

Document Title	Specification of Network Management Interface
Document Owner	AUTOSAR
Document Responsibility	AUTOSAR
Document Identification No	228

Document Status	published
Part of AUTOSAR Standard	Classic Platform
Part of Standard Release	R23-11

Document Change History			
Date	Release	Changed by	Description
2023-11-23	R23-11	AUTOSAR Release Management	<ul style="list-style-type: none"> • NM harmonization • Editorial changes
2022-11-24	R22-11	AUTOSAR Release Management	<ul style="list-style-type: none"> • Refined Partial Network Cluster handling • Editorial changes
2021-11-25	R21-11	AUTOSAR Release Management	<ul style="list-style-type: none"> • Reworked Partial Network functionality and Partial Network Cluster handling • Caveats that were no real requirements were change to notes • Editorial changes
2020-11-30	R20-11	AUTOSAR Release Management	<ul style="list-style-type: none"> • Support for synchronized PNC shutdown functionality • Introduction of Dynamic PNC-to-channel-mapping and PNC Learning algorithm • Added limitation regarding Nm Coordinator functionality when using 10BASE-T1S in combination with PLCA media access • Support for passing NM state change to SwC • Editorial changes





2019-11-28	R19-11	AUTOSAR Release Management	<ul style="list-style-type: none"> • Minor changes • Multicore Distribution support (draft) added • Changed Document Status from Final to published
2018-10-31	4.4.0	AUTOSAR Release Management	<ul style="list-style-type: none"> • Removed LinNM from the architecture • Removed obsolete elements • Header File Cleanup
2017-12-08	4.3.1	AUTOSAR Release Management	<ul style="list-style-type: none"> • minor corrections / clarifications / editorial changes; For details please refer to the ChangeDocumentation
2016-11-30	4.3.0	AUTOSAR Release Management	<ul style="list-style-type: none"> • Add functionality for synchronizing channel A and channel B • removed dependencies of ComMChannels to each other in respect to NMVariants • minor corrections / clarifications / editorial changes; For details please refer to the ChangeDocumentation
2015-07-31	4.2.2	AUTOSAR Release Management	<ul style="list-style-type: none"> • "Coordination algorithm" and "Coordinated shutdown" redefined • Make the CarWakeup feature available • Debugging support marked as obsolete • Editorial changes
2014-10-31	4.2.1	AUTOSAR Release Management	<ul style="list-style-type: none"> • Corrections on the requirement tracing • Clarification at use of callback versus callout • Editorial changes
2014-03-31	4.1.3	AUTOSAR Release Management	<ul style="list-style-type: none"> • Rework of wakeup and abortion of coordinated shutdown • Rework of coordination of nested sub-busses





2013-10-31	4.1.2	AUTOSAR Release Management	<ul style="list-style-type: none"> • Remove DEM usage • Correct multiplicity and dependency of configuration parameter • Corrections on RemoteSleepIndication feature • Corrections on MainFunction and coordinated shutdown • Formal correction on REQ Tags • Editorial changes • Removed chapter(s) on change documentation
2013-03-15	4.1.1	AUTOSAR Administration	<ul style="list-style-type: none"> • Introduction J1939Nm • Merged and corrected calculation of delay timer for Coordination Algorithm • Correction of parametrization and Services for Coordinator Synchronization Algorithm • Moved Nm_Passive_Mode_Enabled Parameter back to global container
2011-12-22	4.0.3	AUTOSAR Administration	<ul style="list-style-type: none"> • NmMultipleChannelsEnabled removed • Added Mandatory Interfaces provided by ComM to Chapter 8.6.1 • move NmPassiveMode • Enabled form global configuration to channel configuration • Removed Nm_ReturnType • Fixed some min and max values of FloatParamDef configuration parameters • Added support of NmCarWakup-Feature • Added support of coordinated shutdown of nested sub-busses



△

2009-12-18	4.0.1	AUTOSAR Administration	<ul style="list-style-type: none"> • Release check added • DET Error Code for false Pointer added • ChannelID harmonized in COM-Stack • Nm-State-changes in Userdata via NmIf
2010-02-02	3.1.4	AUTOSAR Administration	<ul style="list-style-type: none"> • Remove explicit support for OSEK NM from specification • NM Coordinator functionality reworked (chapter 7.2 and 7.2.4) • Debugging functionality added • Link time configuration variant introduced • Legal disclaimer revised
2008-08-13	3.1.1	AUTOSAR Administration	<ul style="list-style-type: none"> • Legal disclaimer revised
2007-12-21	3.0.1	AUTOSAR Administration	<ul style="list-style-type: none"> • Initial release

Disclaimer

This work (specification and/or software implementation) and the material contained in it, as released by AUTOSAR, is for the purpose of information only. AUTOSAR and the companies that have contributed to it shall not be liable for any use of the work.

The material contained in this work is protected by copyright and other types of intellectual property rights. The commercial exploitation of the material contained in this work requires a license to such intellectual property rights.

This work may be utilized or reproduced without any modification, in any form or by any means, for informational purposes only. For any other purpose, no part of the work may be utilized or reproduced, in any form or by any means, without permission in writing from the publisher.

The work has been developed for automotive applications only. It has neither been developed, nor tested for non-automotive applications.

The word AUTOSAR and the AUTOSAR logo are registered trademarks.

Contents

1	Introduction and functional overview	10
2	Acronyms and Abbreviations	11
3	Related documentation	13
3.1	Input documents	13
3.2	Related specification	13
4	Constraints and assumptions	14
4.1	Limitations	14
4.2	Specific limitations of the current release	14
4.3	Applicability to automotive domains	15
5	Dependencies to other modules	16
5.1	Interfaces to modules	16
5.1.1	ComM, CanNm, J1939Nm, FrNm, UdpNm, generic bus specific NM layers and CDD	17
5.1.2	Error handling modules	17
5.1.3	BSW Scheduler	17
5.2	File structure	18
5.2.1	Code file structure	18
5.2.2	Header file structure	18
6	Requirements traceability	19
7	Functional specification	24
7.1	Base functionality	24
7.2	NM Coordinator functionality	25
7.2.1	Applicability of the NM Coordinator functionality	25
7.2.2	Keeping coordinated busses alive	26
7.2.3	Shutdown of coordinated busses	27
7.2.4	Coordination of nested sub-busses	29
7.2.5	Calculation of shutdown timers	33
7.2.6	Synchronization Use Case 1 - Synchronous command	33
7.2.7	Synchronization Use Case 2 - Synchronous initiation	34
7.2.8	Synchronization Use Case 3 - Synchronous network sleep	34
7.2.8.1	Examples	35
7.3	Wakeup and abortion of the coordinated shutdown	37
7.3.1	External network wakeup	37
7.3.2	Coordinated wakeup	37
7.3.3	Abortion of the coordinated shutdown	37
7.4	Partial Network functionality	39
7.4.1	PNC bit vector filter algorithm	39
7.4.2	Aggregation of PNC requests	41

7.4.2.1	Aggregation of internal and external Partial Network Cluster	41
7.4.2.2	Aggregation of external Partial Network Cluster	44
7.4.3	EIRA / ERA state and PNC reset timer handling	45
7.4.4	Synchronized PNC shutdown functionality	47
7.5	Prerequisites of bus specific Network Management modules	50
7.5.1	Prerequisites for basic functionality	50
7.5.2	Prerequisites for NM Coordinator functionality	51
7.5.3	Prerequisites of Partial Network functionality	54
7.5.3.1	Prerequisite for aggregation of PNC requests	54
7.5.3.2	Prerequisites for synchronized PNC shutdown functionality	54
7.5.4	Configuration of global parameters for bus specific networks	54
7.6	NM_BUSNM_LOCALNM	55
7.7	Multicore Distribution	55
7.8	Additional Functionality	55
7.8.1	Nm_CarWakeUpIndication	55
7.8.2	Nm_StateChangeNotification	56
7.9	Error classification	57
7.9.1	Development Errors	57
7.9.2	Runtime Errors	57
7.9.3	Transient Faults	57
7.9.4	Production Errors	58
7.9.5	Extended Production Errors	58
8	API specification	59
8.1	Imported types	59
8.2	Type definitions	59
8.2.1	Nm_ModeType	59
8.2.2	Nm_StateType	59
8.2.3	Nm_BusNmType	60
8.2.4	Nm_ConfigType	60
8.3	Function definitions	61
8.3.1	Standard services provided by NM Interface	61
8.3.1.1	Nm_Init	61
8.3.1.2	Nm_PassiveStartUp	61
8.3.1.3	Nm_NetworkRequest	62
8.3.1.4	Nm_NetworkRelease	63
8.3.2	Communication control services provided by NM Interface	64
8.3.2.1	Nm_DisableCommunication	64
8.3.2.2	Nm_EnableCommunication	65
8.3.3	Partial Network services provided by NM Interface	66
8.3.3.1	Nm_RequestSynchronizedPncShutdown	66
8.3.3.2	Nm_UpdateIRA	66
8.3.4	Extra services provided by NM Interface	67
8.3.4.1	Nm_SetUserData	67

8.3.4.2	Nm_GetUserData	68
8.3.4.3	Nm_GetPduData	69
8.3.4.4	Nm_RepeatMessageRequest	69
8.3.4.5	Nm_GetNodeIdentifier	70
8.3.4.6	Nm_GetLocalNodeIdentifier	71
8.3.4.7	Nm_CheckRemoteSleepIndication	72
8.3.4.8	Nm_GetState	73
8.3.4.9	Nm_GetVersionInfo	73
8.3.4.10	Nm_PnLearningRequest	74
8.4	Call-back notifications	75
8.4.1	Standard Call-back notifications	75
8.4.1.1	Nm_NetworkStartIndication	75
8.4.1.2	Nm_NetworkMode	76
8.4.1.3	Nm_BusSleepMode	76
8.4.1.4	Nm_PrepareBusSleepMode	77
8.4.1.5	NM_SynchronizeMode	77
8.4.1.6	Nm_RemoteSleepIndication	78
8.4.1.7	Nm_RemoteSleepCancellation	78
8.4.1.8	Nm_SynchronizationPoint	79
8.4.1.9	Nm_CoordReadyToSleepIndication	79
8.4.1.10	Nm_CoordReadyToSleepCancellation	80
8.4.1.11	Nm_ForwardSynchronizedPncShutdown	81
8.4.1.12	Nm_PncBitVectorRxIndication	81
8.4.1.13	Nm_PncBitVectorTxIndication	82
8.4.1.14	Nm_PncBitVectorTxConfirmation	82
8.4.2	Extra Call-back notifications	83
8.4.2.1	Nm_PduRxIndication	83
8.4.2.2	Nm_StateChangeNotification	84
8.4.2.3	Nm_RepeatMessageIndication	84
8.4.2.4	Nm_TxTimeoutException	85
8.4.2.5	Nm_CarWakeUpIndication	86
8.5	Scheduled functions	86
8.5.1	Nm_MainFunction	87
8.6	Expected interfaces	87
8.6.1	Mandatory Interfaces	87
8.6.2	Optional Interfaces	88
8.6.3	Configurable Interfaces	89
8.6.3.1	NmCarWakeUpCallout	89
8.7	Version Check	90
9	Sequence diagrams	91
9.1	Basic functionality	91
9.2	Seq of NM Coordinator functionality	91
9.3	Sequence of Partial network functionality	93
10	Configuration specification	98
10.1	How to read this chapter	98

10.2	Configuration parameters	98
10.2.1	Nm	99
10.3	Global configurable parameters	100
10.3.1	NmGlobalConfig	100
10.3.2	NmGlobalConstants	101
10.3.3	NmGlobalProperties	102
10.3.4	NmGlobalFeatures	105
10.4	Channel configurable parameters	112
10.4.1	NmChannelConfig	112
10.4.2	NmPnFilterMaskByte	118
10.4.3	NmBusType	119
10.4.4	NmGenericBusNmConfig	120
10.4.5	NmStandardBusNmConfig	121
10.5	Published Information	122
A	Not applicable requirements	123
B	Change history of AUTOSAR traceable items	124
B.1	Traceable item history of this document according to AUTOSAR Release R22-11	124
B.1.1	Added Specification Items in R22-11	124
B.1.2	Changed Specification Items in R22-11	124
B.1.3	Deleted Specification Items in R22-11	127
B.1.4	Added Constraints in R22-11	127
B.1.5	Changed Constraints in R22-11	127
B.1.6	Deleted Constraints in R22-11	127
B.2	Traceable item history of this document according to AUTOSAR Release R23-11	128
B.2.1	Added Specification Items in R23-11	128
B.2.2	Changed Specification Items in R23-11	128
B.2.3	Deleted Specification Items in R23-11	128
B.2.4	Added Constraints in R23-11	128
B.2.5	Changed Constraints in R23-11	128
B.2.6	Deleted Constraints in R23-11	128

1 Introduction and functional overview

This document describes the concept, interfaces and configuration of the **Network Management Interface** module.

The **Network Management Interface** is an adaptation layer between the AUTOSAR Communication Manager and the AUTOSAR bus specific network management modules (e.g. CAN Network Management and FlexRay Network Management). This is also referred to as Basic functionality.

Additionally, this document describes the following optional features:

- interoperability between several networks connected to the same (coordinator) ECU that run AUTOSAR NM, where "interoperability" means that these networks can be put to sleep synchronously. This is also referred to as *NM Coordinator functionality*.
- Partial Network Cluster (PNC) handling, including handling of PNC timers and handling of synchronized PNC shutdown requests. If Partial Network is enabled, AUTOSAR NM aggregates all internal PNC requests (notified by ComM), all external PNC requests (notified by the <Bus>Nm's) and manage the PNC timers of each notified PNC. Additionally, if using the synchronized PNC shutdown functionality, AUTOSAR NM collect all synchronized PNC shutdown requests (notified by ComM) and control the PNC shutdown handling. For transmission of PN shutdown messages the AUTOSAR NM indicate the <Bus>Nm to fetch the aggregated PN shutdown requests. On reception of PN shutdown message the AUTOSAR NM acts as an interface layer between <Bus>Nm's and ComM. It forwards requests from <Bus>Nm's to ComM. Handling of PNC timer and handling of synchronized PNC shutdown requests are also referred to as *Partial Network functionality*.

Support of the *NM Coordinator functionality* and *Partial Network functionality* are optional. A **Network Management Interface** implementation can either support only Basic functionality or one of the following combinations:

- Basic functionality and *NM Coordinator functionality*.
- Basic functionality and *Partial Network functionality*.

The **Network Management Interface** is constructed to support generic lower layer modules that follow a fixed set of requirement for bus specific NM modules. This will allow third parties to offer support for OEM specific or legacy NM protocols such as direct OSEK NM.

2 Acronyms and Abbreviations

The glossary below includes acronyms and abbreviations and terms relevant to the Network Management Interface module that are not included in the [1, AUTOSAR glossary].

Abbreviation / Acronym:	Description:
CanIf	CAN Interface module
CanNm	CAN Network Management module
CC	Communication controller
ComM	Communication Manager module
EcuM	ECU State Manager module
DEM	Diagnostic Event Manager module
Nm	Generic Network Management Interface module, this is the abbreviation used for this module throughout this specification
NM	Network Management
OEM	Original Equipment Manufacturer
CBV	Control Bit Vector in NM-message
PNC	Partial network cluster

Terms:	Definition:
Bus-Sleep Mode	Network mode where all interconnected communication controllers are in the sleep mode.
NM-Channel	Logical channel associated with the NM-cluster
NM-Cluster	Set of NM nodes coordinated with the use of the NM algorithm.
NM-Coordinator	A functionality of the Nm which allows coordination of network sleep for multiple NM Channels.
NM-Message	Packet of information exchanged for purposes of the NM algorithm.
NM-Timeout	Timeout in the NM algorithm that initiates transition into Bus-Sleep Mode.
NM User Data	Supplementary application specific piece of data that is attached to every NM message sent on the bus.
Node Identifier	Node address information exchanged for purposes of the NM algorithm.
Node Identifier List	List of Node Identifiers recognized by the NM algorithm.
Bus	Physical communication medium to which a NM node/ecu is connected to.
network	Entity of all NM nodes/ecus which are connected to the same bus.
channel	Logical bus to which the NM node/ecu is connected to.
Coordinated shutdown	Shutdown of two or more busses in a way that their shutdown is finished coinciding.
Coordination algorithm	Initiation of coordinated shutdown in case all conditions are met.

Terms:	Definition:
PNC bit vector	Represent the Partial Network information in a NM frame
PNC bit vector length	Represent the length of a Partial Network information in bytes
PNC bit	One bit which represent a particular Partial Network in the Partial Network Info Range
PN filter mask	Vector of filter mask bytes defined by configuration container(s) NmPnFilterMaskByte per channel to filter relevant PNC requests for the PNC timer handling
Top-level PNC coordinator	An ECU acts as top-level PNC coordinator for those PNCs which are actively coordinated on all assigned channels. This ECU has the PNC gateway functionality enabled. The top-level PNC coordinator triggers for those PNCs a synchronized PNC shutdown, if no other ECU in the network requests them and if the synchronized PNC shutdown is enabled. Note: For different PNCs it is possible to have different top-level PNC coordinators. But for the same PNC only one top-level coordinator is supported.
Intermediate PNC coordinator	An ECU acts as intermediate PNC coordinator for those PNCs which are passively coordinated on at least one channel. This ECU has the PNC gateway functionality enabled. The intermediate PNC coordinator forwards a synchronized PNC shutdown to active coordinated channels for PNCs which are passively coordinated, if the synchronized PNC shutdown is enabled
PNC leaf node	A PNC leaf node is an ECU that act neither as top-level PNC coordinator nor as an intermediate PNC coordinator. It act as an ECU without a PNC gateway in the network and process PN shutdown message as usual NM messages.
PN shutdown message	<p>A top-level PNC coordinator transmits PN shutdown messages to indicate a synchronized PNC shutdown across the PN topology. A PN shutdown message is a NM message which has PNSR bit in the control bit vector and all PNCs which are indicated for a synchronized shutdown set to '1'. An intermediate PNC coordinator which receive a PN shutdown message has to forward the PNC bit vector as PN shutdown message on the affected channels.</p> <p>Note: An intermediate PNC coordinators has to forward the PNC bit vector of received PN shutdown message as fast as possible to ensure a nearly synchronized shutdown of the affected PNCs across the PN topology.</p>

3 Related documentation

3.1 Input documents

- [1] Glossary
AUTOSAR_FO_TR_Glossary
- [2] General Specification of Basic Software Modules
AUTOSAR_CP_SWS_BSWGeneral
- [3] Specification of CAN Network Management
AUTOSAR_CP_SWS_CANNetworkManagement
- [4] Specification of FlexRay Network Management
AUTOSAR_CP_SWS_FlexRayNetworkManagement
- [5] Specification of UDP Network Management
AUTOSAR_CP_SWS_UDPNetworkManagement
- [6] Specification of Network Management for SAE J1939
AUTOSAR_CP_SWS_SAEJ1939NetworkManagement
- [7] General Requirements on Basic Software Modules
AUTOSAR_CP_SRS_BSWGeneral
- [8] Requirements on AUTOSAR Network Management
AUTOSAR_FO_RS_NetworkManagement
- [9] Guide to Mode Management
AUTOSAR_CP_EXP_ModeManagementGuide
- [10] Specification of Communication Manager
AUTOSAR_CP_SWS_COMManager
- [11] Guide to BSW Distribution
AUTOSAR_CP_EXP_BSWDistributionGuide

3.2 Related specification

AUTOSAR provides a General Specification on Basic Software modules [2, SWS BSW General], which is also valid for the Generic Network Management Interface.

Thus, the specification SWS BSW General shall be considered as additional and required specification for the Generic Network Management Interface.

4 Constraints and assumptions

4.1 Limitations

1. The Generic Network Management Interface can only be applied to communication systems that support broadcast communication and 'bus-sleep mode'.
2. There is only one instance of the Generic Network Management Interface layer for all NM-Clusters. This instance manages all channels where a NM is used.
3. The Generic Network Management Interface shall only include the common modes, definitions and return values of different bus specific NM layers.
4. The Generic Network Management Interface shall only include the common modes, definitions and return values of different bus specific NM layers.
5. If 10BASE-T1S is used in combination with PLCA media access, then Nm Coordinator functionality are not supported.

Note: Consequently, the configuration parameter `NmCoordinatorSupportEnabled` shall be set to false.

6. NM Coordination functionality in combination with Partial Network functionality and vice versa is not supported.

Figure 4.1 shows a typical example of the AUTOSAR NM stack.

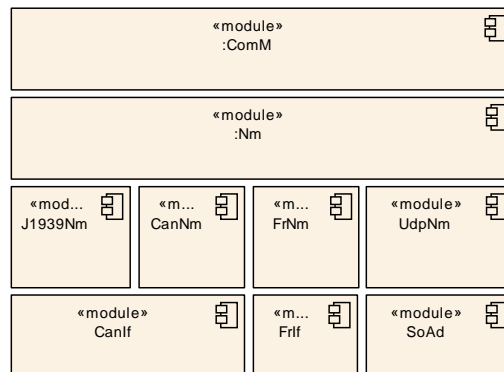

Figure 4.1: Nm stack modules

4.2 Specific limitations of the current release

The following limitations reflect desired functionality that has yet not been implemented or agreed upon, but might be added for future releases:

- No support of a back-up coordinator ECU (fault tolerance).

Also; explicit support for OSEK NM has been completely removed from this specification as of AUTOSAR Release 4.0. OSEK NM can still be supported by extending

the CanNm or by introducing a Complex Driver (CDD) on <Bus>Nm level as a generic BusNm. Supporting the OSEK NM through a CDD is not specified by AUTOSAR.

4.3 Applicability to automotive domains

The AUTOSAR NM Interface is generic and provides flexible configuration; it is independent of the underlying communication system and can be applied to any automotive domain under limitations provided above.

5 Dependencies to other modules

5.1 Interfaces to modules

Figure 5.1 shows the interfaces provided to and required from other modules in the AUTOSAR BSW.

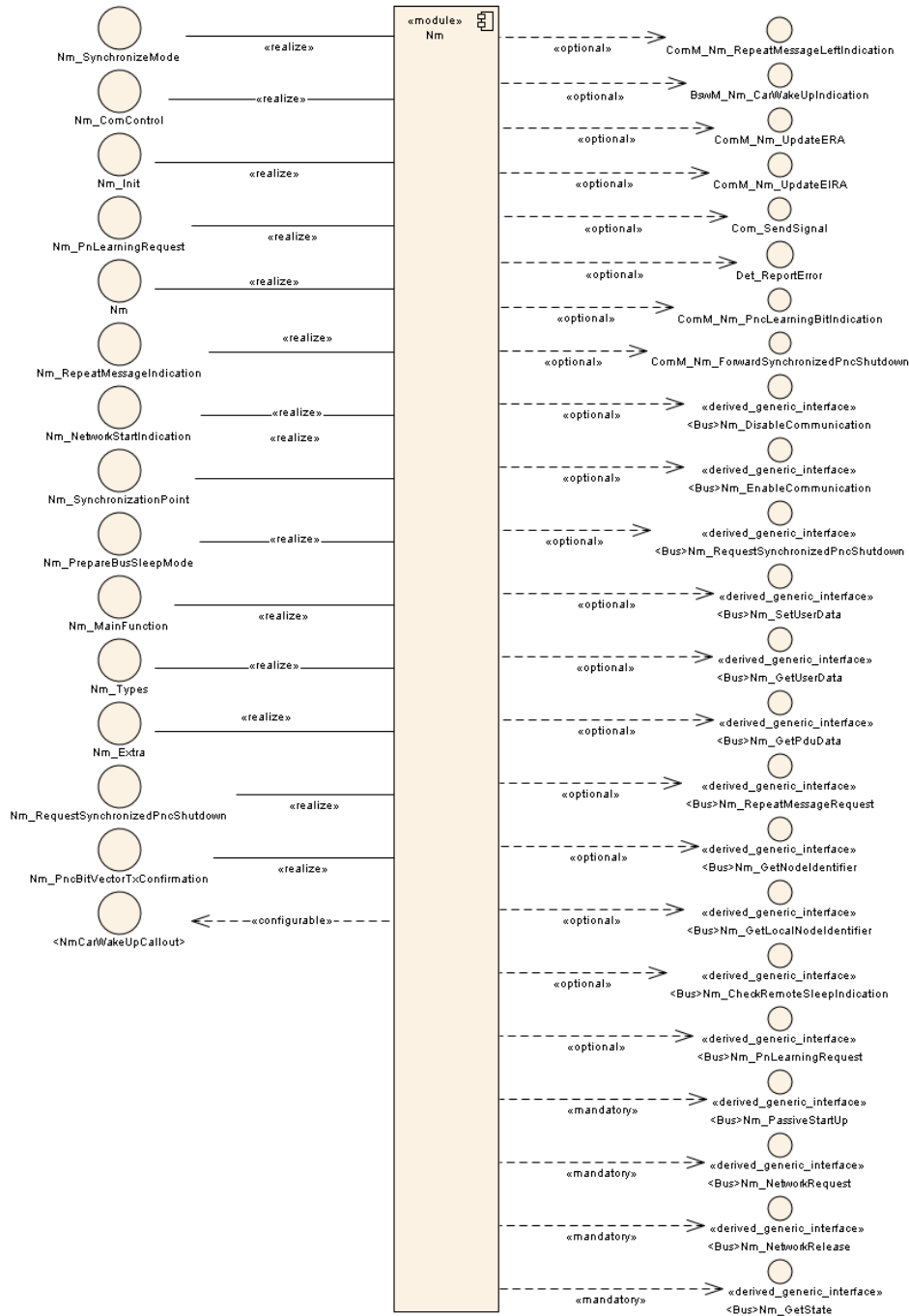

Figure 5.1: Nm’s interfaces to other modules

5.1.1 ComM, CanNm, J1939Nm, FrNm, UdpNm, generic bus specific NM layers and CDD

The Generic Network Management Interface module (**Nm**) provides services to the Communication Manager (**ComM**) and uses services of the bus specific Network Management modules:

- CAN Network Management ([3, **CanNm**])
- FlexRay Network Management ([4, **FrNm**])
- Ethernet Network Management ([5, **UdpNm**]).
- J1939 Network Management ([6, **J1939Nm**]).

For Buses which do not need to provide Network Management Information on the bus like for example a LIN-bus the Bus-Type can be configured as "local Nm". With respect to callbacks, the **Nm** provides notification callbacks to the bus specific Network Management modules and calls the notification callbacks provided by the **ComM**.

In addition to the official AUTOSAR NM-modules above, Nm also support generic bus specific NM layers (**<Bus>Nm**). Any component which implements the required provided interfaces and uses the provided callback functions of Nm can be used as a bus specific NM. See [section 7.5](#) for the prerequisites for a generic bus specific NM.

Rationale: Nm is specified to support generic bus specific NM layers by adding generic lower layer modules as Complex Drivers. As such, Nm does not explicitly use the services by the official AUTOSAR bus-NM modules (CanNm, FrNm and UdpNm), but rather the services of the generic **<Bus>Nm**. The AUTOSAR bus-NMs are then explicitly supported since they implement the interfaces of **<Bus>Nm**.

The optional CarWakeUp-Functionality needs a Complex Driver which Coordinates Basic Software Mode Management.

5.1.2 Error handling modules

Nm reports development errors to the Default Error Tracer according to [\[SWS_Nm_00232\]](#).

5.1.3 BSW Scheduler

In case of the NM Coordinator functionality and depending on the configuration, the Nm will need cyclic invocation of it's main scheduling function in order to evaluate and detect when timers have expired.

5.2 File structure

5.2.1 Code file structure

[SWS_Nm_00247] [The code file structure shall not be defined within this specification completely. At this point it shall be pointed out that the code-file structure shall include the following files named:

]([SRS_BSW_00159](#), [SRS_BSW_00345](#), [SRS_BSW_00419](#))

5.2.2 Header file structure

[SWS_Nm_00124] [The following header files shall be included by the Nm Interface module:

- Std_Types.h (for AUTOSAR standard types)
Note: Platform_Types.h (for platform specific types) is indirectly included via AUTOSAR standard types.
- ComM_Nm.h (for Communication Manager callback functions)
- BswM_Nm.h (If the BswM is used for CarWakeup-functionality)

]([SRS_BSW_00348](#), [SRS_BSW_00353](#), [SRS_BSW_00357](#), [SRS_BSW_00384](#))

[SWS_Nm_00243] [The Nm Interface shall optionally include the header file of Default Error Tracer (depending on the pre-processor switch NmDevErrorDetect, see ECUC_Nm_00203).

- Det.h for service of the Default Error Tracer.

]([SRS_BSW_00171](#), [SRS_BSW_00301](#), [SRS_BSW_00384](#))

6 Requirements traceability

The following tables references the requirements specified in [7] as well as [8] and links to the fulfillment of these.

Requirement	Description	Satisfied by
[RS_Nm_00044]	The Nm shall be applicable to different types of communication systems which are in the scope of AUTOSAR and support a bus sleep mode.	[SWS_Nm_00051] [SWS_Nm_00172] [SWS_Nm_00274] [SWS_Nm_00276]
[RS_Nm_00045]	Nm shall provide services to coordinate shutdown of Nm-clusters independently of each other	[SWS_Nm_00167] [SWS_Nm_00168]
[RS_Nm_00046]	It shall be possible to trigger the startup of all Nodes at any Point in Time	[SWS_Nm_00031] [SWS_Nm_00032]
[RS_Nm_00047]	Nm shall provide a service to request to keep the bus awake and a service to cancel this request.	[SWS_Nm_00002] [SWS_Nm_00003] [SWS_Nm_00032] [SWS_Nm_00046] [SWS_Nm_00171]
[RS_Nm_00048]	Nm shall put the communication controller into sleep mode if there is no bus communication	[SWS_Nm_00046]
[RS_Nm_00050]	The Nm shall provide the current state of Nm	[SWS_Nm_00043] [SWS_Nm_00114] [SWS_Nm_00275]
[RS_Nm_00051]	Nm shall inform application when Nm state changes occur.	[SWS_Nm_00031] [SWS_Nm_00032] [SWS_Nm_00046] [SWS_Nm_00114] [SWS_Nm_00156] [SWS_Nm_00158] [SWS_Nm_00159] [SWS_Nm_00161] [SWS_Nm_00162] [SWS_Nm_00163] [SWS_Nm_00230] [SWS_Nm_00249] [SWS_Nm_00487] [SWS_Nm_00509]
[RS_Nm_00052]	The Nm interface shall signal to the application that all other ECUs are ready to sleep.	[SWS_Nm_00192]
[RS_Nm_00054]	There shall be a deterministic time from the point where all nodes agree to go to bus sleep to the point where bus is switched off.	[SWS_Nm_00171]
[RS_Nm_00149]	The timing of Nm shall be configurable.	[SWS_Nm_00175] [SWS_Nm_00281] [SWS_Nm_00284]
[RS_Nm_00150]	Specific features of the Network Management shall be configurable	[SWS_Nm_00055] [SWS_Nm_00134] [SWS_Nm_00136] [SWS_Nm_00138] [SWS_Nm_00140] [SWS_Nm_00150] [SWS_Nm_00164] [SWS_Nm_00165] [SWS_Nm_00166] [SWS_Nm_00241] [SWS_Nm_00251] [SWS_Nm_00255] [SWS_Nm_00273] [SWS_Nm_00277] [SWS_Nm_00278] [SWS_Nm_00279] [SWS_Nm_00290]
[RS_Nm_00151]	The Network Management algorithm shall allow any node to integrate into an already running Nm cluster	[SWS_Nm_00031] [SWS_Nm_00032]
[RS_Nm_00153]	The Network Management shall optionally provide a possibility to detect present nodes	[SWS_Nm_00038] [SWS_Nm_00230]





Requirement	Description	Satisfied by
[RS_Nm_00154]	The Network Management API shall be independent from the communication bus	[SWS_Nm_00006] [SWS_Nm_00012] [SWS_Nm_00276]
[RS_Nm_02503]	The Nm API shall optionally give the possibility to send user data	[SWS_Nm_00035] [SWS_Nm_00250] [SWS_Nm_00252] [SWS_Nm_00285]
[RS_Nm_02504]	The Nm API shall optionally give the possibility to get user data	[SWS_Nm_00036] [SWS_Nm_00291]
[RS_Nm_02506]	The Nm API shall give the possibility to read the source node identifier of the sender	[SWS_Nm_00039]
[RS_Nm_02508]	Every node shall have a node identifier associated with it that is unique in the Nm-cluster.	[SWS_Nm_00040]
[RS_Nm_02509]	The Nm interface shall signal to the application that at least one ECU is not ready to sleep anymore.	[SWS_Nm_00193]
[RS_Nm_02511]	It shall be possible to configure the Network Management of a node so that it does not contribute to the cluster shutdown decision.	[SWS_Nm_00168] [SWS_Nm_00228]
[RS_Nm_02512]	The Nm shall give the possibility to enable or disable the network management related communication configured for an active Nm node	[SWS_Nm_00033] [SWS_Nm_00034]
[RS_Nm_02513]	Nm shall provide functionality which enables upper layers to control the sleep mode.	[SWS_Nm_00006] [SWS_Nm_00012] [SWS_Nm_00031] [SWS_Nm_00032] [SWS_Nm_00033] [SWS_Nm_00042] [SWS_Nm_00154] [SWS_Nm_00155]
[RS_Nm_02514]	It shall be possible to group networks into <i>Nm Coordination Clusters</i>	[SWS_Nm_00001] [SWS_Nm_00168]
[RS_Nm_02515]	Nm shall offer a generic possibility to run other Nms than the AUTOSAR-Nms	[SWS_Nm_00051] [SWS_Nm_00119] [SWS_Nm_00166] [SWS_Nm_00276]
[RS_Nm_02516]	All AUTOSAR Nm instances shall support the Nm Coordinator functionality including Bus synchronization on demand	[SWS_Nm_00169] [SWS_Nm_00171] [SWS_Nm_00173] [SWS_Nm_00174] [SWS_Nm_00175] [SWS_Nm_00176] [SWS_Nm_00177] [SWS_Nm_00194] [SWS_Nm_00284]
[RS_Nm_02517]	CanNm shall support Partial Networking on CAN	[SWS_Nm_00302] [SWS_Nm_00308] [SWS_Nm_00312] [SWS_Nm_00313] [SWS_Nm_00317] [SWS_Nm_00318] [SWS_Nm_00319] [SWS_Nm_00320] [SWS_Nm_00321] [SWS_Nm_00322] [SWS_Nm_00323] [SWS_Nm_00324] [SWS_Nm_00325] [SWS_Nm_00326] [SWS_Nm_00327] [SWS_Nm_00328] [SWS_Nm_00329] [SWS_Nm_00330] [SWS_Nm_00331] [SWS_Nm_00533] [SWS_Nm_00534] [SWS_Nm_00535] [SWS_Nm_00536] [SWS_Nm_00537] [SWS_Nm_CONSTR_00001]
[RS_Nm_02527]	Nm shall implement a filter algorithm dropping all Nm messages that are not relevant for the ECU	[SWS_Nm_00308] [SWS_Nm_00312] [SWS_Nm_CONSTR_00001]





Requirement	Description	Satisfied by
[RS_Nm_02535]	The Nm coordination shall support the coordination of nested sub-buses	[SWS_Nm_00254] [SWS_Nm_00256] [SWS_Nm_00257] [SWS_Nm_00259] [SWS_Nm_00261] [SWS_Nm_00262] [SWS_Nm_00267] [SWS_Nm_00271] [SWS_Nm_00272] [SWS_Nm_00280]
[RS_Nm_02536]	Nm shall provide functionality to start-up without requesting the network.	[SWS_Nm_00031] [SWS_Nm_00119] [SWS_Nm_00245] [SWS_Nm_00250]
[RS_Nm_02537]	The Nm Coordinator shall be able to abort the coordinated shutdown	[SWS_Nm_00181] [SWS_Nm_00182] [SWS_Nm_00183] [SWS_Nm_00185] [SWS_Nm_00235] [SWS_Nm_00236] [SWS_Nm_00267]
[RS_Nm_02544]	Nm shall forward the indication of a PN shutdown message	[SWS_Nm_91006] [SWS_Nm_91007] [SWS_Nm_91008] [SWS_Nm_91009]
[RS_Nm_02548]	<Bus>Nm shall be able to propagate and evaluate the need for synchronized PNC shutdown in the role of a top-level PNC coordinator or intermediate PNC coordinator (optional)	[SWS_Nm_00305]
[RS_Nm_02562]	Nm shall support channel-specific storage of IRA	[SWS_Nm_00330]
[RS_Nm_02563]	Nm shall calculate the combined partial network request status EIRA	[SWS_Nm_00302] [SWS_Nm_00313] [SWS_Nm_00317] [SWS_Nm_00318] [SWS_Nm_00319] [SWS_Nm_00320] [SWS_Nm_00534] [SWS_Nm_00535] [SWS_Nm_00536] [SWS_Nm_00537]
[RS_Nm_02564]	Nm shall calculate the status of the external partial network requests ERA	[SWS_Nm_00322] [SWS_Nm_00323] [SWS_Nm_00324] [SWS_Nm_00325] [SWS_Nm_00326] [SWS_Nm_00328] [SWS_Nm_00329]
[RS_Nm_02565]	<Bus>Nm shall communicate EIRA and ERA requests to the upper layers using dedicated APIs	[SWS_Nm_00321] [SWS_Nm_00327]
[RS_Nm_02571]	Nm shall handle requests for synchronized PNC shutdown	[SWS_Nm_00521] [SWS_Nm_00523] [SWS_Nm_00524] [SWS_Nm_00525] [SWS_Nm_00527] [SWS_Nm_00529] [SWS_Nm_00530] [SWS_Nm_00532] [SWS_Nm_00533] [SWS_Nm_91005]
[RS_Nm_02572]	<Bus>Nm shall transmit requests for synchronized PNC shutdown as NM-PDU	[SWS_Nm_91005]
[RS_Nm_02574]	Nm shall provide a confirmation API to indicate the transmission state PNC bit vector	[SWS_Nm_91010]
[SRS_BSW_00003]	All software modules shall provide version and identification information	[SWS_Nm_00044]
[SRS_BSW_00101]	The Basic Software Module shall be able to initialize variables and hardware in a separate initialization function	[SWS_Nm_00030]
[SRS_BSW_00159]	All modules of the AUTOSAR Basic Software shall support a tool based configuration	[SWS_Nm_00247]





Requirement	Description	Satisfied by
[SRS_BSW_00171]	Optional functionality of a Basic-SW component that is not required in the ECU shall be configurable at pre-compile-time	[SWS_Nm_00243]
[SRS_BSW_00301]	All AUTOSAR Basic Software Modules shall only import the necessary information	[SWS_Nm_00117] [SWS_Nm_00243]
[SRS_BSW_00323]	All AUTOSAR Basic Software Modules shall check passed API parameters for validity	[SWS_Nm_00488] [SWS_Nm_00489] [SWS_Nm_00490] [SWS_Nm_00491] [SWS_Nm_00492] [SWS_Nm_00493] [SWS_Nm_00494] [SWS_Nm_00495] [SWS_Nm_00496] [SWS_Nm_00497] [SWS_Nm_00498] [SWS_Nm_00499] [SWS_Nm_00500] [SWS_Nm_00505] [SWS_Nm_00508]
[SRS_BSW_00327]	Error values naming convention	[SWS_Nm_00232]
[SRS_BSW_00330]	It shall be allowed to use macros instead of functions where source code is used and runtime is critical	[SWS_Nm_00091]
[SRS_BSW_00333]	For each callback function it shall be specified if it is called from interrupt context or not	[SWS_Nm_00028]
[SRS_BSW_00337]	Classification of development errors	[SWS_Nm_00232]
[SRS_BSW_00344]	BSW Modules shall support link-time configuration	[SWS_Nm_00030]
[SRS_BSW_00345]	BSW Modules shall support pre-compile configuration	[SWS_Nm_00247]
[SRS_BSW_00348]	All AUTOSAR standard types and constants shall be placed and organized in a standard type header file	[SWS_Nm_00124]
[SRS_BSW_00353]	All integer type definitions of target and compiler specific scope shall be placed and organized in a single type header	[SWS_Nm_00124]
[SRS_BSW_00357]	For success/failure of an API call a standard return type shall be defined	[SWS_Nm_00124]
[SRS_BSW_00358]	The return type of init() functions implemented by AUTOSAR Basic Software Modules shall be void	[SWS_Nm_00030]
[SRS_BSW_00359]	All AUTOSAR Basic Software Modules callback functions shall avoid return types other than void if possible	[SWS_Nm_00112] [SWS_Nm_00114] [SWS_Nm_00154] [SWS_Nm_00156] [SWS_Nm_00159] [SWS_Nm_00162] [SWS_Nm_00192] [SWS_Nm_00193] [SWS_Nm_00194] [SWS_Nm_00230] [SWS_Nm_00234] [SWS_Nm_00250] [SWS_Nm_00254] [SWS_Nm_00272]
[SRS_BSW_00369]	All AUTOSAR Basic Software Modules shall not return specific development error codes via the API	[SWS_Nm_00488] [SWS_Nm_00489] [SWS_Nm_00490] [SWS_Nm_00491] [SWS_Nm_00492] [SWS_Nm_00493] [SWS_Nm_00494] [SWS_Nm_00495] [SWS_Nm_00496] [SWS_Nm_00497] [SWS_Nm_00498] [SWS_Nm_00499] [SWS_Nm_00500] [SWS_Nm_00505] [SWS_Nm_00508]





Requirement	Description	Satisfied by
[SRS_BSW_00373]	The main processing function of each AUTOSAR Basic Software Module shall be named according the defined convention	[SWS_Nm_00020]
[SRS_BSW_00384]	The Basic Software Module specifications shall specify at least in the description which other modules they require	[SWS_Nm_00124] [SWS_Nm_00243]
[SRS_BSW_00385]	List possible error notifications	[SWS_Nm_00232]
[SRS_BSW_00386]	The BSW shall specify the configuration and conditions for detecting an error	[SWS_Nm_00232] [SWS_Nm_00488] [SWS_Nm_00489] [SWS_Nm_00490] [SWS_Nm_00491] [SWS_Nm_00492] [SWS_Nm_00493] [SWS_Nm_00494] [SWS_Nm_00495] [SWS_Nm_00496] [SWS_Nm_00497] [SWS_Nm_00498] [SWS_Nm_00499] [SWS_Nm_00500] [SWS_Nm_00505] [SWS_Nm_00508]
[SRS_BSW_00405]	BSW Modules shall support multiple configuration sets	[SWS_Nm_00030]
[SRS_BSW_00407]	Each BSW module shall provide a function to read out the version information of a dedicated module implementation	[SWS_Nm_00044]
[SRS_BSW_00414]	Init functions shall have a pointer to a configuration structure as single parameter	[SWS_Nm_00030] [SWS_Nm_00282] [SWS_Nm_00283]
[SRS_BSW_00419]	If a pre-compile time configuration parameter is implemented as <code>const</code> it should be placed into a separate c-file	[SWS_Nm_00247]
[SRS_BSW_00424]	BSW module main processing functions shall not be allowed to enter a wait state	[SWS_Nm_00118]
[SRS_BSW_00425]	The BSW module description template shall provide means to model the defined trigger conditions of schedulable objects	[SWS_Nm_00118]
[SRS_BSW_00450]	A Main function of a un-initialized module shall return immediately	[SWS_Nm_00121]
[SRS_BSW_00459]	It shall be possible to concurrently execute a service offered by a BSW module in different partitions	[SWS_Nm_00484] [SWS_Nm_00485] [SWS_Nm_00486]
[SRS_BSW_00478]	Timing limits of main functions	[SWS_Nm_00292]
[SRS_BSW_00482]	Get version information function shall follow a naming rule	[SWS_Nm_00044]
[SRS_ModeMgm_09250]	PNC activation requests shall be exchanged with the Network Management via a PNC bit vector	[SWS_Nm_00317] [SWS_Nm_00321] [SWS_Nm_00327] [SWS_Nm_91006] [SWS_Nm_91008] [SWS_Nm_91010]

Table 6.1: RequirementsTracing

7 Functional specification

The NM Interface functionality consists of three parts:

- The *Base functionality* necessary to run, together with the bus specific NM modules, AUTOSAR NM on an ECU.
- The *NM Coordinator functionality* used by gateway ECUs to synchronously shut down one or more busses.
- The Partial Network functionality is divided in 2 sub parts:
 - The handling of PNC requests (filtering, aggregation and monitoring) is used by any ECU which is member of an Partial Network.
 - The PNC timer handling is used by any ECU which is member of an Partial Network.
 - The *synchronized PNC shutdown functionality* used by PNC gateway ECUs in the role of a top-level PNC coordinator or intermediate PNC coordinator to synchronously shutdown particular PNCs across the PN topology.

7.1 Base functionality

The Generic Network Management Interface module (Nm) shall act as a bus-independent adaptation layer between the bus-specific Network Management modules (such as CanNm, J1939Nm, FrNm and UdpNm) and the Communication Manager module (ComM).

Note: The Nm does not provide interface functions beyond those specified in this document. The Nm will provide an interface to the ComM, that does not contain specific knowledge about the type of the underlying busses, and that nevertheless is sufficient to accomplish the necessary network management functions. The algorithm handled by the Nm is bus independent.

Note: It is also required that other service layer modules access network management functions exclusively via Nm and that no bypasses to bus specific NM functions exist

[SWS_Nm_00006] [The Nm shall convert generic function calls from the ComM to bus specific functions of the bus specific NM layer.] ([RS_Nm_00154](#), [RS_Nm_02513](#))

[SWS_Nm_00012] [The Nm shall convert callback functions called by the bus specific NM layers to generic callbacks to the ComM.] ([RS_Nm_00154](#), [RS_Nm_02513](#))

[SWS_Nm_00091] [The Base functionality of Nm may be implemented completely or partly using macros.] ([SRS_BSW_00330](#))

7.2 NM Coordinator functionality

NM Coordinator functionality is a functionality of **Nm** that uses a [coordination algorithm](#) to coordinate the shutdown of **NM** on all, or one or more independent subsets of the busses that the ECU is connected to.

Dependent on configuration, the [coordination algorithm](#) can be configured to achieve different levels of synchronization of the shutdown.

An ECU using an **NM** that actively performs the *NM Coordinator functionality* is commonly referred to as an **NM Coordinator**. However, in this specification this term is synonymous with the *NM Coordinator functionality* when used in requirements.

Note: Consider that certain bus types have different nomenclature on the terms [Network](#), [Channel](#), [Cluster](#).

[SWS_Nm_00292] [If the *NM Coordinator functionality* is configured, the configuration parameter [NmCycletimeMainFunction](#) shall be configured (see [SWS_Nm_00118]).] ([SRS_BSW_00478](#))

Note: The **NM Coordinator** may use this to calculate the timeout status of internal timers.

7.2.1 Applicability of the NM Coordinator functionality

[SWS_Nm_00001] [The [coordination algorithm](#) shall be able to handle a topology where several coordinated busses are connected to one **NM Coordinator**.] ([RS_Nm_02514](#))

[SWS_Nm_00256] [The [NM-Coordinator](#) shall support two or more **NM-Coordinators** connected to the same **NM Cluster**.] ([RS_Nm_02535](#))

[SWS_Nm_00051] [The **NM Coordinator** shall be able to coordinate busses running the official AUTOSAR bus specific **NMs** as well as all other generic bus **NMs** implementing the required functionality, callbacks and interfaces.] ([RS_Nm_00044](#), [RS_Nm_02515](#))

Note: The required functionality, callbacks and interfaces are specified in [subsection 7.5.2](#). Coordinator Support for **J1939Nm** is not needed as the **J1939Nm** does not support shutdown handling.

[SWS_Nm_00055] [The **NM Interface** configuration shall provide the parameter [Nm-CoordinatorSupportEnabled](#) to define if the support of the *NM Coordinator functionality* is present or not.] ([RS_Nm_00150](#))

[SWS_Nm_00167] [It shall be possible to configure multiple **NM coordination clusters** that shall be coordinated independently.] ([RS_Nm_00045](#))

[SWS_Nm_00168] [Each bus shall belong to zero or one **NM coordination cluster**.] ([RS_Nm_00045](#), [RS_Nm_02511](#), [RS_Nm_02514](#))

Rationale: The configuration parameter `NmCoordClusterIndex` is used for specifying to which coordination cluster a bus belongs. If this parameter is undefined for a channel, the corresponding bus does not belong to an NM coordination cluster.

[SWS_Nm_00169] [Shutdown shall only be coordinated on the presently awake networks of a coordination cluster. Networks that are already in "bus-sleep mode" shall still be monitored but not coordinated.] ([RS_Nm_02516](#))

Rationale: The `NM Coordinator` does not require all busses in a coordination cluster to be awake, working with subsets of the coordination cluster resp. partial networks, to perform `coordinated shutdown`. It always monitors the shutdown initiation conditions and when these are met, it performs a coordinated shutdown of all the presently awake busses in the coordination cluster.

Note: It is outside the scope of the `Nm` to provide synchronized wakeup for coordinated busses. It is up to the application (-> vehicle mode management) to wake up the required resp. all channels if one channel wake up occurs.

7.2.2 Keeping coordinated busses alive

[SWS_Nm_00002] [As long as the node implementing the `NM Coordinator` is not ready to go to sleep on at least one of the busses in a coordination cluster (i.e. that it has actively requested the network), the `NM Coordinator` shall ensure that the network is requested on all currently active busses in that coordination cluster.] ([RS_Nm_00047](#))

[SWS_Nm_00003] [As long as at least one bus in the coordination cluster is not ready to sleep (i.e. because another node than the `NM Coordinator` is requesting that bus), the `NM Coordinator` shall still ensure that the network is requested on all currently active busses in that coordination cluster even if the local ECU itself is ready to go to sleep on all busses of that coordination cluster.] ([RS_Nm_00047](#))

Rationale: The **bus specific NMs** will indicate to `Nm` if the bus is ready to go to sleep or not by calling the callbacks `Nm_RemoteSleepIndication` and `Nm_RemoteSleepCancellation`. The local ECU will indicate if it is ready to go to sleep or not on a network using the API functions `Nm_NetworkRelease` and `Nm_NetworkRequest`.

Rationale: The `Nm` requests the network on a bus by calling the bus specific NM function `<Bus>Nm_NetworkRequest`.

Since all AUTOSAR bus specific `NMs` are built on the principle that one AUTOSAR node can keep the bus alive as long as it keeps the network requested, the `NM Coordinator` will keep all busses of the coordination cluster awake by requesting the network for the **bus specific NMs**.

The two requirements [\[SWS_Nm_00002\]](#) and [\[SWS_Nm_00003\]](#) above can be summarized as follows: as long as at least one node (including the node implementing the

NM Coordinator) keeps any of the busses in the coordination cluster awake, the *NM Coordinator* shall keep all busses of that coordination cluster awake.

[SWS_Nm_00228] [If a bus of a coordination cluster has the parameter *NmChannelSleepMaster* set to **TRUE**, the *NM Coordinator* shall consider that bus ready to sleep at all times and shall not await an invocation of *Nm_RemoteSleepIndication* from that bus before starting shutdown of that network.](*RS_Nm_02511*)

Rationale: This property shall be set for all **bus specific NMs** where the sleep of the bus can be absolutely decided by the local node only and that no other nodes of that bus can oppose that decision. An example of such a network is LIN where the local AUTOSAR ECU will always be the LIN bus master and can always solely decide when the network shall go to sleep.

7.2.3 Shutdown of coordinated busses

The level of synchronization achievable is dependent on the configuration. See [subsection 7.2.5](#), [Figure 7.1](#) shows an overview of the *coordination algorithm*. As described in [Section 7.2.1](#), the *coordination algorithm* and *coordinated shutdown* shall be applied independently per *NM coordination cluster*.

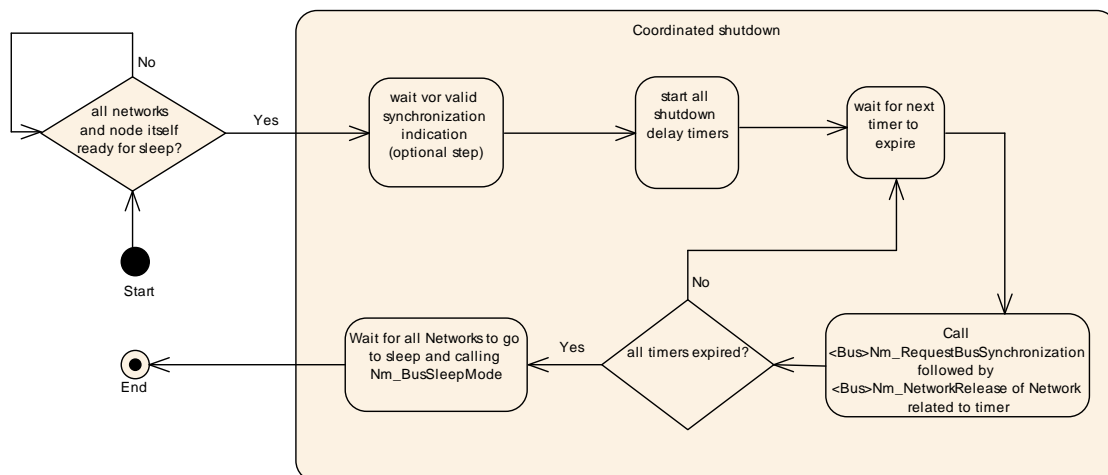

Figure 7.1: Overview of the coordination algorithm with the coordinated shutdown as part of it

Note: There is no limitation where the actions performed by the *coordination algorithm* shall take place.

This can be done either by the *Nm main function* (*Nm_MainFunction*) or module indication / callbacks.

[SWS_Nm_00171] [When all networks of a coordination cluster are either ready to go to sleep or already in "bus-sleep mode" the *NM Coordinator* shall start the *coordinated shutdown* on all awake networks. The *NM Coordinator* shall evaluate continuously if the *coordinated shutdown* can be started.](*RS_Nm_00047*, *RS_Nm_02516*, *RS_Nm_00054*)

Rationale: Evaluation of shutdown conditions can be also done in other API calls than the main function. The evaluation can be segmented then to check only the specific conditions affected by the API calls there, hence it is not necessary to re-evaluate all conditions in every main processing period and every API call.

[SWS_Nm_00172] [If the configuration parameter `NmSynchronizingNetwork` is **TRUE** for any of the busses in a coordination cluster, the coordination shutdown shall be delayed until a network that is configured as synchronizing network for this coordination cluster invoked `Nm_SynchronizationPoint`.] (*RS_Nm_00044*)

[SWS_Nm_00293] [If on a coordinated network the coordinator detects a mode change to `NM_MODE_SYNCHRONIZE`, `NM_MODE_PREPARE_BUS_SLEEP` or `NM_MODE_BUS_SLEEP` AND the coordinated cluster this network belongs to has not started the shutdown process AND if there is no internal network mode request for that channel by ComM, the coordinator shall treat this network as remote sleep and shall call `<Bus>Nm_NetworkRelease` for this network. If additionally for this network the configuration parameter `NmSynchronizingNetwork` is **TRUE** then the coordinator shall not wait for `Nm_SynchronizationPoint` on this network.] ()

Rationale: If one or more of the networks in the NM coordination clusters is cyclic (such as FlexRay), a higher level of synchronized shutdown will be achieved if the algorithm is synchronized with one of the included cyclic networks. If configured so, the shutdown timers for all coordinated networks will not be started until the synchronizing network has called the `Nm_SynchronizationPoint`.

Rationale: Although only one network per NM coordination cluster should be configured to indicate synchronization points, this will allow the *NM Coordinator functionality* to filter out all synchronization indications except those that originate from the network that is configured to be the synchronizing network of each coordination cluster.

[SWS_Nm_00173] [If not all conditions to start the `coordinated shutdown` have been met, or if the `coordinated shutdown` has already been started (but not aborted), calls to `Nm_SynchronizationPoint` shall be ignored.] (*RS_Nm_02516*)

Rationale: In some cases, non-synchronizing networks can take longer time to go to sleep. If this happens, the `coordinated shutdown` will be started based on one synchronization indication, but as the synchronizing network will not be released directly it will continue to invoke (several) more synchronization indications which can safely be ignored.

[SWS_Nm_00174] [If the configuration parameter `NmSynchronizingNetwork` is **FALSE** for all of the presently awake busses in a coordination cluster, the timers shall be started after all shutdown conditions have been met, without waiting for a call to `Nm_SynchronizationPoint`(). (see also [\[SWS_Nm_00172\]](#)).] (*RS_Nm_02516*)

[SWS_Nm_00175] [When the `coordinated shutdown` is started, a shutdown delay timer shall be activated for each currently awake channel in the coordination cluster. Each timer shall be set to `NmGlobalCoordinatorTime`. In case `NmBusType` is not set to `NM_BUSNM_LOCALNM` additionally the shutdown time of the specific channel `TSHUTDOWN_CHANNEL` shall be subtracted.] (*RS_Nm_00149*, *RS_Nm_02516*)

[SWS_Nm_00284] [If the `NmGlobalCoordinatorTime` is zero the shutdown delay timer of all channels shall also be zero.] ([RS_Nm_00149](#), [RS_Nm_02516](#))

Note: The `TSHUTDOWN_CHANNEL` can be calculated as described in [subsection 7.2.5](#) or with following formulas:

CanNm: Ready Sleep Time + Prepare BusSleep Time

FrNm: Ready Sleep Time, e.g.: $(FrNmReadySleepCnt+1) * FrNmRepetitionCycle$ * "Duration of one Flexray Cycle"

GenericNm: `NmGenericBusNmShutdownTime`

[SWS_Nm_00176] [When a shutdown timer expires for a network, **Nm** shall in case `Nm_BusNmType` is not set to `NM_BUSNM_LOCALNM` release the network by calling the `<Bus>Nm_RequestBusSynchronization` followed by `<Bus>Nm_NetworkRelease`. In case `BusNmType` is set to `NM_BUSNM_LOCALNM` **Nm** shall inform ComM about shutdown by calling `ComM_Nm_BusSleepMode`.] ([RS_Nm_02516](#))

Note: In the AUTOSAR Classic Platform, `CanNm_PassiveStartUp`, `J1939Nm_PassiveStartUp`, `FrNm_PassiveStartUp` and `UdpNm_PassiveStartUp` have been specified as the predefined interfaces corresponding to `<Bus>Nm_PassiveStartUp`.

[SWS_Nm_00177] [**Nm** shall keep track of all networks that have been released but have not yet reported "bus-sleep mode". If the shutdown is aborted, these networks shall still be considered active networks.] ([RS_Nm_02516](#))

Note: See Section [subsection 7.3.3](#).

Definition: When all networks have been released and all networks are in "bus-sleep mode", the [coordinated shutdown](#) is completed.

7.2.4 Coordination of nested sub-busses

To support the coordination of nested sub-busses the Nm-Coordinators need be configured to build up a coordination hierarchy. The top most `NM Coordinator` has only actively coordinated channels (`NmActiveCoordinator == TRUE`) per coordination cluster. This `NM Coordinator` has to initiate the [coordinated shutdown](#) for all other coordinators. An nested `NM Coordinator` receive his shutdown indication information from his passively configured channel (`NmActiveCoordinator == FALSE`) and provides this information to following NM Coordinators via his actively coordinated channels (`NmActiveCoordinator == TRUE`).

The [Figure 7.2](#) will explain this as an example.

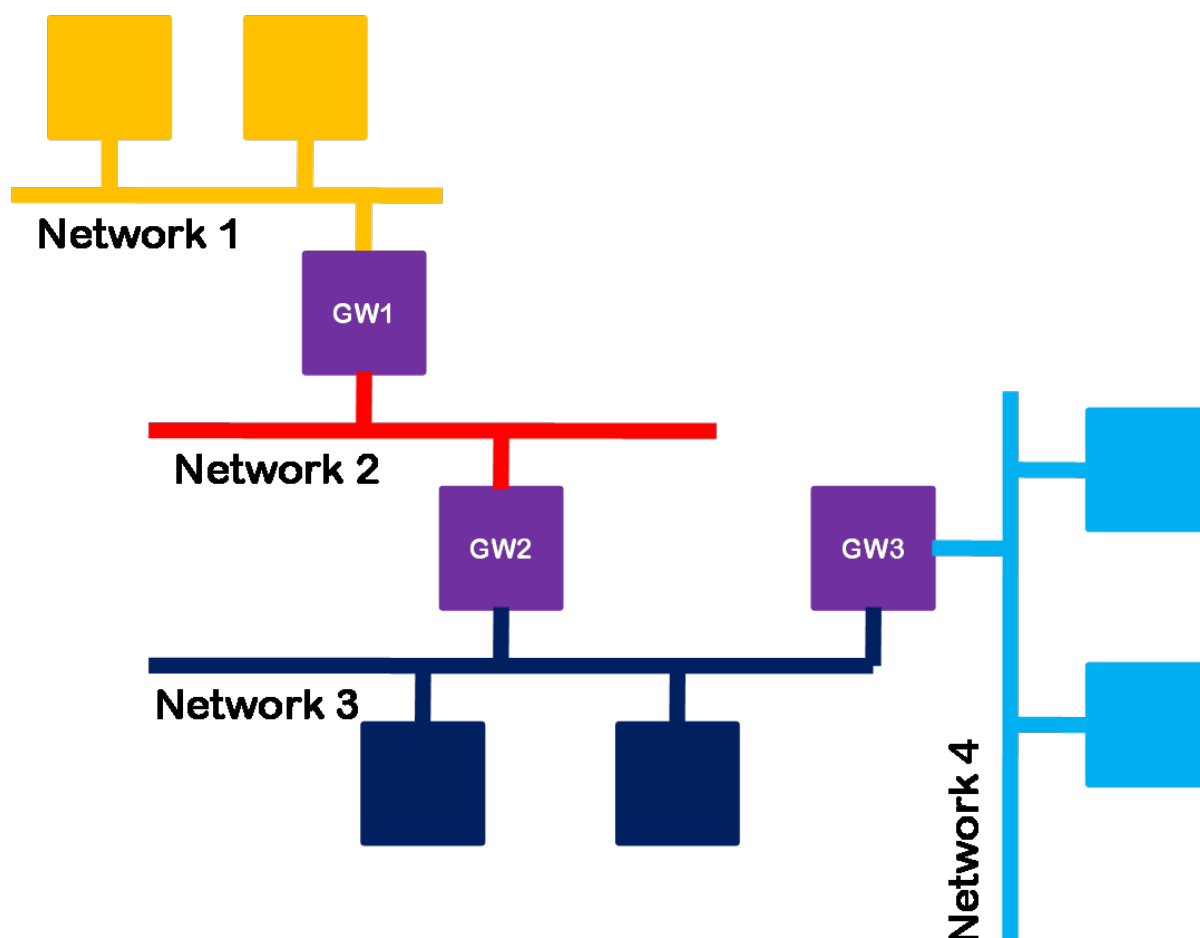

Figure 7.2: Use Case Nested Gateways

The exemplary topology shown in [Figure 7.2](#) has the following coordination approach. GW 1 have configured the channel onto Network 1 and Network 2 as actively coordinating channels. Where GW 2 is configured with Network 2 connection as passively coordinated channel, but with actively coordinated channel on Network 3. GW 3 then needs to be configured on Network 3 as passively coordinated channel but as actively coordinated channel for his connection to the Network 4.

[SWS_Nm_00280] [The functionality of coordinating nested sub busses shall be available if the `NmCoordinatorSyncSupport` parameter is set to **TRUE**.] ([RS_Nm_02535](#))

Note: All requirements within this chapter are valid “per Nm Coordination Cluster” (see [\[SWS_Nm_00167\]](#)).

The `NmActiveCoordinator` parameter indicates, if an `NM Coordinator` behaves on this channel in actively manner

(Actively coordinated channel) [`NmActiveCoordinator` = **TRUE**]

or behave in a passively manner

(Passively coordinated channel) [`NmActiveCoordinator` = **FALSE**].

[SWS_Nm_00257] [On its passively coordinated channels a *NM-Coordinator* shall send Nm messages only if the node has a network management request pending or a connected network which is coordinated actively by that *NM Coordinator* is not ready to sleep.](*RS_Nm_02535*)

Rationale: This prevents that 2 *NM Coordinators* at the same channel, send NM messages when they are ready to sleep and therefore keep the bus awake. Without this mechanism it would not be possible to detect if there is at least one other node active.

[SWS_Nm_00259] [The *NM Coordinator* shall set the *NMCoordinatorSleepReady* bit in the Nm message via `<Bus>Nm_SetSleepReadyBit` to the value 1 at his actively coordinated channels,

IF

all nodes of the *NM Coordination cluster* are ready to sleep (*RemoteSleepIndication*)

AND

IF *NmSynchronizingNetwork* is enabled a *Nm_SynchronizationPoint()* call has been received on the corresponding channel

AND

If all channels of this *NM Coordination cluster* are configured as *NmActiveCoordinator* == **TRUE**. AND

If the *NmBusType* is not configured to `NM_BUSNM_LOCALNM`.](*RS_Nm_02535*)

Note: for Position of Coordinator Bits in CBV see according `<Bus>Nm` specifications.

Note: This applies to the top most coordinator (no passively coordinated channel).

Rationale: Nodes which contain passively coordinated channels do not need a synchronization point as they are synchronized by the sleep ready bit of their active coordinator already.

Note: Nodes which contain a passively coordinated channel will set the bit according to the requirement in [*SWS_Nm_00261*].

[SWS_Nm_00261] [If *Nm_CoordReadyToSleepIndication* is received on a passively coordinated channel the NmCoordinator shall set the *NMCoordinatorSleepReady* bit to **SET (1)** via API call to `<Bus>Nm_SetSleepReadyBit` on all actively coordinated channels.](*RS_Nm_02535*)

[SWS_Nm_00271] [If *Nm_CoordReadyToSleepCancellation* is received on a passively coordinated channel the NmCoordinator shall set the *NMCoordinatorSleepReady* bit to **UNSET (0)** via API call to `<Bus>Nm_SetSleepReadyBit` on all actively coordinated channels.](*RS_Nm_02535*)

Note: On its passively coordinated channel a *NM Coordinator* would not set the *Sleep Ready* bit ever (via `<Bus>Nm` function call) but forward a received status change of *Sleep ready* bit onto its actively coordinated channels.

Note: On its actively coordinated channel(s) a *NM Coordinator* a call of *Nm_CoordReadyToSleepIndication* and *Nm_CoordReadyToSleepCancellation* is not expected.

[SWS_Nm_00262] [The *NM Coordinator* shall start *coordinated shutdown* after the *Sleep Ready* Bit with **SET** status has been requested.] (*RS_Nm_02535*)

[SWS_Nm_00281] [*NmGlobalCoordinatorTime* shall be set at least to the maximum time needed to shut down all Networks coordinated.] (*RS_Nm_00149*)

Note:This includes all nested connections.(for example see [Figure 7.3](#))

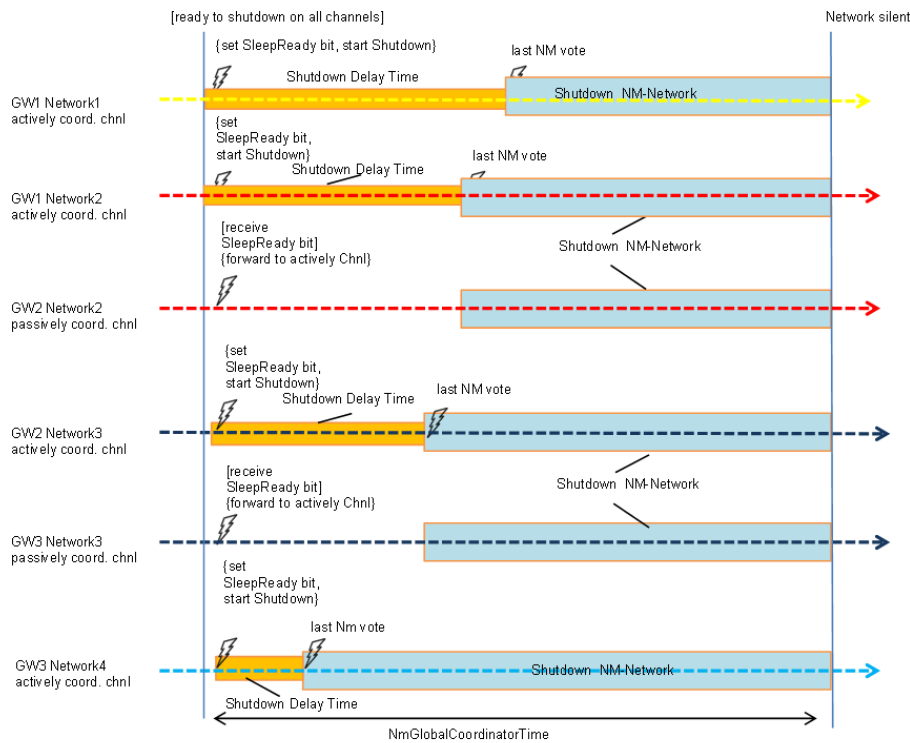

Figure 7.3: Shutdown with Nm_GlobalCoordinatorTime

[SWS_Nm_00267] [*NM Coordinator* shall set the *NMCoordinatorSleepReady* bit to **UNSET (0)** via API call to `<Bus>Nm_SetSleepReadyBit` on all actively coordinated channels if the *coordinated shutdown* has been aborted for any reason.] (*RS_Nm_02535*, *RS_Nm_02537*)

Note: Details about aborted shutdown can be found in [subsection 7.3.3](#).

7.2.5 Calculation of shutdown timers

The `coordination algorithm` is quite flexible since the level of synchronization achievable depends on the configuration of switches and timers. Depending on which event or point in time that is the goal to synchronize on, the configuration shall be done differently. This Chapter contains guide on how to achieve three different levels of synchronization. It is up to the configuration to follow these guidelines or to achieve a separate order of synchronization by choosing his/her own particular configuration. Therefore, this Section will not contain any requirement, only recommendations.

Note that absolute synchronization will never be possible to achieve. The jitter factors that determine the preciseness of the synchronization involve the processing period of the **Nm**, the exactness of the timers and the busload for non-deterministic busses. Correctly configured, the Use Cases described below will give the best possible synchronization that is achievable considering these circumstances.

Previous version of the `NM Coordinator` included the possibility for the coordinator algorithm to delay the start of the `coordinated shutdown` "a number of rounds". This specific delay has been removed but a similar behavior can still be obtained by increasing all shutdown timers (configuration parameter `NmGlobalCoordinatorTime`). Special care must be taken when cyclic networks (such as FlexRay) are used when this increased delay time should be quantified to the synchronization indication periodicity of those networks.

7.2.6 Synchronization Use Case 1 - Synchronous command

This Use Case focuses on how to synchronize the point in time where the different networks are released.

This results in the fastest possible total shutdown of all networks, but with the downside that the networks will not enter "bus-sleep mode" at the same time.

Rationale: One example of this Use Case is when several CAN networks shall be kept alive as long as any CAN-node is requesting one of the networks; but when all nodes are ready to go to sleep it does not matter if "bus-sleep mode" is entered at the same time for the different networks.

Since the Use Case does not consider any cyclic behavior of the networks, the synchronization parameter `NmSynchronizingNetwork` shall be set to **FALSE** for all networks and no **bus specific NM** shall be configured to invoke the `Nm_SynchronizationPoint` callback.

To achieve the fastest possible shutdown, the shutdown timer parameter `NmGlobalCoordinatorTime` needs to be set to 0.0.

7.2.7 Synchronization Use Case 2 - Synchronous initiation

This Use Case is an extension of Use Case 1, but here consideration is taken to the fact that for some networks the request to release the network will only be acted upon at specific points in time. This Use Case will command a simultaneous shutdown like in Use Case 1, but will wait until a point in time suitable for the synchronizing network.

Rationale: One example of this Use Case is when one FlexRay network and several CAN networks where the time when all networks are active shall be maximized, but the networks shall still be put to sleep as fast as possible.

Since this Use Case shall consider the cyclic behavior of a selected network, one of the networks shall have its synchronization parameter `NmSynchronizingNetwork` set to **TRUE** while the other networks shall have this parameter set to **FALSE**. The synchronizing network's **bus specific NM** shall also be configured to invoke the `Nm_SynchronizationPoint` callback at suitable points in time where the shutdown shall be initiated.

To achieve the fastest possible shutdown, the shutdown timer parameter `NmGlobalCoordinatorTime` needs to be set to `0.0`.

7.2.8 Synchronization Use Case 3 - Synchronous network sleep

This Use Case will focus on synchronizing the point in time where the different networks enters "bus-sleep mode". It will wait for indication from a synchronizing network, and then delay the network releases of all networks based on timing values so that the transition from "network mode" (or "prepare bus-sleep mode") into "bus-sleep mode" is as synchronized as possible.

Rationale: One example of this Use Case is when one FlexRay network and several CAN networks shall stop communicating at the same time.

Since this Use Case shall consider the cyclic behavior of a selected network, of the networks - preferably the cyclic one - shall have its synchronization parameter `NmSynchronizingNetwork` set to **TRUE** while the other networks shall have this parameter set to **FALSE**. The synchronizing network's **bus specific NM** shall also be configured to invoke the `Nm_SynchronizationPoint` callback at suitable points in time where the shutdown shall be initiated.

To calculate the shutdown timer **TSHUTDOWN_CHANNEL** of each network, specific knowledge of each networks timing behavior must be obtained.

For all networks, **TSHUTDOWN_CHANNEL** must be calculated, this is the minimum time it will take the network to enter "bus-sleep mode". For non-cyclic networks (such as CAN), the time shall be measured from the point in time when the network is released until it enters "bus-sleep mode". For cyclic networks (such as FlexRay) the time shall also include the full range from the synchronization indication made just before

the network is released. For Generic **BusNms** the time is given by the configuration parameter `NmGenericBusNmShutdownTime`.

For the synchronizing network, **TSYNCHRONIZATION_INDICATION** must be determined. This is the time between any two consecutive calls made by that **bus specific NM** to `Nm_SynchronizationPoint`.

The `NmGlobalCoordinatorTime` shall be the total time that is needed for the `co-ordination algorithm`. This includes the shutdown time of nested sub-busses. Start with setting `NmGlobalCoordinatorTime` to the same value as **TSHUTDOWN_CHANNEL** for the synchronizing network. If the **TSHUTDOWN_CHANNEL** for any other network is greater than `NmGlobalCoordinatorTime`, extend `NmGlobalCoordinatorTime` with **TSYNCHRONIZATION_INDICATION** repeatedly until `NmGlobalCoordinatorTime` is equal to, or larger than any **TSHUTDOWN_CHANNEL**.

The shutdown delay timer for each network shall be calculated as `NmGlobalCoordinatorTime` - **TSHUTDOWN_CHANNEL** for that network.

For the cyclic networks this parameter must then be increased slightly in order to make sure that the network release will occur between to synchronization indications, slightly after `Nm_SynchronizationPoint` (would) have been called. The amount of time to extend the timer depends on the implementation and configuration of the **bus specific NM** but should be far smaller than **TSYNCHRONIZATION_INDICATION**.

7.2.8.1 Examples

In the first case ([Figure 7.4](#)), the synchronizing network holds the largest **TSHUTDOWN_CHANNEL**, which will therefore equal the `NmGlobalCoordinatorTime`. For the synchronizing network, the shutdown delay timer will be `NmGlobalCoordinatorTime` - **TSHUTDOWN_CHANNEL**, which is zero, but then a small amount of time is added to make sure that the Nm will wait to release the network between the two synchronization points.

For the Non-cyclic network, the shutdown delay timer will simply be `NmGlobalCoordinatorTime` - **TSHUTDOWN_CHANNEL**.

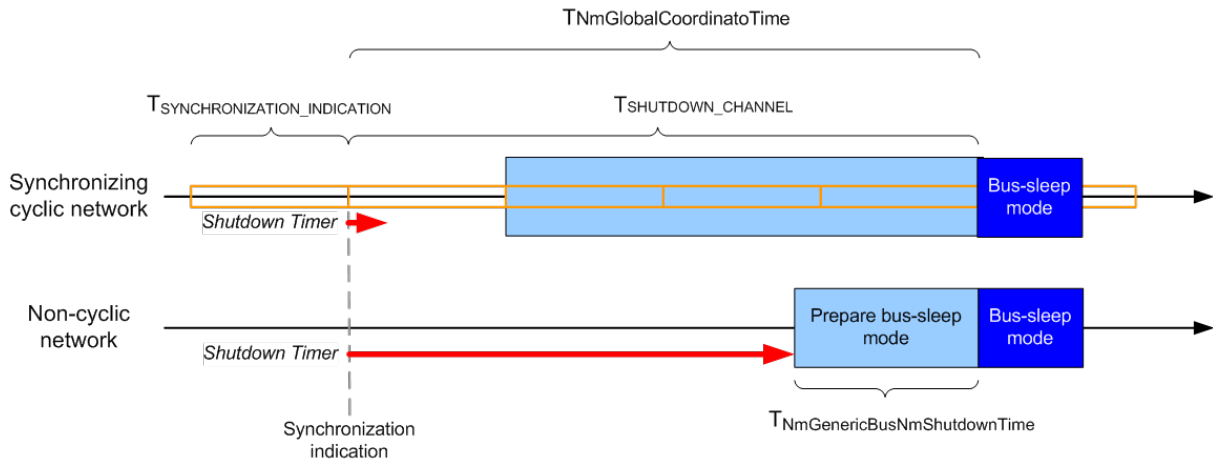

Figure 7.4: Timing example one

In the second case ([Figure 7.5](#)), the non-cyclic network takes very long time to shut down and therefore holds the largest **TSHUTDOWN_CHANNEL**. The **NmGlobalCoordinatorTime** has now been obtained by taking the synchronizing network’s (slightly shorter) **TSHUTDOWN_CHANNEL** adding **TSYNCHRONIZATION_INDICATION** once to this value.

For the synchronizing network, the shutdown timer will be **NmGlobalCoordinatorTime - TSHUTDOWN_CHANNEL**, with a small amount of time added to make sure that the **Nm** will wait to release the network between the two synchronization points. For the Non-cyclic network, the shutdown timer will simply be **NmGlobalCoordinatorTime - TSHUTDOWN_CHANNEL**.

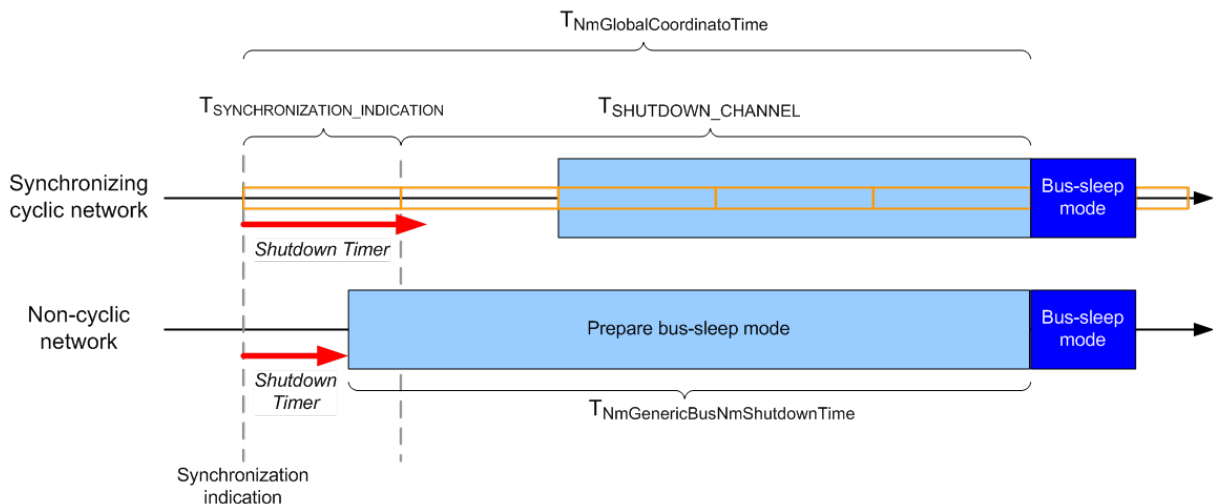

Figure 7.5: Timing example two

7.3 Wakeup and abortion of the coordinated shutdown

Nm is not responsible for normal wakeup of the node or the networks this will be done by the COM Manager (**ComM**).

7.3.1 External network wakeup

For both *Basic functionality* and *NM Coordination functionality*, **Nm** will forward wakeup indications from the networks (indicated by the bus specific NMs calling the callback `Nm_NetworkStartIndication`) to the **ComM** by calling `ComM_Nm_NetworkStartIndication()`. **ComM** will then call `Nm_PassiveStartUp`, which will be forwarded by Nm to the corresponding interface of the bus specific NM.

Processing of wake-up events for channels in bus-sleep (related to transceiver and controller state) will be handled by **EcuM** and **ComM**. No interaction of the **Nm** apply here. **Nm** will get the network request from **ComM** as stated above, depending on the wake-up validation and the respective communication needs.

[SWS_Nm_00245] [If the **ComM** calls `Nm_PassiveStartUp()` for a network that is part of a coordinated cluster of networks, the **Nm** coordinator functionality shall treat this call as if the **ComM** had called `Nm_NetworkRequest()`. In case `BusNmType` is not set to `NM_BUSNM_LOCALNM` the **Nm** shall forward a call of `<Bus>Nm_NetworkRequest` to the lower layer and accordingly, the network shall be counted as requested by the NM coordinator.] (*RS_Nm_02536*)

Note: In other words: Calls of `Nm_PassiveStartUp` for networks that are part of a cluster of coordinated networks shall be "translated" to / handled as calls of `Nm_NetworkRequest`.

7.3.2 Coordinated wakeup

Depending on the configuration, **ComM** can start multiple networks based on the indication from one network. It is recommended to configure the **ComM** to automatically start all network of a *NM Coordination Cluster* if one of the networks indicates network start, but this is not always necessary. Since the wakeup of network is outside the scope of **Nm**, this is independent of if the *NM Coordination functionality* is used or not.

7.3.3 Abortion of the coordinated shutdown

If the *NM Coordination functionality* is activated and `coordinated shutdown` has been initiated on an *NM Coordination Cluster*, dependent on the coordinator algorithm configuration it might take time before each included bus is actually released. If any node on one of the coordinated buses changes its state and starts requesting

the network before all networks are released, race conditions can occur in the `coordination algorithm`. This can happen in four ways:

1. A node on a network that has not yet been released and is still in 'network mode' starts requesting the network again. This will be detected by the **bus specific NM** which will inform **Nm** by calling `Nm_RemoteSleepCancellation`.
2. A node on a network that has already been released and has indicated "prepare bus-sleep mode" but not "bus-sleep mode" starts requesting the network again. This will be detected by the **bus specific NM** that will automatically change state to "network mode" and inform **Nm** by calling `Nm_NetworkMode`.
3. The **ComM** requests the network on any of the networks in the `NM Coordination Cluster`.
4. The coordinator which actively coordinates this network sends `Nm` message with cleared Ready-Sleep Bit. This will be detected by the Bus spec NM (only on passively coordinated channels) and forwarded to the NM by calling `Nm_CoordReadyToSleepCancellation`.

The generic approach is to abort the shutdown and start requesting the networks again. However, networks that have already gone into "bus-sleep mode" shall not be automatically woken up; this must be requested explicitly by **ComM**.

[SWS_Nm_00181] [The `coordinated shutdown` shall be aborted if any network in that `NM Coordination Cluster`,

- indicates `Nm_RemoteSleepCancellation` or
- indicates `Nm_NetworkMode` or
- indicates `Nm_CoordReadyToSleepCancellation`
- or the **ComM** request one of the networks with `Nm_NetworkRequest` or `Nm_PassiveStartUp`.

](`RS_Nm_02537`)

Note: `Nm_NetworkStartIndication` is not a trigger to abort the `coordinated shutdown`, as this is handled by the upper layer.

[SWS_Nm_00182] [If the `coordinated shutdown` is aborted, `NM Coordinator` shall call `ComM_Nm_RestartIndication` for all networks that already indicated "bus sleep".](`RS_Nm_02537`)

Rationale: Since **Nm** cannot take decision to wake networks on its own, this must be decided by **ComM** just as in the (external) wakeup case.

[SWS_Nm_00183] [If the `coordinated shutdown` is aborted, `NM Coordinator` shall in case `BusNmType` is not set `NM_BUSNM_LOCALNM` request the network from the `<Bus>Nm`'s for the networks that have not indicated "bus sleep". In case `BusNmType` is set to `NM_BUSNM_LOCALNM` **Nm** shall inform **ComM** about network startup by calling `ComM_Nm_NetworkMode`.](`RS_Nm_02537`)

[SWS_Nm_00185] [If the `coordination algorithm` has been aborted, all conditions that guard the initiation of the `coordinated shutdown` shall be evaluated again.] ([RS_Nm_02537](#))

Rationale: When a `coordinated shutdown` has been aborted, in most cases there are now networks in that NM Coordination Cluster that do not longer indicate that network sleep is possible, and thus the NM Coordinator must keep all presently non-sleeping networks awake. There can be cases where none of the conditions have been changed, which will only lead to a re-initiation of the `coordinated shutdown`.

[SWS_Nm_00235] [If a `coordinated shutdown` has been aborted and Nm receives `E_NOT_OK` on a `<Bus>Nm_NetworkRequest`, that network shall not be considered awake when the conditions for initiating a coordinated shutdown are evaluated again.] ([RS_Nm_02537](#))

Rationale: Any `<Bus>Nm` that needs to be re-requested during an aborted `coordinated shutdown` have previously been released, both by **ComM** and by **Nm**. It is the responsibility of the `<Bus>Nm` to inform the **ComM** (through **Nm**) that the network really has been released and therefore the **ComM** will have knowledge of the network state even though the error response on `Nm_NetworkRequest` never reached the **ComM** directly.

[SWS_Nm_00236] [If a `coordinated shutdown` has been initiated and Nm receives `E_NOT_OK` on a `<Bus>Nm_NetworkRelease`, the shutdown shall be immediately aborted. For all networks that have not entered "bus-sleep mode", **Nm** shall request the networks. This includes the network that indicated an error for `<Bus>Nm_NetworkRelease`. As soon as this has been done, the conditions for initiating coordinated shutdown can be evaluated again. This applies also to networks that were not actively participating in the current coordinated shutdown.] ([RS_Nm_02537](#))

Rationale: If a network cannot be released, it shall immediately be requested again to synchronize the states between the NM Coordinator in the **Nm** and the `<Bus>Nm`. The `coordinated shutdown` will eventually be initiated again as long as the problem with the `<Bus>Nm` persists. It is up to the `<Bus>Nm` to report any problems directly to the **DEM** and/or Default Error Tracer so the NM Coordinator shall only try to release the networks until it is successful.

7.4 Partial Network functionality

An overview regarding the partial network cluster functionality can be found in document Guide to Mode Management [9]

7.4.1 PNC bit vector filter algorithm

The intention of the `PNC bit vector` filter algorithm is to include all PNC requests that are relevant for the ECU for the PNC handling and to exclude all received PNC

requests that are not relevant for the ECU. Additionally the filter algorithm is used to qualify relevant PNC request for transmission. PNC requests which are qualified to be relevant (re-)start the corresponding PNC timer.

In order to distinguish between PNC requests that are relevant for the ECU and PNC requests that are not relevant, the `Nm` evaluates the `PNC bit vector` received by the `<Bus>Nm` (passive PNC requests, initiated remotely by another ECU in the network) and it evaluates the `PNC bit vector` transmitted by `ComM` (active request, initiated by a local application). Every bit of the `PNC bit vector` represents one PNC.

PNCs are statically configured. One PNC denotes the participation of an ECU to a specific partial network cluster (PNC).

[SWS_Nm_00308] [The `PNC bit vector` filter algorithm shall evaluate the bytes of the given `PNC bit vector` in the context of `Nm_PncBitVectorRxIndication`.] ([RS_Nm_02517](#), [RS_Nm_02527](#))

Note: If `<Bus>NmAllNmMessagesKeepAwake` is enabled, ECU might still be kept alive, even if no relevant PNC request was received.

[SWS_Nm_00312] [If `Nm_PncBitVectorRxIndication` is called, `NmPnEraCalcEnabled` or `NmPnEraCalcEnabled` is set to TRUE and at least one PNC bit is detected as relevant PNC request in the given `PNC bit vector`, the OUT parameter `RelevantPncRequestDetectedPtr` shall be set to TRUE. Otherwise the value of `RelevantPncRequestDetectedPtr` shall be set to FALSE.] ([RS_Nm_02517](#), [RS_Nm_02527](#))

Note: The value of `RelevantPncRequestDetectedPtr` is used by the caller `<Bus>Nm` to qualify if the received NMPDU shall be considered for further Rx Indication handling.

Example: The given `PNC bit vector` has a length of 2 bytes (`NmPncBitVectorLength`):

Byte 0	Byte 1
PNC bit vector	
0x12	0x8E

Table 7.1: Example of PNC bit vector

For this example two `NmPnFilterMaskBytes` would be defined, e.g

- `NmPnFilterMaskByteIndex` = 0 with `NmPnFilterMaskByteValue` = 0x01
- `NmPnFilterMaskByteIndex` = 1 with `NmPnFilterMaskByteValue` = 0x97

The filter algorithm actions and result would then be:

Filter Mask Value (Byte)	Compared to received PNC bit vector	Resulting in

0x01 (Byte 0)	0x12 (NM PDU Byte 4)	0x00 (no relevant PNC request)
0x97 (Byte 1)	0x8E (NM PDU Byte 5)	0x86 (relevant PNC request)

Table 7.2: Example PN Filter Algorithm

As one byte contains relevant information, the value of the boolean parameter `RelevantPncRequestDetectedPtr` is set to TRUE.

[SWS_Nm_CONSTR_00001] [The length of all configured `NmPnFilterMaskBytes` shall have the same length (in bytes) as the `NmPncBitVectorLength` of the corresponding NM-channel. A configuration tool shall reject a configuration as invalid (error), if the length of the configured `NmPnFilterMaskBytes` differ from the configured `NmPncBitVectorLength` of the corresponding NM-channel.]([RS_Nm_02517](#), [RS_Nm_02527](#))

7.4.2 Aggregation of PNC requests

7.4.2.1 Aggregation of internal and external Partial Network Cluster

[SWS_Nm_00302] [If `NmPnEiraCalcEnabled` is set to TRUE, then Nm shall provide the possibility to store external and internal requested PNCs combined over all NM-channels where `NmPnEnabled` is set to TRUE. At initialization the values of all PNCs within EIRA shall be set to 0 (PNC released).]([RS_Nm_02517](#), [RS_Nm_02563](#))

[SWS_Nm_00313] [If

- `NmPnEiraCalcEnabled` is TRUE
- and a PNC bit vector is received via `Nm_PncBitVectorRxIndication`(`<Nm-channel>`, `<PNC bit vector of external PNC requests>`) or `Nm_ForwardSynchronizedPncShutdown`(`<Nm-channel>`, `<PNC bit vector PNCs indicated for a synchronized shutdown>`)
- and PNCs are requested within this message (bits set to 1)
- and the requested PNCs are set to 1 within the configured PN filter mask

then Nm shall store the request information (value 1) for these PNCs as "PNC requested".]([RS_Nm_02517](#), [RS_Nm_02563](#))

[SWS_Nm_00534] [If

- `NmPnEiraCalcEnabled` is set to TRUE
- and a transmission of a PNC bit vector is indicated via `Nm_PncBitVectorTxIndication`(`<Nm-channel>`, `<buffer to provide the unfiltered PNC bit vector of aggregated internal PNC requests >`)

- and no requests for a synchronized PNC shutdown are pending on the given NM-channel
- and PNCs are requested within the stored unfiltered PNC bit vector (bits set to 1)
- and the requested PNCs of the stored unfiltered PNC bit vector for internal PNC requests are set to 1 within the configured PN filter mask

then Nm shall store the request information (value 1) for these PNCs as "PNC requested".](RS_Nm_02517, RS_Nm_02563)

[SWS_Nm_00535] [If NmPnEiraCalcEnabled is TRUE, Nm_PncBitVectorTxIndication(<NM-channel>, PncBitVectorPtr <buffer to provide the unfiltered PNC bit vector>) is called and no requests for synchronized PNC shutdown are pending on the given NM-channel, then Nm shall copy the unfiltered PNC bit vector for internal PNC requests of the given NM-channel to the buffer indicated by PncBitVectorPtr.](RS_Nm_02517, RS_Nm_02563)

[SWS_Nm_00536] [If

- NmPnEiraCalcEnabled is set to TRUE
- and requests for a synchronized PNC shutdown are pending on the given NM-channel
- and a transmission of a PNC bit vector is indicated via Nm_PncBitVectorTxIndication(<NM-channel>, <buffer to provide the PNC bit vector of the aggregated synchronized PNC requests >),
- and PNCs are requested for a synchronized PNC shutdown within the PNC bit vector (bits set to 1)
- and the aggregated synchronized PNC requests of the PNC bit vector are set to 1 within the configured PN filter mask,

then Nm shall store the request information (value 1) for these PNCs as "PNC requested".](RS_Nm_02517, RS_Nm_02563)

[SWS_Nm_00537] [If NmPnEiraCalcEnabled is set to TRUE, Nm_PncBitVectorTxIndication(NetworkHandle <NM-channel>, PncBitVectorPtr <buffer to provide the aggregated synchronized PNC requests as bit vector>) is called and requests for synchronized PNC shutdown are pending on the given NM-channel, then Nm shall set the buffer indicated by PncBitVectorPtr as follows :

- set all according bits to 1 that relate to a PNC requested for synchronized PNC shutdown of the given NM-channel
- set all other bits to 0

](RS_Nm_02517, RS_Nm_02563)

Note: The Nm module has to aggregate all PNCs which were indicated for a synchronized PNC shutdown and transfer the pncId's to a byte array (PNC bit vector). Each bit (PNC bit) of the PNC bit vector represent a particular PNC. The `byteIndex` and `bitIndex` within the PNC bit vector of PNC bit can be determined as follows:

- $\text{byteIndex} = (\text{PncId} \div 8)$
- $\text{bitIndex} = (\text{PncId} \bmod 8)$

[SWS_Nm_00330] [For all configured NM-channel where `NmPartialNetworkSupportEnabled` is set TRUE, Nm shall provide the possibility to store external and internal requested PNCs combined over all NM-channels where `NmPnEnabled` is set to TRUE. At initialization the values of all PNCs within EIRA shall be set to 0 (PNC released).] ([RS_Nm_02517](#), [RS_Nm_02562](#))

[SWS_Nm_00317] [If `Nm_UpdateIRA`(<NM-channel>, <PncBitVector of aggregated internal PNC requests>) is called, the Nm shall store the received unfiltered PncBitVector per given NM-channel. Therefore, the Nm module shall copy the amount of bytes with respect of the configured length (see `NmPncBitVectorLength`) of the given NM-Channel.] ([RS_Nm_02517](#), [RS_Nm_02563](#), [SRS_ModeMgm_09250](#))

Note: Nm stores unfiltered internal PNC requests in order to support the possibility of requesting a PNC on a specific channel even if the PNC is not assigned to the channel.

[SWS_Nm_00318] [If `NmPnEiraCalcEnabled` is TRUE, then Nm shall provide a possibility to monitor each relevant PNC in the context of `Nm_MainFunction`. The monitoring shall consider the PNC state, if the PNC is still externally or internally requested on at least one of the relevant NM-channels.] ([RS_Nm_02517](#), [RS_Nm_02563](#))

Note: This means, only one timer is required to handle one PNC on multiple connected physical channels. For example: only 8 EIRA reset timers are required to handle the requests of a Gateway with 6 physical channels and 8 partial network clusters. This is possible because the switch of PNC related PDU-Groups is done global for the ECU and independent of the physical channel.

[SWS_Nm_00319] [If `NmPnEiraCalcEnabled` is TRUE and every time a PNC is stored as "PNC requested" (see [\[SWS_Nm_00313\]](#)), then the monitoring for this PNC shall be restarted with respect to `NmPnResetTime` in the context of `Nm_MainFunction`.] ([RS_Nm_02517](#), [RS_Nm_02563](#))

Note: `NmPnResetTime` has to be configured to a value greater than `<Bus>NmMsgCycleTime`. If `NmPnResetTime` is configured to a value smaller than `<Bus>NmMsgCycleTime` and only one ECU requests the PNC, the request state toggles in the EIRA, because the request state reset before the requesting ECU is able to transmit the PNC bit vector within the next NM message.

Note: `NmPnResetTime` has to be configured to a value smaller than `<Bus>NmTimeoutTime` to avoid that the timer elapses after `<Bus>Nm` already changed to a state where it is expected that application communication is disabled (e.g. change to Prepare Bus Sleep (**UdpNm**, **CanNm**) or Bus Sleep (**FrNm**)).

[SWS_Nm_00320] [If `NmPnEiraCalcEnabled` is TRUE and a PNC is not requested again within `NmPnResetTime` the corresponding stored value for this PNC shall be set to PNC released (value 0) in the context of `Nm_MainFunction`.] (*RS_Nm_02517*, *RS_Nm_02563*)

[SWS_Nm_00321] [If `NmPnEiraCalcEnabled` is TRUE and the stored value for a PNC is set to PNC requested or back to PNC released (see [\[SWS_Nm_00313\]](#) and [\[SWS_Nm_00320\]](#)), then `Nm` shall forward the changed state of EIRA to `ComM` by calling `ComM_Nm_UpdateEIRA(<PncBitVector of EIRA>)`.] (*RS_Nm_02517*, *RS_Nm_02565*, *SRS_ModeMgm_09250*)

Note: If a PN shutdown message is received (PNSR is set to 1), no special handling is needed, because the according PNC state machines need to stay in `COMM_PNC_READY_SLEEP`. Only the ERA PDU is handled in a different way (see [\[SWS_Nm_00305\]](#))

7.4.2.2 Aggregation of external Partial Network Cluster

[SWS_Nm_00322] [If `NmPnEraCalcEnabled` is TRUE, then `Nm` shall provide the possibility to store relevant external PNCs request per channel. At initialization the values of all PNCs shall be set to 0 (PNC released).] (*RS_Nm_02517*, *RS_Nm_02564*)

[SWS_Nm_00323] [If

- `NmPnEraCalcEnabled` is TRUE
- and a PNC bit vector is received via `Nm_PncBitVectorRxIndication(<NM-channel>, <PncBitVector of external PNC requests>)`
- and PNCs are requested within this message (bits set to 1)
- and the requested PNCs are set to 1 within the configured PN filter mask

then `Nm` shall store the PNC request information (value 1) for these PNCs as "PNC requested" per given channel.] (*RS_Nm_02517*, *RS_Nm_02564*)

[SWS_Nm_00324] [If `NmPnEraCalcEnabled` is TRUE, then `Nm` shall provide a possibility to monitor each relevant PNC per channel in the context of `Nm_MainFunction`. The monitoring shall consider the PNC state, if the PNC is still externally requested on the corresponding NM-channels.] (*RS_Nm_02517*, *RS_Nm_02564*)

Note: This means, a separate timer is required to handle one PNC on multiple physical channels. For example: 48 ERA PNC reset timers are required to handle the external PNC requests of a PNC gateway with 6 physical channels and 8 partial network clusters. It is not possible to combine the PNC reset timer as it is possible for EIRA PNC timers, because the external PNC request mustn't be mirrored back to the bus / network from where the PNC request was received. Thus, it is required to detect the physical channel that is the source of the PNC request.

[SWS_Nm_00325] [If `NmPnEraCalcEnabled` is TRUE, then every time a PNC is stored as "PNC requested" (see [\[SWS_Nm_00323\]](#)), the monitoring for this PNC shall be restarted with respect to `NmPnResetTime` in the context of `Nm_MainFunction`.] ([RS_Nm_02517](#), [RS_Nm_02564](#))

Note: `NmPnResetTime` has to be configured to a value greater than `<Bus>NmMsgCycleTime`. If `NmPnResetTime` is configured to a value smaller than `<Bus>NmMsgCycleTime` and only one ECU requests the PNC, the request state toggles in the EIRA because the request state is reset before the requesting ECU is able to transmit the PNC bit vector within the next NM message.

Note: `NmPnResetTime` has to be configured to a value smaller than `<Bus>NmTimeoutTime` to avoid that the timer elapses after `<Bus>Nm` already changed to a state where it is expected that application communication is disabled (e.g. change to Prepare Bus Sleep (**UdpNm**, **CanNm**) or Bus Sleep (**FrNm**)).

[SWS_Nm_00326] [If `NmPnEraCalcEnabled` is TRUE and a PNC is not requested again within `NmPnResetTime` the corresponding stored value for this PN shall be set to PNC released (value 0).] ([RS_Nm_02517](#), [RS_Nm_02564](#))

[SWS_Nm_00327] [If `NmPnEraCalcEnabled` is TRUE and the stored value for a PNC is set to PNC requested or back to PNC released (see [\[SWS_Nm_00323\]](#) and [\[SWS_Nm_00326\]](#)), then `Nm` shall forward the changed state of ERA of the affected NM-channel to `ComM` by calling `ComM_Nm_UpdateERA(<ComMChannel>, <PncBitVector of ERA>)`.] ([RS_Nm_02517](#), [RS_Nm_02565](#), [SRS_ModeMgm_09250](#))

[SWS_Nm_00331] [If `NmPnEraCalcEnabled` is TRUE and `NmPnEraCalcEnabled` is TRUE, the PNC status information has to be stored separately for both, the EIRA and ERA information (compare [\[SWS_Nm_00302\]](#) and [\[SWS_Nm_00322\]](#)).] ([RS_Nm_02517](#))

7.4.3 EIRA / ERA state and PNC reset timer handling

PNC reset timers for ERA and EIRA are handled in the context of `Nm_Mainfunction`. PNC reset timers are used for the monitoring of PNC requests. Based on the current available PNC requests and the current state of the corresponding PNC reset timers, particular actions have to be performed (e.g. re-start PNC timer, set requested PNC to PNC released)

[SWS_Nm_00328] [If `NmPartialNetworkSupportEnabled` is set to TRUE, then all PNC reset timers shall be stopped at initialization.] ([RS_Nm_02517](#), [RS_Nm_02564](#))

[SWS_Nm_00329] [If `NmPartialNetworkSupportEnabled` is set to TRUE, then the evaluation of the PNC states in combination with PNC reset timers shall consider at least the following order:

- Update PNC reset timers

- Evaluate the PNC states
- Perform actions based on the current state of PNC reset timer and PNC requests

]([RS_Nm_02517](#), [RS_Nm_02564](#))

The monitoring of PNC requests and the PNC reset timer handling is kept as implementation specific. The following section shows an example, how the EIRA / ERA evaluation and PNC reset timer could be handled in the main function of [Nm](#). This is described to support the understanding of the overall mechanism of the PNC handling in [Nm](#).

Example: The following example is based on the following assumptions:

- each PNC reset timer has 3 states(stopped, elapsed, running)
- if a PNC reset timer is started, the PNC reset timer is loaded with `NmPnResetTime`
- a running PNC reset timer is decremented in each call of the main function, until it reaches value '0'
- PNC gateway functionality is enabled:
 - One ERA as `PNC bit vector` exists per channel
 - One EIRA as `PNC bit vector` exist

At initialization the PNC reset timers are in state "stopped" and the EIRA / ERA `PNC bit vectors` are set value '0' (PNC released). The PNC reset timers are started if a relevant PNC (PNC that pass the PN filter mask) is received where the value is set to '1' (e.g. [[SWS_Nm_00325](#)]). In each main function all PNC timers are decremented as first step. Afterwards the current PNC requests are evaluated in combination with the state of the according PNC reset timer. Particular actions are performed based on the evaluation result. As final step the EIRA / ERA `PNC bit vectors` are erased (set to '0'). This is needed to refresh the current state of PNC requests until the next main function call and to detect changes from PNC requested to PNC released and vice versa. (Please note: EIRA is always updated if a `PNC bit vector` with relevant PNC requests is received or if a `PNC bit vector` with relevant PNC requests is transmitted. ERA is always updated if a `PNC bit vector` with relevant PNC request of the according channel is received.) Based on this example EIRA and ERA is used to store a snapshot of PNC requests between 2 main function calls. In each main function call PNC requests conveyed from the EIRA / ERA storage to either PNC reset timer and/or as change to [ComM](#).

[Table 7.3](#) shows the evaluation details of the example. Column "EIRA / ERA PNC state" and "PNC reset timer state" is the input and column "Evaluation result" is the output of the evaluation. The output describes which action has to be performed.

EIRA / ERA PNC state)	PNC reset timer state	Evaluation result
PNC requested	Stopped	Start PNC reset timer, set PNC reset timer state to "running" and inform ComM regarding the PNC state change
PNC requested	Elapsed	Restart PNC reset timer, set PNC reset timer state to "running" and inform ComM regarding the PNC state change
PNC requested	Running	Restart PNC reset timer
PNC released	Stopped	Do nothing
PNC released	Elapsed	Set PNC reset timer to "stopped" and inform ComM regarding the PNC state change
PNC released	Running	Do nothing (Please note: time of the PNC reset timer was already decrement as very first action in the main function)

Table 7.3: Example for EIRA / ERA PNC state handling in combination with PNC reset timer state.

7.4.4 Synchronized PNC shutdown functionality

The synchronized PNC shutdown is a functionality which is a cooperation of **ComM**, **Nm** and **<Bus>Nm** to ensure a synchronized PNC shutdown at almost the same point in time across the whole PN topology. A synchronized PNC shutdown is handled by ECUs in role of a top-level PNC coordinator or intermediate PNC coordinator and where the PNC gateway is enabled. If **ComM** of an ECU in the role of a top-level PNC coordinator detects that a PNC is released, the **ComM** requests a synchronized PNC shutdown by calling `Nm_RequestSynchronizedPncShutdown` per ComMChannel and ComMPnc. The Nm module store all requests and handle them in the context of the Nm_Mainfunction. The Nm module indicate the affected **<Bus>Nms** regarding an activated PNC shutdown process. The **<Bus>Nms** call the Nm module to provide the aggregated requests for a synchronized PNC shutdown as `PNC bit vector` per given NM-channel. The **<Bus>Nms** use the provided `PNC bit vector` to assemble a NM-PDU as PN shutdown message and transmit this NM message on the according NM channel. If a PN shutdown message is received by an ECU in the role of an intermediate PNC coordinator, the **<Bus>Nms** extract the `PNC bit vector` from the received PN shutdown message and forward the information by calling the callback function **Nm_ForwardSynchronizedPncShutdown**. The callback function will immediately forward the indication to **ComM** by calling `ComM_Nm_ForwardSynchronizedPncShutdown`. **ComM** will immediately request

a synchronized PNC shutdown of all actively PNC coordinated (coordinated by a PNC gateway) ComMChannels. The requests for a synchronized PNC shutdown are forwarded to Nm module per NM-channel and handled in the same way as described in the previous section.

If a PNC leaf node receives a top-level PNC coordinator Nm frame, then it will handle the frame as a usual NM message (update the local PNC bit vector and reset PN reset time).

[SWS_Nm_00533] [If `NmPartialNetworkSupportEnabled` is set to TRUE, then PNC shutdown handling shall be considered as deactivated at initialization.]([RS_Nm_02517](#), [RS_Nm_02571](#))

[SWS_Nm_00521] [If function `Nm_RequestSynchronizedPncShutdown` is called, `NmSynchronizedPncShutdownEnabled` is set to TRUE and `NmStandardBusType` of the given NM-channel is set to a type other than `NM_BUSNM_LOCALNM`, the Nm module shall store the given PNC (PncId) per given NM-channel (`NetworkHandle`) as a pending request for a synchronized PNC shutdown.]([RS_Nm_02571](#))

[SWS_Nm_00305] [If the reception of PN shutdown message via callback function `Nm_ForwardSynchronizedPncShutdown` is indicated, then Nm shall stop the ERA related monitoring of external PNC requests of the PNCs (see [\[SWS_Nm_00324\]](#)) which are indicated for an PNC shutdown (PNC bit set to '1') in the given PNC bit vector, set the corresponding ERA bits to '0' in the ERA of the indicated NM-channel and forward the indication to ComM with the corresponding ComMChannel by calling `ComM_Nm_ForwardSynchronizedPncShutdown` (`<ComMChannel>`, `<PncBitVector>`).]([RS_Nm_02548](#))

Note:

- The PNC bit vector of a received PN shutdown message shall be used to release the PNCs for a synchronized shutdown. Explicitly clear the affected ERA bits of the indication NM-channel, stop the ERA monitoring for the indicated PNCs of the indicated NM-channel and pass the indication for a synchronized PNC shutdown to the ComM module. The synchronized PNC shutdown has to be handled as fast as possible. Therefore, the ComM module is informed immediately.
- Stopping the ERA related monitoring should not result in a call of `ComM_UpdateERA`. ComM ensure a proper handling of the ComM internal ERA bits within the context of `ComM_Nm_ForwardSynchronizedPncShutdown`. This should support an unambiguous handling of the PNC state machine for a synchronized PNC shutdown

[SWS_Nm_00525] [If `NmPnShutdownMessageRetransmissionDuration` is configured and `Nm_RequestSynchronizedPncShutdown` is called (refer to [\[SWS_Nm_00523\]](#)), then the corresponding retransmission timer for PN shutdown messages shall be started with `NmPnShutdownMessageRetransmissionDuration` on all affected NM-channels.]([RS_Nm_02571](#))

[SWS_Nm_00523] [If `NmSynchronizedPncShutdownEnabled` is set to TRUE, requests for synchronized PNC shutdown are pending and PNC shutdown handling has been deactivated, then Nm shall activate the PNC shutdown handling by calling `<Bus>Nm_ActivateTxPnShutdownMsg.`]([RS_Nm_02571](#))

[SWS_Nm_00524] [If `NmSynchronizedPncShutdownEnabled` is set to TRUE, no requests for synchronized PNC shutdown are pending, PNC shutdown handling has been activated, then Nm shall deactivate the PNC shutdown handling by calling `<Bus>Nm_DeactivateTxPnShutdownMsg.`]([RS_Nm_02571](#))

[SWS_Nm_00527] [If `NmSynchronizedPncShutdownEnabled` is set to TRUE, PNC shutdown handling has been activated (refer to [\[SWS_Nm_00523\]](#)) and `Nm_PncBitVectorTxConfirmation` is called with `E_OK`, then the Nm module shall consider those PNC IDs, stored as pending request for a synchronized PNC shutdown of the given NM-channel, as completed which were indicated by the given PNC bit vector (PNC bit set '1') and remove them from storage. Additionally, if `NmPnShutdownMessageRetransmissionDuration` is configured, then the Nm module shall cancel the retransmission timer for PN shutdown messages of the affected NM-channel.]([RS_Nm_02571](#))

Note:

- Nm has to ensure that new request for a synchronized PNC shutdown (indicated via `Nm_RequestSynchronizedPncShutdown`) are not lost, during an ongoing PNC shutdown process.
- The `<Bus>Nm` has to handle the re-transmission of the NM-PDU as PN shutdown message as long as `Nm_PncBitVectorTxConfirmation` is called with `E_NOT_OK` or the re-transmission timer for PN shutdown messages is running.

[SWS_Nm_00529] [If `NmSynchronizedPncShutdownEnabled` is set to TRUE and the Nm module has stored PNC IDs as pending request for a synchronized PNC shutdown, then Nm shall remove those PNC IDs from storage which are either externally or internally requested again:

- Nm shall check on reception of an PNC bit vector via call of `Nm_PncBitVectorRxIndication`, if externally requested PNCs are received.
- Nm shall check on update of an PNC bit vector via call of `Nm_UpdateIRA`, if internal PNC requests are available .

]([RS_Nm_02571](#))

[SWS_Nm_00530] [If `NmSynchronizedPncShutdownEnabled` is set to TRUE, `NmPnShutdownMessageRetransmissionDuration` is not configured, the corresponding `<Bus>Nm` module of this NM-channel has indicated transmission request via call of `Nm_PncBitVectorTxIndication` and `Nm_PncBitVectorTxConfirmation` is called with result `E_NOT_OK` (transmission of the given PNC bit vector failed), then the Nm shall remove the PNC IDs stored as pending request for a synchronized PNC shutdown of the corresponding NM-channel and report the runtime

error NM_E_TRANSMISSION_OF_PN_SHUTDOWN_MESSAGE_FAILED to DET.](RS-Nm_02571)

[SWS_Nm_00532] [If `NmSynchronizedPncShutdownEnabled` is set to TRUE and a retransmission timer for a PN shutdown message (see `NmPncShutdownMessageRetransmissionDuration`) expires, then Nm shall remove the pending request for a synchronized PNC shutdown of the corresponding NM-channel from the storage and report the runtime error NM_E_TRANSMISSION_OF_PN_SHUTDOWN_MESSAGE_FAILED to DET.](RS-Nm_02571)

Note: If a retransmission timer for PN shutdown messages is configured and the NM message was not transmitted successfully (`NmPncBitVectorTxConfirmation` is called with result **E_NOT_OK**), then the duration of PNC shutdown process continue. In the worst case the PN shutdown process coincide with a post poned NM message transmitted with **<Bus>NmMsgCycleTime**. But in any case, if the capability to transmitted NM messages is not re-covered within the PN reset time (EIRA), the PNCs will shutdown not synchronized, which might lead to timeout errors on application level.

7.5 Prerequisites of bus specific Network Management modules

This chapter gives an overview of the API calls that are used for the *Basic functionality*, the *NM Coordination functionality* and *synchronized PNC shutdown functionality* as well as information on the expected behavior of the **bus specific NM** for both functionalities.

For specific requirements of the interfaces and the configuration parameters for enabling/disabling the API's, refer to chapter 8.

7.5.1 Prerequisites for basic functionality

The **Nm** only acts as a forwarding layer between the **ComM** and the **bus specific NM** for the *basic functionality*.

All API calls made from the upper layer shall be forwarded to the corresponding API call of the lower layer. All callbacks of **Nm** invoked by the lower layer shall be forwarded to the corresponding callback of the upper layer.

The *Basic functionality* provides the following API calls to the ComM:

- `Nm_NetworkRequest` - [SWS_Nm_00032]
- `Nm_NetworkRelease` - [SWS_Nm_00046]
- `Nm_PassiveStartUp` - [SWS_Nm_00031]

Note: This implies that the **bus specific NM** provides the corresponding functions `<Bus>Nm_NetworkRequest`, `<Bus>Nm_NetworkRelease` and `<Bus>Nm_PassiveStartUp`.

The *Basic functionality* forwards the following API callbacks to the **ComM**:

- `Nm_NetworkStartIndication` - [SWS_Nm_00154]
- `Nm_NetworkMode` - [SWS_Nm_00156]
- `Nm_BusSleepMode` - [SWS_Nm_00162]
- `Nm_PrepareBusSleepMode` - [SWS_Nm_00159]

Note: This implies that the **ComM** provides the corresponding callback functions `ComM_Nm_NetworkStartIndication`, `ComM_Nm_NetworkMode`, `ComM_Nm_BusSleepMode` and `ComM_Nm_PrepareBusSleepMode`.

The **Nm** provides a number of API calls to the upper layers that are not used by **ComM**. These are provided for OEM specific extensions of the NM stack and are not required by any AUTOSAR module. They shall be forwarded to the corresponding API calls provided by the **bus specific NMs**.

The *Basic functionality* provides the following API calls to any OEM extension of an upper layer:

- `Nm_DisableCommunication` - [SWS_Nm_00033]
- `Nm_EnableCommunication` - [SWS_Nm_00034]
- `Nm_SetUserData` - [SWS_Nm_00035]
- `Nm_GetUserData` - [SWS_Nm_00036]
- `Nm_GetPduData` - [SWS_Nm_00037]
- `Nm_RepeatMessageRequest` - [SWS_Nm_00038]
- `Nm_GetNodeIdentifier` - [SWS_Nm_00039]
- `Nm_GetLocalNodeIdentifier` - [SWS_Nm_00040]
- `Nm_CheckRemoteSleepIndication` - [SWS_Nm_00042]
- `Nm_GetState` - [SWS_Nm_00043]

Note: This implies that the **bus specific NM** optionally provides the corresponding functions.

7.5.2 Prerequisites for NM Coordinator functionality

The *coordination algorithm* makes use of the following interfaces of the **bus specific NM**:

- `<Bus>Nm_NetworkRequest` - [SWS_Nm_00119]
- `<Bus>Nm_NetworkRelease` - [SWS_Nm_00119]
- `<Bus>Nm_RequestBusSynchronization` - [SWS_Nm_00166]
- `<Bus>Nm_CheckRemoteSleepIndication` - [SWS_Nm_00166]

Note: All NM networks configured to be part of a coordinated cluster of the *NM coordinator functionality* must have the corresponding Bus NM configured to be able to actively send out NM messages (e.g. `CANNM_PASSIVE_MODE_ENABLED = false`). As a result of this configuration restriction, all **<Bus>Nm** used by the *coordinator functionality* of the Nm module must provide the API `<Bus>Nm_NetworkRequest`.

Note: Any configuration where a network is part of a coordinated cluster of networks where the corresponding **<Bus>Nm** is configured as passive is invalid.

Note: The `<Bus>Nm_RequestBusSynchronization` is called by **Nm** immediately before `<Bus>Nm_NetworkRelease` in order to allow non-synchronous networks to synchronize before the network is released. For some networks, this call has no meaning. The **bus specific NM** shall still provide this interface in order to support the generality of the *NM Coordinator functionality*, but can choose to provide an empty implementation.

Rationale: The `<Bus>Nm_CheckRemoteSleepIndication` is never explicitly mentioned in the *coordination algorithm*. Its use is dependent on the implementation.

The *coordination algorithm* requires that the following callbacks of the **Nm** can be invoked by the **bus specific NM**:

- `Nm_NetworkStartIndication` - [SWS_Nm_00154]
- `Nm_NetworkMode` - [SWS_Nm_00156]
- `Nm_BusSleepMode` - [SWS_Nm_00162]
- `Nm_PrepareBusSleepMode` - [SWS_Nm_00159]
- `Nm_SynchronizeMode` - [SWS_Nm_91002]
- `Nm_RemoteSleepIndication` - [SWS_Nm_00192]
- `Nm_RemoteSleepCancellation` - [SWS_Nm_00193]
- `Nm_SynchronizationPoint` - [SWS_Nm_00194]

Note: The `Nm_NetworkStartIndication`, `Nm_NetworkMode`, `Nm_BusSleepMode` and `Nm_PrepareBusSleepMode` are used by the *coordination algorithm* to keep track of the status of the different networks and to handle aborted shutdown (see Chapter 7.3.3).

Note: The `Nm_RemoteSleepIndication` and `Nm_RemoteSleepCancellation` are used by the *coordination algorithm* to determine when all conditions for

initiating the `coordinated shutdown` are met. The indication will be called by the **bus specific NM** when it detects that all other nodes on the network (except for itself) is ready to go to "bus-sleep mode". Some implementations will also make use of the API call `<Bus>Nm_CheckRemoteSleepIndication`.

Note: A **bus specific NM** which is included in a coordination cluster must monitor its bus to identify when all other nodes on the network is ready to go to sleep. When this occurs, the **bus specific NM** shall call the callback `Nm_RemoteSleepIndication` of **Nm**. (See [SWS_Nm_00192]).

Note: After a **bus specific NM** which is included in a coordination cluster has signaled to **Nm** that all other nodes on the network is ready to go to sleep (See [SWS_Nm_00192]), it must continue monitoring its bus to identify if any node starts requesting the network again, implying that the bus is no longer ready to go to sleep. When this occurs, the **bus specific NM** shall call the callback `Nm_RemoteSleepCancellation` of **Nm**. (See [SWS_Nm_00193]).

Note: The Remote Sleep Indication and Cancellation functionality is further specified in the respective bus specific NM.

Rationale: The `Nm_SynchronizationPoint` shall be called by the **bus specific NM** in order to inform the `coordination algorithm` of a suitable point in time to initiate the `coordinated shutdown`. For cyclic networks this is typically at cycle boundaries. For non-cyclic networks this must be defined by other means. Each *NM Coordination Cluster* can be configured to make use of synchronization indications or not (See [SWS_Nm_00172]), and if they are used, the coordination algorithm filters indications and only acts on indications from networks that are configured as synchronizing networks.

Note: Please note for implementation of `<bus>Nm`: Cyclic networks invoke the `Nm_SynchronizationPoint` repeatedly when no other nodes request the network. The invocation is typically made at boundaries in the **bus specific NM** protocol when changes in the **NM** voting will occur.

It is assumed that any call to `<Bus>Nm_ReleaseNetwork` made between two of these `Nm_SynchronizationPoint` will be acted upon at the same point in time as the next `Nm_SynchronizationPoint` would have been invoked.

Rationale: The synchronization indication shall start when `Nm_RemoteSleepIndication` has been notified and continue until either the network has been released (`<Bus>Nm_NetworkRelease`) or the `Nm_RemoteSleepCancellation` is called.

Note: For the use case of coordinating Flexray-channel A + B if there is no other Network inside the **NM Cluster**, hence, if an **NM Coordinator** contains only one **NM Channel**, the `NmActiveCoordinator` for this `NmChannelConfig` needs to be set to `TRUE` and the `NmChannelSleepMaster` needs to be set to `FALSE` to allow the channel to coordinate itself. Note: The Value of "`NmSynchronizingNetwork`" is only relevant if this network is in the same coordination cluster with other networks.

7.5.3 Prerequisites of Partial Network functionality

7.5.3.1 Prerequisite for aggregation of PNC requests

The aggregation of PNC requests, requires that the following callback function of the Nm can be invoked by the bus specific NM:

- [Nm_PncBitVectorRxIndication](#)
- [Nm_PncBitVectorTxIndication](#)

The aggregation of PNC requests functionality provides the following API, to be called by the ComM:

- [Nm_UpdateIRA](#)

7.5.3.2 Prerequisites for synchronized PNC shutdown functionality

The synchronized PNC shutdown functionality makes use of the following interface of the bus specific NM:

- [<Bus>Nm_RequestSynchronizedPncShutdown](#) - [\[SWS_Nm_00166\]](#)[\[SWS_Nm_00521\]](#)

The synchronized PNC shutdown functionality requires that the following callback of the Nm can be invoked by the bus specific NM:

- [Nm_ForwardSynchronizedPncShutdown](#) - [\[SWS_Nm_91007\]](#)

The synchronized PNC shutdown functionality provides the following API, to be called by the ComM:

- [Nm_RequestSynchronizedPncShutdown](#) - [\[SWS_Nm_91005\]](#)

7.5.4 Configuration of global parameters for bus specific networks

The **Nm**'s configuration contains parameters that regulate support of optional features found in the **bus specific NMs**. Since **Nm** is only a pass-through interface layer regarding features that are not used by the *NM Coordinator functionality*, enabling these in **Nm**'s configuration will in many cases only enable the pass-through of the controlling API functions and the callback indications from the bus specific layers.

Many of the parameters defined for NM are used only as a source for global configuration of all bus specific NM modules. Corresponding parameters of the bus specific NMs are derived from these parameters.

7.6 NM_BUSNM_LOCALNM

[SWS_Nm_00483] [If BusNmType is [NM_BUSNM_LOCALNM](#) and **ComM** requests [Nm_PassiveStartUp](#) or [Nm_NetworkRequest](#) then **Nm** shall inform **ComM** about start of network by calling `ComM_Nm_NetworkMode`.

Rationale : Buses of type [NM_BUSNM_LOCALNM](#) which are coordinated do not have a network management message but are synchronized e.g. by a master - slave concept like LIN). These Bus-Types are always directly started on request by **ComM** but the shutdown will be done by coordinator algorithm.]()

7.7 Multicore Distribution

In its role as central module dealing with different network types the Nm interaction spans across partitions in case the Com-Stack is distributed and so shall provide required multi-core features to ensure a clean architecture and keep the network dependent clusters free of multi-partition (multi-core) addons.

[SWS_Nm_00484] [The Nm module shall apply appropriate mechanisms to allow calls of its APIs from other partitions than its main function, e.g. by providing a Nm satellite.] ([SRS_BSW_00459](#))

[SWS_Nm_00485] [Nm shall interact with <Bus>Nm (i.e. call <Bus>Nm APIs) only in the partition, where the respective <Bus>Nm module is assigned to.] ([SRS_BSW_00459](#))

[SWS_Nm_00486] [The Nm kernel shall be assigned to the same partition as ComM kernel in order to keep the interaction between these two modules on an intra-partition basis.] ([SRS_BSW_00459](#))

Note: Even though the basic software (and the Com-Stack in particular) is distributed across several partitions, ComM [10] and Nm Masters should reside in the same partition in order to keep mode interfaces between the two modules simple (for further information see chapter Master/Satellite-approach in [11, Guide to BSW Distribution]).

7.8 Additional Functionality

7.8.1 Nm_CarWakeUpIndication

[SWS_Nm_00252] [If the <bus>Nm calls [Nm_CarWakeUpIndication](#) and [NmCarWakeUpCallout](#) is defined, the NM Interface shall call the callout function defined by [NmCarWakeUpCallout](#) with `nmNetworkHandle` as parameter.] ([RS_Nm_02503](#))

[SWS_Nm_00285] [If the <bus>Nm calls [Nm_CarWakeUpIndication](#) and [NmCarWakeUpCallout](#) is not defined, the NM Interface shall call the function

BswM_Nm_CarWakeUpIndication with nmNetworkHandle as parameter.](RS_Nm_02503)

Note: The application, called by NmCarWakeUpCallout, is responsible to manage the Car Wake Up (CWU) request and distribute the Request to other Nm channels by setting the CWU bit in its own Nm message. This application drops the CWU request if the request is not repeated within a specific time.

Note: The callout is declared as specified within SWS_BSW_00039 and SWS_BSW_00135.

7.8.2 Nm_StateChangeNotification

[SWS_Nm_00249] [If NmStateReportEnabled is set to **TRUE** and NmStateReportSignalRef is configured, when one of the state transitions mentioned in [SWS_Nm_00509] occur, Nm_StateChangeNotification shall call Com_SendSignal(uint8, Com_SignalIdType, const void*) for the signal referenced by NmStateReportSignalRef with the value according to [SWS_Nm_00509].](RS_Nm_00051)

Note: The transmitted signal has to be at least a 6 bit signal in Com that should be part of the NM message.

[SWS_Nm_00487] [When Nm_StateChangeNotification is called to report a change of the Nm state, Nm shall call BswM_Nm_StateChangeNotification() with the reported current state.](RS_Nm_00051)

[SWS_Nm_00509] Definition of network management states in Nm module [

Bit	Value	Name	Description
0	1	NM_RM_BSM	NM in state RepeatMessage (transition from BusSleepMode)
1	2	NM_RM_PBSM	NM in state RepeatMessage (transition from PrepareBusSleepMode)
2	4	NM_NO_RM	NM in state NormalOperation (transition from RepeatMessage)
3	8	NM_NO_RS	NM in state NormalOperation (transition from ReadySleep)
4	16	NM_RM_RS	NM in state RepeatMessage (transition from ReadySleep)
5	32	NM_RM_NO	NM in state RepeatMessage (transition from NormalOperation)

Table 7.4: Network Management States

](RS_Nm_00051)

[SWS_Nm_00501] [If `NmDynamicPncToChannelMappingEnabled` is set to `TRUE` and `Nm_StateChangeNotification` is called, then `ComM_Nm_RepeatMessageLeftIndication()` shall be called when `nmPreviousState` is set to `NM_STATE_REPEAT_MESSAGE` and `nmCurrentState` is different from `NM_STATE_REPEAT_MESSAGE`.]()

7.9 Error classification

Section 7.2 "Error Handling" of the document [2, SWS_BSW General] describes the error handling of the Basic Software in detail. Above all, it constitutes a classification scheme consisting of five error types which may occur in BSW modules.

Based on this foundation, the following section specifies particular errors arranged in the respective subsections below.

7.9.1 Development Errors

[SWS_Nm_00232] Definiton of development errors in module Nm [

Type of error	Related error code	Error value
API service used without Nm interface initialization	NM_E_UNINIT	0x00
API Service called with wrong parameter but not with NULL-pointer	NM_E_INVALID_CHANNEL	0x01
API service called with a NULL pointer	NM_E_PARAM_POINTER	0x02

] ([SRS_BSW_00327](#), [SRS_BSW_00337](#), [SRS_BSW_00385](#), [SRS_BSW_00386](#))

7.9.2 Runtime Errors

[SWS_Nm_91011] Definiton of runtime errors in module Nm [

Type of error	Related error code	Error value
Retransmission timer for a PN shutdown message has expired, because a PN shutdown message could not be transmitted on the network within the configured duration of re-transmission.	NM_E_TRANSMISSION_OF_PN_SHUTDOWN_MESSAGE_FAILED	0x10

]()

7.9.3 Transient Faults

There are no transient faults.

7.9.4 Production Errors

There are no production errors.

7.9.5 Extended Production Errors

There are no extended production errors.

8 API specification

8.1 Imported types

In this chapter all types included from the following modules are listed.

[SWS_Nm_00117] Definition of imported datatypes of module Nm [

Module	Header File	Imported Type
Com	Com.h	Com_SignalIdType
ComStack_Types	ComStack_Types.h	NetworkHandleType
	ComStack_Types.h	PNCHandleType
Std	Std_Types.h	Std_ReturnType
	Std_Types.h	Std_VersionInfoType

]([SRS_BSW_00301](#))

8.2 Type definitions

8.2.1 Nm_ModeType

[SWS_Nm_00274] Definition of datatype Nm_ModeType [

Name	Nm_ModeType		
Kind	Enumeration		
Range	NM_MODE_BUS_SLEEP	–	Bus-Sleep Mode
	NM_MODE_PREPARE_BUS_SLEEP	–	Prepare-Bus Sleep Mode
	NM_MODE_SYNCHRONIZE	–	Synchronize Mode
	NM_MODE_NETWORK	–	Network Mode
Description	Operational modes of the network management.		
Available via	NmStack_types.h		

]([RS_Nm_00044](#))

8.2.2 Nm_StateType

[SWS_Nm_00275] Definition of datatype Nm_StateType [

Name	Nm_StateType		
Kind	Enumeration		
Range	NM_STATE_UNINIT	0x00	Uninitialized State
	NM_STATE_BUS_SLEEP	0x01	Bus-Sleep State



△

	NM_STATE_PREPARE_BUS_SLEEP	0x02	Prepare-Bus State
	NM_STATE_READY_SLEEP	0x03	Ready Sleep State
	NM_STATE_NORMAL_OPERATION	0x04	Normal Operation State
	NM_STATE_REPEAT_MESSAGE	0x05	Repeat Message State
	NM_STATE_SYNCHRONIZE	0x06	Synchronize State
	NM_STATE_OFFLINE	0x07	Offline State
Description	States of the network management state machine.		
Available via	NmStack_types.h		

|(RS_Nm_00050)

8.2.3 Nm_BusNmType

[SWS_Nm_00276] Definition of datatype Nm_BusNmType [

Name	Nm_BusNmType		
Kind	Enumeration		
Range	NM_BUSNM_CANNM	–	CAN NM type
	NM_BUSNM_FRNM	–	FR NM type
	NM_BUSNM_UDPNM	–	UDP NM type
	NM_BUSNM_GENERICNM	–	Generic NM type
	NM_BUSNM_UNDEF	–	NM type undefined; it shall be defined as FFh
	NM_BUSNM_J1939NM	–	SAE J1939 NM type (address claiming)
	NM_BUSNM_LOCALNM	–	Local NM Type
Description	BusNm Type		
Available via	NmStack_types.h		

|(RS_Nm_00044, RS_Nm_00154, RS_Nm_02515)

8.2.4 Nm_ConfigType

[SWS_Nm_00282] Definition of datatype Nm_ConfigType [

Name	Nm_ConfigType		
Kind	Structure		
Elements	implementation specific		
	Type	–	
	Comment	–	
Description	Configuration data structure of the Nm module.		
Available via	Nm.h		

|(SRS_BSW_00414)

8.3 Function definitions

8.3.1 Standard services provided by NM Interface

8.3.1.1 Nm_Init

[SWS_Nm_00030] Definition of API function Nm_Init [

Service Name	Nm_Init	
Syntax	<pre>void Nm_Init (const Nm_ConfigType* ConfigPtr)</pre>	
Service ID [hex]	0x00	
Sync/Async	Synchronous	
Reentrancy	Non Reentrant	
Parameters (in)	ConfigPtr	Pointer to the selected configuration set.
Parameters (inout)	None	
Parameters (out)	None	
Return value	None	
Description	Initializes the NM Interface.	
Available via	Nm.h	

]([SRS_BSW_00101](#), [SRS_BSW_00344](#), [SRS_BSW_00358](#), [SRS_BSW_00405](#), [SRS_BSW_00414](#))

Note: Caveats of `Nm_Init`: This service function has to be called after the initialization of the respective bus interface.

[SWS_Nm_00283] [The Configuration pointer **ConfigPtr** shall always have a `NULL_PTR` value.]([SRS_BSW_00414](#))

Note: The Configuration pointer **ConfigPtr** is currently not used and shall therefore be set `NULL_PTR` value.

8.3.1.2 Nm_PassiveStartUp

[SWS_Nm_00031] Definition of API function Nm_PassiveStartUp [

Service Name	Nm_PassiveStartUp	
Syntax	<pre>Std_ReturnType Nm_PassiveStartUp (NetworkHandleType NetworkHandle)</pre>	
Service ID [hex]	0x01	
Sync/Async	Asynchronous	
Reentrancy	Non-reentrant for the same NetworkHandle, reentrant otherwise	
Parameters (in)	NetworkHandle	Identification of the NM-channel
Parameters (inout)	None	





Parameters (out)	None	
Return value	Std_ReturnType	E_OK: No error E_NOT_OK: Passive start of network management has failed NetworkHandle does not exist (development only) Module not yet initialized (development only)
Description	This function calls the <Bus>Nm_PassiveStartUp function in case NmBusType is not set to NM_BUSNM_LOCALNM (e.g. CanNm_PassiveStartUp function is called for NM_BUSNM_CANNM).	
Available via	Nm.h	

]([RS_Nm_00046](#), [RS_Nm_00051](#), [RS_Nm_00151](#), [RS_Nm_02513](#), [RS_Nm_02536](#))

Note: Caveats of [Nm_PassiveStartUp](#): The <Bus>Nm and the Nm itself are initialized correctly.

[SWS_Nm_00488] [If the pre-processor switch [NmDevErrorDetect](#) is set to TRUE, the function [Nm_PassiveStartUp](#) shall raise the error [NM_E_INVALID_CHANNEL](#) if the parameter [NetworkHandle](#) is not a configured network handle.]([SRS_BSW_00323](#), [SRS_BSW_00369](#), [SRS_BSW_00386](#))

8.3.1.3 Nm_NetworkRequest

[SWS_Nm_00032] Definition of API function Nm_NetworkRequest [

Service Name	Nm_NetworkRequest	
Syntax	Std_ReturnType Nm_NetworkRequest (NetworkHandleType NetworkHandle)	
Service ID [hex]	0x02	
Sync/Async	Asynchronous	
Reentrancy	Non-reentrant for the same NetworkHandle, reentrant otherwise	
Parameters (in)	NetworkHandle	Identification of the NM-channel
Parameters (inout)	None	
Parameters (out)	None	
Return value	Std_ReturnType	E_OK: No error E_NOT_OK: Requesting of bus communication has failed NetworkHandle does not exist (development only) Module not yet initialized (development only)
Description	This function calls the <Bus>Nm_NetworkRequest (e.g. CanNm_NetworkRequest function is called if channel is configured as CAN) function in case NmBusType is not set to NM_BUSNM_LOCALNM.	
Available via	Nm.h	

]([RS_Nm_00046](#), [RS_Nm_00047](#), [RS_Nm_00051](#), [RS_Nm_02513](#), [RS_Nm_00151](#))

Note: Caveats of [Nm_NetworkRequest](#): The <Bus>Nm and the Nm itself are initialized correctly.

[SWS_Nm_00130] [If [Nm_NetworkRequest](#) is called with a network handle where [NmPassiveModeEnabled](#) is set to TRUE it shall not execute any functionality and

return with **E_NOT_OK**. If `NmDevErrorDetect` is set to `TRUE` then it shall raise the error `NM_E_INVALID_CHANNEL` in this case. `()`

[SWS_Nm_00489] [If the pre-processor switch `NmDevErrorDetect` is set to `TRUE`, the function `Nm_NetworkRequest` shall raise the error `NM_E_INVALID_CHANNEL` if the parameter `NetworkHandle` is not a configured network handle.] ([SRS_BSW_00323](#), [SRS_BSW_00369](#), [SRS_BSW_00386](#))

8.3.1.4 Nm_NetworkRelease

[SWS_Nm_00046] Definition of API function Nm_NetworkRelease [

Service Name	Nm_NetworkRelease	
Syntax	Std_ReturnType Nm_NetworkRelease (NetworkHandleType NetworkHandle)	
Service ID [hex]	0x03	
Sync/Async	Asynchronous	
Reentrancy	Non-reentrant for the same NetworkHandle, reentrant otherwise	
Parameters (in)	NetworkHandle	Identification of the NM-channel
Parameters (inout)	None	
Parameters (out)	None	
Return value	Std_ReturnType	E_OK: No error E_NOT_OK: Releasing of bus communication has failed NetworkHandle does not exist (development only) Module not yet initialized (development only)
Description	This function calls the <Bus>Nm_NetworkRelease bus specific function in case NmBusType is not set to NM_BUSNM_LOCALNM (e.g. CanNm_NetworkRelease function is called if channel is configured as CAN).	
Available via	Nm.h	

] ([RS_Nm_00047](#), [RS_Nm_00048](#), [RS_Nm_00051](#))

Note: Caveats of `Nm_NetworkRelease`: The **<Bus>Nm** and the **Nm** itself are initialized correctly.

[SWS_Nm_00132] [If `Nm_NetworkRelease` is called with a network handle where `NmPassiveModeEnabled` is set to `TRUE` it shall not execute any functionality and return with **E_NOT_OK**. If `NmDevErrorDetect` is set to `TRUE` then it shall raise the error `NM_E_INVALID_CHANNEL` in this case.] `()`

[SWS_Nm_00490] [If the pre-processor switch `NmDevErrorDetect` is set to `TRUE`, the function `Nm_NetworkRelease` shall raise the error `NM_E_INVALID_CHANNEL` if the parameter `NetworkHandle` is not a configured network handle.] ([SRS_BSW_00323](#), [SRS_BSW_00369](#), [SRS_BSW_00386](#))

8.3.2 Communication control services provided by NM Interface

The following services are provided by NM Interface to allow the Diagnostic Communication Manager (DCM) to control the transmission of NM Messages.

Note: To run the [coordination algorithm](#) correctly, it has to be ensured that NM PDU transmission ability is enabled before the ECU is shut down. If `<Bus>Nm_NetworkRelease` is called while NM PDU transmission ability is disabled, the ECU will shut down after NM PDU transmission ability has been re-enabled again. Therefore the ECU can also shut down in case of race conditions (e.g. diagnostic session left shortly before enabling communication) or a wrong usage of communication control.

8.3.2.1 Nm_DisableCommunication

[SWS_Nm_00033] Definition of API function Nm_DisableCommunication [

Service Name	Nm_DisableCommunication	
Syntax	Std_ReturnType Nm_DisableCommunication (NetworkHandleType NetworkHandle)	
Service ID [hex]	0x04	
Sync/Async	Asynchronous	
Reentrancy	Non-reentrant for the same NetworkHandle, reentrant otherwise	
Parameters (in)	NetworkHandle	Identification of the NM-channel
Parameters (inout)	None	
Parameters (out)	None	
Return value	Std_ReturnType	E_OK: No error E_NOT_OK: Disabling of NM PDU transmission ability has failed. NetworkHandle does not exist (development only) Module not yet initialized (development only)
Description	Disables the NM PDU transmission ability. For that purpose <code><Bus>Nm_DisableCommunication</code> shall be called in case <code>NmBusType</code> is not set to <code>NM_BUSNM_LOCALNM</code> (e.g. <code>CanNm_DisableCommunication</code> function is called if channel is configured as CAN).	
Available via	Nm.h	

]([RS_Nm_02513](#), [RS_Nm_02512](#))

Note: Caveats of `Nm_DisableCommunication`: The `<Bus>Nm` and the `Nm` itself are initialized correctly.

[SWS_Nm_00134] [Configuration of `Nm_DisableCommunication`: This function is only available if `NmComControlEnabled` is set to `TRUE`.]([RS_Nm_00150](#))

[SWS_Nm_00286] [If `Nm_DisableCommunication` is called with a network handle where `NmPassiveModeEnabled` is set to `TRUE` it shall not execute any functionality and return with `E_NOT_OK`. If `NmDevErrorDetect` is set to `TRUE` then it shall raise the error `NM_E_INVALID_CHANNEL` in this case.]([/](#))

[SWS_Nm_00491] [If the pre-processor switch `NmDevErrorDetect` is set to `TRUE`, the function `Nm_DisableCommunication` shall raise the error `NM_E_INVALID_CHANNEL` if the parameter `NetworkHandle` is not a configured network handle.] ([SRS_BSW_00323](#), [SRS_BSW_00369](#), [SRS_BSW_00386](#))

8.3.2.2 Nm_EnableCommunication

[SWS_Nm_00034] Definition of API function `Nm_EnableCommunication` [

Service Name	Nm_EnableCommunication	
Syntax	Std_ReturnType Nm_EnableCommunication (NetworkHandleType NetworkHandle)	
Service ID [hex]	0x05	
Sync/Async	Asynchronous	
Reentrancy	Non-reentrant for the same NetworkHandle, reentrant otherwise	
Parameters (in)	NetworkHandle	Identification of the NM-channel
Parameters (inout)	None	
Parameters (out)	None	
Return value	Std_ReturnType	E_OK: No error E_NOT_OK: Enabling of NM PDU transmission ability has failed. NetworkHandle does not exist (development only) Module not yet initialized (development only)
Description	Enables the NM PDU transmission ability. For that purpose <code><Bus>Nm_EnableCommunication</code> shall be called in case <code>NmBusType</code> is not set to <code>NM_BUSNM_LOCALNM</code> . (e.g. <code>CanNm_EnableCommunication</code> function is called if channel is configured as CAN).	
Available via	Nm.h	

] ([RS_Nm_02512](#))

Note: Caveats of `Nm_EnableCommunication`: The `<Bus>Nm` and the `Nm` itself are initialized correctly.

[SWS_Nm_00136] [Configuration of `Nm_EnableCommunication`: This function is only available if `NmComControlEnabled` is set to `TRUE`.] ([RS_Nm_00150](#))

[SWS_Nm_00287] [If `Nm_EnableCommunication` is called with a network handle where `NmPassiveModeEnabled` is set to `TRUE` it shall not execute any functionality and return with `E_NOT_OK`. If `NmDevErrorDetect` is set to `TRUE` then it shall raise the error `NM_E_INVALID_CHANNEL` in this case.] ()

[SWS_Nm_00492] [If the pre-processor switch `NmDevErrorDetect` is set to `TRUE`, the function `Nm_EnableCommunication` shall raise the error `NM_E_INVALID_CHANNEL` if the parameter `NetworkHandle` is not a configured network handle.] ([SRS_BSW_00323](#), [SRS_BSW_00369](#), [SRS_BSW_00386](#))

8.3.3 Partial Network services provided by NM Interface

8.3.3.1 Nm_RequestSynchronizedPncShutdown

[SWS_Nm_91005] Definition of API function Nm_RequestSynchronizedPncShutdown [

Service Name	Nm_RequestSynchronizedPncShutdown	
Syntax	<pre>Std_ReturnType Nm_RequestSynchronizedPncShutdown (NetworkHandleType NetworkHandle, PNCHandleType PncId)</pre>	
Service ID [hex]	0x24	
Sync/Async	Synchronous	
Reentrancy	Non Reentrant for the same NetworkHandle, reentrant otherwise	
Parameters (in)	NetworkHandle	Identification of the NM-channel
	PncId	Identification of the Pnc which is requested for a synchronized shutdown across the PNC network topology
Parameters (inout)	None	
Parameters (out)	None	
Return value	Std_ReturnType	E_OK: No error E_NOT_OK: Request for a synchronized PNC shutdown has failed, e.g. NetworkHandle does not exist (development only) Module not yet initialized (development only)
Description	This function store the request for a synchronized PNC shutdown of a particular PNC given by PncId per given NM-Channel. The handling of the synchronized PNC shutdown process is mainly done in the context of the Nm_Mainfunction. The function call is only valid if NmStandardBusType is not set to NM_BUSNM_LOCALNM as a <Bus>Nm like CanNm is needed to transmit the PNC shutdown requests.	
Available via	Nm.h	

]([RS_Nm_02572](#), [RS_Nm_02571](#))

[SWS_Nm_00508] [If the pre-processor switch `NmDevErrorDetect` is set to `TRUE`, the function `Nm_RequestSynchronizedPncShutdown` shall raise the error `NM_E_INVALID_CHANNEL` if the parameter `NetworkHandle` is not a configured network handle.]([SRS_BSW_00323](#), [SRS_BSW_00369](#), [SRS_BSW_00386](#))

8.3.3.2 Nm_UpdateIRA

[SWS_Nm_91007] Definition of callback function Nm_UpdateIRA [

Service Name	Nm_UpdateIRA	
Syntax	<pre>void Nm_UpdateIRA (NetworkHandleType NetworkHandle, const uint8* PncBitVectorPtr)</pre>	
Service ID [hex]	0x26	
Sync/Async	Synchronous	





Reentrancy	Non Reentrant for the same NetworkHandle, reentrant otherwise	
Parameters (in)	NetworkHandle	Identification of the NM-channel
	PncBitVectorPtr	Pointer to the bit vector with all PNC bits set to "1" of internal requested PNCs (IRA)
Parameters (inout)	None	
Parameters (out)	None	
Return value	None	
Description	Indication by ComM of internal PNC requests. This is used to aggregate the internal PNC requests.	
Available via	Nm.h	

|(RS_Nm_02544)

8.3.4 Extra services provided by NM Interface

The following services are provided by NM Interface for OEM specific extensions of the NM stack and are not required by any AUTOSAR module.

8.3.4.1 Nm_SetUserData

[SWS_Nm_00035] Definition of API function Nm_SetUserData [

Service Name	Nm_SetUserData	
Syntax	<pre>Std_ReturnType Nm_SetUserData (NetworkHandleType NetworkHandle, const uint8* nmUserDataPtr)</pre>	
Service ID [hex]	0x06	
Sync/Async	Synchronous	
Reentrancy	Non-reentrant for the same NetworkHandle, reentrant otherwise	
Parameters (in)	NetworkHandle	Identification of the NM-channel
	nmUserDataPtr	User data for the next transmitted NM message
Parameters (inout)	None	
Parameters (out)	None	
Return value	Std_ReturnType	E_OK: No error E_NOT_OK: Setting of user data has failed NetworkHandle does not exist (development only) Module not yet initialized (development only)
Description	Set user data for NM messages transmitted next on the bus. For that purpose <Bus>Nm_SetUserData shall be called in case NmBusType is not set to NM_BUSNM_LOCALNM. (e.g. Can Nm_SetUserData function is called if channel is configured as CAN).	
Available via	Nm.h	

|(RS_Nm_02503)

Note: Caveats of Nm_SetUserData: The <Bus>Nm and the Nm itself are initialized correctly.

[SWS_Nm_00138] [Configuration of `Nm_SetUserData`: This function is only available if `NmUserDataEnabled` is set to `TRUE`.] ([RS_Nm_00150](#))

[SWS_Nm_00288] [If `Nm_SetUserData` is called with a network handle where `NmPassiveModeEnabled` is set to `TRUE` it shall not execute any functionality and return with `E_NOT_OK`. If `NmDevErrorDetect` is set to `TRUE` then it shall raise the error `NM_E_INVALID_CHANNEL` in this case.] ()

[SWS_Nm_00241] [Configuration of `Nm_SetUserData`: If `NmComUserDataSupport` is `TRUE` the API `Nm_SetUserData` shall not be available.] ([RS_Nm_00150](#))

[SWS_Nm_00493] [If the pre-processor switch `NmDevErrorDetect` is set to `TRUE`, the function `Nm_SetUserData` shall raise the error `NM_E_INVALID_CHANNEL` if the parameter `NetworkHandle` is not a configured network handle.] ([SRS_BSW_00323](#), [SRS_BSW_00369](#), [SRS_BSW_00386](#))

8.3.4.2 Nm_GetUserData

[SWS_Nm_00036] Definition of API function `Nm_GetUserData` [

Service Name	Nm_GetUserData	
Syntax	<pre>Std_ReturnType Nm_GetUserData (NetworkHandleType NetworkHandle, uint8* nmUserDataPtr)</pre>	
Service ID [hex]	0x07	
Sync/Async	Synchronous	
Reentrancy	Reentrant	
Parameters (in)	NetworkHandle	Identification of the NM-channel
Parameters (inout)	None	
Parameters (out)	nmUserDataPtr	Pointer where user data out of the last successfully received NM message shall be copied to
Return value	Std_ReturnType	<code>E_OK</code> : No error <code>E_NOT_OK</code> : Getting of user data has failed NetworkHandle does not exist (development only) Module not yet initialized (development only)
Description	Get user data out of the last successfully received NM message. For that purpose <code><Bus>Nm_GetUserData</code> shall be called in case <code>NmBusType</code> is not set to <code>NM_BUSNM_LOCALNM</code> . (e.g. <code>CanNm_GetUserData</code> function is called if channel is configured as CAN).	
Available via	Nm.h	

] ([RS_Nm_02504](#))

Note: Caveats of `Nm_GetUserData`: The `<Bus>Nm` and the `Nm` itself are initialized correctly.

[SWS_Nm_00140] [Configuration of `Nm_GetUserData`: This function is only available if `NmUserDataEnabled` is set to `TRUE`.] ([RS_Nm_00150](#))

[SWS_Nm_00494] [If the pre-processor switch `NmDevErrorDetect` is set to `TRUE`, the function `Nm_GetUserData` shall raise the error `NM_E_INVALID_CHANNEL` if the

parameter `NetworkHandle` is not a configured network handle.] ([SRS_BSW_00323](#), [SRS_BSW_00369](#), [SRS_BSW_00386](#))

8.3.4.3 Nm_GetPduData

[SWS_Nm_00037] Definition of API function Nm_GetPduData [

Service Name	Nm_GetPduData	
Syntax	Std_ReturnType Nm_GetPduData (NetworkHandleType NetworkHandle, uint8* nmPduData)	
Service ID [hex]	0x08	
Sync/Async	Synchronous	
Reentrancy	Reentrant	
Parameters (in)	NetworkHandle	Identification of the NM-channel
Parameters (inout)	None	
Parameters (out)	nmPduData	Pointer where NM PDU shall be copied to.
Return value	Std_ReturnType	E_OK: No error E_NOT_OK: Getting of NM PDU data has failed NetworkHandle does not exist (development only) Module not yet initialized (development only)
Description	Get the whole PDU data out of the most recently received NM message. For that purpose <Bus Nm>_GetPduData shall be called in case NmBusType is not set to NM_BUSNM_LOCALNM. (e.g. CanNm_GetPduData function is called if channel is configured as CAN).	
Available via	Nm.h	

]()

Note: Caveats of `Nm_GetPduData`: The `<Bus>Nm` and the `Nm` itself are initialized correctly.

[SWS_Nm_00495] [If the pre-processor switch `NmDevErrorDetect` is set to `TRUE`, the function `Nm_GetPduData` shall raise the error `NM_E_INVALID_CHANNEL` if the parameter `NetworkHandle` is not a configured network handle.] ([SRS_BSW_00323](#), [SRS_BSW_00369](#), [SRS_BSW_00386](#))

8.3.4.4 Nm_RepeatMessageRequest

[SWS_Nm_00038] Definition of API function Nm_RepeatMessageRequest [

Service Name	Nm_RepeatMessageRequest	
Syntax	Std_ReturnType Nm_RepeatMessageRequest (NetworkHandleType NetworkHandle)	
Service ID [hex]	0x09	
Sync/Async	Asynchronous	





Reentrancy	Non-reentrant for the same NetworkHandle, reentrant otherwise	
Parameters (in)	NetworkHandle	Identification of the NM-channel
Parameters (inout)	None	
Parameters (out)	None	
Return value	Std_ReturnType	E_OK: No error E_NOT_OK: Setting of Repeat Message Request Bit has failed NetworkHandle does not exist (development only) Module not yet initialized (development only)
Description	Set Repeat Message Request Bit for NM messages transmitted next on the bus. For that purpose <Bus>Nm_RepeatMessageRequest shall be called in case NmBusType is not set to NM_BUSNM_LOCALNM. (e.g. CanNm_RepeatMessageRequest function is called if channel is configured as CAN). This will force all nodes on the bus to transmit NM messages so that they can be identified.	
Available via	Nm.h	

](RS_Nm_00153)

Note: Caveats of Nm_RepeatMessageRequest: The <Bus>Nm and the Nm itself are initialized correctly.

[SWS_Nm_00289] [If Nm_RepeatMessageRequest is called with a network handle where NmPassiveModeEnabled is set to TRUE it shall not execute any functionality and return with E_NOT_OK. If NmDevErrorDetect is set to TRUE then it shall raise the error NM_E_INVALID_CHANNEL in this case.]()

[SWS_Nm_00496] [If the pre-processor switch NmDevErrorDetect is set to TRUE, the function Nm_RepeatMessageRequest shall raise the error NM_E_INVALID_CHANNEL if the parameter NetworkHandle is not a configured network handle.] (SRS_BSW_00323, SRS_BSW_00369, SRS_BSW_00386)

8.3.4.5 Nm_GetNodeIdentifier

[SWS_Nm_00039] Definition of API function Nm_GetNodeIdentifier [

Service Name	Nm_GetNodeIdentifier	
Syntax	<pre>Std_ReturnType Nm_GetNodeIdentifier (NetworkHandleType NetworkHandle, uint8* nmNodeIdPtr)</pre>	
Service ID [hex]	0x0a	
Sync/Async	Synchronous	
Reentrancy	Non-reentrant for the same NetworkHandle, reentrant otherwise	
Parameters (in)	NetworkHandle	Identification of the NM-channel
Parameters (inout)	None	
Parameters (out)	nmNodeIdPtr	Pointer where node identifier out of the last successfully received NM-message shall be copied to





Return value	Std_ReturnType	E_OK: No error E_NOT_OK: Getting of the node identifier out of the last received NM-message has failed NetworkHandle does not exist (development only) Module not yet initialized (development only)
Description	Get node identifier out of the last successfully received NM-message. The function <Bus>Nm_GetNodeIdentifier shall be called in case NmBusType is not set to NM_BUSNM_LOCALNM. (e.g. CanNm_GetNodeIdentifier function is called if channel is configured as CAN).	
Available via	Nm.h	

](RS_Nm_02506)

Note: Caveats of Nm_GetNodeIdentifier: The <Bus>Nm and the Nm itself are initialized correctly.

[SWS_Nm_00497] [If the pre-processor switch NmDevErrorDetect is set to TRUE, the function Nm_GetNodeIdentifier shall raise the error NM_E_INVALID_CHANNEL if the parameter NetworkHandle is not a configured network handle.](SRS_BSW_00323, SRS_BSW_00369, SRS_BSW_00386)

8.3.4.6 Nm_GetLocalNodeIdentifier

[SWS_Nm_00040] Definition of API function Nm_GetLocalNodeIdentifier [

Service Name	Nm_GetLocalNodeIdentifier	
Syntax	Std_ReturnType Nm_GetLocalNodeIdentifier (NetworkHandleType NetworkHandle, uint8* nmNodeIdPtr)	
Service ID [hex]	0x0b	
Sync/Async	Synchronous	
Reentrancy	Non-reentrant for the same NetworkHandle, reentrant otherwise	
Parameters (in)	NetworkHandle	Identification of the NM-channel
Parameters (inout)	None	
Parameters (out)	nmNodeIdPtr	Pointer where node identifier of the local node shall be copied to
Return value	Std_ReturnType	E_OK: No error E_NOT_OK: Getting of the node identifier of the local node has failed NetworkHandle does not exist (development only) Module not yet initialized (development only)
Description	Get node identifier configured for the local node. For that purpose <Bus>Nm_GetLocalNodeIdentifier shall be called in case NmBusType is not set to NM_BUSNM_LOCALNM. (e.g. CanNm_GetLocalNodeIdentifier function is called if channel is configured as CAN).	
Available via	Nm.h	

](RS_Nm_02508)

Note: Caveats of Nm_GetLocalNodeIdentifier: The <Bus>Nm and the Nm itself are initialized correctly.

[SWS_Nm_00498] [If the pre-processor switch `NmDevErrorDetect` is set to `TRUE`, the function `Nm_GetLocalNodeIdentifier` shall raise the error `NM_E_INVALID_CHANNEL` if the parameter `NetworkHandle` is not a configured network handle.] ([SRS_BSW_00323](#), [SRS_BSW_00369](#), [SRS_BSW_00386](#))

8.3.4.7 Nm_CheckRemoteSleepIndication

[SWS_Nm_00042] Definition of API function `Nm_CheckRemoteSleepIndication` [

Service Name	Nm_CheckRemoteSleepIndication	
Syntax	<pre>Std_ReturnType Nm_CheckRemoteSleepIndication (NetworkHandleType nmNetworkHandle, boolean* nmRemoteSleepIndPtr)</pre>	
Service ID [hex]	0x0d	
Sync/Async	Synchronous	
Reentrancy	Non-reentrant for the same NetworkHandle, reentrant otherwise	
Parameters (in)	nmNetworkHandle	Identification of the NM-channel
Parameters (inout)	None	
Parameters (out)	nmRemoteSleepIndPtr	Pointer where check result of remote sleep indication shall be copied to
Return value	Std_ReturnType	E_OK: No error E_NOT_OK: Checking of remote sleep indication bits has failed NetworkHandle does not exist (development only) Module not yet initialized (development only)
Description	Check if remote sleep indication takes place or not. For that purpose <code><Bus>Nm_CheckRemoteSleepIndication</code> shall be called in case <code>NmBusType</code> is not set to <code>NM_BUSNM_LOCALNM</code> . (e.g. <code>CanNm_CheckRemoteSleepIndication</code> function is called if channel is configured as CAN).	
Available via	Nm.h	

] ([RS_Nm_02513](#))

Note: Caveats of `Nm_CheckRemoteSleepIndication`: The `<Bus>Nm` and the `Nm` itself are initialized correctly.

[SWS_Nm_00290] [If `Nm_CheckRemoteSleepIndication` is called with a network handle where `NmPassiveModeEnabled` is set to `TRUE` it shall not execute any functionality and return with `E_NOT_OK`. If `NmDevErrorDetect` is set to `TRUE` then it shall raise the error `NM_E_INVALID_CHANNEL` in this case.] ([RS_Nm_00150](#))

[SWS_Nm_00150] [Configuration of `Nm_CheckRemoteSleepIndication`: This function is only available if `NmRemoteSleepIndEnabled` is set to `TRUE`.] ([RS_Nm_00150](#))

[SWS_Nm_00499] [If the pre-processor switch `NmDevErrorDetect` is set to `TRUE`, the function `Nm_CheckRemoteSleepIndication` shall raise the error `NM_E_INVALID_CHANNEL` if the parameter `nmNetworkHandle` is not a configured network handle.] ([SRS_BSW_00323](#), [SRS_BSW_00369](#), [SRS_BSW_00386](#))

8.3.4.8 Nm_GetState

[SWS_Nm_00043] Definition of API function Nm_GetState [

Service Name	Nm_GetState	
Syntax	<pre>Std_ReturnType Nm_GetState (NetworkHandleType nmNetworkHandle, Nm_StateType* nmStatePtr, Nm_ModeType* nmModePtr)</pre>	
Service ID [hex]	0x0e	
Sync/Async	Synchronous	
Reentrancy	Reentrant	
Parameters (in)	nmNetworkHandle	Identification of the NM-channel
Parameters (inout)	None	
Parameters (out)	nmStatePtr	Pointer where state of the network management shall be copied to
	nmModePtr	Pointer to the location where the mode of the network management shall be copied to
Return value	Std_ReturnType	E_OK: No error E_NOT_OK: Getting of NM state has failed NetworkHandle does not exist (development only) Module not yet initialized (development only)
Description	Returns the state of the network management. The function <Bus>Nm_GetState shall be called in case NmBusType is not set to NM_BUSNM_LOCALNM. (e.g. CanNm_GetState function is called if channel is configured as CAN).	
Available via	Nm.h	

] ([RS_Nm_00050](#))

Note: Caveats of Nm_GetState: The <Bus>Nm and the Nm itself are initialized correctly.

[SWS_Nm_00500] [If the pre-processor switch NmDevErrorDetect is set to TRUE, the function Nm_GetState shall raise the error NM_E_INVALID_CHANNEL if the parameter nmNetworkHandle is not a configured network handle.] ([SRS_BSW_00323](#), [SRS_BSW_00369](#), [SRS_BSW_00386](#))

8.3.4.9 Nm_GetVersionInfo

[SWS_Nm_00044] Definition of API function Nm_GetVersionInfo [

Service Name	Nm_GetVersionInfo	
Syntax	<pre>void Nm_GetVersionInfo (Std_VersionInfoType* nmVerInfoPtr)</pre>	
Service ID [hex]	0x0f	
Sync/Async	Synchronous	
Reentrancy	Reentrant	
Parameters (in)	None	



△

Parameters (inout)	None	
Parameters (out)	nmVerInfoPtr	Pointer to where to store the version information of this module.
Return value	None	
Description	This service returns the version information of this module.	
Available via	Nm.h	

]([SRS_BSW_00003](#), [SRS_BSW_00407](#), [SRS_BSW_00482](#))

8.3.4.10 Nm_PnLearningRequest

[SWS_Nm_91003] Definition of API function Nm_PnLearningRequest [

Service Name	Nm_PnLearningRequest	
Syntax	Std_ReturnType Nm_PnLearningRequest (NetworkHandleType NetworkHandle)	
Service ID [hex]	0x22	
Sync/Async	Asynchronous	
Reentrancy	Non Reentrant for the same NetworkHandle, reentrant otherwise	
Parameters (in)	NetworkHandle	Identification of the NM-channel
Parameters (inout)	None	
Parameters (out)	None	
Return value	Std_ReturnType	E_OK: No error E_NOT_OK: PN Learning Request has failed or is not configured for the networkHandle
Description	Set Repeat Message Request Bit and Partial Network Learning Bit for NM messages transmitted next on the bus. For that purpose <Bus>Nm_PnLearningRequest shall be called (e.g. CanNm_PnLearningRequest function if channel is configured as CAN). This will force all nodes to enter the PNC Learning Phase and re-enter Repeat Message Stat. This is needed for the optional Dynamic PNC-to-channel-mapping feature.	
Available via	Nm.h	

]()

Note: Caveats of [Nm_PnLearningRequest](#): The <Bus>Nm and the Nm itself are initialized correctly.

[SWS_Nm_00502] [[Nm_PnLearningRequest](#) shall only be available if [NmDynamicPncToChannelMappingSupport](#) is set to TRUE.]()

[SWS_Nm_00503] [If [Nm_PnLearningRequest](#) is called with a network handle for a bus system where [NmDynamicPncToChannelMappingEnabled](#) is set to FALSE Nm shall not execute any functionality and return with E_NOT_OK. If [NmDevErrorDetect](#) is set to TRUE then it shall raise the error [NM_E_INVALID_CHANNEL](#) in this case.]()

[SWS_Nm_00505] [If the pre-processor switch [NmDevErrorDetect](#) is set to TRUE, the function [Nm_PnLearningRequest](#) shall raise the error [NM_E_INVALID_CHANNEL](#) if the parameter [NetworkHandle](#) is not a configured network handle.]([SRS_BSW_00323](#), [SRS_BSW_00369](#), [SRS_BSW_00386](#))

8.4 Call-back notifications

Callback notifications are called by the lower layer's bus-specific Network Management modules. For the Base functionality of Nm ([section 7.1](#)) the call-backs shall be forwarded to the upper layer's ComM. For the NM Coordinator functionality of Nm ([section 7.2](#)) the call-backs will provide indications used to control the NM Coordinator and the optional Dynamic PNC-to-channel-mapping feature.

[SWS_Nm_00028] [All callbacks of the Nm shall assume that they can run either in task or in interrupt context.] ([SRS_BSW_00333](#))

8.4.1 Standard Call-back notifications

8.4.1.1 Nm_NetworkStartIndication

[SWS_Nm_00154] Definition of callback function Nm_NetworkStartIndication [

Service Name	Nm_NetworkStartIndication	
Syntax	void Nm_NetworkStartIndication (NetworkHandleType nmNetworkHandle)	
Service ID [hex]	0x11	
Sync/Async	Asynchronous	
Reentrancy	Reentrant	
Parameters (in)	nmNetworkHandle	Identification of the NM-channel
Parameters (inout)	None	
Parameters (out)	None	
Return value	None	
Description	Notification that a NM-message has been received in the Bus-Sleep Mode, what indicates that some nodes in the network have already entered the Network Mode.	
Available via	Nm.h	

] ([SRS_BSW_00359](#), [RS_Nm_02513](#))

[SWS_Nm_00155] [The indication through callback function Nm_NetworkStartIndication: shall be forwarded to **ComM** by calling the ComM_Nm_NetworkStartIndication.] ([RS_Nm_02513](#))

8.4.1.2 Nm_NetworkMode

[SWS_Nm_00156] Definition of callback function Nm_NetworkMode [

Service Name	Nm_NetworkMode	
Syntax	<pre>void Nm_NetworkMode (NetworkHandleType nmNetworkHandle)</pre>	
Service ID [hex]	0x12	
Sync/Async	Asynchronous	
Reentrancy	Reentrant	
Parameters (in)	nmNetworkHandle	Identification of the NM-channel
Parameters (inout)	None	
Parameters (out)	None	
Return value	None	
Description	Notification that the network management has entered Network Mode.	
Available via	Nm.h	

] ([SRS_BSW_00359](#), [RS_Nm_00051](#))

[SWS_Nm_00158] [The indication through callback function Nm_NetworkMode: shall be forwarded to **ComM** by calling the ComM_Nm_NetworkMode.] ([RS_Nm_00051](#))

8.4.1.3 Nm_BusSleepMode

[SWS_Nm_00162] Definition of callback function Nm_BusSleepMode [

Service Name	Nm_BusSleepMode	
Syntax	<pre>void Nm_BusSleepMode (NetworkHandleType nmNetworkHandle)</pre>	
Service ID [hex]	0x14	
Sync/Async	Asynchronous	
Reentrancy	Reentrant	
Parameters (in)	nmNetworkHandle	Identification of the NM-channel
Parameters (inout)	None	
Parameters (out)	None	
Return value	None	
Description	Notification that the network management has entered Bus-Sleep Mode.	
Available via	Nm.h	

] ([SRS_BSW_00359](#), [RS_Nm_00051](#))

[SWS_Nm_00163] [The indication through callback function Nm_BusSleepMode: shall be forwarded to **ComM** by calling the ComM_Nm_BusSleepMode.] ([RS_Nm_00051](#))

8.4.1.4 Nm_PrepareBusSleepMode

[SWS_Nm_00159] Definition of callback function Nm_PrepareBusSleepMode [

Service Name	Nm_PrepareBusSleepMode	
Syntax	void Nm_PrepareBusSleepMode (NetworkHandleType nmNetworkHandle)	
Service ID [hex]	0x13	
Sync/Async	Asynchronous	
Reentrancy	Reentrant	
Parameters (in)	nmNetworkHandle	Identification of the NM-channel
Parameters (inout)	None	
Parameters (out)	None	
Return value	None	
Description	Notification that the network management has entered Prepare Bus-Sleep Mode.	
Available via	Nm.h	

] ([SRS_BSW_00359](#), [RS_Nm_00051](#))

[SWS_Nm_00161] [The indication through callback function [Nm_PrepareBusSleepMode](#): shall be forwarded to **ComM** by calling ComM_Nm_PrepareBusSleepMode.] ([RS_Nm_00051](#))

8.4.1.5 NM_SynchronizeMode

[SWS_Nm_91002] Definition of callback function Nm_SynchronizeMode [

Service Name	Nm_SynchronizeMode	
Syntax	void Nm_SynchronizeMode (NetworkHandleType nmNetworkHandle)	
Service ID [hex]	0x21	
Sync/Async	Asynchronous	
Reentrancy	Reentrant but not for the same channel	
Parameters (in)	nmNetworkHandle	Identification of the NM-channel
Parameters (inout)	None	
Parameters (out)	None	
Return value	None	
Description	Notification that the network management has entered Synchronize Mode.	
Available via	Nm.h	

]()

8.4.1.6 Nm_RemoteSleepIndication

[SWS_Nm_00192] Definition of callback function Nm_RemoteSleepIndication [

Service Name	Nm_RemoteSleepIndication	
Syntax	void Nm_RemoteSleepIndication (NetworkHandleType nmNetworkHandle)	
Service ID [hex]	0x17	
Sync/Async	Asynchronous	
Reentrancy	Reentrant	
Parameters (in)	nmNetworkHandle	Identification of the NM-channel
Parameters (inout)	None	
Parameters (out)	None	
Return value	None	
Description	Notification that the network management has detected that all other nodes on the network are ready to enter Bus-Sleep Mode.	
Available via	Nm.h	

] ([SRS_BSW_00359](#), [RS_Nm_00052](#))

[SWS_Nm_00277] [Configuration of [Nm_RemoteSleepIndication](#): This function is only available if [NmRemoteSleepIndEnabled](#) is set to TRUE.] ([RS_Nm_00150](#))

The notification that all other nodes on the network are ready to enter Bus-Sleep Mode is only needed for internal purposes of the NM Coordinator.

Note: When *NM Coordinator functionality* is disabled [Nm_RemoteSleepIndication](#) can be an empty function.

8.4.1.7 Nm_RemoteSleepCancellation

[SWS_Nm_00193] Definition of callback function Nm_RemoteSleepCancellation

Service Name	Nm_RemoteSleepCancellation	
Syntax	void Nm_RemoteSleepCancellation (NetworkHandleType nmNetworkHandle)	
Service ID [hex]	0x18	
Sync/Async	Asynchronous	
Reentrancy	Reentrant	
Parameters (in)	nmNetworkHandle	Identification of the NM-channel
Parameters (inout)	None	
Parameters (out)	None	
Return value	None	
Description	Notification that the network management has detected that not all other nodes on the network are longer ready to enter Bus-Sleep Mode.	
Available via	Nm.h	

] ([SRS_BSW_00359](#), [RS_Nm_02509](#))

[SWS_Nm_00278] [Configuration of [Nm_RemoteSleepCancellation](#): This function is only available if [NmRemoteSleepIndEnabled](#) is set to TRUE.] ([RS_Nm_00150](#))

The notification that not all other nodes on the network are longer ready to enter Bus-Sleep Mode is only needed for internal purposes of the NM Coordinator.

Note: When *NM Coordinator functionality* is disabled [Nm_RemoteSleepCancellation](#) can be an empty function.

8.4.1.8 Nm_SynchronizationPoint

[SWS_Nm_00194] Definition of callback function [Nm_SynchronizationPoint](#) [

Service Name	Nm_SynchronizationPoint	
Syntax	<pre>void Nm_SynchronizationPoint (NetworkHandleType nmNetworkHandle)</pre>	
Service ID [hex]	0x19	
Sync/Async	Asynchronous	
Reentrancy	Reentrant	
Parameters (in)	nmNetworkHandle	Identification of the NM-channel
Parameters (inout)	None	
Parameters (out)	None	
Return value	None	
Description	Notification to the NM Coordinator functionality that this is a suitable point in time to initiate the coordinated shutdown on.	
Available via	Nm.h	

] ([SRS_BSW_00359](#), [RS_Nm_02516](#))

The notification that this is a suitable point in time to initiate the [coordinated shutdown](#) is only needed for internal purposes of the NM Coordinator.

8.4.1.9 Nm_CoordReadyToSleepIndication

[SWS_Nm_00254] Definition of callback function [Nm_CoordReadyToSleepIndication](#) [

Service Name	Nm_CoordReadyToSleepIndication	
Syntax	<pre>void Nm_CoordReadyToSleepIndication (NetworkHandleType nmChannelHandle)</pre>	
Service ID [hex]	0x1e	
Sync/Async	Synchronous	
Reentrancy	Non Reentrant	
Parameters (in)	nmChannelHandle	Identification of the NM-channel



△

Parameters (inout)	None
Parameters (out)	None
Return value	None
Description	Sets an indication, when the NM Coordinator Sleep Ready bit in the Control Bit Vector is set
Available via	Nm.h

]([SRS_BSW_00359](#), [RS_Nm_02535](#))

[SWS_Nm_00255] [Configuration of [Nm_CoordReadyToSleepIndication](#): Optional

If [NmCoordinatorSyncSupport](#) is set to TRUE , the Nm shall provide the API [Nm_CoordReadyToSleepIndication](#).]([RS_Nm_00150](#))

8.4.1.10 Nm_CoordReadyToSleepCancellation

[SWS_Nm_00272] Definition of callback function [Nm_CoordReadyToSleepCancellation](#) [

Service Name	Nm_CoordReadyToSleepCancellation	
Syntax	void Nm_CoordReadyToSleepCancellation (NetworkHandleType nmChannelHandle)	
Service ID [hex]	0x1f	
Sync/Async	Synchronous	
Reentrancy	Non Reentrant	
Parameters (in)	nmChannelHandle	Identification of the NM-channel
Parameters (inout)	None	
Parameters (out)	None	
Return value	None	
Description	Cancels an indication, when the NM Coordinator Sleep Ready bit in the Control Bit Vector is set back to 0.	
Available via	Nm.h	

]([SRS_BSW_00359](#), [RS_Nm_02535](#))

[SWS_Nm_00273] [Configuration of [Nm_CoordReadyToSleepCancellation](#): Optional

If [NmCoordinatorSyncSupport](#) is set to TRUE , the Nm shall provide the API [Nm_CoordReadyToSleepCancellation](#).]([RS_Nm_00150](#))

8.4.1.11 Nm_ForwardSynchronizedPncShutdown

[SWS_Nm_91009] Definition of API function Nm_ForwardSynchronizedPncShutdown

Service Name	Nm_ForwardSynchronizedPncShutdown	
Syntax	<pre>void Nm_ForwardSynchronizedPncShutdown (NetworkHandleType NetworkHandle, const uint8* PncBitVectorPtr)</pre>	
Service ID [hex]	0x28	
Sync/Async	Synchronous	
Reentrancy	Non Reentrant for the same NetworkHandle, reentrant otherwise	
Parameters (in)	NetworkHandle	Identification of the NM-channel
	PncBitVectorPtr	Pointer to the bit vector with all PNC bits set to "1" which are indicated for a synchronized PNC shutdown
Parameters (inout)	None	
Parameters (out)	None	
Return value	None	
Description	Notification that the network management has received a PN shutdown message on a particular NM-channel. This is used to grant a nearly synchronized PNC shutdown across the entire PN topology.	
Available via	Nm.h	

|(RS_Nm_02544)

8.4.1.12 Nm_PncBitVectorRxIndication

[SWS_Nm_91006] Definition of callback function Nm_PncBitVectorRxIndication

Service Name	Nm_PncBitVectorRxIndication	
Syntax	<pre>void Nm_PncBitVectorRxIndication (NetworkHandleType NetworkHandle, const uint8* PncBitVectorPtr, boolean* RelevantPncRequestDetectedPtr)</pre>	
Service ID [hex]	0x25	
Sync/Async	Synchronous	
Reentrancy	Non Reentrant for the same NetworkHandle, reentrant otherwise	
Parameters (in)	NetworkHandle	Identification of the NM-channel
	PncBitVectorPtr	Pointer to the bit vector with all PNC bits set to "1" of external requested PNCs
Parameters (inout)	None	
Parameters (out)	RelevantPncRequestDetectedPtr	Pointer to a boolean variable which indicates, if a relevant PNC request is available in the given PncBitVector
Return value	None	





Description	Indication that a bus specific network management has received a NM message on a particular NM-channel that contain a PNC bit vector. This is used to aggregate the external PNC requests. The function evaluate if a relevant PNC request (PNC bit set to '1') is available in the given PNC bit vector. If a relevant PNC request is available (PNC bit passes the PNC bit vector filter), then the RelevantPncRequestDetectedPtr refers to a boolean with value set to TRUE. Otherwise refer to boolean with value set to FALSE. RelevantPncRequestDetectedPtr is evaluated by the callee <Bus>Nm module to qualify the further processing of the received NM-PDU.
Available via	Nm.h

|(RS_Nm_02544, SRS_ModeMgm_09250)

8.4.1.13 Nm_PncBitVectorTxIndication

[SWS_Nm_91008] Definition of callback function Nm_PncBitVectorTxIndication

[

Service Name	Nm_PncBitVectorTxIndication	
Syntax	<pre>void Nm_PncBitVectorTxIndication (NetworkHandleType NetworkHandle, uint8* PncBitVectorPtr)</pre>	
Service ID [hex]	0x27	
Sync/Async	Synchronous	
Reentrancy	Non Reentrant for the same NetworkHandle, reentrant otherwise	
Parameters (in)	NetworkHandle	Identification of the NM-channel
Parameters (inout)	None	
Parameters (out)	PncBitVectorPtr	Pointer to the bit vector with all PNC bits set to "1" of internal requested PNCs
Return value	None	
Description	Function called by <Bus>Nms to request the aggregated internal PNC requests for transmission within the Nm message.	
Available via	Nm.h	

|(RS_Nm_02544, SRS_ModeMgm_09250)

8.4.1.14 Nm_PncBitVectorTxConfirmation

[SWS_Nm_91010] Definition of callback function Nm_PncBitVectorTxConfirmation

[

Service Name	Nm_PncBitVectorTxConfirmation	
Syntax	<pre>void Nm_PncBitVectorTxConfirmation (NetworkHandleType NetworkHandle, const uint8* PncBitVectorPtr, Std_ReturnType result)</pre>	
Service ID [hex]	0x29	
Sync/Async	Synchronous	





Reentrancy	Non-reentrant for the same NetworkHandle, reentrant otherwise	
Parameters (in)	NetworkHandle	Identification of the NM-channel
	PncBitVectorPtr	Pointer to the PNC bit vector which was considered for transmission
	result	E_OK: The PNC bit vector has been transmitted E_NOT_OK: The transmission of the PNC bit vector failed
Parameters (inout)	None	
Parameters (out)	None	
Return value	None	
Description	Function called by <Bus>Nms to confirm the state of the transmission for the given PNC bit vector on the given NM-Channel.	
Available via	Nm.h	

]([RS_Nm_02574](#), [SRS_ModeMgm_09250](#))

8.4.2 Extra Call-back notifications

The following call-back notifications are provided by NM Interface for OEM specific extensions of bus specific NM components and are not required by any AUTOSAR module. In the context of the Basic functionality and NM Coordinator functionality they have no specific usage.

8.4.2.1 Nm_PduRxIndication

[SWS_Nm_00112] Definition of callback function Nm_PduRxIndication [

Service Name	Nm_PduRxIndication	
Syntax	<pre>void Nm_PduRxIndication (NetworkHandleType nmNetworkHandle)</pre>	
Service ID [hex]	0x15	
Sync/Async	Asynchronous	
Reentrancy	Reentrant	
Parameters (in)	nmNetworkHandle	Identification of the NM-channel
Parameters (inout)	None	
Parameters (out)	None	
Return value	None	
Description	Notification that a NM message has been received.	
Available via	Nm.h	

]([SRS_BSW_00359](#))

The notification that an NM message has been received is only needed for OEM specific extensions of the *NM Coordinator*.

[SWS_Nm_00164] [Configuration of [Nm_PduRxIndication](#): This function is only available if [NmPduRxIndicationEnabled](#) is set to TRUE.] ([RS_Nm_00150](#))

8.4.2.2 Nm_StateChangeNotification

[SWS_Nm_00114] Definition of callback function [Nm_StateChangeNotification](#) [

Service Name	Nm_StateChangeNotification	
Syntax	<pre>void Nm_StateChangeNotification (NetworkHandleType nmNetworkHandle, Nm_StateType nmPreviousState, Nm_StateType nmCurrentState)</pre>	
Service ID [hex]	0x16	
Sync/Async	Asynchronous	
Reentrancy	Reentrant	
Parameters (in)	nmNetworkHandle	Identification of the NM-channel
	nmPreviousState	Previous state of the NM-channel
	nmCurrentState	Current (new) state of the NM-channel
Parameters (inout)	None	
Parameters (out)	None	
Return value	None	
Description	Notification that the state of the lower layer <Bus>Nm has changed.	
Available via	Nm.h	

] ([SRS_BSW_00359](#), [RS_Nm_00050](#), [RS_Nm_00051](#))

The notification that the state of the bus-specific NM has changed is only needed for OEM specific extensions and for the optional Dynamic PNC-to-channel-mapping feature.

[SWS_Nm_00165] [Configuration of [Nm_StateChangeNotification](#): This function is only available if [NmStateChangeIndEnabled](#) is set to TRUE.] ([RS_Nm_00150](#))

8.4.2.3 Nm_RepeatMessageIndication

[SWS_Nm_00230] Definition of callback function [Nm_RepeatMessageIndication](#) [

Service Name	Nm_RepeatMessageIndication	
Syntax	<pre>void Nm_RepeatMessageIndication (NetworkHandleType nmNetworkHandle, boolean pnLearningBitSet)</pre>	
Service ID [hex]	0x1a	
Sync/Async	Asynchronous	





Reentrancy	Reentrant	
Parameters (in)	nmNetworkHandle	Identification of the NM-channel
	pnLearningBitSet	TRUE if also the Partial Network Learning Bit was received, FALSE otherwise
Parameters (inout)	None	
Parameters (out)	None	
Return value	None	
Description	Service to indicate that an NM message with set Repeat Message Request Bit has been received. This is needed for node detection and the Dynamic PNC-to-channel-mapping feature.	
Available via	Nm.h	

]([SRS_BSW_00359](#), [RS_Nm_00153](#), [RS_Nm_00051](#))

The notification that an NM message with the set Repeat Message Bit has been received is only needed for OEM specific extensions and for the optional Dynamic PNC-to-channel-mapping feature.

[SWS_Nm_00504] [If [Nm_RepeatMessageIndication](#) is called with [pnLearningBitSet](#) set to TRUE and [NmDynamicPncToChannelMappingEnabled](#) is set to TRUE for the provided [nmNetworkHandle](#) Nm shall call [ComM_Nm_PncLearningBitIndication](#) with the corresponding network handle.]
()

8.4.2.4 Nm_TxTimeoutException

[SWS_Nm_00234] Definition of callback function Nm_TxTimeoutException [

Service Name	Nm_TxTimeoutException	
Syntax	<pre>void Nm_TxTimeoutException (NetworkHandleType nmNetworkHandle)</pre>	
Service ID [hex]	0x1b	
Sync/Async	Asynchronous	
Reentrancy	Reentrant	
Parameters (in)	nmNetworkHandle	–
Parameters (inout)	None	
Parameters (out)	None	
Return value	None	
Description	Service to indicate that an attempt to send an NM message failed.	
Available via	Nm.h	

]([SRS_BSW_00359](#))

The notification that an attempt to send an NM message failed is only needed for OEM specific extensions of the Nm.

8.4.2.5 Nm_CarWakeUpIndication

[SWS_Nm_00250] Definition of callback function Nm_CarWakeUpIndication [

Service Name	Nm_CarWakeUpIndication	
Syntax	void Nm_CarWakeUpIndication (NetworkHandleType nmChannelHandle)	
Service ID [hex]	0x1d	
Sync/Async	Synchronous	
Reentrancy	Reentrant	
Parameters (in)	nmChannelHandle	Identification of the NM-channel
Parameters (inout)	None	
Parameters (out)	None	
Return value	None	
Description	This function is called by a <Bus>Nm to indicate reception of a CWU request.	
Available via	Nm.h	

] ([SRS_BSW_00359](#), [RS_Nm_02503](#), [RS_Nm_02536](#))

[SWS_Nm_00251] [Configuration of Nm_CarWakeUpIndication: Optional
If NmCarWakeUpRxEnabled is **TRUE**, The Nm shall provide the API Nm_CarWake-
UpIndication.] ([RS_Nm_00150](#))

8.5 Scheduled functions

Since the Base functionality (Chapter 7.1) does not contain any logic that needs to be invoked outside the scope of call from the upper or lower layer, the main function is only needed to implement the NM Coordinator functionality (Chapter 7.2).

[SWS_Nm_00020] [A scheduled main function shall only contain logic related to the NM Coordinator functionality.] ([SRS_BSW_00373](#))

[SWS_Nm_00121] [In case the main function is called before the Nm has been initialized, the main function shall immediately return without yielding an error.] ([SRS_BSW_00450](#))

Rationale: In case the NM Coordinator functionality is not used and/or disabled, calling the main function shall not yield in an error, but nothing should be performed.

8.5.1 Nm_MainFunction

[SWS_Nm_00118] Definition of scheduled function Nm_MainFunction [

Service Name	Nm_MainFunction
Syntax	void Nm_MainFunction (void)
Service ID [hex]	0x10
Description	This function implements the processes of the NM Interface, which need a fix cyclic scheduling.
Available via	SchM_Nm.h

]([SRS_BSW_00424](#), [SRS_BSW_00425](#))

[SWS_Nm_00279] [If [NmCoordinatorSupportEnabled](#) is set to TRUE, the [Nm_MainFunction](#) API shall be available.]([RS_Nm_00150](#))

8.6 Expected interfaces

This chapter lists all interfaces required from other modules.

8.6.1 Mandatory Interfaces

This chapter lists all interfaces required from other modules.

[SWS_Nm_00119] Definition of mandatory interfaces in module Nm [

API Function	Header File	Description
<Bus>Nm_GetState	–	Returns the state and the mode of the network management.
<Bus>Nm_NetworkRelease	–	Release the network, since ECU doesn't have to communicate on the bus.
<Bus>Nm_NetworkRequest	–	Request the network, since ECU needs to communicate on the bus.
<Bus>Nm_PassiveStartUp	–	Passive startup of the NM. It triggers the transition from Bus-Sleep Mode to the Network Mode without requesting the network.
ComM_Nm_BusSleepMode	ComM_Nm.h	Notification that the network management has entered Bus-Sleep Mode. This callback function should perform a transition of the hardware and transceiver to bus-sleep mode.
ComM_Nm_NetworkMode	ComM_Nm.h	Notification that the network management has entered Network Mode.
ComM_Nm_NetworkStartIndication	ComM_Nm.h	Indication that a NM-message has been received in the Bus Sleep Mode, what indicates that some nodes in the network have already entered the Network Mode.





API Function	Header File	Description
ComM_Nm_PrepareBusSleepMode	ComM_Nm.h	Notification that the network management has entered Prepare Bus-Sleep Mode. Reentrancy: Reentrant (but not for the same NM-Channel)
ComM_Nm_RestartIndication	ComM_Nm.h	If NmIf has started to shut down the coordinated busses, AND not all coordinated busses have indicated bus sleep state, AND on at least on one of the coordinated busses NM is restarted, THEN the NM Interface shall call the callback function ComM_Nm_RestartIndication with the nmNetworkHandle of the channels which have already indicated bus sleep state.

|(RS_Nm_02515, RS_Nm_02536)

8.6.2 Optional Interfaces

This chapter defines all interfaces that are required to fulfill an optional functionality of the module.

[SWS_Nm_00166] Definition of optional interfaces in module Nm [

API Function	Header File	Description
<Bus>Nm_ActivateTxPnShutdownMsg	–	NM indicate to activate the transmission of PN shutdown messages on the given NM-Channel. This results in transmission of a NM-PDU with PNSR bit set to 1 (PN shutdown message).
<Bus>Nm_CheckRemoteSleep Indication	–	Check if remote sleep indication takes place or not.
<Bus>Nm_DeactivateTxPnShutdown Msg	–	NM indicate to deactivate the transmission of PN shutdown messages on the given NM-Channel. This result in transmission of a usual NM-PDUs with PNSR bit set to 0.
<Bus>Nm_DisableCommunication	–	Disable the NM PDU transmission ability.
<Bus>Nm_EnableCommunication	–	Enable the NM PDU transmission ability.
<Bus>Nm_GetLocalNodeIdentifier	–	Get node identifier configured for the local node.
<Bus>Nm_GetNodeIdentifier	–	Get node identifier out of the last successfully received NM-message.
<Bus>Nm_GetPduData	–	Pointer where NM PDU shall be copied to.
<Bus>Nm_GetUserData	–	Get user data out of the last successfully received NM message.
<Bus>Nm_PnLearningRequest	–	–
<Bus>Nm_RepeatMessageRequest	–	Request a Repeat Message Request to be transmitted next on the bus.
<Bus>Nm_RequestBus Synchronization	–	Request bus synchronization.
<Bus>Nm_RequestSynchronizedPnc Shutdown	–	–
<Bus>Nm_SetSleepReadyBit	–	Set the NM Coordinator Sleep Ready bit in the Control Bit Vector
<Bus>Nm_SetUserData	–	Set user data for NM messages transmitted next on the bus.





API Function	Header File	Description
BswM_Nm_CarWakeUpIndication	BswM_Nm.h	Function called by Nm to indicate a CarWakeUp.
Com_SendSignal	Com.h	The service Com_SendSignal updates the signal object identified by SignalId with the signal referenced by the SignalDataPtr parameter.
ComM_Nm_ForwardSynchronizedPncShutdown	ComM_Nm.h	If an ECU in role of an intermediate PNC coordinator receives a PN shutdown message via a <Bus>Nm, then ComM is immediately indicated via ComM_Nm_ForwardSynchronizedPncShutdown to forward the request for a synchronized PNC shutdown of the affected PNCs given by PncBitVectorPtr. Therefore, ComM will immediately release the affected PNC state machines and forward the PNC bit vector to the affected ComM Channels and the corresponding NM channels, respectively. Note: This supports a nearly synchronized PNC shutdown across the PN topology from the top-level PNC coordinator down to the subordinated PNC node.
ComM_Nm_PncLearningBitIndication	ComM_Nm.h	Service to indicate that an NM message with set PNC Learning Bit has been received.
ComM_Nm_RepeatMessageLeft Indication	ComM_Nm.h	Notification that the state of all <Bus>Nm has left RepeatMessage. This interface is used to indicate by the optional Dynamic PNC-to-channel-mapping feature to indicate that learning phase ends.
ComM_Nm_UpdateEIRA	ComM_Nm.h	Function to indicate the current aggregated external / internal PNC request called by Nm.
ComM_Nm_UpdateERA	ComM_Nm.h	Function to indicate the current external PNC request per channel called by Nm.
Det_ReportError	Det.h	Service to report development errors.

|(RS_Nm_00150, RS_Nm_02515)

8.6.3 Configurable Interfaces

In this chapter all interfaces are listed where the target function could be configured. The target function is usually a call-back function. The names of these kind of interfaces are not fixed because they are configurable.

8.6.3.1 NmCarWakeUpCallout

[SWS_Nm_00291] Definition of configurable interface <NmCarWakeUpCallout> [

Service Name	<NmCarWakeUpCallout>
Syntax	void <NmCarWakeUpCallout> (NetworkHandleType nmNetworkHandle)
Service ID [hex]	0x20
Sync/Async	Asynchronous
Reentrancy	Non Reentrant





Parameters (in)	nmNetworkHandle	Identification of the NM-channel
Parameters (inout)	None	
Parameters (out)	None	
Return value	None	
Description	Callout function to be called by Nm_CarWakeUpIndication()	
Available via	Nm_Externals.h	

]([RS_Nm_02504](#))

8.7 Version Check

For details refer to the chapter 5.1.8 "Version Check" in [[2](#), SWS_BSWGeneral].

9 Sequence diagrams

9.1 Basic functionality

The role of the *Basic functionality* of the **Nm** is to act as a dispatcher of functions between the ComM and the Bus Specific NM modules. Therefore, no sequence diagram is provided.

9.2 Seq of NM Coordinator functionality

Figure shows the sequence diagram for the shutdown of network of the *NM Coordinator* functionality.

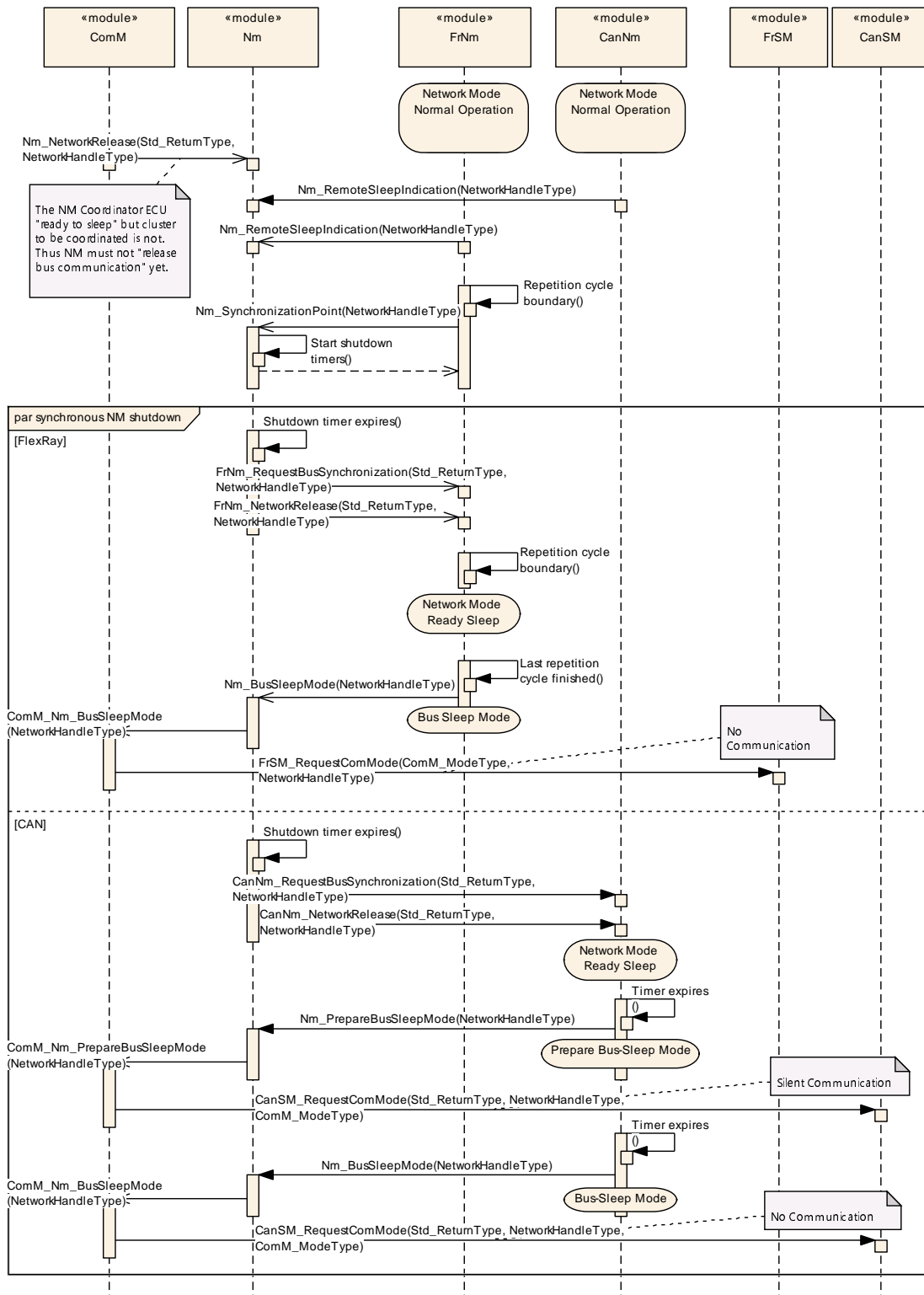

Figure 9.1: Nm Coordination

9.3 Sequence of Partial network functionality

The following sequence diagram shows the interaction between **Nm** and the **CanIf** module as example. The following deviations has to be considered if using FlexRay communication stack

- FrNm has no ECUC parameter similar to `CanNmAllNmMessagesKeepAwake`
- FrNm needs to check ECUC parameter `FrIfImmediate` of the NM PDU configured in `FrIf`
- If using `FrNm`, the NM Pdu is always fetched via `FrNm_TriggerTransmit`. There is no ECUC parameter similar to `CanIfTxPduTriggerTransmit`

The following deviations have to be considered if using an Ethernet communication stack:

- The `UdpNm` module interacts with the `SoAd` (and NOT with the `EthIf`). Therefore `UdpNm` has to call `SoAd_IfTransmit` to trigger a transmission of a NM PDU. The `SoAd` has to call `UdpNm_SoAdIfRxIndication` to indicate the reception of NM PDU
- `UdpNm` needs to check the ECUC parameter `SoAdBswModules/-SoAdIfTriggerTransmit` of the `SoAd`, to determine if the NM PDU is fetched via call of `UdpNm_SoAdIfTriggerTransmit`

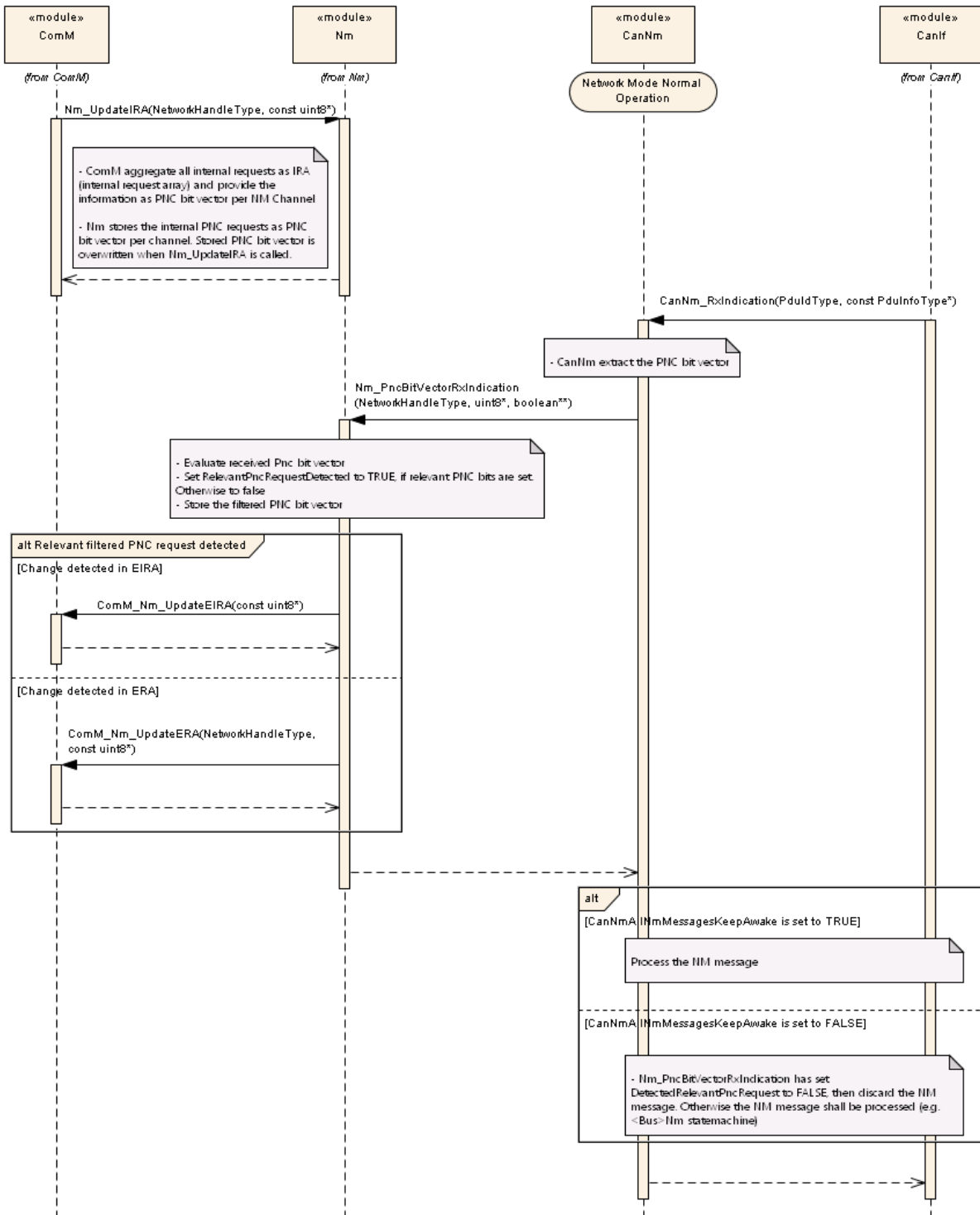

Figure 9.2: Partial Network functionality (part 1)

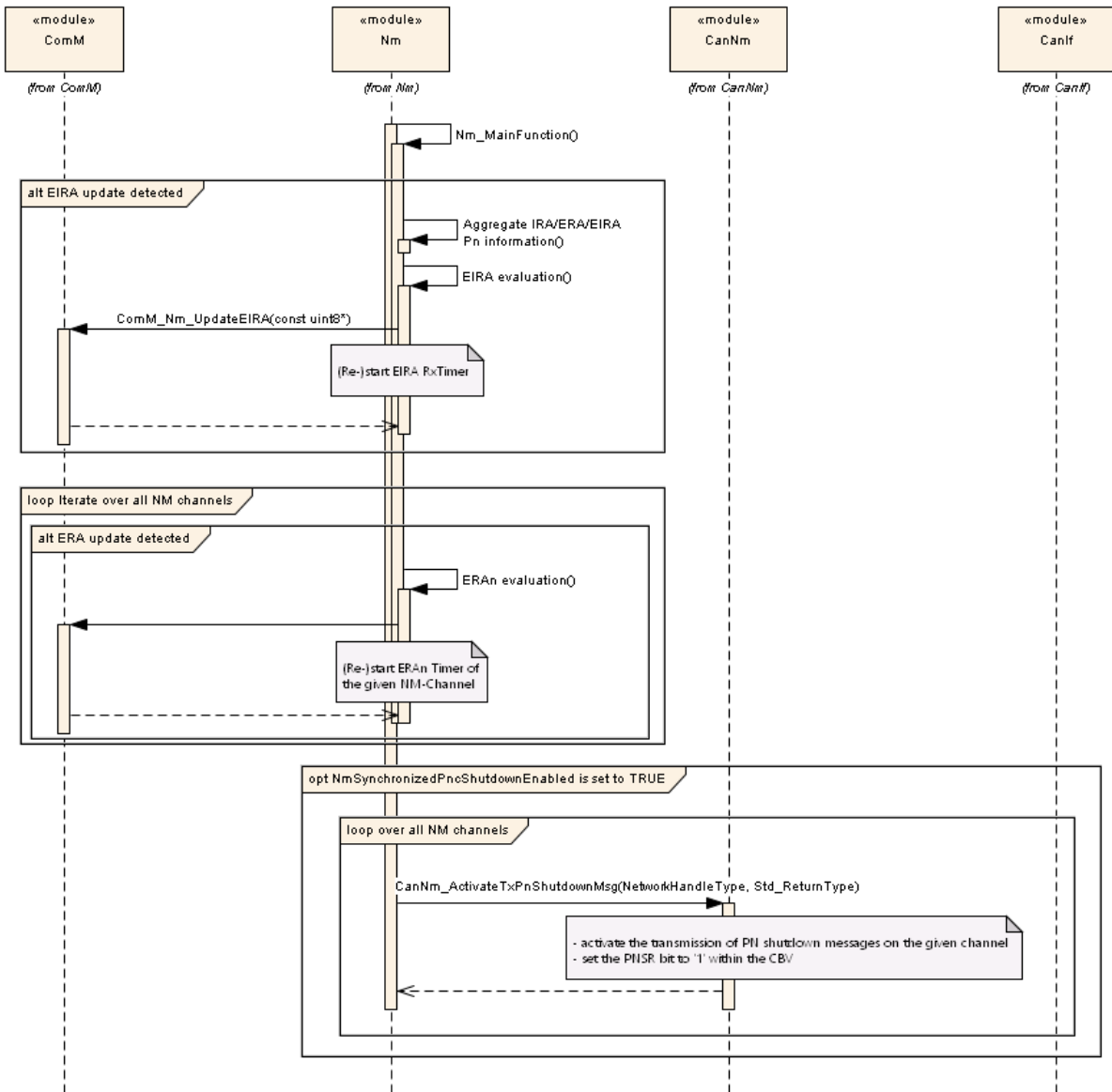

Figure 9.3: Partial Network functionality (part 2)

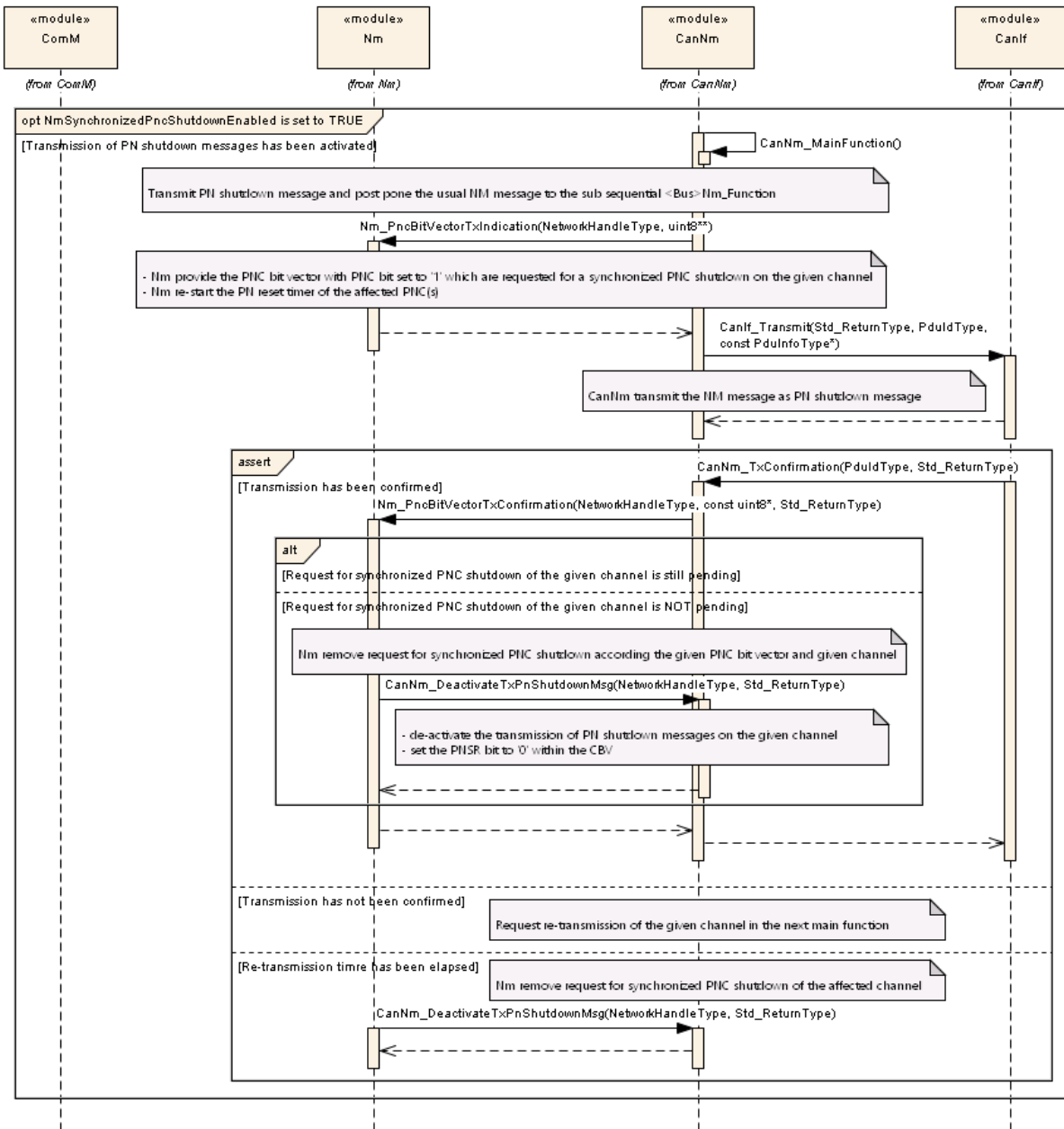

Figure 9.4: Partial Network functionality (part 3)

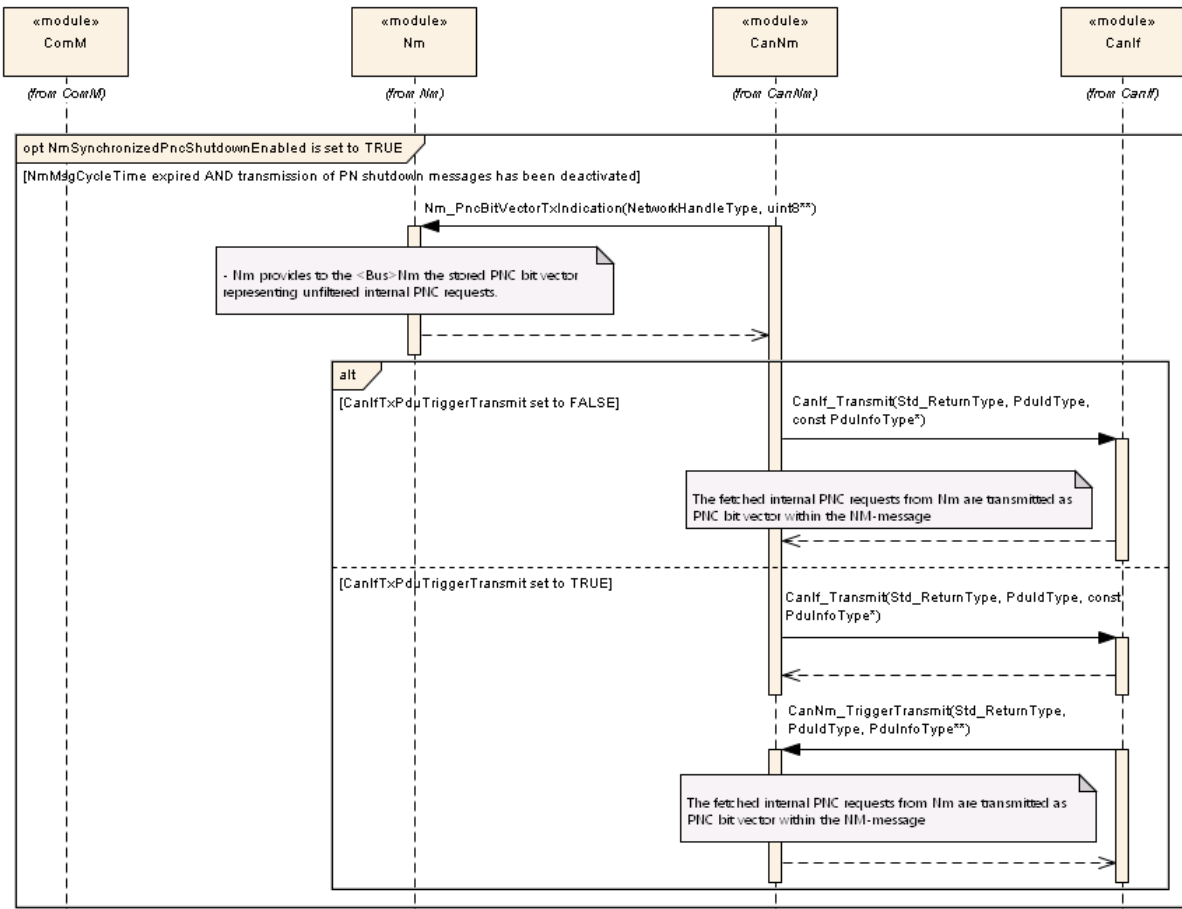

Figure 9.5: Partial Network functionality (part 4)

10 Configuration specification

The following chapter contains tables of all configuration parameters and switches used to determine the functional units of the Generic Network Management Interface. The default values of configuration parameters are denoted as bold.

In general, this chapter defines configuration parameters and their clustering into containers. [section 10.1](#) describes fundamentals. [section 10.2](#), [section 10.3](#) and [section 10.4](#) specifies the structure (containers) and the parameters of the Nm. The [section 10.5](#) specifies published information of the Nm.

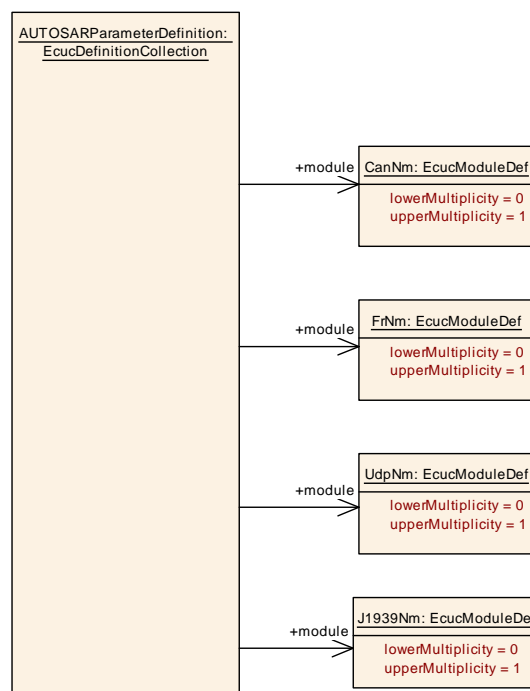

Figure 10.1: Network Management Overview

10.1 How to read this chapter

For details refer to the [2, chapter 10.1 “Introduction to configuration specification” in SWS_BSWGeneral]

10.2 Configuration parameters

The following Chapters summarize all configuration parameters for the Nm. The detailed meanings of most parameters are described in [chapter 7](#) and [chapter 8](#). Note that the behavior and configuration of Nm is closely dependent on the behavior and configuration of the different bus specific NM modules used.

10.2.1 Nm

SWS Item	[ECUC_Nm_00243]
Module Name	Nm
Description	The Generic Network Management Interface module
Post-Build Variant Support	false
Supported Config Variants	VARIANT-LINK-TIME, VARIANT-PRE-COMPILE

Included Containers		
Container Name	Multiplicity	Scope / Dependency
NmChannelConfig	1..*	This container contains the configuration (parameters) of the bus channel(s). The channel parameter shall be harmonized within the whole communication stack.
NmGlobalConfig	1	This container contains all global configuration parameters of the Nm Interface.

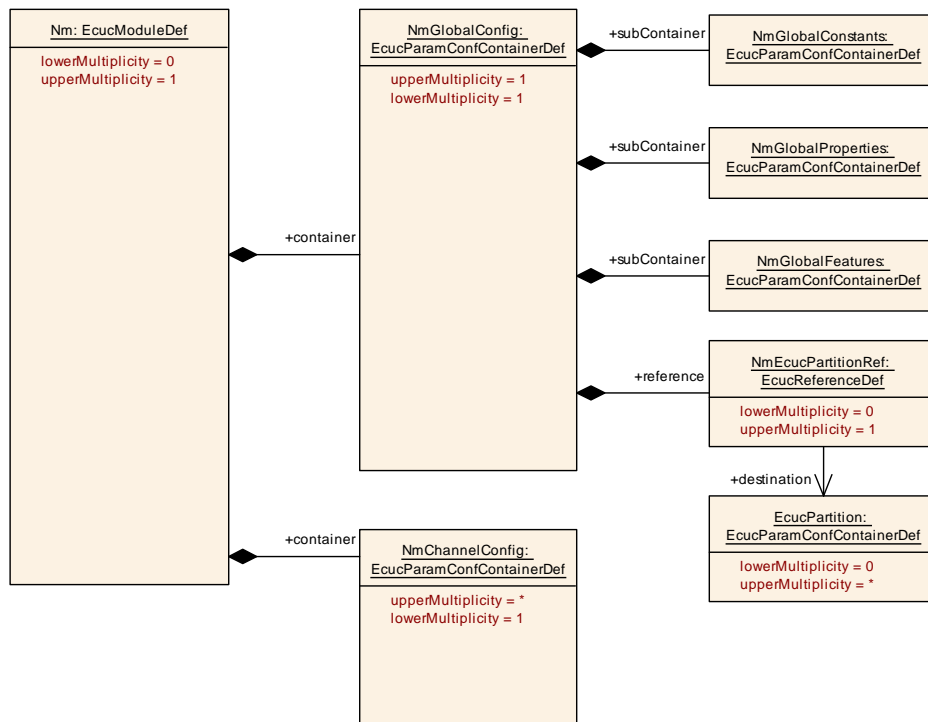

Figure 10.2: Nm configuration container overview

10.3 Global configurable parameters

10.3.1 NmGlobalConfig

SWS Item	[ECUC_Nm_00196]
Container Name	NmGlobalConfig
Parent Container	Nm
Description	This container contains all global configuration parameters of the Nm Interface.
Configuration Parameters	

SWS Item	[ECUC_Nm_00245]		
Parameter Name	NmEcucPartitionRef		
Parent Container	NmGlobalConfig		
Description	Reference to EcucPartition, where Nm module is assigned to.		
Multiplicity	0..1		
Type	Reference to EcucPartition		
Post-Build Variant Multiplicity	false		
Post-Build Variant Value	false		
Multiplicity Configuration Class	Pre-compile time	X	All Variants
	Link time	–	
	Post-build time	–	
Value Configuration Class	Pre-compile time	X	All Variants
	Link time	–	
	Post-build time	–	
Scope / Dependency	scope: local		

Included Containers		
Container Name	Multiplicity	Scope / Dependency
NmGlobalConstants	1	–
NmGlobalFeatures	1	–
NmGlobalProperties	1	–

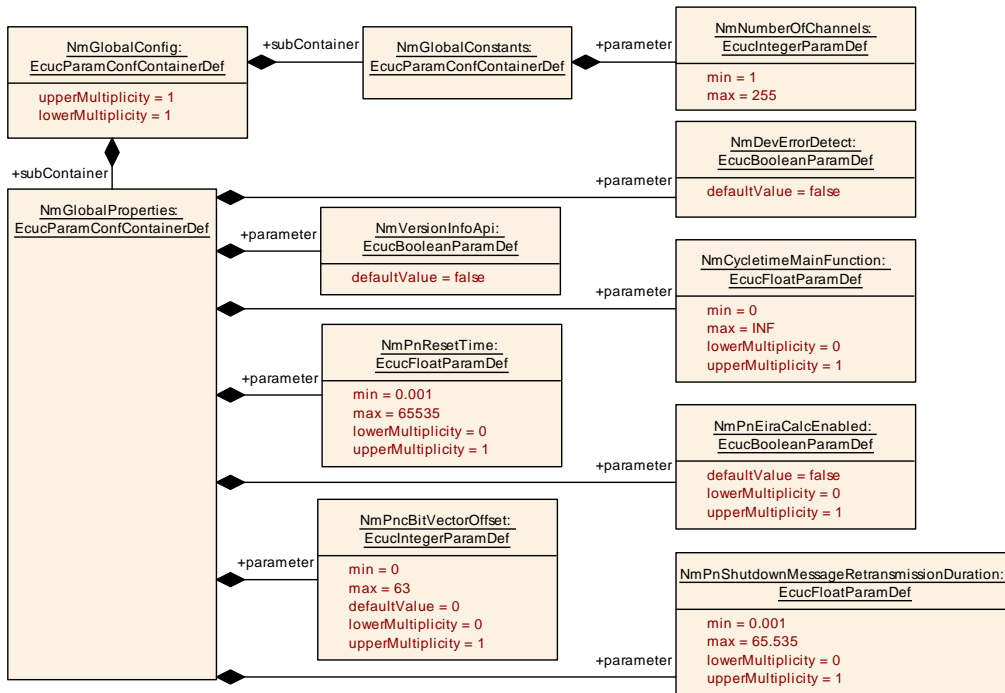

Figure 10.3: NmGlobalConfig overview

10.3.2 NmGlobalConstants

SWS Item	[ECUC_Nm_00198]
Container Name	NmGlobalConstants
Parent Container	NmGlobalConfig
Description	–
Configuration Parameters	

SWS Item	[ECUC_Nm_00201]		
Parameter Name	NmNumberOfChannels		
Parent Container	NmGlobalConstants		
Description	Number of NM channels allowed within one ECU.		
Multiplicity	1		
Type	EcucIntegerParamDef		
Range	1 .. 255		
Default value	–		
Post-Build Variant Value	false		
Value Configuration Class	Pre-compile time	X	All Variants
	Link time	–	
	Post-build time	–	
Scope / Dependency	scope: local		

No Included Containers

10.3.3 NmGlobalProperties

SWS Item	[ECUC_Nm_00199]
Container Name	NmGlobalProperties
Parent Container	NmGlobalConfig
Description	–
Configuration Parameters	

SWS Item	[ECUC_Nm_00205]		
Parameter Name	NmCycletimeMainFunction		
Parent Container	NmGlobalProperties		
Description	The period between successive calls to the Main Function of the NM Interface in seconds.		
Multiplicity	0..1		
Type	EcucFloatParamDef		
Range]0 .. INF[
Default value	–		
Post-Build Variant Multiplicity	false		
Post-Build Variant Value	false		
Multiplicity Configuration Class	Pre-compile time	X	VARIANT-PRE-COMPILE
	Link time	X	VARIANT-LINK-TIME
	Post-build time	–	
Value Configuration Class	Pre-compile time	X	VARIANT-PRE-COMPILE
	Link time	X	VARIANT-LINK-TIME
	Post-build time	–	
Scope / Dependency	scope: local dependency: If NmCoordinatorSupportEnabled is set to TRUE, then the NmCycletime MainFunction shall be configured.		

SWS Item	[ECUC_Nm_00203]		
Parameter Name	NmDevErrorDetect		
Parent Container	NmGlobalProperties		
Description	Switches the development error detection and notification on or off. <ul style="list-style-type: none"> ● true: detection and notification is enabled. ● false: detection and notification is disabled. 		
Multiplicity	1		
Type	EcucBooleanParamDef		
Default value	false		
Post-Build Variant Value	false		
Value Configuration Class	Pre-compile time	X	All Variants
	Link time	–	
	Post-build time	–	
Scope / Dependency	scope: local		

SWS Item	[ECUC_Nm_00252]		
Parameter Name	NmPncBitVectorOffset		
Parent Container	NmGlobalProperties		





Description	Parameter to configure the offset in bytes of the PNC bit vector that contains the PNC requests, which is transmitted within NM PDU by the corresponding <Bus>Nm.		
Multiplicity	0..1		
Type	EcucIntegerParamDef		
Range	0 .. 63		
Default value	0		
Value Configuration Class	Pre-compile time	X	VARIANT-PRE-COMPILE
	Link time	X	VARIANT-LINK-TIME
	Post-build time	–	
Scope / Dependency	scope: ECU dependency: This parameter is only valid if NmPartialNetworkSupportEnabled is set to TRUE. NmPncBitVectorOffset == Number of <Bus>Nm Sytem Bytes OR NmPncBit VectorOffset + NmPncBitVectorLength == NM PduLength.		

SWS Item	[ECUC_Nm_00251]		
Parameter Name	NmPnEraCalcEnabled		
Parent Container	NmGlobalProperties		
Description	Specifies if NmIf calculates the PNC request information for internal and external requests (EIRA) true: PN request are calculated false: PN request are not calculated Note: A PNC coordinator (NmPnEraCalcEnabled set to TRUE) has always set NmPnEraCalcEnabled to TRUE.		
Multiplicity	0..1		
Type	EcucBooleanParamDef		
Default value	false		
Multiplicity Configuration Class	Pre-compile time	X	VARIANT-PRE-COMPILE
	Link time	X	VARIANT-LINK-TIME
	Post-build time	–	
Value Configuration Class	Pre-compile time	X	VARIANT-PRE-COMPILE
	Link time	X	VARIANT-LINK-TIME
	Post-build time	–	
Scope / Dependency	scope: local dependency: This parameter can only be set to TRUE if NmPartialNetworkSupport Enabled is set to TRUE. If NmPnEraCalcEnabled is set to TRUE than this parameter shall be set to TRUE.		

SWS Item	[ECUC_Nm_00250]		
Parameter Name	NmPnResetTime		
Parent Container	NmGlobalProperties		
Description	Specifies the runtime of the reset time in seconds. This reset time is valid for the reset of PNC requests in the EIRA and in the ERA. The value shall be the same for every channel. Thus it is a global config parameter.		
Multiplicity	0..1		
Type	EcucFloatParamDef		
Range	[0.001 .. 65535]		
Default value	–		
Multiplicity Configuration Class	Pre-compile time	X	VARIANT-PRE-COMPILE
	Link time	X	VARIANT-LINK-TIME



△

	Post-build time	–	
Value Configuration Class	Pre-compile time	X	VARIANT-PRE-COMPILE
	Link time	X	VARIANT-LINK-TIME
	Post-build time	–	
Scope / Dependency	scope: local dependency: This parameter is only valid if NmPartialNetworkSupportEnabled is set to TRUE. NmPnResetTime > <Can Udp>NmMsgCycleTime NmPnResetTime > FrNmDataCycle * FR Cycle Time		

SWS Item	[ECUC_Nm_00260]		
Parameter Name	NmPnShutdownMessageRetransmissionDuration		
Parent Container	NmGlobalProperties		
Description	Specifies the duration in seconds of the retransmission phase of a PN shutdown message. A retransmission shall be performed per affected NM channel, as long as the PN shutdown message could not be successfully sent and the retransmission timer is running. The value shall be a multiple integral NmMainFunctionPeriod.		
Multiplicity	0..1		
Type	EcucFloatParamDef		
Range	[0.001 .. 65.535]		
Default value	–		
Post-Build Variant Multiplicity	false		
Post-Build Variant Value	false		
Multiplicity Configuration Class	Pre-compile time	X	VARIANT-PRE-COMPILE
	Link time	X	VARIANT-LINK-TIME
	Post-build time	–	
Value Configuration Class	Pre-compile time	X	VARIANT-PRE-COMPILE
	Link time	X	VARIANT-LINK-TIME
	Post-build time	–	
Scope / Dependency	scope: local dependency: Only valid NmSynchronizedPncShutdownEnabled == TRUE. NmPnShutdownMessageRetransmissionDuration <= NmPnResetTime.		

SWS Item	[ECUC_Nm_00204]		
Parameter Name	NmVersionInfoApi		
Parent Container	NmGlobalProperties		
Description	Pre-processor switch for enabling Version Info API support.		
Multiplicity	1		
Type	EcucBooleanParamDef		
Default value	false		
Post-Build Variant Value	false		
Value Configuration Class	Pre-compile time	X	All Variants
	Link time	–	
	Post-build time	–	
Scope / Dependency	scope: local		

No Included Containers

10.3.4 NmGlobalFeatures

SWS Item	[ECUC_Nm_00200]
Container Name	NmGlobalFeatures
Parent Container	NmGlobalConfig
Description	–
Configuration Parameters	

SWS Item	[ECUC_Nm_00208]		
Parameter Name	NmBusSynchronizationEnabled		
Parent Container	NmGlobalFeatures		
Description	Pre-processor switch for enabling bus synchronization support of the <Bus>Nms. This feature is required for NM Coordinator nodes only.		
Multiplicity	1		
Type	EcucBooleanParamDef		
Default value	–		
Post-Build Variant Value	false		
Value Configuration Class	Pre-compile time	X	All Variants
	Link time	–	
	Post-build time	–	
Scope / Dependency	scope: local dependency: This parameter must be enabled if NmCoordinatorSupportEnabled is enabled.		

SWS Item	[ECUC_Nm_00234]		
Parameter Name	NmCarWakeUpCallout		
Parent Container	NmGlobalFeatures		
Description	Name of the callout function to be called if Nm_CarWakeUpIndication() is called. If this parameter is not configured, the Nm will call BswM_Nm_CarWakeUpIndication.		
Multiplicity	0..1		
Type	EcucFunctionNameDef		
Default value	–		
Regular Expression	–		
Post-Build Variant Multiplicity	false		
Post-Build Variant Value	false		
Multiplicity Configuration Class	Pre-compile time	X	VARIANT-PRE-COMPILE
	Link time	X	VARIANT-LINK-TIME
	Post-build time	–	
Value Configuration Class	Pre-compile time	X	VARIANT-PRE-COMPILE
	Link time	X	VARIANT-LINK-TIME
	Post-build time	–	
Scope / Dependency	scope: local dependency: only available if NmCarWakeUpRxEnabled == TRUE		

SWS Item	[ECUC_Nm_00235]
Parameter Name	NmCarWakeUpRxEnabled
Parent Container	NmGlobalFeatures





Description	Enables or disables CWU detection. FALSE - CarWakeUp not supported TRUE - Car WakeUp supported		
Multiplicity	1		
Type	EcucBooleanParamDef		
Default value	false		
Post-Build Variant Value	false		
Value Configuration Class	Pre-compile time	X	VARIANT-PRE-COMPILE
	Link time	X	VARIANT-LINK-TIME
	Post-build time	–	
Scope / Dependency	scope: local		

SWS Item	[ECUC_Nm_00210]		
Parameter Name	NmComControlEnabled		
Parent Container	NmGlobalFeatures		
Description	Pre-processor switch for enabling the Communication Control support.		
Multiplicity	1		
Type	EcucBooleanParamDef		
Default value	–		
Post-Build Variant Value	false		
Value Configuration Class	Pre-compile time	X	All Variants
	Link time	–	
	Post-build time	–	
Scope / Dependency	scope: local		

SWS Item	[ECUC_Nm_00206]		
Parameter Name	NmCoordinatorSupportEnabled		
Parent Container	NmGlobalFeatures		
Description	Pre-processor switch for enabling NM Coordinator support.		
Multiplicity	1		
Type	EcucBooleanParamDef		
Default value	false		
Post-Build Variant Value	false		
Value Configuration Class	Pre-compile time	X	All Variants
	Link time	–	
	Post-build time	–	
Scope / Dependency	scope: local dependency: Only valid if at least one NM channel exists which has NmPassiveMode Enabled set to FALSE.		

SWS Item	[ECUC_Nm_00240]		
Parameter Name	NmCoordinatorSyncSupport		
Parent Container	NmGlobalFeatures		
Description	Enables/disables the coordinator synchronisation support.		
Multiplicity	1		
Type	EcucBooleanParamDef		
Default value	–		
Post-Build Variant Value	false		





Value Configuration Class	Pre-compile time	X	VARIANT-PRE-COMPILE
	Link time	X	VARIANT-LINK-TIME
	Post-build time	–	
Scope / Dependency	scope: local dependency: NmCoordinatorSyncSupport shall only be valid if NmCoordinatorSupport Enabled is TRUE.		

SWS Item	[ECUC_Nm_00246]		
Parameter Name	NmDynamicPncToChannelMappingSupport		
Parent Container	NmGlobalFeatures		
Description	Precompile time switch to enable the dynamic PNC-to-channel-mapping handling. False: Dynamic PNC-to-channel-mapping is disabled True: Dynamic PNC-to-channel-mapping is enabled Tags: atp.Status=draft		
Multiplicity	1		
Type	EcucBooleanParamDef		
Default value	–		
Post-Build Variant Value	false		
Value Configuration Class	Pre-compile time	X	All Variants
	Link time	–	
	Post-build time	–	
Scope / Dependency	scope: local		

SWS Item	[ECUC_Nm_00237]		
Parameter Name	NmGlobalCoordinatorTime		
Parent Container	NmGlobalFeatures		
Description	This parameter defines the maximum shutdown time of a connected and coordinated NM-Cluster. Note:This includes nested connections.		
Multiplicity	0..1		
Type	EcucFloatParamDef		
Range	[0 .. INF]		
Default value	–		
Post-Build Variant Multiplicity	false		
Post-Build Variant Value	false		
Multiplicity Configuration Class	Pre-compile time	X	All Variants
	Link time	–	
	Post-build time	–	
Value Configuration Class	Pre-compile time	X	All Variants
	Link time	–	
	Post-build time	–	
Scope / Dependency	scope: local dependency: NmGlobalCoordinatorTime shall only be valid if NmCoordinatorSupport Enabled is TRUE.		

SWS Item	[ECUC_Nm_00253]		
Parameter Name	NmPartialNetworkSupportEnabled		
Parent Container	NmGlobalFeatures		
Description	Pre-processor switch for enabling the Nm Partial Network support.		





Multiplicity	0..1		
Type	EcucBooleanParamDef		
Default value	false		
Multiplicity Configuration Class	Pre-compile time	X	VARIANT-PRE-COMPILE
	Link time	X	VARIANT-LINK-TIME
	Post-build time	–	
Value Configuration Class	Pre-compile time	X	VARIANT-PRE-COMPILE
	Link time	X	VARIANT-LINK-TIME
	Post-build time	–	
Scope / Dependency	scope: local dependency: This parameter can only be set to TRUE if NmCoordinatorSupport Enabled is set to FALSE.		

SWS Item	[ECUC_Nm_00214]		
Parameter Name	NmPduRxIndicationEnabled		
Parent Container	NmGlobalFeatures		
Description	Pre-processor switch for enabling the PDU Rx Indication.		
Multiplicity	1		
Type	EcucBooleanParamDef		
Default value	–		
Post-Build Variant Value	false		
Value Configuration Class	Pre-compile time	X	All Variants
	Link time	–	
	Post-build time	–	
Scope / Dependency	scope: local		

SWS Item	[ECUC_Nm_00207]		
Parameter Name	NmRemoteSleepIndEnabled		
Parent Container	NmGlobalFeatures		
Description	Pre-processor switch for enabling Remote Sleep Indication support. This feature is required for a Gateway or Nm Coordinator functionality. Note that this feature should not be used if all NM channels have Passive Mode enabled.		
Multiplicity	1		
Type	EcucBooleanParamDef		
Default value	–		
Post-Build Variant Value	false		
Value Configuration Class	Pre-compile time	X	All Variants
	Link time	–	
	Post-build time	–	
Scope / Dependency	scope: local dependency: If NmCoordinatorSupportEnabled == TRUE then NmRemoteSleepInd Enabled = TRUE		

SWS Item	[ECUC_Nm_00215]		
Parameter Name	NmStateChangeIndEnabled		
Parent Container	NmGlobalFeatures		
Description	Pre-processor switch for enabling the Network Management state change notification.		





Multiplicity	1		
Type	EcucBooleanParamDef		
Default value	-		
Post-Build Variant Value	false		
Value Configuration Class	Pre-compile time	X	All Variants
	Link time	-	
	Post-build time	-	
Scope / Dependency	scope: local dependency: NmStateChangeIndEnabled = TRUE if NmDynamicPncToChannelMappingSupport == TRUE		

SWS Item	[ECUC_Nm_00249]		
Parameter Name	NmSynchronizedPncShutdownEnabled		
Parent Container	NmGlobalFeatures		
Description	Enables or disables support of synchronized PNC shutdown. FALSE: synchronized PNC shutdown is disabled TRUE: synchronized PNC shutdown is enabled		
Multiplicity	0..1		
Type	EcucBooleanParamDef		
Default value	false		
Multiplicity Configuration Class	Pre-compile time	X	VARIANT-PRE-COMPILE
	Link time	X	VARIANT-LINK-TIME
	Post-build time	-	
Value Configuration Class	Pre-compile time	X	VARIANT-PRE-COMPILE
	Link time	X	VARIANT-LINK-TIME
	Post-build time	-	
Scope / Dependency	scope: local dependency: This parameter can only be set to TRUE if NmPartialNetworkSupportEnabled is set to TRUE.		

SWS Item	[ECUC_Nm_00211]		
Parameter Name	NmUserDataEnabled		
Parent Container	NmGlobalFeatures		
Description	Pre-processor switch for enabling User Data support.		
Multiplicity	1		
Type	EcucBooleanParamDef		
Default value	-		
Post-Build Variant Value	false		
Value Configuration Class	Pre-compile time	X	All Variants
	Link time	-	
	Post-build time	-	
Scope / Dependency	scope: local		

No Included Containers

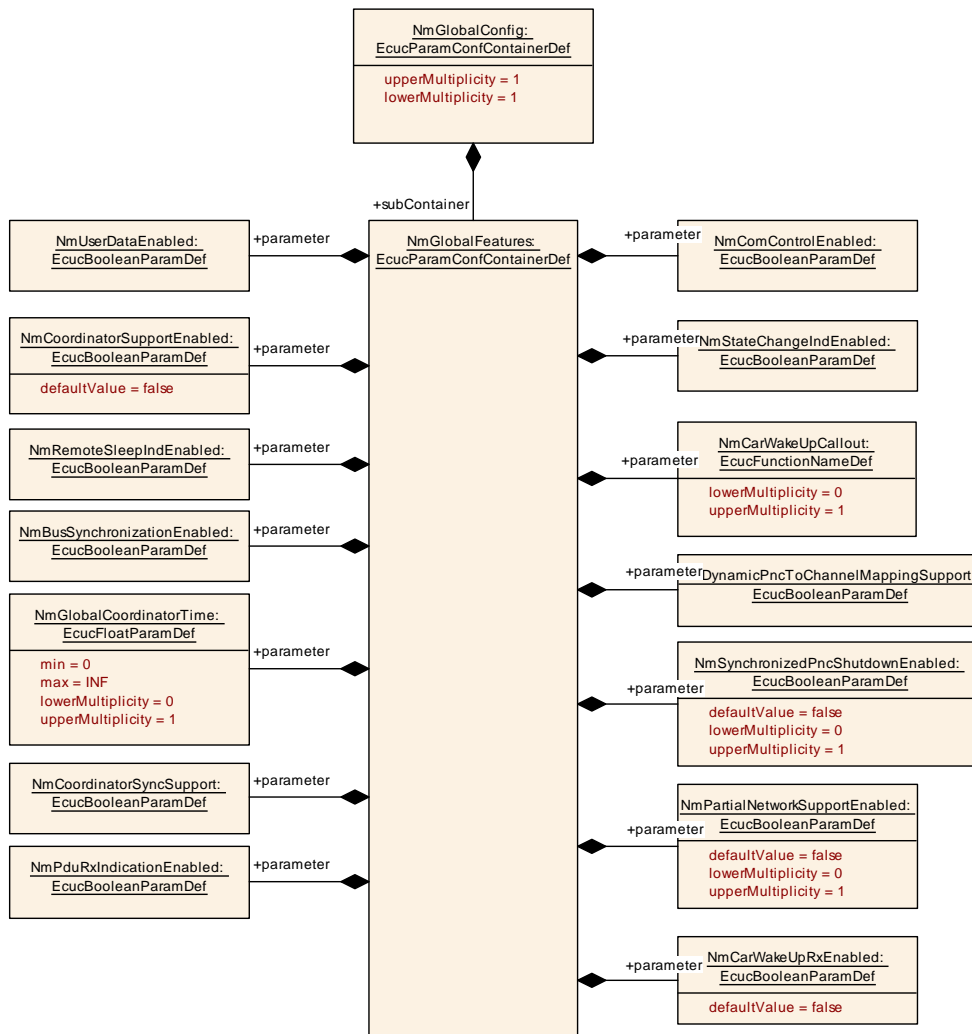

Figure 10.4: NmGlobalFeatures overview

10.4 Channel configurable parameters

10.4.1 NmChannelConfig

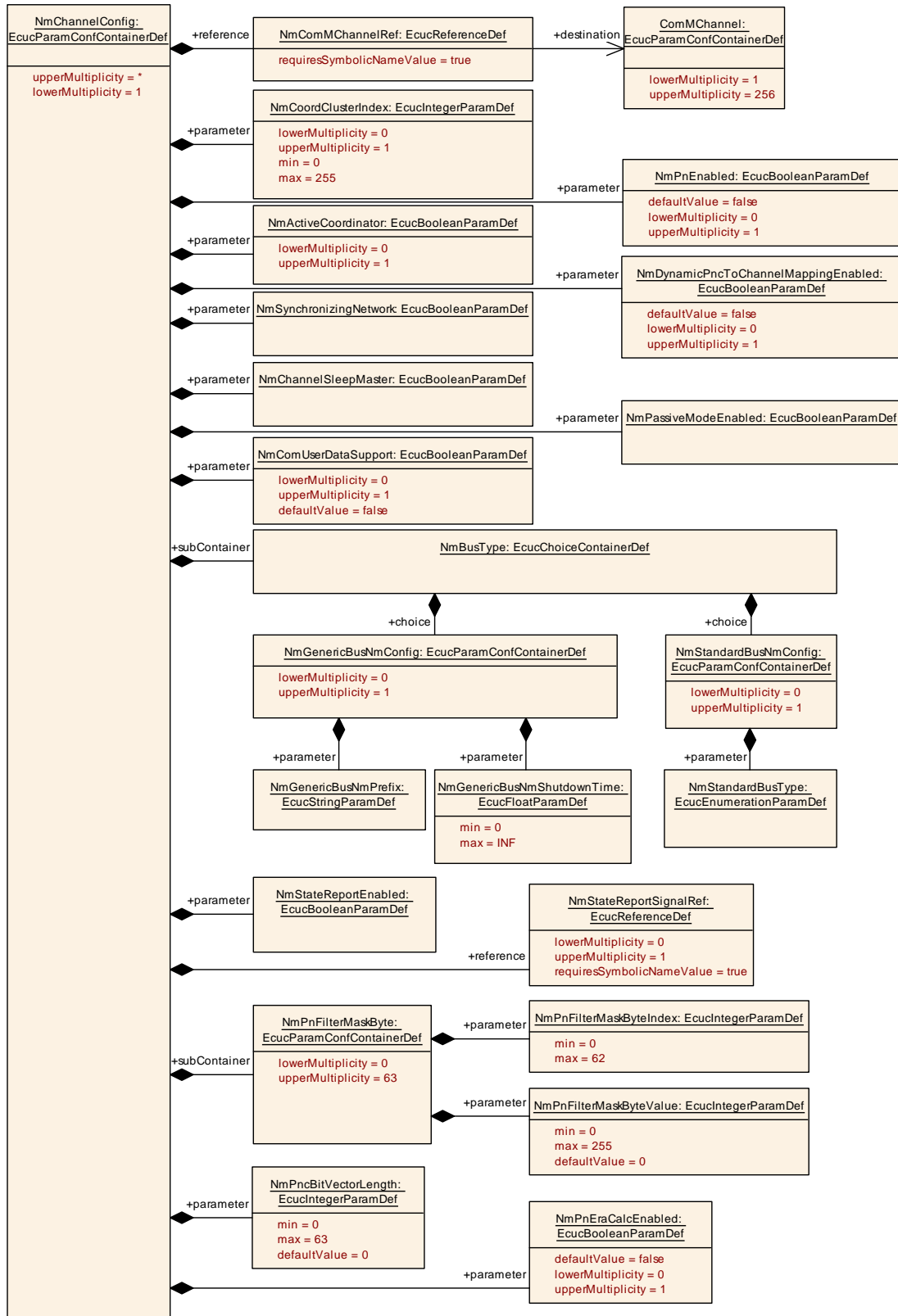

Figure 10.5: NmChannelConfig overview

SWS Item	[ECUC_Nm_00197]
Container Name	NmChannelConfig
Parent Container	Nm
Description	This container contains the configuration (parameters) of the bus channel(s). The channel parameter shall be harmonized within the whole communication stack.
Configuration Parameters	

SWS Item	[ECUC_Nm_00236]		
Parameter Name	NmActiveCoordinator		
Parent Container	NmChannelConfig		
Description	This parameter indicates whether a NM channel - part of a Nm Coordination cluster - will be coordinated actively (NmActiveCoordinator = TRUE) or passively (NmActiveCoordinator = FALSE).		
Multiplicity	0..1		
Type	EcucBooleanParamDef		
Default value	-		
Post-Build Variant Multiplicity	false		
Post-Build Variant Value	false		
Multiplicity Configuration Class	Pre-compile time	X	All Variants
	Link time	-	
	Post-build time	-	
Value Configuration Class	Pre-compile time	X	All Variants
	Link time	-	
	Post-build time	-	
Scope / Dependency	scope: local dependency: If the NmCoordinatorSyncSupport is set to true this feature is available. Only one channel per Coordination cluster can have NmActiveCoordinator = FALSE. This parameter is mandatory if this channel belongs to a Coordination cluster (see ECUC_Nm_00221). Value cannot be set to FALSE in case BusNmType is set to NM_BUSNM_LOCALNM (i.e. no passive coordination for this type).		

SWS Item	[ECUC_Nm_00227]		
Parameter Name	NmChannelSleepMaster		
Parent Container	NmChannelConfig		
Description	This parameter shall be set to indicate if the sleep of this network can be absolutely decided by the local node only and that no other nodes can oppose that decision. If this parameter is set to TRUE, the Nm shall assume that the channel is always ready to go to sleep and that no calls to Nm_RemoteSleepIndication or Nm_RemoteSleepCancellation will be made from the <Bus>Nm representing this channel. If this parameter is set to FALSE, the Nm shall not assume that the network is ready to sleep until a call has been made to Nm_RemoteSleepCancellation.		
Multiplicity	1		
Type	EcucBooleanParamDef		
Default value	-		
Post-Build Variant Value	false		
Value Configuration Class	Pre-compile time	X	VARIANT-PRE-COMPILE
	Link time	X	VARIANT-LINK-TIME
	Post-build time	-	





Scope / Dependency	scope: local dependency: If the parameter NmCoordClusterIndex is not defined, this parameter is not valid.
---------------------------	---

SWS Item	[ECUC_Nm_00241]		
Parameter Name	NmComUserDataSupport		
Parent Container	NmChannelConfig		
Description	This parameter indicates whether on a NM channel user data is accessed via Com signals or by SetUserData API.		
Multiplicity	0..1		
Type	EcucBooleanParamDef		
Default value	false		
Post-Build Variant Multiplicity	false		
Post-Build Variant Value	false		
Multiplicity Configuration Class	Pre-compile time	X	All Variants
	Link time	–	
	Post-build time	–	
Value Configuration Class	Pre-compile time	X	All Variants
	Link time	–	
	Post-build time	–	
Scope / Dependency	scope: local dependency: NmComUserDataSupport shall be equal to <Bus>NmComUserData Support		

SWS Item	[ECUC_Nm_00221]		
Parameter Name	NmCoordClusterIndex		
Parent Container	NmChannelConfig		
Description	If this parameter is undefined for a channel, the corresponding bus does not belong to an NM coordination cluster.		
Multiplicity	0..1		
Type	EcucIntegerParamDef		
Range	0 .. 255		
Default value	–		
Post-Build Variant Multiplicity	false		
Post-Build Variant Value	false		
Multiplicity Configuration Class	Pre-compile time	X	VARIANT-PRE-COMPILE
	Link time	X	VARIANT-LINK-TIME
	Post-build time	–	
Value Configuration Class	Pre-compile time	X	VARIANT-PRE-COMPILE
	Link time	X	VARIANT-LINK-TIME
	Post-build time	–	
Scope / Dependency	scope: local dependency: If NmCoordClusterIndex is defined than NmPassiveModeEnabled has to be FALSE for this channel.		

SWS Item	[ECUC_Nm_00248]		
Parameter Name	NmDynamicPncToChannelMappingEnabled		
Parent Container	NmChannelConfig		





Description	Channel-specific parameter to enable the dynamic PNC-to-channel-mapping feature. False: Dynamic PNC-to-channel-mapping is disabled True: Dynamic PNC-to-channel-mapping is enabled Tags: atp.Status=draft		
Multiplicity	0..1		
Type	EcucBooleanParamDef		
Default value	false		
Post-Build Variant Value	false		
Value Configuration Class	Pre-compile time	X	VARIANT-PRE-COMPILE
	Link time	X	VARIANT-LINK-TIME
	Post-build time	–	
Scope / Dependency	scope: local dependency: Shall only be TRUE if NmDynamicPncToChannelMappingSupport is TRUE		

SWS Item	[ECUC_Nm_00242]		
Parameter Name	NmPassiveModeEnabled		
Parent Container	NmChannelConfig		
Description	This parameter indicates whether a NM channel is active, e.g. can request communication and keep the bus awake, or passive, e.g. can just be woken up and kept awake by other ECUs.		
Multiplicity	1		
Type	EcucBooleanParamDef		
Default value	–		
Post-Build Variant Value	false		
Value Configuration Class	Pre-compile time	X	All Variants
	Link time	–	
	Post-build time	–	
Scope / Dependency	scope: local dependency: if ComMNMVariant == FULL then NmPassiveModeEnabled = FALSE; NmPassiveModeEnabled shall be equal to <Bus>NmPassiveModeEnabled		

SWS Item	[ECUC_Nm_00258]		
Parameter Name	NmPncBitVectorLength		
Parent Container	NmChannelConfig		
Description	Parameter to configure the length of the PNC bit request information in bytes, which is transmitted within NM PDU by the corresponding <Bus>Nm.		
Multiplicity	1		
Type	EcucIntegerParamDef		
Range	0 .. 63		
Default value	0		
Post-Build Variant Value	false		
Value Configuration Class	Pre-compile time	X	VARIANT-PRE-COMPILE
	Link time	X	VARIANT-LINK-TIME
	Post-build time	–	
Scope / Dependency	scope: ECU dependency: This parameter is only valid if NmPartialNetworkSupportEnabled is set to TRUE.		

SWS Item	[ECUC_Nm_00254]		
Parameter Name	NmPnEnabled		
Parent Container	NmChannelConfig		
Description	If this parameter is true, then this NM channel supports Partial Networking.		
Multiplicity	0..1		
Type	EcucBooleanParamDef		
Default value	false		
Multiplicity Configuration Class	Pre-compile time	X	VARIANT-PRE-COMPILE
	Link time	X	VARIANT-LINK-TIME
	Post-build time	–	
Value Configuration Class	Pre-compile time	X	VARIANT-PRE-COMPILE
	Link time	X	VARIANT-LINK-TIME
	Post-build time	–	
Scope / Dependency	scope: local dependency: This parameter is only valid if NmPartialNetworkSupportEnabled is set to TRUE.		

SWS Item	[ECUC_Nm_00259]		
Parameter Name	NmPnEraCalcEnabled		
Parent Container	NmChannelConfig		
Description	Specifies if NmIf calculates the PN request information for external requests. (ERA)		
Multiplicity	0..1		
Type	EcucBooleanParamDef		
Default value	false		
Multiplicity Configuration Class	Pre-compile time	X	VARIANT-PRE-COMPILE
	Link time	X	VARIANT-LINK-TIME
	Post-build time	–	
Value Configuration Class	Pre-compile time	X	VARIANT-PRE-COMPILE
	Link time	X	VARIANT-LINK-TIME
	Post-build time	–	
Scope / Dependency	scope: local dependency: This parameter is only valid if NmPartialNetworkSupportEnabled is set to TRUE.		

SWS Item	[ECUC_Nm_00231]		
Parameter Name	NmStateReportEnabled		
Parent Container	NmChannelConfig		
Description	Specifies if the NMS shall be set for the corresponding network. false: No NMS shall be set true: The NMS shall be set		
Multiplicity	1		
Type	EcucBooleanParamDef		
Default value	–		
Post-Build Variant Value	false		
Value Configuration Class	Pre-compile time	X	All Variants
	Link time	–	
	Post-build time	–	





Scope / Dependency	scope: local dependency: only available if NmStatChangeIndEnabled and NmComUserData Support are configured to TRUE.
---------------------------	--

SWS Item	[ECUC_Nm_00223]		
Parameter Name	NmSynchronizingNetwork		
Parent Container	NmChannelConfig		
Description	If this parameter is true, then this network is a synchronizing network for the NM coordination cluster which it belongs to. The network is expected to call Nm_SynchronizationPoint() at regular intervals.		
Multiplicity	1		
Type	EcucBooleanParamDef		
Default value	-		
Post-Build Variant Value	false		
Value Configuration Class	Pre-compile time	X	VARIANT-PRE-COMPILE
	Link time	X	VARIANT-LINK-TIME
	Post-build time	-	
Scope / Dependency	scope: local dependency: If the parameter NmCoordClusterIndex is not defined, this parameter is not valid. Only one network can be configured as synchronizing network (NmSynchronizingNetwork = TRUE) per coordination cluster (same NmCoordClusterIndex value per channel). NmSynchronizingNetwork can only be set to true if NmActiveCoordinator is true for all networks which have the same NmCoordClusterIndex.		

SWS Item	[ECUC_Nm_00217]		
Parameter Name	NmComMChannelRef		
Parent Container	NmChannelConfig		
Description	Reference to the corresponding ComM Channel.		
Multiplicity	1		
Type	Symbolic name reference to ComMChannel		
Post-Build Variant Value	false		
Value Configuration Class	Pre-compile time	X	VARIANT-PRE-COMPILE
	Link time	X	VARIANT-LINK-TIME
	Post-build time	-	
Scope / Dependency	scope: local		

SWS Item	[ECUC_Nm_00232]		
Parameter Name	NmStateReportSignalRef		
Parent Container	NmChannelConfig		
Description	Reference to the signal for setting the NMS by calling Com_SendSignal for the respective channel.		
Multiplicity	0..1		
Type	Symbolic name reference to ComSignal		
Post-Build Variant Multiplicity	false		
Post-Build Variant Value	false		
Multiplicity Configuration Class	Pre-compile time	X	All Variants
	Link time	-	
	Post-build time	-	
Value Configuration Class	Pre-compile time	X	All Variants





	Link time	–	
	Post-build time	–	
Scope / Dependency	scope: local dependency: Signal must be configured in COM. Only available if NmStateReport Enabled == true		

Included Containers		
Container Name	Multiplicity	Scope / Dependency
NmBusType	1	–
NmPnFilterMaskByte	0..63	Information for the filter of the PNC bit vector.

10.4.2 NmPnFilterMaskByte

SWS Item	[ECUC_Nm_00255]		
Container Name	NmPnFilterMaskByte		
Parent Container	NmChannelConfig		
Description	Information for the filter of the PNC bit vector.		
Multiplicity Configuration Class	Pre-compile time	X	VARIANT-PRE-COMPILE
	Link time	X	VARIANT-LINK-TIME
	Post-build time	–	
Configuration Parameters			

SWS Item	[ECUC_Nm_00256]		
Parameter Name	NmPnFilterMaskByteIndex		
Parent Container	NmPnFilterMaskByte		
Description	Index of the filter mask byte. Specifies the position within the filter mask byte array.		
Multiplicity	1		
Type	EcucIntegerParamDef		
Range	0 .. 62		
Default value	–		
Value Configuration Class	Pre-compile time	X	VARIANT-PRE-COMPILE
	Link time	X	VARIANT-LINK-TIME
	Post-build time	–	
Scope / Dependency	scope: local dependency: This parameter is only valid if NmPartialNetworkSupportEnabled is set to TRUE, NmPnFilterMaskByteIndex < NmPncBitVectorLength.		

SWS Item	[ECUC_Nm_00257]		
Parameter Name	NmPnFilterMaskByteValue		
Parent Container	NmPnFilterMaskByte		
Description	Parameter to configure the filter mask byte.		
Multiplicity	1		
Type	EcucIntegerParamDef		
Range	0 .. 255		





Default value	0		
Value Configuration Class	Pre-compile time	X	VARIANT-PRE-COMPILE
	Link time	X	VARIANT-LINK-TIME
	Post-build time	–	
Scope / Dependency	scope: local dependency: This parameter is only valid if NmPartialNetworkSupportEnabled is set to TRUE.		

No Included Containers

10.4.3 NmBusType

SWS Item	[ECUC_Nm_00218]
Choice Container Name	NmBusType
Parent Container	NmChannelConfig
Description	–

Container Choices		
Container Name	Multiplicity	Scope / Dependency
NmGenericBusNmConfig	0..1	–
NmStandardBusNmConfig	0..1	–

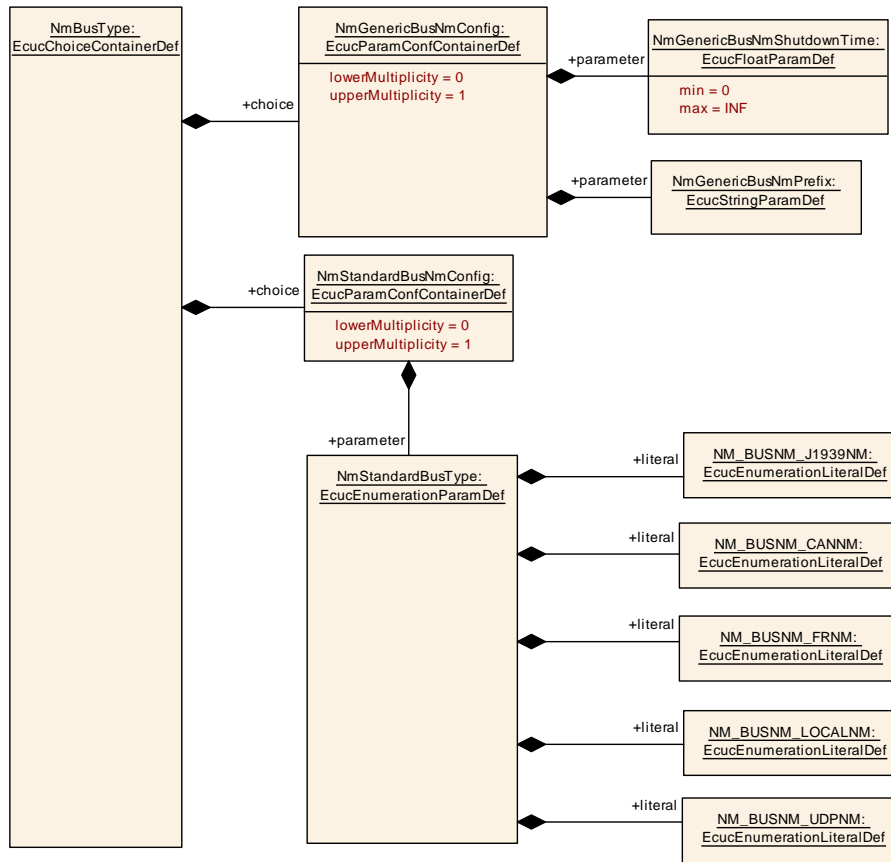

Figure 10.6: NmBusType overview

10.4.4 NmGenericBusNmConfig

SWS Item	[ECUC_Nm_00225]
Container Name	NmGenericBusNmConfig
Parent Container	NmBusType
Description	–
Configuration Parameters	

SWS Item	[ECUC_Nm_00219]
Parameter Name	NmGenericBusNmPrefix
Parent Container	NmGenericBusNmConfig
Description	The prefix which identifies the generic <Bus>Nm. This will be used to determine the API name to be called by Nm for the provided interfaces of the <Bus>Nm. This string will be used for the module prefix before the "_" character in the API call name.
Multiplicity	1
Type	EcucStringParamDef
Default value	–
Regular Expression	–
Post-Build Variant Value	false





Value Configuration Class	Pre-compile time	X	VARIANT-PRE-COMPILE
	Link time	X	VARIANT-LINK-TIME
	Post-build time	–	
Scope / Dependency	scope: local		

SWS Item	[ECUC_Nm_00239]		
Parameter Name	NmGenericBusNmShutdownTime		
Parent Container	NmGenericBusNmConfig		
Description	This parameter shall be used to calculate shutdown delay time.		
Multiplicity	1		
Type	EcucFloatParamDef		
Range	[0 .. INF]		
Default value	–		
Post-Build Variant Value	false		
Value Configuration Class	Pre-compile time	X	VARIANT-PRE-COMPILE
	Link time	X	VARIANT-LINK-TIME
	Post-build time	–	
Scope / Dependency	scope: local		

No Included Containers

10.4.5 NmStandardBusNmConfig

SWS Item	[ECUC_Nm_00226]		
Container Name	NmStandardBusNmConfig		
Parent Container	NmBusType		
Description	–		
Configuration Parameters			

SWS Item	[ECUC_Nm_00220]		
Parameter Name	NmStandardBusType		
Parent Container	NmStandardBusNmConfig		
Description	Identifies the bus type of the channel for standard AUTOSAR <Bus>Nms and is used to determine which set of API calls to be called by Nm for the <Bus>Nms. Note: The Ethernet bus' NM is UdpNm !		
Multiplicity	1		
Type	EcucEnumerationParamDef		
Range	NM_BUSNM_CANNM	CAN bus	
	NM_BUSNM_FRNM	FlexRay bus	
	NM_BUSNM_J1939NM	J1939 bus (address claiming)	
	NM_BUSNM_LOCALNM	Local Bus (e.g. LIN bus)	
	NM_BUSNM_UDPNM	Ethernet bus (using UDP)	
Post-Build Variant Value	false		
Value Configuration Class	Pre-compile time	X	VARIANT-PRE-COMPILE





	Link time	X	VARIANT-LINK-TIME
	Post-build time	–	
Scope / Dependency	scope: local dependency: Configuring value to NM_BUSNM_LOCALNM is only allowed if NmCoord ClusterIndex for the corresponding channel is defined (i.e channel is coordinated).		

No Included Containers

10.5 Published Information

For details refer to the chapter 10.3 “Published Information” in [2, SWS_BSWGeneral].

A Not applicable requirements

[SWS_Nm_NA_00999] Not applicable requirements [These requirements are not applicable to this specification.] (*RS_Nm_00043, RS_Nm_00137, RS_Nm_00142, RS_Nm_00144, RS_Nm_00145, RS_Nm_00146, RS_Nm_00152, RS_Nm_02517, RS_Nm_02550, RS_Nm_02519, SRS_BSW_00004, SRS_BSW_00005, SRS_BSW_00006, SRS_BSW_00007, SRS_BSW_00009, SRS_BSW_00010, SRS_BSW_00160, SRS_BSW_00161, SRS_BSW_00162, SRS_BSW_00164, SRS_BSW_00167, SRS_BSW_00168, SRS_BSW_00170, SRS_BSW_00172, SRS_BSW_00300, SRS_BSW_00302, SRS_BSW_00304, SRS_BSW_00305, SRS_BSW_00306, SRS_BSW_00307, SRS_BSW_00308, SRS_BSW_00309, SRS_BSW_00310, SRS_BSW_00312, SRS_BSW_00314, SRS_BSW_00318, SRS_BSW_00321, SRS_BSW_00325, SRS_BSW_00328, SRS_BSW_00331, SRS_BSW_00334, SRS_BSW_00335, SRS_BSW_00336, SRS_BSW_00339, SRS_BSW_00341, SRS_BSW_00342, SRS_BSW_00343, SRS_BSW_00346, SRS_BSW_00347, SRS_BSW_00350, SRS_BSW_00351, SRS_BSW_00360, SRS_BSW_00374, SRS_BSW_00375, SRS_BSW_00377, SRS_BSW_00378, SRS_BSW_00379, SRS_BSW_00380, SRS_BSW_00383, SRS_BSW_00388, SRS_BSW_00389, SRS_BSW_00390, SRS_BSW_00392, SRS_BSW_00393, SRS_BSW_00394, SRS_BSW_00395, SRS_BSW_00397, SRS_BSW_00398, SRS_BSW_00399, SRS_BSW_00400, SRS_BSW_00401, SRS_BSW_00402, SRS_BSW_00403, SRS_BSW_00404, SRS_BSW_00406, SRS_BSW_00408, SRS_BSW_00409, SRS_BSW_00410, SRS_BSW_00411, SRS_BSW_00413, SRS_BSW_00415, SRS_BSW_00416, SRS_BSW_00417, SRS_BSW_00422, SRS_BSW_00423, SRS_BSW_00426, SRS_BSW_00427, SRS_BSW_00428, SRS_BSW_00429, SRS_BSW_00432, SRS_BSW_00433, SRS_BSW_00437, SRS_BSW_00438, SRS_BSW_00439, SRS_BSW_00440, SRS_BSW_00441, SRS_BSW_00447, SRS_BSW_00448, SRS_BSW_00449, SRS_BSW_00451, SRS_BSW_00452, SRS_BSW_00453, SRS_BSW_00454, SRS_BSW_00456, SRS_BSW_00457, SRS_BSW_00458, SRS_BSW_00460, SRS_BSW_00461, SRS_BSW_00462, SRS_BSW_00463, SRS_BSW_00464, SRS_BSW_00465, SRS_BSW_00466, SRS_BSW_00467, SRS_BSW_00469, SRS_BSW_00470, SRS_BSW_00471, SRS_BSW_00472, SRS_BSW_00473, SRS_BSW_00396, SRS_BSW_00477, SRS_BSW_00479, SRS_BSW_00480, SRS_BSW_00481*)

B Change history of AUTOSAR traceable items

Please note that the lists in this chapter also include traceable items that have been removed from the specification in a later version. These items do not appear as hyperlinks in the document.

B.1 Traceable item history of this document according to AUTOSAR Release R22-11

B.1.1 Added Specification Items in R22-11

Number	Heading
[SWS_Nm_00521]	
[SWS_Nm_00523]	
[SWS_Nm_00524]	
[SWS_Nm_00525]	
[SWS_Nm_00527]	
[SWS_Nm_00529]	
[SWS_Nm_00530]	
[SWS_Nm_00532]	
[SWS_Nm_00533]	
[SWS_Nm_00534]	
[SWS_Nm_00535]	
[SWS_Nm_00536]	
[SWS_Nm_00537]	
[SWS_Nm_91010]	
[SWS_Nm_91011]	
[SWS_Nm_NA_-00999]	Not applicable requirements

Table B.1: Added Specification Items in R22-11

B.1.2 Changed Specification Items in R22-11

Number	Heading
[SWS_Nm_00030]	
[SWS_Nm_00031]	
[SWS_Nm_00032]	





Number	Heading
[SWS_Nm_00033]	
[SWS_Nm_00034]	
[SWS_Nm_00035]	
[SWS_Nm_00036]	
[SWS_Nm_00037]	
[SWS_Nm_00038]	
[SWS_Nm_00039]	
[SWS_Nm_00040]	
[SWS_Nm_00042]	
[SWS_Nm_00043]	
[SWS_Nm_00044]	
[SWS_Nm_00046]	
[SWS_Nm_00112]	
[SWS_Nm_00114]	
[SWS_Nm_00117]	
[SWS_Nm_00118]	
[SWS_Nm_00119]	
[SWS_Nm_00124]	
[SWS_Nm_00154]	
[SWS_Nm_00156]	
[SWS_Nm_00159]	
[SWS_Nm_00162]	
[SWS_Nm_00166]	
[SWS_Nm_00176]	
[SWS_Nm_00183]	
[SWS_Nm_00192]	
[SWS_Nm_00193]	
[SWS_Nm_00194]	
[SWS_Nm_00230]	
[SWS_Nm_00232]	
[SWS_Nm_00234]	
[SWS_Nm_00235]	
[SWS_Nm_00236]	
[SWS_Nm_00245]	
[SWS_Nm_00250]	
[SWS_Nm_00254]	
[SWS_Nm_00259]	
[SWS_Nm_00261]	
[SWS_Nm_00267]	





Number	Heading
[SWS_Nm_00271]	
[SWS_Nm_00272]	
[SWS_Nm_00274]	
[SWS_Nm_00275]	
[SWS_Nm_00276]	
[SWS_Nm_00282]	
[SWS_Nm_00291]	
[SWS_Nm_00293]	
[SWS_Nm_00302]	
[SWS_Nm_00305]	
[SWS_Nm_00308]	
[SWS_Nm_00310]	
[SWS_Nm_00311]	
[SWS_Nm_00312]	
[SWS_Nm_00313]	
[SWS_Nm_00317]	
[SWS_Nm_00318]	
[SWS_Nm_00319]	
[SWS_Nm_00320]	
[SWS_Nm_00321]	
[SWS_Nm_00322]	
[SWS_Nm_00323]	
[SWS_Nm_00324]	
[SWS_Nm_00325]	
[SWS_Nm_00326]	
[SWS_Nm_00327]	
[SWS_Nm_00328]	
[SWS_Nm_00329]	
[SWS_Nm_00330]	
[SWS_Nm_00331]	
[SWS_Nm_00501]	
[SWS_Nm_00502]	
[SWS_Nm_00503]	
[SWS_Nm_00504]	
[SWS_Nm_00505]	
[SWS_Nm_00508]	
[SWS_Nm_91002]	
[SWS_Nm_91003]	
[SWS_Nm_91005]	





Number	Heading
[SWS_Nm_91006]	
[SWS_Nm_91007]	
[SWS_Nm_91008]	
[SWS_Nm_91009]	
[SWS_Nm_- CONSTR_00001]	

Table B.2: Changed Specification Items in R22-11

B.1.3 Deleted Specification Items in R22-11

Number	Heading
[SWS_Nm_00314]	
[SWS_Nm_00332]	
[SWS_Nm_00506]	
[SWS_Nm_00507]	
[SWS_Nm_00999]	Not applicable requirements

Table B.3: Deleted Specification Items in R22-11

B.1.4 Added Constraints in R22-11

none

B.1.5 Changed Constraints in R22-11

none

B.1.6 Deleted Constraints in R22-11

none

B.2 Traceable item history of this document according to AUTOSAR Release R23-11

B.2.1 Added Specification Items in R23-11

Number	Heading
[SWS_Nm_00509]	Definiton of network management states in Nm module

Table B.4: Added Specification Items in R23-11

B.2.2 Changed Specification Items in R23-11

Number	Heading
[SWS_Nm_00312]	
[SWS_Nm_91003]	Definition of API function Nm_PnLearningRequest
[SWS_Nm_91005]	Definition of API function Nm_RequestSynchronizedPncShutdown

Table B.5: Changed Specification Items in R23-11

B.2.3 Deleted Specification Items in R23-11

Number	Heading
[SWS_Nm_00310]	
[SWS_Nm_00311]	

Table B.6: Deleted Specification Items in R23-11

B.2.4 Added Constraints in R23-11

none

B.2.5 Changed Constraints in R23-11

none

B.2.6 Deleted Constraints in R23-11

none