

| | |
|-----------------------------------|------------------------------------|
| Document Title | Specification of Health Monitoring |
| Document Owner | AUTOSAR |
| Document Responsibility | AUTOSAR |
| Document Identification No | 850 |

| | |
|---------------------------------|------------|
| Document Status | published |
| Part of AUTOSAR Standard | Foundation |
| Part of Standard Release | R22-11 |

| Document Change History | | | |
|--------------------------------|----------------|----------------------------|---|
| Date | Release | Changed by | Description |
| 2022-11-24 | R22-11 | AUTOSAR Release Management | <ul style="list-style-type: none"> Introduced Elementary Supervision Status for Adaptive platform Determination of Supervision Status is now platform specific |
| 2021-11-25 | R21-11 | AUTOSAR Release Management | <ul style="list-style-type: none"> Add Application Interfaces for SystemHealthMonitoring Add Mode Dependent Configuration |
| 2020-11-30 | R20-11 | AUTOSAR Release Management | <ul style="list-style-type: none"> Change document type from SWS to ASWS Remove arbitration rules and actions Remove HealthChannel supervision Add SystemHealthMonitoring Remove spec item numbers from API chapter |
| 2019-11-28 | R19-11 | AUTOSAR Release Management | <ul style="list-style-type: none"> Clarifications in specification of supervisions Deleted parameter "number of instances" from HealthChannel and SupervisedEntity Removed SWS_HM_00071 Changed Document Status from Final to published |

| | | | |
|------------|-------|----------------------------------|---|
| 2019-03-29 | 1.5.1 | AUTOSAR Release Management | <ul style="list-style-type: none"> ● Updated acronyms table ● Added chapter with not applicable requirements ● Added SWS_HM_00460 and SWS_HM_00461 ● Updated traceability to requirements of RS Health Monitoring ● Moved figures out of requirement trace items |
| 2018-10-29 | 1.5.0 | AUTOSAR Release Management | <ul style="list-style-type: none"> ● Added API for retrieving supervision status ● Clarified error recovery actions ● Modified parameter configuration ● Several editorial changes |
| 2018-03-29 | 1.4.0 | AUTOSAR Release Management | <ul style="list-style-type: none"> ● Initial release as "draft" |

Disclaimer

This work (specification and/or software implementation) and the material contained in it, as released by AUTOSAR, is for the purpose of information only. AUTOSAR and the companies that have contributed to it shall not be liable for any use of the work.

The material contained in this work is protected by copyright and other types of intellectual property rights. The commercial exploitation of the material contained in this work requires a license to such intellectual property rights.

This work may be utilized or reproduced without any modification, in any form or by any means, for informational purposes only. For any other purpose, no part of the work may be utilized or reproduced, in any form or by any means, without permission in writing from the publisher.

The work has been developed for automotive applications only. It has neither been developed, nor tested for non-automotive applications.

The word AUTOSAR and the AUTOSAR logo are registered trademarks.

Contents

| | | |
|---------|---|----|
| 1 | Introduction and functional overview | 6 |
| 1.1 | Input documents and related standards and norms | 6 |
| 2 | Acronyms and abbreviations | 7 |
| 3 | Related documentation | 10 |
| 4 | Constraints and assumptions | 11 |
| 4.1 | Limitations and conditions of use | 11 |
| 4.2 | Applicability to car domains | 11 |
| 5 | Requirements Tracing | 12 |
| 6 | Functional specification | 14 |
| 6.1 | Functional Overview | 14 |
| 6.1.1 | Functional Interfaces | 14 |
| 6.1.2 | Basic concepts - Supervised EntityS, CheckpointS, GraphS, Supervision Mode | 15 |
| 6.1.3 | Execution of Supervision Functions | 16 |
| 6.1.3.1 | Alive Supervision | 16 |
| 6.1.3.2 | Deadline Supervision | 17 |
| 6.1.3.3 | Logical Supervision | 17 |
| 6.1.4 | Determination of Supervision Status | 17 |
| 6.1.4.1 | Rule Pocessing | 18 |
| 6.1.4.2 | Watchdog Control | 18 |
| 6.1.4.3 | Error Handling | 18 |
| 6.1.5 | Functional Decomposition | 18 |
| 6.2 | Execution of Supervision Functions and Determination of Supervision Results | 19 |
| 6.2.1 | Alive Supervision | 20 |
| 6.2.1.1 | Alive Supervision Configuration | 20 |
| 6.2.1.2 | Alive Supervision Algorithm | 22 |
| 6.2.2 | Deadline Supervision | 23 |
| 6.2.2.1 | Deadline Supervision Configuration | 23 |
| 6.2.2.2 | Deadline Supervision Algorithm | 24 |
| 6.2.3 | Logical Supervision | 25 |
| 6.2.3.1 | Logical Supervision Configuration | 25 |
| 6.2.3.2 | Logical Supervision Algorithm | 27 |
| 6.3 | System Health Monitoring | 29 |
| 6.3.1 | System Health Monitoring Architecture | 29 |
| 6.3.2 | Concept of Health Indicator | 31 |
| 6.3.3 | Application interfaces | 32 |
| 6.3.4 | Usage of HealthIndicators | 32 |
| 7 | Health Monitoring API specification | 34 |

| | | |
|-------|---|----|
| 7.1 | Provided API | 34 |
| 7.1.1 | Reporting Checkpoints | 34 |
| 7.1.2 | Reporting health status | 34 |
| 7.1.3 | Forwarding information between health monitoring components | 34 |
| 7.1.4 | Init / Delnit | 34 |
| 7.1.5 | Retrieving Supervision Status from application | 35 |
| 7.2 | Assumed API | 35 |
| 7.2.1 | Triggering error handling | 35 |
| 7.2.2 | Controlling watchdog | 35 |
| 8 | Configuration Parameters | 36 |
| 8.1 | Overall configuration | 36 |
| 8.2 | Mode-independent settings | 38 |
| 8.2.1 | Supervised Entity | 38 |
| 8.3 | Mode-dependent settings | 39 |
| 8.3.1 | Alive Supervision | 39 |
| 8.3.2 | Deadline Supervision | 40 |
| 8.3.3 | Logical Supervision | 40 |
| 8.3.4 | Global Supervision | 41 |
| 9 | Service Interfaces | 42 |
| 9.1 | Type definitions | 42 |
| 9.2 | Provided Service Interfaces | 44 |
| 9.2.1 | HealthIndicator | 44 |
| 9.2.2 | HealthInfo | 45 |

1 Introduction and functional overview

1.1 Input documents and related standards and norms

This document specifies the functionality on the [Health Monitoring](#) and System Health Monitoring.

[Health Monitoring](#) is required by [1, ISO 26262] (under the terms control flow monitoring, external monitoring facility, watchdog, logical monitoring, temporal monitoring, program sequence monitoring) and this specification is supposed to address all relevant requirements from this standard.

Health monitoring has the following error detection functions:

1. [Alive Supervision](#) - checking if [Checkpoints](#) happens with a correct frequency
2. [Deadline Supervision](#) - checking the delta time between two [Checkpoints](#)
3. [Logical Supervision](#) - checking for correct sequence of execution of [Checkpoints](#)

The [Health Monitoring](#) is supposed to be implemented by AUTOSAR classic platform and AUTOSAR adaptive platform. It may be implemented by other platforms as well.

The [Health Monitoring](#) requirements are specified in [2, RS HealthMonitoring].

The System Health Monitoring introduces platform agnostic health monitoring. It aims to abstract the health monitoring on a system level by sharing of health information between different Adaptive, Classic or non-AUTOSAR platforms. The health information shall be shared between different platforms using a standardized format of [Health Indicators](#). The abstract interfaces for exchanging the health information across several platforms are provided in this document.

2 Acronyms and abbreviations

The glossary below includes acronyms and abbreviations relevant to Health Monitoring that are not included in the AUTOSAR Glossary [3].

| Abbreviation / Acronym: | Description: |
|-------------------------------|---|
| Alive Indication | An indication of a Supervised Entity to signal its aliveness by calling a checkpoint used for Alive Supervision . |
| Alive Supervision | Kind of supervision that checks if a Supervised Entity executed in a correct frequency. |
| Checkpoint | A point in the control flow of a Supervised Entity where the activity is reported. |
| Deadline Supervision | Kind of supervision that checks if the execution time between two Checkpoints is within minimum/maximum time limit. |
| Elementary Supervision Status | Status that represents the current state of an Alive Supervision , Deadline Supervision or Logical Supervision , based on the evaluation (correct/incorrect) of the supervision. |
| Final Checkpoint | The ending Checkpoint of a Graph. There can be zero or more Final Checkpoints for each Graph. |
| Global Supervision Status | Cumulative Supervision Status. In Classic Platform, it summarizes the Local Supervision Status of all Supervised Entities. In Adaptive Platform, it is calculated based on a set of Elementary Supervision Status within a single Function Group. |
| Graph | A set of Checkpoints connected through Transitions, where at least one of Checkpoints is an Initial Checkpoint. There is a path (through Transitions) between any two Checkpoints of the Graph. |
| Health Channel | Channel providing information about the health status of a (sub)system. This might be the Global Supervision Status of an application, the result any test routine or the status reported by a (sub)system (e.g. voltage monitoring, OS kernel, ECU status, ...). |
| Health Channel Supervision | Kind of supervision that checks if the health indicators registered by the supervised software are within the tolerances/limits. |
| Health Monitoring | Supervision of the software behaviour for correct timing and sequence. |
| Health Status | A set of states that are relevant to the supervised software (e.g. a Voltage State, an application state, the result of a RAM monitoring algorithm). |

| | |
|----------------------------|--|
| Health Status Supervision | Check if the health indicators registered by the supervised software are within the tolerances/limits. |
| Initial Checkpoint | The starting Checkpoint of a Graph. There can be one or more Initial Checkpoints for each Graph. |
| Logical Supervision | Kind of online supervision of software that checks if the software (Supervised Entity or set of Supervised Entities) is executed in the sequence defined by the programmer (by the developed code). |
| Local Supervision Status | Status that represents the current result of Alive Supervision, Deadline Supervision and Logical Supervision of a single Supervised Entity. |
| Machine | see [3] AUTOSAR Glossary |
| Platform Health Management | Health Monitoring for the Adaptive Platform |
| Supervised Entity | A whole or part of a software component type which is included in the supervision. A Supervised Entity denotes a collection of Checkpoints within the corresponding software component type. A software component type can include zero, one or more Supervised Entities. A Supervised Entity may be instantiated multiple times, in which case each instance is independently supervised. |
| Supervision Mode | An overall state of a microcontroller or virtual machine or state of a Function Group (in case of Adaptive Platform). Modes are mutually exclusive. A mode can be e.g. Startup, Shutdown, Low power. |
| Health Indicator | Health Indicator provides an evaluation metric of current system performance with regard to safety requirements. |
| System Health Monitor(SHM) | System Health Monitor is responsible for monitoring the health of a (Sub)-system. It provides Health Indicators that can be used for system wide error handling across several Classic, Adaptive and any third party platforms. |
| Local Health Monitor | Local Health Monitor gathers health information of the platform on which it is deployed. |
| Health Indicator Interface | Health Indicator Interface is an interface used for communication of Health Indicators using a standardized service field. |
| SE | Supervised Entity. |
| SOTIF | Safety Of The Intended Functionality [4]. |
| Performance | The Performance rates the performance with respect to malfunctioning behavior. |

| | |
|-------------|--|
| Reliability | Reliability evaluates how much to trust the system due to uncertainties. |
|-------------|--|

Table 2.1: Acronyms

3 Related documentation

References

- [1] ISO 26262:2018 (all parts) – Road vehicles – Functional Safety
<http://www.iso.org>
- [2] Requirements on Health Monitoring
AUTOSAR_RS_HealthMonitoring
- [3] Glossary
AUTOSAR_TR_Glossary
- [4] ISO/PAS 21448:2019 – Road vehicles – Safety of the intended functionality
<http://www.iso.org>
- [5] Specification of Watchdog Manager
AUTOSAR_SWS_WatchdogManager
- [6] Specification of Platform Health Management
AUTOSAR_SWS_PlatformHealthManagement
- [7] Explanation of System Health Monitoring
AUTOSAR_EXP_SystemHealthMonitoring

4 Constraints and assumptions

4.1 Limitations and conditions of use

The logic for determination of [Health Indicator](#) values is not standardized as a part of AUTOSAR.

4.2 Applicability to car domains

No restrictions.

5 Requirements Tracing

| Requirement | Description | Satisfied by |
|---------------|---|---|
| [RS_HM_09125] | Health Monitoring shall provide an Alive Supervision | [ASWS_HM_00074] [ASWS_HM_00083] [ASWS_HM_00098] |
| [RS_HM_09163] | Health Monitoring shall provide configurable tolerances for detected errors and configurable delays of error reactions. | [ASWS_HM_00075] [ASWS_HM_00079] |
| [RS_HM_09222] | Health Monitoring shall provide a Logical Supervision | [ASWS_HM_00252] [ASWS_HM_00271] [ASWS_HM_00273] [ASWS_HM_00295] [ASWS_HM_00296] [ASWS_HM_00297] [ASWS_HM_00331] |
| [RS_HM_09235] | Health Monitoring shall provide a Deadline Supervision | [ASWS_HM_00228] [ASWS_HM_00229] [ASWS_HM_00294] [ASWS_HM_00299] [ASWS_HM_00354] |
| [RS_HM_09242] | Health Monitoring shall support the supervision within and across Supervised Entities. | [ASWS_HM_00460] |
| [RS_HM_09243] | Health Monitoring shall support the supervision of concurrent and parallel Supervised Entities. | [ASWS_HM_00461] |
| [RS_HM_09249] | Health Monitoring shall support building safety-related systems. | [ASWS_HM_00074] [ASWS_HM_00083] [ASWS_HM_00098] [ASWS_HM_00228] [ASWS_HM_00229] [ASWS_HM_00252] [ASWS_HM_00271] [ASWS_HM_00273] [ASWS_HM_00294] [ASWS_HM_00295] [ASWS_HM_00296] [ASWS_HM_00297] [ASWS_HM_00299] [ASWS_HM_00331] [ASWS_HM_00354] [ASWS_HM_00460] [ASWS_HM_00461] |
| [RS_HM_09300] | System Health Monitor shall transmit Health Indicators as standardized service events | [ASWS_HM_00510] |
| [RS_HM_09301] | SHM shall receive relevant health information from local health monitors | [ASWS_HM_00501] [ASWS_HM_00513] |
| [RS_HM_09302] | Communication between SHM and local health monitors shall be E2E protected | [ASWS_HM_00503] |

| Requirement | Description | Satisfied by |
|---------------|---|---|
| [RS_HM_09303] | SHM shall be platform agnostic | [ASWS_HM_00501] [ASWS_HM_00502] [ASWS_HM_00503] [ASWS_HM_00504] [ASWS_HM_00505] [ASWS_HM_00506] [ASWS_HM_00509] [ASWS_HM_00510] [ASWS_HM_00511] [ASWS_HM_00512] [ASWS_HM_00513] [ASWS_HM_00514] [ASWS_HM_00515] [ASWS_HM_00516] [ASWS_HM_00517] [ASWS_HM_00518] [ASWS_HM_00519] [ASWS_HM_00520] [ASWS_HM_00521] [ASWS_HM_00522] [ASWS_HM_00523] |
| [RS_HM_09304] | SHM shall determine Health Indicators. | [ASWS_HM_00501] [ASWS_HM_00504] |
| [RS_HM_09305] | SHM should support redundancy concepts | [ASWS_HM_00504] [ASWS_HM_00505] |
| [RS_HM_09308] | Communication between SHM instances shall be E2E protected | [ASWS_HM_00506] |
| [RS_HM_09309] | Cyclic communication between SHM and local health monitors shall be used for aliveness checks | [ASWS_HM_00502] [ASWS_HM_00509] |
| [RS_HM_09310] | Cyclic communication between SHM instances shall be used for aliveness checks | [ASWS_HM_00509] |

6 Functional specification

6.1 Functional Overview

This section presents black-box functional overview of the [Health Monitoring](#). It does not define any requirements nor details on the functionality.

6.1.1 Functional Interfaces

The [Health Monitoring](#) supervises the execution of a configurable number of [Supervised Entitys](#) and it also supervises their [Health Status](#). When it detects a violation of the configured temporal and/or logical constraints on program execution or a violation of the configured health constraints, it triggers the appropriate error handlers. [Health Monitoring](#) controls also the Watchdogs correspondingly, see [Figure 6.1](#).

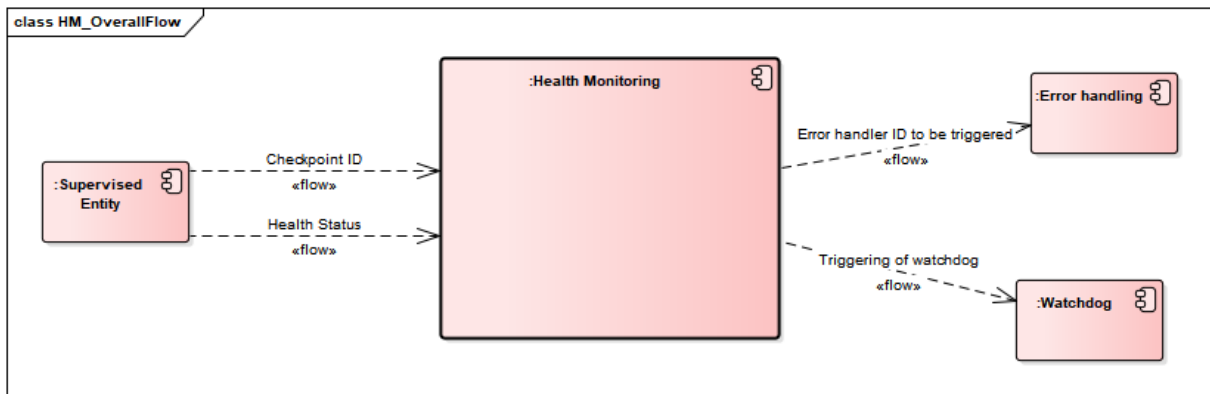

Figure 6.1: Scope of [Health Monitoring](#)

The [Health Monitoring](#) function can be split as a daisy chain. Each [Health Monitoring](#) instance has the same interface to [Supervised Entitys](#), [Error handling](#) and [Watchdog](#). In addition, the interface between the instances of [Health Monitoring](#) is standardized as well - it carries the results of [Health Monitoring](#) as well as "raw data" (Checkpoint IDs, Health Status together with necessary context information). Each instance adds some context-specific data to [Checkpoints](#) (e.g. process/task id).

In the example below ([Figure 6.2](#)), there are three instances of [Health Monitoring](#), each having different usage scenarios.

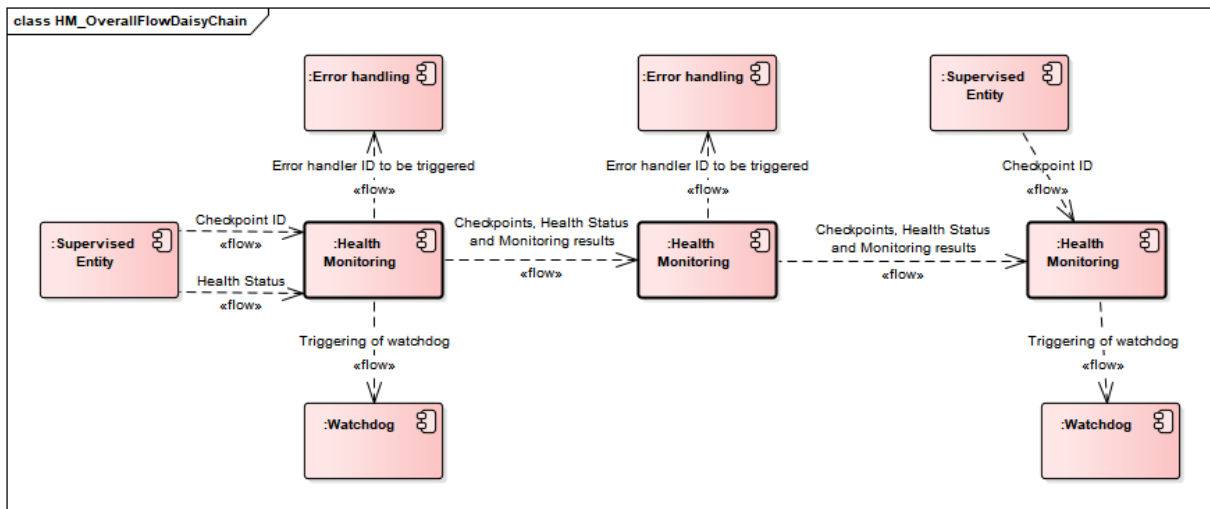

Figure 6.2: Scope of Health Monitoring Daisy Chain example

The data exchanged between `Health Monitoring` instances is configurable.

These are known use cases for `Health Monitoring` instances:

- The first instance is typically the same process/executable/application as the `Supervised Entity`.
- Further instance(s) can be realized as services/daemons on the microcontroller
- Further or final instance can be realized on a remote machine.

A `SystemHealthMonitor` is responsible for combining health information of different platforms and calculate `Health Indicators` on different abstraction levels. These `Health Indicators` can then be used within the platform for stabilizing the system or enhancing services with some kind of Health of Service. The `SystemHealthMonitor` is defined as a platform agnostic component which could be deployed anywhere in the system.

6.1.2 Basic concepts - `Supervised Entitys`, `Checkpoints`, `Graphs`, `Supervision Mode`

The `Health Monitoring` supervises the execution of software. The logical units of supervision are `Checkpoints` that belong to `Supervised Entitys`. There is no fixed relationship between `Supervised Entitys` and the architectural building blocks software, but typically a `Supervised Entity` may represent one software component.

The `Checkpoints` and Transitions between the `Checkpoints` form a Graph. The `Checkpoints` of a graph can belong to the same `Supervised Entity` or to different `Supervised Entitys`.

[ASWS_HM_00460] [The [Health Monitoring](#) shall supervise graphs with checkpoints belonging to the same or different [Supervised Entitys](#).] ([RS_HM_09242](#), [RS_HM_09249](#))

[ASWS_HM_00461] [The [Health Monitoring](#) shall simultaneously supervise graphs of [Supervised Entitys](#) preempted by other [Supervised Entitys](#).] ([RS_HM_09243](#), [RS_HM_09249](#))

A [Graph](#) may have one or more initial [Checkpoints](#) and one or more final [Checkpoints](#). Any sequence of starting with any [Initial Checkpoint](#) and finishing with any [Final Checkpoint](#) is correct (assuming that the checkpoints belong to the same [Graph](#)). After the final [Checkpoint](#), any initial [Checkpoint](#) can be reported.

At runtime, [Health Monitoring](#) verifies if the configured [Graphs](#) are executed. This is called [Logical Supervision](#). [Health Monitoring](#) verifies also the timing of [Checkpoints](#) and [Transitions](#). The mechanism for periodic [Checkpoints](#) is called [Alive Supervision](#) and for aperiodic [Checkpoints](#) it is called [Deadline Supervision](#).

The granularity of [Checkpoints](#) is not fixed by the [Health Monitoring](#). Few coarse-grained [Checkpoints](#) limit the detection abilities of the [Health Monitoring](#). For example, for an application with only one [Checkpoint](#) the [Health Monitoring](#) is only capable of detecting that this application (or one part of this application) is cyclically running and check the timing constraints. In contrast, if that application has [Checkpoints](#) at each block and branch, the [Health Monitoring](#) may also detect failures in the control flow of that application. Fine granularity of [Checkpoints](#) causes a complex and large configuration of the [Health Monitoring](#).

[Health Monitoring](#) allows the definition of different [Supervision Modes](#). Different behavior of supervision functions can be configured for each [Supervision Mode](#).

6.1.3 Execution of Supervision Functions

[Health Monitoring](#) offers [Alive Supervision](#), [Deadline Supervision](#), [Logical Supervision](#) and [Health Channel Supervision](#). All supervision functions can be invoked independently.

6.1.3.1 [Alive Supervision](#)

Periodic [Supervised Entitys](#) have constraints on the number of times they are executed within a given time span. By means of [Alive Supervision](#), The [Health Monitoring](#) checks periodically if the [Checkpoints](#) of a [Supervised Entity](#) have been reached within the given limits. This means that [Health Monitoring](#) checks if a [Supervised Entity](#) is run not too frequently or not too rarely.

6.1.3.2 Deadline Supervision

Non-cyclic [Supervised Entity](#)s have individual constraints on the timing between two [Checkpoints](#). By means of [Deadline Supervision](#), [Health Monitoring](#) checks the time span of transitions between two Checkpoints (one Source Checkpoint and one Target Checkpoint) of a Supervised Entity (for detection of early arrivals and delays), and elapsed time after the Source Checkpoints (for detection of timeouts). This means that [Health Monitoring](#) checks if some steps in a [Supervised Entity](#) take a time that is within the configured minimum and maximum limits.

6.1.3.3 Logical Supervision

[Logical Supervision](#) is a fundamental technique for checking the correct execution of embedded system software. Please refer to the safety standards (IEC 61508 or ISO26262) when [Logical Supervision](#) is required. [Logical Supervision](#) focuses on control flow errors, which cause a divergence from the valid (i.e. coded/compiled) program sequence during the error-free execution of the application. An incorrect control flow occurs if one or more program instructions are processed either in the incorrect sequence or are not even processed at all. Control flow errors can lead to data corruption, microcontroller resets, or fail-silence violations.

For the control flow graph this implies that every time the [Supervised Entity](#) reports a new [Checkpoint](#), it must be verified that there is a Transition configured between the previous [Checkpoint](#) and the reported one.

6.1.4 Determination of Supervision Status

Based on the results of the Alive, Deadline and Logical supervision Functions, the Cumulative Supervision Status is calculated. Each status is determined by a state machine. For details of the state machine, please refer the specification in the corresponding platform ([5] and [6]).

In case of Classic Platform, the [Local Supervision Status](#) is calculated for each [Supervised Entity](#) and a [Global Supervision Status](#) is calculated based on the [Local Supervision Status](#) of all Supervised Entities.

In case of Adaptive Platform, the [Elementary Supervision Status](#) is calculated for each Alive, Deadline and Logical supervision. The [Global Supervision Status](#) is calculated based on the [Elementary Supervision Status](#) of all Supervisions (Alive, Deadline and Logical) mapped to a Global Supervision. There can be multiple Global Supervisions and therefore a [Global Supervision Status](#) may not aggregate all [Elementary Supervision Statuses](#).

6.1.4.1 Rule Processing

Based on the results of supervision functions, [Health Monitoring](#) determines the corresponding reaction.

6.1.4.2 Watchdog Control

[Health Monitoring](#) controls the hardware watchdog. When the [Supervised Entities](#) are not correctly evaluated due to a programming error or memory failure in the watchdog protocol itself, it may still happen that the watchdog protocol erroneously sets the triggering condition and no watchdog reset will be caused. Therefore, it may be needed to use [Supervised Entities](#) and [Checkpoints](#) (or some other internal supervision mechanism) within watchdog protocol itself, while avoiding recursion in watchdog protocol.

6.1.4.3 Error Handling

Depending on the [Local Supervision Status](#) of each [Supervised Entity](#) and on the [Global Supervision Status](#), the [Health Monitoring](#) initiates mechanisms to recover from supervision failures. These range from notifying a central error handler to a global reset of the ECU.

6.1.5 Functional Decomposition

The [Health Monitoring](#) has the following logical steps:

1. Execution of all Supervision Functions - see [6.2](#)
2. Determination of Supervision Status - see [6.1.4](#)
3. Determination of Actions - see [6.1.4.1](#), [6.1.4.2](#) and [6.1.4.3](#)

The behavior of [Health Monitoring](#) is mode-dependent (see description of supervision mode in [6.1.2](#) and [2]).

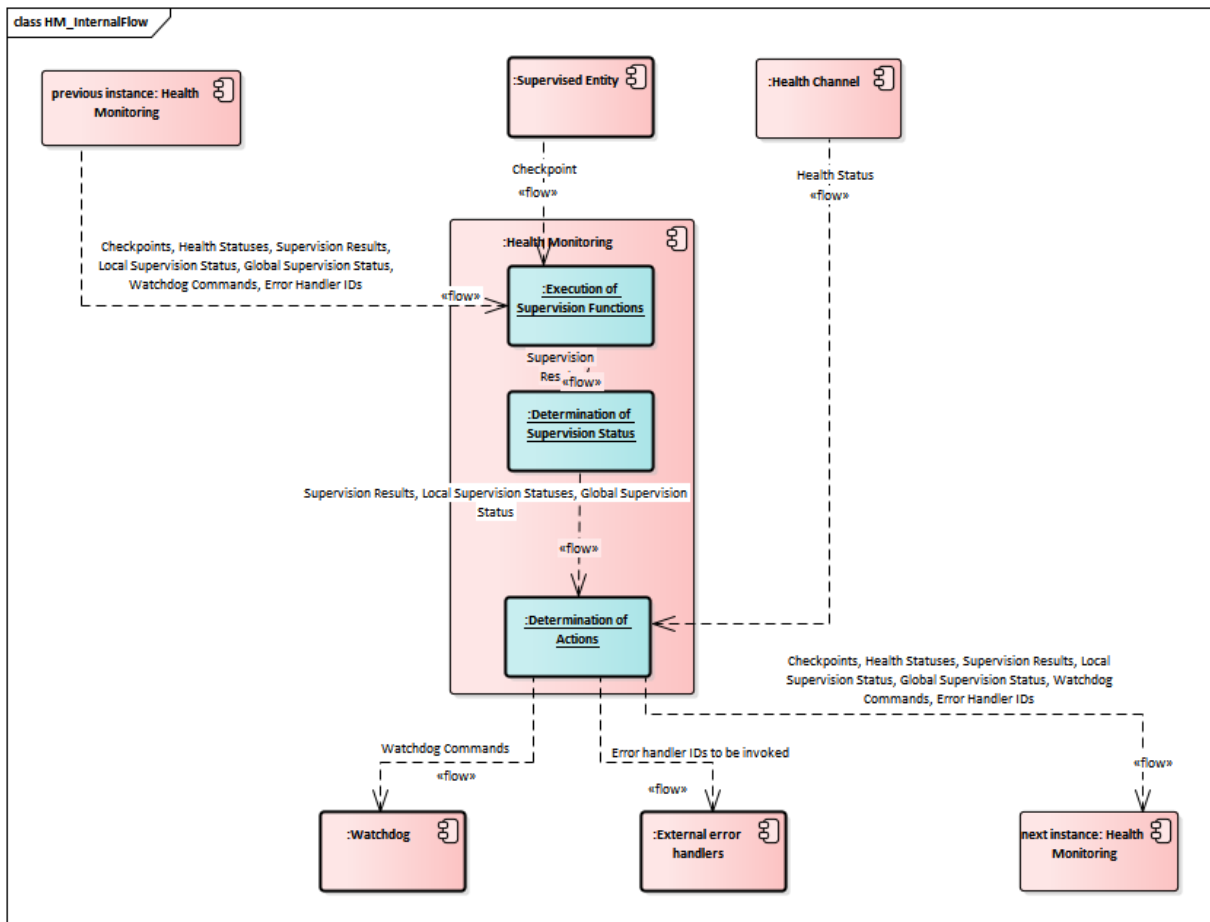

Figure 6.3: Main functions of Health Monitoring

6.2 Execution of Supervision Functions and Determination of Supervision Results

Supervised Entities are the units of supervision for the *Health Monitoring*. Each *Supervised Entity* (*SupervisedEntity*) can be supervised by a different supervision function or a combination of them.

The following three supervision functions are executed at this stage:

- *Alive Supervision* (see 6.2.1)
- *Deadline Supervision* (see 6.2.2)
- *Logical Supervision* (see 6.2.3)

Each of three Supervision Functions results with a list of Results of Supervision Function for each *Supervised Entity* (*SupervisedEntity*) (highlighted in Blue on Figure 6.3), where each Result is either correct or incorrect.

At **Health Monitoring** initialization, all the **Results** are set to correct. This means that for every **Supervised Entity** (**SupervisedEntity**) there are three partial results (one from **Alive Supervision**, one from **Deadline Supervision** and one from **Logical Supervision**).

In a given mode, each **Supervised Entity** (**SupervisedEntity**) may have zero, one or more **Alive Supervisions** (**AliveSupervision**), each having one correct/incorrect result.

In a given mode, each **Supervised Entity** (**SupervisedEntity**) may have zero, one or more **Deadline Supervisions** (**DeadlineSupervision**), each having one correct/incorrect result.

In a given mode, each **Supervised Entity** (**SupervisedEntity**) may have zero, one or more **Logical Supervisions** (**LogicalSupervision**) (i.e. graphs) configured, each having one correct/incorrect result.

In case there are zero active supervisions in a given mode, then **Health Monitoring** sees no **EXPIRED** local stati, so the watchdog trigger condition can be invoked.

6.2.1 **Alive Supervision**

The **Alive Supervision** (**AliveSupervision**) offers a mechanism to periodically check the execution reliability of one or several **Supervised Entitys**. This mechanism supports a check of cyclic timing constraints of independent **Supervised Entitys**.

6.2.1.1 **Alive Supervision Configuration**

To provide **Alive Supervision** (**AliveSupervision**), the **Checkpoints** and their timing constraints need to be configured. The simplest configuration for **AliveSupervision** is one **Checkpoint** without any **Transitions**, as shown in Figure 6.4)

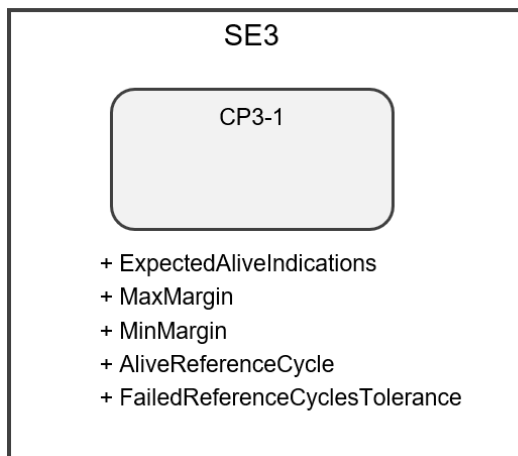

Figure 6.4: Simplest [Alive Supervision Checkpoint](#) Configuration for a given Supervision Mode

Moreover, it is also possible to have more than one [Checkpoint](#) as shown in Figure 6.5)

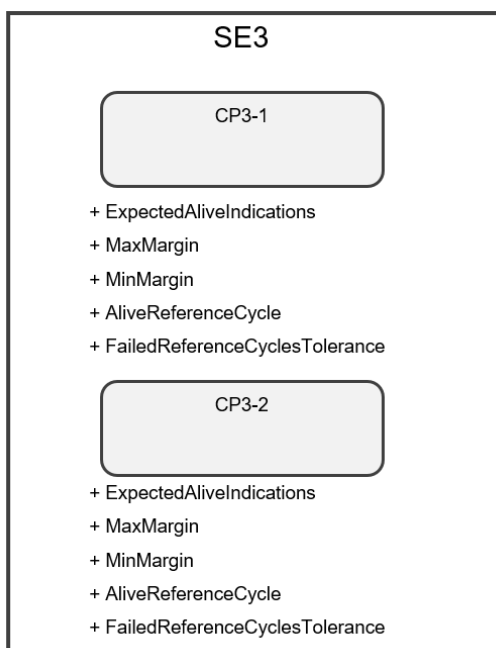

Figure 6.5: Multiple [Checkpoints](#) for [Alive Supervision](#) in one [SupervisedEntity](#) for a given Supervision Mode

Each [Checkpoint](#) can have its own set of [AliveSupervision](#) Parameters. Transitions are not used by [AliveSupervision](#). Although each [Checkpoint](#) has its own parameters, it is the [SupervisedEntity](#) for which status is determined based on the frequency of [Checkpoints](#).

The parameters of the [AliveSupervision](#) depend on the [Supervision Mode](#) and are defined per [Checkpoint](#) (and not globally for the whole [SupervisedEntity](#)).

None, some, or all of the [Checkpoints](#) of a [SupervisedEntity](#) can be configured for [AliveSupervision](#) in a given Mode. Moreover, in each Mode the [AliveSupervision](#) options of [Checkpoints](#) can be different.

The [ExpectedAliveIndications](#) (EAI) specifies the amount of expected alive indications from a given [Checkpoint](#), within a fixed period of supervision cycles. The period length is defined by [AliveReferenceCycle](#).

An acceptable negative variation ([MinMargin](#)) and acceptable positive variation ([MaxMargin](#)) can be configured.

The [Health Monitoring](#) has to support a configurable amount of independent [Supervised Entities](#).

6.2.1.2 [Alive Supervision Algorithm](#)

To send an Alive Indication, a [Supervised Entity](#) ([SupervisedEntity](#)) invokes the function [ReportCheckpoint](#), which results with incrementation of an Alive Counter for the [Checkpoint](#).

The periodic examination of the Counter of each [Checkpoint](#) of a [SupervisedEntity](#) by the Health Monitoring happens at every [AliveReferenceCycle](#).

The Alive Reference Cycle (see [AliveReferenceCycle](#)) is the property of an [AliveSupervision](#) of a [Checkpoint](#) in a given [Supervision Mode](#).

[ASWS_HM_00098] [The Health Monitoring shall perform for each [Alive Supervision](#) ([AliveSupervision](#)) configured in the active Mode, the examination of the Alive Counter of each [Checkpoint](#) of the [SupervisedEntity](#). The examination shall be done at the period [AliveReferenceCycle](#) of the corresponding [Alive Supervision](#) ([AliveSupervision](#)).] ([RS_HM_09125](#), [RS_HM_09249](#))

[ASWS_HM_00074] [The Health Monitoring shall examine an Alive Counter by checking if it is within the allowed tolerance (Expected - Min Margin; Expected + Max Margin) (see [ExpectedAliveIndications](#), [MinMargin](#), [MaxMargin](#)).] ([RS_HM_09125](#), [RS_HM_09249](#))

If any [Checkpoint](#) of a [SupervisedEntity](#) fails the examination, then the result of [Alive Supervision](#) at this [AliveReferenceCycle](#) for the [SupervisedEntity](#) is set to incorrect. Otherwise, it is set to correct.

[ASWS_HM_00075] [On examination of the Alive Counter, if the result of Alive Supervision is determined to be incorrect then, counter for failed alive supervision reference cycles shall be incremented unless it exceeds (is not greater than) configured Failure Tolerance (see configuration parameter [FailedReferenceCyclesTolerance](#)).] ([RS_HM_09163](#))

[ASWS_HM_00079] [On examination of the Alive Counter, if the result of Alive Supervision is determined to be correct then, counter for failed alive supervision reference cycles shall be decremented unless it is zero.]([RS_HM_09163](#))

Health Monitoring only checks the Checkpoints that are configured for the current [Supervision Mode](#).

[ASWS_HM_00083] [The Health Monitoring shall not perform the examination of the Alive Counter of a [Checkpoint](#) if no corresponding [Alive Supervision](#) ([AliveSupervision](#)) is defined in the current [Supervision Mode](#).]([RS_HM_09125](#), [RS_HM_09249](#))

6.2.2 Deadline Supervision

[Deadline Supervision](#) ([DeadlineSupervision](#)) checks the timing constraints of non-cyclic [Supervised Entity](#)s. In these [Supervised Entity](#)s, a certain event happens and a following event happens within a given time span. This time span can have a maximum and minimum deadline (time window).

6.2.2.1 Deadline Supervision Configuration

For every [DeadlineSupervision](#), two [Checkpoints](#) connected by a [Transition](#) are configured. The [Deadline](#) is attached to the [Transition](#) from the Source [Checkpoint](#) to the Target [Checkpoint](#). The simplest [DeadlineSupervision](#) configuration contains two [Checkpoints](#) and one [Transition](#), as shown in [Figure 6.6](#))

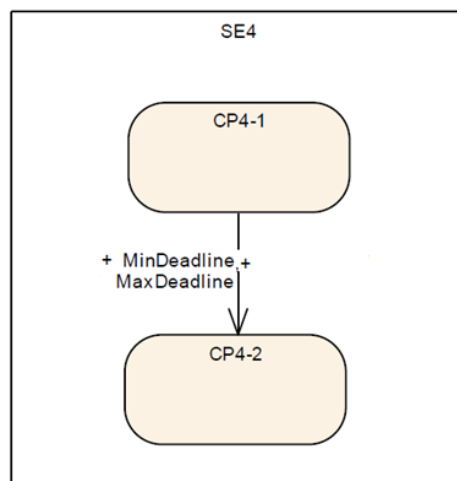

Figure 6.6: Simplest [Deadline Supervision](#) Configuration for a given [Supervision Mode](#)

More than one [Transition](#) can be defined in a [SupervisedEntity](#). The [Transitions](#) and the [Checkpoints](#) do not have to form a closed graph. Since only the Source

and the Target Checkpoints are considered by this Supervision Function, there can be independent graphs, as shown in Figure 6.7). Moreover, the Checkpoints can be chained.

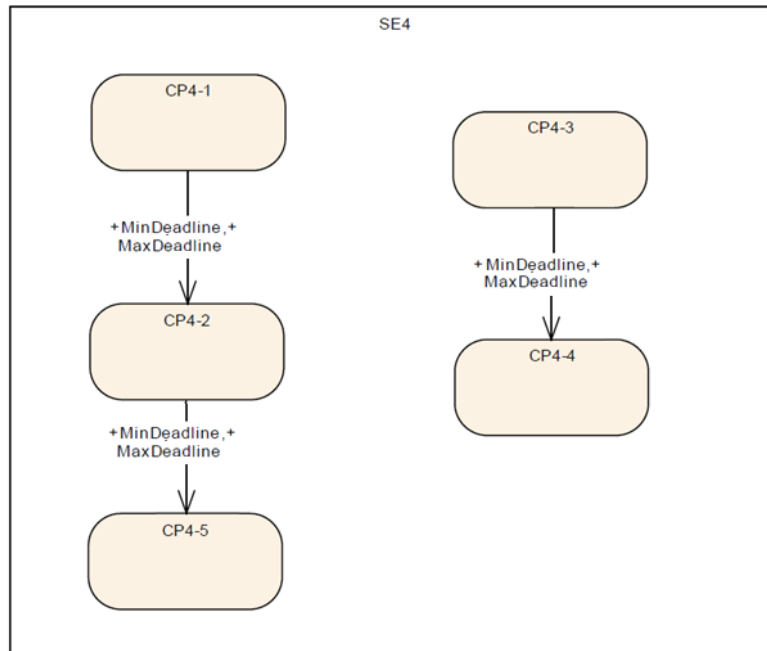

Figure 6.7: Multiple Transitions for Deadline Supervision in one Supervised Entity for a given Supervision Mode

The configuration of `DeadlineSupervision` is similar to the one of `AliveSupervision`.

The parameters of the `Deadline Supervision` (see `DeadlineSupervision`) depend on the Supervision Mode (`ModeDependentSettings`) and are defined for per a set of two `Checkpoints`. None, some, or all of the `Checkpoints` of a `SupervisedEntity` can be configured for `DeadlineSupervision` in a given Mode.

A `DeadlineSupervision` is defined as a set of `Transitions` with time constraints. A `Transition` is defined as two references to two `Checkpoints`, called `Source Checkpoint` and `Target Checkpoint` (see `DeadlineSupervision`). A `Transition` has minimum and maximum time `MinDeadline`, `MaxDeadline`.

6.2.2.2 Deadline Supervision Algorithm

When a `Source Checkpoint` (i.e. the `Source Checkpoint` referenced by the `CheckpointTransition`, see `DeadlineSupervision`) or a `Target Checkpoint` is reached, a `SupervisedEntity` invokes the function `ReportCheckpoint`, which will calculate the time expired between the `Source Checkpoint` and the `Target Checkpoint`.

The calculation is performed either at the occurrence of the Target [Checkpoint](#) or at the moment the elapsed time after Source [Checkpoint](#) is above the maximum limit ([MaxDeadline](#)).

[ASWS_HM_00294] [If the time difference between the Target [Checkpoint](#) and the Source [Checkpoint](#) is not within the minimum and the maximum limits (that is, the time difference is either less than [MinDeadline](#) or greater than [MaxDeadline](#)), then the result of [DeadlineSupervision](#) for this [SupervisedEntity](#) shall be defined as incorrect. Otherwise, it shall be defined as correct.]([RS_HM_09235](#), [RS_HM_09249](#))

[ASWS_HM_00228] [If the Target [Checkpoint](#) is not reached even though the time since reaching the Source [Checkpoint](#) has crossed the maximum limit (that is, the time elapsed since reaching Source [Checkpoint](#) is greater than [MaxDeadline](#)), then the result of [DeadlineSupervision](#) for this [SupervisedEntity](#) shall be defined as incorrect.]([RS_HM_09235](#), [RS_HM_09249](#))

[ASWS_HM_00229] [When a given Source [Checkpoint](#) is reached two or more times on or before the expiration of the maximum limit without reaching the corresponding Target [Checkpoint](#), this shall be considered as an error and the result of the [DeadlineSupervision](#) for this [SupervisedEntity](#) shall be considered as incorrect.]([RS_HM_09235](#), [RS_HM_09249](#))

[ASWS_HM_00354] [When a given Target [Checkpoint](#) is reached before the occurrence of the corresponding Source [Checkpoint](#), the function [ReportCheckpoint](#) [[SWS_HM_00447](#)] shall ignore this [Checkpoint](#) and not update the result of the Deadline Supervision for the Supervised Entity.]([RS_HM_09235](#), [RS_HM_09249](#))

This means also that it is not considered as an error by [DeadlineSupervision](#) if a given Target [Checkpoint](#) is reached several times in a sequence.

[ASWS_HM_00299] [For any reported [Checkpoint](#) that is neither a Source [Checkpoint](#) nor a Target [Checkpoint](#), the function [ReportCheckpoint](#) shall ignore this [Checkpoint](#) and not update the result of the Deadline Supervision for the Supervised Entity.]([RS_HM_09235](#), [RS_HM_09249](#))

6.2.3 Logical Supervision

[Logical Supervision](#) checks if the code of [Supervised Entity](#)s is executed in the correct sequence.

6.2.3.1 Logical Supervision Configuration

For every [Logical Supervision](#) ([LogicalSupervision](#)), there is a [Graph](#) of [Checkpoints](#) connected by [Transitions](#). The [Graph](#) abstracts the behavior of the [SupervisedEntity](#). There is a 1 to 1 correspondance between a [Graph](#) and the [LogicalSupervision](#) container.

In addition, a **Checkpoint** shall belong to maximum one **Graph**, overlapping **Graph** are not possible.

As an example for a **SupervisedEntity**, let us consider the following code fragment, which contains the **Checkpoints** CP0-0 to CP0-6.

```

CP0-0 initialize();
CP0-1 while (subsystem is running) {
CP0-2     if (condition_A)
CP0-3         run subtask_A;
CP0-4     else
CP0-5         run subtask_B;
CP0-6     run subtask_C
}
    
```

Figure 6.8: Example of Checkpoints

This **SupervisedEntity** can be represented by the **Graph** shown in Figure 6.9.

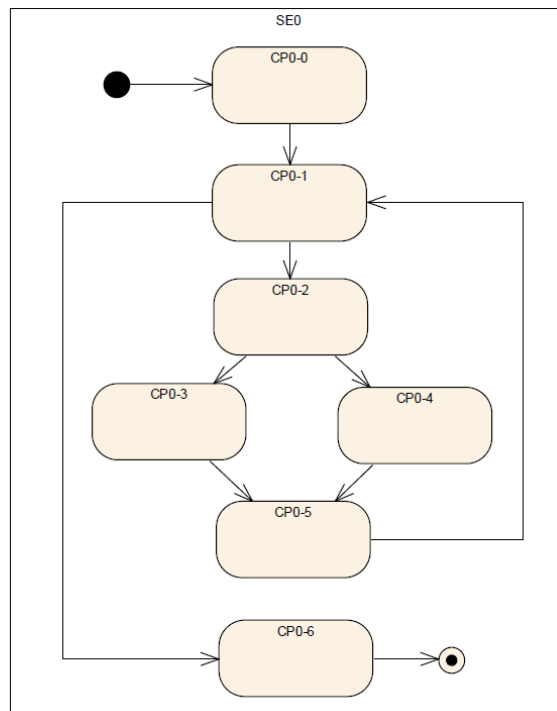

Figure 6.9: Example Control Flow Graph

A more abstract view of the **SupervisedEntity** is given by the **Graph** shown in Figure 6.10), where the **Checkpoint** CP0-1 represents the complete while loop.

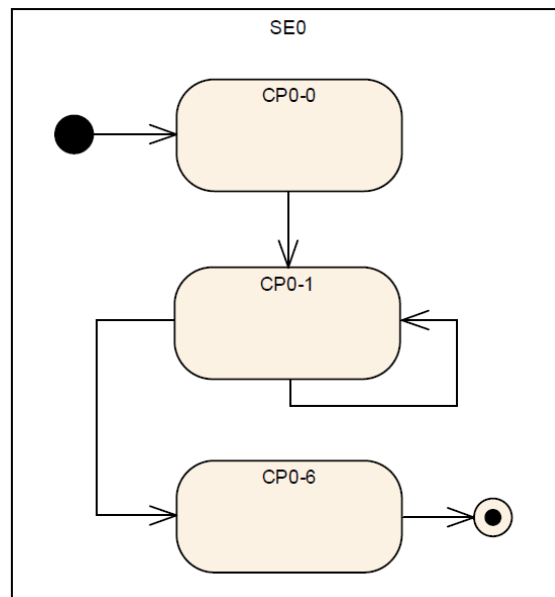

Figure 6.10: Abstracted Example Control Flow Graph

In a [Graphs](#), [Checkpoints](#) can belong to the same [SupervisedEntity](#) or to different [Supervised Entities](#), no restriction is imposed. The transitions between [Checkpoints](#) in a [Graph](#) are dependent on the Supervision Mode.

The parameters of the [Graphs](#) (see [LogicalSupervision](#)) are the [Transitions](#) that are contained in a Supervision Mode (see [ModeDependentSettings](#)). Each [Transition](#) connects two [Checkpoints](#). The [Checkpoints](#) exist irrespective if they are connected by any transitions.

6.2.3.2 Logical Supervision Algorithm

Immediately after initialization of the Health Monitoring, there has not yet been a [Checkpoint](#) reported, i.e. all the [Supervised Entities](#) are passive. Each [Graph](#) is considered as inactive.

Each [Graph](#) represents one [LogicalSupervision](#), but it may span across possibly several [Supervised Entities](#). Assuming N [Graphs](#) that cross a [Supervised Entity](#), this implies N results from the [LogicalSupervision](#) for the [SupervisedEntity](#)

[ASWS_HM_00271] [The [Health Monitoring](#) shall maintain the activity status of each [Graph](#).] ([RS_HM_09222](#), [RS_HM_09249](#))

[ASWS_HM_00296] [At the initialization, the Health Monitoring shall consider each [Graph](#) as inactive.] ([RS_HM_09222](#), [RS_HM_09249](#))

Each [Graph](#) may have one or more Initial [Checkpoints](#). Initial [Checkpoints](#) are [Checkpoints](#) with which a [Graph](#) can start.

To notify reaching a **Checkpoint**, a **SupervisedEntity** invokes the function **ReportCheckpoint**, which results with execution of **Logical Supervision** algorithm.

Because a **Checkpoint** can belong to only one **Graph**, the function **ReportCheckpoint** is able to identify to which **Graph** a **Checkpoint** belongs.

[ASWS_HM_00295] [The function **ReportCheckpoint** shall identify to which one **Graph** a reached **Checkpoint** belongs.](*RS_HM_09222, RS_HM_09249*)

If a **Graph** is active, the function **ReportCheckpoint** checks for each new **Checkpoint** if the Transition between the stored **Checkpoint** and the newly reported **Checkpoint** is allowed.

[ASWS_HM_00252] [The function **ReportCheckpoint** shall verify if the reported **Checkpoint** belonging to a **Graph** is a correct one by the following checks:

1. If the **Graph** of the reported **Checkpoint** is inactive, then:
 - a. If the **Checkpoint** is an Initial **Checkpoint** (see **LogicalSupervision**), then the result of this **Logical Supervision** within the **SupervisedEntity** of the reported **Checkpoint** is correct, otherwise incorrect.
2. Else if the **Graph** is active and all previously called **Checkpoints** of this **Graph** were called in the right sequence, then:
 - a. If the reported **Checkpoint** is a successor of the stored **Checkpoint** within the **Graph** of the reported **Checkpoint** (this means there is a Transition with **Source** and **Target**), then the result of this **Logical Supervision** for **SupervisedEntity** of the reported **Checkpoint** is correct, otherwise incorrect.
3. Else (i.e. the **Graph** is active, but at least one **Checkpoint** in this **Graph** was previously called in a wrong sequence):
 - a. The result of this **Logical Supervision** of the **Supervised Entity** keeps incorrect.

The above requirement means that in case of an incorrect transition, the **SupervisedEntity** that is considered as erroneous is the one that reported the incorrect **Checkpoint**.

](*RS_HM_09222, RS_HM_09249*)

If a **Checkpoint** is one of the initial **Checkpoints** of a **Graph**, then the **Graph** is set as active.

Note that if a **Graph** contains multiple initial **Checkpoints**, either of them are allowed to be entered when the **Graph** is inactive: when an initial **Checkpoint** is reported, the corresponding **Graph** becomes active, so another initial **Checkpoint** is allowed only if a Transition is configured from the first **Checkpoint** to the second one as a **Graph** can have only one active checkpoint at a specific time.

[ASWS_HM_00331] [If the result of the **Logical Supervision** triggered by **ReportCheckpoint** is correct and the **Checkpoint** is defined as a final one, then the

function `ReportCheckpoint` shall set `Graph` as inactive. After a final checkpoint, only initial checkpoints are possible.]([RS_HM_09222](#), [RS_HM_09249](#))

[ASWS_HM_00297] [For any reported `Checkpoint` that does not belong to any `Graph`, the function `ReportCheckpoint` shall ignore it and not update the result of the `Logical Supervision` for the `SupervisedEntity`.]([RS_HM_09222](#), [RS_HM_09249](#))

This is because the checkpoint may be used by other Supervision Functions (Alive or Deadline).

[ASWS_HM_00273] [If the function `ReportCheckpoint` determines that the result of the `Logical Supervision` for the given `Checkpoint` is true, and the `Checkpoint` is the initial one (see `LogicalSupervision`), then the `Graph` corresponding to the `Checkpoint` shall be considered as active.]([RS_HM_09222](#), [RS_HM_09249](#))

6.3 System Health Monitoring

The previous chapters described Health Monitoring on platform level. In a distributed system using different platforms AP, CP, Non-AUTOSAR, a global monitor is necessary for evaluating and sharing health information on a vehicle level.

A standardized format for `Health Indicator` will be introduced for sharing health information of platforms, features, domains or even vehicles. These `Health Indicator` can either be used for platform level recovery actions, or to enhance services with a Health of Service, similar to Quality of Service (QoS).

Abstract interfaces for System Health Monitor to local health monitors shall be specified, allowing platform agnostic health management of several Adaptive, Classic and third-party platforms.

6.3.1 System Health Monitoring Architecture

The `SystemHealthMonitor` is intended for platform agnostic safety monitoring. For this reason the `SystemHealthMonitor` is introduced as an abstract component according to `AUTOSAR_TPS_AbstractPlatformSpecification`. A `SystemHealthMonitor` gathers health information of abstract `LocalHealthMonitors`. These `LocalHealthMonitors` are deployed on platform level and collect the health information of the platform itself. The `LocalHealthMonitor` on platform level might be implemented as a client `SystemHealthMonitor` as seen in the [7, EXP-SHM], or some functional cluster. The local information might include monitoring results of Platform Health Monitor(in AP)/Watchdog Manager(in CP), State Manager(in AP)/Basic Software Mode Manager(in CP) or hardware information e.g highTemp. Components like the State Manager are highly project specific and it can thus not be fully standardized which information the `LocalHealthMonitor` reports.

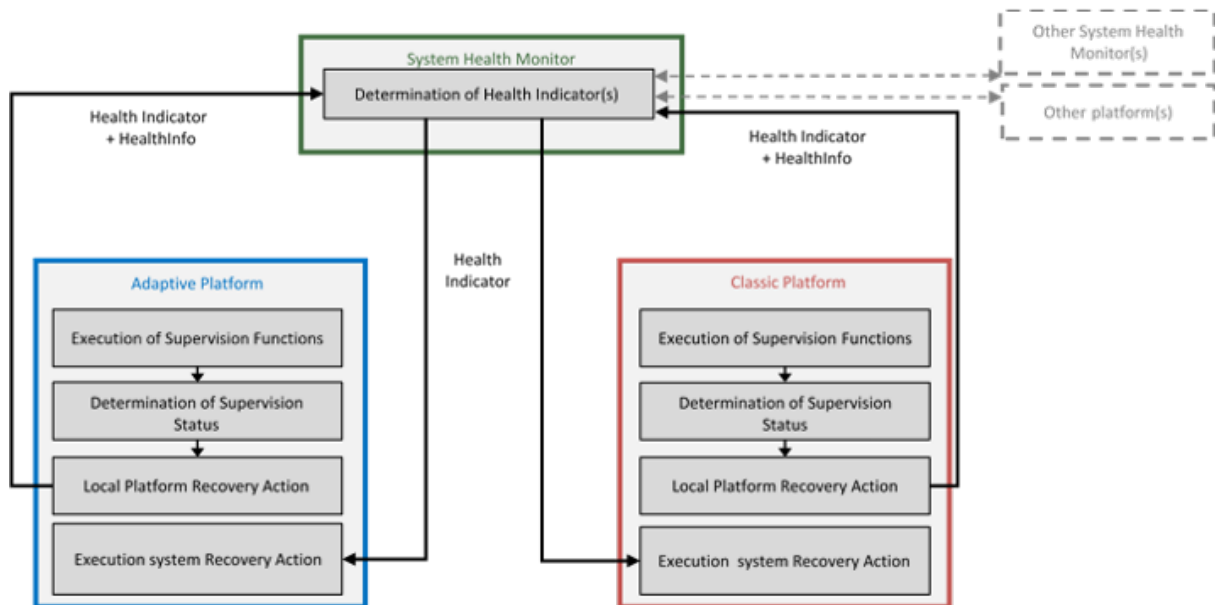

Figure 6.11: Overview of Health Information exchange between different platforms

The collected information can be used to create a platform [Health Indicator](#), giving an overall estimation of the platform health.

[ASWS_HM_00501]{DRAFT} [The [LocalHealthMonitor](#) shall create a platform [Health Indicator](#), based on the locally reported health information.]([RS_HM_09301](#), [RS_HM_09304](#), [RS_HM_09303](#))

Information exchanged with SHM is considered safety relevant. Therefore, communication between SHM instance and local monitors and between multiple SHM instances shall be cyclic. Safety mechanisms like E2E protection shall be used to detect possible message loss, delay, alteration etc. The detectable errors depend on the chosen E2E profile and are project specific. Cycle exchange of Health Indicators can be used as periodical heart beat, giving an indication on the availability of the platforms and of SHM. A missed message means no confidence of correct behavior and should be considered in [Health Indicator](#) determination on SHM side and for recovery action on platform level.

[ASWS_HM_00502]{DRAFT} [The platform [Health Indicator](#) and the local health information shall be cyclically reported to the [SystemHealthMonitor](#).]([RS_HM_09309](#), [RS_HM_09303](#))

[ASWS_HM_00509]{DRAFT} [The [Health Indicator](#) calculated by SHM shall be reported cyclically to subscribers.]([RS_HM_09309](#), [RS_HM_09310](#), [RS_HM_09303](#))

[ASWS_HM_00503]{DRAFT} [Information exchange between [LocalHealthMonitor](#) and [SystemHealthMonitor](#) shall be E2E protected.]([RS_HM_09302](#), [RS_HM_09303](#))

[ASWS_HM_00504]{DRAFT} [The [SystemHealthMonitor](#) shall gather and evaluate health information of all [LocalHealthMonitors](#) in its subsystem. Together with [Health Indicators](#) of other [SystemHealthMonitors](#) the subsystem information

can be used to create `Health Indicators` at a higher level of abstraction.]([RS_HM_09305](#), [RS_HM_09304](#), [RS_HM_09303](#))

As one `SystemHealthMonitor` poses the threat of a single point of failure for its subsystem, multiple `SystemHealthMonitors` might receive the local health information, but only one of them should be actively calculating and providing the `Health Indicators`.

[ASWS_HM_00505]{DRAFT} [A dedicated/particular `Health Indicator` shall be provided by only one `SystemHealthMonitor` at a given point of time.]([RS_HM_09305](#), [RS_HM_09303](#))

6.3.2 Concept of Health Indicator

`Health Indicators` provide an evaluation metric of current system performance with regard to safety requirements. Health information of safety monitors is analyzed and used to determine `Health Indicators` on different abstraction levels. The `Health Indicator` is defined as a tuple of ID, Performance, Reliability, Timestamp and SubsystemState. The Performance rates the performance with respect to malfunctioning behavior. Reliability evaluates how much to trust the system due to uncertainties. SubsystemState is a systemspecific Health status of the Subsystem $Sub = \{sub_1, \dots, sub_n\}$. Different SubsystemStates are based on availability and availability requirements. Health Indicators can be results of supervisions on hardware, software, user, or the vehicle's environment. Combining monitoring results with well-defined safety properties, a corresponding health triple is determined. The three core parameters of the Health Indicator are supposed to capture different safety aspects required by different safety standards. The Degradation parameter is operating at the most abstract level. Only based on binary availability indications an overall degradation state is determined. ISO-26262 [1] and ISO-21448 [4] take further aspects into consideration than just the availability. ISO-26262 focuses on hazards arising from malfunctioning of E/E Systems whereas SOTIF refers to hazards caused by performance limitations. To this end, the scope of SOTIF demands including the vehicle's interaction with its environment, users, and other cars to capture uncertainties introduced by them. To include ISO-26262 and SOTIF into the Health Indicator, the Performance and Reliability parameters are used.

The timestamp can be used to store information when the HealthIndicator was created. A unique HealthIndicatorID shall be used to distinguish `Health Indicators` and assign them to a specific subsystem (e.g feature,platform,domain).

`SystemHealthMonitors` can operate on different abstraction levels. Monitoring results on platform level can be grouped on the level of functional features. Functional features might then be grouped in domains and all of this might give an health indication for the vehicle. These abstraction levels are not standardized and just given as an example. Each `SystemHealthMonitor` can handle multiple subsystems at different abstraction levels and thus provides multiple HealthIndicators.

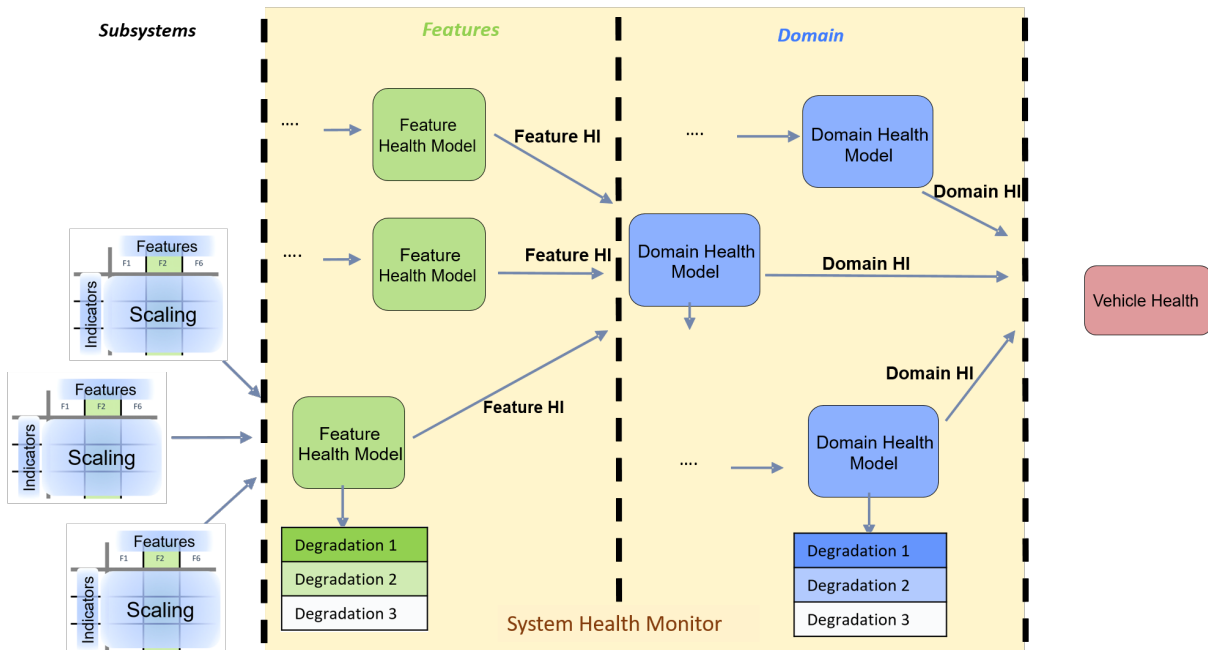

Figure 6.12: Example abstraction levels for Health Indicators

Health Indicators of subsystems can be used to build Health Indicators on feature level. These can then be combined to build Health Indicators on domain level and finally on vehicle level. Further explanation how these Health Indicators could look like for their respective domain can be found in the EXP_SHM.

[ASWS_HM_00506]{DRAFT} [Reporting of Health Indicators from SHM to subscribers shall be E2E protected.] (RS_HM_09308, RS_HM_09303)

6.3.3 Application interfaces

For reporting the actual health information a standardized interface shall be used. The platform HealthIndicator can be provided over the HealthIndicatorInterface and local health information over the HealthInfoInterface. Local health information can contain health information from functional clusters e.g. supervision results from PHM/SM or external monitors (e.g. voltage monitor). These interfaces are described as service interfaces in chapter 9

6.3.4 Usage of HealthIndicators

Health Indicators can be used for directly exchanging health information of subsystems. Each consumer interested in a specific Health Indicator can access it over the HealthIndicatorInterface. Local platform managers (State Manager/Basic Software Mode Manager) could use the HIs of other platforms to degrade their own platform or activate backup functions, for platforms with bad health. This

would allow decentralized system degradation across multiple platforms. Similarly applications might want to know the HI of features providing them with input, in order to decide whether to trust this information.

7 Health Monitoring API specification

This chapter specifies the API of [Health Monitoring](#) that is referred in other document parts. It is defined in generic/abstract way, so that it can be implemented on different platforms. For exact API name and semantics please refer to corresponding Platform specific documents ([5] in case of Classic Platform and [6] in case of Adaptive platform).

7.1 Provided API

7.1.1 Reporting Checkpoints

[Health Monitoring](#) provides a method to report the current code location, represented by a Checkpoint

```
1 ReportCheckpoint(CheckpointID id)
```

7.1.2 Reporting health status

[Health Monitoring](#) provides a method to report the health status information

```
1 ReportHealthStatus(HealthStatusID id, HealthStatus status)
```

7.1.3 Forwarding information between health monitoring components

[Health Monitoring](#) provides a method to report the information collected and determined by one [Health Monitoring](#) component, so that they can be forwarded to another [Health Monitoring](#) component.

```
1 ReportHealthMonitoring(HealthMonitoring monitoringData)
```

7.1.4 Init / DeInit

[Health Monitoring](#) provides a method to initialize the service.

```
1 Init()
```

[Health Monitoring](#) provides a method to deinitialize the service.

```
1 DeInit()
```

7.1.5 Retrieving Supervision Status from application

[Health Monitoring](#) provides a method to report the Local Status of a [Supervised Entity](#) to the application.

```
1 GetLocalStatus(LocalStatusType* LocalStatus)
```

[Health Monitoring](#) provides a method to report the Global Status to which the specified [Supervised Entity](#) belongs to the application.

```
1 GetGlobalStatus(GlobalStatusType* GlobalStatus)
```

7.2 Assumed API

This section specified an API that is used by [Health Monitoring](#).

7.2.1 Triggering error handling

[Health Monitoring](#) provides a method to trigger a defined error handler, providing the identifier of this error.

```
1 TriggerErrorHandler(ErrorID id)
```

7.2.2 Controlling watchdog

[Health Monitoring](#) provides a method to control the watchdog drivers.

```
1 ControlWatchdog(ControlData control)
```

8 Configuration Parameters

This chapter specifies a configuration model of [Health Monitoring](#). The options defined here are referenced/used in chapter [6](#).

This configuration, which is abstract and platform-independent is supposed to be implemented/instantiated by the specific platforms, e.g. by AUTOSAR AP.

8.1 Overall configuration

The configuration of a [Machine](#) (representing MCU, virtual machine, partition) is split into two categories:

1. [ModeIndependentSettings](#) - containing only static information: what are possible [SupervisedEntitys](#) and possible [Health Channels](#)
2. [ModeDependentSettings](#) - containing all supervision function configurations.

It means all supervision configuration is fully mode-dependent.

A system is made of several [Machines](#). Therefore, [Health Monitoring](#) is allocated to a specific [Machine](#).

It is possible that there are several independent suppliers of software for the same [Machine](#). Therefore, each of suppliers can supply any part of the configuration, for any configuration classes.

[ModeDependentSettings](#) contains also the configuration of watchdogs - but this part is not standardized (marked in blue).

The definitions of [Machines](#) (machines/virtual machines/partitions) are assumed to be provided externally (by other specifications) therefore they are only referenced here.

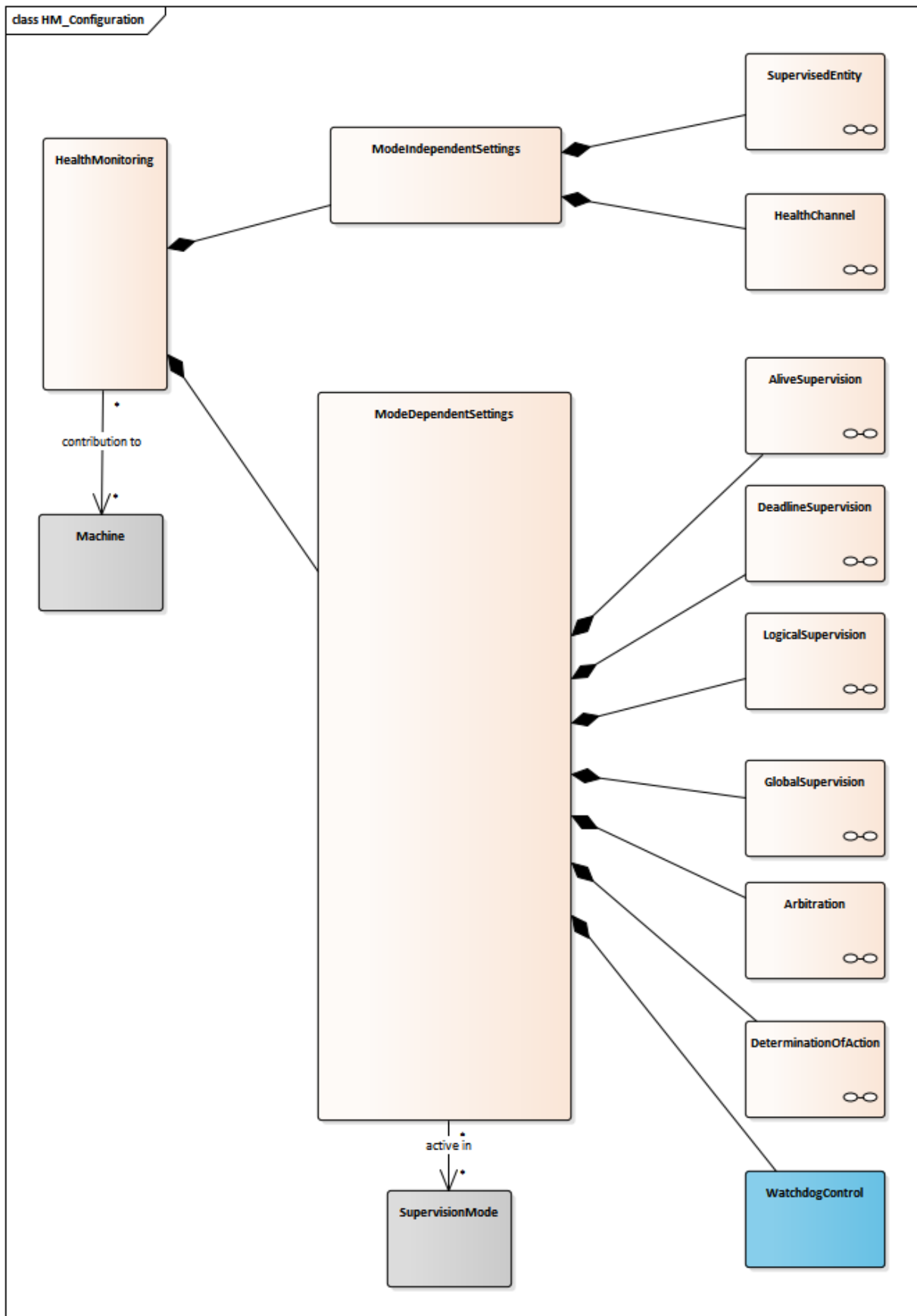

Figure 8.1: Overall configuration

8.2 Mode-independent settings

`ModeIndependentSettings` contain static information: what are possible `SupervisedEntity`s and possible `Health Channel`.

Implementation hint: This part of configuration is typically used to generate the type-safe API to Applications.

8.2.1 Supervised Entity

A `SupervisedEntity` is a collection of `Checkpoints` that can occur during the runtime of a software.

A `SupervisedEntity` has the following options:

1. `Name`: Globally unique name identifier, used by Applications
2. `ID`: Globally unique identifier (number)

Note that on AUTOSAR AP, the uniqueness of the name can be ensured by using a namespace as a part of the identification.

A `Checkpoint` has the following options:

1. `Name`: Name, used by Applications, unique within the `SupervisedEntity`.
2. `ID`: Identifier of the `Checkpoint`, unique within the `SupervisedEntity`.

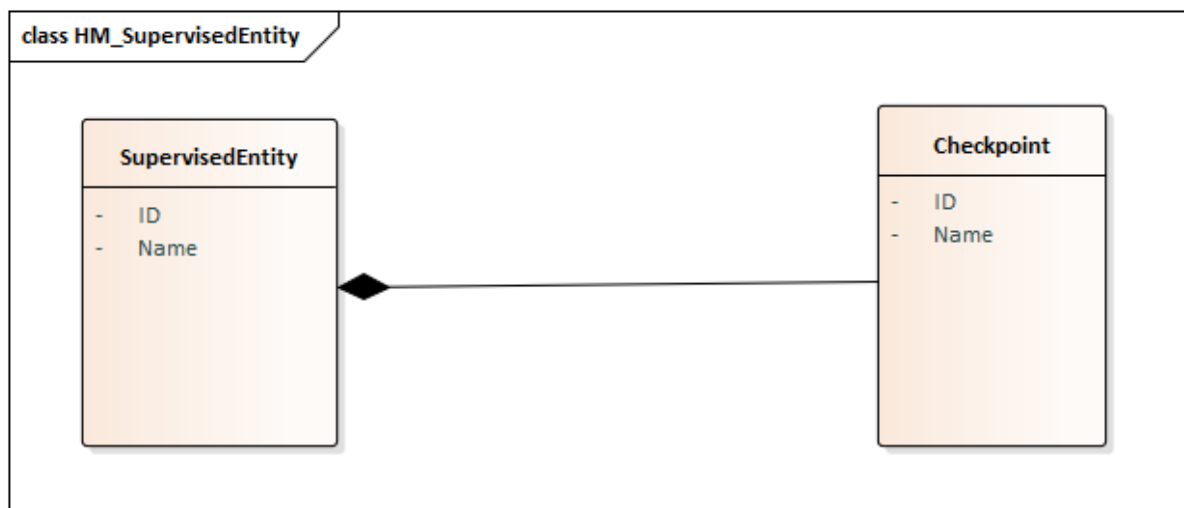

Figure 8.2: Supervised Entity

Note: On AUTOSAR AP, a `Supervised Entity` results with an enum, named after the `Supervised Entity`s namespace and name, with the enumerations corresponding to the checkpoints.

8.3 Mode-dependent settings

`ModeDependentSettings` contain all supervision function configurations.

Implementation hint: This part of configuration is typically used by non-generated code to perform the supervision at runtime.

8.3.1 Alive Supervision

`AliveSupervision` checks the amount of reported alive indications within the `AliveReferenceCycle`, which is to be within `ExpectedAliveIndications - MinMargin` and `ExpectedAliveIndications + MaxMargin`.

`AliveSupervision` has the following options:

1. `AliveReferenceCycle`: time period at which the `Alive Supervision` mechanism compares the amount of received `Alive Indications` of the `Checkpoint` against the expected/configured amount.
2. `ExpectedAliveIndications`: the amount of expected alive indications of the `Checkpoint` within `AliveReferenceCycle`
3. `MaxMargin`: amount of acceptable missing alive indications within `AliveReferenceCycle`
4. `MinMargin`: amount of acceptable additional alive indications within `AliveReferenceCycle`
5. `FailedReferenceCyclesTolerance`: acceptable amount of `AliveReferenceCycles` with incorrect/failed alive supervision

A `Checkpoint` uniquely identifies a specific location in source code. Different executions of the same code (e.g. due to multithreading or running the same application in several instances) share the same `Checkpoint` identification.

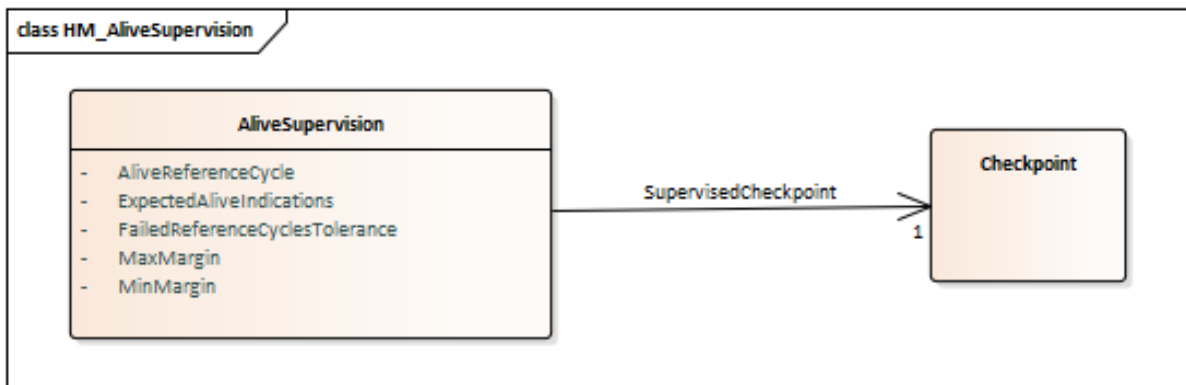

Figure 8.3: Alive Supervision

8.3.2 Deadline Supervision

`DeadlineSupervision` has the following options:

1. `MaxDeadline`: longest time span allowed.
2. `MinDeadline`: shortest time span allowed.

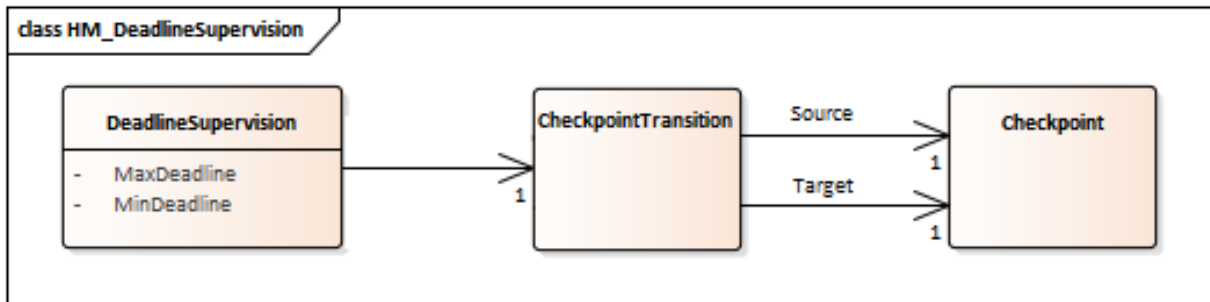

Figure 8.4: Deadline Supervision

8.3.3 Logical Supervision

`LogicalSupervision` is a collection of `CheckpointTransitions`.

A `LogicalSupervision` can be seen one graph.

As `LogicalSupervision` represents a graph, so it is possible to configure the initial and/or the final `Checkpoints` by referring to those `Checkpoints`.

A `CheckpointTransition` has its `Source` and `Target Checkpoint`. One `Checkpoint` can have multiple `Transitions` - this way it is possible to configure merges and forks in the graph (e.g. from A you can go to B or to C).

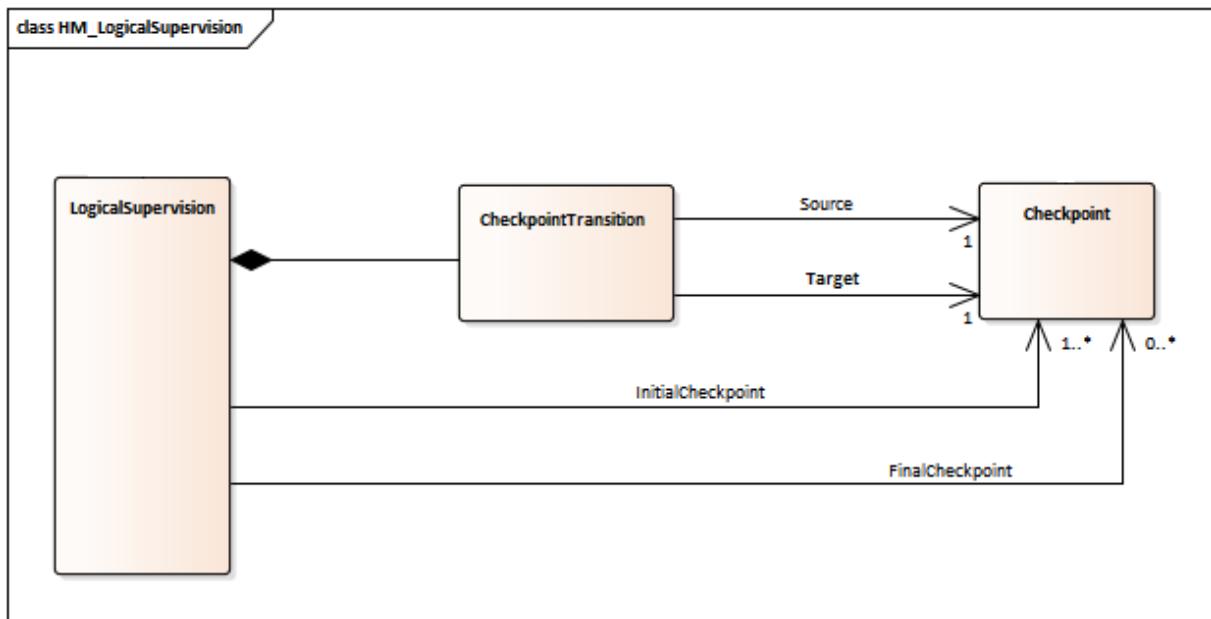

Figure 8.5: Logical Supervision

8.3.4 Global Supervision

A *GlobalSupervision* is an overall state of a software subsystem. There can be one or a few *GlobalSupervisions* per *Machine*.

GlobalSupervision is a "worst-of" of all contained *LocalSupervisions*.

LocalSupervision represents the state of a *SupervisedEntity*. It comprises of all *AliveSupervisions*, *DeadlineSupervisions* and *LogicalSupervisions* pertaining to a *SupervisedEntity*.

9 Service Interfaces

9.1 Type definitions

[ASWS_HM_00511]{DRAFT} [

| | |
|---------------------|--|
| Name | HealthIndicator |
| Kind | STRUCTURE |
| Subelements | HealthIndicatorID uint8_t Timestamp uint32_t (optional) Performance int16_t (optional) Reliability int16_t (optional) SubsystemState enum [uint8_t] (optional) |
| Derived from | - |
| Description | Health Indicator provides an evaluation metric of current system performance with regard to safety requirements |

](RS_HM_09303)

[ASWS_HM_00515]{DRAFT} [

| | |
|---------------------|---|
| Name | HealthInfo |
| Kind | STRUCTURE |
| Subelements | GlobalSupervisionInfoVector (optional) HealthChannelInfoVector (optional) FunctionGroupInfoVector (optional) LocalSupervisionInfoVector (optional) BswMModeName string (optional) |
| Derived from | - |
| Description | Structure containing different Health Information pairs [Shortname+Value]. |

](RS_HM_09303)

[ASWS_HM_00516]{DRAFT} [

| | |
|---------------------|---|
| Name | GlobalSupervisionInfo |
| Kind | STRUCTURE |
| Subelements | Name string Status enum[uint8_t] |
| Derived from | - |
| Description | Structure containing Global Supervision Status information. |

](RS_HM_09303)

[ASWS_HM_00517]{DRAFT} [

| | |
|---------------------|---|
| Name | GlobalSupervisionInfoVector |
| Kind | VECTOR |
| Subelements | GlobalSupervisionInfo |
| Derived from | - |
| Description | A list of Global Supervision Status Information |

](RS_HM_09303)

[ASWS_HM_00518]{DRAFT} [

| | |
|---------------------|--|
| Name | FunctionGroupInfo |
| Kind | STRUCTURE |
| Subelements | Name string State string |
| Derived from | - |
| Description | Structure containing a Function Group State. |

]([RS_HM_09303](#))

[ASWS_HM_00519]{DRAFT} [

| | |
|---------------------|--|
| Name | FunctionGroupInfoVector |
| Kind | VECTOR |
| Subelements | FunctionGroupInfo |
| Derived from | - |
| Description | A list of Function Group State Information |

]([RS_HM_09303](#))

[ASWS_HM_00520]{DRAFT} [

| | |
|---------------------|---|
| Name | HealthChannelInfo |
| Kind | STRUCTURE |
| Subelements | Name string Status string |
| Derived from | - |
| Description | A structure containing a Health Channel Status information. |

]([RS_HM_09303](#))

[ASWS_HM_00521]{DRAFT} [

| | |
|---------------------|--|
| Name | HealthChannelInfoVector |
| Kind | VECTOR |
| Subelements | HealthChannelInfo |
| Derived from | - |
| Description | A list of Health Channel Status information. |

]([RS_HM_09303](#))

[ASWS_HM_00522]{DRAFT} [

| | |
|---------------------|---|
| Name | LocalSupervisionInfo |
| Kind | STRUCTURE |
| Subelements | Name string Status enum[uint8_t] |
| Derived from | - |
| Description | Structure containing a Local Supervision Status |

]([RS_HM_09303](#))

[ASWS_HM_00523]{DRAFT} [

| | |
|---------------------|--|
| Name | LocalSupervisionInfoVector |
| Kind | VECTOR |
| Subelements | LocalSupervisionInfo |
| Derived from | - |
| Description | A list of Local Supervision Status Information |

]([RS_HM_09303](#))

Note: Following Health Information are supported in Adaptive Platform:

- GlobalSupervisionInfo
- HealthChannelInfo
- FunctionGroupInfo

Following Health Information are supported in Classic Platform:

- GlobalSupervisionInfo
- LocalSupervisionInfo
- BswMModeName

9.2 Provided Service Interfaces

9.2.1 HealthIndicator

Port

[ASWS_HM_00510]{DRAFT} [

| | | | |
|--------------------|--------------------------|-----------|--------------------------|
| Name | HealthIndicatorInterface | | |
| Kind | ProvidedPort | Interface | HealthIndicatorInterface |
| Description | Report HealthIndicator | | |
| Variation | | | |

]([RS_HM_09300](#), [RS_HM_09303](#))

Service Interface

[ASWS_HM_00512]{DRAFT} [

| | |
|--------------------|--------------------------------|
| Name | HealthIndicator |
| Events | HealthIndicatorEvent |
| Description | The reported Health Indicator. |
| Type | HealthIndicator |

]([RS_HM_09303](#))

9.2.2 HealthInfo

Port

[ASWS_HM_00513]{DRAFT} [

| | | | |
|--------------------|---------------------|-----------|---------------------|
| Name | HealthInfoInterface | | |
| Kind | ProvidedPort | Interface | HealthInfoInterface |
| Description | Report HealthInfo | | |
| Variation | | | |

]([RS_HM_09301](#), [RS_HM_09303](#))

Service Interface

[ASWS_HM_00514]{DRAFT} [

| | |
|--------------------|---------------------------------|
| Name | HealthInfo |
| Events | HealthInfoEvent |
| Description | The reported Health Information |
| Type | HealthInfo |

]([RS_HM_09303](#))