

Document Title	Specification of a Transport Layer for SAE J1939
Document Owner	AUTOSAR
Document Responsibility	AUTOSAR
Document Identification No	425

Document Status	published
Part of AUTOSAR Standard	Classic Platform
Part of Standard Release	R22-11

Document Change History			
Date	Release	Changed by	Change Description
2022-11-24	R22-11	AUTOSAR Release Management	<ul style="list-style-type: none"> Fixed not applicable SWS items
2021-11-25	R21-11	AUTOSAR Release Management	<ul style="list-style-type: none"> No content changes
2020-11-30	R20-11	AUTOSAR Release Management	<ul style="list-style-type: none"> Improved structure of error sections Replaced error descriptions with generated tables
2019-11-28	R19-11	AUTOSAR Release Management	<ul style="list-style-type: none"> No content changes Changed Document Status from Final to published
2018-10-31	4.4.0	AUTOSAR Release Management	<ul style="list-style-type: none"> Changed header file structure Fixed reference to protocol type Harmonized J1939TP_E_UNINIT Clarifications of timeouts
2017-12-08	4.3.1	AUTOSAR Release Management	<ul style="list-style-type: none"> Clarified reception with identical channels Introduction of runtime errors
2016-11-30	4.3.0	AUTOSAR Release Management	<ul style="list-style-type: none"> Improved handling of meta data Reliable TxConfirmation replaces timeout Clarification on concurrent connections Support of link time configuration variant

Document Change History			
Date	Release	Changed by	Change Description
2015-07-31	4.2.2	AUTOSAR Release Management	<ul style="list-style-type: none"> • Fixed retry behavior • Clarified effect of MetaData on SA/DA/Protocol • Introduction of further error classes
2014-10-31	4.2.1	AUTOSAR Release Management	<ul style="list-style-type: none"> • Removed obsolete configuration elements • Harmonized with SWS BSW General
2014-03-31	4.1.3	AUTOSAR Release Management	<ul style="list-style-type: none"> • Allow for parallel reception via TP (BAM/CMDT) and directly • Clarified ambiguities regarding CTS parameters
2013-10-31	4.1.2	AUTOSAR Release Management	<ul style="list-style-type: none"> • NotifResultType replaced by StdReturnType • Additional development errors for protocol problems • Connection parameters moved to channel configuration • Editorial changes • Removed chapter(s) on change documentation
2013-03-15	4.1.1	AUTOSAR Administration	<ul style="list-style-type: none"> • Support for dynamic CAN IDs via MetaData • Support for variable block size and retry • TP API improvements and fixes • Adapted to new BSW General
2011-12-22	4.0.3	AUTOSAR Administration	<ul style="list-style-type: none"> • API changes: CancelTransmit, CancelReceive, and ChangeParameter were changed to synchronous behavior
2011-04-15	4.0.2	AUTOSAR Administration	<ul style="list-style-type: none"> • Fixed service API IDs • Removed duplicate requirement J1939TP0099 • Clarified requirements SWS_J1939Tp_00125 and SWS_J1939Tp_00189
2009-12-18	4.0.1	AUTOSAR Administration	<ul style="list-style-type: none"> • Initial release

Disclaimer

This work (specification and/or software implementation) and the material contained in it, as released by AUTOSAR, is for the purpose of information only. AUTOSAR and the companies that have contributed to it shall not be liable for any use of the work.

The material contained in this work is protected by copyright and other types of intellectual property rights. The commercial exploitation of the material contained in this work requires a license to such intellectual property rights.

This work may be utilized or reproduced without any modification, in any form or by any means, for informational purposes only. For any other purpose, no part of the work may be utilized or reproduced, in any form or by any means, without permission in writing from the publisher.

The work has been developed for automotive applications only. It has neither been developed, nor tested for non-automotive applications.

The word AUTOSAR and the AUTOSAR logo are registered trademarks.

Table of Contents

1	Introduction and Functional Overview	7
2	Glossary, Acronyms, and Abbreviations.....	9
3	Related Documentation	11
3.1	Input Documents	11
3.2	Related Standard Documents.....	12
3.3	Related specification.....	12
4	Constraints and Assumptions	13
4.1	Limitations	13
4.2	Applicability to Automotive Domains	13
5	Module Architecture	14
5.1	Dependencies on Other Modules	14
5.2	File Structure.....	14
5.2.1	Code File Structure	15
5.2.2	Header File Structure	15
6	Requirements Traceability	16
7	Functional Specification	21
7.1	Basic Principles of SAE J1939	21
7.2	Basic Functionality of J1939Tp.....	22
7.3	Initialization and Shutdown	23
7.4	Communication with the Lower Layer	24
7.4.1	Transmission Confirmation	24
7.4.2	Reception Indication.....	24
7.5	Internal Behavior	25
7.5.1	Session Handling	25
7.5.1.1	Close Transmission	25
7.5.1.2	Abort Transmission.....	25
7.5.1.3	Close Reception	25
7.5.1.4	Abort Reception.....	25
7.5.1.5	Abort CMDT Connection	25
7.5.2	N-SDU Reception.....	26
7.5.3	N-SDU Transmission.....	27
7.5.4	Data Flow on the CAN Bus	29
7.5.4.1	Data Flow using Direct Transmission.....	29
7.5.4.2	Data Flow using CMDT	29
7.5.4.3	Data Flow using BAM	33
7.5.5	N-SDU Buffer Management	34
7.5.6	Relationship between N-SDU and N-PDU in J1939Tp.....	36
7.5.7	Concurrent Connections	37
7.5.8	N-PDU Padding.....	38
7.5.9	Handling of Unexpected N-PDU Arrivals	38
7.6	Error Classification.....	38
7.6.1	Development Errors	38
7.6.2	Runtime Errors	39

7.6.3	Transient Faults.....	40
7.6.4	Production Errors	40
7.6.5	Extended Production Errors	40
8	API Specification	41
8.1	API Parameter Checking	41
8.2	Imported Types	41
8.3	Type Definitions	41
8.4	Function Definitions	42
8.4.1	J1939Tp_Init.....	42
8.4.2	J1939Tp_Shutdown	43
8.4.3	J1939Tp_GetVersionInfo	44
8.4.4	J1939Tp_Transmit	45
8.4.5	J1939Tp_CancelTransmit	46
8.4.6	J1939Tp_CancelReceive	47
8.4.7	J1939Tp_ChangeParameter.....	47
8.5	Callback Notifications.....	48
8.5.1	J1939Tp_RxIndication	48
8.5.2	J1939Tp_TxConfirmation.....	49
8.6	Scheduled Functions	50
8.6.1	J1939Tp_MainFunction.....	50
8.7	Expected Interfaces	51
8.7.1	Mandatory Interfaces.....	51
8.7.2	Optional Interfaces	51
9	Sequence Diagrams.....	53
9.1	Reception of Direct PG	53
9.2	Reception via BAM	53
9.3	Reception via CMDT.....	54
9.4	Transmission of Direct PG.....	55
9.5	Transmission via BAM	56
9.6	Transmission via CMDT.....	57
9.7	Handling of Retry during CMDT Transmission.....	58
10	Configuration Specification.....	60
10.1	Containers and Configuration Parameters.....	60
10.1.1	J1939Tp	65
10.1.2	J1939TpGeneral	65
10.1.3	J1939TpConfiguration.....	68
10.1.4	J1939TpRxChannel	68
10.1.5	J1939TpRxCmNPdu.....	74
10.1.6	J1939TpRxDtNPdu	75
10.1.7	J1939TpRxFcNPdu	77
10.1.8	J1939TpRxDirectNPdu	78
10.1.9	J1939TpRxNSdu.....	79
10.1.10	J1939TpTxFcNPdu	81
10.1.11	J1939TpTxChannel.....	82
10.1.12	J1939TpRxFcNPdu.....	87
10.1.13	J1939TpTxCmNPdu	89
10.1.14	J1939TpTxDtNPdu	90
10.1.15	J1939TpTxPg.....	91

10.1.16	J1939TpTxDirectNPdu.....	93
10.1.17	J1939TpTxNSdu	94
10.2	Published Information	95
11	Not applicable requirements	96

1 Introduction and Functional Overview

This specification describes the functionality, the API, and the configuration of the AUTOSAR Basic Software module J1939Tp, which implements an SAE J1939 compatible transport layer for AUTOSAR. The terms J1939Tp and J1939 Transport Layer module are used synonymously in this document.

SAE J1939 has a broad acceptance in the truck domain, and consists of several documents describing the layers of the communication protocol from the physical layer to diagnostics and the application layer. SAE J1939-21 describes the data link and transport layer, which includes two transport protocol variants: BAM (Broadcast Announce Message) for broadcast messages, and CMDT (Connection Mode Data Transfer) for point-to-point connections.

This specification defines how the transport protocol of SAE J1939-21 can be implemented in the AUTOSAR architecture. It only describes those parts of the implementation that are relevant to the AUTOSAR architecture. Protocol specific details like exact timings are not part of this specification. Therefore, to be able to implement the J1939 Transport Layer module, the reader of this specification must have access to the original SAE J1939-21 specification document.

The module J1939Tp interfaces to the PDU Router and the CAN Interface, as shown in the following figure:

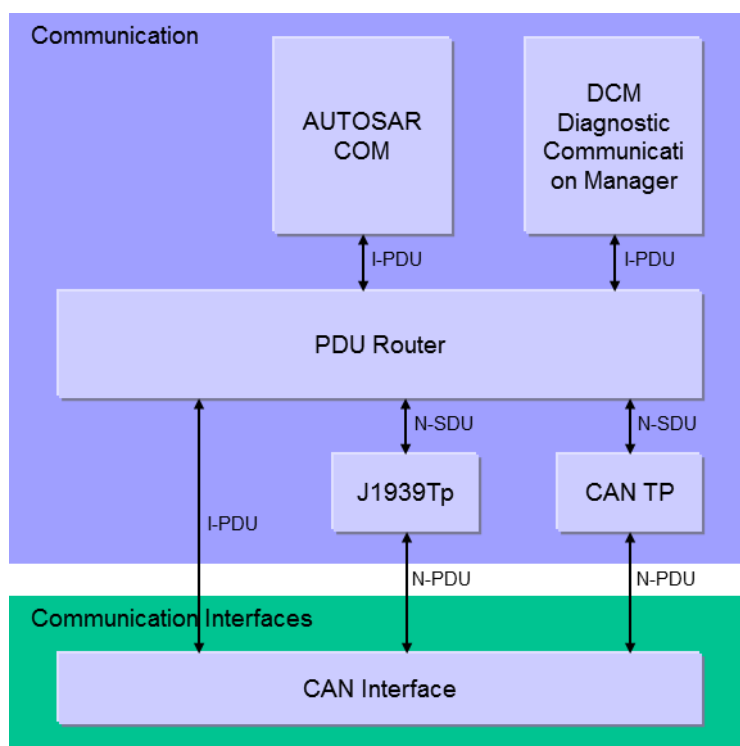

Figure 1-1 : AUTOSAR Communication Stack

The purpose of J1939Tp is to segment and reassemble J1939 PGNs (N-SDUs) that are longer than 8 bytes. The segmented messages are sent and received via the CAN Interface.

The PDU-Router (PduR) deploys AUTOSAR COM and DCM I-PDUs onto different communication protocols (e.g. CAN or J1939, segmented via transport layer or directly). At runtime, the PduR decides where to route I-PDUs based on the I-PDU (L-SDU or N-SDU) identifier. In the same way, the CanIf uses the L-SDU (I-PDU or N-PDU) identifier to decide whether a received message must be processed by one of the available transport layer modules or may be forwarded directly to the PduR.

J1939Tp supports fixed and variable size N-SDUs (I-PDUs) with more than 8 bytes. I-PDUs that do not exceed 8 bytes are exchanged directly between PduR and CanIf.

Fixed size N-SDUs are always segmented by the J1939Tp, while variable size N-SDUs are only segmented when they exceed 8 bytes. J1939Tp forwards variable size N-SDUs with an actual size of 8 bytes or less and a configured maximum size of more than 8 bytes directly to the CanIf. The transport protocol variant (BAM or CMDT) is chosen based on received N-PDUs when a large N-SDU is received, and on the configuration and the actual DA when a large N-SDU is transmitted.

J1939Tp supports handling of N-PDUs and N-SDUs with variable SA, DA, and Priority. In this case, the N-PDUs and N-SDUs will contain parts of the CAN ID in the MetaData.

In summary, J1939Tp provides the following functionality:

- Segmentation and direct transmission of data in transmit direction
- Reassembling and direct reception of data in receive direction
- Control of data flow
- Timeout supervision
- Detection of errors during segmentation or reassembly

2 Glossary, Acronyms, and Abbreviations

The following table presents a glossary of J1939 specific terms. For all other terms, please check the AUTOSAR Glossary.

<i>Glossary Term</i>	<i>Explanation</i>
Address Claiming	Address Claiming forms the network management of SAE J1939 defined in the standard document SAE J1939/81. Address claiming assigns a temporary 8-bit identifier to each ECU connected to one J1939 network. Within this network, the 8-bit identifier is unique. The 8-bit identifier is used as source and target address of parameter groups (messages) transferred via the J1939 network. The address claiming procedure is based on the exchange of AddressClaimed messages (PGN 00EE00).
J1939 Diagnostics	The SAE J1939 diagnostic layer is defined in the standard document SAE J1939/73. The J1939 diagnostics is functionally similar to the UDS diagnostics, and has recently been extended to support OBD for emission relevant values.
Parameter	A parameter is a signal of the SAE J1939 application layer. Parameters are uniquely identified by the SPN.
Parameter Group	A parameter group is a message of the SAE J1939 application layer. Each parameter group contains several parameters (signals), and is uniquely identified by the PGN.
Transport Protocol	The SAE J1939 transport protocol is used for the segmented transmission of messages with more than 8 bytes of data. The transport protocol is defined in the network layer standard document (SAE J1939/21).

The following table lists acronyms and abbreviations that are specific to the J1939 transport layer. For all other abbreviations, please check the AUTOSAR Glossary and the AUTOSAR BSW Module List.

Acronym / Abbreviation	Description
BAM	Broadcast Announce Message, broadcast variant of SAE J1939 transport protocol
CMDT	Connection Mode Data Transfer, peer-to-peer variant of SAE J1939 transport protocol
DA	Destination Address, part of the 29 bit identifier of SAE J1939 messages
DET	Default Error Tracer, supports development and runtime error reporting
DMx	Diagnostic messages of the SAE J1939 diagnostics layer
NAME	Unique 64 bit identifier of each ECU connected to an SAE J1939 network
PDUF	PDU Format, part of the 29 bit identifier of SAE J1939 messages which identifies the message and determines the layout of the 29 bit identifier
PDUS	PDU Specific, part of the 29 bit identifier of SAE J1939 messages which identifies broadcast messages which do not have a destination address
PG	Parameter Group, SAE J1939 term for a specific message layout, corresponds to an N-SDU of J1939Tp
PGN	Parameter Group Number, unique identifier of an SAE J1939 parameter group
SA	Source Address, part of the 29 bit identifier of SAE J1939 messages
SPN	Suspect Parameter Number, unique identifier of an SAE J1939 parameter
TP.CM	Connection Management message (PGN 00EC00) used by SAE J1939 transport protocol, corresponds to an N-PDU of J1939Tp
TP.CM_BAM	Broadcast Announce Message, variant of TP.CM that initiates a BAM transmission
TP.CM_CTS	Connection Mode Clear To Send, variant of TP.CM that is used for handshake during CMDT transmission
TP.CM_EndOfMsg Ack	End Of Message Acknowledge, variant of TP.CM that acknowledges correct reception of a CMDT transmission
TP.CM_RTS	Connection Mode Request To Send, variant of TP.CM that initiates a CMDT transmission
TP.Conn_Abort	Connection Abort, variant of TP.CM that terminates a CMDT transmission
TP.DT	Data Transfer message (PGN 00EB00) used by SAE J1939 transport protocol, corresponds to an N-PDU of J1939Tp

3 Related Documentation

3.1 Input Documents

- [1] List of Basic Software Modules
AUTOSAR_TR_BSWModuleList.pdf

- [2] Layered Software Architecture
AUTOSAR_EXP_LayeredSoftwareArchitecture.pdf

- [3] General Requirements on Basic Software Modules
AUTOSAR_SRS_BSWGeneral.pdf

- [4] Specification of COM
AUTOSAR_SWS_COM.pdf

- [5] Requirements on CAN
AUTOSAR_SRS_CAN.pdf

- [6] Specification of CAN Interface
AUTOSAR_SWS_CANInterface.pdf

- [7] Requirements on a Transport Layer for SAE J1939
AUTOSAR_SRS_SAEJ1939TransportLayer.pdf

- [8] Specification of PDU Router
AUTOSAR_SWS_PDURouter.pdf

- [9] Specification of BSW Scheduler
AUTOSAR_SWS_Scheduler.pdf

- [10] Specification of Default Error Tracer
AUTOSAR_SWS_DefaultErrorTracer.pdf

- [11] Basic Software Module Description Template
AUTOSAR_SRS_BSWGeneral.pdf

- [12] Specification of ECU Configuration
AUTOSAR_TPS_ECUConfiguration.pdf

- [13] Specification of System Template
AUTOSAR_TPS_SystemTemplate.pdf

- [14] Specification of Memory Mapping
AUTOSAR_SWS_MemoryMapping.pdf

- [15] General Specification of Basic Software Modules
AUTOSAR_SWS_BSWGeneral.pdf

3.2 Related Standard Documents

[16] SAE J1939-21(2006-12), Data Link Layer

[17] SAE J1939-7x(2006-xx), Application Layer

3.3 Related specification

AUTOSAR provides a General Specification of Basic Software modules [15] (SWS BSW General), which is also valid for SAE J1939 Transport Layer.

Thus, the specification SWS BSW General shall be considered as additional and required specification for SAE J1939 Transport Layer.

4 Constraints and Assumptions

4.1 Limitations

The AUTOSAR architecture contains several communication system specific transport layers (J1939Tp, CanTp, FrTp, etc.). All of these modules need to have identical APIs, with the exception of API functions for which the PduR has separate configuration abilities.

The J1939Tp module does not implement the TriggerTransmit API, because it is only needed for time triggered bus architectures.

4.2 Applicability to Automotive Domains

The J1939 transport layer supports the implementation of ECUs that are designed to operate in a J1939 network.

5 Module Architecture

5.1 Dependencies on Other Modules

This section describes the relations between the J1939Tp and other AUTOSAR basic software modules. Besides the standard modules DET, EcuM, and SchM, which have interfaces to all BSW modules, J1939Tp only interacts with the PduR and the CanIf. The interfaces of J1939Tp are similar to the interfaces of CanTp.

The figure below shows the interactions between J1939Tp, PduR, and CanIf.

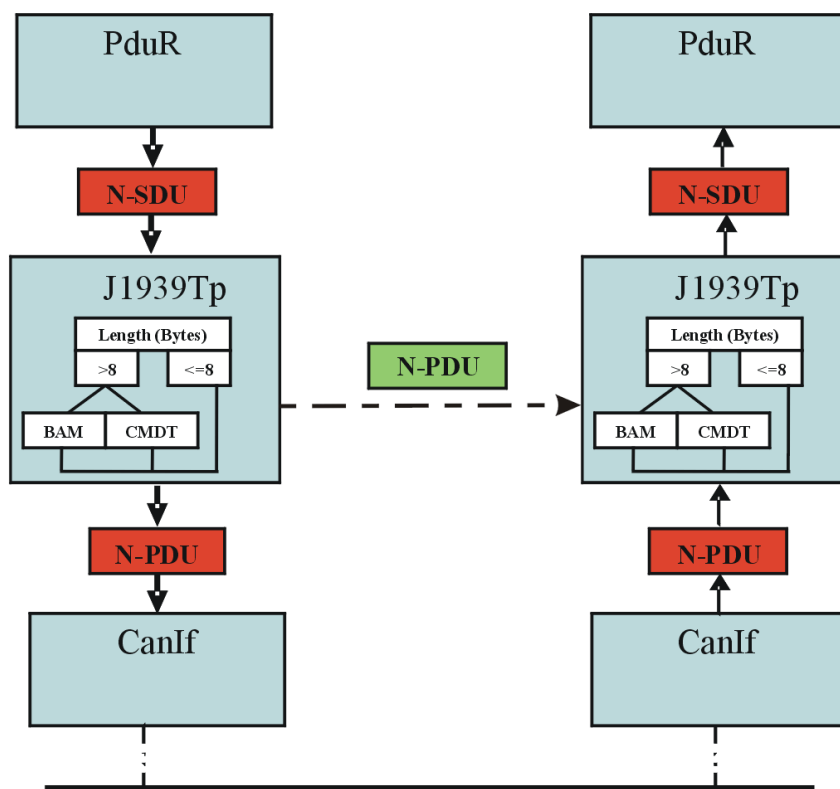

Figure 5-1: J1939 Transport Layer interactions

The J1939Tp's upper interface offers the PduR module access to transmitted and received N-SDUs corresponding to J1939 PGs with a maximum length of more than 8 bytes of data.

J1939 PGs with a maximum length of 8 bytes or less are exchanged directly between PduR and CanIf.

5.2 File Structure

AUTOSAR specifies that an ECU can be created from modules provided as object code, source code (generated or static), or both.

The decision to provide a module as object code or source code is based on a compromise between IP protection, test coverage, code efficiency and configurability at system generation time. Depending on the configurability requirements of the OEM, suppliers may deliver the J1939Tp module as object code or source code.

The file hierarchy defined in this section allows the separation of platform, compiler, and implementation specific definitions and declarations from general definitions, as well as the separation of source code and configuration.

5.2.1 Code File Structure

For details, refer to the chapter 5.1.6 “Code file structure” in SWS BSW General [15].

[SWS_J1939Tp_00007] [

Internally used data types and functions shall be defined locally in the implementation source files.] ()

This prevents visibility of these symbols outside of the J1939Tp module.

5.2.2 Header File Structure

For details, refer to the chapter 5.1.7 “Header file structure” in SWS BSW General [15].

6 Requirements Traceability

Requirement	Description	Satisfied by
SRS_BSW_00005	Modules of the μ C Abstraction Layer (MCAL) may not have hard coded horizontal interfaces	SWS_J1939Tp_NA
SRS_BSW_00101	The Basic Software Module shall be able to initialize variables and hardware in a separate initialization function	SWS_J1939Tp_00087
SRS_BSW_00161	The AUTOSAR Basic Software shall provide a microcontroller abstraction layer which provides a standardized interface to higher software layers	SWS_J1939Tp_NA
SRS_BSW_00162	The AUTOSAR Basic Software shall provide a hardware abstraction layer	SWS_J1939Tp_NA
SRS_BSW_00164	The Implementation of interrupt service routines shall be done by the Operating System, complex drivers or modules	SWS_J1939Tp_NA
SRS_BSW_00167	All AUTOSAR Basic Software Modules shall provide configuration rules and constraints to enable plausibility checks	SWS_J1939Tp_00084
SRS_BSW_00168	SW components shall be tested by a function defined in a common API in the Basis-SW	SWS_J1939Tp_NA
SRS_BSW_00170	The AUTOSAR SW Components shall provide information about their dependency from faults, signal qualities, driver demands	SWS_J1939Tp_NA
SRS_BSW_00171	Optional functionality of a Basic-SW component that is not required in the ECU shall be configurable at pre-compile-time	SWS_J1939Tp_00125
SRS_BSW_00314	All internal driver modules shall separate the interrupt frame definition from the service routine	SWS_J1939Tp_NA
SRS_BSW_00323	All AUTOSAR Basic Software Modules shall check passed API parameters for validity	SWS_J1939Tp_00188
SRS_BSW_00325	The runtime of interrupt service routines and functions that are running in interrupt context shall be kept short	SWS_J1939Tp_NA
SRS_BSW_00327	Error values naming convention	SWS_J1939Tp_00115
SRS_BSW_00333	For each callback function it shall be specified if it is called from interrupt context or not	SWS_J1939Tp_00110, SWS_J1939Tp_00114
SRS_BSW_00335	Status values naming convention	SWS_J1939Tp_00019
SRS_BSW_00336	Basic SW module shall be able to shutdown	SWS_J1939Tp_00093
SRS_BSW_00337	Classification of development errors	SWS_J1939Tp_00115
SRS_BSW_00341	Module documentation shall contains all needed informations	SWS_J1939Tp_NA
SRS_BSW_00347	A Naming seperation of different instances of BSW drivers shall be in place	SWS_J1939Tp_NA
SRS_BSW_00357	For success/failure of an API call a standard	SWS_J1939Tp_00096

	return type shall be defined	
SRS_BSW_00358	The return type of init() functions implemented by AUTOSAR Basic Software Modules shall be void	SWS_J1939Tp_00087
SRS_BSW_00359	All AUTOSAR Basic Software Modules callback functions shall avoid return types other than void if possible	SWS_J1939Tp_00108, SWS_J1939Tp_00112
SRS_BSW_00360	AUTOSAR Basic Software Modules callback functions are allowed to have parameters	SWS_J1939Tp_00108, SWS_J1939Tp_00112
SRS_BSW_00373	The main processing function of each AUTOSAR Basic Software Module shall be named according the defined convention	SWS_J1939Tp_00104
SRS_BSW_00375	Basic Software Modules shall report wake-up reasons	SWS_J1939Tp_NA
SRS_BSW_00377	A Basic Software Module can return a module specific types	SWS_J1939Tp_NA
SRS_BSW_00385	List possible error notifications	SWS_J1939Tp_00115
SRS_BSW_00400	Parameter shall be selected from multiple sets of parameters after code has been loaded and started	SWS_J1939Tp_00187
SRS_BSW_00405	BSW Modules shall support multiple configuration sets	SWS_J1939Tp_00187
SRS_BSW_00406	A static status variable denoting if a BSW module is initialized shall be initialized with value 0 before any APIs of the BSW module is called	SWS_J1939Tp_00023
SRS_BSW_00407	Each BSW module shall provide a function to read out the version information of a dedicated module implementation	SWS_J1939Tp_00089
SRS_BSW_00413	An index-based accessing of the instances of BSW modules shall be done	SWS_J1939Tp_NA
SRS_BSW_00414	Init functions shall have a pointer to a configuration structure as single parameter	SWS_J1939Tp_00187
SRS_BSW_00415	Interfaces which are provided exclusively for one module shall be separated into a dedicated header file	SWS_J1939Tp_NA
SRS_BSW_00416	The sequence of modules to be initialized shall be configurable	SWS_J1939Tp_NA
SRS_BSW_00417	Software which is not part of the SW-C shall report error events only after the Dem is fully operational.	SWS_J1939Tp_NA
SRS_BSW_00419	If a pre-compile time configuration parameter is implemented as const it should be placed into a separate c-file	SWS_J1939Tp_NA
SRS_BSW_00423	BSW modules with AUTOSAR interfaces shall be describable with the means of the SW-C Template	SWS_J1939Tp_NA
SRS_BSW_00427	ISR functions shall be defined and documented in the BSW module description template	SWS_J1939Tp_NA

SRS_BSW_00433	Main processing functions are only allowed to be called from task bodies provided by the BSW Scheduler	SWS_J1939Tp_NA
SRS_BSW_00437	Memory mapping shall provide the possibility to define RAM segments which are not to be initialized during startup	SWS_J1939Tp_NA
SRS_BSW_00438	Configuration data shall be defined in a structure	SWS_J1939Tp_00187
SRS_BSW_00439	Enable BSW modules to handle interrupts	SWS_J1939Tp_NA
SRS_BSW_00440	The callback function invocation by the BSW module shall follow the signature provided by RTE to invoke servers via Rte_Call API	SWS_J1939Tp_NA
SRS_BSW_00441	Naming convention for type, macro and function	SWS_J1939Tp_00019, SWS_J1939Tp_00115
SRS_BSW_00447	Standardizing Include file structure of BSW Modules Implementing Autosar Service	SWS_J1939Tp_NA
SRS_BSW_00449	BSW Service APIs used by Autosar Application Software shall return a Std_ReturnType	SWS_J1939Tp_NA
SRS_BSW_00450	A Main function of a un-initialized module shall return immediately	SWS_J1939Tp_00023
SRS_BSW_00453	BSW Modules shall be harmonized	SWS_J1939Tp_NA
SRS_J1939_00001	The J1939 Transport Layer module shall be configurable to support only transport protocol variant BAM	SWS_J1939Tp_00125
SRS_J1939_00005	The local addresses of the ECU shall be configurable	SWS_J1939Tp_NA
SRS_J1939_00007	The queue size for transmitted PGs shall be configurable	SWS_J1939Tp_NA
SRS_J1939_00008	Requestable PGNs shall be configurable	SWS_J1939Tp_NA
SRS_J1939_00009	The upper layers using J1939 Request Manager services shall be configurable	SWS_J1939Tp_NA
SRS_J1939_00010	The J1939 Transport Layer module shall implement an interface for initialization	SWS_J1939Tp_00024
SRS_J1939_00011	The J1939 Transport Layer services shall not be operational before initializing the module	SWS_J1939Tp_00023
SRS_J1939_00012	The J1939 Request Manager shall provide an interface for module initialization	SWS_J1939Tp_NA
SRS_J1939_00013	The J1939 Request Manager shall provide an interface for module shutdown	SWS_J1939Tp_NA
SRS_J1939_00014	The J1939 Request Manager shall forward incoming requests to configured destinations	SWS_J1939Tp_NA
SRS_J1939_00015	The J1939 Request Manager shall forward incoming acknowledgements to configured destinations	SWS_J1939Tp_NA
SRS_J1939_00016	The J1939 Request Manager shall provide an interface for transmission of request messages	SWS_J1939Tp_NA

SRS_J1939_00017	The J1939 Request Manager shall provide an interface for transmission of acknowledgement messages	SWS_J1939Tp_NA
SRS_J1939_00019	The J1939 Transport Layer module shall support the transport protocol variant BAM	SWS_J1939Tp_00155
SRS_J1939_00020	The AUTOSAR J1939 Transport Layer module shall support the transport protocol variant CMDT	SWS_J1939Tp_00155
SRS_J1939_00022	The timeout values of the J1939 transport protocol variants shall be supervised	SWS_J1939Tp_00018, SWS_J1939Tp_00121, SWS_J1939Tp_00123
SRS_J1939_00023	The J1939 Transport Layer module shall handle unexpected PDUs according to the SAE J1939 specification	SWS_J1939Tp_00018, SWS_J1939Tp_00064
SRS_J1939_00024	Unused Bytes in N-PDUs shall be padded	SWS_J1939Tp_00068
SRS_J1939_00025	The J1939 Transport Layer module shall be able to manage connections via BAM and CMDT in parallel	SWS_J1939Tp_00062
SRS_J1939_00026	The J1939 Request Manager shall support timeout supervision for outgoing requests	SWS_J1939Tp_NA
SRS_J1939_00027	The channels on which the J1939 Network Management module is active shall be configurable	SWS_J1939Tp_NA
SRS_J1939_00028	The local addresses of the ECU shall be configurable	SWS_J1939Tp_NA
SRS_J1939_00029	The NAMEs used for claiming of each configured address shall be configurable	SWS_J1939Tp_NA
SRS_J1939_00030	The J1939 Network Management module shall provide an interface for module initialization	SWS_J1939Tp_NA
SRS_J1939_00031	The J1939 Network Management module shall provide an interface for module shutdown	SWS_J1939Tp_NA
SRS_J1939_00032	The J1939 Network Management module shall report a failed address claim to the Diagnostic Event Manager	SWS_J1939Tp_NA
SRS_J1939_00033	The J1939 Network Management module shall perform an initial address claim at startup	SWS_J1939Tp_NA
SRS_J1939_00034	The J1939 Network Management module shall react correctly to contending address claims	SWS_J1939Tp_NA
SRS_J1939_00035	The J1939 Network Management module shall react to requests for the AddressClaimed PG	SWS_J1939Tp_NA
SRS_J1939_00036	The J1939 Network Management module shall only allow communication after a successful address claim	SWS_J1939Tp_NA
SRS_J1939_00037	The J1939 Network Management module shall delay communication after initial address	SWS_J1939Tp_NA

	claim	
SRS_J1939_00040	The AUTOSAR J1939 Transport Layer module shall be based on SAE J1939 specifications	SWS_J1939Tp_00018
SRS_J1939_00042	The J1939 Transport Layer interface shall be independent of its internal configuration	SWS_J1939Tp_00157
SRS_J1939_00050	The J1939 Request Manager shall route incoming requests and acknowledgements to connected channels	SWS_J1939Tp_NA
SRS_J1939_00051	The J1939 Network Management module shall route received address claims to connected channels	SWS_J1939Tp_NA
SRS_J1939_NA	-	SWS_J1939Tp_NA

7 Functional Specification

This chapter describes the functionality of the AUTOSAR J1939 Transport Layer. It explains the services provided to the upper and lower layers and the internal behavior of J1939Tp.

7.1 Basic Principles of SAE J1939

The SAE J1939 standard defines a set of Parameter Groups (PGs), each containing signals with defined content and semantics. The following information is provided for each PG:

- Payload length type: maximal number of bytes, fixed or variable size.
- Parameter Group Number (PGN): 18 bit value containing the following fields:
 - o 2 bit data page information (DP and EDP)
 - o 8 bit PDU-Format (PF)
 - o 8 bit PDU-Specific (PS)

PGNs with PDU-Format < 240 (format 1) identify point-to-point messages, while PGNs with PDU-Format >= 240 (format 2) identify broadcast messages. The PDU-Specific field is only relevant for broadcast messages (format 2); it is always zero for point-to-point messages (format 1).

J1939 uses 29-bit CAN identifiers to identify each message. The CAN identifier contains a 3-bit-priority, the PGN, the Source Address (SA), and the Destination Address (DA, only for point-to-point messages).

Usually, an ECU has just one node address, which is used as DA in received messages and as SA in transmitted messages. However, a single ECU can also implement several different J1939 nodes at once, each with its own node address. In this case, the ECU accepts any of these node addresses as DA and sends with any of the defined node addresses as SA.

The SAE J1939 transport layer uses two special point-to-point messages identified by PGNs of format 1 to transport segmented messages, both with a fixed length of 8 bytes. These messages are called transport frames in the context of this document.

TP.CM is used for connection management. The first byte of the payload identifies its role, which may be one of the following:

TP.CM_BAM is used to initiate a BAM transfer.

TP.CM_RTS is transmitted to initiate a CMDT transfer.

TP.CM_CTS is used for flow control during a CMDT transfer.

TP.CM_EndOfMsgAck indicates the end of a CMDT transfer.

TP.Conn_Abort indicates an error and terminates the CMDT transfer.

TP.DT contains a sequence number in the first byte and 7 bytes of data.

A single TP.CM or TP.DT frame, identified by a certain CAN Identifier, is used for different PGs. The PGN of the transported PG is contained in the payload of the TP.CM frames as specified in [16].

The destination address (DA) of CMDT related transport frames contains a legal node address and thus allows a point-to-point connection, while the DA of BAM related transport frames is always set to FF₁₆ to create a broadcast connection.

[SWS_J1939Tp_00018] [

The J1939Tp module shall follow the recommendations of SAE J1939-21 [16] if they are not explicitly excluded in this document.] (SRS_J1939_00022, SRS_J1939_00023, SRS_J1939_00040)

7.2 Basic Functionality of J1939Tp

This section describes aspects of the functionality of J1939Tp that are not related to neighboring modules.

[SWS_J1939Tp_00071] [

On errors and exceptions, the J1939Tp module shall not modify its current module state (see Figure 7-1: J1939 Transport Layer life cycle) but shall simply report the error event.] ()

To assure a unique PDU router handling of all J1939 PGs which is independent of the Payload Length type (variable or fixed), the J1939Tp is used for the transmission of all Parameter Groups that are longer than 8 Bytes, independent of their length being fixed or variable.

This means that PGs with variable length that have a configured maximum size of more than 8 bytes but do not exceed 8 bytes at runtime shall be transported using J1939Tp even though no segmentation is necessary and a direct transmission from PDU router to CAN Interface would be possible.

[SWS_J1939Tp_00155] [

The J1939 transport layer shall implement the following two J1939 transport protocol variants defined in [16]:

- BAM for broadcast transmission
- CMDT for point-to-point transmission] (SRS_J1939_00019, SRS_J1939_00020)

[SWS_J1939Tp_00125] [

The J1939 Transport Layer shall be configurable to either use both BAM and CMDT transport protocol variants, or only BAM, or only CMDT.] (SRS_BSW_00171, SRS_J1939_00001)

[SWS_J1939Tp_00198] [

The J1939 Transport Layer shall use meta data items of type SOURCE_ADDRESS_16, TARGET_ADDRESS_16, and PRIORITY_8 of all N-SDUs, and meta data items of type CAN_ID_32 for all N-PDUs.] ()

[SWS_J1939Tp_00231] [

The J1939 Transport Layer module shall support several connections for the same PGN in parallel as long as they can be received or transmitted independently.] ()

For the definition of connections see section 7.5.7.

[SWS_J1939Tp_00233] [

If several receiving connections are configured with identical PGNs and matching channel parameters, the J1939Tp shall allocate an arbitrary free connection with matching parameters.] ()

Note: This scenario is typically only useful if all of these similar connections are configured to end up at the same upper layer module.

7.3 Initialization and Shutdown

The following figure summarizes all the requirements concerning initialization and shut down:

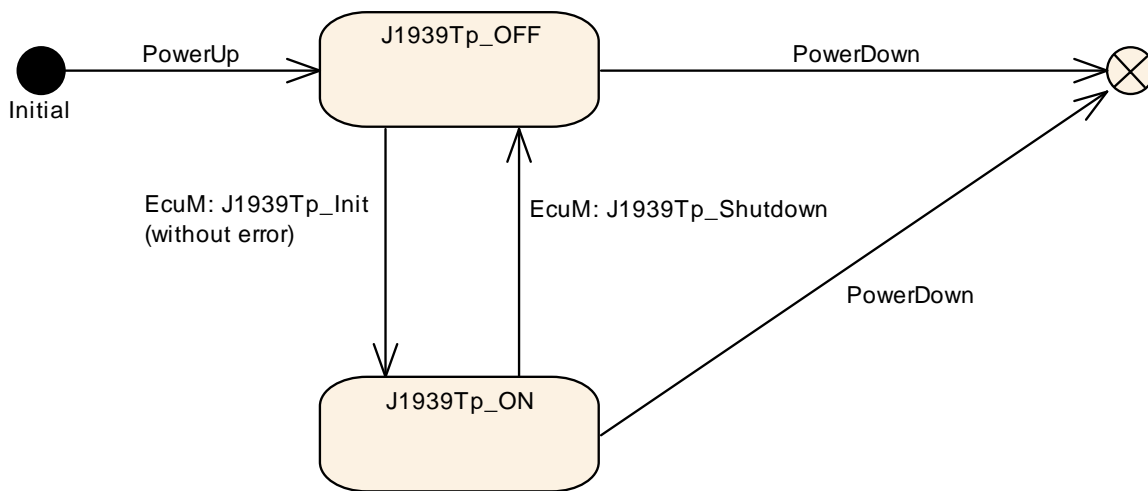

Figure 7-1: J1939 Transport Layer life cycle

[SWS_J1939Tp_00019] [

The J1939Tp module shall have two global states, J1939TP_ON and J1939TP_OFF.] (SRS_BSW_00335, SRS_BSW_00441)

[SWS_J1939Tp_00020] [

The J1939Tp module shall be in the J1939TP_OFF state after power up.] ()

In the state J1939TP_OFF, the J1939Tp allows for an update of the post build configuration.

[SWS_J1939Tp_00023] [

The J1939Tp module shall perform segmentation and reassembly tasks only when the J1939Tp is in the `J1939TP_ON` state.] (SRS_BSW_00406, SRS_BSW_00450, SRS_J1939_00011)

[SWS_J1939Tp_00076] [

The global state (see **SWS_J1939Tp_00019**) shall be used to check if the module has been initialized before calling an API.] ()

7.4 Communication with the Lower Layer

[SWS_J1939Tp_00157] [

All service interfaces provided to the lower layer shall be independent of the internal communication configuration and implementation of the J1939Tp.] (SRS_J1939_00042)

[SWS_J1939Tp_00041] [

J1939Tp shall send the transport frames TP.CM and TP.DT and direct frames using the service function `CanIf_Transmit()`.] ()

7.4.1 Transmission Confirmation

The transmission confirmation `J1939Tp_TxConfirmation()` is called by `CanIf` to notify J1939 TP of successful or failed transmission of an N-PDU.

[SWS_J1939Tp_00035] [

When `J1939Tp_TxConfirmation()` is called with result `E_NOT_OK`, the J1939Tp module shall abort the corresponding session.] ()

For transmitting sessions, the session abort is defined in **SWS_J1939Tp_00032**, while **SWS_J1939Tp_00031** defines the behavior in case of a receiving session. The J1939Tp shall not try to send an abort frame (as defined by **SWS_J1939Tp_00097**) in this case.

7.4.2 Reception Indication

The J1939Tp module shall provide a `J1939Tp_RxIndication()` API to allow the `CanIf` to notify that a new N-PDU has been received (see [SWS_J1939Tp_00108](#)). `CanIf` shall perform the Reception Indication according to its configuration (i.e. in ISR context if configured so).

7.5 Internal Behavior

7.5.1 Session Handling

7.5.1.1 Close Transmission

[SWS_J1939Tp_00119] [

When the transport transmission session is successfully completed, the J1939Tp module shall call a notification service of the upper layer, `PduR_J1939TpTxConfirmation`, with the result `E_OK`, to notify that the N-SDU transfer is successfully processed.] ()

7.5.1.2 Abort Transmission

[SWS_J1939Tp_00032] [

An Abort Transmission feature shall indicate the upper layer that the transmission of a given N-SDU has been aborted. It uses the callback function `PduR_J1939TpTxConfirmation` with `E_NOT_OK`.] ()

7.5.1.3 Close Reception

[SWS_J1939Tp_00118] [

A close connection feature shall indicate the upper layer that the transport reception session is completed. It uses the `PduR_J1939TpRxIndication()` with `E_OK` to indicate that the N-SDU reception is successfully processed.] ()

7.5.1.4 Abort Reception

[SWS_J1939Tp_00031] [

An Abort Reception feature shall indicate the upper layer that the reception of a given N-SDU has been aborted. It uses the `PduR_J1939TpRxIndication()` with state `E_NOT_OK`.] ()

7.5.1.5 Abort CMTD Connection

[SWS_J1939Tp_00097] [

An Abort CMTD Connection feature shall indicate to the other ECU participating in the concerned connection that the current CMTD session (transmission or reception) cannot be completed successfully. A `TP.Conn_Abort` abort message shall be transmitted to the other ECU via CAN as specified by [16].] ()

Sending a `TP.Conn_Abort` is necessary every time an error happens after `TP.CM_CTS` has been successfully sent or received, and is advisable already after

transmission or reception of TP.CM_RTS. The connection abort reason of the TP.Conn_Abort shall be set according to [16].

7.5.2 N-SDU Reception

Reception of an N-SDU is always initiated by the reception of a TP.CM message. In case of CMDT, this is a TP.CM_RTS, in case of BAM a TP.CM_BAM.

[SWS_J1939Tp_00043] [

Depending on the control byte of the initializing TP.CM frame (BAM or RTS), the J1939Tp module shall use the variant BAM or CMDT of the J1939 transport protocol to handle the data reception.] ()

[SWS_J1939Tp_00038] [

When receiving an N-PDU containing a TP.CM_BAM or a TP.CM_RTS the J1939Tp module shall first notify the upper layer (PDU Router) before processing the frame reassembly. It uses the `PduR_J1939TpStartOfReception` function with the following parameters:

- the Identifier of the corresponding N-SDU,
- depending on the configured meta data items: the SA, DA and Priority,
- the total Data Length (after reassembly) and
- a pointer to a location where the upper layer stores its currently available buffer size.] ()

[SWS_J1939Tp_00162] [

After the reception of an N-PDU containing a TP.DT frame, the function `PduR_J1939TpCopyRxData` shall be called with the following parameters:

- the Identifier of the corresponding N-SDU,
- `PduInfoPtr` with max. 7 bytes of data,
- a pointer to a location where the upper layer stores its currently available buffer size.] ()

[SWS_J1939Tp_00173] [

The J1939Tp module shall abort the reception silently if any of the following conditions occurs:

- The `PduR_J1939TpStartOfReception` function returns `BUFREQ_E_NOT_OK` or `BUFREQ_E_OVFL` or
- the protocol chosen in **SWS_J1939Tp_00043** does not match the transport protocol configured for the transported PGN (see [ECUC_J1939Tp_00029]) or
- the SA/DA of N-PDUs with MetaData do not match the configured SA/DA (see [ECUC_J1939Tp_00179]/[ECUC_J1939Tp_00178]).

In case of a BAM connection, no further activity is required.

In case of a CMDT connection, a CMDT Connection Abort shall be performed as described in **SWS_J1939Tp_00097**, and the connection abort reason shall be set to 1 (Already in one or more connection managed sessions and cannot support another).] ()

[SWS_J1939Tp_00040] [

The J1939Tp module shall abort the reception like indicated in **SWS_J1939Tp_00031** if any of the following conditions occurs:

- The value returned by `PduR_J1939TpStartOfReception` via `bufferSizePtr` is smaller than the total data length of the N-SDU when received via the direct N-PDU,
- the `PduR_J1939TpCopyRxData` function returns `BUFREQ_E_NOT_OK`, or
- the `J1939Tp_CancelReceive` function is called.

In case of a BAM connection, no further activity is required.

In case of a CMDT connection, a CMDT Connection Abort shall be performed as described in **SWS_J1939Tp_00097**, and the connection abort reason shall be set to 1 (Already in one or more connection managed sessions and cannot support another) after the call to `PduR_J1939TpStartOfReception`, and to 2 (System resources were needed for another task so this connection managed session was terminated) in the other two cases.] ()

7.5.3 N-SDU Transmission

As described in section 7.3.2, the upper layer (PDU Router) asks for the transmission of an N-SDU by calling `J1939Tp_Transmit()`. The parameters of `J1939Tp_Transmit()` describe the Identifier of the N-SDU (`NSdulId`) and a reference to a `PduInfoType` that indicates the full length of the N-SDU to transmit (full Tx N-SDU data length) and a pointer to the payload N-SDU, which may contain `MetaData` with SA, DA and Priority depending on the meta data configuration of the N-SDU.

[SWS_J1939Tp_00039] [

When configured, the transport protocol variant (BAM/CMDT, see [\[ECUC_J1939Tp_00137\]](#)) and the SA/DA (see [\[ECUC_J1939Tp_00181\]](#)/[\[ECUC_J1939Tp_00180\]](#)) shall be used for transmission. For N-SDUs with `MetaInfo`, these parameters are optional. If SA or DA is not configured, the value provided via the `MetaData` shall be used. If the transport protocol is not configured, it shall be chosen based on the actual DA: BAM when DA is 0xFF, CMDT otherwise.] ()

[SWS_J1939Tp_00045] [

The function `J1939Tp_Transmit` shall use the `NSdulId` and the `SduLength` provided in the `PduInfoType` structure. It shall not use the payload of N-SDUs, only the contained `MetaData`.] ()

[SWS_J1939Tp_00047] [

After a transmission request from the upper layer, the J1939Tp module shall initiate the transmission by sending:

- For CMDT: a TP.CM_RTS frame
- For BAM: a TP.CM_BAM frame] ()

[SWS_J1939Tp_00046] [

For each TP.DT frame to be sent, the J1939Tp module shall previously call `PduR_J1939TpCopyTxData` with the following parameters:

- the Identifier of the corresponding N-SDU,
 - `PduInfoType` structure with up to 7 bytes as `SduLength`,
 - the retry parameter, and
 - a pointer to a location where the upper layer stores its currently available data.
-] ()

[SWS_J1939Tp_00228] [

When `PduR_J1939TpCopyTxData` returns `BUFREQ_E_BUSY`, the J1939Tp shall retry the call to `PduR_J1939TpCopyTxData` until the data is available or a timeout occurs.] ()

[SWS_J1939Tp_00218] [

If `J1939TpTxRetrySupport` is disabled, the parameter `retry` of `PduR_J1939TpCopyTxData` shall always be set to the `NULL_PTR`.] ()

[SWS_J1939Tp_00219] [

For BAM transmissions, the parameter `retry` of `PduR_J1939TpCopyTxData` shall always be set to the `NULL_PTR`.] ()

[SWS_J1939Tp_00220] [

If `J1939TpTxRetrySupport` is enabled, a valid `RetryInfoType` struct shall be provided via the parameter `retry` of `PduR_J1939TpCopyTxData` during CMDT transmissions.] ()

See section 7.5.4.2 for a description how the J1939 Transport Layer module uses the `RetryInfoType` during CMDT transmission.

[SWS_J1939Tp_00048] [

The J1939Tp module shall abort the transmission session like specified in **SWS_J1939Tp_00032** if any of the following conditions occur:

- The upper Layer returns the `PduR_J1939TpCopyTxData` function call with `BUFREQ_E_NOT_OK` or
- the `J1939Tp_CancelTransmit` function is called.

In case of a CMDT connection, a CMDT Connection Abort shall be performed as described in **SWS_J1939Tp_00097**, and the connection abort reason shall be set to 2 (System resources were needed for another task so this connection managed session was terminated).] ()

7.5.4 Data Flow on the CAN Bus

7.5.4.1 Data Flow using Direct Transmission

The following figure shows an example of direct message transmission between two ECUs using J1939Tp. This is the only case of transmission of a J1939Tp N-SDU using no TP.CM or TP.DT frame. The SA is always included in the CAN identifier. Depending on the PDU-Format of the concerned PG, the CAN Identifier might contain the DA.

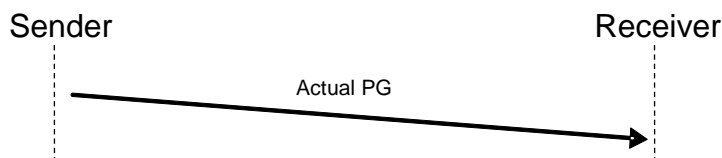

Figure 7-2: Example of direct data flow for PGs of variable length <= 8 Bytes

7.5.4.2 Data Flow using CMDT

The following figure shows an example of segmented message transmission between two ECUs using CMDT as transport protocol variant. The CMDT transport protocol variant is used for peer-to-peer communication (i.e. 1 to 1 communication, like physical addressing in diagnostics). In the example, the transmitted PG has a total length of 16 bytes, which corresponds to 3 blocks of 7 bytes.

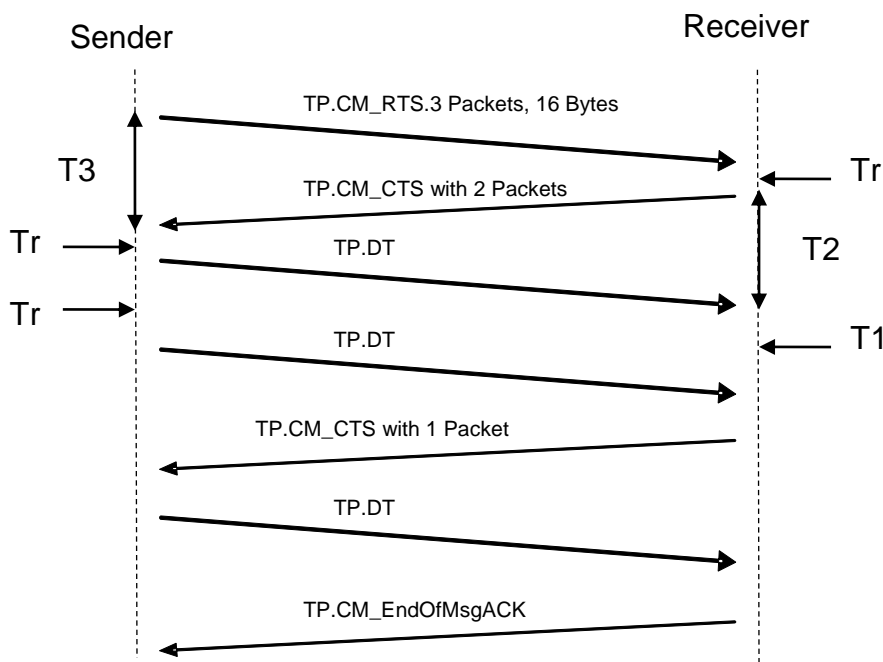

Figure 7-3: Example of data flow without error using CMDT as transport protocol variant

The J1939 transport protocol uses the initial sequence of RTS and CTS to determine the number of packets per block.

[SWS_J1939Tp_00165] [

If J1939TpTxDynamicBlockCalculation is enabled, after J1939Tp_Transmit has been called, the J1939Tp shall call PduR_J1939TpCopyTxData once with info->SduLength set to 0 and retry set to NULL_PTR to obtain the available amount of data via availableDataPtr.] ()

[SWS_J1939Tp_00207] [

If J1939TpTxDynamicBlockCalculation and J1939TpTxMaxPacketsPerBlock are enabled, the J1939Tp shall compare the available amount of data returned by PduR_J1939TpCopyTxData to J1939TpTxMaxPacketsPerBlock and use the smaller of these two values to calculate the maximum number of packets field of the TP.CM_RTS message.] ()

[SWS_J1939Tp_00208] [

If J1939TpTxDynamicBlockCalculation is enabled but J1939TpTxMaxPacketsPerBlock is disabled, the J1939Tp shall use the available amount of data returned by PduR_J1939TpCopyTxData to calculate the maximum number of packets field of the TP.CM_RTS message.] ()

[SWS_J1939Tp_00209] [

If J1939TpTxDynamicBlockCalculation is disabled, the J1939Tp shall use J1939TpTxMaxPacketsPerBlock for the maximum number of packets field of the TP.CM_RTS message.] ()

[SWS_J1939Tp_00210] [

If J1939TpRxDynamicBlockCalculation and J1939TpRxPacketsPerBlock are enabled, the J1939Tp shall compare the value returned by PduR_J1939TpStartOfReception for the available buffer size to J1939TpRxPacketsPerBlock and use the lower value to calculate the number of packets field of the TP.CM_CTS message.] ()

[SWS_J1939Tp_00211] [

If J1939TpRxDynamicBlockCalculation is enabled but J1939TpRxPacketsPerBlock is disabled, the J1939Tp shall use the value returned by PduR_J1939TpStartOfReception for the available buffer size to calculate the number of packets field of the TP.CM_CTS message.] ()

[SWS_J1939Tp_00226] [

After reception of the TP.CM_RTS and after reception of the last N-PDU of a block, if the reported buffer size is large enough for the next block, the J1939Tp shall transmit a TP.CM_CTS message requesting the next block. The number of packets requested by TP.CM_CTS shall be constant during the complete reception of one N-SDU, only in the last TP.CM_CTS this number shall be reduced to the number of remaining packets.] ()

[SWS_J1939Tp_00227] [

When there is not enough buffer reported by `PduR_J1939TpStartOfReception` or `PduR_J1939TpCopyRxData` for the reception of a complete block, the J1939Tp shall call `PduR_J1939TpCopyRxData` with `info->SduLength` set to 0 until the buffer is large enough for one block, or a timeout occurs.] ()

Please note: A timeout can be a timeout of an expected message (e.g. T1) or a timeout during transmission of a message (e.g. Tr).

[SWS_J1939Tp_00229] [

While monitoring the buffer state as defined by **SWS_J1939Tp_00227**, the J1939Tp shall send TP.CM_CTS wait frames (number of packets set to 0, see also [16]) according to the timing requirements defined in [16].] ()

[SWS_J1939Tp_00212] [

If J1939TpRxRetrySupport is enabled, the J1939Tp shall adapt the value returned by `PduR_J1939TpStartOfReception` for the available buffer size according to `J1939TpRxDynamicBufferRatio` before using it to calculate the number of packets field of the TP.CM_CTS message as specified in **SWS_J1939Tp_00210** and **SWS_J1939Tp_00211**.] ()

[SWS_J1939Tp_00213] [

If `J1939TpRxDynamicBlockCalculation` is disabled, the J1939Tp shall use `J1939TpRxPacketsPerBlock` to calculate the number of packets field of the TP.CM_CTS message.] ()

[SWS_J1939Tp_00217] [

If `J1939TpTxRetrySupport` is enabled, the J1939Tp shall call `PduR_J1939TpCopyTxData` with

- `TpDataState` set to `TP_DATACONF` for the first call after reception of a TP.CM_CTS, and
- `TpDataState` set to `TP_CONFPENDING` for the following calls.] ()

[SWS_J1939Tp_00195] [

If a TP.CM_CTS wait frame (number of packets set to 0, see also [16]) is received, the J1939Tp shall wait for another TP.CM_CTS frame.] ()

[SWS_J1939Tp_00223] [

When the J1939Tp receives a TP.CM_CTS frame that requests data beyond the current position or preceding the position where the last TP.CM_CTS was received, it shall abort the transmission using the mechanisms described by **SWS_J1939Tp_00032** and **SWS_J1939Tp_00097** with reason FF₁₆ (SNA).] ()

[SWS_J1939Tp_00221] [

If J1939TpTxRetrySupport is enabled, when the J1939Tp receives a TP.CM_CTS frame requesting already sent data, it shall call PduR_J1939TpCopyTxData with TpDataState set to TP_DATARETRY and TxTpDataCnt set to the number of bytes to be retransmitted.] ()

The number of bytes that need to be retransmitted is calculated from the position of the requested package relative to the current package.

[SWS_J1939Tp_00194] [

If J1939TpTxRetrySupport is disabled, when the J1939Tp receives a TP.CM_CTS frame requesting already sent data, it shall abort the transmission using the mechanisms described by **SWS_J1939Tp_00032** and **SWS_J1939Tp_00097** with reason 255 (unassigned).] ()

[SWS_J1939Tp_00222] [

If J1939TpRxRetrySupport is enabled, when a sequence error occurs during reception, the J1939Tp module shall, after the last TP.DT message of the block was received, send a TP.CM_CTS frame requesting the packages that follow the last correctly received package of the current block.] ()

[SWS_J1939Tp_00232] [

The content of a TP.DT message with a sequence error and of the TP.DT messages following a sequence error in the same block shall be discarded.] ()

Note: This means that for such messages PduR_J1939TpCopyRxData shall not be called.

[SWS_J1939Tp_00216] [

If J1939TpRxRetrySupport is disabled, when a sequence error occurs during reception, the J1939Tp module shall abort the reception session

- as specified in **SWS_J1939Tp_00031** and
- as specified in **SWS_J1939Tp_00097** with connection abort reason FF₁₆ (SNA).] ()

[SWS_J1939Tp_00123] [

J1939Tp shall implement all CMDT related timing constraints (Tr, Th, T1, T2, T3, T4) as described in [16]. They supervise the CMDT data flow.] (SRS_J1939_00022)

[SWS_J1939Tp_00100] [

If a timeout occurs during CMDT transmission (see [16] for details) then the J1939Tp module shall abort the transmission session

- as specified in **SWS_J1939Tp_00032** and
- as specified in **SWS_J1939Tp_00097** with connection abort reason 3 (A timeout occurred and this is the connection abort to close the session) when the timeout occurred after successful transmission of the TP.CM_RTS frame.

] ()

[SWS_J1939Tp_00159] [

If a timeout occurs during reception (see [16] for details) then the J1939Tp module shall abort the reception session

- as specified in **SWS_J1939Tp_00031** and
- as specified in **SWS_J1939Tp_00097** with connection abort reason 3 (A timeout occurred and this is the connection abort to close the session).] ()

[SWS_J1939Tp_00098] [

If a TP.Conn_Abort frame is received after a TP.CM_RTS frame has been successfully sent by the ECU, the transmission shall be aborted like indicated in **SWS_J1939Tp_00032**. No transmission of TP.Conn_Abort is necessary.] ()

[SWS_J1939Tp_00163] [

If a TP.Conn_Abort frame is received after a TP.CM_RTS frame has been received, the reception shall be aborted like indicated in **SWS_J1939Tp_00031**. No transmission of TP.Conn_Abort is necessary.] ()

7.5.4.3 Data Flow using BAM**[SWS_J1939Tp_00121]** [

J1939Tp shall implement the BAM related timing constraints (50ms, Tr, T1) as described in [16]. They supervise the BAM data flow.] (SRS_J1939_00022)

[SWS_J1939Tp_00160] [

If a timeout occurs during the BAM reception, the J1939Tp module shall abort the reception session as specified in **SWS_J1939Tp_00031**.] ()

[SWS_J1939Tp_00192] [

After a sequence error, J1939Tp shall abort BAM connections as specified in **SWS_J1939Tp_00031**.] ()

The following figure shows an example of segmented message transmission between two ECUs using BAM as transport protocol variant according to [16]. The BAM transport protocol variant is used for a broadcast communication (i.e. 1 to n communication, like functional addressing in diagnostics). In the example, the transmitted PG has a total length of 3 blocks of 7 bytes that have to be successively transmitted.

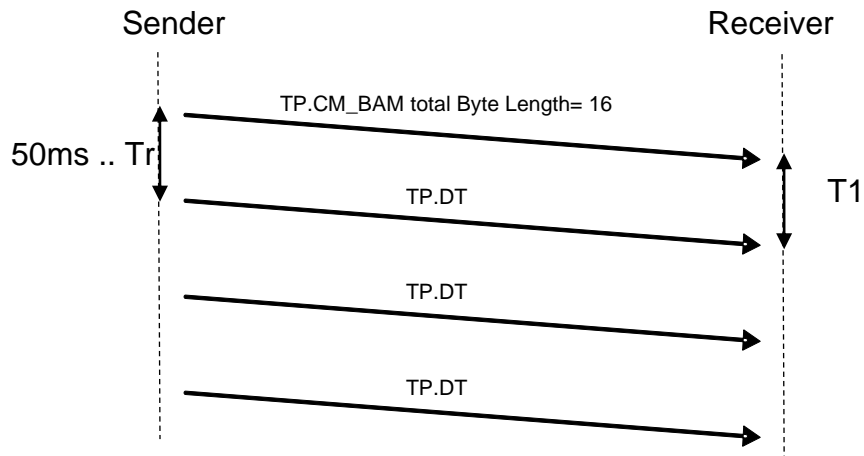

Figure 7-4: Example of data flow using BAM as transport protocol variant

7.5.5 N-SDU Buffer Management

J1939Tp shall have no internal PDU buffers. It requests data for sending directly from the upper layers via `PduR_J1939TpCopyTxData()` and provides received data directly to the upper layers via `PduR_J1939TpCopyRxData()`.

To guarantee data consistency, the complete buffer of the upper layers must be locked during the whole data transmission or reception.

Data transmission is initialized when the PduR calls `J1939Tp_Transmit()` and is active after J1939Tp executed this call successfully until J1939Tp calls `PduR_J1939TpTxConfirmation()`:

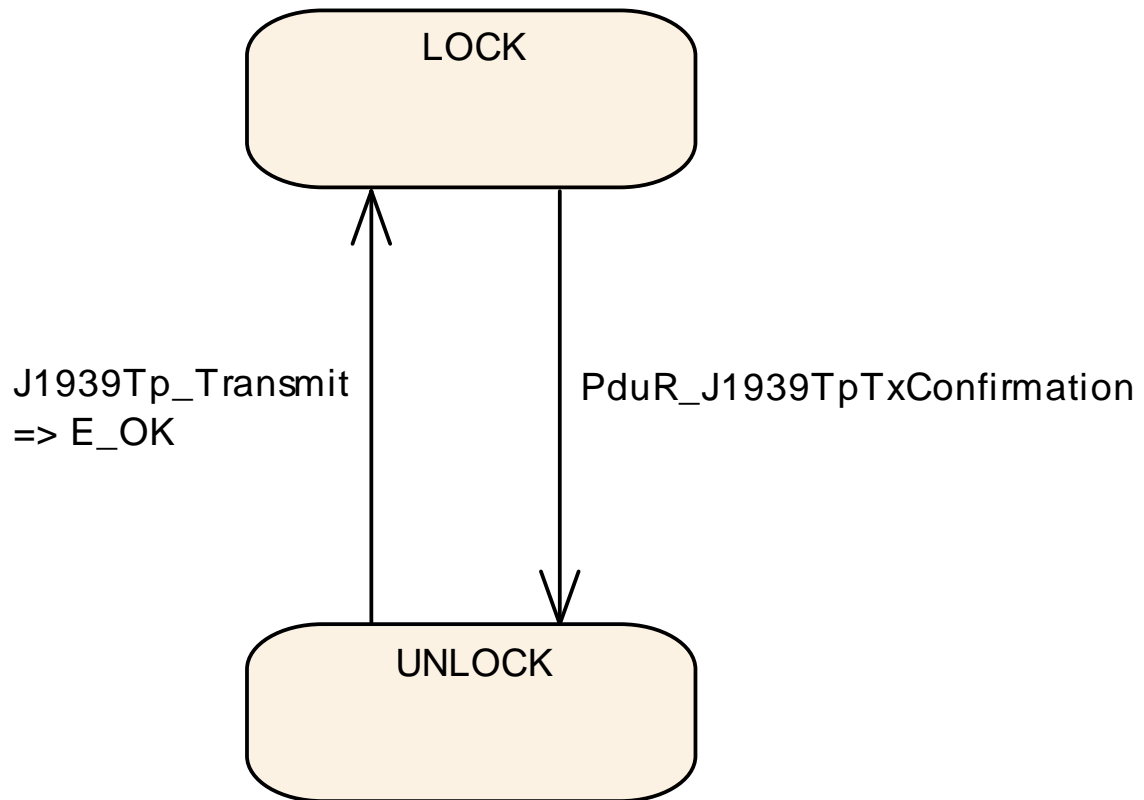

Figure 7-5: Tx Buffer locking

Data reception is initialized when J1939Tp calls `PduR_J1939TpStartOfReception()` and is active after the PduR executed this call successfully until J1939Tp calls `PduR_J1939TpRxIndication()`:

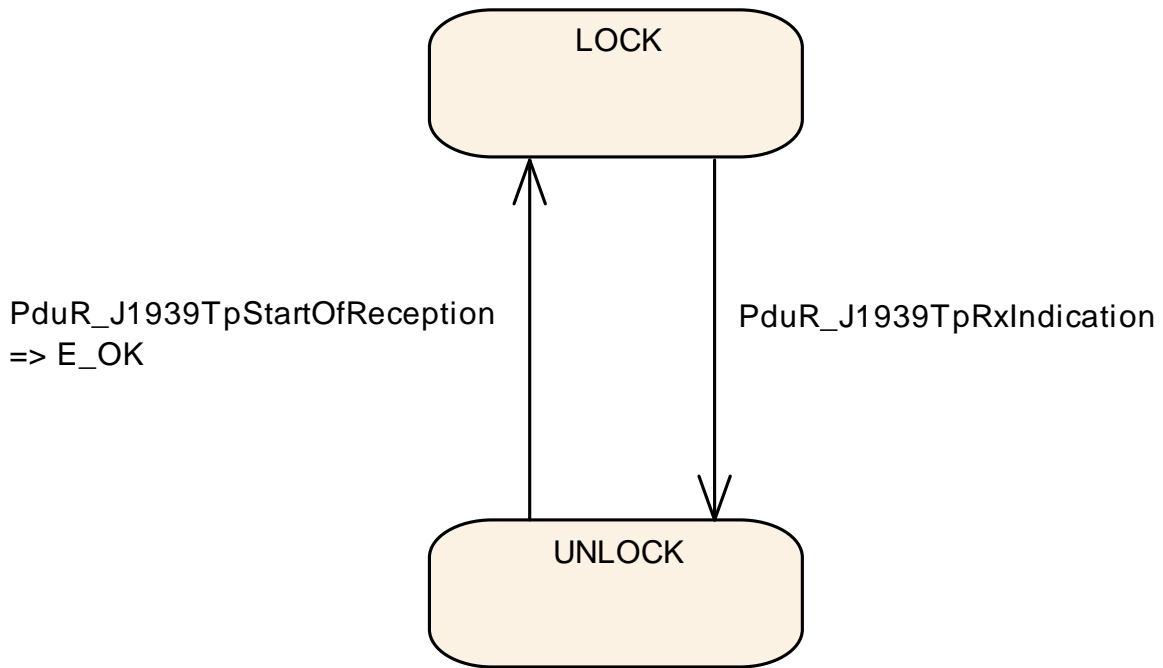

Figure 7-6: Rx Buffer locking

7.5.6 Relationship between N-SDU and N-PDU in J1939Tp

This section describes the relation that exists between an N-SDU and the set of N-PDUs that is required to transport the N-SDU data, as shown in the following figure.

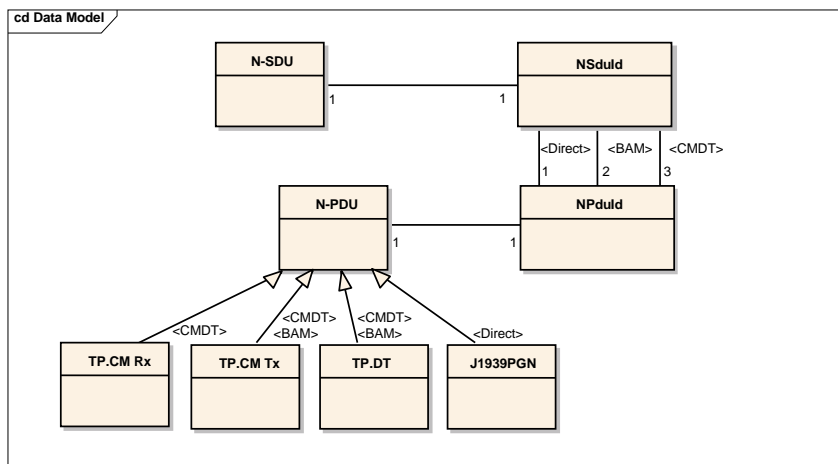

Figure 7-7: Relation between N-SDU and N-PDU

The N-PDUs as well as the N-SDU may use MetaData. In that case, the N-SDU stands for a certain PGN, and the N-PDUs stand for TP.CM, TP.DT, and direct PG, regardless of source and/or destination addresses.

[SWS_J1939Tp_00057] [

During reception, the N-SDU is identified by a combination of the PGN included in the payload of TP.CM and, when the N-SDU has no MetaData, from the addressing information implicitly encoded in the NPduls or explicitly provided via the MetaData of the N-PDUs.] ()

[SWS_J1939Tp_00199] [

During transmission, the relevant set of N-PDUs is identified by the configured SA/DA of N-SDUs without MetaData, or by the SA/DA explicitly provided in the MetaData by the upper layer.] ()

7.5.7 Concurrent Connections

Connections only concern internal J1939Tp purposes. They are transparent for the upper and lower layers of J1939Tp but influence the handling of J1939Tp.

A J1939Tp connection is characterized by its direction (Receiving /Sending) and its type (BAM / CMTD / Direct). A J1939Tp connection of type BAM or CMTD uses the following transport related frames:

- control (TP.CM)
- data (TP.DT)

The CAN-Identifier corresponding to those transport specific frames is the same for all J1939 PGs longer than 8 bytes:

- sent from a given SA - in the BAM case
- sent from a given SA to a given DA - in the CMTD case

This reduces the possibility for J1939Tp to process concurrent connections.

[SWS_J1939Tp_00120] [

The J1939Tp shall be able to handle connections in parallel for all N-SDUs that do not interfere in the usage of TP.DT frames with the same SA and DA. For channels with defined SA/DA and protocol type, only one TP connection and one direct connection for each PG can be open at any time. For channels with variable SA/DA, the maximum number of parallel connections is limited by the number of N-SDUs assigned to this channel.] ()

J1939Tp shall only support concurrent connections as described in section 5.10.5 of [16]. Note that one AUTOSAR ECU can represent several J1939 nodes and thus may have more than one address (used as SA or DA) assigned to it.

[SWS_J1939Tp_00062] [

Each connection shall be independent of the other connections.] (SRS_J1939_00025)

This means that a connection shall use its own resources, such as timer or state machine.

7.5.8 N-PDU Padding

[SWS_J1939Tp_00200] [

The J1939 Transport Layer module shall send TP.DT frames always with 8 bytes according to [16].] ()

[SWS_J1939Tp_00068] [

According to [16], all unused data bytes within the last TP.DT frame or the direct frame shall be set to 0xFF.] (SRS_J1939_00024)

7.5.9 Handling of Unexpected N-PDU Arrivals

[SWS_J1939Tp_00064] [

The J1939Tp shall ignore unexpected N-PDUs that do not correspond to a currently active connection.] (SRS_J1939_00023)

[SWS_J1939Tp_00224] [

If J1939TpTxRetrySupport is disabled, when a TP.CM_CTS is received while TP.DT messages are being transmitted, J1939Tp shall abort the connection as specified in **SWS_J1939Tp_00032** and in **SWS_J1939Tp_00097** with connection abort reason 4 (CTS messages received when data transfer is in progress).] ()

[SWS_J1939Tp_00225] [

When a TP.CM_RTS is received for a currently active connection, the J1939Tp shall stop this connection as specified in **SWS_J1939Tp_00031** and start a new connection as described in **SWS_J1939Tp_00038**.] ()

7.6 Error Classification

Section 7.2 "Error Handling" of the document "General Specification of Basic Software Modules" [15] describes the error handling of the Basic Software in detail. Above all, it constitutes a classification scheme consisting of five error types which may occur in BSW modules.

Based on this foundation, this section specifies particular errors arranged in the respective subsections below.

7.6.1 Development Errors

[SWS_J1939Tp_00115][

<i>Type of error</i>	<i>Related error code</i>	<i>Error value</i>
API service used in state J1939TP_OFF	J1939TP_E_UNINIT	0x01

J1939Tp_Init() called in state J1939TP_ON.	J1939TP_E_REINIT	0x02
J1939Tp_Init() was called with an invalid configuration pointer	J1939TP_E_INIT_FAILED	0x03
API service called with null pointer.	J1939TP_E_PARAM_POINTER	0x10
API service called with wrong ID.	J1939TP_E_INVALID_PDU_SDU_ID	0x11

[(SRS_BSW_00327, SRS_BSW_00337, SRS_BSW_00385, SRS_BSW_00441)]

7.6.2 Runtime Errors

[SWS_J1939Tp_00234]

<i>Type of error</i>	<i>Related error code</i>	<i>Error value</i>
Timeout occurred on receiver side after reception of an intermediate TP.DT frame of a block.	J1939TP_E_TIMEOUT_T1	0x30
Timeout occurred on receiver side after transmission of a TP.CM/CTS frame.	J1939TP_E_TIMEOUT_T2	0x31
Timeout occurred on transmitter side after transmission of the last TP.DT frame of a block.	J1939TP_E_TIMEOUT_T3	0x32
Timeout occurred on transmitter side after reception of a TP.CM/CTS(0) frame.	J1939TP_E_TIMEOUT_T4	0x33
Timeout occurred on transmitter or receiver side while trying to send the next TP.DT or TP.CM frame.	J1939TP_E_TIMEOUT_TR	0x34
Timeout occurred on receiver side while trying to send the next TP.CM/CTS frame after a TP.CM/CTS(0) frame.	J1939TP_E_TIMEOUT_TH	0x35
Invalid value for "total message size" in received TP.CM/RTS frame.	J1939TP_E_INVALID_TMS	0x40
Value for "total number of packets" in received TP.CM/RTS frame does not match the "total message size".	J1939TP_E_INVALID_TNOP	0x41
Invalid value for "maximum number of packets" in received TP.CM/RTS frame.	J1939TP_E_INVALID_MNOP	0x42
Unexpected PGN in received TP.CM frame.	J1939TP_E_INVALID_PGN	0x43
Invalid value for "number of packets" in received TP.CM/CTS frame.	J1939TP_E_INVALID_NOP	0x44
Invalid value for "next packet number" in received TP.CM/CTS frame.	J1939TP_E_INVALID_NPN	0x45
Invalid value for "connection abort reason" in received TP.Conn_Abort frame.	J1939TP_E_INVALID_CAR	0x46
Unexpected serial number in received TP.DT frame.	J1939TP_E_	0x47

	INVALID_SN	
--	------------	--

l()

7.6.3 Transient Faults

There are no transient faults.

7.6.4 Production Errors

There are no production errors.

7.6.5 Extended Production Errors

There are no extended production errors.

8 API Specification

8.1 API Parameter Checking

J1939TP_E_PARAM_POINTER shall be reported as specified in [15] by SWS_BSW_00212.

[SWS_J1939Tp_00188] [

If development error detection for the J1939Tp is enabled, all APIs using a SDU- or PDU-Identifier shall check the input Identifier and raise the development error: J1939TP_E_INVALID_PDU_SDU_ID in case the API has been called for a not configured PDU or SDU.] (SRS_BSW_00323)

8.2 Imported Types

This section lists all externally defined types that are used by J1939Tp. These types are included from the headers corresponding to the module names listed in the table below.

[SWS_J1939Tp_00230][

<i>Module</i>	<i>Header File</i>	<i>Imported Type</i>
ComStack_Types	ComStack_Types.h	BufReq_ReturnType
	ComStack_Types.h	PduIdType
	ComStack_Types.h	PduInfoType
	ComStack_Types.h	PduLengthType
	ComStack_Types.h	RetryInfoType
	ComStack_Types.h	TPParameterType
	ComStack_Types.h	TpDataStateType
Std	Std_Types.h	Std_ReturnType
	Std_Types.h	Std_VersionInfoType

]()

8.3 Type Definitions

This section lists the types defined by J1939Tp.

[SWS_J1939Tp_00175][

<i>Name</i>	
J1939Tp_ConfigType	

Kind	Structure	
Elements	implementation specific	
	Type	--
	Comment	The content of the initialization data structure is implementation specific.
Description	Data structure containing post-build configuration data of J1939-TP.	
Available via	J1939Tp.h	

]()

The J1939Tp_ConfigType defines a structure that contains configuration parameters J1939Tp uses at run time. It is provided as an argument to J1939Tp_Init().

8.4 Function Definitions

This section defines a list of functions provided for upper layer modules. All these APIs shall provide the following development errors:

8.4.1 J1939Tp_Init

[SWS_J1939Tp_00087]

Service Name	J1939Tp_Init	
Syntax	<pre>void J1939Tp_Init (const J1939Tp_ConfigType* ConfigPtr)</pre>	
Service ID [hex]	0x01	
Sync/Async	Synchronous	
Reentrancy	Non Reentrant	
Parameters (in)	ConfigPtr	Pointer to configuration data structure.
Parameters (inout)	None	
Parameters (out)	None	
Return value	None	
Description	This function initializes the J1939Tp module.	
Available via	J1939Tp.h	

](SRS_BSW_00101, SRS_BSW_00358)

After power up, J1939Tp is in a state called J1939TP_OFF. In this state, J1939Tp is not yet configured, and therefore cannot perform any communication task. The J1939Tp module's environment (usually the ECU Manager) will call `J1939Tp_Init()` before using the J1939Tp module for further processing.

[SWS_J1939Tp_00024] [

The function `J1939Tp_Init()` shall initialize all global variables of the module and reset all transport protocol connections.] (SRS_J1939_00010)

[SWS_J1939Tp_00022] [

`J1939Tp_Init()` shall change to the internal state `J1939TP_ON` after successful initialization.] ()

[SWS_J1939Tp_00026] [

If called when the J1939Tp module is in the global state `J1939TP_ON`, the function `J1939Tp_Init()` shall raise the development error `J1939TP_E_REINIT` and do nothing.] ()

[SWS_J1939Tp_00187] [

The provided `ConfigPtr` shall only be used, when post-build configuration is enabled, or when different configuration variants must be supported. Otherwise, the parameters should be accessed directly to avoid indirection via the `ConfigPtr`.] (SRS_BSW_00400, SRS_BSW_00405, SRS_BSW_00414, SRS_BSW_00438)

The structure of type `J1939Tp_ConfigType` pointed to by the `ConfigPtr` contains post-build parameters of the J1939Tp module. In link time or pre-compile configured environments, the structure may contain a set of post-build parameters that differ between several configuration variants. It is expected that link time and pre-compile parameters may not change for different configuration variants.

`J1939Tp_Init()` has no return value because configuration data errors should be detected during configuration time (e.g. by the configuration tools). Furthermore, if a hardware error occurs, it will be reported via the error manager modules.

`J1939TP_E_INIT_FAILED` shall be reported as specified in [15] by `SWS_BSW_00050`.

8.4.2 J1939Tp_Shutdown

[SWS_J1939Tp_00093][

Service Name	J1939Tp_Shutdown
Syntax	<pre>void J1939Tp_Shutdown (void)</pre>

Service ID [hex]	0x02
Sync/Async	Synchronous
Reentrancy	Non Reentrant
Parameters (in)	None
Parameters (inout)	None
Parameters (out)	None
Return value	None
Description	This function is used to shutdown the J1939Tp module.
Available via	J1939Tp.h

|(SRS_BSW_00336)

To close down communication, the state handling (usually the ECU Manager) calls `J1939Tp_Shutdown()`.

[SWS_J1939Tp_00094] [

`J1939Tp_Shutdown()` shall close all pending transport protocol connections, free all resources and set the J1939Tp module into the global state `J1939TP_OFF` state.

] ()

[SWS_J1939Tp_00095] [

`J1939Tp_Shutdown()` shall not raise a notification about the pending frame transmission or reception. **] ()**

8.4.3 J1939Tp_GetVersionInfo

[SWS_J1939Tp_00089]

Service Name	J1939Tp_GetVersionInfo
Syntax	<pre>void J1939Tp_GetVersionInfo (Std_VersionInfoType* VersionInfo)</pre>
Service ID [hex]	0x03
Sync/Async	Synchronous
Reentrancy	Reentrant
Parameters (in)	None
Parameters (inout)	None

Parameters (out)	Version Info	Pointer to the location where the version information of J1939Tp shall be stored.
Return value	None	
Description	Returns the version information of J1939Tp.	
Available via	J1939Tp.h	

](SRS_BSW_00407)

Note that the function J1939Tp_GetVersionInfo may be called in global state J1939TP_OFF, i.e. before initialization of the J1939Tp module.

8.4.4 J1939Tp_Transmit

[SWS_J1939Tp_00096]

Service Name	J1939Tp_Transmit	
Syntax	<pre>Std_ReturnType J1939Tp_Transmit (PduIdType TxPduId, const PduInfoType* PduInfoPtr)</pre>	
Service ID [hex]	0x49	
Sync/Async	Synchronous	
Reentrancy	Reentrant for different Pdulds. Non reentrant for the same PduId.	
Parameters (in)	TxPduId	Identifier of the PDU to be transmitted
	PduInfoPtr	Length of and pointer to the PDU data and pointer to Meta Data.
Parameters (inout)	None	
Parameters (out)	None	
Return value	Std_Return-Type	E_OK: Transmit request has been accepted. E_NOT_OK: Transmit request has not been accepted.
Description	Requests transmission of a PDU.	
Available via	J1939Tp.h	

](SRS_BSW_00357)

As described in **SWS_J1939Tp_00119** and **SWS_J1939Tp_00032**, the J1939Tp module will notify the upper layer by calling the `PduR_J1939TpTxConfirmation` callback when the transmit request has been completed.

[SWS_J1939Tp_00101] [

The function J1939Tp_Transmit shall reject a request, if the J1939Tp_Transmit service is called for an N-SDU identifier that is being used in a currently running J1939 Transport Layer session.] ()

[SWS_J1939Tp_00030] [

The function J1939Tp_Transmit() shall reject the transmit request and return the status value E_NOT_OK if the transmission needs a transport protocol and the channel is occupied (see also 7.5.7).] ()

The term channel refers to a communication relation with identical SA and DA.

8.4.5 J1939Tp_CancelTransmit

[SWS_J1939Tp_00177][

Service Name	J1939Tp_CancelTransmit	
Syntax	Std_ReturnType J1939Tp_CancelTransmit (PduIdType TxPduId)	
Service ID [hex]	0x4a	
Sync/Async	Synchronous	
Reentrancy	Reentrant for different Pdulds. Non reentrant for the same Pduldd.	
Parameters (in)	TxPduldd	Identification of the PDU to be cancelled.
Parameters (inout)	None	
Parameters (out)	None	
Return value	Std_Return- Type	E_OK: Cancellation was executed successfully by the destination module. E_NOT_OK: Cancellation was rejected by the destination module.
Description	Requests cancellation of an ongoing transmission of a PDU in a lower layer communication module.	
Available via	J1939Tp.h	

]()

[SWS_J1939Tp_00203] [

J1939Tp_CancelTransmit shall return E_NOT_OK if 'TxPduldd' is invalid, if 'TxPduldd' is currently not active, if currently a direct frame is transmitted, if the last TP.DT frame has already been transmitted during BAM transmission, or if the TP.CM_EOMAck frame has already been received during CMDT transmission.] ()

[SWS_J1939Tp_00214] [

The `J1939Tp_CancelTransmit` API shall only be available when `J1939TpCancellationSupport` is enabled.] ()

8.4.6 J1939Tp_CancelReceive

[SWS_J1939Tp_00176]

Service Name	J1939Tp_CancelReceive	
Syntax	Std_ReturnType J1939Tp_CancelReceive (PduIdType RxPduId)	
Service ID [hex]	0x4c	
Sync/Async	Synchronous	
Reentrancy	Non Reentrant	
Parameters (in)	RxPduId	Identification of the PDU to be cancelled.
Parameters (inout)	None	
Parameters (out)	None	
Return value	Std_Return-Type	E_OK: Cancellation was executed successfully by the destination module. E_NOT_OK: Cancellation was rejected by the destination module.
Description	Requests cancellation of an ongoing reception of a PDU in a lower layer transport protocol module.	
Available via	J1939Tp.h	

] ()

[SWS_J1939Tp_00204] [

`J1939Tp_CancelReceive` shall return `E_NOT_OK` if 'RxPduId' is invalid, if 'RxPduId' is currently not active, if currently a direct frame is received, if the last TP.DT frame has already been received during BAM reception, or if the TP.CM_EOMAck frame has already been sent during CMDT reception.] ()

[SWS_J1939Tp_00215] [

The `J1939Tp_CancelReceive` API shall only be available when `J1939TpCancellationSupport` is enabled.] ()

8.4.7 J1939Tp_ChangeParameter

[SWS_J1939Tp_00180]

Service Name	J1939Tp_ChangeParameter
---------------------	-------------------------

Syntax	Std_ReturnType J1939Tp_ChangeParameter (PduIdType id, TPParameterType parameter, uint16 value)	
Service ID [hex]	0x4b	
Sync/Async	Synchronous	
Reentrancy	Non Reentrant	
Parameters (in)	id	Identification of the PDU which the parameter change shall affect.
	parameter	ID of the parameter that shall be changed.
	value	The new value of the parameter.
Parameters (inout)	None	
Parameters (out)	None	
Return value	Std_Return- Type	E_OK: The parameter was changed successfully. E_NOT_OK: The parameter change was rejected.
Description	Request to change a specific transport protocol parameter (e.g. block size).	
Available via	J1939Tp.h	

J()

[SWS_J1939Tp_00206] [

J1939Tp_ChangeParameter shall return E_NOT_OK if 'id' is invalid, if 'parameter' is not TP_BS, or if 'value' is larger than 255.] ()

8.5 Callback Notifications

This is a list of functions provided for other modules.

8.5.1 J1939Tp_RxIndication

[SWS_J1939Tp_00108][

Service Name	J1939Tp_RxIndication	
Syntax	void J1939Tp_RxIndication (PduIdType RxPduId, const PduInfoType* PduInfoPtr)	
Service ID [hex]	0x42	

Sync/Async	Synchronous	
Reentrancy	Reentrant for different PduIds. Non reentrant for the same PduId.	
Parameters (in)	RxPdu Id	ID of the received PDU.
	Pdu InfoPtr	Contains the length (SduLength) of the received PDU, a pointer to a buffer (SduDataPtr) containing the PDU, and the MetaData related to this PDU.
Parameters (inout)	None	
Parameters (out)	None	
Return value	None	
Description	Indication of a received PDU from a lower layer communication interface module.	
Available via	J1939Tp.h	

](SRS_BSW_00359, SRS_BSW_00360)

The J1939Tp module provides the J1939Tp_RxIndication() API to allow the CanIf to notify that a new N-PDU has been received.

[SWS_J1939Tp_00110] [

The function J1939Tp_RxIndication shall be callable in interrupt context (it could be called from the CAN receive interrupt).] (SRS_BSW_00333)

8.5.2 J1939Tp_TxConfirmation

[SWS_J1939Tp_00112][

Service Name	J1939Tp_TxConfirmation	
Syntax	<pre>void J1939Tp_TxConfirmation (PduIdType TxPduId, Std_ReturnType result)</pre>	
Service ID [hex]	0x40	
Sync/Async	Synchronous	
Reentrancy	Reentrant for different PduIds. Non reentrant for the same PduId.	
Parameters (in)	TxPduId	ID of the PDU that has been transmitted.
	result	E_OK: The PDU was transmitted. E_NOT_OK: Transmission of the PDU failed.
Parameters (inout)	None	

Parameters (out)	None
Return value	None
Description	The lower layer communication interface module confirms the transmission of a PDU, or the failure to transmit a PDU.
Available via	J1939Tp.h

](SRS_BSW_00359, SRS_BSW_00360)

The J1939Tp module implements the J1939Tp_TxConfirmation API to allow the CanIf module to confirm that a TP related frame (TP.CM, TP.DT) or direct frame has been successfully transmitted to the J1939 network.

[SWS_J1939Tp_00114] [

The function J1939Tp_TxConfirmation shall be callable in interrupt context (it could be called from the CAN transmit interrupt).] (SRS_BSW_00333)

8.6 Scheduled Functions

The Basic Software Scheduler directly calls the functions listed in this section. Scheduled functions shall have no return value and no parameter, and need not be reentrant.

8.6.1 J1939Tp_MainFunction

[SWS_J1939Tp_00104][

Service Name	J1939Tp_MainFunction
Syntax	void J1939Tp_MainFunction (void)
Service ID [hex]	0x04
Description	Main function of the J1939Tp. Used for scheduling purposes and timeout supervision.
Available via	SchM_J1939Tp.h

](SRS_BSW_00373)

[SWS_J1939Tp_00106] [

The calling frequency of the function J1939Tp_MainFunction is determined by the parameter J1939TpMainFunctionPeriod (see [ECUC_J1939Tp_00044]).] ()

8.7 Expected Interfaces

In this section, all interfaces required from other modules are listed.

8.7.1 Mandatory Interfaces

This section defines all interfaces, which are required to fulfill the core functionality of the module.

[SWS_J1939Tp_00116]

<i>API Function</i>	<i>Header File</i>	<i>Description</i>
CanIf_Transmit	CanIf.h	Requests transmission of a PDU.
Det_Report- RuntimeError	Det.h	Service to report runtime errors. If a callout has been configured then this callout shall be called.
PduR_J1939- TpCopyRxData	PduR_ J1939Tp.h	This function is called to provide the received data of an I-PDU segment (N-PDU) to the upper layer. Each call to this function provides the next part of the I-PDU data. The size of the remaining buffer is written to the position indicated by bufferSizePtr.
PduR_J1939- TpCopyTxData	PduR_ J1939Tp.h	This function is called to acquire the transmit data of an I-PDU segment (N-PDU). Each call to this function provides the next part of the I-PDU data unless retry->TpDataState is TP_DATARETRY. In this case the function restarts to copy the data beginning at the offset from the current position indicated by retry->TxTpDataCnt. The size of the remaining data is written to the position indicated by available DataPtr.
PduR_J1939- TpRxIndication	PduR_ J1939Tp.h	Called after an I-PDU has been received via the TP API, the result indicates whether the transmission was successful or not.
PduR_J1939- TpStartOf- Reception	PduR_ J1939Tp.h	This function is called at the start of receiving an N-SDU. The N-SDU might be fragmented into multiple N-PDUs (FF with one or more following CFs) or might consist of a single N-PDU (SF). The service shall provide the currently available maximum buffer size when invoked with TpSduLength equal to 0.
PduR_J1939- TpTx- Confirmation	PduR_ J1939Tp.h	This function is called after the I-PDU has been transmitted on its network, the result indicates whether the transmission was successful or not.

()

8.7.2 Optional Interfaces

This section defines all interfaces that are required to fulfill an optional functionality of the module.

[SWS_J1939Tp_00060]

<i>API Function</i>	<i>Header File</i>	<i>Description</i>
---------------------	--------------------	--------------------

Det_ReportError	Det.h	Service to report development errors.
-----------------	-------	---------------------------------------

J()

9 Sequence Diagrams

The following sequence diagrams shall give an impression of the way the J1939 Transport Layer module shall behave and interoperate with other BSW modules. They are not complete and not binding for the implementation.

9.1 Reception of Direct PG

The following diagram shows the interaction of the J1939 Transport Layer module with the CAN Interface and the PDU Router during reception of a direct PG, i.e. an N-SDU with dynamic length that is not larger than 8 bytes.

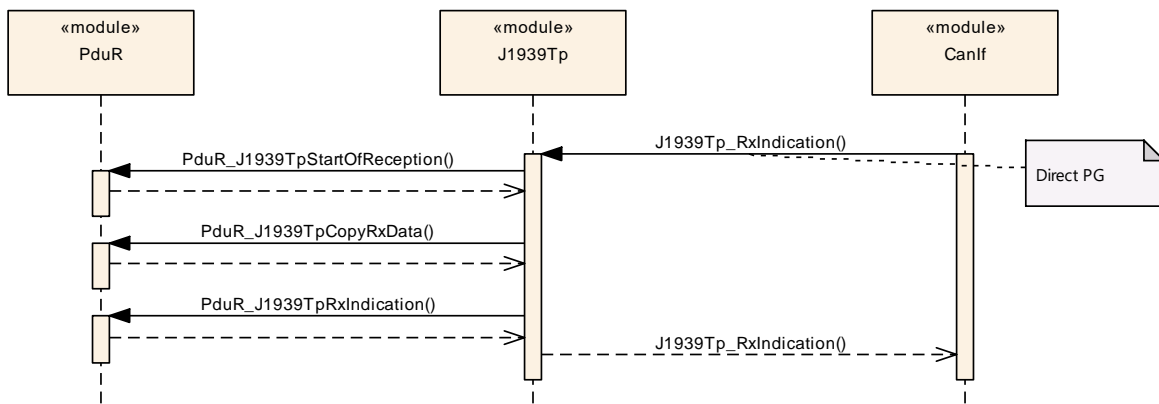

Figure 9-1: Reception of Direct PG

9.2 Reception via BAM

The following diagram shows the interaction of the J1939 Transport Layer module with the CAN Interface and the PDU Router during reception of a PG via BAM, i.e. an N-SDU that is larger than 8 bytes and is sent to the whole network.

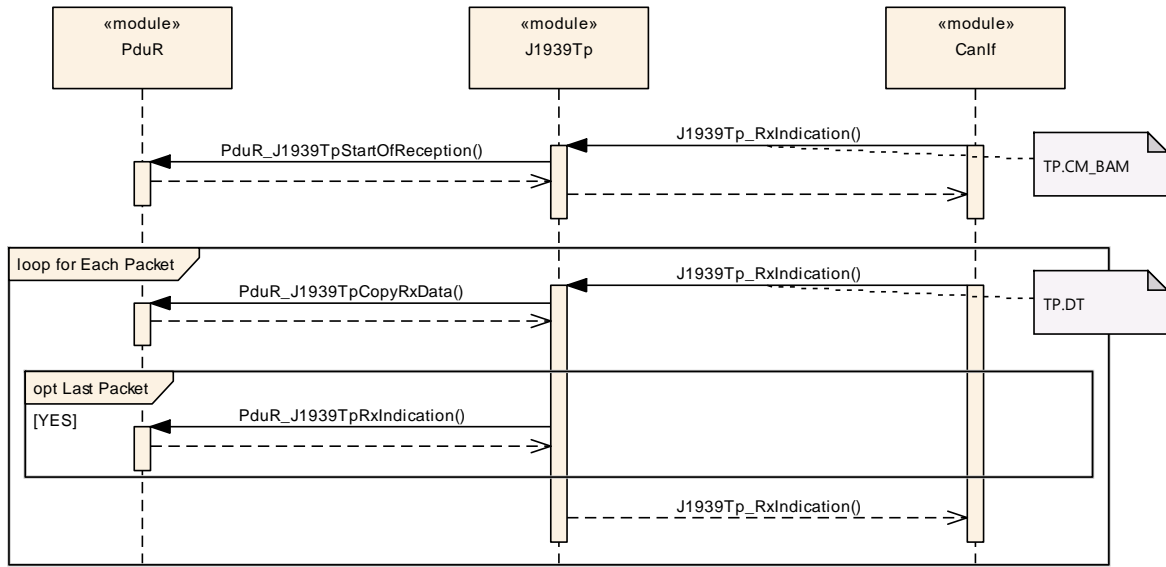

Figure 9-2: Reception via BAM

9.3 Reception via CMDT

The following diagram shows the interaction of the J1939 Transport Layer module with the CAN Interface and the PDU Router during reception of a PG via CMDT, i.e. an N-SDU that is larger than 8 bytes and is sent directly to the receiving node.

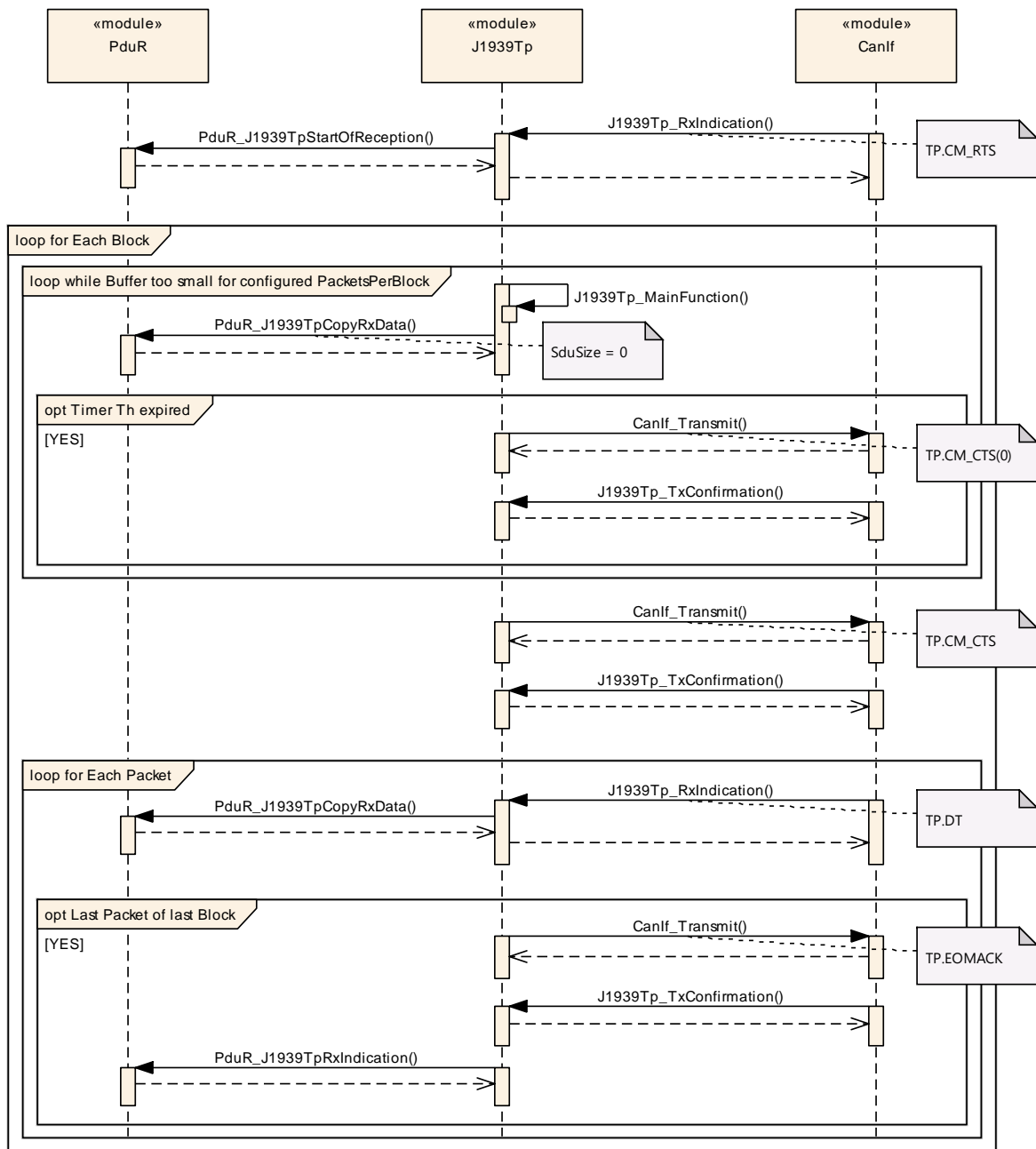

Figure 9-3: Reception via CMTD

9.4 Transmission of Direct PG

The following diagram shows the interaction of the J1939 Transport Layer module with the PDU Router and the CAN Interface during transmission of a direct PG, i.e. an N-SDU with dynamic length that is not larger than 8 bytes.

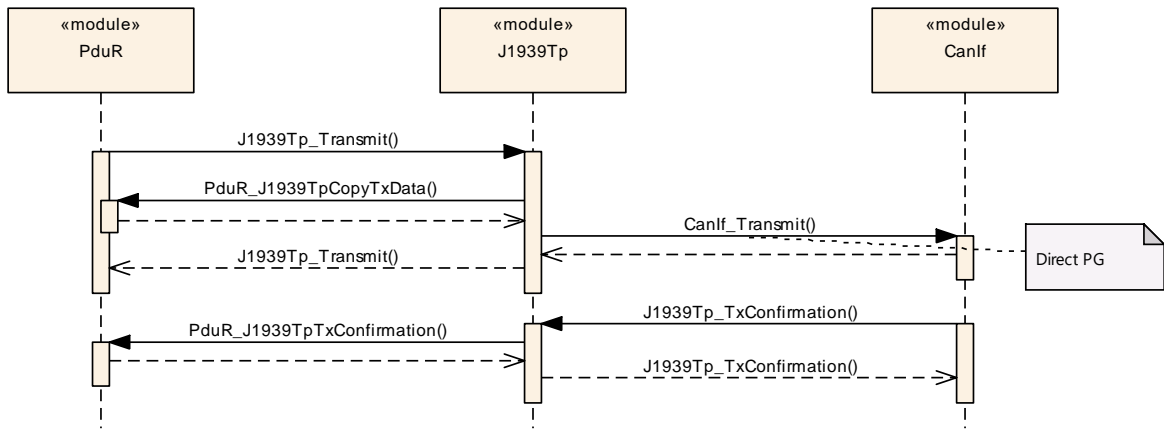

Figure 9-4: Transmission of Direct PG

9.5 Transmission via BAM

The following diagram shows the interaction of the J1939 Transport Layer module with the PDU Router and the CAN Interface during transmission of a PG via BAM, i.e. an N-SDU that is larger than 8 bytes and is sent to the whole network.

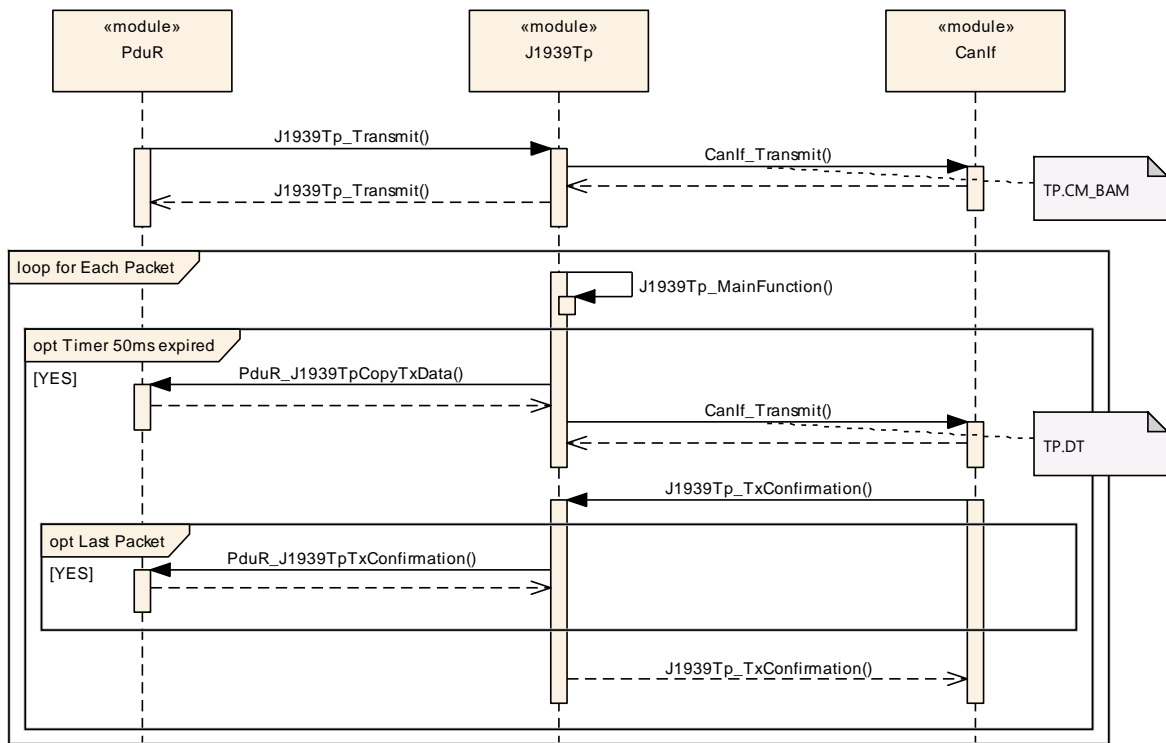

Figure 9-5: Transmission via BAM

9.6 Transmission via CMDT

The following diagram shows the interaction of the J1939 Transport Layer module with the PDU Router and the CAN Interface during transmission of a PG via CMDT, i.e. an N-SDU that is larger than 8 bytes and is sent directly to the receiving node.

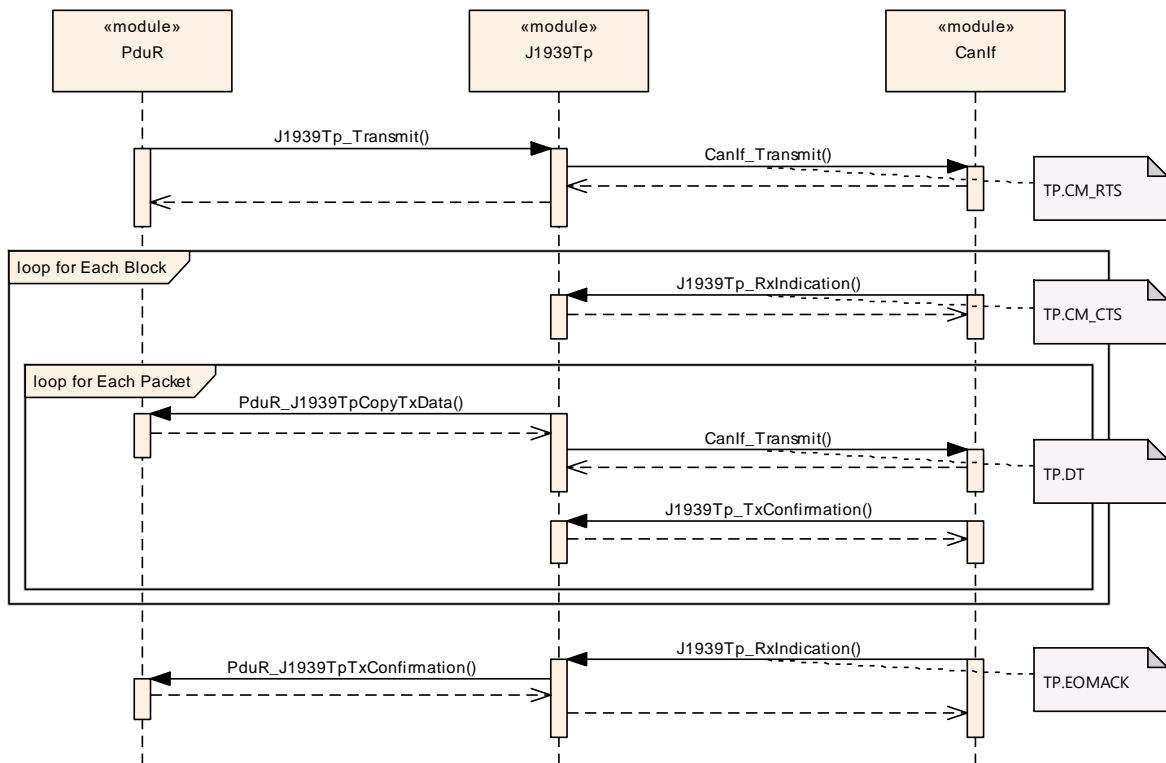

Figure 9-6: Transmission via CMDT

9.7 Handling of Retry during CMDT Transmission

The following diagram shows the interaction of the J1939 Transport Layer module with the PDU Router in the sender and the receiver node during transmission of a PG via CMDT when a retry is performed because some data is lost.

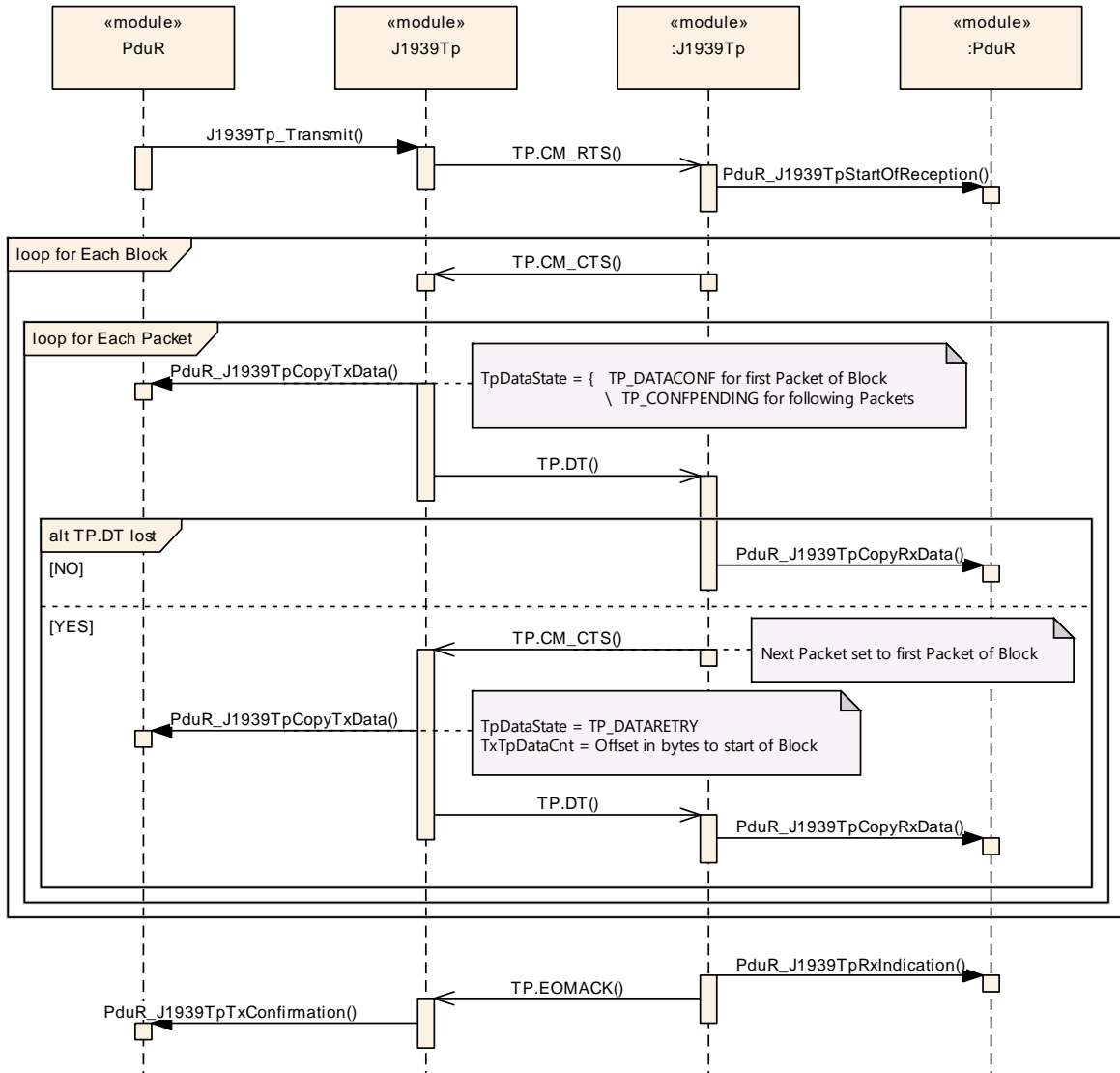

Figure 9-7: Retry Handling

10 Configuration Specification

In general, this chapter defines configuration parameters and their clustering into containers. For general information about the definition of containers and parameters, refer to the chapter 10.1 “Introduction to configuration specification” in the SWS BSW General [15].

Section 10.1 specifies structure (containers) and parameters of J1939Tp.

Section 10.2 specifies published information of J1939Tp.

The configuration parameters are derived from a network description database, which is based on the System Template. The configuration tool will extract all relevant information to configure the J1939 Transport Protocol.

[SWS_J1939Tp_00084] [

The consistency of the configuration must be checked by the configuration tool at configuration time. Configuration rules and constraints for plausibility checks will be performed where possible, during configuration time.] (SRS_BSW_00167)

10.1 Containers and Configuration Parameters

The following sections summarize all configuration parameters. Additional information on the usage of these parameters can be found in chapter 7 and 8.

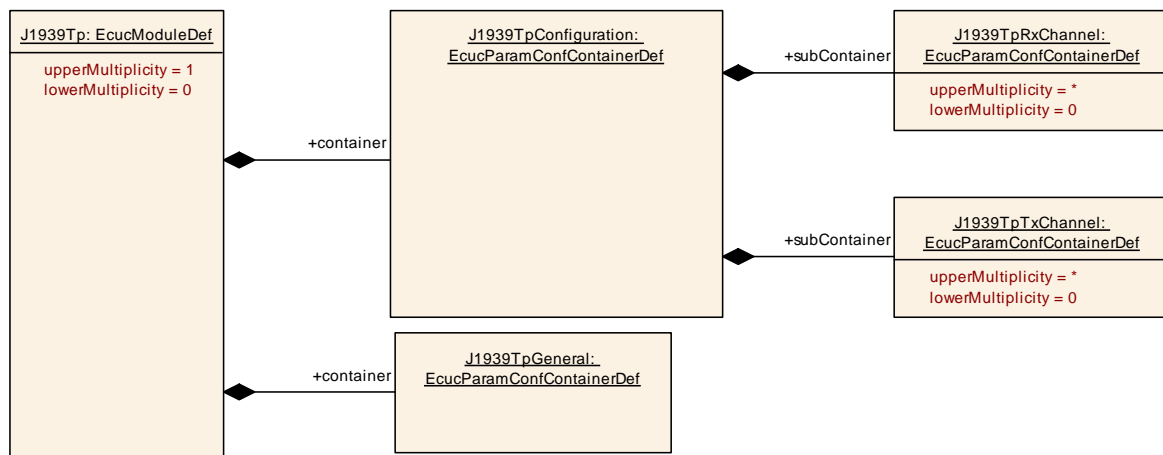

Figure 10-1: Module Configuration

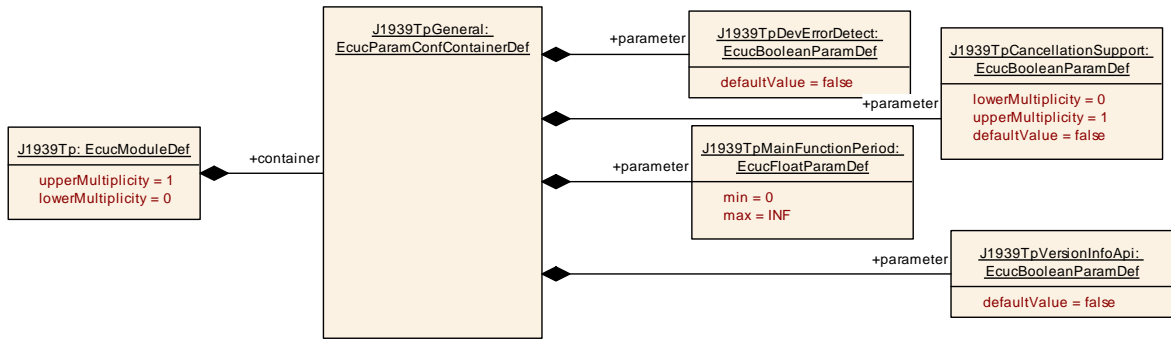

Figure 10-2: General Parameters

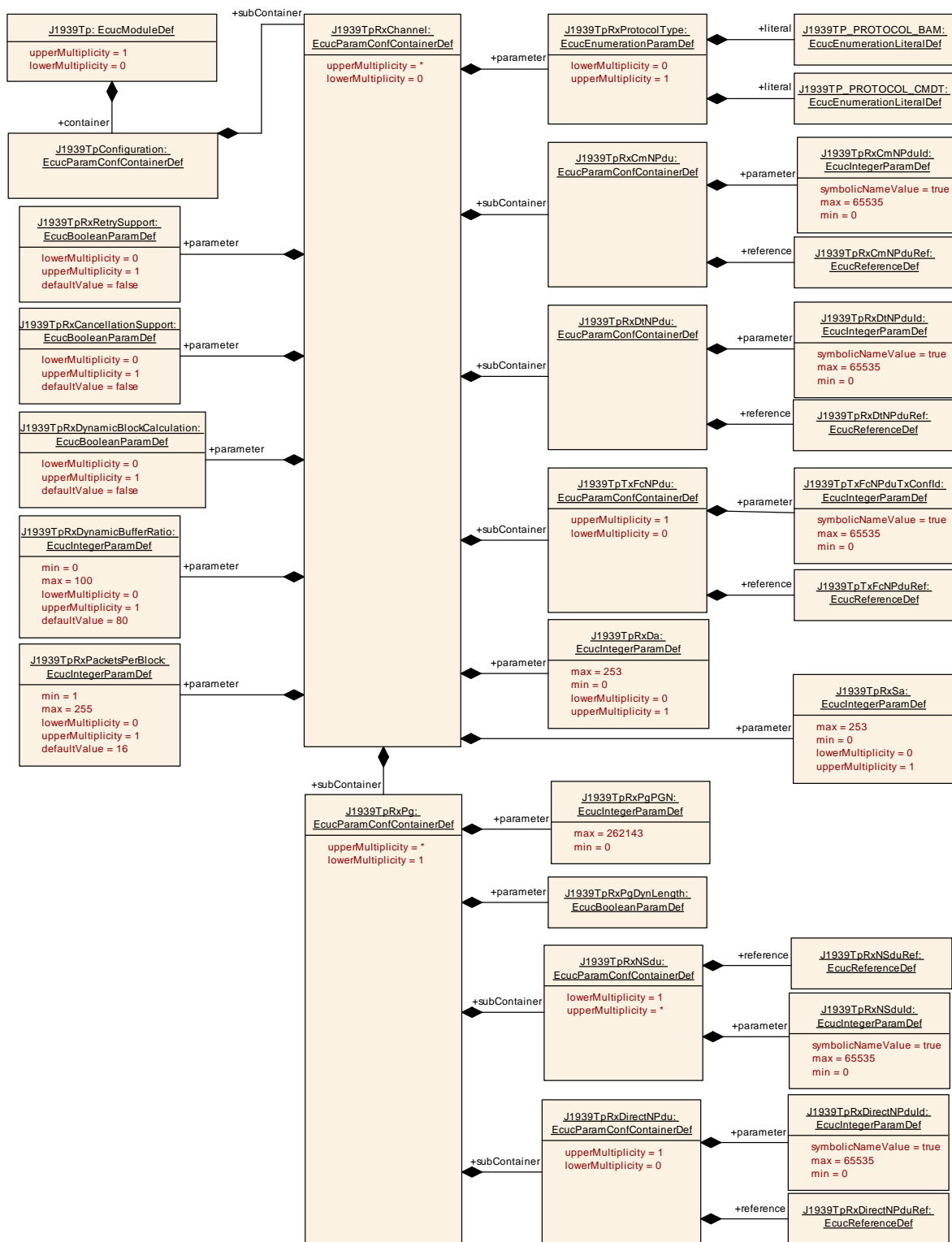

Figure 10-3: Configuration of Rx Channel

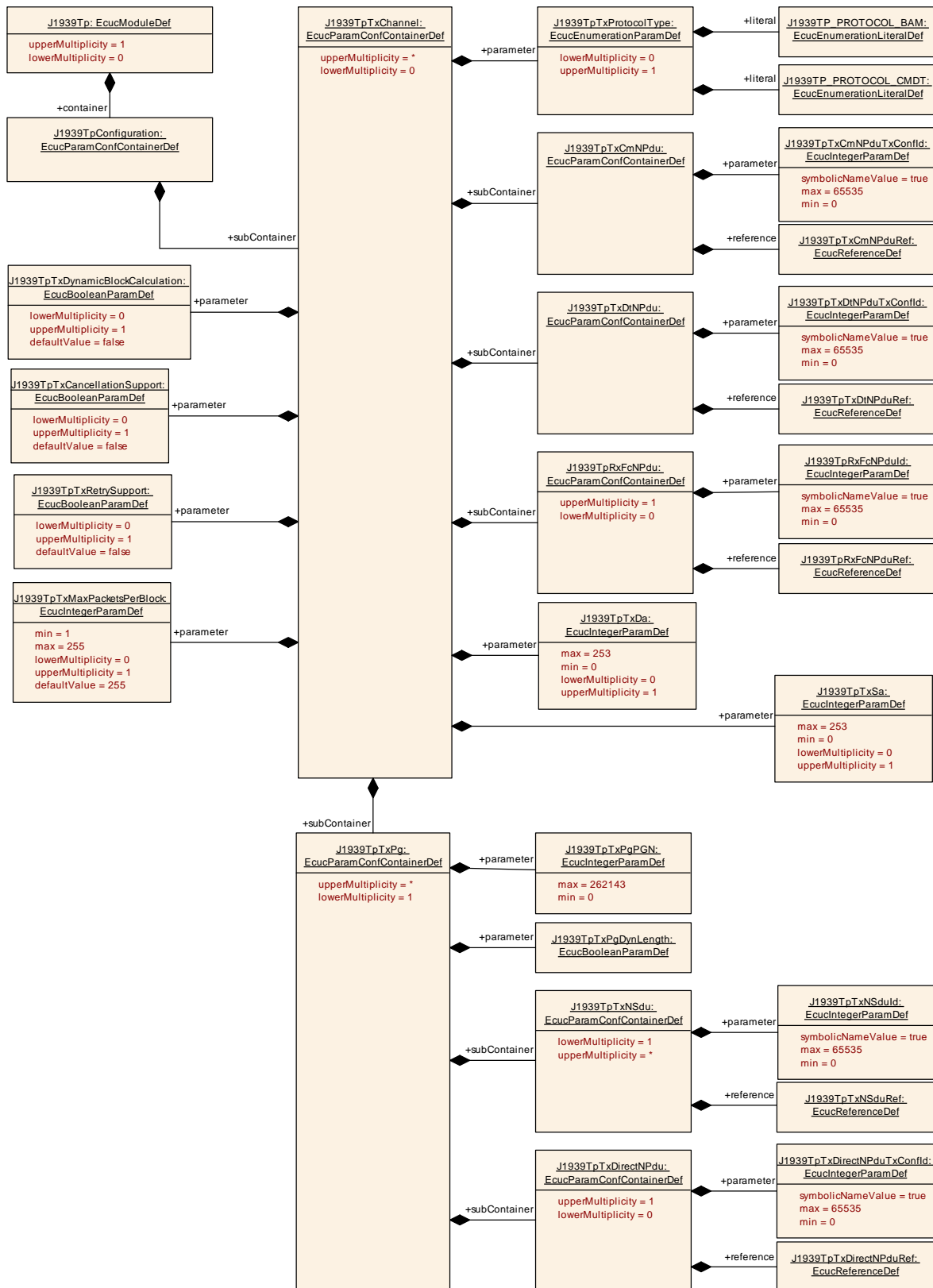

Figure 10-4: Configuration of Tx Channel

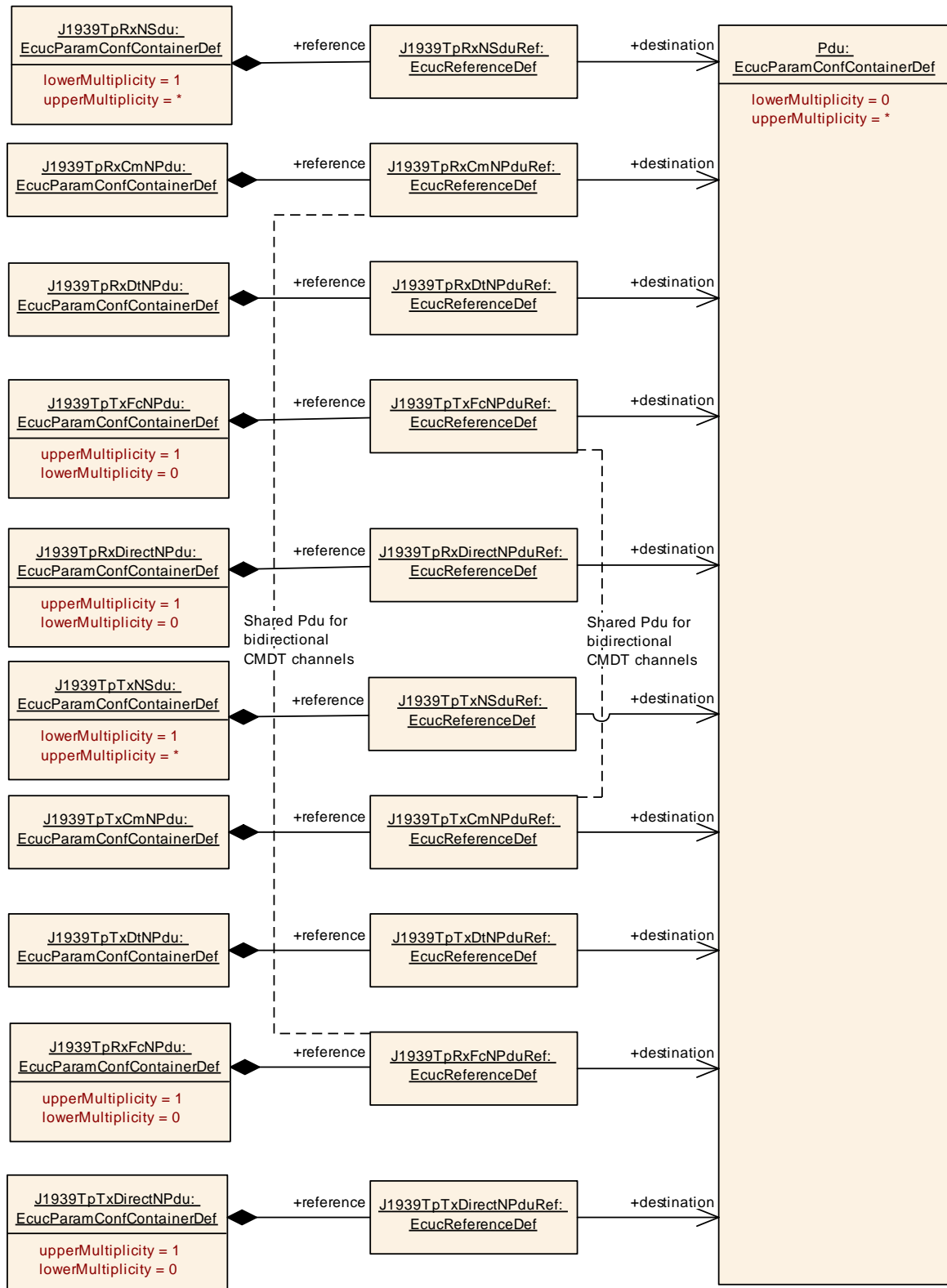

Figure 10-5: References to PDUs

10.1.1 J1939Tp

SWS Item	[ECUC_J1939Tp_00127]
Module Name	J1939Tp
Description	Configuration of the J1939Tp (J1939 Transport Protocol) module.
Post-Build Variant Support	true
Supported Config Variants	VARIANT-LINK-TIME, VARIANT-POST-BUILD, VARIANT-PRE-COMPILE

Included Containers		
Container Name	Multiplicity	Scope / Dependency
J1939Tp-Configuration	1	This container contains the configuration parameters and sub containers of the J1939Tp module that define the communication paths.
J1939TpGeneral	1	This container describes the general configuration parameters of the J1939Tp module.

10.1.2 J1939TpGeneral

SWS Item	[ECUC_J1939Tp_00033]
Container Name	J1939TpGeneral
Parent Container	J1939Tp
Description	This container describes the general configuration parameters of the J1939Tp module.

Configuration Parameters	
--------------------------	--

SWS Item	[ECUC_J1939Tp_00174]
Parameter Name	J1939TpCancellationSupport
Parent Container	J1939TpGeneral
Description	Enable transmit and receive cancellation. The APIs J1939Tp_Cancel Transmit() and J1939Tp_CancelReceive() will only be available when this parameter is enabled.
Multiplicity	0..1
Type	EcucBooleanParamDef

Default value	false		
Post-Build Variant Multiplicity	false		
Post-Build Variant Value	false		
Multiplicity Configuration Class	Pre-compile time	X	All Variants
	Link time	--	
	Post-build time	--	
Value Configuration Class	Pre-compile time	X	All Variants
	Link time	--	
	Post-build time	--	
Scope / Dependency	scope: local		

SWS Item	[ECUC_J1939Tp_00042]		
Parameter Name	J1939TpDevErrorDetect		
Parent Container	J1939TpGeneral		
Description	Switches the development error detection and notification on or off. <ul style="list-style-type: none"> • true: detection and notification is enabled. • false: detection and notification is disabled. 		
Multiplicity	1		
Type	EcucBooleanParamDef		
Default value	false		
Post-Build Variant Value	false		
Value Configuration Class	Pre-compile time	X	All Variants
	Link time	--	
	Post-build time	--	
Scope / Dependency	scope: local		

SWS Item	[ECUC_J1939Tp_00044]		
Parameter Name	J1939TpMainFunctionPeriod		
Parent Container	J1939TpGeneral		
Description	Allow to configure the time for the MainFunction (in seconds). Please note:		

	This configuration value shall be equal to the value in the ScheduleManager module.		
Multiplicity	1		
Type	EcucFloatParamDef		
Range]0 .. INF[
Default value	--		
Post-Build Variant Value	false		
Value Configuration Class	Pre-compile time	X	All Variants
	Link time	--	
	Post-build time	--	
Scope / Dependency	scope: ECU		

SWS Item	[ECUC_J1939Tp_00051]		
Parameter Name	J1939TpVersionInfoApi		
Parent Container	J1939TpGeneral		
Description	The function J1939Tp_GetVersionInfo is configurable (On/Off) by this configuration parameter.		
Multiplicity	1		
Type	EcucBooleanParamDef		
Default value	false		
Post-Build Variant Value	false		
Value Configuration Class	Pre-compile time	X	All Variants
	Link time	--	
	Post-build time	--	
Scope / Dependency	scope: local		

No Included Containers

10.1.3 J1939TpConfiguration

SWS Item	[ECUC_J1939Tp_00052]
Container Name	J1939TpConfiguration
Parent Container	J1939Tp
Description	This container contains the configuration parameters and sub containers of the J1939Tp module that define the communication paths.
Configuration Parameters	

Included Containers		
Container Name	Multiplicity	Scope / Dependency
J1939Tp-RxChannel	0..*	This container describes a reception channel of the J1939Tp module. A channel referencing N-PDUs without MetaData is used for all N-SDUs that share the same source address (SA) and the same destination address (BAM: DA = 0xFF, CMDT: DA != 0xFF). A channel with N-PDUs with MetaData is used for all possible source and destination addresses.
J1939TpTx-Channel	0..*	This container describes a transmission channel of the J1939Tp module. A channel referencing N-PDUs without MetaData is used for all N-SDUs that share the same source address (SA) and the same destination address (BAM: DA = 0xFF, CMDT: DA != 0xFF). A channel with N-PDUs with MetaData is used for all possible source and destination addresses.

10.1.4 J1939TpRxChannel

SWS Item	[ECUC_J1939Tp_00053]
Container Name	J1939TpRxChannel
Parent Container	J1939TpConfiguration
Description	This container describes a reception channel of the J1939Tp module. A channel referencing N-PDUs without MetaData is used for all N-SDUs that share the same source address (SA) and the same destination address (BAM: DA = 0xFF, CMDT: DA != 0xFF). A channel with N-PDUs with MetaData is used for all possible source and destination addresses.
Configuration Parameters	

SWS Item	[ECUC_J1939Tp_00186]
Parameter Name	J1939TpRxCancellationSupport

Parent Container	J1939TpRxChannel		
Description	Enable receive cancellation using the API J1939Tp_CancelReceive() for this channel.		
Multiplicity	0..1		
Type	EcucBooleanParamDef		
Default value	false		
Post-Build Variant Multiplicity	false		
Post-Build Variant Value	false		
Multiplicity Configuration Class	Pre-compile time	X	All Variants
	Link time	--	
	Post-build time	--	
Value Configuration Class	Pre-compile time	X	All Variants
	Link time	--	
	Post-build time	--	
Scope / Dependency	scope: local		

SWS Item	[ECUC_J1939Tp_00178]		
Parameter Name	J1939TpRxDa		
Parent Container	J1939TpRxChannel		
Description	Destination address (DA) of this channel. This parameter is only required for channels with fixed DA which use N-PDUs with MetaData containing the DA.		
Multiplicity	0..1		
Type	EcucIntegerParamDef		
Range	0 .. 253		
Default value	--		
Post-Build Variant Multiplicity	true		
Post-Build Variant Value	true		
Multiplicity Configuration Class	Pre-compile time	X	VARIANT-PRE-COMPILE
	Link time	X	VARIANT-LINK-TIME
	Post-build time	X	VARIANT-POST-BUILD
Value Configuration	Pre-compile time	X	VARIANT-PRE-COMPILE

Class	Link time	X	VARIANT-LINK-TIME
	Post-build time	X	VARIANT-POST-BUILD
Scope / Dependency	scope: local		

SWS Item	[ECUC_J1939Tp_00187]		
Parameter Name	J1939TpRxDynamicBlockCalculation		
Parent Container	J1939TpRxChannel		
Description	Enable dynamic calculation of "number of packets that can be sent" value in TP.CM_CTS, based on the size of buffers in upper layers reported via StartOf Reception and PduR_J1939TpCopyRxData.		
Multiplicity	0..1		
Type	EcucBooleanParamDef		
Default value	false		
Post-Build Variant Multiplicity	false		
Post-Build Variant Value	false		
Multiplicity Configuration Class	Pre-compile time	X	All Variants
	Link time	--	
	Post-build time	--	
Value Configuration Class	Pre-compile time	X	All Variants
	Link time	--	
	Post-build time	--	
Scope / Dependency	scope: local		

SWS Item	[ECUC_J1939Tp_00188]		
Parameter Name	J1939TpRxDynamicBufferRatio		
Parent Container	J1939TpRxChannel		
Description	Percentage of available buffer that shall be used for retry. This parameter is only applicable when "J1939TpRxRetrySupport" and "J1939TpRxDynamicBlockCalculation" are enabled.		
Multiplicity	0..1		
Type	EcucIntegerParamDef		
Range	0 .. 100		

Default value	80		
Post-Build Variant Multiplicity	false		
Post-Build Variant Value	false		
Multiplicity Configuration Class	Pre-compile time	X	All Variants
	Link time	--	
	Post-build time	--	
Value Configuration Class	Pre-compile time	X	All Variants
	Link time	--	
	Post-build time	--	
Scope / Dependency	scope: local dependency: Only applicable when "J1939TpRxRetrySupport" and "J1939TpRxDynamicBlockCalculation" are enabled		

SWS Item	[ECUC_J1939Tp_00189]		
Parameter Name	J1939TpRxPacketsPerBlock		
Parent Container	J1939TpRxChannel		
Description	Number of TP.DT frames the receiving J1939Tp module allows the sender to send before waiting for another TP.CM_CTS. This parameter is transmitted in the TP.CM_CTS frame, and is thus only relevant for reception of messages via CMDT. When J1939TpRxDynamicBlockCalculation is enabled, this parameter specifies a maximum for the calculated value. For further details on this parameter value see SAE J1939/21.		
Multiplicity	0..1		
Type	EcucIntegerParamDef		
Range	1 .. 255		
Default value	16		
Post-Build Variant Multiplicity	false		
Post-Build Variant Value	false		
Multiplicity Configuration Class	Pre-compile time	X	All Variants
	Link time	--	
	Post-build time	--	
Value	Pre-compile time	X	All Variants

Configuration Class	Link time	--	
	Post-build time	--	
Scope / Dependency	scope: local		

SWS Item	[ECUC_J1939Tp_00029]		
Parameter Name	J1939TpRxProtocolType		
Parent Container	J1939TpRxChannel		
Description	Protocol type used by this channel. This parameter is only required for channels with fixed destination address.		
Multiplicity	0..1		
Type	EcucEnumerationParamDef		
Range	J1939TP_PROTOCOL_BAM	J1939 transport protocol type BAM (Broadcast Announce Message). This protocol uses two N-PDUs: The CmNPdu and the DtNPdu.	
	J1939TP_PROTOCOL_CMDT	J1939 transport protocol type CMDT (Connection Mode Data Transfer). This protocol uses three N-PDUs: The CmNPdu, the DtNPdu, and the Fc NPdu.	
Post-Build Variant Multiplicity	false		
Post-Build Variant Value	false		
Multiplicity Configuration Class	Pre-compile time	X	All Variants
	Link time	--	
	Post-build time	--	
Value Configuration Class	Pre-compile time	X	All Variants
	Link time	--	
	Post-build time	--	
Scope / Dependency	scope: local		

SWS Item	[ECUC_J1939Tp_00185]		
Parameter Name	J1939TpRxRetrySupport		
Parent Container	J1939TpRxChannel		
Description	Enable support for triggering repetition of failed transmission using TP.CM_		

	CTS with a packet number that has already been sent. Retransmission is triggered when a sequence number is missing or a timeout occurs during reception.		
Multiplicity	0..1		
Type	EcucBooleanParamDef		
Default value	false		
Post-Build Variant Multiplicity	false		
Post-Build Variant Value	false		
Multiplicity Configuration Class	Pre-compile time	X	All Variants
	Link time	--	
	Post-build time	--	
Value Configuration Class	Pre-compile time	X	All Variants
	Link time	--	
	Post-build time	--	
Scope / Dependency	scope: local		

SWS Item	[ECUC_J1939Tp_00179]		
Parameter Name	J1939TpRxSa		
Parent Container	J1939TpRxChannel		
Description	Source address (SA) of this channel. This parameter is only required for channels with fixed SA which use N-PDUs with MetaData containing the SA.		
Multiplicity	0..1		
Type	EcucIntegerParamDef		
Range	0 .. 253		
Default value	--		
Post-Build Variant Multiplicity	true		
Post-Build Variant Value	true		
Multiplicity Configuration Class	Pre-compile time	X	VARIANT-PRE-COMPILE
	Link time	X	VARIANT-LINK-TIME
	Post-build time	X	VARIANT-POST-BUILD

Value Configuration Class	Pre-compile time	X	VARIANT-PRE-COMPILE
	Link time	X	VARIANT-LINK-TIME
	Post-build time	X	VARIANT-POST-BUILD
Scope / Dependency	scope: local		

Included Containers		
Container Name	Multiplicity	Scope / Dependency
J1939TpRx-CmNPdu	1	This N-PDU represents the TP.CM frame of a J1939 transport protocol session. TP.CM is used both by BAM and CMDT to initialize the connection. For CMDT, it is also used to abort the connection. This N-PDU consumes a meta data item of type CAN_ID_32.
J1939TpRx-DtNPdu	1	This N-PDU represents the TP.DT frame of a J1939 transport protocol session. TP.DT is used both by BAM and CMDT to transfer the contents of an N-SDU. This N-PDU consumes a meta data item of type CAN_ID_32.
J1939TpRx-Pg	1..*	Parameter group received by the J1939 transport layer.
J1939TpTx-FcNPdu	0..1	This N-PDU represents the TP.CM frame that is used in reverse direction for a J1939 transport protocol session using the CMDT protocol type. TP.CM in reverse direction is used for intermediate and final acknowledgement of received data and to abort the connection. This N-PDU produces a meta data item of type CAN_ID_32. Please note: This sub container is only required when J1939TpRx ProtocolType is J1939TP_PROTOCOL_CMDT or when it is not configured at all.

10.1.5 J1939TpRxCmNPdu

SWS Item	[ECUC_J1939Tp_00128]
Container Name	J1939TpRxCmNPdu
Parent Container	J1939TpRxChannel
Description	This N-PDU represents the TP.CM frame of a J1939 transport protocol session. TP.CM is used both by BAM and CMDT to initialize the connection. For CMDT, it is also used to abort the connection. This N-PDU consumes a meta data item of type CAN_ID_32.
Configuration Parameters	

SWS Item	[ECUC_J1939Tp_00129]
----------	----------------------

Parameter Name	J1939TpRxCmNPdulId		
Parent Container	J1939TpRxCmNPdu		
Description	The N-PDU identifier used for communication with CanIf.		
Multiplicity	1		
Type	EcucIntegerParamDef (Symbolic Name generated for this parameter)		
Range	0 .. 65535		
Default value	--		
Post-Build Variant Value	false		
Value Configuration Class	Pre-compile time	X	All Variants
	Link time	--	
	Post-build time	--	
Scope / Dependency	scope: ECU		

SWS Item	[ECUC_J1939Tp_00158]		
Parameter Name	J1939TpRxCmNPduRef		
Parent Container	J1939TpRxCmNPdu		
Description	Reference to the Pdu object representing the N-PDU.		
Multiplicity	1		
Type	Reference to Pdu		
Post-Build Variant Value	true		
Value Configuration Class	Pre-compile time	X	VARIANT-PRE-COMPILE
	Link time	X	VARIANT-LINK-TIME
	Post-build time	X	VARIANT-POST-BUILD
Scope / Dependency	scope: local		

No Included Containers

10.1.6 J1939TpRxDtNPdu

SWS Item	[ECUC_J1939Tp_00117]
Container Name	J1939TpRxDtNPdu

Parent Container	J1939TpRxChannel
Description	This N-PDU represents the TP.DT frame of a J1939 transport protocol session. TP.DT is used both by BAM and CMDT to transfer the contents of an N-SDU. This N-PDU consumes a meta data item of type CAN_ID_32.
Configuration Parameters	

SWS Item	[ECUC_J1939Tp_00133]		
Parameter Name	J1939TpRxDtNPduId		
Parent Container	J1939TpRxDtNPdu		
Description	The N-PDU identifier used for communication with CanIf.		
Multiplicity	1		
Type	EcucIntegerParamDef (Symbolic Name generated for this parameter)		
Range	0 .. 65535		
Default value	--		
Post-Build Variant Value	false		
Value Configuration Class	Pre-compile time	X	All Variants
	Link time	--	
	Post-build time	--	
Scope / Dependency	scope: ECU		

SWS Item	[ECUC_J1939Tp_00134]		
Parameter Name	J1939TpRxDtNPduRef		
Parent Container	J1939TpRxDtNPdu		
Description	Reference to the Pdu object representing the N-PDU.		
Multiplicity	1		
Type	Reference to Pdu		
Post-Build Variant Value	true		
Value Configuration Class	Pre-compile time	X	VARIANT-PRE-COMPILE
	Link time	X	VARIANT-LINK-TIME
	Post-build time	X	VARIANT-POST-BUILD
Scope / Dependency	scope: local		

No Included Containers

10.1.7 J1939TpRxPg

SWS Item	[ECUC_J1939Tp_00050]
Container Name	J1939TpRxPg
Parent Container	J1939TpRxChannel
Description	Parameter group received by the J1939 transport layer.
Configuration Parameters	

SWS Item	[ECUC_J1939Tp_00066]		
Parameter Name	J1939TpRxPgDynLength		
Parent Container	J1939TpRxPg		
Description	This flag is set to TRUE when the N-SDU refers to a PGN with variable length. Please note: When this attribute is TRUE, the sub container J1939TpRx DirectNPdu is required.		
Multiplicity	1		
Type	EcucBooleanParamDef		
Default value	--		
Post-Build Variant Value	false		
Value Configuration Class	Pre-compile time	X	All Variants
	Link time	--	
	Post-build time	--	
Scope / Dependency			

SWS Item	[ECUC_J1939Tp_00065]
Parameter Name	J1939TpRxPgPGN
Parent Container	J1939TpRxPg
Description	PGN of the referenced N-SDUs.
Multiplicity	1
Type	EcucIntegerParamDef

Range	0 .. 262143		
Default value	--		
Post-Build Variant Value	false		
Value Configuration Class	Pre-compile time	X	All Variants
	Link time	--	
	Post-build time	--	
Scope / Dependency	scope: local		

Included Containers		
Container Name	Multiplicity	Scope / Dependency
J1939TpRx-DirectNPdu	0..1	This N-PDU represents the short frame that is used for a dynamic length PGN when it has a length of less than 8 bytes. This N-PDU consumes a meta data item of type CAN_ID_32. Please note: This sub container is only necessary when J1939TpRxPg DynLength is TRUE.
J1939TpRxN-Sdu	1..*	This container describes the parameters that are relevant for the reception of a specific N-SDU. This N-SDU produces meta data items of type SOURCE_ADDRESS_16, TARGET_ADDRESS_16, and PRIORITY_8.

10.1.8 J1939TpRxDirectNPdu

SWS Item	[ECUC_J1939Tp_00130]
Container Name	J1939TpRxDirectNPdu
Parent Container	J1939TpRxPg
Description	This N-PDU represents the short frame that is used for a dynamic length PGN when it has a length of less than 8 bytes. This N-PDU consumes a meta data item of type CAN_ID_32. Please note: This sub container is only necessary when J1939TpRxPgDynLength is TRUE.
Configuration Parameters	

SWS Item	[ECUC_J1939Tp_00131]
Parameter Name	J1939TpRxDirectNPduld
Parent Container	J1939TpRxDirectNPdu

Description	The N-PDU identifier used for communication with CanIf.		
Multiplicity	1		
Type	EcucIntegerParamDef (Symbolic Name generated for this parameter)		
Range	0 .. 65535		
Default value	--		
Post-Build Variant Value	false		
Value Configuration Class	Pre-compile time	X	All Variants
	Link time	--	
	Post-build time	--	
Scope / Dependency	scope: ECU		

SWS Item	[ECUC_J1939Tp_00132]		
Parameter Name	J1939TpRxDirectNPduRef		
Parent Container	J1939TpRxDirectNPdu		
Description	Reference to the Pdu object representing the N-PDU.		
Multiplicity	1		
Type	Reference to Pdu		
Post-Build Variant Value	true		
Value Configuration Class	Pre-compile time	X	VARIANT-PRE-COMPILE
	Link time	X	VARIANT-LINK-TIME
	Post-build time	X	VARIANT-POST-BUILD
Scope / Dependency	scope: local		

No Included Containers

10.1.9 J1939TpRxNSdu

SWS Item	[ECUC_J1939Tp_00063]
Container Name	J1939TpRxNSdu
Parent Container	J1939TpRxPg

Description	This container describes the parameters that are relevant for the reception of a specific N-SDU. This N-SDU produces meta data items of type SOURCE_ADDRESS_16, TARGET_ADDRESS_16, and PRIORITY_8.
Configuration Parameters	

SWS Item	[ECUC_J1939Tp_00184]		
Parameter Name	J1939TpRxNSduld		
Parent Container	J1939TpRxNSdu		
Description	This is a unique identifier for a received N-SDU. This Id is used in the Cancel Receive and ChangeParameter API call.		
Multiplicity	1		
Type	EcucIntegerParamDef (Symbolic Name generated for this parameter)		
Range	0 .. 65535		
Default value	--		
Post-Build Variant Value	false		
Value Configuration Class	Pre-compile time	X	All Variants
	Link time	--	
	Post-build time	--	
Scope / Dependency	scope: ECU		

SWS Item	[ECUC_J1939Tp_00069]		
Parameter Name	J1939TpRxNSduRef		
Parent Container	J1939TpRxNSdu		
Description	Reference to the Pdu object representing the N-SDU.		
Multiplicity	1		
Type	Reference to Pdu		
Post-Build Variant Value	true		
Value Configuration Class	Pre-compile time	X	VARIANT-PRE-COMPILE
	Link time	X	VARIANT-LINK-TIME
	Post-build time	X	VARIANT-POST-BUILD
Scope / Dependency	scope: local		

No Included Containers

10.1.10 J1939TpTxFcNPdu

SWS Item	[ECUC_J1939Tp_00135]
Container Name	J1939TpTxFcNPdu
Parent Container	J1939TpRxChannel
Description	This N-PDU represents the TP.CM frame that is used in reverse direction for a J1939 transport protocol session using the CMDT protocol type. TP.CM in reverse direction is used for intermediate and final acknowledgement of received data and to abort the connection. This N-PDU produces a meta data item of type CAN_ID_32. Please note: This sub container is only required when J1939TpRxProtocolType is J1939TP_PROTOCOL_CMDT or when it is not configured at all.
Configuration Parameters	

SWS Item	[ECUC_J1939Tp_00168]		
Parameter Name	J1939TpTxFcNPduTxConfId		
Parent Container	J1939TpTxFcNPdu		
Description	The N-PDU identifier used for Tx confirmation from CanIf.		
Multiplicity	1		
Type	EcucIntegerParamDef (Symbolic Name generated for this parameter)		
Range	0 .. 65535		
Default value	--		
Post-Build Variant Value	false		
Value Configuration Class	Pre-compile time	X	All Variants
	Link time	--	
	Post-build time	--	
Scope / Dependency	scope: ECU		

SWS Item	[ECUC_J1939Tp_00136]
Parameter Name	J1939TpTxFcNPduRef
Parent Container	J1939TpTxFcNPdu
Description	Reference to the Pdu object representing the N-PDU. Please note: When two channels have identical but exchanged source and

	destination addresses, the Pdu referenced by this parameter is shared with J1939TpTxCmNPduRef of the corresponding J1939TpTxChannel.		
Multiplicity	1		
Type	Reference to Pdu		
Post-Build Variant Value	true		
Value Configuration Class	Pre-compile time	X	VARIANT-PRE-COMPILE
	Link time	X	VARIANT-LINK-TIME
	Post-build time	X	VARIANT-POST-BUILD
Scope / Dependency	scope: local		

No Included Containers

10.1.11 J1939TpTxChannel

SWS Item	[ECUC_J1939Tp_00059]
Container Name	J1939TpTxChannel
Parent Container	J1939TpConfiguration
Description	This container describes a transmission channel of the J1939Tp module. A channel referencing N-PDUs without MetaData is used for all N-SDUs that share the same source address (SA) and the same destination address (BAM: DA = 0xFF, CMDT: DA != 0xFF). A channel with N-PDUs with MetaData is used for all possible source and destination addresses.
Configuration Parameters	

SWS Item	[ECUC_J1939Tp_00192]
Parameter Name	J1939TpTxCancellationSupport
Parent Container	J1939TpTxChannel
Description	Enable transmit cancellation using the API J1939Tp_CancelTransmit() for this channel.
Multiplicity	0..1
Type	EcucBooleanParamDef
Default value	false

Post-Build Variant Multiplicity	false		
Post-Build Variant Value	false		
Multiplicity Configuration Class	Pre-compile time	X	All Variants
	Link time	--	
	Post-build time	--	
Value Configuration Class	Pre-compile time	X	All Variants
	Link time	--	
	Post-build time	--	
Scope / Dependency	scope: local		

SWS Item	[ECUC_J1939Tp_00180]		
Parameter Name	J1939TpTxDa		
Parent Container	J1939TpTxChannel		
Description	Destination address (DA) of this channel. This parameter is only required for channels with fixed DA which use N-PDUs with MetaData containing the DA.		
Multiplicity	0..1		
Type	EcucIntegerParamDef		
Range	0 .. 253		
Default value	--		
Post-Build Variant Multiplicity	true		
Post-Build Variant Value	true		
Multiplicity Configuration Class	Pre-compile time	X	VARIANT-PRE-COMPILE
	Link time	X	VARIANT-LINK-TIME
	Post-build time	X	VARIANT-POST-BUILD
Value Configuration Class	Pre-compile time	X	VARIANT-PRE-COMPILE
	Link time	X	VARIANT-LINK-TIME
	Post-build time	X	VARIANT-POST-BUILD
Scope / Dependency	scope: local		

SWS Item	[ECUC_J1939Tp_00191]
Parameter Name	J1939TpTxDynamicBlockCalculation

Parent Container	J1939TpTxChannel		
Description	Enable dynamic calculation of "maximum number of packets that can be sent" value in TP.CM_RTS, based on the available amount of data in upper layers reported via PduR_J1939TpCopyTxData.		
Multiplicity	0..1		
Type	EcucBooleanParamDef		
Default value	false		
Post-Build Variant Multiplicity	false		
Post-Build Variant Value	false		
Multiplicity Configuration Class	Pre-compile time	X	All Variants
	Link time	--	
	Post-build time	--	
Value Configuration Class	Pre-compile time	X	All Variants
	Link time	--	
	Post-build time	--	
Scope / Dependency	scope: local		

SWS Item	[ECUC_J1939Tp_00190]		
Parameter Name	J1939TpTxMaxPacketsPerBlock		
Parent Container	J1939TpTxChannel		
Description	Maximum number of TP.DT frames the transmitting J1939Tp module is ready to send before waiting for another TP.CM_CTS. This parameter is transmitted in the TP.CM_RTS frame, and is thus only relevant for transmission of messages via CMDT. When J1939TpTxDynamicBlockCalculation is enabled, this parameter specifies a maximum for the calculated value. For further details on this parameter value see SAE J1939/21.		
Multiplicity	0..1		
Type	EcucIntegerParamDef		
Range	1 .. 255		
Default value	255		
Post-Build Variant Multiplicity	false		
Post-Build	false		

Variant Value			
Multiplicity Configuration Class	Pre-compile time	X	All Variants
	Link time	--	
	Post-build time	--	
Value Configuration Class	Pre-compile time	X	All Variants
	Link time	--	
	Post-build time	--	
Scope / Dependency	scope: local		

SWS Item	[ECUC_J1939Tp_00137]		
Parameter Name	J1939TpTxProtocolType		
Parent Container	J1939TpTxChannel		
Description	Protocol type used by this channel. This parameter is only required for channels with fixed destination address.		
Multiplicity	0..1		
Type	EcucEnumerationParamDef		
Range	J1939TP_PROTOCOL_BAM	J1939 transport protocol type BAM (Broadcast Announce Message). This protocol uses two N-PDUs: The CmNPdu and the DtNPdu.	
	J1939TP_PROTOCOL_CMDT	J1939 transport protocol type CMDT (Connection Mode Data Transfer). This protocol uses three N-PDUs: The CmNPdu, the DtNPdu, and the Fc NPdu.	
Post-Build Variant Multiplicity	false		
Post-Build Variant Value	false		
Multiplicity Configuration Class	Pre-compile time	X	All Variants
	Link time	--	
	Post-build time	--	
Value Configuration Class	Pre-compile time	X	All Variants
	Link time	--	
	Post-build time	--	
Scope / Dependency	scope: local		

SWS Item	[ECUC_J1939Tp_00193]		
Parameter Name	J1939TpTxRetrySupport		
Parent Container	J1939TpTxChannel		
Description	Enable support for repetition of failed transmission using TP.CM_CTS with a packet number that has already been sent. Retransmission is handled via the retry feature of PduR_J1939TpCopyTxData.		
Multiplicity	0..1		
Type	EcucBooleanParamDef		
Default value	false		
Post-Build Variant Multiplicity	false		
Post-Build Variant Value	false		
Multiplicity Configuration Class	Pre-compile time	X	All Variants
	Link time	--	
	Post-build time	--	
Value Configuration Class	Pre-compile time	X	All Variants
	Link time	--	
	Post-build time	--	
Scope / Dependency	scope: local		

SWS Item	[ECUC_J1939Tp_00181]		
Parameter Name	J1939TpTxSa		
Parent Container	J1939TpTxChannel		
Description	Source address (SA) of this channel. This parameter is only required for channels with fixed SA which use N-PDUs with MetaData containing the SA.		
Multiplicity	0..1		
Type	EcucIntegerParamDef		
Range	0 .. 253		
Default value	--		
Post-Build Variant Multiplicity	true		
Post-Build Variant Value	true		

Multiplicity Configuration Class	Pre-compile time	X	VARIANT-PRE-COMPILE
	Link time	X	VARIANT-LINK-TIME
	Post-build time	X	VARIANT-POST-BUILD
Value Configuration Class	Pre-compile time	X	VARIANT-PRE-COMPILE
	Link time	X	VARIANT-LINK-TIME
	Post-build time	X	VARIANT-POST-BUILD
Scope / Dependency	scope: local		

Included Containers		
Container Name	Multiplicity	Scope / Dependency
J1939TpRxFcNPdu	0..1	This N-PDU represents the TP.CM frame that is used in reverse direction for a J1939 transport protocol session using the CMDT protocol type. TP.CM in reverse direction is used for intermediate and final acknowledgement of received data and to abort the connection. This N-PDU consumes a meta data item of type CAN_ID_32. Please note: This sub container is only required when J1939TpTx ProtocolType is J1939TP_PROTOCOL_CMDT or when it is not configured at all.
J1939TpTx-CmNPdu	1	This N-PDU represents the TP.CM frame of a J1939 transport protocol session. TP.CM is used both by BAM and CMDT to initialize the connection. For CMDT, it is also used to abort the connection. This N-PDU produces a meta data item of type CAN_ID_32.
J1939TpTx-DtNPdu	1	This N-PDU represents the TP.DT frame of a J1939 transport protocol session. TP.DT is used both by BAM and CMDT to transfer the contents of an N-SDU. This N-PDU produces a meta data item of type CAN_ID_32.
J1939TpTx-Pg	1..*	Parameter group transmitted by the J1939 transport layer.

10.1.12 J1939TpRxFcNPdu

SWS Item	[ECUC_J1939Tp_00144]
Container Name	J1939TpRxFcNPdu
Parent Container	J1939TpTxChannel
Description	This N-PDU represents the TP.CM frame that is used in reverse direction for a J1939 transport protocol session using the CMDT protocol type. TP.CM in reverse direction is used for intermediate and final acknowledgement of received data and to abort the

	connection. This N-PDU consumes a meta data item of type CAN_ID_32. Please note: This sub container is only required when J1939TpTxProtocolType is J1939TP_PROTOCOL_CMDT or when it is not configured at all.
Configuration Parameters	

SWS Item	[ECUC_J1939Tp_00145]		
Parameter Name	J1939TpRxFcNPdul		
Parent Container	J1939TpRxFcNPdu		
Description	The N-PDU identifier used for communication with CanIf.		
Multiplicity	1		
Type	EcucIntegerParamDef (Symbolic Name generated for this parameter)		
Range	0 .. 65535		
Default value	--		
Post-Build Variant Value	false		
Value Configuration Class	Pre-compile time	X	All Variants
	Link time	--	
	Post-build time	--	
Scope / Dependency	scope: ECU		

SWS Item	[ECUC_J1939Tp_00146]		
Parameter Name	J1939TpRxFcNPduRef		
Parent Container	J1939TpRxFcNPdu		
Description	Reference to the Pdu object representing the N-PDU. Please note: When two channels have identical but exchanged source and destination addresses, the Pdu referenced by this parameter is shared with J1939TpRxCmNPduRef of the corresponding J1939TpRxChannel.		
Multiplicity	1		
Type	Reference to Pdu		
Post-Build Variant Value	true		
Value Configuration Class	Pre-compile time	X	VARIANT-PRE-COMPILE
	Link time	X	VARIANT-LINK-TIME
	Post-build time	X	VARIANT-POST-BUILD
Scope / Dependency	scope: local		

No Included Containers

10.1.13 J1939TpTxCmNPdu

SWS Item	[ECUC_J1939Tp_00138]
Container Name	J1939TpTxCmNPdu
Parent Container	J1939TpTxChannel
Description	This N-PDU represents the TP.CM frame of a J1939 transport protocol session. TP.CM is used both by BAM and CMDT to initialize the connection. For CMDT, it is also used to abort the connection. This N-PDU produces a meta data item of type CAN_ID_32.
Configuration Parameters	

SWS Item	[ECUC_J1939Tp_00170]		
Parameter Name	J1939TpTxCmNPduTxConflf		
Parent Container	J1939TpTxCmNPdu		
Description	The N-PDU identifier used for Tx confirmation from CanIf.		
Multiplicity	1		
Type	EcucIntegerParamDef (Symbolic Name generated for this parameter)		
Range	0 .. 65535		
Default value	--		
Post-Build Variant Value	false		
Value Configuration Class	Pre-compile time	X	All Variants
	Link time	--	
	Post-build time	--	
Scope / Dependency	scope: ECU		

SWS Item	[ECUC_J1939Tp_00139]
Parameter Name	J1939TpTxCmNPduRef
Parent Container	J1939TpTxCmNPdu
Description	Reference to the Pdu object representing the N-PDU.

Multiplicity	1		
Type	Reference to Pdu		
Post-Build Variant Value	true		
Value Configuration Class	Pre-compile time	X	VARIANT-PRE-COMPILE
	Link time	X	VARIANT-LINK-TIME
	Post-build time	X	VARIANT-POST-BUILD
Scope / Dependency	scope: local		

No Included Containers

10.1.14 J1939TpTxDtNPdu

SWS Item	[ECUC_J1939Tp_00142]
Container Name	J1939TpTxDtNPdu
Parent Container	J1939TpTxChannel
Description	This N-PDU represents the TP.DT frame of a J1939 transport protocol session. TP.DT is used both by BAM and CMDT to transfer the contents of an N-SDU. This N-PDU produces a meta data item of type CAN_ID_32.

Configuration Parameters

SWS Item	[ECUC_J1939Tp_00171]		
Parameter Name	J1939TpTxDtNPduTxConfld		
Parent Container	J1939TpTxDtNPdu		
Description	The N-PDU identifier used for Tx confirmation from CanIf.		
Multiplicity	1		
Type	EcucIntegerParamDef (Symbolic Name generated for this parameter)		
Range	0 .. 65535		
Default value	--		
Post-Build Variant Value	false		
Value Configuration Class	Pre-compile time	X	All Variants
	Link time	--	

	Post-build time	--	
Scope / Dependency	scope: ECU		

SWS Item	[ECUC_J1939Tp_00143]		
Parameter Name	J1939TpTxDtNPduRef		
Parent Container	J1939TpTxDtNPdu		
Description	Reference to the Pdu object representing the N-PDU.		
Multiplicity	1		
Type	Reference to Pdu		
Post-Build Variant Value	true		
Value Configuration Class	Pre-compile time	X	VARIANT-PRE-COMPILE
	Link time	X	VARIANT-LINK-TIME
	Post-build time	X	VARIANT-POST-BUILD
Scope / Dependency	scope: local		

No Included Containers

10.1.15 J1939TpTxPg

SWS Item	[ECUC_J1939Tp_00070]
Container Name	J1939TpTxPg
Parent Container	J1939TpTxChannel
Description	Parameter group transmitted by the J1939 transport layer.
Configuration Parameters	

SWS Item	[ECUC_J1939Tp_00148]
Parameter Name	J1939TpTxPgDynLength
Parent Container	J1939TpTxPg
Description	This flag is set to TRUE when the N-SDU refers to a PGN with variable length. Please note: When this attribute is TRUE, the sub container J1939TpTx DirectNPdu is required.
Multiplicity	1

Type	EcucBooleanParamDef		
Default value	--		
Post-Build Variant Value	false		
Value Configuration Class	Pre-compile time	X	All Variants
	Link time	--	
	Post-build time	--	
Scope / Dependency	scope: local		

SWS Item	[ECUC_J1939Tp_00150]		
Parameter Name	J1939TpTxPgPGN		
Parent Container	J1939TpTxPg		
Description	PGN of the referenced N-SDUs.		
Multiplicity	1		
Type	EcucIntegerParamDef		
Range	0 .. 262143		
Default value	--		
Post-Build Variant Value	false		
Value Configuration Class	Pre-compile time	X	All Variants
	Link time	--	
	Post-build time	--	
Scope / Dependency	scope: local		

Included Containers		
Container Name	Multiplicity	Scope / Dependency
J1939TpTx-DirectNPdu	0..1	This N-PDU represents the short frame that is used for a dynamic length PGN when it has a length of less than 8 bytes. This N-PDU produces a meta data item of type CAN_ID_32. Please note: This sub container is only necessary when J1939TpTxPg DynLength is TRUE.
J1939TpTxN-Sdu	1..*	This container describes the parameters that are relevant for the transmission of a specific N-SDU. This N-SDU consumes meta data items of type SOURCE_ADDRESS_16, TARGET_ADDRESS_16, and PRIORITY_8.

10.1.16 J1939TpTxDirectNPdu

SWS Item	[ECUC_J1939Tp_00140]
Container Name	J1939TpTxDirectNPdu
Parent Container	J1939TpTxPg
Description	This N-PDU represents the short frame that is used for a dynamic length PGN when it has a length of less than 8 bytes. This N-PDU produces a meta data item of type CAN_ID_32. Please note: This sub container is only necessary when J1939TpTxPgDynLength is TRUE.
Configuration Parameters	

SWS Item	[ECUC_J1939Tp_00169]		
Parameter Name	J1939TpTxDirectNPduTxConfId		
Parent Container	J1939TpTxDirectNPdu		
Description	The N-PDU identifier used for Tx confirmation from CanIf.		
Multiplicity	1		
Type	EcucIntegerParamDef (Symbolic Name generated for this parameter)		
Range	0 .. 65535		
Default value	--		
Post-Build Variant Value	false		
Value Configuration Class	Pre-compile time	X	All Variants
	Link time	--	
	Post-build time	--	
Scope / Dependency	scope: ECU		

SWS Item	[ECUC_J1939Tp_00141]
Parameter Name	J1939TpTxDirectNPduRef
Parent Container	J1939TpTxDirectNPdu
Description	Reference to the Pdu object representing the N-PDU.
Multiplicity	1
Type	Reference to Pdu
Post-Build Variant Value	true

Value Configuration Class	Pre-compile time	X	VARIANT-PRE-COMPILE
	Link time	X	VARIANT-LINK-TIME
	Post-build time	X	VARIANT-POST-BUILD
Scope / Dependency	scope: local		

No Included Containers

10.1.17 J1939TpTxNSdu

SWS Item	[ECUC_J1939Tp_00147]
Container Name	J1939TpTxNSdu
Parent Container	J1939TpTxPg
Description	This container describes the parameters that are relevant for the transmission of a specific N-SDU. This N-SDU consumes meta data items of type SOURCE_ADDRESS_16, TARGET_ADDRESS_16, and PRIORITY_8.
Configuration Parameters	

SWS Item	[ECUC_J1939Tp_00149]		
Parameter Name	J1939TpTxNSdulld		
Parent Container	J1939TpTxNSdu		
Description	The N-SDU identifier used for communication with PduR.		
Multiplicity	1		
Type	EcucIntegerParamDef (Symbolic Name generated for this parameter)		
Range	0 .. 65535		
Default value	--		
Post-Build Variant Value	false		
Value Configuration Class	Pre-compile time	X	All Variants
	Link time	--	
	Post-build time	--	
Scope / Dependency	scope: ECU		

SWS Item	[ECUC_J1939Tp_00151]		
Parameter Name	J1939TpTxNSduRef		
Parent Container	J1939TpTxNSdu		
Description	Reference to the Pdu object representing the N-SDU.		
Multiplicity	1		
Type	Reference to Pdu		
Post-Build Variant Value	true		
Value Configuration Class	Pre-compile time	X	VARIANT-PRE-COMPILE
	Link time	X	VARIANT-LINK-TIME
	Post-build time	X	VARIANT-POST-BUILD
Scope / Dependency	scope: local		

No Included Containers

10.2 Published Information

For details, refer to the chapter 10.3 “Published Information” in the SWS BSW General [15].

11 Not applicable requirements

[SWS_J1939Tp_NA] [These requirements are not applicable to this specification.]

(SRS_J1939_00005, SRS_J1939_00007, SRS_J1939_00008, SRS_J1939_00009,
SRS_J1939_00012, SRS_J1939_00013, SRS_J1939_00014, SRS_J1939_00015,
SRS_J1939_00016, SRS_J1939_00017, SRS_J1939_00026, SRS_J1939_00027,
SRS_J1939_00028, SRS_J1939_00029, SRS_J1939_00030, SRS_J1939_00031,
SRS_J1939_00032, SRS_J1939_00033, SRS_J1939_00034, SRS_J1939_00035,
SRS_J1939_00036, SRS_J1939_00037, SRS_J1939_00050, SRS_J1939_00051, SRS_J1939_NA,
SRS_BSW_00005, SRS_BSW_00161, SRS_BSW_00162, SRS_BSW_00164, SRS_BSW_00168,
SRS_BSW_00170, SRS_BSW_00314, SRS_BSW_00325, SRS_BSW_00341, SRS_BSW_00347,
SRS_BSW_00375, SRS_BSW_00377, SRS_BSW_00413, SRS_BSW_00415, SRS_BSW_00416,
SRS_BSW_00417, SRS_BSW_00419, SRS_BSW_00423, SRS_BSW_00427, SRS_BSW_00433,
SRS_BSW_00437, SRS_BSW_00439, SRS_BSW_00440, SRS_BSW_00447, SRS_BSW_00449,
SRS_BSW_00453)