

Document Title	Specification of Cryptography
Document Owner	AUTOSAR
Document Responsibility	AUTOSAR
Document Identification No	883

Document Status	published
Part of AUTOSAR Standard	Adaptive Platform
Part of Standard Release	R22-11

Document Change History			
Date	Release	Changed by	Description
2022-11-24	R22-11	AUTOSAR Release Management	<ul style="list-style-type: none"> • Added: <ul style="list-style-type: none"> [SWS_CRYPT_40984] [SWS_CRYPT_40985] • Updated: <ul style="list-style-type: none"> [SWS_CRYPT_00502] [SWS_CRYPT_00503] [SWS_CRYPT_40983] [SWS_CRYPT_01820] [SWS_CRYPT_01821] [SWS_CRYPT_00919] [SWS_CRYPT_03303] [SWS_CRYPT_03305] [SWS_CRYPT_04204] [SWS_CRYPT_01821] [SWS_CRYPT_00919] • Updated API: <ul style="list-style-type: none"> [SWS_CRYPT_40981] [SWS_CRYPT_20746] [SWS_CRYPT_21115] [SWS_CRYPT_21312] [SWS_CRYPT_22711] [SWS_CRYPT_23012] [SWS_CRYPT_23013] [SWS_CRYPT_23014] • Editorial changes

2021-11-25	R21-11	AUTOSAR Release Management	<ul style="list-style-type: none"> • Reworked SWS items in chapter 7 to improve testability • Improved traceability between chapters 7 and 8
2020-11-30	R20-11	AUTOSAR Release Management	<ul style="list-style-type: none"> • Rewrote the document to align with AUTOSAR standard • Update of Crypto API according to WG-SEC feedback
2019-03-29	R19-03	AUTOSAR Release Management	<ul style="list-style-type: none"> • "Direct" prefix of Crypto API is removed, because now it is single • All bugs found after R18-03 are fixed • Crypto API is converted for usage of basic <code>ara::core</code> types • Crypto API is converted for support of the "Exception-less" approach • Detalization of Crypto API specification is extended
2018-08-20	R18-10	AUTOSAR Release Management	<ul style="list-style-type: none"> • Removed crypto API introduced in release 17-10
2018-03-29	R18-03	AUTOSAR Release Management	<ul style="list-style-type: none"> • Crypto API introduced at previous release is renamed to Modeled API, chapter 7 is updated • Added specification of additional Direct Crypto API (chapter 9)
2017-10-27	R17-10	AUTOSAR Release Management	<ul style="list-style-type: none"> • Initial release

Disclaimer

This work (specification and/or software implementation) and the material contained in it, as released by AUTOSAR, is for the purpose of information only. AUTOSAR and the companies that have contributed to it shall not be liable for any use of the work.

The material contained in this work is protected by copyright and other types of intellectual property rights. The commercial exploitation of the material contained in this work requires a license to such intellectual property rights.

This work may be utilized or reproduced without any modification, in any form or by any means, for informational purposes only. For any other purpose, no part of the work may be utilized or reproduced, in any form or by any means, without permission in writing from the publisher.

The work has been developed for automotive applications only. It has neither been developed, nor tested for non-automotive applications.

The word AUTOSAR and the AUTOSAR logo are registered trademarks.

Contents

1	Introduction and functional overview	6
2	Acronyms and Abbreviations	7
3	Related documentation	11
3.1	Input documents & related standards and norms	11
3.2	Further applicable specification	14
4	Constraints and assumptions	15
4.1	Constraints	15
4.2	Assumptions	15
4.3	Known limitations	15
4.4	Applicability to car domains	16
5	Dependencies to other functional clusters	17
5.1	Protocol layer dependencies	17
6	Requirements Tracing	18
7	Functional specification	41
7.1	Functional Cluster Lifecycle	41
7.1.1	Startup	41
7.1.2	Shutdown	41
7.2	Architectural concepts	42
7.2.1	Integration with Identity and Access Management	44
7.2.2	Integration into AUTOSAR	46
7.2.3	Application level	48
7.2.4	System service level	49
7.2.5	Bridging domains: the IOInterface	49
7.3	Crypto API structure	50
7.4	Crypto API elements	51
7.4.1	Crypto Provider	51
7.4.1.1	Random Number Generator (RNG)	58
7.4.1.2	Key Derivation Function (KDF)	60
7.4.1.3	Hashing	62
7.4.1.4	Message Authentication Code (MAC)	65
7.4.1.5	Symmetric encryption	69
7.4.1.6	Authenticated Encryption	74
7.4.1.7	Key Wrapping	76
7.4.1.8	Digital signatures	78
7.4.1.9	Asymmetric encryption	83
7.4.1.10	Key Encapsulation Mechanism (KEM)	85
7.4.1.11	Key Exchange Protocol, Key Exchange Mechanism, and Key Exchange Scheme	88
7.4.1.12	Identification of cryptographic primitives and using one	90

7.4.1.13	Support on internal elements (Loading, Update, Import, and Export)	91
7.4.2	Key Storage Provider	96
7.4.2.1	Serializable interface	98
7.4.2.2	Key Generation	99
7.4.2.3	Exporting and Importing of Key Material	100
7.4.3	Certificate handling (X.509 Provider)	100
7.4.3.1	Certificate Signing Request	104
7.4.3.2	Using Certificates	105
7.4.3.3	Revocation of certificates	108
7.5	Cryptographic Primitives Naming Convention	111
8	API specification	114
8.1	C++ language binding Crypto Provider	114
8.2	C++ language binding Key Storage Provider	241
8.3	C++ language binding X509 Certificate Management Provider	258
8.4	API Common Data Types	307
8.5	API Reference	314
9	Service Interfaces	344
9.1	Type definitions	344
9.2	Provided Service Interfaces	344
9.3	Required Service Interfaces	344
9.4	Application Errors	344
A	Mentioned Manifest Elements	345
B	Interfaces to other Functional Clusters (informative)	352
B.1	Overview	352
B.2	Interface Tables	352

1 Introduction and functional overview

This specification describes the functionality and the configuration for the Adaptive AUTOSAR [Functional Cluster Cryptography \(FC Crypto\)](#) and its API ([CryptoAPI](#)), which is part of the AUTOSAR Adaptive Platform Foundation.

The [FC Crypto](#) offers applications and other Adaptive AUTOSAR [Functional Clusters](#) a standardized interface, which provides operations for cryptographic and related calculations. These operations include cryptographic operations, key management, and certificate handling. [FC Crypto](#) manages the actual implementations of all operations, the configuration, and the brokering of operations from applications to implementations. The standardized interface is exposed by the [CryptoAPI](#).

The [FC Crypto](#) and its [CryptoAPI](#) supports both public-key and symmetric-key cryptography. It allows applications to use mechanisms such as authentication, encryption, and decryption for automotive services.

2 Acronyms and Abbreviations

The glossary below includes acronyms and abbreviations relevant to the FC Crypto module that are not included in the [1, AUTOSAR glossary].

Abbreviation / Acronym:	Description:
ACL	Access Control List
AE	Authenticated Encryption
AEAD	Authenticated Encryption with Associated Data – Encryption scheme which simultaneously provides confidentiality and authenticity of data as well as additional authenticated but not encrypted data.
AES	Advanced Encryption Standard – A block cipher for the symmetric encryption of electronic data.
API	Abstract Programming Interface
ARA	Autosar Runtime Environment for Adaptive Applications
ASN.1	Abstract Syntax Notation One, as defined in the ASN.1 standards
BER	Basic Encoding Rules
BLOB	Binary Large Object – A Binary Large Object (BLOB) is a collection of binary data stored as a single entity.
CA	Certificate Authority or Certification Authority is an entity that issues digital certificates.
CBC	Cipher Block Chaining Mode – A mode of operation for symmetric ciphers (e.g. AES) that supports encryption.
CBC-MAC	Cipher Block Chaining Message Authentication Mode – A mode of operation for symmetric ciphers (e.g. AES) that supports authentication.
CCM	Counter Mode with CBC-MAC – An AEAD operation mode (encryption and authentication) for AES.
CMAC	Cipher-based Message Authentication Code – A mode of operation for symmetric ciphers (e.g. AES) that supports authentication and is similar but advanced to CBC-MAC.
CMP	X.509 Certificate Management Provider.
CO	Cryptographic Object
COUID	Cryptographic Object Unique Identifier
CRL	Certificate Revocation Lists is a list of digital certificates that have been revoked before their expiration date was reached. This list contains all the serial numbers of the revoked certificates and the revoked data.
CSR	Certificate Signing Request
CTL	Certificate Trust List is a list of digital certificates that are explicitly trusted in this environment. This list contains all the serial numbers of the explicitly trusted certificates.
DER	Distinguished Encoding Rules as defined in [2]
DH	Diffie-Hellman (key exchange method)
ECC	Elliptic Curve Cryptography – Public-key cryptography based on the structure of elliptic curves.
ECDH	Elliptic Curve Diffie-Hellman – An ECC based DH key exchange with perfect forward secrecy.
ECDSA	Elliptic Curve Digital Signature Algorithm – An ECC based signature scheme.
ECIES	Elliptic Curve Integrated Encryption Scheme – An ECC based encryption scheme.
ECU	Electronic Control Unit

Abbreviation / Acronym:	Description:
FC Crypto	Functional cluster Cryptography. This is the AUTOSAR cluster, which provides all important functionality related to cryptographic, key management, and certificate handling needs.
gamma	linear recurrent sequence
GCM	Galois Counter Mode – An AEAD operation mode (encryption and authentication) for AES.
GMAC	Galois MAC – A mode of operation for symmetric ciphers (e.g. AES) that supports authentication.
HSM	Hardware Security Module – Hardware security module, used to store cryptographic credentials and secure run-time environment
HMAC	Hashed Message Authentication Code
IAM	Identity and Access Management
IETF	Internet Engineering Task Force
IKE	Internet Key Exchange
IPC	Inter-Process Communication
IPsec	Internet Protocol Security (IPsec) is a secure network protocol suite that authenticates and encrypts the packets of data to provide secure encrypted communication between two computers over an Internet Protocol network.
IV	Initialization Vector
KDF	Key Derivation Function – A function to derive one or more keys from a secret value.
KEK	Key encryption key – A key that is used to encrypt another key for transportation or storage in an unsecure environment
KEM	Key Encapsulation Mechanism
KSP	Key Storage Provider
MAC	Message Authentication Code
MGF	Mask Generation Function – A cryptographic function similar to a hash function. It takes a variable length input and an output length l to generate an output of length l . If the input is unknown, the output appears random.
OCSP	Online Certificate Status Protocol – Internet protocol used to obtain revocation status of X.509 certificates.
PDP	Policy Decision Point
PEP	Policy Enforcement Point
PEM	Privacy-Enhanced Mail
PKI	Public Key Infrastructure – A system that issues, distributes, and checks digital certificates.
PKCS	Public Key Cryptography Standard.
RA	Registration Authority
RNG	Random Number Generator
RSA	Rivest, Shamir, Adleman – RSA is an algorithm for public-key cryptography; It is named after its inventors Ronald L. Rivest, Adi Shamir and Leonard Adleman.
SecOC	Secure Onboard Communication
SHA-1	Secure Hash Algorithm (version 1) – Hash functions family.
SHA-2	Secure Hash Algorithm (version 2) – Hash functions family with different hash value length.
SHA-3	Secure Hash Algorithm (version 3) – New hash function generation, faster and more secure as SHA-2.
SHE	Secure Hardware Extension
TLS	Transport Layer Security (TLS) is a cryptographic protocol designed to provide communications security over a computer network.

Abbreviation / Acronym:	Description:
TPM	The Trusted Platform Module is defined in [3] and is a secure cryptoprocessor.
UCM	Update and Configuration Management
UID	Unique Identifier
X.509	Standard for certificates

Terms:	Description:
Adaptive Application	An adaptive application is a part of application SW in the architecture of Adaptive AUTOSAR. An adaptive application runs on top of ARA and accesses AUTOSAR functional clusters through ARA.
Adaptive Platform Services	Adaptive Platform Services are located below the ARA. They provide platform standard services of Adaptive AUTOSAR.
Asymmetric Key	An asymmetric key describes a pair of two keys (public and private key). A cipher text created by one key cannot be decrypted with this key. Encryption is only possible with the other key of this pair.
Block Cipher	A symmetric encryption that encrypts plaintext blocks of fixed length.
certificate serial number	An integer value, unique within the issuing authority, which is unambiguously associated with a certificate issued by that authority.
Certificate Slot	Secure storage of certificate material. Certificate slots define the access to the stored certificate material and may grant the access only to authorized application or functional cluster.
certification path	An ordered list of one or more public-key certificates, starting with a public-key certificate signed by the trust anchor, and ending with the public key certificate to be validated. All intermediate public-key certificates, if any, are CA-certificates in which the subject of the preceding certificate is the issuer of the following certificate.
Ciphertext	A ciphertext is an encrypted text, which is the result of encryption performed on <code>plaintext</code> .
CryptoAPI	The set of all interfaces that are provided by FC Crypto to consumers.
Crypto Provider	A structural element that organizes cryptographic primitives.
Cryptographic primitives	Well-established, low-level cryptographic algorithms that are frequently used to build cryptographic protocols for computer security systems.
Distinguished name	is originally defined in X.501 [4] as a representation of a directory name, defined as a construct that identifies a particular object from among a set of all objects.
Functional Cluster	The SW functionality of ARA is divided into functional clusters. Functional clusters provide APIs and can communicate with each other.
Identity and Access Management	A functional cluster of adaptive AUTOSAR.
Instance Specifier	Crypto provider can have more than one instance. To distinguish between instances the specific instance is addressed with an instance specifier. An instance specifier identifies one instance of a crypto provider.
Key Material	public keys, private keys, seeds.
Key Slot	Secure storage of key material. Key slots define the access to the stored key material and grant the access only to authorized application or functional cluster.

Terms:	Description:
Key Storage Provider	A structural element that organizes and manages cryptographic keys.
Message Authentication Code	A cryptographic function similar to a hash function. It takes a message of variable length and a secret key as input to generate a hash value, the MAC value. The MAC value is attached to the message to be sent. The receiver of the message can recalculate the MAC value to check if the message is authentic.
Nonce	A nonce is a random or semi-random number that is generated for cryptographic topics. A nonce can be used as an input to a hash algorithm so that the hash algorithm computes a hash value out of two inputs: plaintext and nonce. Usage of nonces enhances security against brute force attacks.
Plaintext	A plaintext is ordinary readable text before being encrypted into ciphertext or after being decrypted.
Policy Decision Point	A PDP defines which item (process, application, function) can decide if a requested access to resources may be granted or not.
Policy Enforcement Point	A PEP is the point a policy decision is used to grant or deny the access.
Random Number Generator	A program that generates random numbers or pseudo random numbers in a given range.
Salt	A salt is a random or semi-random number which is created for passwords. When a password is edited for a user/account also a salt is created for this user/account. A hash algorithm creates a hash value of password and salt. Salts increase the security against brute force password guessing attacks.
SecretSeed	A secret value that is used as an initial value to start encryption/decryption.
Stream Cipher	A symmetric encryption that calculates cipher text out of streaming plaintext and the status result of the encryption of previous streamed plaintext. For the first part of encryption a start value is needed as status result.
Symmetric Key	In a symmetric encryption the same key (symmetric key) is used to encrypt plaintext into cipher text and to decode cipher text into plaintext. A symmetric key is also called secret key because it must be kept secret.
X.509 Provider	Domain SW for X.509 certificates parsing, verification, storage and search.

3 Related documentation

3.1 Input documents & related standards and norms

- [1] Glossary
AUTOSAR_TR_Glossary
- [2] X.690 : Information technology - ASN.1 encoding rules: Specification of Basic Encoding Rules (BER), Canonical Encoding Rules (CER) and Distinguished Encoding Rules (DER)
<https://www.itu.int/rec/T-REC-X.690>
- [3] ISO/IEC 11889-1:2015 Information technology - Trusted platform module library - Part 1: Architecture
<http://www.iso.org>
- [4] X.501 : Information technology - Open Systems Interconnection - The Directory: Models
<https://www.itu.int/rec/T-REC-X.501>
- [5] Specification of Adaptive Platform Core
AUTOSAR_SWS_AdaptivePlatformCore
- [6] General Requirements specific to Adaptive Platform
AUTOSAR_RS_General
- [7] Requirements on Cryptography
AUTOSAR_RS_Cryptography
- [8] BSI: Functionality Classes and Evaluation Methodology for Deterministic Random Number Generators (AIS)
[https://www.bsi.bund.de/SharedDocs/Downloads/DE/BSI/Zertifizierung/Interpretationen/AIS_20_Functionality_Classes_Evaluation_Methodology_DRNG_e.pdf?__blob=publicationFile\[5\]](https://www.bsi.bund.de/SharedDocs/Downloads/DE/BSI/Zertifizierung/Interpretationen/AIS_20_Functionality_Classes_Evaluation_Methodology_DRNG_e.pdf?__blob=publicationFile[5])
- [9] Recommendation for Pair-Wise Key-Establishment Schemes Using Discrete Logarithm Cryptography
<https://nvlpubs.nist.gov/nistpubs/SpecialPublications/NIST.SP.800-56Ar3.pdf>
- [10] Public Key Cryptography for the Financial Services Industry Key Agreement and Key Stransport Using Elliptic Curve Cryptography
[https://webstore.ansi.org/preview-pages/ASCX9/preview_ANSI+X9.63-2011+\(R2017\).pdf](https://webstore.ansi.org/preview-pages/ASCX9/preview_ANSI+X9.63-2011+(R2017).pdf)
- [11] Recommendation for Key Derivation Using Pseudorandom Functions (Revised)
<https://nvlpubs.nist.gov/nistpubs/Legacy/SP/nistspecialpublication800-108.pdf>
- [12] Elliptic Curve Cryptography
<https://www.secg.org/sec1-v2.pdf>
- [13] ISO IEC 9797-3:2011 Amd 1:2020(en) Information technology - Security tech-

- niques - Message Authentication Codes (MAC)
<http://www.iso.org>
- [14] HMAC: Keyed-Hashing for Message Authentication
<https://tools.ietf.org/html/rfc2104>
- [15] Updated Security Considerations the MD5 Message-Digest and the HMAC-MD5 Algorithms
<https://tools.ietf.org/html/rfc6151>
- [16] Using Advanced Encryption Standard Counter Mode (AES-CTR) with the Internet Key Exchange version 02 (IKEv2) Protocol
<https://rfc-editor.org/rfc/rfc5930.txt>
- [17] ChaCha20-Poly1305 Cipher Suites for Transport Layer Security (TLS)
<https://rfc-editor.org/rfc/rfc7905.txt>
- [18] TRIVIUM Specifications
<http://citeseerx.ist.psu.edu/viewdoc/summary?doi=10.1.1.59.9030>
- [19] PKCS #5: Password-Based Cryptography Specification Version 2.0
<https://rfc-editor.org/rfc/rfc2898.txt>
- [20] PKCS #5: Password-Based Cryptography Specification Version 2.1
<https://rfc-editor.org/rfc/rfc8018.txt>
- [21] PKCS #7: Cryptographic Message Syntax Version 1.5
<https://rfc-editor.org/rfc/rfc2315.txt>
- [22] Financial institution encryption of wholesale financial messages: X9.23
- [23] Advanced Encryption Standard (AES) Key Wrap Algorithm
<https://tools.ietf.org/html/rfc3394>
- [24] Advanced Encryption Standard (AES) Key Wrap with Padding Algorithm
<https://tools.ietf.org/html/rfc5649>
- [25] ISO/IEC 9796-2:2010 Information technology - Security techniques - Digital signature schemes giving message recovery - Part 2: Integer factorization based mechanisms
<http://www.iso.org>
- [26] Use of Elliptic Curve Cryptography (ECC) Algorithms in Cryptographic Message Syntax (CMS)
<https://rfc-editor.org/rfc/rfc3278.txt>
- [27] Use of Elliptic Curve Cryptography (ECC) Algorithms in Cryptographic Message Syntax (CMS)
<https://rfc-editor.org/rfc/rfc5753.txt>
- [28] IEEE P1363: A Standard for RSA, Diffie-Hellman, and Elliptic-Curve Cryptography (Abstract)

- [29] New directions in cryptography
<https://ieeexplore.ieee.org/document/1055638>
- [30] Guide for Internet Standards Writers
<https://tools.ietf.org/html/rfc2360>
- [31] X.509 Internet Public Key Infrastructure Online Certificate Status Protocol - OCSP
<https://rfc-editor.org/rfc/rfc6960.txt>
- [32] Standard X.509
<https://www.itu.int/rec/T-REC-X.509/en>
- [33] Internet X.509 Public Key Infrastructure Certificate and Certificate Revocation List (CRL) Profile
<https://rfc-editor.org/rfc/rfc5280.txt>
- [34] PKCS #10: Certification Request Syntax Specification Version 1.7
<https://tools.ietf.org/html/rfc2986>
- [35] The application/pkcs10 Media Type
<https://tools.ietf.org/html/rfc5967>
- [36] Internet X.509 Certificate Request Message Format
<https://tools.ietf.org/html/rfc2511>
- [37] Internet X.509 Public Key Infrastructure Certificate Request Message Format (CRMF)
<https://tools.ietf.org/html/rfc4211>
- [38] S/MIME Version 2 Message Specification
<https://tools.ietf.org/html/rfc2311>
- [39] Public-Key Cryptography Standards (PKCS) #8: Private-Key Information Syntax Specification Version 1.2
<https://rfc-editor.org/rfc/rfc5208.txt>
- [40] PKCS #12: Personal Information Exchange Syntax v1.1
<https://tools.ietf.org/html/rfc7292>
- [41] X.680 : Information technology - Abstract Syntax Notation One (ASN.1): Specification of basic notation
<https://www.itu.int/rec/T-REC-X.680>
- [42] X.682 : Information technology - Abstract Syntax Notation One (ASN.1): Constraint specification
<https://www.itu.int/rec/T-REC-X.682>
- [43] X.683 : Information technology - Abstract Syntax Notation One (ASN.1): Parameterization of ASN.1 specifications
<https://www.itu.int/rec/T-REC-X.683>
- [44] Keying and Authentication for Routing Protocols (KARP) Design Guidelines
<https://tools.ietf.org/html/rfc6518>

- [45] Internationalized Email Addresses in X.509 Certificates
<https://tools.ietf.org/html/rfc8398>
- [46] Internationalization Updates to RFC 5280
<https://tools.ietf.org/html/rfc8399>
- [47] Transport Layer Security (TLS) Extensions: Extension Definitions
<https://tools.ietf.org/html/rfc6066>
- [48] The Transport Layer Security (TLS) Multiple Certificate Status Request Extension
<https://tools.ietf.org/html/rfc6961>
- [49] The Transport Layer Security (TLS) Protocol Version 1.3
<https://tools.ietf.org/html/rfc8446>

3.2 Further applicable specification

AUTOSAR provides a core specification [5, SWS AdaptivePlatformCore] which is also applicable for FC Crypto. The chapter "General requirements for all FunctionalClusters" of this specification shall be considered as an additional and required specification for implementation of FC Crypto.

4 Constraints and assumptions

4.1 Constraints

For the design of the [FC Crypto](#) and the [CryptoAPI](#) the following constraints were applied:

- Support the independence of application software components from a specific platform implementation.
- Make the API as lean as possible, no specific use cases are supported, which could also be layered on top of the API.
- Offer a "comfort layer" to enable the use of C++11/14 features.
- Support the integration into safety relevant systems.
- Support the integration into cyber security relevant systems.

4.2 Assumptions

The [Adaptive Application](#) and [Functional Cluster](#) should not have direct access to keys within its own process. The [FC Crypto](#) and its building blocks mediates for [Adaptive Application](#) and [Functional Cluster](#) access and usage of secret [Key Material](#). Therefore, the [FC Crypto](#) verifies whether an application or functional cluster is allowed to access a specific cryptographic object, which is stored in the infrastructure of the [FC Crypto](#). This access control mechanism is realized in combination with [IAM](#), where the [FC Crypto](#) acts as a policy enforcement point.

Beside the support of applications and [Functional Clusters](#), the [FC Crypto](#) provides mechanism to ensure secure communication. The [FC Crypto](#) helps [Adaptive Application](#) and [Functional Cluster](#) to establish secure channels. The [FC Crypto](#) also allows to store data persistent in an encrypted manner.

4.3 Known limitations

The following functional domains and descriptions are still missing in the current version of [Crypto API](#) specification:

- **Asynchronous interfaces**
Currently there is only a synchronous API specification and asynchronous behavior (if required) should be implemented on the consumer application level. It can be done via utilization of dedicated execution threads for long-time operations.
- **Full X.509 certificate support incl. OCSP and OCSP stabling**
[CryptoAPI](#) doesn't provide complete specification of the X.509 certificates man-

agement on the client (ECU) side yet. Current version of Crypto API specifies only minimal subset of interfaces responsible for basic X.509 functionality and related on utilization of cryptographic algorithms. Current API supports extraction and parsing of only basic attributes of X.509 certificates and certification requests. An extension of the API specification by additional interfaces dedicated for complete support of X.509 extensions is planned for the next release of this specification.

Note: Generally current specification of the X.509 Provider API is preliminary and subject for extensions and changes.

- **Formats of certificate objects**

Current version of [CryptoAPI](#) has minimal support of well-known cryptographic formats encoding/decoding: support of only DER and PEM encoding for X.509 certificates and certificate signing requests is required from any implementation of [CryptoAPI](#). For other cryptographic objects an implementation can support only "raw" formats. Following extension of the [CryptoAPI](#) by unified interfaces for encoding/decoding of complex objects to standard formats is planned for the next release of this specification.

4.4 Applicability to car domains

No restrictions to applicability.

5 Dependencies to other functional clusters

There is a dependency to IAM that concerns PEP and PDP. For details see [7.2.1](#).

5.1 Protocol layer dependencies

There are currently no dependencies to protocol layers.

6 Requirements Tracing

The following tables reference the requirements specified in [6] and [7] and links to the fulfillment of these. Please note that if column “Satisfied by” is empty for a specific requirement this means that this requirement is not fulfilled by this document.

Requirement	Description	Satisfied by
[RS_AP_00130]	AUTOSAR Adaptive Platform shall represent a rich and modern programming environment.	[SWS_CRYPT_19900]
[RS_AP_00144]	Availability of a named constructor.	[SWS_CRYPT_20745] [SWS_CRYPT_20746] [SWS_CRYPT_20747] [SWS_CRYPT_20748] [SWS_CRYPT_20750] [SWS_CRYPT_20751] [SWS_CRYPT_20752] [SWS_CRYPT_20753] [SWS_CRYPT_20754] [SWS_CRYPT_20755] [SWS_CRYPT_20756] [SWS_CRYPT_20757] [SWS_CRYPT_20758] [SWS_CRYPT_20760] [SWS_CRYPT_20761]
[RS_CRYPTO_-02001]	The Crypto Stack shall conceal symmetric keys from the users	[SWS_CRYPT_00007] [SWS_CRYPT_20733] [SWS_CRYPT_20762] [SWS_CRYPT_20763] [SWS_CRYPT_20764] [SWS_CRYPT_20765] [SWS_CRYPT_20810] [SWS_CRYPT_21010] [SWS_CRYPT_21313] [SWS_CRYPT_21413] [SWS_CRYPT_21525] [SWS_CRYPT_21815] [SWS_CRYPT_22118] [SWS_CRYPT_22211] [SWS_CRYPT_22913] [SWS_CRYPT_23211] [SWS_CRYPT_23515] [SWS_CRYPT_23623] [SWS_CRYPT_23710] [SWS_CRYPT_23800] [SWS_CRYPT_23911] [SWS_CRYPT_24018] [SWS_CRYPT_24115]

Requirement	Description	Satisfied by
[RS_CRYPTO_-02002]	The Crypto Stack shall conceal asymmetric private keys from the users	[SWS_CRYPT_00007] [SWS_CRYPT_10305] [SWS_CRYPT_20733] [SWS_CRYPT_20762] [SWS_CRYPT_20763] [SWS_CRYPT_20764] [SWS_CRYPT_20765] [SWS_CRYPT_22500]
[RS_CRYPTO_-02003]	The Crypto Stack shall support management of non-persistent session/ephemeral keys during their lifetime	[SWS_CRYPT_20512] [SWS_CRYPT_20721] [SWS_CRYPT_20722] [SWS_CRYPT_20810] [SWS_CRYPT_21010] [SWS_CRYPT_21313] [SWS_CRYPT_21413] [SWS_CRYPT_21525] [SWS_CRYPT_21815] [SWS_CRYPT_22118] [SWS_CRYPT_22211] [SWS_CRYPT_22913] [SWS_CRYPT_23211] [SWS_CRYPT_23515] [SWS_CRYPT_23623] [SWS_CRYPT_23710] [SWS_CRYPT_23911] [SWS_CRYPT_24018] [SWS_CRYPT_24115]
[RS_CRYPTO_-02004]	The Crypto Stack shall support secure storage of cryptographic artifacts	[SWS_CRYPT_00102] [SWS_CRYPT_00103] [SWS_CRYPT_04202] [SWS_CRYPT_04203] [SWS_CRYPT_04204] [SWS_CRYPT_04205] [SWS_CRYPT_04207] [SWS_CRYPT_04208] [SWS_CRYPT_04209] [SWS_CRYPT_10000] [SWS_CRYPT_10016] [SWS_CRYPT_10018] [SWS_CRYPT_10019] [SWS_CRYPT_10031] [SWS_CRYPT_10033] [SWS_CRYPT_10701] [SWS_CRYPT_10710] [SWS_CRYPT_10750] [SWS_CRYPT_10751] [SWS_CRYPT_10752] [SWS_CRYPT_10753] [SWS_CRYPT_10800] [SWS_CRYPT_10810] [SWS_CRYPT_10811]

Requirement	Description	Satisfied by
		[SWS_CRYPT_10818] [SWS_CRYPT_10821] [SWS_CRYPT_10822] [SWS_CRYPT_10823] [SWS_CRYPT_10850] [SWS_CRYPT_10851] [SWS_CRYPT_10852] [SWS_CRYPT_10853] [SWS_CRYPT_20517] [SWS_CRYPT_30010] [SWS_CRYPT_30011] [SWS_CRYPT_30101] [SWS_CRYPT_30110] [SWS_CRYPT_30115] [SWS_CRYPT_30123] [SWS_CRYPT_30124] [SWS_CRYPT_30125] [SWS_CRYPT_30126] [SWS_CRYPT_30200] [SWS_CRYPT_30201] [SWS_CRYPT_30202] [SWS_CRYPT_30203] [SWS_CRYPT_30204] [SWS_CRYPT_30205] [SWS_CRYPT_30206] [SWS_CRYPT_30207] [SWS_CRYPT_30209] [SWS_CRYPT_30210] [SWS_CRYPT_30211] [SWS_CRYPT_30212] [SWS_CRYPT_30213] [SWS_CRYPT_30214] [SWS_CRYPT_30215] [SWS_CRYPT_30216] [SWS_CRYPT_30217] [SWS_CRYPT_30218] [SWS_CRYPT_30219] [SWS_CRYPT_30220] [SWS_CRYPT_30221] [SWS_CRYPT_30222] [SWS_CRYPT_30223] [SWS_CRYPT_30224] [SWS_CRYPT_30225] [SWS_CRYPT_30226] [SWS_CRYPT_30227] [SWS_CRYPT_30404] [SWS_CRYPT_30406] [SWS_CRYPT_30408]

Requirement	Description	Satisfied by
		[SWS_CRYPT_30409] [SWS_CRYPT_40947] [SWS_CRYPT_40948] [SWS_CRYPT_40949] [SWS_CRYPT_40950] [SWS_CRYPT_40951] [SWS_CRYPT_40952] [SWS_CRYPT_40953] [SWS_CRYPT_40954] [SWS_CRYPT_40955] [SWS_CRYPT_40956] [SWS_CRYPT_40957] [SWS_CRYPT_40959]
[RS_CRYPTO_-02005]	The Crypto Stack shall support unique identification of cryptographic objects	[SWS_CRYPT_10100] [SWS_CRYPT_10150] [SWS_CRYPT_10151] [SWS_CRYPT_10152] [SWS_CRYPT_10153] [SWS_CRYPT_10154] [SWS_CRYPT_10155] [SWS_CRYPT_10306] [SWS_CRYPT_10400] [SWS_CRYPT_10411] [SWS_CRYPT_10412] [SWS_CRYPT_10413] [SWS_CRYPT_10808] [SWS_CRYPT_20500] [SWS_CRYPT_20501] [SWS_CRYPT_20502] [SWS_CRYPT_20503] [SWS_CRYPT_20504] [SWS_CRYPT_20505] [SWS_CRYPT_20506] [SWS_CRYPT_20507] [SWS_CRYPT_20513] [SWS_CRYPT_20514] [SWS_CRYPT_20515] [SWS_CRYPT_20518] [SWS_CRYPT_20600] [SWS_CRYPT_20641] [SWS_CRYPT_20643] [SWS_CRYPT_20644] [SWS_CRYPT_20703] [SWS_CRYPT_20724] [SWS_CRYPT_20725] [SWS_CRYPT_20726] [SWS_CRYPT_20727] [SWS_CRYPT_20733] [SWS_CRYPT_20760] [SWS_CRYPT_20761] [SWS_CRYPT_30500]

Requirement	Description	Satisfied by
[RS_CRYPTO_-02006]	The Crypto Stack shall support a version control mechanism and distinguish “versions” and “origin sources” of cryptographic objects	[SWS_CRYPT_04213] [SWS_CRYPT_10100] [SWS_CRYPT_10101] [SWS_CRYPT_10102] [SWS_CRYPT_10111] [SWS_CRYPT_10112] [SWS_CRYPT_10113] [SWS_CRYPT_10114] [SWS_CRYPT_10115] [SWS_CRYPT_20102] [SWS_CRYPT_20703] [SWS_CRYPT_20724] [SWS_CRYPT_20725] [SWS_CRYPT_20726] [SWS_CRYPT_20727] [SWS_CRYPT_20733] [SWS_CRYPT_20760] [SWS_CRYPT_20761] [SWS_CRYPT_20802] [SWS_CRYPT_21002] [SWS_CRYPT_21102] [SWS_CRYPT_21302] [SWS_CRYPT_21402] [SWS_CRYPT_21517] [SWS_CRYPT_21802] [SWS_CRYPT_22102] [SWS_CRYPT_22210] [SWS_CRYPT_22902] [SWS_CRYPT_23210] [SWS_CRYPT_23510] [SWS_CRYPT_23602] [SWS_CRYPT_23702] [SWS_CRYPT_24002] [SWS_CRYPT_24102] [SWS_CRYPT_40958]
[RS_CRYPTO_-02007]	The Crypto Stack shall provide means for secure handling of “secret seeds”	[SWS_CRYPT_00102] [SWS_CRYPT_10401] [SWS_CRYPT_20723] [SWS_CRYPT_21311] [SWS_CRYPT_21411] [SWS_CRYPT_21516] [SWS_CRYPT_21810] [SWS_CRYPT_23000] [SWS_CRYPT_23001] [SWS_CRYPT_23002] [SWS_CRYPT_23003] [SWS_CRYPT_23011] [SWS_CRYPT_23012] [SWS_CRYPT_23013] [SWS_CRYPT_23014] [SWS_CRYPT_23015] [SWS_CRYPT_23016] [SWS_CRYPT_24015]

Requirement	Description	Satisfied by
[RS_CRYPTO_-02008]	The Crypto Stack shall support restrictions of the allowed usage scope for keys and “secret seeds”	[SWS_CRYPT_10004] [SWS_CRYPT_10819] [SWS_CRYPT_20400] [SWS_CRYPT_20401] [SWS_CRYPT_20402] [SWS_CRYPT_20411] [SWS_CRYPT_21521] [SWS_CRYPT_24800] [SWS_CRYPT_24801] [SWS_CRYPT_24811] [SWS_CRYPT_29046]
[RS_CRYPTO_-02009]	The Crypto stack shall support separation of applications” access rights for each cryptographic object slot	[SWS_CRYPT_10003] [SWS_CRYPT_10004] [SWS_CRYPT_30208] [SWS_CRYPT_30300] [SWS_CRYPT_30405]
[RS_CRYPTO_-02101]	The Crypto Stack shall provide interfaces to generate cryptographic keys for all supported primitives	[SWS_CRYPT_00601] [SWS_CRYPT_00603] [SWS_CRYPT_00608] [SWS_CRYPT_00609] [SWS_CRYPT_00610] [SWS_CRYPT_00611] [SWS_CRYPT_00622] [SWS_CRYPT_03300] [SWS_CRYPT_03311] [SWS_CRYPT_10300] [SWS_CRYPT_10301] [SWS_CRYPT_10303] [SWS_CRYPT_10304] [SWS_CRYPT_20721] [SWS_CRYPT_20722] [SWS_CRYPT_40944] [SWS_CRYPT_40945] [SWS_CRYPT_40946] [SWS_CRYPT_40962] [SWS_CRYPT_40969]
[RS_CRYPTO_-02102]	The Crypto Stack shall prevent keys from being used in incompatible or insecure ways	[SWS_CRYPT_00102] [SWS_CRYPT_03312] [SWS_CRYPT_10014] [SWS_CRYPT_20721] [SWS_CRYPT_20722] [SWS_CRYPT_21412] [SWS_CRYPT_21512] [SWS_CRYPT_21513] [SWS_CRYPT_21515] [SWS_CRYPT_21523] [SWS_CRYPT_21813]

Requirement	Description	Satisfied by
[RS_CRYPTO_-02103]	The Crypto Stack shall support primitives to derive cryptographic key material from a base key material	[SWS_CRYPT_03313] [SWS_CRYPT_10402] [SWS_CRYPT_20748] [SWS_CRYPT_21500] [SWS_CRYPT_21501] [SWS_CRYPT_21519] [SWS_CRYPT_21520] [SWS_CRYPT_21522]
[RS_CRYPTO_-02104]	The Crypto Stack shall support a primitive to exchange cryptographic keys with another entity	[SWS_CRYPT_03301] [SWS_CRYPT_20743] [SWS_CRYPT_20752] [SWS_CRYPT_20753] [SWS_CRYPT_20758] [SWS_CRYPT_21300] [SWS_CRYPT_21301] [SWS_CRYPT_21400] [SWS_CRYPT_21401] [SWS_CRYPT_21800] [SWS_CRYPT_24000]
[RS_CRYPTO_-02105]	Symmetric keys and asymmetric private keys shall be imported and exported in a secure format.	[SWS_CRYPT_03302] [SWS_CRYPT_03303] [SWS_CRYPT_03304] [SWS_CRYPT_04200] [SWS_CRYPT_10403] [SWS_CRYPT_10700] [SWS_CRYPT_20728] [SWS_CRYPT_20729] [SWS_CRYPT_20730] [SWS_CRYPT_20731] [SWS_CRYPT_20732]
[RS_CRYPTO_-02106]	The Crypto Stack shall provide interfaces for secure processing of passwords	[SWS_CRYPT_10004]
[RS_CRYPTO_-02107]	The Crypto Stack shall support the algorithm specification in any key generation or derivation request	[SWS_CRYPT_01501] [SWS_CRYPT_01506] [SWS_CRYPT_01508] [SWS_CRYPT_01651] [SWS_CRYPT_02123] [SWS_CRYPT_10014] [SWS_CRYPT_13000] [SWS_CRYPT_13001] [SWS_CRYPT_13002] [SWS_CRYPT_13003] [SWS_CRYPT_20710] [SWS_CRYPT_20721] [SWS_CRYPT_20722] [SWS_CRYPT_21512] [SWS_CRYPT_21513] [SWS_CRYPT_21515] [SWS_CRYPT_21523] [SWS_CRYPT_40964]

Requirement	Description	Satisfied by
[RS_CRYPTO_-02108]	The Crypto Stack shall provide interfaces for management and usage of algorithm-specific domain parameters	[SWS_CRYPT_20414] [SWS_CRYPT_20721] [SWS_CRYPT_20722] [SWS_CRYPT_21314] [SWS_CRYPT_21412] [SWS_CRYPT_21414] [SWS_CRYPT_21512] [SWS_CRYPT_21513] [SWS_CRYPT_21515] [SWS_CRYPT_21523] [SWS_CRYPT_21524] [SWS_CRYPT_21813] [SWS_CRYPT_21816] [SWS_CRYPT_22120] [SWS_CRYPT_22212] [SWS_CRYPT_22511] [SWS_CRYPT_23212] [SWS_CRYPT_23516] [SWS_CRYPT_23627] [SWS_CRYPT_23712] [SWS_CRYPT_24019] [SWS_CRYPT_24116] [SWS_CRYPT_24414]
[RS_CRYPTO_-02109]	The Crypto Stack shall support interfaces for a unified Machine-wide storage and retrieval of different crypto objects	[SWS_CRYPT_10017] [SWS_CRYPT_10801] [SWS_CRYPT_10802] [SWS_CRYPT_10814] [SWS_CRYPT_10815] [SWS_CRYPT_10816] [SWS_CRYPT_10817] [SWS_CRYPT_20701] [SWS_CRYPT_30099] [SWS_CRYPT_30100]
[RS_CRYPTO_-02110]	The Crypto Stack shall support prototyping of application-exclusive key slot resources	[SWS_CRYPT_00101] [SWS_CRYPT_10812] [SWS_CRYPT_10813] [SWS_CRYPT_10818] [SWS_CRYPT_30300] [SWS_CRYPT_30301] [SWS_CRYPT_30302] [SWS_CRYPT_30305] [SWS_CRYPT_30306] [SWS_CRYPT_30307] [SWS_CRYPT_30308] [SWS_CRYPT_30309] [SWS_CRYPT_30310] [SWS_CRYPT_30311] [SWS_CRYPT_30312] [SWS_CRYPT_30313] [SWS_CRYPT_30350] [SWS_CRYPT_30351] [SWS_CRYPT_30407]

Requirement	Description	Satisfied by
[RS_CRYPTO_-02111]	The Crypto Stack shall provide applications a possibility to define usage restrictions of any new generated or derived key	[SWS_CRYPT_10015] [SWS_CRYPT_13100] [SWS_CRYPT_13101] [SWS_CRYPT_13102] [SWS_CRYPT_13103] [SWS_CRYPT_13104] [SWS_CRYPT_13105] [SWS_CRYPT_13106] [SWS_CRYPT_13107] [SWS_CRYPT_13108] [SWS_CRYPT_13109] [SWS_CRYPT_13110] [SWS_CRYPT_13111] [SWS_CRYPT_13112] [SWS_CRYPT_13113] [SWS_CRYPT_13114] [SWS_CRYPT_13115] [SWS_CRYPT_13116] [SWS_CRYPT_13117] [SWS_CRYPT_13118] [SWS_CRYPT_13119] [SWS_CRYPT_13120] [SWS_CRYPT_13121] [SWS_CRYPT_13122] [SWS_CRYPT_20721] [SWS_CRYPT_20722] [SWS_CRYPT_21512] [SWS_CRYPT_21513] [SWS_CRYPT_21515] [SWS_CRYPT_21523] [SWS_CRYPT_30500] [SWS_CRYPT_30501] [SWS_CRYPT_30503] [SWS_CRYPT_30505] [SWS_CRYPT_30506] [SWS_CRYPT_30508] [SWS_CRYPT_30510] [SWS_CRYPT_30511] [SWS_CRYPT_30550] [SWS_CRYPT_30551]

Requirement	Description	Satisfied by
[RS_CRYPTO_-02112]	The Crypto Stack shall execute export/import of a key value together with its meta information	[SWS_CRYPT_04200] [SWS_CRYPT_10200] [SWS_CRYPT_10451] [SWS_CRYPT_10452] [SWS_CRYPT_10453] [SWS_CRYPT_10454] [SWS_CRYPT_10455] [SWS_CRYPT_10456] [SWS_CRYPT_10711] [SWS_CRYPT_10712] [SWS_CRYPT_20005] [SWS_CRYPT_20728] [SWS_CRYPT_20729] [SWS_CRYPT_20730] [SWS_CRYPT_20731] [SWS_CRYPT_20732]
[RS_CRYPTO_-02113]	The Crypto Stack interfaces shall support control of the exportability property of a key object	[SWS_CRYPT_04200]
[RS_CRYPTO_-02115]	The Crypto Stack shall enforce assigning required domain parameters to a key in its generation or derivation procedure	[SWS_CRYPT_03305] [SWS_CRYPT_20721] [SWS_CRYPT_20722] [SWS_CRYPT_21312] [SWS_CRYPT_21315] [SWS_CRYPT_21412] [SWS_CRYPT_21515] [SWS_CRYPT_21523] [SWS_CRYPT_21813] [SWS_CRYPT_22511] [SWS_CRYPT_24016] [SWS_CRYPT_24017]
[RS_CRYPTO_-02116]	The Crypto Stack shall support version control of key objects kept in the Key Storage	[SWS_CRYPT_30300]

Requirement	Description	Satisfied by
[RS_CRYPTO_-02201]	The Crypto Stack shall provide interfaces to use symmetric encryption and decryption primitives	[SWS_CRYPT_01501] [SWS_CRYPT_01502] [SWS_CRYPT_01503] [SWS_CRYPT_01504] [SWS_CRYPT_01506] [SWS_CRYPT_01508] [SWS_CRYPT_01651] [SWS_CRYPT_01653] [SWS_CRYPT_01654] [SWS_CRYPT_01655] [SWS_CRYPT_01656] [SWS_CRYPT_01657] [SWS_CRYPT_01658] [SWS_CRYPT_01659] [SWS_CRYPT_01660] [SWS_CRYPT_01661] [SWS_CRYPT_01662] [SWS_CRYPT_02123] [SWS_CRYPT_10042] [SWS_CRYPT_20742] [SWS_CRYPT_20744] [SWS_CRYPT_23600] [SWS_CRYPT_23601] [SWS_CRYPT_23700] [SWS_CRYPT_23701] [SWS_CRYPT_23716] [SWS_CRYPT_23717] [SWS_CRYPT_23801] [SWS_CRYPT_23802] [SWS_CRYPT_24001] [SWS_CRYPT_24011] [SWS_CRYPT_24012] [SWS_CRYPT_24013] [SWS_CRYPT_24014] [SWS_CRYPT_40963] [SWS_CRYPT_40964]

Requirement	Description	Satisfied by
[RS_CRYPTO_-02202]	The Crypto Stack shall provide interfaces to use asymmetric encryption and decryption primitives	[SWS_CRYPT_02700] [SWS_CRYPT_02701] [SWS_CRYPT_02702] [SWS_CRYPT_02703] [SWS_CRYPT_02704] [SWS_CRYPT_02705] [SWS_CRYPT_02706] [SWS_CRYPT_02726] [SWS_CRYPT_10042] [SWS_CRYPT_20750] [SWS_CRYPT_20751] [SWS_CRYPT_20754] [SWS_CRYPT_20755] [SWS_CRYPT_20800] [SWS_CRYPT_20801] [SWS_CRYPT_20811] [SWS_CRYPT_20812] [SWS_CRYPT_20813] [SWS_CRYPT_21000] [SWS_CRYPT_21001] [SWS_CRYPT_21011] [SWS_CRYPT_21012] [SWS_CRYPT_21013] [SWS_CRYPT_22200] [SWS_CRYPT_22700] [SWS_CRYPT_22701] [SWS_CRYPT_22702] [SWS_CRYPT_22711] [SWS_CRYPT_22712] [SWS_CRYPT_22713] [SWS_CRYPT_23200] [SWS_CRYPT_23201] [SWS_CRYPT_23215] [SWS_CRYPT_23216] [SWS_CRYPT_40966]

Requirement	Description	Satisfied by
[RS_CRYPTO_-02203]	The Crypto Stack shall provide interfaces to use message authentication code primitives	[SWS_CRYPT_01200] [SWS_CRYPT_01201] [SWS_CRYPT_01202] [SWS_CRYPT_01203] [SWS_CRYPT_01204] [SWS_CRYPT_01207] [SWS_CRYPT_01208] [SWS_CRYPT_01209] [SWS_CRYPT_01210] [SWS_CRYPT_01211] [SWS_CRYPT_01213] [SWS_CRYPT_10042] [SWS_CRYPT_20319] [SWS_CRYPT_20746] [SWS_CRYPT_22100] [SWS_CRYPT_22101] [SWS_CRYPT_22115] [SWS_CRYPT_22116] [SWS_CRYPT_22117] [SWS_CRYPT_22119] [SWS_CRYPT_23300] [SWS_CRYPT_23301] [SWS_CRYPT_23302] [SWS_CRYPT_23311]
[RS_CRYPTO_-02204]	The Crypto Stack shall provide interfaces to use digital signature primitives	[SWS_CRYPT_00902] [SWS_CRYPT_02400] [SWS_CRYPT_02408] [SWS_CRYPT_02409] [SWS_CRYPT_02410] [SWS_CRYPT_02411] [SWS_CRYPT_02412] [SWS_CRYPT_02413] [SWS_CRYPT_02414] [SWS_CRYPT_02415] [SWS_CRYPT_02416] [SWS_CRYPT_02417] [SWS_CRYPT_02418] [SWS_CRYPT_02419] [SWS_CRYPT_02420] [SWS_CRYPT_02421] [SWS_CRYPT_02422] [SWS_CRYPT_10042] [SWS_CRYPT_20003] [SWS_CRYPT_20319] [SWS_CRYPT_20754] [SWS_CRYPT_20755] [SWS_CRYPT_20756] [SWS_CRYPT_20757]

Requirement	Description	Satisfied by
		[SWS_CRYPT_22119] [SWS_CRYPT_22200] [SWS_CRYPT_22201] [SWS_CRYPT_22215] [SWS_CRYPT_22216] [SWS_CRYPT_23200] [SWS_CRYPT_23201] [SWS_CRYPT_23300] [SWS_CRYPT_23301] [SWS_CRYPT_23302] [SWS_CRYPT_23311] [SWS_CRYPT_23500] [SWS_CRYPT_23501] [SWS_CRYPT_23511] [SWS_CRYPT_23512] [SWS_CRYPT_23513] [SWS_CRYPT_23514] [SWS_CRYPT_24100] [SWS_CRYPT_24101] [SWS_CRYPT_24111] [SWS_CRYPT_24112] [SWS_CRYPT_24113] [SWS_CRYPT_24114] [SWS_CRYPT_40961]
[RS_CRYPTO_-02205]	The Crypto Stack shall provide interfaces to use hashing primitives	[SWS_CRYPT_00901] [SWS_CRYPT_00903] [SWS_CRYPT_00905] [SWS_CRYPT_00906] [SWS_CRYPT_00907] [SWS_CRYPT_00908] [SWS_CRYPT_00909] [SWS_CRYPT_00910] [SWS_CRYPT_00919] [SWS_CRYPT_10042] [SWS_CRYPT_20747] [SWS_CRYPT_21100] [SWS_CRYPT_21101] [SWS_CRYPT_21115] [SWS_CRYPT_21116] [SWS_CRYPT_21117] [SWS_CRYPT_23300] [SWS_CRYPT_23301] [SWS_CRYPT_23302] [SWS_CRYPT_23311] [SWS_CRYPT_40960]

Requirement	Description	Satisfied by
[RS_CRYPTO_-02206]	The Crypto Stack shall provide interfaces to configure and use random number generation	[SWS_CRYPT_00500] [SWS_CRYPT_00501] [SWS_CRYPT_00502] [SWS_CRYPT_00503] [SWS_CRYPT_00504] [SWS_CRYPT_00505] [SWS_CRYPT_00506] [SWS_CRYPT_00507] [SWS_CRYPT_00508] [SWS_CRYPT_10042] [SWS_CRYPT_20741] [SWS_CRYPT_22900] [SWS_CRYPT_22901] [SWS_CRYPT_22911] [SWS_CRYPT_22912] [SWS_CRYPT_22914] [SWS_CRYPT_22915] [SWS_CRYPT_30098] [SWS_CRYPT_40983]
[RS_CRYPTO_-02207]	The Crypto Stack shall provide interfaces to use authenticated symmetric encryption and decryption primitives	[SWS_CRYPT_01800] [SWS_CRYPT_01801] [SWS_CRYPT_01802] [SWS_CRYPT_01803] [SWS_CRYPT_01804] [SWS_CRYPT_01805] [SWS_CRYPT_01806] [SWS_CRYPT_01807] [SWS_CRYPT_01808] [SWS_CRYPT_01811] [SWS_CRYPT_01820] [SWS_CRYPT_01821] [SWS_CRYPT_01822] [SWS_CRYPT_01823] [SWS_CRYPT_10042] [SWS_CRYPT_20100] [SWS_CRYPT_20101] [SWS_CRYPT_20316] [SWS_CRYPT_20745]
[RS_CRYPTO_-02208]	The Crypto Stack shall provide interfaces to use symmetric key wrapping primitives	[SWS_CRYPT_02104] [SWS_CRYPT_02105] [SWS_CRYPT_02106] [SWS_CRYPT_02107] [SWS_CRYPT_02108] [SWS_CRYPT_02109] [SWS_CRYPT_02121] [SWS_CRYPT_02122] [SWS_CRYPT_10042] [SWS_CRYPT_20743] [SWS_CRYPT_24000] [SWS_CRYPT_40965]

Requirement	Description	Satisfied by
[RS_CRYPTO_-02209]	The Crypto Stack shall provide interfaces to use asymmetric key encapsulation primitives	[SWS_CRYPT_03000] [SWS_CRYPT_03002] [SWS_CRYPT_03003] [SWS_CRYPT_03004] [SWS_CRYPT_03005] [SWS_CRYPT_03006] [SWS_CRYPT_03007] [SWS_CRYPT_03008] [SWS_CRYPT_03009] [SWS_CRYPT_10042] [SWS_CRYPT_20752] [SWS_CRYPT_20753] [SWS_CRYPT_21400] [SWS_CRYPT_21800] [SWS_CRYPT_21801] [SWS_CRYPT_40967] [SWS_CRYPT_40968]
[RS_CRYPTO_-02301]	The Crypto Stack API shall provide a standardized header files structure	[SWS_CRYPT_20099] [SWS_CRYPT_30099] [SWS_CRYPT_40099]
[RS_CRYPTO_-02302]	The Crypto Stack API shall support a streaming approach	[SWS_CRYPT_10701] [SWS_CRYPT_10710] [SWS_CRYPT_10750] [SWS_CRYPT_10751] [SWS_CRYPT_10752] [SWS_CRYPT_10753] [SWS_CRYPT_20312] [SWS_CRYPT_20313] [SWS_CRYPT_20314] [SWS_CRYPT_21110] [SWS_CRYPT_21111] [SWS_CRYPT_21112] [SWS_CRYPT_21113] [SWS_CRYPT_21114] [SWS_CRYPT_21115] [SWS_CRYPT_21118] [SWS_CRYPT_22110] [SWS_CRYPT_22111] [SWS_CRYPT_22112] [SWS_CRYPT_22113] [SWS_CRYPT_22114] [SWS_CRYPT_22115] [SWS_CRYPT_23614] [SWS_CRYPT_23615]

Requirement	Description	Satisfied by
		[SWS_CRYPT_23616] [SWS_CRYPT_23617] [SWS_CRYPT_23618] [SWS_CRYPT_23619] [SWS_CRYPT_23620] [SWS_CRYPT_23621] [SWS_CRYPT_23622] [SWS_CRYPT_23625] [SWS_CRYPT_23626] [SWS_CRYPT_23634] [SWS_CRYPT_23635] [SWS_CRYPT_23715] [SWS_CRYPT_24714] [SWS_CRYPT_24715]
[RS_CRYPTO_-02304]	The Crypto Stack API should support the possibility to move a state of a “counter mode” stream cipher to a random position	[SWS_CRYPT_23613]
[RS_CRYPTO_-02305]	The Crypto Stack design shall separate cryptographic API from key access API	[SWS_CRYPT_00004] [SWS_CRYPT_00006] [SWS_CRYPT_10000] [SWS_CRYPT_20700] [SWS_CRYPT_30100]
[RS_CRYPTO_-02306]	The Crypto Stack shall support integration with a Public Key Infrastructure (PKI)	[SWS_CRYPT_20001] [SWS_CRYPT_20002] [SWS_CRYPT_20003] [SWS_CRYPT_20004] [SWS_CRYPT_20005] [SWS_CRYPT_20006] [SWS_CRYPT_20007] [SWS_CRYPT_20009] [SWS_CRYPT_20010] [SWS_CRYPT_20011] [SWS_CRYPT_20301] [SWS_CRYPT_20302] [SWS_CRYPT_20303] [SWS_CRYPT_20304] [SWS_CRYPT_20601] [SWS_CRYPT_20602] [SWS_CRYPT_20603] [SWS_CRYPT_20611] [SWS_CRYPT_20612] [SWS_CRYPT_20613] [SWS_CRYPT_20614] [SWS_CRYPT_20615] [SWS_CRYPT_20616] [SWS_CRYPT_20617]

Requirement	Description	Satisfied by
		[SWS_CRYPT_20618] [SWS_CRYPT_20619] [SWS_CRYPT_20901] [SWS_CRYPT_20902] [SWS_CRYPT_20903] [SWS_CRYPT_20904] [SWS_CRYPT_20905] [SWS_CRYPT_20906] [SWS_CRYPT_20907] [SWS_CRYPT_20908] [SWS_CRYPT_20909] [SWS_CRYPT_20910] [SWS_CRYPT_22501] [SWS_CRYPT_22503] [SWS_CRYPT_24414] [SWS_CRYPT_24415] [SWS_CRYPT_40001] [SWS_CRYPT_40002] [SWS_CRYPT_40099] [SWS_CRYPT_40100] [SWS_CRYPT_40101] [SWS_CRYPT_40111] [SWS_CRYPT_40112] [SWS_CRYPT_40113] [SWS_CRYPT_40114] [SWS_CRYPT_40115] [SWS_CRYPT_40150] [SWS_CRYPT_40151] [SWS_CRYPT_40152] [SWS_CRYPT_40153] [SWS_CRYPT_40154] [SWS_CRYPT_40155] [SWS_CRYPT_40156] [SWS_CRYPT_40157] [SWS_CRYPT_40158] [SWS_CRYPT_40159] [SWS_CRYPT_40200] [SWS_CRYPT_40201] [SWS_CRYPT_40202] [SWS_CRYPT_40203] [SWS_CRYPT_40211] [SWS_CRYPT_40212] [SWS_CRYPT_40213] [SWS_CRYPT_40214] [SWS_CRYPT_40215] [SWS_CRYPT_40216] [SWS_CRYPT_40217] [SWS_CRYPT_40218]

Requirement	Description	Satisfied by
		[SWS_CRYPT_40219] [SWS_CRYPT_40220] [SWS_CRYPT_40221] [SWS_CRYPT_40300] [SWS_CRYPT_40301] [SWS_CRYPT_40302] [SWS_CRYPT_40311] [SWS_CRYPT_40313] [SWS_CRYPT_40314] [SWS_CRYPT_40315] [SWS_CRYPT_40400] [SWS_CRYPT_40401] [SWS_CRYPT_40402] [SWS_CRYPT_40403] [SWS_CRYPT_40411] [SWS_CRYPT_40412] [SWS_CRYPT_40413] [SWS_CRYPT_40414] [SWS_CRYPT_40415] [SWS_CRYPT_40416] [SWS_CRYPT_40417] [SWS_CRYPT_40418] [SWS_CRYPT_40500] [SWS_CRYPT_40501] [SWS_CRYPT_40511] [SWS_CRYPT_40600] [SWS_CRYPT_40601] [SWS_CRYPT_40602] [SWS_CRYPT_40603] [SWS_CRYPT_40604] [SWS_CRYPT_40611] [SWS_CRYPT_40612] [SWS_CRYPT_40613] [SWS_CRYPT_40614] [SWS_CRYPT_40615] [SWS_CRYPT_40616] [SWS_CRYPT_40617] [SWS_CRYPT_40618] [SWS_CRYPT_40619] [SWS_CRYPT_40620] [SWS_CRYPT_40621] [SWS_CRYPT_40622] [SWS_CRYPT_40624] [SWS_CRYPT_40625] [SWS_CRYPT_40626] [SWS_CRYPT_40627] [SWS_CRYPT_40628] [SWS_CRYPT_40629]

Requirement	Description	Satisfied by
		[SWS_CRYPT_40630] [SWS_CRYPT_40631] [SWS_CRYPT_40632] [SWS_CRYPT_40633] [SWS_CRYPT_40634] [SWS_CRYPT_40635] [SWS_CRYPT_40636] [SWS_CRYPT_40637] [SWS_CRYPT_40638] [SWS_CRYPT_40639] [SWS_CRYPT_40640] [SWS_CRYPT_40641] [SWS_CRYPT_40700] [SWS_CRYPT_40701] [SWS_CRYPT_40702] [SWS_CRYPT_40711] [SWS_CRYPT_40800] [SWS_CRYPT_40801] [SWS_CRYPT_40802] [SWS_CRYPT_40811] [SWS_CRYPT_40900] [SWS_CRYPT_40912] [SWS_CRYPT_40913] [SWS_CRYPT_40914] [SWS_CRYPT_40915] [SWS_CRYPT_40916] [SWS_CRYPT_40917] [SWS_CRYPT_40918] [SWS_CRYPT_40919] [SWS_CRYPT_40920] [SWS_CRYPT_40921] [SWS_CRYPT_40922] [SWS_CRYPT_40923] [SWS_CRYPT_40924] [SWS_CRYPT_40925] [SWS_CRYPT_40926] [SWS_CRYPT_40927] [SWS_CRYPT_40928] [SWS_CRYPT_40929] [SWS_CRYPT_40930] [SWS_CRYPT_40931] [SWS_CRYPT_40932] [SWS_CRYPT_40933] [SWS_CRYPT_40934] [SWS_CRYPT_40935] [SWS_CRYPT_40936] [SWS_CRYPT_40937] [SWS_CRYPT_40938]

Requirement	Description	Satisfied by
		[SWS_CRYPT_40939] [SWS_CRYPT_40940] [SWS_CRYPT_40941] [SWS_CRYPT_40942] [SWS_CRYPT_40943] [SWS_CRYPT_40972] [SWS_CRYPT_40973] [SWS_CRYPT_40974] [SWS_CRYPT_40975] [SWS_CRYPT_40976] [SWS_CRYPT_40977] [SWS_CRYPT_40978] [SWS_CRYPT_40979] [SWS_CRYPT_40980] [SWS_CRYPT_40981]
[RS_CRYPTO_-02307]	The Crypto Stack design shall separate cryptographic API from the PKI API	[SWS_CRYPT_20000] [SWS_CRYPT_20700] [SWS_CRYPT_24400] [SWS_CRYPT_24401] [SWS_CRYPT_24410]
[RS_CRYPTO_-02308]	The Crypto Stack shall support a unified cryptographic primitives naming convention, common for all suppliers	[SWS_CRYPT_03904] [SWS_CRYPT_03905] [SWS_CRYPT_03906] [SWS_CRYPT_03910] [SWS_CRYPT_20651] [SWS_CRYPT_20711] [SWS_CRYPT_20712] [SWS_CRYPT_40970] [SWS_CRYPT_40971]
[RS_CRYPTO_-02309]	The Crypto Stack API shall support the run-time configurable usage style	[SWS_CRYPT_20103] [SWS_CRYPT_20412] [SWS_CRYPT_20516] [SWS_CRYPT_20652] [SWS_CRYPT_21415] [SWS_CRYPT_21416] [SWS_CRYPT_21514] [SWS_CRYPT_21715] [SWS_CRYPT_21817] [SWS_CRYPT_21818] [SWS_CRYPT_22213] [SWS_CRYPT_22214] [SWS_CRYPT_23213] [SWS_CRYPT_23214] [SWS_CRYPT_23312] [SWS_CRYPT_23611] [SWS_CRYPT_23612] [SWS_CRYPT_23624] [SWS_CRYPT_23711] [SWS_CRYPT_23712] [SWS_CRYPT_24411] [SWS_CRYPT_24412] [SWS_CRYPT_24413] [SWS_CRYPT_29000]

Requirement	Description	Satisfied by
		[SWS_CRYPT_29001] [SWS_CRYPT_29002] [SWS_CRYPT_29003] [SWS_CRYPT_29004] [SWS_CRYPT_29010] [SWS_CRYPT_29011] [SWS_CRYPT_29012] [SWS_CRYPT_29013] [SWS_CRYPT_29014] [SWS_CRYPT_29015] [SWS_CRYPT_29020] [SWS_CRYPT_29021] [SWS_CRYPT_29022] [SWS_CRYPT_29023] [SWS_CRYPT_29024] [SWS_CRYPT_29030] [SWS_CRYPT_29031] [SWS_CRYPT_29032] [SWS_CRYPT_29033] [SWS_CRYPT_29034] [SWS_CRYPT_29035] [SWS_CRYPT_29040] [SWS_CRYPT_29041] [SWS_CRYPT_29042] [SWS_CRYPT_29043] [SWS_CRYPT_29044] [SWS_CRYPT_29045] [SWS_CRYPT_29047] [SWS_CRYPT_29048] [SWS_CRYPT_29049] [SWS_CRYPT_40984] [SWS_CRYPT_40985]
[RS_CRYPTO_-02310]	The Crypto Stack API shall support an efficient mechanism of error states notification	[SWS_CRYPT_00104] [SWS_CRYPT_10099] [SWS_CRYPT_19902] [SWS_CRYPT_19903] [SWS_CRYPT_19904] [SWS_CRYPT_19905] [SWS_CRYPT_19906] [SWS_CRYPT_19950] [SWS_CRYPT_19951] [SWS_CRYPT_19953] [SWS_CRYPT_19954]

Requirement	Description	Satisfied by
[RS_CRYPTO_-02401]	The Crypto Stack should support a joint usage of multiple back-end cryptography providers including ones with non-extractable keys	[SWS_CRYPT_00005] [SWS_CRYPT_00006] [SWS_CRYPT_00009] [SWS_CRYPT_10017] [SWS_CRYPT_20098] [SWS_CRYPT_20099] [SWS_CRYPT_20654] [SWS_CRYPT_20700] [SWS_CRYPT_30001] [SWS_CRYPT_30002] [SWS_CRYPT_30003] [SWS_CRYPT_30099] [SWS_CRYPT_30100] [SWS_CRYPT_30130] [SWS_CRYPT_30131] [SWS_CRYPT_30403] [SWS_CRYPT_40911]
[RS_CRYPTO_-02403]	The Crypto Stack shall support isolating keys and requests	[SWS_CRYPT_22500] [SWS_CRYPT_23800] [SWS_CRYPT_24802]
[RS_CRYPTO_-02405]	The Crypto Stack shall support the key slots identification in a way independent from a concrete deployment	[SWS_CRYPT_10005] [SWS_CRYPT_30400] [SWS_CRYPT_30401] [SWS_CRYPT_30402]

7 Functional specification

The AUTOSAR Adaptive architecture organizes the software of the AUTOSAR Adaptive foundation as [Functional Clusters](#). These clusters offer common functionality as services to the applications. The [Functional Cluster Cryptography \(FC Crypto\)](#) is part of the AUTOSAR Adaptive Platform Foundation.

The [FC Crypto](#) provides the infrastructure to access multiple implementations of cryptographic operations through a standardized interface, [CryptoAPI](#). Operations provided by [FC Crypto](#) are grouped into different *providers*, each of them implements specific domain of cryptography-related functionality:

- [Crypto Provider](#)
- [Key Storage Provider](#)
- [X.509 Certificate Management Provider](#)

This specification includes the syntax of the [API](#), the relationship of the [API](#) to the model and describes semantics.

7.1 Functional Cluster Lifecycle

7.1.1 Startup

Using `ara::core::Intitalize` and `ara::core::Deinitialize`, the application can initialize and deinitialize [FC Crypto](#) resources allocated to the application.

[SWS_CRYPT_00101]{DRAFT} [When `ara::core::Intitalize` is called, the [FC Crypto](#) shall read in the manifest information and prepare the access structures to [CryptoProvider](#) and [CryptoKeySlot](#) that are defined in the manifest.

] ([RS_CRYPTO_02110](#))

Hint: Access structures may encompass the communication channel between the application process and the stack process or other resource required by the [CryptoAPI](#).

7.1.2 Shutdown

[SWS_CRYPT_00102]{DRAFT} [When `ara::core::Deinitialize` is called, the [FC Crypto](#) shall ensure that all open contexts are closed and all occupied resources are freed.] ([RS_CRYPTO_02004](#), [RS_CRYPTO_02007](#), [RS_CRYPTO_02102](#))

`ara::crypto::cryp::CryptoObject::CryptoObject`, `ara::crypto::cryp::CryptoContext`

[SWS_CRYPT_00103]{DRAFT} [When `ara::core::Deinitialize` is called, the [FC Crypto](#) shall ensure that all associated persist operations in this context of this

application are executed successfully and no new persist operations are started.]([RS_CRYPT_02004](#))

Note: the application is expected not to call any API of `FC Crypto` before `ara::core::Initialize` or after `ara::core::Deinitialize`.

[SWS_CRYPT_00104]{DRAFT} [All functions of `FC Crypto` and all methods of its classes shall return the error `kUnknownIdentifier` when they are called after static initialization but before `ara::core::Initialize` was called or after `ara::core::Deinitialize` was called.]([RS_CRYPT_02310](#))

7.2 Architectural concepts

The `FC Crypto` offers applications and other Adaptive AUTOSAR `Functional Clusters` a standardized interface, which provides operations for cryptographic and related calculations. These operations include cryptographic operations, key management and certificate handling. `FC Crypto` handles the actual implementation of all operations, including all necessary configuration and brokering of operations between requesting-application and `FC Crypto`-provided implementation. The standardized interface is exposed by the `CryptoAPI`.

The `FC Crypto` and its `CryptoAPI` support both public-key and symmetric-key cryptography. It allows applications to use mechanisms such as authentication, encryption and decryption for automotive services.

The interfaces defined by `FC Crypto` are designed to enable integraton of 3rd party cryptographic libraries and hardware-based elements. This facilitates implementation of a security "trust anchor" or acceleration of cryptographic transformations in situations, where the `FC Crypto`'s default crypto-library will not provide the necessary primitives or hardware acceleration is needed.

`CryptoAPI` provides a set of methods, which enable application and system developer to store and transmit information while safeguarding it from intruders. `CryptoAPI` provides cryptographic methods to keep critical information in confidential and / or authentic form, and to communicate in a way such that only the intended recipient can read the message. Therefore, `FC Crypto` provides mechanisms for building applications that ensure the following security goals:

- **Authentication:** `FC Crypto` provides mechanisms that allow `Adaptive Applications` or `Functional Clusters` to prove their identity to other applications or `Functional Clusters`.
- **Non-Repudiation:** `FC Crypto` supports the concept of non-repudiation, where someone cannot deny the validity of something.
- **Confidentiality:** `FC Crypto` allows to keep information private. Cryptographic systems were originally developed to function in this capacity. Whether it be system or user specific data sent during system debugging or tracing, or storing

confidential vehicle / ECU data, encryption can assure that only users who have access to the appropriate key will get read access to the data [Plaintext](#).

- Integrity: [FC Crypto](#) ensures that secured data is not altered during storage or transmission without the receiver detecting this altering. Additionally, [FC Crypto](#) allows applications to build functionality, which guarantees the integrity of elements or services.

The [FC Crypto](#) shall take care not to leak any information about the message it has read from a stream, until the decryption process has finished without error.

Additionally, the [FC Crypto](#) integrates a [Key Storage Provider](#). The purpose of this element is secure persistent storage of any supported cryptographic objects and programmatic access to them via a unified interface, independently from actual physical storage implementations. A single logical Key Storage can aggregate multiple software or hardware-based physical storage managed by the correspondent [Crypto Providers](#). This is done transparent for the user of the Key Storage interface. Guaranteeing correct access to the keys, [CryptoAPI](#) restricts access to this material.

[CryptoAPI](#) allows to manage [PKI](#) certificates. These interfaces are grouped in a certificate management namespace. Here, all typical certificate handling mechanism, such as issuing, revocation, and replacement, are handled. Additionally, certificate management [API](#) provides a kind of permanent storage where all certificates are stored. All operations on certificates are done by certificate management, which enforces access permissions by implementing the [Policy Enforcement Point](#).

The definition and implementation of [FC Crypto](#) shall be implemented according to its parts as described above. The architectural overview shows all parts, such as [X.509 Provider](#) for certificate handling, [Crypto Provider](#) and [Key Storage Provider](#). Figure 7.1 depicts the high-level architecture of [FC Crypto](#) including the previously described elements.

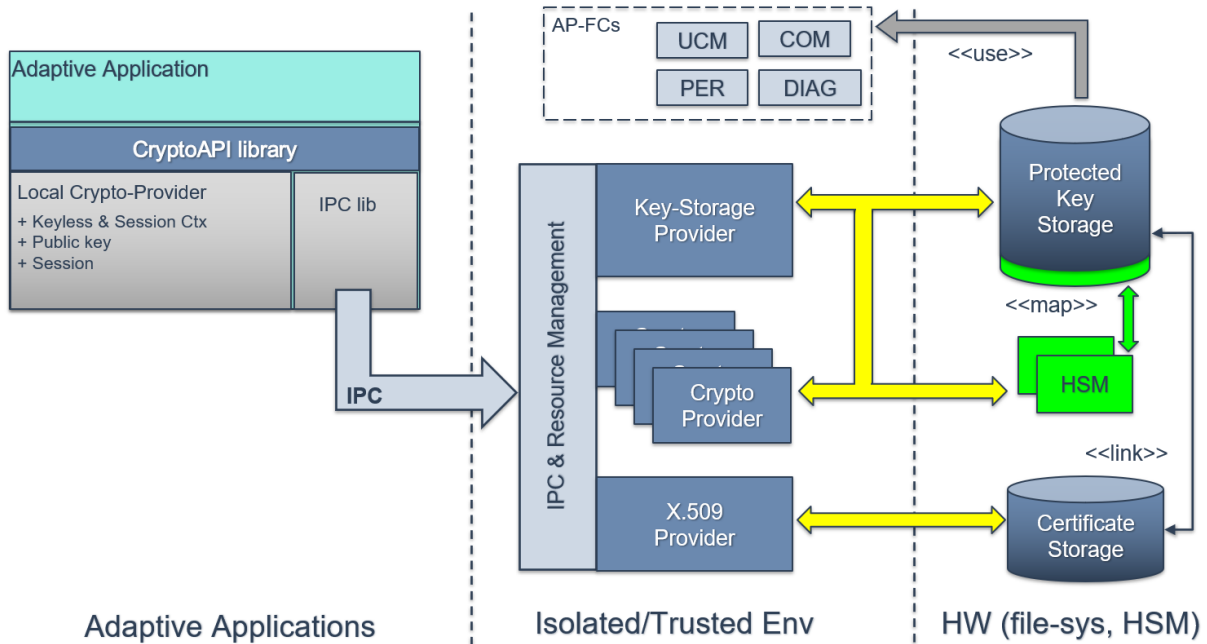

Figure 7.1: High-level CryptoAPI architecture

7.2.1 Integration with Identity and Access Management

To enable access control the FC Crypto shall implement a Policy Enforcement Point (PEP) to enforce the policy decision obtained from the Policy Decision Point (PDP) as specified by Identity and Access Management (IAM). Thus, an interaction is needed between FC Crypto (PEP) and some entity that implements the PDP.

Since only key- and certificate-slots are subject to access control it makes sense to embed the PEP within the Key Storage Provider and the X.509 Provider. One possible implementation is illustrated in figure 7.2: a PDP interface (IAM unit) obtains policy information and decides whether access is granted; this decision is enforced by a PEP functional unit. Both units may be implemented as part of the Key Storage Provider.

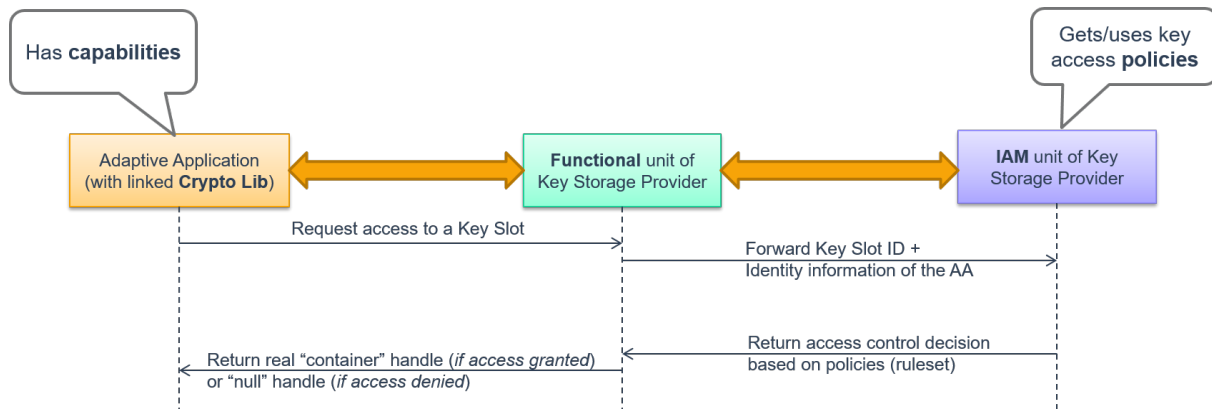

Figure 7.2: Interaction with IAM

IAM enables access control to modeled entities or resources. Currently, [FC Crypto](#) considers access control only for two types of resources: [Key Slot](#) (read/write) and [Certificate Slot](#) (write). To simplify IAM configuration [FC Crypto](#) specifies the exclusive-access-model, which states that access to a key-slot can only be granted to a single [Adaptive Application](#) (exclusive).

Clarification: key-slots and certificate-slots are non-volatile in nature, i.e. there is no use case for allocating volatile key-slot or certificate-slot instances.

Note: [Functional Cluster](#) access to a [Key Slot](#) assigned under exclusive-access to an [Adaptive Application](#) is not ruled out by this model (see sub-chapter [7.2.2](#))!

To enable and synchronize concurrent update and usage of the same key-slot, the [Key Storage Provider](#) specifies dedicated interfaces and mechanisms, which are subject to access control based on the addressed [Key Slot](#). Figure [7.3](#) showcases this scenario: the [Adaptive Application](#) has exclusive-access to a [Key Slot](#), which is used by a library providing cryptographic services to a higher layer (business logic). At the same time another library independently manages [Key Slot](#) content (e.g. crypto-keys).

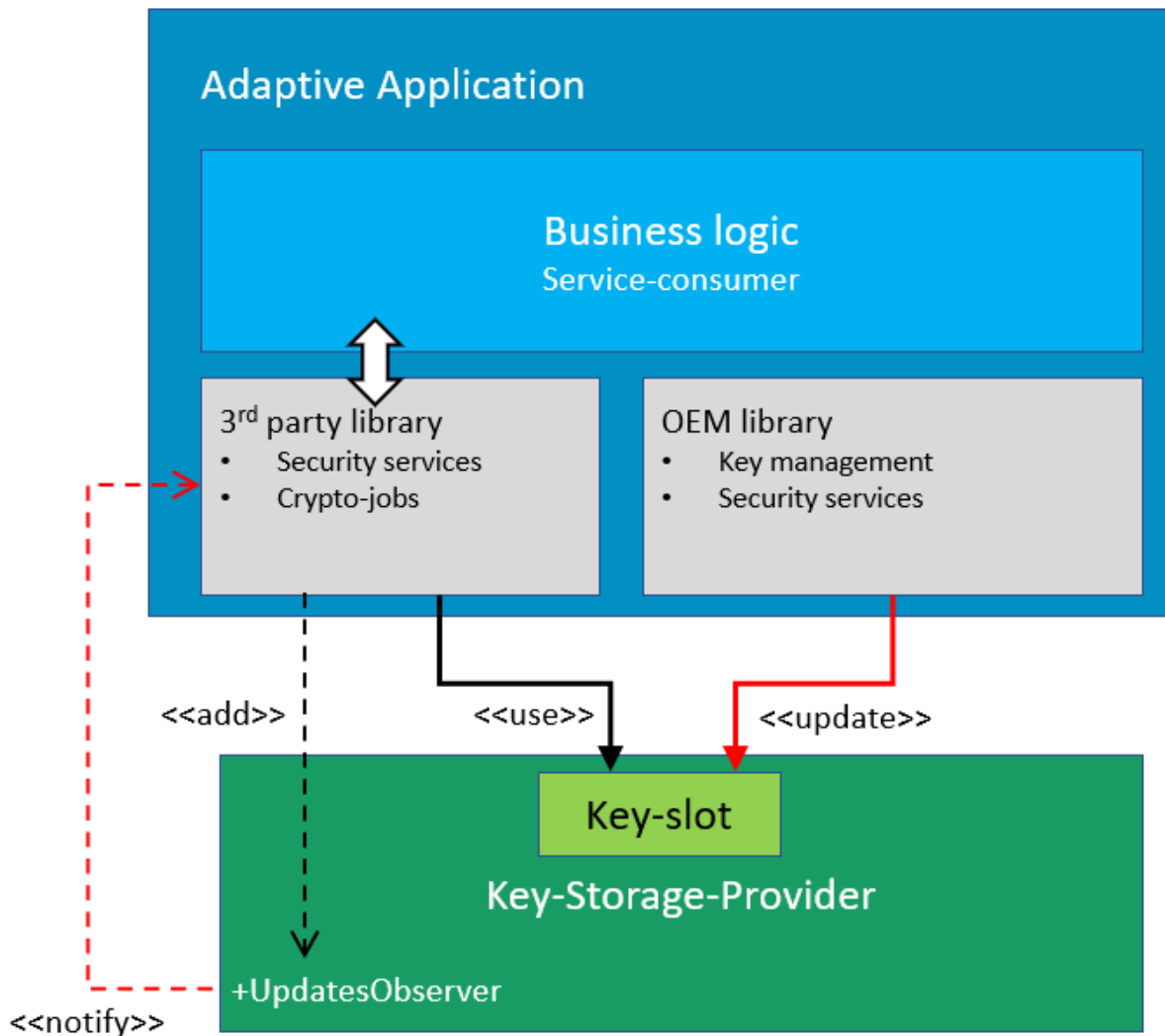

Figure 7.3: Concurrent access to a single Key Slot

The required [Key Slots](#) are described in the manifest of the application. This information is stored by [IAM](#), e.g. in a database.

7.2.2 Integration into AUTOSAR

The overall architecture is described in chapter [7.2](#). The [FC Crypto](#) provides its service to all AUTOSAR elements, such as untrusted [Adaptive Applications](#) or trusted system services ([Functional Clusters](#)). From cryptographic service point of view both could be treated equally.

The integration of FC Crypto into AUTOSAR is described in Figure 7.4.

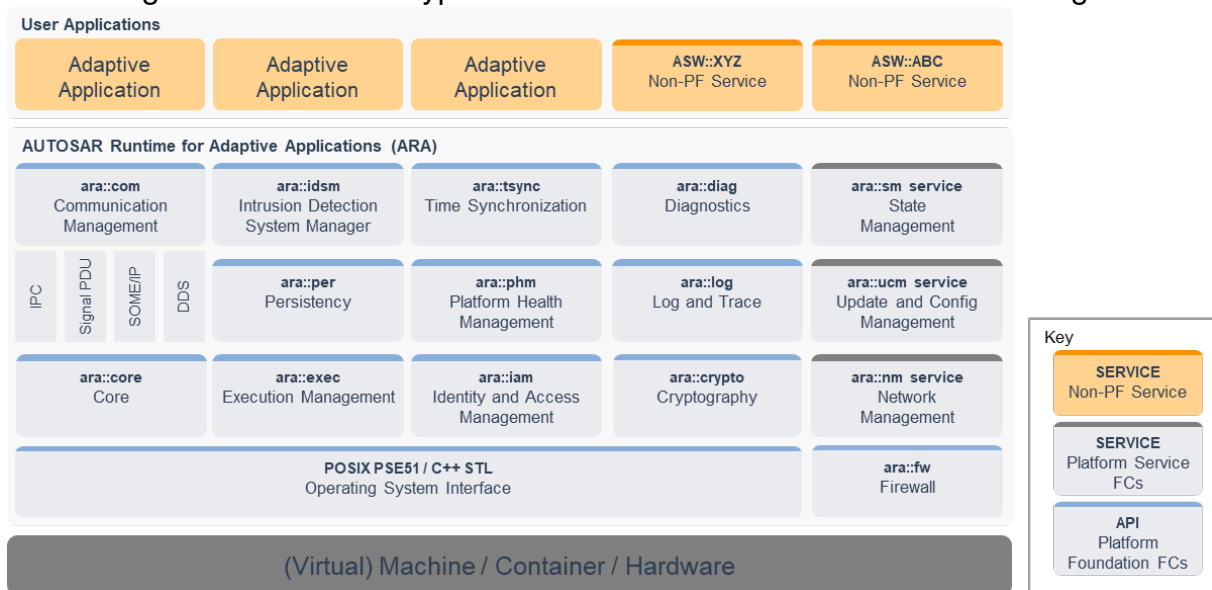

Figure 7.4: Integration into AUTOSAR

Their differential treatment is due to the underlying trust-model: system services ([Functional Clusters](#)) are the trusted foundation while [Adaptive Applications](#) are untrusted additions. To ensure secure access from application side the trust-model, in the form of IAM, is designed for and applied only to [Adaptive Applications](#). Similarly, the exclusive-access-model aims at protecting an application's own resources against access by other applications, but additionally also against access by [Functional Clusters](#) other than [FC Crypto](#). On the other hand some [Functional Clusters](#) specify their own key-slots, which contain key-material to be used when implementing certain system services (e.g. secure data storage, secure diagnostics or secure communication such as SecOC). Because key-management of [Key Slots](#) used by [Functional Clusters](#) should be possible from an [Adaptive Application](#) (e.g. OEM key manager), the exclusive-access-model defines two types of [Key Slots](#):

- **application:** the application has exclusive access to this key slot. It is able to import/export, update/delete and use the contained key-material. No other application or [Functional Cluster](#) may access this [Key Slot](#).
- **machine:** this type of [Key Slot](#) is defined by the adaptive machine and may be used by the [Functional Cluster](#) for which it is configured. Additionally, the [Key Slot](#) may be assigned to a single [Adaptive Application](#) that is then able to manage the contained key-material.

Figure 7.5 gives an example for the use of machine and application [Key Slots](#).

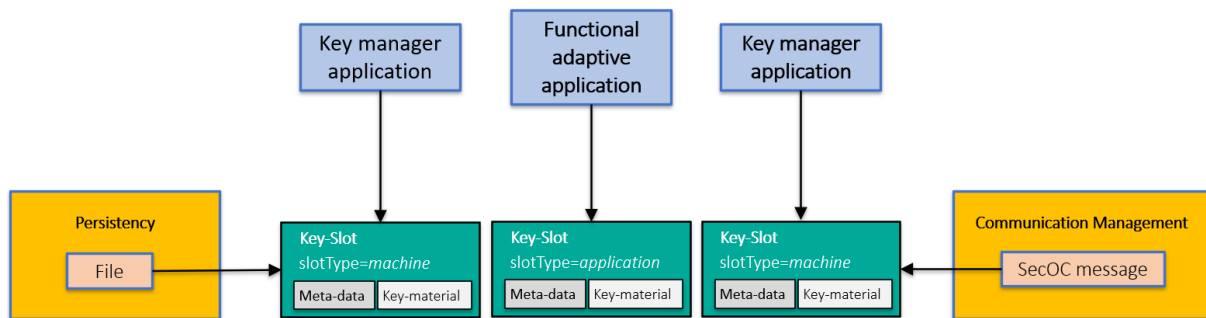

Figure 7.5: Key Slot types and usages

7.2.3 Application level

The `FC Crypto` has been primarily designed to enable `Adaptive Applications` to access cryptographic services, for a majority of which cryptographic key-material is needed. Therefore, an application may define the required `Key Slots`, `Crypto Providers` and certificates. These information are represented in the design model. The `CryptoKeySlotInterface` describes the needed `Key Material` for an application.

When a specified `Key Slot` is of slotType `application`, the application expects **exclusive** access to this key-slot. During Integration a key-slot resource must be allocated on the machine.

When an `Adaptive Application` specifies a `Key Slot` of slotType `machine`, it expresses a wish to **manage** a platform `Key Slot` with the configured properties. Note: the attribute `cryptoKeyName` of `CryptoKeySlotInterface` is used to match platform `Key Slots` and application-manifest specified `machine Key Slots`.

An `Adaptive Application` that uses a `Crypto Provider` without keys (e.g. Hashing, Random Number Generation) or only session keys may use the `CryptoProviderInterface`. Additionally, if the application requires certificates, this can be configured using the `CryptoCertificateInterface`. Figure 7.6 shows the model elements that are used to configure access from an `Adaptive Application` to elements of `FC Crypto`.

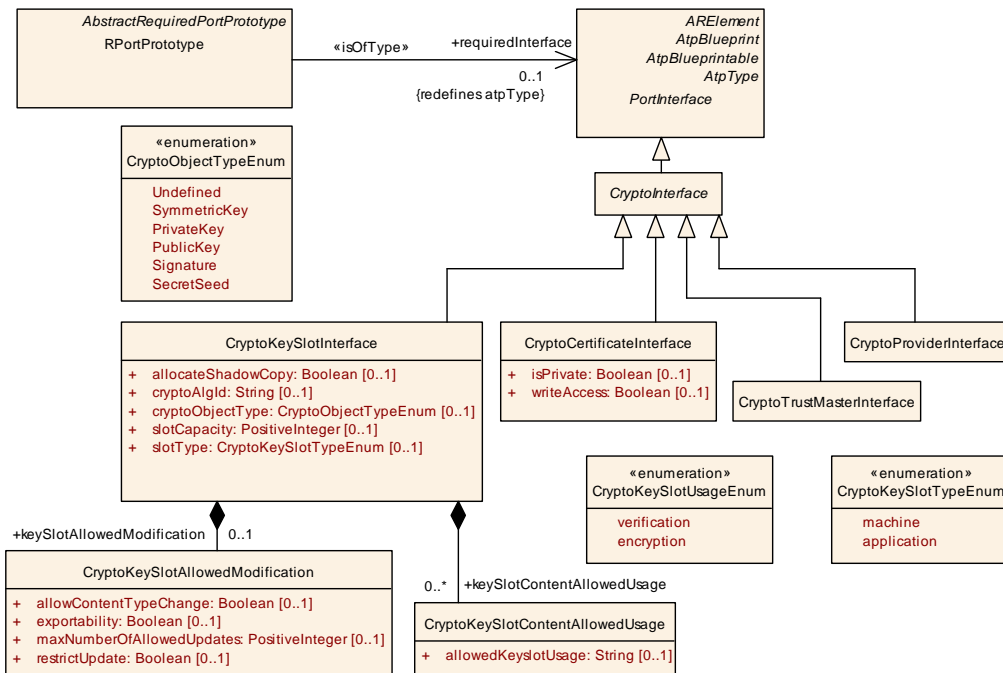

Figure 7.6: Application interface

7.2.4 System service level

Some [Adaptive Platform Services](#) such as update and configuration, communication, persistency or diagnostics also require cryptographic services as part of their functionality. If key-material is needed and must be configurable by an [Adaptive Application](#) (e.g. OEM key manager), the platform shall specify a [Key Slot](#) of slotType *machine*. To manage the [Key Material](#) a dedicated [Adaptive Application](#) (key-manager) may specify the same [Key Slot](#) (i.e. same parameters and slotType *machine*). During Integration this machine type key-slot resource must be linked to the key-manager.

7.2.5 Bridging domains: the IOInterface

One major design decision of [FC Crypto](#) is to separate to the extent possible the three domains dealing with cryptography (crypto::crypt), key management (crypto::keys) and certificate management (crypto::x509). To simplify interaction between domains and abstract interfaces from the actual object the IOInterface interface has been introduced as an intermediate layer between the persistent resource and the runtime object. The IOInterface represents a smart wrapper providing access to and meta-data on the content it is encapsulating. For example, it can be used by an application to instantiate a runtime crypto-object from its persistent storage location (read-access). Or it can be used by an application to store a runtime crypto-object into a persistent storage location (write-access).

7.3 Crypto API structure

`CryptoAPI` provided by `FC Crypto` to consumers is presented by three different Provider types, each of them implements specific domain of cryptography-related functionality:

1. **Crypto Provider** (CP, namespace `ara::crypto::cryp`) is responsible for implementation of all supported `Cryptographic primitives`. `FC Crypto` may support multiple instances of the `Crypto Providers`. Each instance of `Crypto Provider` represents single holistic software- or hardware-based implementation of some set of cryptographic algorithms. Each `Crypto Provider` must isolate all `Key Material` used during processing from unauthorized access from "external world".
2. **Key Storage Provider** (`KSP`, namespace `ara::crypto::keys`) is responsible for secure (confidential and/or authentic) storage of different type `Key Material` (public/private/secret keys, seeds) and other security critical cryptographic objects (digital signatures, hash, `MAC/HMAC` tags). `CryptoAPI` consumers work with logically single `KSP` that is used for access to all crypto objects independently from their physical hosting on the `ECU`. But from the stack supplier point of view, each `HSM` may support own back-end `KSP` responsible for access control to internally stored cryptographic objects. All back-end `KSP` are hidden from the consumers (under public `CryptoAPI`). `KSP` implementation (similar to `Crypto Provider`) must ensure confidentiality and authenticity of processed and stored objects, i.e. its implementation must be isolated from the consumers' code space.
3. **X.509 Certificate Management Provider** (CMP, namespace `ara::crypto::x509`) is responsible for `X.509` certificates parsing, verification, authentic storage and local searching by different attributes. Also CMP is responsible for storage, management and processing of Certificate Revocation Lists (`CRLs`) and Delta `CRLs`. CMP supports of requests preparation and responses parsing for On-line Certificate Status Protocol (`OCSP`). `FC Crypto` supports only single instance of the CMP and it is completely independent from `Crypto Provider` and `KSP` implementation details, therefore CMP and `Crypto Provider/KSP` may be provided by completely independent suppliers.
Note: CMP works with non-confidential objects only.

Note: Public `APIs` of each Provider type is common for consumers code and components suppliers. It is a mandatory part of API. But `Crypto Provider` and back-end `KSP` from single supplier may use internal "private" `APIs` for intercommunication. Also `FC Crypto` may specify additional "protected" `APIs` expected from specific provider type.

7.4 Crypto API elements

7.4.1 Crypto Provider

A `Crypto Provider` is a structural element that organizes `Cryptographic primitives`. Every `Crypto Provider` represents exactly either one hardware element, e.g., trusted platform module (TPM) or hardware security module (HSM), or one software element, e.g., cryptographic library. As a general rule, the stack vendor is expected to provide at least one `Crypto Provider` for each hardware and/or software element that is available in a project specific environment.

[SWS_CRYPT_00004]{DRAFT} [Each derived implementation of the interface class `ara::crypto::crypt::CryptoProvider` shall encapsulate cryptographic transformations and associated resources, such as `ara::crypto::crypt::CryptoObject` and `Cryptographic primitives`, of a single software or hardware cryptography implementation.]([RS_CRYPT_02305](#))

Note: a `Crypto Provider` may expose only a subset of all available transformations or primitives of the underlying software or hardware cryptography implementation (e.g. in case of weak or outdated primitives). However, this implementation detail shall be documented and communicated to the user.

[SWS_CRYPT_00005]{DRAFT} [The global factory method `ara::crypto::LoadCryptoProvider` shall instantiate a `ara::crypto::crypt::CryptoProvider` identified by the provided `ara::core::InstanceSpecifier`.]([RS_CRYPT_02401](#))

[SWS_CRYPT_00006]{DRAFT} [Each instance of a `Crypto Provider` shall implement one coherent representation of either software based cryptographic algorithms, i.e. library, or hardware based cryptographic algorithms, e.g., `HSM`.]([RS_CRYPT_02305](#), [RS_CRYPT_02401](#))

[SWS_CRYPT_00007]{DRAFT} [Derived implementations of the interface class `ara::crypto::crypt::CryptoProvider` shall isolate all non-session `Key Material` from the user (`Adaptive Application`).]([RS_CRYPT_02001](#), [RS_CRYPT_02002](#))

[SWS_CRYPT_00009]{DRAFT} [The `ara::crypto::crypt::CryptoProvider` shall be identified during runtime via call to `ara::crypto::LoadCryptoProvider` with `ara::core::InstanceSpecifier` as an input parameter. Here `ara::core::InstanceSpecifier` represents a path to `RPortPrototype` mapped to referenced `ara::crypto::crypt::CryptoProvider`.]([RS_CRYPT_02401](#))

[SWS_CRYPT_00500]{DRAFT} [The interface `ara::crypto::crypt::CryptoProvider::CreateRandomGeneratorCtx` shall return an instance of `ara::crypto::crypt::RandomGeneratorCtx` implementing the algorithm specified by the provided parameter `ara::crypto::CryptoAlgId`. The instantiated `ara::crypto::crypt::RandomGeneratorCtx` shall only be seeded, if a local-state

`ara::crypto::cryp::RandomGeneratorCtx` shall be created and the optional boolean parameter `initialize` is not provided or set to `TRUE`. The interface shall return

- `kUnknownIdentifier`, if the provided `ara::crypto::CryptoAlgId` is not supported or equals `kAlgIdDefault` but the `ara::crypto::cryp::CryptoProvider` does not support random number generation.
- `kBusyResource`, if seeding is requested but cannot be provided.
- `kInvalidArgument`, if the provided `ara::crypto::CryptoAlgId` is supported but does not refer to random number generation.

]([RS_CRYPT_02206](#))

While this enables applications to create a ready-to-go `RandomGeneratorCtx`, it cannot be guaranteed that seeding of the `RandomGeneratorCtx` is possible at this point in time, e.g., due to a lack of entropy. As applications shall be prevented from modifying the state of global-state `RandomGeneratorCtx`, applications shall also not be able to trigger the seeding of any global-state `RandomGeneratorCtx`.

[SWS_CRYPT_00506]{DRAFT} [If `ara::crypto::cryp::CryptoProvider::CreateRandomGeneratorCtx` is called to create a global-state `ara::crypto::cryp::RandomGeneratorCtx`, the optional boolean parameter `initialize` shall be ignored and the requested `RandomGeneratorCtx` shall be returned without modification of its state.]([RS_CRYPT_02206](#))

[SWS_CRYPT_00601]{DRAFT} [The interface `ara::crypto::cryp::CryptoProvider::CreateKeyDerivationFunctionCtx` shall return an instance of `ara::crypto::cryp::KeyDerivationFunctionCtx` implementing the algorithm specified by the provided parameter `ara::crypto::CryptoAlgId`. The interface shall return

- `kUnknownIdentifier`, if the provided `ara::crypto::CryptoAlgId` is not supported.
- `kInvalidArgument`, if the provided `ara::crypto::CryptoAlgId` is supported but does not refer to key derivation.

]([RS_CRYPT_02101](#))

This context needs an identifier to specify the used cryptographic algorithm. This identifier is encoded with the common name as defined in chapter 7.5. This context will also be used in different areas to derive keys, such as Key Agreement or Key Encapsulation.

[SWS_CRYPT_00901]{DRAFT} [The interface `ara::crypto::cryp::CryptoProvider::CreateHashFunctionCtx` shall return an instance of `ara::crypto::cryp::HashFunctionCtx` implementing the algorithm specified by the provided parameter `ara::crypto::CryptoAlgId`. The interface shall return

- `kUnknownIdentifier`, if the provided `ara::crypto::CryptoAlgId` is not supported.

- `kInvalidArgument`, if the provided `ara::crypto::CryptoAlgId` is supported but does not refer to hashing.

](RS_CRYPT_02205)

The `ara::crypto::CryptoAlgId` identifier represents the common name as defined in chapter 7.5.

[SWS_CRYPT_40960]{DRAFT} [The interface `ara::crypto::cryp::CryptoProvider::CreateHashDigest` shall return an instance of `ara::crypto::cryp::Signature` initialized according to the provided `ara::crypto::CryptoAlgId` and hash data (`ara::crypto::ReadOnlyMemRegion` value). The interface shall only support `ara::crypto::CryptoAlgIds` of hash primitives and return

- `kUnknownIdentifier`, if the provided `ara::crypto::CryptoAlgId` is not supported.
- `kInvalidArgument`, if the provided `ara::crypto::CryptoAlgId` is supported but does not refer to hashing.
- `kInvalidInputSize`, if the size of hash data provided is not compatible with the provided `ara::crypto::CryptoAlgId`.

](RS_CRYPT_02205)

[SWS_CRYPT_01200]{DRAFT} [The interface `ara::crypto::cryp::CryptoProvider::CreateMessageAuthnCodeCtx` shall return an instance of `ara::crypto::cryp::MessageAuthnCodeCtx` implementing the algorithm specified by the provided parameter `ara::crypto::CryptoAlgId`.

- `kUnknownIdentifier`, if the provided `ara::crypto::CryptoAlgId` is not supported.
- `kInvalidArgument`, if the provided `ara::crypto::CryptoAlgId` is supported but does not refer to `Message Authentication Code` generation or verification.

](RS_CRYPT_02203)

[SWS_CRYPT_40963]{DRAFT} [The interface `ara::crypto::cryp::CryptoProvider::CreateSymmetricBlockCipherCtx` shall return an instance of `ara::crypto::cryp::SymmetricBlockCipherCtx` implementing the algorithm specified by the provided parameter `ara::crypto::CryptoAlgId`. The interface shall return

- `kUnknownIdentifier`, if the provided `ara::crypto::CryptoAlgId` is not supported.
- `kInvalidArgument`, if the provided `ara::crypto::CryptoAlgId` is supported but does not refer to symmetric `Block Cipher` en/decryption.

](RS_CRYPT_02201)

[SWS_CRYPT_40964]{DRAFT} [The interface `ara::crypto::cryp::CryptoProvider::CreateStreamCipherCtx` shall return an instance of `ara::crypto::cryp::StreamCipherCtx` implementing the algorithm specified by the provided parameter `ara::crypto::CryptoAlgId`. The interface shall return

- `kUnknownIdentifier`, if the provided `ara::crypto::CryptoAlgId` is not supported.
- `kInvalidArgument`, if the provided `ara::crypto::CryptoAlgId` is supported but does not refer to symmetric `Stream Cipher` en/decryption

]([RS_CRYPT_02107](#), [RS_CRYPT_02201](#))

[SWS_CRYPT_01806]{DRAFT} [The interface `ara::crypto::cryp::CryptoProvider::CreateAuthCipherCtx` shall return an instance of `ara::crypto::cryp::AuthCipherCtx` implementing the algorithm specified by the provided parameter `ara::crypto::CryptoAlgId`. The interface shall return

- `kUnknownIdentifier`, if the provided `ara::crypto::CryptoAlgId` is not supported.
- `kInvalidArgument`, if the provided `ara::crypto::CryptoAlgId` is supported but does not refer to authenticated encryption/decryption.

]([RS_CRYPT_02207](#))

[SWS_CRYPT_40965]{DRAFT} [The interface `ara::crypto::cryp::CryptoProvider::CreateSymmetricKeyWrapperCtx` shall return an instance of `ara::crypto::cryp::SymmetricKeyWrapperCtx` implementing the algorithm specified by the provided parameter `ara::crypto::CryptoAlgId`. The interface shall return

- `kUnknownIdentifier`, if the provided `ara::crypto::CryptoAlgId` is not supported.
- `kInvalidArgument`, if the provided `ara::crypto::CryptoAlgId` is supported but does not refer to symmetric key-wrapping.

]([RS_CRYPT_02208](#))

[SWS_CRYPT_02400]{DRAFT} [The interface `ara::crypto::cryp::CryptoProvider::CreateVerifierPublicCtx` shall return an instance of `ara::crypto::cryp::VerifierPublicCtx` implementing the algorithm specified by the provided parameter `ara::crypto::CryptoAlgId`.

- `kUnknownIdentifier`, if the provided `ara::crypto::CryptoAlgId` is not supported.
- `kInvalidArgument`, if the provided `ara::crypto::CryptoAlgId` is supported but does not refer to signature verification.

]([RS_CRYPT_02204](#))

[SWS_CRYPT_02408]{DRAFT} [The interface `ara::crypto::cryp::CryptoProvider::CreateSignerPrivateCtx` shall return an instance of `ara::crypto::cryp::SignerPrivateCtx` implementing the primitive specified by the provided algorithm `ara::crypto::CryptoAlgId`. The interface shall return

- `kUnknownIdentifier`, if the provided `ara::crypto::CryptoAlgId` is not supported.
- `kInvalidArgument`, if the provided `ara::crypto::CryptoAlgId` is supported but does not refer to signature generation..

]([RS_CRYPT_02204](#))

[SWS_CRYPT_02409]{DRAFT} [The interface `ara::crypto::cryp::CryptoProvider::CreateSigEncodePrivateCtx` shall return an instance of `ara::crypto::cryp::SigEncodePrivateCtx` implementing the algorithm specified by the provided parameter `ara::crypto::CryptoAlgId`. The interface shall return

- `kUnknownIdentifier`, if the provided `ara::crypto::CryptoAlgId` is not supported.
- `kInvalidArgument`, if the provided `ara::crypto::CryptoAlgId` is supported but does not refer signature generation with message encoding.

]([RS_CRYPT_02204](#))

[SWS_CRYPT_02410]{DRAFT} [The interface `ara::crypto::cryp::CryptoProvider::CreateMsgRecoveryPublicCtx` shall return an instance of `ara::crypto::cryp::MsgRecoveryPublicCtx` implementing the algorithm specified by the provided parameter `ara::crypto::CryptoAlgId`. The interface shall return

- `kUnknownIdentifier`, if the provided `ara::crypto::CryptoAlgId` is not supported.
- `kInvalidArgument`, if the provided `ara::crypto::CryptoAlgId` is supported but does not refer to signature verification with message recovery.

]([RS_CRYPT_02204](#))

[SWS_CRYPT_40966]{DRAFT} [The interface `ara::crypto::cryp::CryptoProvider::CreateEncryptorPublicCtx` shall return an instance of `ara::crypto::cryp::EncryptorPublicCtx` implementing the algorithm specified by the provided parameter `ara::crypto::CryptoAlgId`. The interface shall return

- `kUnknownIdentifier`, if the provided `ara::crypto::CryptoAlgId` is not supported.
- `kInvalidArgument`, if the provided `ara::crypto::CryptoAlgId` is supported but does not refer but does not refer to assymmetric encryption.

]([RS_CRYPT_02202](#))

[SWS_CRYPT_40967]{DRAFT} [The interface `ara::crypto::cryp::CryptoProvider::CreateKeyEncapsulatorPublicCtx` shall return an instance of `ara::crypto::cryp::KeyEncapsulatorPublicCtx` implementing the algorithm specified by the provided parameter `ara::crypto::CryptoAlgId`. The interface shall return

- `kUnknownIdentifier`, if the provided `ara::crypto::CryptoAlgId` is not supported.
- `kInvalidArgument`, if the provided `ara::crypto::CryptoAlgId` is supported but does not refer to key encapsulation.

]([RS_CRYPT_02209](#))

[SWS_CRYPT_40968]{DRAFT} [The interface `ara::crypto::cryp::CryptoProvider::CreateKeyDecapsulatorPrivateCtx` shall return an instance of `ara::crypto::cryp::KeyDecapsulatorPrivateCtx` implementing the algorithm specified by the provided parameter `ara::crypto::CryptoAlgId`. The interface shall return

- `kUnknownIdentifier`, if the provided `ara::crypto::CryptoAlgId` is not supported.
- `kInvalidArgument`, if the provided `ara::crypto::CryptoAlgId` is supported but does not refer to key decapsulation.

]([RS_CRYPT_02209](#))

[SWS_CRYPT_40961]{DRAFT} [The interface `ara::crypto::cryp::CryptoProvider::CreateSignature` shall return an instance of `ara::crypto::cryp::Signature` initialized according to the provided primary `ara::crypto::CryptoAlgId`, authentication tag (`ara::crypto::ReadOnlyMemRegion` value), the provided `ara::crypto::cryp::RestrictedUseObject` key and optionally a secondary `ara::crypto::CryptoAlgId` of the hash function used with the primary digital signature algorithm. The interface shall only support primary `ara::crypto::CryptoAlgIds` of digital signature and `Message Authentication Code` primitives and return

- `kUnknownIdentifier`, if the provided `ara::crypto::CryptoAlgId` is not supported.
- `kInvalidArgument`, if the provided `CryptoAlgIds` are supported but do not refer to digital signature or `Message Authentication Code` primitives.
- `kInvalidInputSize`, if the size of the authentication tag provided is not compatible with the provided primary `ara::crypto::CryptoAlgId`.
- `kIncompatibleArguments`, if the primary and secondary `ara::crypto::CryptoAlgIds` are incompatible or if the `ara::crypto::CryptoAlgId` of the provided `ara::crypto::cryp::RestrictedUseObject` is incompatible with either the primary and secondary `ara::crypto::CryptoAlgId`.

](RS_CRYPT_02204)

[SWS_CRYPT_40962]{DRAFT} [The interfaces `ara::crypto::cryp::CryptoProvider::GeneratePrivateKey`, `ara::crypto::cryp::CryptoProvider::GenerateSeed` and `ara::crypto::cryp::CryptoProvider::GenerateSymmetricKey` shall generate secret key-material according to the provided `ara::crypto::CryptoAlgId` return an instance of `ara::crypto::cryp::PrivateKey`, `ara::crypto::cryp::SecretSeed` or `ara::crypto::cryp::SymmetricKey` respectively. Each function shall initialize the object according to the provided `ara::crypto::AllowedUsageFlags` and boolean attributes `isSession` and `isExportable`, e.g. as `isSession` or `isExportable`. The interface shall return

- `kUnknownIdentifier`, if the provided `ara::crypto::CryptoAlgId` is not supported.
- `kInvalidArgument`, if the provided `ara::crypto::CryptoAlgId` is supported but does not refer to primitive that the interfaces shall generate.

](RS_CRYPT_02101)

[SWS_CRYPT_40969]{DRAFT} [The interface `ara::crypto::cryp::CryptoProvider::CreateKeyAgreementPrivateCtx` shall return an instance of `ara::crypto::cryp::KeyAgreementPrivateCtx` implementing the algorithm specified by the provided parameter `ara::crypto::CryptoAlgId`. The interface shall return

- `kUnknownIdentifier`, if the provided `ara::crypto::CryptoAlgId` is not supported.
- `kInvalidArgument`, if the provided `ara::crypto::CryptoAlgId` is supported but does not refer to key agreement.

](RS_CRYPT_02101)

[SWS_CRYPT_40970]{DRAFT} Translation of common name to vendor identifier [The interface `ara::crypto::cryp::CryptoProvider::ConvertToAlgId` shall convert the provided primitive name from its string representation according to NamingConvention into a vendor specific `ara::crypto::CryptoAlgId`. The interface shall return `kAlgIdUndefined`, if the provided primitive name is not supported.]
(RS_CRYPT_02308)

[SWS_CRYPT_40971]{DRAFT} Translation of identifier to name [The `ara::crypto::cryp::CryptoProvider::ConvertToAlgName` shall convert a vendor specific algorithm identifier to the common name of the cryptographic algorithm.

The interface `ara::crypto::cryp::CryptoProvider::ConvertToAlgName` shall convert the provided vendor specific `ara::crypto::CryptoAlgId` into a primitive name according to NamingConvention. The interface shall return a `ara::core::StringView` of the converted primitive name or `kUnknownIdentifier`, if the provided `ara::crypto::CryptoAlgId` is not supported.] (RS_CRYPT_02308)

Note: generation of strong key-material is the foundation that underpins all security properties of further cryptographic transformations or protocols. It is the stack vendor's responsibility to ensure strong key-material is generated. The user of the above mentioned generate interfaces provides additional restrictions of how the generated key-material may be used, e.g. restricting usage of a [Symmetric Key](#) only to message authentication, forbidding the key-material to be exported or to be persistently stored (session keys).

The `ara::crypto::CryptoAlgId` is the implementation specific identifier that represents the algorithm name, as described in chapter [NamingConvention](#). With this identifier the context is setup matching the requested algorithm. Here, the setup can influence the organization of the cryptographic material, the provided internal buffers for keys, input, or output data and the buffers length. Some cryptographic algorithms need specific initialization parameters. All the specific needs of an algorithm are specified by the corresponding standards, and provide details on how to internally setup the [Crypto Provider](#) and its supported [Cryptographic primitives](#).

7.4.1.1 Random Number Generator (RNG)

Generating randomness or pseudo randomness is required for many operations such as creating [Salts](#) or [Nonces](#). In order to enable applications to perform these operations, [CryptoAPI](#) provides an interface to generate random data.

Randomness can be generated by True [Random Number Generators](#) (TRNGs) or by Cryptographically Secure Pseudo [Random Number Generators](#) (CSPRNGs). CSPRNGs hold an internal state that needs to be securely seeded with sufficient entropy. This entropy is used to generate a deterministic but unpredictable stream of random data. More information on the desired properties of CSPRNGs can be found in [8, BSIDRNG: Functionality Classes and Evaluation Methodology for Deterministic [Random Number Generators](#)].

[SWS_CRYPT_00501]{DRAFT} [If a [Crypto Provider](#) provides one or more random generator implementations, one random generator implementation shall be documented as the default and a corresponding `RandomGeneratorCtx` shall be returned when `ara::crypto::crypt::CryptoProvider::CreateRandomGeneratorCtx` is called with `algId == kAlgIdDefault`.

If a [Crypto Provider](#) provides one or more [RNG](#) implementations, one [RNG](#) implementation shall be documented as the default. If `ara::crypto::crypt::CryptoProvider::CreateRandomGeneratorCtx` is called with the `algId` parameter equal to `kAlgIdDefault`, it shall return the default [RNG](#) implementation context.] ([RS_CRYPTO_02206](#))

The definition of the default [RNG](#) and its implementation is not specified in this document.

Each `ara::crypto::crypt::RandomGeneratorCtx` may either rely on state local to the `ara::crypto::crypt::RandomGeneratorCtx` instance only, or may rely

on global state shared among different `ara::crypto::cryp::RandomGeneratorCtx`'s instances. In order to prevent malicious applications from being able to predict random data generated for other processes, it is important to ensure that applications must not modify the global state of any `ara::crypto::cryp::RandomGeneratorCtx`.

[SWS_CRYPT_00502]{DRAFT} [If a `ara::crypto::cryp::RandomGeneratorCtx` uses global state or local state without support for user-provided seed/entropy, calls to its methods `ara::crypto::cryp::RandomGeneratorCtx::Seed`, `ara::crypto::cryp::RandomGeneratorCtx::SetKey` and `ara::crypto::cryp::RandomGeneratorCtx::AddEntropy` shall return false without modifying the global state or local state.](*RS_CRYPT_02206*)

[SWS_CRYPT_00503]{DRAFT} [If `ara::crypto::cryp::RandomGeneratorCtx::Seed`, and `ara::crypto::cryp::RandomGeneratorCtx::SetKey` shall return false without modifying the state, if they are called with a `SymmetricKey` or a `ara::crypto::cryp::SecretSeed` without the allowed usage flag `kAllowRngInit`.](*RS_CRYPT_02206*)

How global-state `ara::crypto::cryp::RandomGeneratorCtxs` are seeded is stack-vendor and/or project specific and out of scope of this specification. Local-state `ara::crypto::cryp::RandomGeneratorCtx`'s may be seeded by `FC Crypto`.

[SWS_CRYPT_00504]{DRAFT} [If `ara::crypto::cryp::CryptoProvider::CreateRandomGeneratorCtx` is called to create a local-state `ara::crypto::cryp::RandomGeneratorCtx` with `initialize` set to true, the internal state of the created `ara::crypto::cryp::RandomGeneratorCtx` shall be seeded by `FC Crypto` before returning.](*RS_CRYPT_02206*)

While this enables applications to create a ready-to-go `ara::crypto::cryp::RandomGeneratorCtx`, it cannot be guaranteed that seeding of the `ara::crypto::cryp::RandomGeneratorCtx` is possible at this point in time, e.g., due to a lack of entropy.

[SWS_CRYPT_00505]{DRAFT} [If `ara::crypto::cryp::CryptoProvider::CreateRandomGeneratorCtx` is called to create a local-state `ara::crypto::cryp::RandomGeneratorCtx` with `initialize` set to true but the context currently cannot be seeded, `ara::crypto::cryp::CryptoProvider::CreateRandomGeneratorCtx` shall return `kBusyResource`.](*RS_CRYPT_02206*)

As applications shall be prevented from modifying the state of global-state `ara::crypto::cryp::RandomGeneratorCtx`, applications shall also not be able to trigger the seeding of any global-state `ara::crypto::cryp::RandomGeneratorCtx`.

A `ara::crypto::cryp::RandomGeneratorCtx` may have insufficient entropy to serve a request for random data, e.g., because it has not been seeded or because it ran out of entropy. In these cases, `ara::crypto::cryp::RandomGeneratorCtx::Generate` shall return errors.

[SWS_CRYPT_00507]{DRAFT} [If a call to `ara::crypto::cryp::RandomGeneratorCtx::Generate` of a global-state `ara::crypto::cryp::RandomGeneratorCtx` cannot be served with the requested number of random bytes, `kBusyResource` shall be returned.

](RS_CRYPT_02206)

[SWS_CRYPT_00508]{DRAFT} [If a call to `ara::crypto::cryp::RandomGeneratorCtx::Generate` of a local-state `ara::crypto::cryp::RandomGeneratorCtx` cannot be served with the requested number of random bytes, `kUninitializedContext` shall be returned.](RS_CRYPT_02206)

These errors represent the possible handling of the error by applications: For a global-state `ara::crypto::cryp::RandomGeneratorCtx` the application has to wait, whereas for a local-state `ara::crypto::cryp::RandomGeneratorCtx` the application has to provide additional entropy.

[SWS_CRYPT_40983]{DRAFT} [The function `ara::crypto::GenerateRandomData` shall return random data generated from the default random data source of FC Crypto or `kBusyResource` if the requested number of random bytes cannot be provided.](RS_CRYPT_02206)

7.4.1.2 Key Derivation Function (KDF)

According to [9], [10], [11], and [12] the Key Derivation Function (KDF) shall prevent that an attacker, when a derived key was obtained, will gather information about the master secret value or other derived keys. It is also important to strengthen the derived key to prevent an attacker to guess or to brute force the derived key. Therefore, good keys are derived by adding a `Salt`, which avoids dictionary attacks, and a number of iterations, which increase the guessing delay.

[SWS_CRYPT_00603]{DRAFT} **Symmetric encryption based KDF** [Beside the usage of hashes, the FC Crypto shall allow to parametrize symmetric encryption algorithms as the used key derivation function. This is done by the algorithm identifier as well.](RS_CRYPT_02101)

[SWS_CRYPT_00608]{DRAFT} [The interface `ara::crypto::cryp::KeyDerivationFunctionCtx::AddSalt` shall add a `Salt` value stored in the provided non-secret `ReadOnlyMemRegion` for subsequent key derivation

- `ara::crypto::cryp::KeyDerivationFunctionCtx::AddSalt` shall return a `kInvalidInputSize` error, if the size of the provided `Salt` is not supported by the `ara::crypto::CryptoAlgId` used to instantiate this context.

](RS_CRYPT_02101)

The CryptoAPI provides the `ara::crypto::cryp::KeyDerivationFunctionCtx::AddSalt` interface in the KDF context. Deriving the key is done by the given target symmetric algorithm identifier, which also defines a length of derived key.

[SWS_CRYPT_00609]{DRAFT} [The interface `ara::crypto::cryp::KeyDerivationFunctionCtx::AddSecretSalt` shall add a secret `Salt` value stored in the provided `ara::crypto::cryp::SecretSeed` for subsequent key derivation

- `ara::crypto::cryp::KeyDerivationFunctionCtx::AddSecretSalt` shall return a `kInvalidInputSize` error, if the size of the provided secret `Salt` is not supported by the `ara::crypto::CryptoAlgId` used to instantiate this context.

]([RS_CRYPT_02101](#))

[SWS_CRYPT_00610]{DRAFT} [The interface `ara::crypto::cryp::KeyDerivationFunctionCtx::ConfigIterations` shall configure the number of iterations for subsequent key derivation. If the provided number of iterations is smaller or larger than the implementation of this interface supports, the interface shall return the actual number of iterations applied otherwise the interface shall return the provided number of iterations.]([RS_CRYPT_02101](#))

The stack vendor may restrict the maximum number of iterations to avoid overloading the system. The stack vendor may enforce a minimum number of iterations needed to derive a secure key.

[SWS_CRYPT_00611]{DRAFT} [The interfaces `ara::crypto::cryp::KeyDerivationFunctionCtx::DeriveKey` and `ara::crypto::cryp::KeyDerivationFunctionCtx::DeriveSeed` shall apply the configured key derivation algorithm for the provided context configuration. The interface shall return the derived `Key Material` as a `ara::crypto::cryp::SymmetricKey` or `ara::crypto::cryp::SecretSeed` respectively. The returned objects shall be configured according to the provided flags `isSession` or `isExportable` and `isSession` or `isExportable`. If the flags are not provided the object instance shall be session and not exportable. The interface shall return `kUninitializedContext`, if the configured key derivation algorithm requires more context configuration than provided.]([RS_CRYPT_02101](#))

[SWS_CRYPT_00622]{DRAFT} **Signalization of error** [By conventions, if any algorithm fails the `FC Crypto` shall provide a distinct error. The context will fail:

- If the input or output lengths exceed some (very large) implementation defined bound.

]([RS_CRYPT_02101](#))

[SWS_CRYPT_40944]{DRAFT} [The interfaces `ara::crypto::cryp::KeyDerivationFunctionCtx::SetSourceKeyMaterial` and `ara::crypto::cryp::KeyDerivationFunctionCtx::SetSourceKeyMaterial` shall deploy the provided data (`ara::crypto::cryp::RestrictedUseObject` or `ara::crypto::cryp::ReadOnlyMemRegion`) as source input for key derivation. The interface shall return

- `kUsageViolation` error, if the allowed usage flag `kAllowKdfMaterial` of the provided `ara::crypto::cryp::RestrictedUseObject` is not set.

- `kIncompatibleObject` error, if the provided `ara::crypto::cryp::RestrictedUseObject` belongs to a different `ara::crypto::cryp::CryptoProvider` instance.
- `kBruteForceRisk` error, if the provided source material is below a implementation defined size

](RS_CRYPT_02101)

[SWS_CRYPT_40945]{DRAFT} [The interface `ara::crypto::cryp::KeyDerivationFunctionCtx::Init` shall configure the key derivation by setting the provided `targetKeyId`, the optionally provided `ara::crypto::CryptoAlgId`, usage flags and context label of the derived key. The interface shall return:

- `kUsageViolation` error, if a `ara::crypto::cryp::RestrictedUseObject` has been provided as source `Key Material` and its allowed usage flags are more restrictive than the allowed usage flags provided by this interface.
- `kIncompatibleArguments` error, if the provided `targetAlgId` is incompatible with the size of the `Key Material` derived by the configured key derivation algorithm.

](RS_CRYPT_02101)

[SWS_CRYPT_40946]{DRAFT} [The interface `ara::crypto::cryp::KeyDerivationFunctionCtx::GetTargetAllowedUsage` shall return the allowed usage flags of the derived key.

- If the context has not yet been configured by a call to `ara::crypto::cryp::KeyDerivationFunctionCtx::Init` and a `ara::crypto::cryp::RestrictedUseObject` has been provided as source `Key Material`, the allowed usage flags of the source key-material shall be returned.
- If the context has not yet been configured by a call to `ara::crypto::cryp::KeyDerivationFunctionCtx::Init` and no `ara::crypto::cryp::RestrictedUseObject` has been provided as source `Key Material`, `kAllowKdfMaterialAnyUsage` shall be returned.
- If the context has been configured by a call to `ara::crypto::cryp::KeyDerivationFunctionCtx::Init`, the provided `ara::crypto::AllowedUsageFlags` shall be returned or `kAllowKdfMaterialAnyUsage` in case `ara::crypto::AllowedUsageFlags` have not been provided.

](RS_CRYPT_02101)

7.4.1.3 Hashing

A hash-function is a one-way function and maps an arbitrary string of bits to a fixed-length string of bits. Due to its nature the bit string result is practical infeasible to invert. Hash-functions are basic elements of cryptography functions. Therefore, the

`FC Crypto` allows application and `Functional Clusters` to use common hash-functions and expose access via the `CryptoAPI` to the user. The `FC Crypto` ensures that the typical properties of modern hash-functions are met and not altered by third parties. The typical properties of modern hash-functions are:

- Determinism: the same input to the hash-function generates always the same result.
- Speed: results are quick to compute.
- No revert: the result is infeasible to revert to the input.
- Collision freedom: two different inputs generate different output.
- Correlation freedom: a small change to the input changes the output significant without providing a correlation of all parts.

[SWS_CRYPT_00902]{DRAFT} [The `ara::crypto::crypt::HashFunctionCtx` shall implement hashing.

]([RS_CRYPT_02204](#))

[SWS_CRYPT_00903]{DRAFT} [The `ara::crypto::crypt::HashFunctionCtx` shall store the calculated hash value until this `ara::crypto::crypt::HashFunctionCtx` object is destroyed or the function `ara::crypto::crypt::HashFunctionCtx::Start` is called again.]([RS_CRYPT_02205](#))

[SWS_CRYPT_00908]{DRAFT} Start [The functions `ara::crypto::crypt::HashFunctionCtx::Start`, `ara::crypto::crypt::HashFunctionCtx::Start`, `ara::crypto::crypt::HashFunctionCtx::Start` shall clear the current hash value and initialize the context with the provided `IV`.

- `ara::crypto::crypt::HashFunctionCtx::Start`, `ara::crypto::crypt::HashFunctionCtx::Start` shall return a `kInvalidInputSize` error, if the size of the provided `IV` is not supported by the configured context `ara::crypto::CryptoAlgId`.
- `ara::crypto::crypt::HashFunctionCtx::Start`, `ara::crypto::crypt::HashFunctionCtx::Start` shall return a `kUnsupported` error, if the configured context `ara::crypto::CryptoAlgId` does not support an `IV`.
- `ara::crypto::crypt::HashFunctionCtx::Start` shall return a `kMissingArgument` error, if the configured context `ara::crypto::CryptoAlgId` expected an `IV` but none was provided.

]([RS_CRYPT_02205](#))

Note, `Start` method can be called after `Update` method. In this case the `ara::crypto::crypt::HashFunctionCtx` will not return an error, instead `Start` method will start a new hash value calculation.

Some [Cryptographic primitives](#) require an Initialization Vector to guarantee randomness or freshness during the data processing. When an application or [Functional Cluster](#) specifies a cryptographic primitive, which requires an [IV](#), the caller must provide the [IV](#).

Hash-function calculation can be resource intensive when the input data has an arbitrary length, which may exceed some (very large) implementation defined bound. A solution is to generate hashes incrementally by presenting parts of the input data, which is hashed. This elementary characteristic is based on two reasons:

- Commonly in practice the entire hash object is not in one contiguous segment available. Instead, often parts are used independently as given by the [HMAC](#) function for example. Here, the inner hash is some preprocessed keying material, followed by the message being [MAC](#)'ed. Therefore, a temporary buffer consisting of the [HMAC](#) inner key ("ipad") and the message can be created. However, this is an overhead.
- The incrementally creation allows to run the hash implementation in memory complexity $O(1)$. The needed memory space for calculation is independent of input size. This is very easy to do with current hash function, such as [SHA-2](#) and [SHA-3](#), where, with a small amount of side memory, the hashing processes the message in pieces.

When an application or [Functional Cluster](#) uses the hash-function of [FC Crypto](#), it expects that the [Crypto Provider](#) supports this elementary characteristic and the [CryptoAPI](#) exposes the corresponding interface.

[SWS_CRYPT_00905]{DRAFT} Update [The functions `ara::crypto::cryp::--HashFunctionCtx::Update`, `ara::crypto::cryp::HashFunctionCtx::Update`, `ara::crypto::cryp::HashFunctionCtx::Update` shall implement the configured hash algorithm calculation.] ([RS_CRYPT_02205](#))

[SWS_CRYPT_00909]{DRAFT} Update [The user application shall be able to call `Update` multiple times, each time providing a new chunk of data. `Update` shall update the hash value calculation with each new chunk. `Update` shall return a `CryptoErrorDomain::kProcessingNotStarted` error, if `Start` has not been called before.] ([RS_CRYPT_02205](#))

With the support of the incrementally creation characteristics the [FC Crypto](#) lost the possibility to know when the input data ends. Therefore, the application or [Functional Cluster](#) needs the possibility to inform the [Crypto Provider](#) that all parts of the input was provided and no further input must be processed. The [CryptoAPI](#) supports this signaling with a corresponding interface.

[SWS_CRYPT_00906]{DRAFT} Finish [The function `ara::crypto::cryp::--HashFunctionCtx::Finish` shall finalize the hash value calculation and return the hash value, i.e. no more data may be provided by `Update`.

- `ara::crypto::cryp::HashFunctionCtx::Finish` shall return a `CryptoErrorDomain::kProcessingNotStarted` error, if `Start` has not been successfully called before.
- `ara::crypto::cryp::HashFunctionCtx::Finish` shall return a `CryptoErrorDomain::kInvalidUsageOrder` error, if `Update` has not been called successfully after the last call to `Start`.

]([RS_CRYPTO_02205](#))

[SWS_CRYPT_00910]{DRAFT} [If `Finish` is called multiple times for the same hash value calculation, then only the first call shall apply the finalizations step; i.e. all other subsequent calls shall only return the hash value.]([RS_CRYPTO_02205](#))

If the signature object is produced by a plain hash-function, then the dependent `COUID` of the signature should be set to `COUID` of context. However, the hash algorithm ID field of the signature shall be set according to the used algorithm ID. If the signature object is produced by a keyed `MAC/HMAC/AE/AEAD` algorithm, then the dependence `COUID` of the signature should be set to `COUID` of used `Symmetric Key`. Instead, the hash algorithm ID field of the signature shall be set to an unknown algorithm ID.

[SWS_CRYPT_00907]{DRAFT} Retrieving the hash value [The functions `ara::crypto::cryp::HashFunctionCtx::GetDigest`, `ara::crypto::cryp::HashFunctionCtx::GetDigest` shall return the finalized hash value or part of the hash value, if the application requested an offset. The offset specifies the first byte that shall be included in the returned buffer.]([RS_CRYPTO_02205](#))

[SWS_CRYPT_00919]{DRAFT} Signalization of missing finalization error [The functions `ara::crypto::cryp::HashFunctionCtx::GetDigest`, `ara::crypto::cryp::HashFunctionCtx::GetDigest` shall return a `kProcessingNotFinished` error, if `ara::crypto::cryp::HashFunctionCtx::Finish` has not been called for the current hash value calculation.]([RS_CRYPTO_02205](#))

7.4.1.4 Message Authentication Code (MAC)

According to the ISO-9797 [13] `Message Authentication Code (MAC)` algorithms are data integrity mechanisms that compute a short string (the Message Authentication Code or MAC) as a complex function of every bit of the data and of a secret key. Their main security property is unforgeability: someone who does not know the secret key should not be able to predict the MAC on any new data string.

`MAC` algorithms can be used to provide data integrity, as defined in defined in [14] and in [15]. Their purpose is the detection of any unauthorized modification of the data such as deletion, insertion, or transportation of items within data. This includes both malicious and accidental modifications. `MAC` algorithms can also provide data origin authentication. This means that they can provide assurance that a message has been originated by an entity in possession of a specific secret key.

In order to support these mechanism, the `FC Crypto` must provide three basic building blocks:

- A key generation algorithm
- An signing algorithm
- A verifying algorithm

The `FC Crypto` shall support `Message Authentication Code` generation as described in [14] and in [15].

This identifier is encoded with the common name as defined in chapter 7.5. `MAC` algorithms can be constructed from other `Cryptographic primitives`, like cryptographic hash functions (as in the case of HMAC), which are specified in chapter 7.4.1.3, or from `Block Cipher` algorithms, as defined in chapter 7.4.1.5.1. Both variants are supported by the `FC Crypto`. However, the `Crypto Provider` can either directly access the cryptographic algorithm or use the exposed interfaces provided by the `CryptoAPI`.

The context handles two different use cases, when an application or `Functional Cluster` start processing or generation of the hash-value:

- The context was fresh initialized. No former data was stored in the context, so the `Crypto Provider` can start the calculation on the new data stream (depending from the primitive).
- The context was used previously. Thus, previous stored content will be deleted, the context is rest to a fresh initialization state, and the calculation is started on the new given data stream.

Some `Cryptographic primitives` require an Initialization Vector to guarantee randomness or freshness during the data processing. When an application or `Functional Cluster` specifies a cryptographic primitive, which requires an `IV`, as `MAC` algorithms, the caller must provide the `IV`. Otherwise the `Crypto Provider` will throw an error.

[SWS_CRYPT_01202]{DRAFT} [At initialization phase the context allows to specify an optional Initialization Vector (`IV`) or `Nonce` value. If `IV` size is greater than maximally by the algorithm supported length, then an `FC Crypto` uses the leading bytes only.] (*RS_CRYPT_02203*)

[SWS_CRYPT_01201]{DRAFT} [The function `ara::crypto::crypt::MessageAuthnCodeCtx::Start` shall initialize the context for a new data stream processing or generation (depending on the the primitive). The function shall return:

- `kUninitializedContext` error, if the context was not initialized by deploying a key.
- `kInvalidInputSize` error, if the size of provided `IV` is not supported (i.e. if it is not enough for the initialization).

- `kUnsupported` error, if the base algorithm (or its current implementation) principally does not support the IV variation, but provided IV value is not empty.

](RS_CRYPT_02203)

[SWS_CRYPT_01203]{DRAFT} Start [The function `ara::crypto::crypt::MessageAuthnCodeCtx::Start` shall initialize the context for a new data stream processing or generation (depending on the primitive) with a secret seed. If the size of the secret seed size is greater than maximum supported by the algorithm then an implementation may use the leading bytes only from the sequence. The function shall return:

- `kUninitializedContext` error, if the context was not initialized by deploying a key.
- `kInvalidInputSize` error, if the size of provided secret seed is not supported (i.e. if it is not enough for the initialization).
- `kUnsupported` if the base algorithm (or its current implementation) principally does not support the secret seed variation.
- `kUsageViolation` error, if this transformation type is prohibited by the "allowed usage" restrictions of the provided Secret Seed object.

](RS_CRYPT_02203)

[SWS_CRYPT_01204]{DRAFT} Update [The functions `ara::crypto::crypt::MessageAuthnCodeCtx::Update`, `ara::crypto::crypt::MessageAuthnCodeCtx::Update`, `ara::crypto::crypt::MessageAuthnCodeCtx::Update` shall update the digest calculation context by a new part of the message. The functions shall return:

- `kProcessingNotStarted` error, if the digest calculation was not initiated by a call of the `ara::crypto::crypt::MessageAuthnCodeCtx::Start` method.

](RS_CRYPT_02203)

[SWS_CRYPT_01207]{DRAFT} Finish [The function `ara::crypto::crypt::MessageAuthnCodeCtx::Finish` shall finalize the hash value calculation, return the hash value and optionally produce the "signature" object. After the call of this function no more data can be provided by calling `ara::crypto::crypt::MessageAuthnCodeCtx::Update`. The function shall return:

- `kProcessingNotStarted` error, if `ara::crypto::crypt::MessageAuthnCodeCtx::Start` has not been successfully called before.
- `kUsageViolation` error, if `ara::crypto::crypt::MessageAuthnCodeCtx::Update`, `ara::crypto::crypt::MessageAuthnCodeCtx::Update`, `ara::crypto::crypt::MessageAuthnCodeCtx::Update` has not been called successfully after the last call to `ara::crypto::crypt::MessageAuthnCodeCtx::Start`.

](RS_CRYPT_02203)

[SWS_CRYPT_01208]{DRAFT} [If the signature object is produced by a plain hash-function then the dependence `COUID` of the "signature" should be set to `COUID` of the used context. But the hash algorithm ID field of the signature should be set according to the used algorithm ID.](RS_CRYPT_02203)

[SWS_CRYPT_01209]{DRAFT} [If the signature object is produced by a keyed `MAC/HMAC/AE/AEAD` algorithm, then the dependent `COUID` of the signature should be set to `COUID` of the used `Symmetric Key`. However, the hash algorithm ID field of the signature should be set to unknown.](RS_CRYPT_02203)

[SWS_CRYPT_01210]{DRAFT} GetDigest [The functions `ara::crypto::crypt::MessageAuthnCodeCtx::GetDigest`, `ara::crypto::crypt::MessageAuthnCodeCtx::GetDigest` shall provide the hashed output. The `CryptoAPI` allows also to specific an offset. This offset informs the `Crypto Provider` where the position of first byte of digest is that should be placed to the output buffer. The functions shall return:

- `kProcessingNotFinished` error, if the digest calculation was not finished by a call of the `Finish()` method.
- `kUsageViolation` error, if the buffered digest belongs to a `MAC/HMAC/AE/AEAD` context initialized by a key without `kAllowSignature` permission.

](RS_CRYPT_02203)

The `Key Storage Provider` generates and manages the key as described in chapter 7.4.2.2. The key can either be generated or configured in the context of the application or `Functional Cluster`. When the `FC Crypto` provides the context no key is given. The application or `Functional Cluster` will provide the key. The key itself contains also the encoding as an attribute and will not provided by the application or `Functional Cluster` in the call of the `CryptoAPI` method.

[SWS_CRYPT_01211]{DRAFT} SetKey [The function `ara::crypto::crypt::MessageAuthnCodeCtx::SetKey` shall set (deploy) a key to `ara::crypto::crypt::MessageAuthnCodeCtx`. The function shall return:

- `kIncompatibleObject` error, if the provided key object is incompatible with this `Symmetric Key` context.
- `kUsageViolation` error, if the transformation type associated with this context (taking into account the direction specified by transform) is prohibited by the "allowed usage"restrictions of provided key object.

](RS_CRYPT_02203)

[SWS_CRYPT_01213]{DRAFT} Verify [The `CryptoAPI` shall `ara::crypto::crypt::MessageAuthnCodeCtx::Check` if previous calculated and internally stored `MAC` is valid to an expected "signature" object. Validation is successful, if value and

meta-information of the provided "signature" object is identical to calculated digest and current configuration of the context.](RS_CRYPT_02203)

7.4.1.5 Symmetric encryption

Symmetric encryption uses a shared secret (e.g., share key) to encrypt and / or decrypt an information. Without knowing the key, the information cannot be understood by anyone. Symmetric cryptography can be categorized by two algorithm classes:

1. **Block Cipher**: Data with a fixed length is transformed (en/decrypted). The system can only process complete blocks of data held in its internal memory.
2. **Stream Cipher**: Information is encrypted as it streams instead of being retained in the system's memory.

7.4.1.5.1 Block cipher

The encryption method, **Block Cipher**, applies an algorithm with a **Symmetric Key** to encrypt an input data. **Block Ciphers** are commonly used to protect data at rest, such as on file systems.

[SWS_CRYPT_01502]{DRAFT} [The interface `ara::crypto::crypt::SymmetricBlockCipherCtx::SetKey` shall configure this context for encryption or decryption according to the provided `ara::crypto::CryptoTransform` and ensure that the provided `ara::crypto::crypt::SymmetricKey` is used for the following en/decryption.

- **SetKey shall return a `CryptoErrorDomain::kIncompatibleObject` error, if the provided **Symmetric Key** belongs to a different `ara::crypto::crypt::CryptoProvider` instance.**
- **SetKey shall return a `CryptoErrorDomain::kUsageViolation` error, if the provided transformation direction (`CryptoTransform::kEncrypt` or `CryptoTransform::kDecrypt`) does not match the `ara::crypto::AllowedUsageFlags` (`kAllowDataEncryption` or `kAllowDataDecryption`, respectively) of the provided **Symmetric Key**.**

](RS_CRYPT_02201)

[SWS_CRYPT_01501]{DRAFT} [Only the key and transformation direction specified by the last valid call of `ara::crypto::crypt::SymmetricBlockCipherCtx::SetKey` shall be used for the subsequent encryption or decryption operation.](RS_CRYPT_02107, RS_CRYPT_02201)

[SWS_CRYPT_01508]{DRAFT} [The interface `ara::crypto::cryp::SymmetricBlockCipherCtx::GetTransformation` shall return the `ara::crypto::CryptoTransform` that was provided in the last valid call to `ara::crypto::cryp::SymmetricBlockCipherCtx::SetKey`.

- `GetTransformation` shall return a `CryptoErrorDomain::kUninitializedContext` error, if `ara::crypto::cryp::SymmetricBlockCipherCtx::SetKey` was never called.

]([RS_CRYPT_02107](#), [RS_CRYPT_02201](#))

[SWS_CRYPT_01506]{DRAFT} [The interface `ara::crypto::cryp::SymmetricBlockCipherCtx::GetCryptoService` shall return a unique pointer to the `ara::crypto::cryp::CryptoService` associated with this context.]([RS_CRYPT_02107](#), [RS_CRYPT_02201](#))

[SWS_CRYPT_01503]{DRAFT} [The interface `ara::crypto::cryp::SymmetricBlockCipherCtx::ProcessBlock` shall apply the configured transformation (encryption or decryption) to the provided `ara::crypto::ReadOnlyMemRegion` and return the result. Note: `ProcessBlock` shall not apply padding, but instead the size of the input buffer must be equal to the block-size.

- `ProcessBlock` shall return a `CryptoErrorDomain::kUninitializedContext` error, if `ara::crypto::cryp::SymmetricBlockCipherCtx::SetKey` was never called.
- `ProcessBlock` shall return a `CryptoErrorDomain::kInvalidInputSize` error, if the size of the input buffer is not equal to the block-size.

]([RS_CRYPT_02201](#))

[SWS_CRYPT_01504]{DRAFT} [The interface `ara::crypto::cryp::SymmetricBlockCipherCtx::ProcessBlocks` shall apply the configured transformation (encryption or decryption) to the provided `ara::crypto::ReadOnlyMemRegion` and return the result. Note: `ProcessBlocks` shall not apply padding, but instead the size of the input buffer must be a multiple of the block-size.

- `ProcessBlock` shall return a `CryptoErrorDomain::kUninitializedContext` error, if `ara::crypto::cryp::SymmetricBlockCipherCtx::SetKey` was never called.
- `ProcessBlock` shall return a `CryptoErrorDomain::kInvalidInputSize` error, if the size of the input buffer is not a multiple of the block-size.

]([RS_CRYPT_02201](#))

7.4.1.5.2 Stream Cipher

A [Stream Cipher](#) is used for [Symmetric Key](#) cryptography, or when the same key is used to encrypt and decrypt data. [Stream Ciphers](#) encrypt pseudo-random sequences with bits of plain-text in order to generate cipher-text, usually with XOR. [Stream Ciphers](#) are good for fast implementations with low resource consumption. These two features help the defender implement resistance strategies in devices that may not have the resources for a [Block Cipher](#) implementation. [Stream Ciphers](#) can be broadly classified into those that work better in hardware and those that work better in software. [Stream Ciphers](#) are commonly used to protect data in motion, such as encrypting data on the network.

[SWS_CRYPT_01651]{DRAFT} [The interface [ara::crypto::crypt::StreamCipherCtx::GetBlockService](#) shall return a unique pointer to the [ara::crypto::crypt::BlockService](#) associated with this context.]([RS_CRYPT_02107](#), [RS_CRYPT_02201](#))

[SWS_CRYPT_01658]{DRAFT} [The interface [ara::crypto::crypt::StreamCipherCtx::CountBytesInCache](#) shall return the number of input data bytes currently held in the context cache.]([RS_CRYPT_02201](#))

Note, that the above requirement applies only to block-wise modes when the user supplied input data that is not a multiple of the block-size. In this case the last data chunk, which cannot be processed because it is less than the block-size, must be cached until the next data processing call adds sufficient data to complete the block-size (and continue processing).

[SWS_CRYPT_01659]{DRAFT} [The interface [ara::crypto::crypt::StreamCipherCtx::SetKey](#) shall configure this context for encryption or decryption according to the provided [ara::crypto::CryptoTransform](#) and ensure that the provided [ara::crypto::crypt::SymmetricKey](#) is used for the following en/decryption.

- **SetKey** shall return a [CryptoErrorDomain::kIncompatibleObject](#) error, if the provided [Symmetric Key](#) belongs to a different [ara::crypto::crypt::CryptoProvider](#) instance.
- **SetKey** shall return a [CryptoErrorDomain::kUsageViolation](#) error, if the provided transformation direction ([CryptoTransform::kEncrypt](#) or [CryptoTransform::kDecrypt](#)) does not match the [ara::crypto::AllowedUsageFlags](#) ([kAllowDataEncryption](#) or [kAllowDataDecryption](#)) of the provided [Symmetric Key](#).

]([RS_CRYPT_02201](#))

[SWS_CRYPT_01660]{DRAFT} [The interface [ara::crypto::crypt::StreamCipherCtx::GetTransformation](#) shall return the [ara::crypto::CryptoTransform](#) that was provided in the last valid call to [ara::crypto::crypt::StreamCipherCtx::SetKey](#).

- `GetTransformation` shall return a `CryptoErrorDomain::kUninitializedContext` error, if `ara::crypto::cryp::StreamCipherCtx::SetKey` was never called.

](RS_CRYPT_02201)

[SWS_CRYPT_01661]{DRAFT} [The interface `ara::crypto::cryp::StreamCipherCtx::IsBytewiseMode` shall return `TRUE`, if the algorithm specified during context creation supports updating data byte-wise. It shall return `FALSE`, if the algorithm can process only data in multiples of the block-size.] (RS_CRYPT_02201)

Some operation modes of specific `Stream Ciphers` are seekable, e.g., [16, CTR], [17, Salsa20], or [18, Trivium], and others are not. Seekable means that the user can efficiently seek to any position in the data stream in constant time. If the user needs such functionality and it is unclear if the chosen algorithm provides this kind of functionality, the support of such a mode can be queried.

[SWS_CRYPT_01662]{DRAFT} [The interface `ara::crypto::cryp::StreamCipherCtx::IsSeekableMode` shall return `TRUE`, if the algorithm specified during context creation supports seek operations.] (RS_CRYPT_02201)

[SWS_CRYPT_01653]{DRAFT} [The interface `ara::crypto::cryp::StreamCipherCtx::Seek` shall increment/decrement the position of the next byte to process according to the provided `offset`. If the second and optional boolean parameter equals `TRUE`, `offset` shall be counted from the start of the stream.

- `Seek` shall return a `CryptoErrorDomain::kUnsupported` error, if this context does not support seeking.
- `Seek` shall return a `CryptoErrorDomain::kProcessingNotStarted` error, if processing was not started by successfully calling `Start` or has already been terminated by successfully calling `FinishBytes`.
- `Seek` shall return a `CryptoErrorDomain::kBelowBoundary` error, if the absolute seek position is negative.
- `Seek` shall return a `CryptoErrorDomain::kInvalidArgument` error, if the interface `ara::crypto::cryp::StreamCipherCtx::IsBytewiseMode` returns `FALSE` and the `offset` is not aligned on the block boundary.

](RS_CRYPT_02201)

[SWS_CRYPT_01654]{DRAFT} [The interface `ara::crypto::cryp::StreamCipherCtx::Start` shall initialize the context either with an optional `ara::crypto::ReadOnlyMemRegion` or a mandatory `ara::crypto::cryp::SecretSeed`. If the size of initialization data is larger than required by the context, only the leading bytes shall be used.

- `Start` shall return a `CryptoErrorDomain::kUninitializedContext` error, if `SetKey` was never called on this context.

- `Start` shall return a `CryptoErrorDomain::kInvalidInputSize` error, if not enough initialization data has been provided.
- `Start` shall return a `CryptoErrorDomain::kUnsupported` error, if the algorithm selected during context creation does not support initialization but initialization data has been provided nonetheless.
- `Start` shall return a `CryptoErrorDomain::kUsageViolation` error, if the transformation direction provided by a call to `ara::crypto::cryp::StreamCipherCtx::SetKey` (`CryptoTransform::kEncrypt` or `CryptoTransform::kDecrypt`) does not match the `ara::crypto::AllowedUsageFlags` (`kAllowDataEncryption` or `kAllowDataDecryption`) of the provided `ara::crypto::cryp::SecretSeed`.

](RS_CRYPT_02201)

`Start` can be called even if processing has already been started by calling for example `ProcessBlocks`. In this case `Start` will cancel the previous transformation and discard the intermediate result, and re-initialize the context for the new transformation.

Note: `ara::crypto::cryp::StreamCipherCtx::Start` must be called even if the selected algorithm does not support initialization. In this case an empty `ara::crypto::ReadOnlyMemRegion` must be provided.

[SWS_CRYPT_01655]{DRAFT} [The interface `ara::crypto::cryp::StreamCipherCtx::ProcessBlocks` shall apply the configured transformation (encryption or decryption) to the provided data. If the data has been provided as a `ara::crypto::ReadOnlyMemRegion`, `ProcessBlock` shall return the processed data. If the data was provided as a `ara::crypto::ReadWriteMemRegion`, the input data shall be overwritten with the processed data. Note: the size of the input or input and output buffer must be a multiple of the block-size.

- `ProcessBlock` shall return a `CryptoErrorDomain::kInvalidUsageOrder` error, if this interface is called after `ara::crypto::cryp::StreamCipherCtx::ProcessBytes` has been called.
- `ProcessBlock` shall return a `CryptoErrorDomain::kInvalidInputSize` error, if the size of the input buffer is not a multiple of the block-size.
- `ProcessBlock` shall return a `CryptoErrorDomain::kProcessingNotStarted` error, if processing was not started by successfully calling `Start` or has already been terminated by successfully calling `FinishBytes`.

](RS_CRYPT_02201)

[SWS_CRYPT_01656]{DRAFT} [The interface `ara::crypto::cryp::StreamCipherCtx::ProcessBytes` shall apply the configured transformation (encryption or decryption) to the provided data and return the result. Note: the size of the input buffer does not need to be a multiple of the block-size. Therefore, if `IsByteWiseMode` equals `FALSE`, `ProcessBytes` shall keep an internal buffer equal in size to the block-size and only process full blocks of data. If a call to this interface left unprocessed data

in the buffer, the subsequent call's input data shall continue filling the buffer until it can be processed.

- `ProcessBlock` shall return a `CryptoErrorDomain::kProcessingNotStarted` error, if processing was not started by successfully calling `Start` or has already been terminated by successfully calling `FinishBytes`.

](RS_CRYPT_02201)

[SWS_CRYPT_01657]{DRAFT} [The interface `ara::crypto::cryp::StreamCipherCtx::FinishBytes` shall apply the configured transformation (encryption or decryption) to the provided data for the last and final time, and return the result. If `IsBytewiseMode` equals `FALSE` and the provided data is insufficient to end processing with a completely filled internal block-size buffer (cache), then padding shall be applied according to the algorithm selected when creating this context. For decryption the padding shall be removed before returning the processed data.

- `FinishBytes` shall return a `CryptoErrorDomain::kProcessingNotStarted` error, if processing was not started by successfully calling `Start` or has already been terminated by successfully calling `FinishBytes`.

](RS_CRYPT_02201)

Some `Stream Cipher` need an exact multiple of the block length in byte. If the length of the data to be encrypted is not an exact multiple, it must be padded to make it so. Available padding schemes are for example, [19, PKCS5], [20, PKCS5], [21, PKCS7], or [22, ANSI X9.23].

7.4.1.6 Authenticated Encryption

Authenticated Encryption (AE) or Authenticated Encryption with Associated Data (AEAD) provide confidentiality and data authenticity simultaneously. AEAD adds the ability to check the integrity and authenticity of some Associated Data (AD), also called "additional authenticated data". Additionally, this mechanism adds an `Message Authentication Code` (MAC), as described in chapter 7.4.1.4, to conform that encrypted data is authentic.

Note: the class `ara::crypto::cryp::AuthCipherCtx` provides authenticity and confidentiality only for well known algorithm-protocols that derive both their properties from a single `Symmetric Key` (e.g. ChaCha20-Poly1305, aead/gimli24v1 or AES-GCM). To implement a custom authenticated-encryption protocol (following a pattern of Encrypt-then-Mac, Mac-then-encrypt or Encrypt-and-Mac) the classes `ara::crypto::cryp::StreamCipherCtx` and `ara::crypto::cryp::MessageAuthnCodeCtx` can be used.

[SWS_CRYPT_01800]{DRAFT} [The functions `ara::crypto::cryp::AuthCipherCtx::UpdateAssociatedData`, `ara::crypto::cryp::AuthCipherCtx::UpdateAssociatedData`, `ara::crypto::cryp::AuthCipherCtx::UpdateAssociatedData` shall return a `CryptoErrorDomain::kInvalidUsageOrder` error, if `ProcessConfidentialData` has already been called.] ([RS_CRYPT_02207](#))

[SWS_CRYPT_01801]{DRAFT} [If associated data is provided by calling `ara::crypto::cryp::AuthCipherCtx::UpdateAssociatedData`, `ara::crypto::cryp::AuthCipherCtx::UpdateAssociatedData`, `ara::crypto::cryp::AuthCipherCtx::UpdateAssociatedData`, the MAC calculation must be updated with the associated data.] ([RS_CRYPT_02207](#))

[SWS_CRYPT_01802]{DRAFT} [Calling `UpdateAssociatedData` is optional for the user. In this case the MAC shall be calculated over the confidential data only.] ([RS_CRYPT_02207](#))

[SWS_CRYPT_01803]{DRAFT} [The function `ara::crypto::cryp::AuthCipherCtx::ProcessConfidentialData` shall update the calculation of the MAC with the confidential data.

] ([RS_CRYPT_02207](#))

[SWS_CRYPT_01804]{DRAFT} [If the transformation direction (`ara::crypto::cryp::AuthCipherCtx::GetTransformation`) is `kEncrypt`, `ara::crypto::cryp::AuthCipherCtx::ProcessConfidentialData` shall also encrypt the provided `Plaintext` data and return the `Ciphertext`.

] ([RS_CRYPT_02207](#))

[SWS_CRYPT_01805]{DRAFT} [If the transformation direction is `kDecrypt`, `ara::crypto::cryp::AuthCipherCtx::ProcessConfidentialData` shall also decrypt the provided `Plaintext` data and return the `Plaintext`, only if the calculated MAC matches the provided `expectedTag`. If the calculated MAC does not match the provided `expectedTag`, `CryptoErrorDomain::kAuthTagNotValid` error shall be returned instead.] ([RS_CRYPT_02207](#))

[SWS_CRYPT_01807]{DRAFT} [The `ara::crypto::cryp::AuthCipherCtx::SetKey` interface of the `AuthCipherCtx` shall check the allowed-usage flags of the key parameter provided. The function shall return

- a `kUsageViolation` error, if `kAllowDataEncryption` is not set and the transformation direction is `CryptoTransform::kEncrypt`.
- a `kUsageViolation` error, if `kAllowDataEncryption` is not set and the transformation direction is `CryptoTransform::kDecrypt`.

] ([RS_CRYPT_02207](#))

[SWS_CRYPT_01808]{DRAFT} [The function `ara::crypto::cryp::AuthCipherCtx::Start` shall initialize the transformation using the provided `IV` or `Nonce`. The function shall return:

- a `kUninitializedContext` error, if `ara::crypto::cryp::AuthCipherCtx::SetKey` has not been called before.
- a `kInvalidInputSize` error, if the provided data is insufficient.
- a `kUnsupported` error, if the `ara::crypto::CryptoAlgId` specified does not support an `IV` or a `Nonce`.
- a `kUsageViolation` error, if a `ara::crypto::cryp::SecretSeed` instance has been provided as the `IV` or `Nonce` and its allowed usage flags (`kAllowDataEncryption` or `kAllowDataDecryption`) do not match the transformation direction set by the `ara::crypto::cryp::AuthCipherCtx::SetKey` function `kEncrypt` or `kDecrypt`.

]([RS_CRYPT_02207](#))

[SWS_CRYPT_01811]{DRAFT} [The `ara::crypto::cryp::AuthCipherCtx::GetDigest` function shall return the calculated `MAC` as raw data only after the `ProcessConfidentialData` has been successfully executed.]([RS_CRYPT_02207](#))

7.4.1.7 Key Wrapping

Key Wrapping (as defined in [23] and [24]) encapsulates `Key Material`, which is used for example to store a key in an unsecure environment or transport a key by an unsecure channel. Wrapping a key is a kind of encryption of the key and contributes to confidentiality.

Wrapping a key requires a `KEK`. With the call of the `CryptoAPI` interface the `KEK` is set (deployed) to the key wrapper algorithm context. Additionally, a "direction" indicator is used to define the transformation direction, such as wrapping, unwrapping, signature calculation, or signature verification.

[SWS_CRYPT_02121]{DRAFT} [The interface `ara::crypto::cryp::SymmetricKeyWrapperCtx::CalculateWrappedKeySize` shall calculate the size of the wrapped key based on the provided `keyLength` of the key to wrap and return the result.]([RS_CRYPT_02208](#))

[SWS_CRYPT_02122]{DRAFT} [The interface `ara::crypto::cryp::SymmetricKeyWrapperCtx::SetKey` shall configure this context for encryption or decryption according to the provided `ara::crypto::CryptoTransform` and ensure the provided `ara::crypto::cryp::SymmetricKey` is used as the key-encryption-key (KEK) for subsequent processing in this context.

- `SetKey` shall return a `CryptoErrorDomain::kIncompatibleObject` error, if the provided `Symmetric Key` belongs to a different `ara::crypto::cryp::CryptoProvider` instance.

- **SetKey** shall return a `CryptoErrorDomain::kUsageViolation` error, if the provided transformation direction (`CryptoTransform::kEncrypt` or `CryptoTransform::kDecrypt`) does not match the `ara::crypto::AllowedUsageFlags` (`kAllowKeyExporting` or `kAllowKeyImporting`) of the provided `SymmetricKey`.

]([RS_CRYPTO_02208](#))

[SWS_CRYPT_02123]{DRAFT} [Only the key and transformation direction specified by the last valid call of `ara::crypto::cryp::SymmetricKeyWrapperCtx::SetKey` shall be used for the subsequent encryption or decryption operation.]([RS_CRYPTO_02107](#), [RS_CRYPTO_02201](#))

[SWS_CRYPT_02104]{DRAFT} [The interface `ara::crypto::cryp::SymmetricKeyWrapperCtx::GetMaxTargetKeyLength` shall return the maximum bit-length of the payload (key-material) that can be protected by the algorithm specified during context creation.]([RS_CRYPTO_02208](#))

[SWS_CRYPT_02106]{DRAFT} [The interface `ara::crypto::cryp::SymmetricKeyWrapperCtx::GetTargetKeyGranularity` shall return the granularity in Bytes of the payload (key-material) that can be protected by the algorithm specified during context creation.]([RS_CRYPTO_02208](#))

The granularity of key-material refers to the minimum key-size that can be protected and implies that the actual key-size has to be a multiple of this value.

[SWS_CRYPT_02105]{DRAFT} **wrap** [The interface `ara::crypto::cryp::SymmetricKeyWrapperCtx::WrapKeyMaterial` shall execute the key-wrap operation on the key-material of the provided `ara::crypto::RestrictedUseObject` and return the result.

- **WrapKeyMaterial** shall return a `CryptoErrorDomain::kInvalidInputSize` error, if the length of the provided `ara::crypto::RestrictedUseObject` is unsupported by the algorithm specified during context creation.
- **WrapKeyMaterial** shall return a `CryptoErrorDomain::kUninitializedContext` error, if `ara::crypto::cryp::SymmetricKeyWrapperCtx::SetKey` was never called.
- **WrapKeyMaterial** shall return a `CryptoErrorDomain::kUsageViolation` error, if the `kAllowExport` flag is not set in the `ara::crypto::AllowedUsageFlags` of the provided `ara::crypto::RestrictedUseObject`, or if the `kAllowKeyExporting` flag of the `ara::crypto::AllowedUsageFlags` is not set for the `SymmetricKey` specified in the `SetKey` call.

]([RS_CRYPTO_02208](#))

The flags `ara::crypto::AllowedUsageFlags` (`kAllowKeyExporting` or `kAllowKeyImporting`) are set for the provided `SymmetricKey`.

Note: this interface was designed to support for example RFC3394 or RFC5649.

[SWS_CRYPT_02107]{DRAFT} unwrap [The interface `ara::crypto::cryp::SymmetricKeyWrapperCtx::UnwrapKey` shall execute the key-unwrap operation on the provided `ara::crypto::ReadOnlyMemRegion` and return a unique smart pointer to the instantiated `ara::crypto::RestrictedUseObject`. `UnwrapKey` shall also apply the provided `ara::crypto::AllowedUsageFlags` and `ara::crypto::CryptoAlgId` to the created `RestrictedUseObject`.]([RS_CRYPTO_02208](#))

[SWS_CRYPT_02108]{DRAFT} unwrap [The interface `ara::crypto::cryp::SymmetricKeyWrapperCtx::UnwrapSeed` shall execute the key-unwrap operation on the provided `ara::crypto::ReadOnlyMemRegion` and return a unique smart pointer to the instantiated `ara::crypto::SecretSeed`. `UnwrapSeed` shall also apply the provided `ara::crypto::AllowedUsageFlags` and `ara::crypto::CryptoAlgId` to the created `ara::crypto::cryp::SecretSeed`.]([RS_CRYPTO_02208](#))

[SWS_CRYPT_02109]{DRAFT} error handling during unwrap [The interfaces `ara::crypto::cryp::SymmetricKeyWrapperCtx::UnwrapSeed` and `ara::crypto::cryp::SymmetricKeyWrapperCtx::UnwrapKey` shall

- return a `CryptoErrorDomain::kInvalidInputSize` error, if the length of the provided `ara::crypto::ReadOnlyMemRegion` is unsupported by the algorithm specified during context creation.
- return a `CryptoErrorDomain::kUninitializedContext` error, if `ara::crypto::cryp::SymmetricKeyWrapperCtx::SetKey` was never called.
- return a `CryptoErrorDomain::kUsageViolation` error, if the `kAllowKeyImporting` flag of the `ara::crypto::AllowedUsageFlags` is not set for the `Symmetric Key` specified in the `SetKey` call.

]([RS_CRYPTO_02208](#))

7.4.1.8 Digital signatures

Digital signature contributes to goal authenticity when information is transferred. Guaranteeing the authenticity of the information asymmetric cryptography is used, where the information is signed by a private key and verified later by using the matching public key. When the verification is successful, the receiver of the information can be sure that the owner of the private key is the sender of the information.

[SWS_CRYPT_02411]{DRAFT} [The `ara::crypto::cryp::MsgRecoveryPublicCtx` shall implement digital signature verification with message recovery according to [25].]([RS_CRYPTO_02204](#))

[SWS_CRYPT_02412]{DRAFT} [The `ara::crypto::cryp::SigEncodePrivateCtx` shall implement digital signature generation with message encoding according to [25].]([RS_CRYPTO_02204](#))

[SWS_CRYPT_02413]{DRAFT} [The `ara::crypto::cryp::SignerPrivateCtx` shall implement digital signature generation.](RS_CRYPTO_02204)

[SWS_CRYPT_02414]{DRAFT} [The `ara::crypto::cryp::VerifierPublicCtx` shall implement digital signature verification.](RS_CRYPTO_02204)

[SWS_CRYPT_01820]{DRAFT} [The interface `ara::crypto::cryp::SignerPrivateCtx::SetKey` shall ensure the provided `ara::crypto::cryp::PrivateKey` is used in the following signature generation. The interface shall return

- `kUsageViolation` error, if the allowed usage flag `kAllowSignature` of the provided `ara::crypto::cryp::PrivateKey` is not set.
- `kIncompatibleObject` error, if the provided `ara::crypto::cryp::PrivateKey` belongs to a different `ara::crypto::cryp::CryptoProvider` instance.
- `kIncompatibleObject` error, if the `ara::crypto::CryptoAlgId` of the provided `ara::crypto::cryp::PrivateKey` is not compatible with the `ara::crypto::CryptoAlgId` used to instantiate this context.

](RS_CRYPTO_02207)

[SWS_CRYPT_01821]{DRAFT} [The interface `ara::crypto::cryp::VerifierPublicCtx::SetKey` shall ensure the provided `ara::crypto::cryp::PublicKey` is used in the following signature verification. The interface shall return

- `kUsageViolation` error, if the allowed usage flag `kAllowVerification` of the provided `ara::crypto::cryp::PublicKey` is not set.
- `kIncompatibleObject` error, if the provided `ara::crypto::cryp::PublicKey` belongs to a different `ara::crypto::cryp::CryptoProvider` instance.
- `kIncompatibleObject` error, if the `ara::crypto::CryptoAlgId` of the provided `ara::crypto::cryp::PublicKey` is not compatible with the `ara::crypto::CryptoAlgId` used to instantiate this context.

](RS_CRYPTO_02207)

[SWS_CRYPT_01822]{DRAFT} [The interface `ara::crypto::cryp::SigEncodePrivateCtx::SetKey` shall ensure the provided `ara::crypto::cryp::PrivateKey` is used in the following signature generation with message encoding. The interface shall return

- `kUsageViolation` error, if the allowed usage flag `kAllowSignature` of the provided `ara::crypto::cryp::PrivateKey` is not set.
- `kIncompatibleObject` error, if the provided `ara::crypto::cryp::PrivateKey` belongs to a different `ara::crypto::cryp::CryptoProvider` instance.

- `kIncompatibleObject` error, if the `ara::crypto::CryptoAlgId` of the provided `ara::crypto::crypt::PrivateKey` is not compatible with the `ara::crypto::CryptoAlgId` used to instantiate this context.

](RS_CRYPT_02207)

[SWS_CRYPT_01823]{DRAFT} [The interface `ara::crypto::crypt::MsgRecoveryPublicCtx::SetKey` shall ensure the provided `ara::crypto::crypt::PublicKey` is used in the following signature verification with message decoding. The interface shall return

- `kUsageViolation` error, if the allowed usage flag `kAllowVerification` of the provided `ara::crypto::crypt::PublicKey` is not set.
- `kIncompatibleObjecterror`, if the provided `ara::crypto::crypt::PublicKey` belongs to a different `ara::crypto::crypt::CryptoProvider` instance.
- `kIncompatibleObject` error, if the `ara::crypto::CryptoAlgId` of the provided `ara::crypto::crypt::PublicKey` is not compatible with the `ara::crypto::CryptoAlgId` used to instantiate this context.

](RS_CRYPT_02207)

[SWS_CRYPT_02415]{DRAFT} **Pre-hashed signing** [The interfaces `ara::crypto::crypt::SignerPrivateCtx::SignPreHashed` and `ara::crypto::crypt::SignerPrivateCtx::SignPreHashed` shall implement the signing algorithm configured for this context without hashing. Note: hashing has already been applied by the user. Both interfaces shall return

- `kProcessingNotFinished` , if a `ara::crypto::crypt::HashFunctionCtx` has been supplied and the hash value computation has not been finished.
- `kUninitializedContext` , if `ara::crypto::crypt::SignerPrivateCtx::SetKey` was not called before.
- `kInvalidInputSize` , if the supplied `ara::crypto::ReadOnlyMemRegion` parameter, `hashValue` or `context` is incompatible with the configured signature algorithm.
- `kInvalidArgument` , if the `ara::crypto::CryptoAlgId` of the provided `ara::crypto::crypt::HashFunctionCtx` or the directly provided `ara::crypto::CryptoAlgId` is incompatible with the configured signature algorithm.

](RS_CRYPT_02204)

[SWS_CRYPT_02416]{DRAFT} **Signing** [The interface `ara::crypto::crypt::SignerPrivateCtx::Sign` shall implement the signing algorithm configured for this context. The interface shall return

- `kUninitializedContext`, if `ara::crypto::cryp::SignerPrivateCtx::SetKey` was not called before.
- `kInvalidInputSize`, if a supplied `ara::crypto::ReadOnlyMemRegion` parameter's size is incompatible with the configured signature algorithm.

](RS_CRYPT_02204)

[SWS_CRYPT_02417]{DRAFT} Pre-hashed verification [The functions `ara::crypto::cryp::VerifierPublicCtx::VerifyPrehashed`, `ara::crypto::cryp::VerifierPublicCtx::VerifyPrehashed` and `ara::crypto::cryp::VerifierPublicCtx::VerifyPrehashed` shall implement the verification algorithm configured for this context without hashing. Note: hashing has already been applied by the user. All interfaces shall return

- `kProcessingNotFinished`, if a `ara::crypto::cryp::HashFunctionCtx` has been supplied and the hash value computation has not been finished.
- `kUninitializedContext`, if `ara::crypto::cryp::VerifierPublicCtx::SetKey` was not called before.
- `kInvalidInputSize`, if the supplied `ara::crypto::ReadOnlyMemRegion` parameter `hashValue` or `context` or `signature` is incompatible with the configured signature algorithm.
- `kInvalidArgument`, if the `ara::crypto::CryptoAlgId` of the provided `ara::crypto::cryp::HashFunctionCtx` or the directly provided `ara::crypto::CryptoAlgId` is incompatible with the configured signature algorithm.
- `kIncompatibleObject`, if the `ara::crypto::CryptoAlgId` of this context does not match the `ara::crypto::CryptoAlgId` of signature; or the required `ara::crypto::CryptoAlgId` of the hash is not `kAlgIdDefault` and the required hash `ara::crypto::CryptoAlgId` of this context does not match `hashAlgId` or the hash `ara::crypto::CryptoAlgId` of signature.
- `kIncompatibleArguments`, if the provided hash `ara::crypto::CryptoAlgId` is not `kAlgIdDefault` and the `ara::crypto::CryptoAlgId` of the provided signature object does not match the provided hash `ara::crypto::CryptoAlgId`.
- `kBadObjectReference`, if the provided signature object does not reference the public key loaded to the context, i.e. if the COUID of the public key in the context is not equal to the COUID referenced from the signature object.

](RS_CRYPT_02204)

[SWS_CRYPT_02418]{DRAFT} Truncation of hash value [The functions `ara::crypto::cryp::VerifierPublicCtx::VerifyPrehashed` and `ara::crypto::cryp::SignerPrivateCtx::SignPreHashed` shall truncate the provided hash value, if the bitlength of the provided hash value is larger than the bitlength

used for signing/verification or if the configured algorithm `ara::crypto::CryptoAlgId` used to instantiate this context) allows the use of a hash-value with the provided bitlength and specifies a truncation.](RS_CRYPT_02204)

[SWS_CRYPT_02419]{DRAFT} Signing [The interface `ara::crypto::crypt::VerifierPublicCtx::Verify` shall implement the verification algorithm configured for this context. The interface shall return

- `kUninitializedContext`, if `ara::crypto::crypt::VerifierPublicCtx::SetKey` was not called before.
- `kInvalidInputSize`, if a supplied `ara::crypto::ReadOnlyMemRegion` parameter's size is incompatible with the configured signature algorithm.

](RS_CRYPT_02204)

[SWS_CRYPT_02421]{DRAFT} [The interface `ara::crypto::crypt::MsgRecoveryPublicCtx::DecodeAndVerify` shall decode the message from the provided signature and return the message after successful verification according to the configured context `ara::crypto::CryptoAlgId`.](RS_CRYPT_02204)

Note: algorithms that compute a signature over a short message allow to embed the message inside of the signature. Similarly, the reverse algorithms first decode the message and return it only after successful verification.

[SWS_CRYPT_02420]{DRAFT} [The interface `ara::crypto::crypt::SigEncodePrivateCtx::SignAndEncode` shall sign the provided input buffer (message) and encode the message into the generated signature according to the algorithm configured for this context. The interface shall return this signature with encoded message as a vector of bytes or

- `kInvalidInputSize`, if the provided message data is larger than allowed by the configured context `ara::crypto::CryptoAlgId`.
- `kUninitializedContext`, if `ara::crypto::crypt::SigEncodePrivateCtx::SetKey` has not been called before.

](RS_CRYPT_02204)

[SWS_CRYPT_40984]{DRAFT} [The interface `ara::crypto::crypt::SigEncodePrivateCtx::GetMaxInputSize` shall return the maximum byte-length of the message that can be signed while also encoding it into the generated signature. If the provided parameter `suppressPadding` equals TRUE, only the number of Bytes available for the message shall be returned. If `suppressPadding` equals FALSE, the returned number shall equal the supported block size.](RS_CRYPT_02309)

[SWS_CRYPT_02422]{DRAFT} [The interface `ara::crypto::crypt::MsgRecoveryPublicCtx::DecodeAndVerify` shall decode the message from the provided signature and return the message only after successful verification according to the algorithm configured for this context. The interface shall return

- `kInvalidInputSize`, if the provided signature data is incomplete. Note: the configured context `ara::crypto::CryptoAlgId` expects more data than provided.
- `kUninitializedContext`, if `ara::crypto::crypt::MsgRecoveryPublicCtx::SetKey` has not been called before.
- `kAuthTagNotValid`, if decoded message could not be verified.

](RS_CRYPT_02204)

The context is generated with an algorithm identifier as specified in chapter 7.5.

7.4.1.9 Asymmetric encryption

Asymmetric encryption, asymmetric cryptography, or public key cryptography is a system, which is based on a pair of keys, public key and private key. As the name suggest, a public key can be distributed public to everyone without losing secrecy. Instead, a private key must be kept secret. Compared to symmetric cryptography, every user, who possesses the public key, can encrypt information, but only the user with the private key can decrypt the information.

[SWS_CRYPT_02700]{DRAFT} Separation of asymmetric transformation directions [The `ara::crypto::crypt::EncryptorPublicCtx` shall implement the asymmetric encryption operation of a `Plaintext` to a `Ciphertext`. The `ara::crypto::crypt::DecryptorPrivateCtx` shall implement the asymmetric decryption operation of a `Ciphertext` to a `Plaintext`. It shall be possible to use both contexts independently.] (RS_CRYPT_02202)

The separation of the encryption and decryption context allows an application or `Functional Cluster` to encrypt or decrypt independently based on their needs. When an application or `Functional Cluster` need both, encryption and decryption, it has to setup both contexts.

[SWS_CRYPT_02701]{DRAFT} Creation of DecryptorPrivateCtx and EncryptorPublicCtx [The interface `ara::crypto::crypt::CryptoProvider::CreateDecryptorPrivateCtx` shall return an instance of `ara::crypto::crypt::DecryptorPrivateCtx` implementing the algorithm specified by the provided parameter `ara::crypto::CryptoAlgId`. The interface shall return

- `kUnknownIdentifier`, if the provided `ara::crypto::CryptoAlgId` is not supported.
- `kInvalidArgument`, if the provided `ara::crypto::CryptoAlgId` is supported but does not refer asymmetric decryption hashing.

](RS_CRYPT_02202)

The `ara::crypto::CryptoAlgId` is the implementation specific identifier that represents the algorithm name, as described in chapter 7.5. With this identifier the context

is setup matching the asymmetric algorithm. Here, the setup can influence the organization of the cryptographic material, the provided internal buffers for keys, input, or output data and the buffers length. Some asymmetric cryptographic algorithms need specific initialization parameters. All the specific needs of an asymmetric algorithm, the corresponding standards gives detailed insights how to setup internally the `Crypto Provider` and its supported `Cryptographic primitives`.

The `Key Storage Provider` generates and manages the key as described in chapter 7.4.2.2. The key can either be generated or configured in the context of the application or `Functional Cluster`. When the `FC Crypto` provides the context no key is given. The application or `Functional Cluster` will provide the key. The key itself contains also the encoding as an attribute and will not provided by the application or `Functional Cluster` in the call of the `CryptoAPI` method.

[SWS_CRYPT_02702]{DRAFT} [The `ara::crypto::cryp::EncryptorPublicCtx::SetKey` shall check the allowed-usage flags of the key parameter provided. If `kAllowDataEncryption` is not set, a `kUsageViolation` error shall be returned.

]([RS_CRYPT_02202](#))

[SWS_CRYPT_02703]{DRAFT} [The `ara::crypto::cryp::DecryptorPrivateCtx::SetKey` shall check the allowed-usage flags of the key parameter provided. If `kAllowDataDecryption` is not set, a `kUsageViolation` error shall be returned.]

([RS_CRYPT_02202](#))

[SWS_CRYPT_02704]{DRAFT} **Encrypting** [The interfaces `ara::crypto::cryp::EncryptorPublicCtx::ProcessBlock`, `ara::crypto::cryp::EncryptorPublicCtx::ProcessBlock` shall execute the encryption operation using the deployed public key.]([RS_CRYPT_02202](#))

[SWS_CRYPT_02705]{DRAFT} **Decrypting** [The interface `ara::crypto::cryp::DecryptorPrivateCtx::ProcessBlock`, `ara::crypto::cryp::DecryptorPrivateCtx::ProcessBlock` shall execute the decryption operation using the deployed public key.]([RS_CRYPT_02202](#))

[SWS_CRYPT_02706]{DRAFT} [If the parameter `suppressPadding` is set to `FALSE`, the interface `ara::crypto::cryp::EncryptorPublicCtx::ProcessBlock` shall add padding as specified by the `ara::crypto::CryptoAlgId`. If the parameter `suppressPadding` is set to `TRUE`, the interface `ara::crypto::cryp::EncryptorPublicCtx::ProcessBlock` shall not add any padding.]([RS_CRYPT_02202](#))

If a padding shall be applied or how the padding layout looks like, this is encoded in the common name, as described in chapter 7.5.

[SWS_CRYPT_02726]{DRAFT} **Errors of ProcessBlock** [The functions `ara::crypto::cryp::DecryptorPrivateCtx::ProcessBlock`, `ara::crypto::cryp::DecryptorPrivateCtx::ProcessBlock` shall return

- `kUninitializedContext` error, if `ara::crypto::cryp::EncryptorPublicCtx::SetKey` was not called before.

- `kInvalidInputSize` error, if `suppressPadding` is set to `TRUE` and the user provided insufficient data.

](RS_CRYPT_02202)

7.4.1.10 Key Encapsulation Mechanism (KEM)

Briefly, a key encapsulation mechanism (KEM) works just like a public-key encryption scheme, except that the encryption algorithm takes no input other than another key. Therefore, the KEM uses randomly generated `Key Material`, the key encryption key (KEK), to encapsulate an input, in this situation a key. The input is encapsulated with an encryption with a target public key, as given in [26], [27], and [28]. The KEK can be derived from the encapsulated `Key Material` or from randomly generated data by application of a `KDF`.

[SWS_CRYPT_03000]{DRAFT} Keying-Data [The interface `ara::crypto::-cryp::KeyEncapsulatorPublicCtx::AddKeyingData` shall set the provided `ara::crypto::cryp::RestrictedUseObject` as payload to be encapsulated (keying-data). The interface shall return

- `kUsageViolation`, if the allowed usage flag `kAllowExport` of the provided `ara::crypto::cryp::RestrictedUseObject` is not set.
- `kIncompatibleObject`, if the provided `ara::crypto::cryp::RestrictedUseObject` belongs to a different `ara::crypto::cryp::CryptoProvider` instance.
- `kInvalidInputSize`, if the size of the provided `ara::crypto::cryp::-RestrictedUseObject` is not supported by the configured `ara::crypto::-:CryptoAlgId` of this context.

](RS_CRYPT_02209)

[SWS_CRYPT_03002]{DRAFT} Encapsulation [The interface `ara::crypto::-:cryp::KeyEncapsulatorPublicCtx::Encapsulate` shall execute key-encapsulation according to the configured `ara::crypto::CryptoAlgId` of this context. If the context allows specifying the used key-derivation function and/or the key-encapsulation-key (KEK) primitive, the interface shall override the initial context configuration with the provided `ara::crypto::cryp::KeyDerivationFunctionCtx` and `ara::crypto::CryptoAlgId`. The interface shall return a byte-vector containing the encapsulated keying-data or

- `kUninitializedContext`, if `ara::crypto::cryp::KeyEncapsulatorPublicCtx::SetKey` and `ara::crypto::cryp::KeyEncapsulatorPublicCtx::AddKeyingData` have not been called successfully before.
- `kInvalidArgument`, if the provided `ara::crypto::cryp::KeyDerivationFunctionCtx` or `ara::crypto::CryptoAlgId` are incompatible with the configured `ara::crypto::CryptoAlgId` of this context.

](RS_CRYPT_02209)

[SWS_CRYPT_03003]{DRAFT} Key Decapsulation [The interface `ara::crypto::KeyDecapsulatorPrivateCtx::DecapsulateKey` shall execute key-decapsulation on the provided `ara::crypto::ReadOnlyMemRegion` according to the configured `ara::crypto::CryptoAlgId` of this context. If the context allows specifying the used key-derivation function and/or the key-encapsulation-key (KEK) primitive, the interface shall override the initial context configuration with the provided `ara::crypto::cryp::KeyDerivationFunctionCtx` and `ara::crypto::CryptoAlgId` (`kekAlgId`). The interface shall return a non-exportable, non-storable instance of `ara::crypto::cryp::SymmetricKey` representing the decapsulated keying-data with usage restrictions set according to the provided `ara::crypto::AllowedUsageFlags` or `kAllowKdfMaterialAnyUsage`, if `ara::crypto::AllowedUsageFlags` are not provided. The returned object's `ara::crypto::CryptoAlgId` shall be set to the provided `ara::crypto::CryptoAlgId` (`keyingDataAlgId`). The interface shall return

- `kUninitializedContext`, if `ara::crypto::cryp::KeyEncapsulatorPublicCtx::SetKey` has not been called successfully before.
- `kInvalidArgument`, if the provided `ara::crypto::cryp::KeyDerivationFunctionCtx` or `ara::crypto::CryptoAlgId` are incompatible with the configured `ara::crypto::CryptoAlgId` of this context.
- `kInvalidInputSize`, if the size of the provided `ara::crypto::ReadOnlyMemRegion` is not supported by the configured `ara::crypto::CryptoAlgId` of this context.

](RS_CRYPT_02209)

[SWS_CRYPT_03004]{DRAFT} Seed Decapsulation [The interface `ara::crypto::cryp::KeyDecapsulatorPrivateCtx::DecapsulateSeed` shall execute key-decapsulation on the provided `ara::crypto::ReadOnlyMemRegion` according to the configured `ara::crypto::CryptoAlgId` of this context. The interface shall return a non-exportable, non-storable instance of `ara::crypto::cryp::SecretSeed` representing the decapsulated keying-data with usage restrictions set according to the provided `ara::crypto::AllowedUsageFlags` or `kAllowKdfMaterialAnyUsage`, if `ara::crypto::AllowedUsageFlags` are not provided. The returned object's `ara::crypto::CryptoAlgId` shall be set to the `ara::crypto::CryptoAlgId` of this context. The interface shall return

- `kUninitializedContext`, if `ara::crypto::cryp::KeyEncapsulatorPublicCtx::SetKey` has not been called successfully before.
- `kInvalidInputSize`, if the size of the provided `ara::crypto::ReadOnlyMemRegion` is not supported by the configured `ara::crypto::CryptoAlgId` of this context.

](RS_CRYPT_02209)

[SWS_CRYPT_03005]{DRAFT} [The interface `ara::crypto::cryp::KeyDecapsulatorPrivateCtx::SetKey` shall ensure the provided `ara::crypto::cryp::PrivateKey` is used in the following key decapsulation. The interface shall return

- `kUsageViolation`, if the allowed usage flag `kAllowKeyImporting` of the provided `ara::crypto::cryp::PrivateKey` is not set.
- `kIncompatibleObject`, if the provided `ara::crypto::cryp::PrivateKey` belongs to a different `ara::crypto::cryp::CryptoProvider` instance.
- `kIncompatibleObject`, if the `ara::crypto::CryptoAlgId` of the provided `ara::crypto::cryp::PrivateKey` is not compatible with the `ara::crypto::CryptoAlgId` used to instantiate this context.

]([RS_CRYPT_02209](#))

[SWS_CRYPT_03006]{DRAFT} [The interface `ara::crypto::cryp::KeyEncapsulatorPublicCtx::SetKey` shall ensure the provided `ara::crypto::cryp::PublicKey` is used in the following key encapsulation. The interface shall return

- `kUsageViolation`, if the allowed usage flag `kAllowKeyExporting` of the provided `ara::crypto::cryp::PublicKey` is not set.
- `kIncompatibleObject`, if the provided `ara::crypto::cryp::PublicKey` belongs to a different `ara::crypto::cryp::CryptoProvider` instance.
- `kIncompatibleObject`, if the `ara::crypto::CryptoAlgId` of the provided `ara::crypto::cryp::PublicKey` is not compatible with the `ara::crypto::CryptoAlgId` used to instantiate this context.

]([RS_CRYPT_02209](#))

[SWS_CRYPT_03007]{DRAFT} [The interfaces `ara::crypto::cryp::KeyEncapsulatorPublicCtx::GetKekEntropy` and `ara::crypto::cryp::KeyDecapsulatorPrivateCtx::GetKekEntropy` shall return the entropy of the key encapsulation key (KEK) in bits, if a KEK is available or the expected entropy can be computed before KEK generation. The interfaces shall return 0 otherwise.]([RS_CRYPT_02209](#))

[SWS_CRYPT_03008]{DRAFT} [The interfaces `ara::crypto::cryp::KeyEncapsulatorPublicCtx::GetEncapsulatedSize` and `ara::crypto::cryp::KeyDecapsulatorPrivateCtx::GetEncapsulatedSize` shall return the size of the encapsulated keying-data in Bytes. The interfaces shall return 0, if the size is unknown at this time, because

- the configured KEM algorithm does not specify a fixed size.
- the keying-data has not been set yet (encapsulation).
- the encapsulated data has not been provided yet (decapsulation).

]([RS_CRYPT_02209](#))

[SWS_CRYPT_03009]{DRAFT} [The interfaces `ara::crypto::cryp::KeyEncapsulatorPublicCtx::GetExtensionService` and `ara::crypto::cryp::KeyDecapsulatorPrivateCtx::GetExtensionService` shall return an instance of `ara::crypto::cryp::ExtensionService` that provides information on the configuration of this context at the time the interface was called.] ([RS_CRYPT_02209](#))

7.4.1.11 Key Exchange Protocol, Key Exchange Mechanism, and Key Exchange Scheme

`Key Material` is an essential element of cryptographic algorithms. Therefore, `Key Material` must either be ephemeral (i.e. only temporary) or must be stored persistently in confidential form to ensure it is kept secret. This avoids exposure and misuse. However, there are situations when `Key Material` must be exchanged without actually transmitting the secret (key-material) itself. One example for this is secure communication using symmetric cryptography in the presence of untrusted communication networks and dynamic connections (i.e. communication partners are not known in advance). In such situations the Diffie-Hellman key exchange scheme [29] is the common used key agreement mechanism.

[SWS_CRYPT_03311]{DRAFT} **Encryption algorithm** [The `FC Crypto` shall provide an encryption algorithm, which matches the chosen public-private key pair and the key exchange schema.] ([RS_CRYPT_02101](#))

[SWS_CRYPT_03300]{DRAFT} **Ephemeral key usage** [The interface `ara::crypto::cryp::CryptoProvider::GeneratePrivateKey` shall support the generation of `ara::crypto::cryp::PrivateKey` instances of primitive types matching the `ara::crypto::CryptoAlgId` provided as part of a successful call to `ara::crypto::cryp::CryptoProvider::CreateKeyAgreementPrivateCtx`.] ([RS_CRYPT_02101](#))

Note: if a specific algorithm for key agreement is supported by the stack, then also the generation of matching key-material shall be supported to enable ephemeral usage of this scheme.

The `Key Storage Provider` generates and manages the key as described in chapter 7.4.2.2.

[SWS_CRYPT_03312]{DRAFT} **SetKey** [The interface `ara::crypto::cryp::KeyAgreementPrivateCtx::SetKey` shall ensure the provided `ara::crypto::cryp::PrivateKey` is used in the following key agreement. The interface shall return

- `kUsageViolation`, if the allowed usage flag `kAllowKeyAgreement` of the provided `ara::crypto::cryp::PrivateKey` is not set.

- `kIncompatibleObject`, if the provided `ara::crypto::cryp::PrivateKey` belongs to a different `ara::crypto::cryp::CryptoProvider` instance.
- `kIncompatibleObject`, if the `ara::crypto::CryptoAlgId` of the provided `ara::crypto::cryp::PrivateKey` is not compatible with the `ara::crypto::CryptoAlgId` used to instantiate this context.

]([RS_CRYPT_02102](#))

[SWS_CRYPT_03313]{DRAFT} [The interface `ara::crypto::cryp::KeyAgreementPrivateCtx::GetExtensionService` shall return an instance of `ara::crypto::cryp::ExtensionService` that provides information on the configuration of this context at the time the interface was called.]([RS_CRYPT_02103](#))

Key agreement requires as input the public key of the communication partner (other side). To retrieve an instance of `ara::crypto::cryp::PublicKey` representing the public key received from the communication partner, the interface `ara::crypto::cryp::CryptoProvider::ImportPublicObject` can be used. Similarly, the communication partner requires the public key of the local application. To send this public data the interface `ara::crypto::Serializable::ExportPublicly` can be used to retrieve the raw data of the public key. Each `ara::crypto::cryp::PublicKey` instance provides this interface.

While the scheme specified here is termed "key agreement", what is actually agreed (or exchanged) is a common shared secret. How this secret data is obtained and used is up to the application. Therefore, the `ara::crypto::cryp::KeyAgreementPrivateCtx` provides two dedicated interfaces to generate a shared secret used for secret seeding or as key-material.

[SWS_CRYPT_03301]{DRAFT} Seed agreement [The interface `ara::crypto::cryp::KeyAgreementPrivateCtx::AgreeSeed` shall execute the key agreement scheme specified at the creation of this context using the provided `ara::crypto::cryp::PublicKey`. The interface shall return a non-exportable, non-storable instance of `ara::crypto::cryp::SecretSeed` representing the calculated shared secret and restrict the object allowed usage according to the provided allowed usage flags or to `kAllowKdfMaterialAnyUsage`, in case allowed usage flags are not provided. The returned object's `ara::crypto::CryptoAlgId` shall be set to the `ara::crypto::CryptoAlgId` of this context. The interface shall return

- `kUninitializedContext`, if `ara::crypto::cryp::KeyAgreementPrivateCtx::SetKey` was not successfully called before.
- `kIncompatibleObject`, if the provided `ara::crypto::cryp::PublicKey` belongs to a different `ara::crypto::cryp::CryptoProvider` instance.
- `kIncompatibleObject`, if the `ara::crypto::CryptoAlgId` of the provided `ara::crypto::cryp::PublicKey` is not compatible with the `ara::crypto::CryptoAlgId` used to instantiate this context.

]([RS_CRYPT_02104](#))

[SWS_CRYPT_03302]{DRAFT} Key agreement [The interface `ara::crypto::-crypt::KeyAgreementPrivateCtx::AgreeKey` shall execute the key agreement scheme specified at the creation of this context using the provided `ara::crypto::-crypt::PublicKey` and return a non-exportable, non-storable instance of `ara::crypto::crypt::SymmetricKey`. The returned `ara::crypto::crypt::SymmetricKey` shall be restricted according to the provided allowed usage flags as well as to the provided `ara::crypto::CryptoAlgId`. The interface shall return

- `kUninitializedContext`, if `ara::crypto::crypt::KeyAgreementPrivateCtx::SetKey` was not successfully called before.
- `kIncompatibleObject`, if the provided `ara::crypto::crypt::PublicKey` belongs to a different `ara::crypto::crypt::CryptoProvider` instance.
- `kIncompatibleObject`, if the `ara::crypto::CryptoAlgId` of the provided `ara::crypto::crypt::PublicKey` is not compatible with the `ara::crypto::CryptoAlgId` used to instantiate this context.

]([RS_CRYPT_02105](#))

[SWS_CRYPT_03303]{DRAFT} Key agreement - no KDF [If the transformation specified by the `AlgId` used to create this context does not include a KDF and no `ara::crypto::crypt::KeyDerivationFunctionCtx` is explicitly provided by calling `ara::crypto::crypt::KeyAgreementPrivateCtx::SetKDF`, the interface `ara::crypto::crypt::KeyAgreementPrivateCtx::AgreeKey` and `ara::crypto::crypt::KeyAgreementPrivateCtx::AgreeSeed` shall return the calculated shared secret. Otherwise the output of key-derivation using the shared secret as input shall be returned.]([RS_CRYPT_02105](#))

[SWS_CRYPT_03304]{DRAFT} Key agreement - optional call parameters [The interface `ara::crypto::crypt::KeyAgreementPrivateCtx::AgreeKey` shall only process the optionally provided parameters `ara::crypto::ReadOnlyMemRegion Salt` and `ara::crypto::ReadOnlyMemRegion ctxLabel`, if required by the configured `ara::crypto::CryptoAlgId` of this context. If such parameters are required, but not provided, an empty value shall be used.]([RS_CRYPT_02105](#))

[SWS_CRYPT_03305]{DRAFT} Key agreement - KDF [The interface `ara::crypto::crypt::KeyAgreementPrivateCtx::SetKDF` shall configure this context to derive the final `ara::crypto::crypt::SymmetricKey` or `ara::crypto::crypt::SecretSeed` using the provided `ara::crypto::crypt::KeyDerivationFunctionCtx` from the computed shared secret.]([RS_CRYPT_02115](#))

7.4.1.12 Identification of cryptographic primitives and using one

`Cryptographic primitives` are the basic building blocks of cryptographic systems. These well-established and frequently used elements can be implemented in hardware or software. Every implementation can be independent from each other and provided by different vendors. Implementations are represented by `Crypto`

Provider. This kind of decoupling provides some negative impacts. Every vendor can choose the `Cryptographic primitives` and their names independently. Then, during development phase of application or `Functional Cluster`, it is not clear how to access the needed algorithm. Therefore, a common name is specified, which allows to develop functionality independent from `FC Crypto`. The common name of the algorithm is given in chapter 7.5. With this common name, it is possible to bind the application or function cluster to the `FC Crypto` during integration phase. However, this approaches needs both, the interface to translate the common name to a vendor specific name and the support from the `FC Crypto`.

[SWS_CRYPT_03904]{DRAFT} [The `ara::crypto::cryp::CryptoContext::GetCryptoPrimitiveId` shall return a `ara::crypto::cryp::CryptoPrimitiveId` of the current used cryptographic algorithm.] ([RS_CRYPT_02308](#))

[SWS_CRYPT_03905]{DRAFT} [The `ara::crypto::cryp::CryptoPrimitiveId::GetPrimitiveName` shall return the common name of the current used cryptographic algorithm.] ([RS_CRYPT_02308](#))

[SWS_CRYPT_03906]{DRAFT} [The `ara::crypto::cryp::CryptoPrimitiveId::GetPrimitiveId` shall return the `ara::crypto::cryp::CryptoPrimitiveId` of the current used cryptographic algorithm.] ([RS_CRYPT_02308](#))

This allows a decoupling of the vendor specific implementation and the using application. With this freedom a late binding during integration phase is realized.

[SWS_CRYPT_40985]{DRAFT} [The interface `ara::crypto::cryp::CryptoService::GetMaxInputSize` shall return the maximum byte-length of data that the cryptographic context associated with this `ara::crypto::cryp::CryptoService` expects as input for applying its cryptographic transformation. If the provided parameter `suppressPadding` equals `TRUE`, only the number of Bytes available for the payload shall be returned. If `suppressPadding` equals `FALSE`, the returned number shall equal the supported block size.] ([RS_CRYPT_02309](#))

Note, several encryption algorithms require a certain number of bytes to be added as padding to improve cryptographic properties (e.g. RSA encryption PKCS1 v1.5)

7.4.1.13 Support on internal elements (Loading, Update, Import, and Export)

[SWS_CRYPT_04200]{DRAFT} **Loading cryptographic material** [The load interfaces `ara::crypto::cryp::CryptoProvider::LoadObject`, `ara::crypto::cryp::CryptoProvider::LoadSymmetricKey`, `ara::crypto::cryp::CryptoProvider::LoadPublicKey`, `ara::crypto::cryp::CryptoProvider::LoadPrivateKey`, `ara::crypto::cryp::CryptoProvider::LoadSecretSeed` shall load the content from the location pointed to by the provided `IOInterface` and return an instance of type `CryptoObject`, `Symmetric Key`, `PublicKey`, `PrivateKey` and `SecretSeed` respectively. The load interface shall return

- `kEmptyContainer`, if the underlying resource this `IOInterface` points to is empty.
- `kResourceFault`, if the underlying resource this `IOInterface` points to is faulty.
- `kModifiedResource`, if the underlying resource has been modified after the `IOInterface` has been opened, i.e., the `IOInterface` has been invalidated.
- `kIncompatibleObject`, if the underlying resource belongs to another incompatible `CryptoProvider` or if the type of the crypto object to be returned by the respective interface does not match the type contained in the underlying resource.

]([RS_CRYPT_02105](#), [RS_CRYPT_02112](#), [RS_CRYPT_02113](#))

[SWS_CRYPT_40947]{DRAFT} [The interface `ara::crypto::IOInterface::GetAllowedUsage` shall return the allowed usage flags of the underlying `CryptoObject` this `IOInterface` points to. If the content that the `IOInterface` points to is empty, `kAllowPrototypedOnly` shall be returned.]([RS_CRYPT_02004](#))

[SWS_CRYPT_40948]{DRAFT} [The interface `ara::crypto::IOInterface::GetCapacity` shall return capacity of the underlying resource in bytes.]([RS_CRYPT_02004](#))

Note: `IOInterfaces` always point to an underlying resource to store `CryptoObjects` such as the RAM buffer of a `VolatileTrustedContainer` or the persistent memory of a `KeySlot`. In both cases the underlying resource has a maximum capacity to store a `CryptoObject` and the content may be empty.

[SWS_CRYPT_40949]{DRAFT} [The interface `ara::crypto::IOInterface::GetCryptoObjectType` shall return the `CryptoObjectType` of the underlying `CryptoObject` this `IOInterface` points to. In case the underlying resource this `IOInterface` points to is empty, `kUndefined` shall be returned.]([RS_CRYPT_02004](#))

[SWS_CRYPT_40950]{DRAFT} [The interface `ara::crypto::IOInterface::GetPayloadSize` shall return size of the underlying `CryptoObject`'s key-material this `IOInterface` points to in bytes. The interface shall return 0, if the container is empty.]([RS_CRYPT_02004](#))

[SWS_CRYPT_40951]{DRAFT} [The interface `ara::crypto::IOInterface::GetPrimitiveId` shall return the vendor specific `ara::crypto::CryptoAlgId` of the underlying `CryptoObject` this `IOInterface` points to. If the underlying resource this `IOInterface` points to is empty, `kAlgIdUndefined` shall be returned.]([RS_CRYPT_02004](#))

[SWS_CRYPT_40952]{DRAFT} [The interface `ara::crypto::IOInterface::GetTypeRestriction` shall return the `CryptoObjectType` that is allowed to be stored in the underlying resource this `IOInterface` points to. The interface shall return `kUndefined`

- if this `IOInterface` points to a `VolatileTrustedContainer`.
- if this `IOInterface` points to a `Key Slot` and the `KeySlot`'s `mAllowContent-TypeChange` flag is set to `TRUE`.

](RS_CRYPT_02004)

[SWS_CRYPT_40953]{DRAFT} [The interface `ara::crypto::IOInterface::IsObjectExportable` shall only return TRUE, if `kAllowExport` is set in the allowed usage flags of the CryptoObject stored in the underlying resource this IOInterface points to.](RS_CRYPT_02004)

[SWS_CRYPT_40954]{DRAFT} [The interface `ara::crypto::IOInterface::IsObjectSession` shall return TRUE, if the CryptoObject stored in the underlying resource this IOInterface points to is volatile and cannot be persisted (session flag set). The interface shall return FALSE, if the underlying resource this IOInterface points to

- is a `Key Slot`.
- is empty.
- is volatile but can be persisted.

](RS_CRYPT_02004)

[SWS_CRYPT_40955]{DRAFT} [The interface `ara::crypto::IOInterface::IsValid` shall only return TRUE, if the underlying resource this IOInterface points to is a `VolatileTrustedContainer` or a `KeySlot` that has not been modified since this IOInterface has been obtained by calling `ara::crypto::keys::KeySlot::Open` on the loaded `KeySlot` instance.](RS_CRYPT_02004)

[SWS_CRYPT_40956]{DRAFT} [The interface `ara::crypto::IOInterface::IsVolatile` shall only return TRUE, if this IOInterface points to a `VolatileTrustedContainer`.](RS_CRYPT_02004)

[SWS_CRYPT_40957]{DRAFT} [The interface `ara::crypto::IOInterface::IsWritable` shall only return TRUE, if this IOInterface points to a `VolatileTrustedContainer` or this IOInterface has been obtained by calling `ara::crypto::keys::KeySlot::Open` with the `writable` flag set to TRUE.](RS_CRYPT_02004)

The serialization format for exporting/importing is not yet standardized in AUTOSAR.

Therefore it is the responsibility of the platform vendor to adequately de-/serialize CryptoObjects including all relevant meta-data such that CryptoObjects can be transferred between adaptive machines (of the same vendor) without loss of information and functionality.

[SWS_CRYPT_04202]{DRAFT} Exporting secure objects [The function `ara::crypto::crypt::CryptoProvider::ExportSecuredObject` shall serialize the provided CryptoObject and apply the transformation specified by the provided `SymmetricKeyWrapperCtx`. The function shall return the serialized data as a vector of bytes or

- `kIncompatibleObject` if the object cannot be exported due to `ara::crypto::crypt::CryptoObject::IsExportable` returning FALSE.

- `kIncompleteArgState` if the provided `SymmetricKeyWrapperCtx` is not fully initialized.
- `kIncompatibleObject` if the flag `kAllowKeyExporting` of the `Symmetric Key` set in the provided `SymmetricKeyWrapperCtx` is not set to `TRUE`

]([RS_CRYPT_02004](#))

[SWS_CRYPT_04213]{DRAFT} [The function `ara::crypto::cryp::CryptoProvider::ExportSecuredObject` shall serialize the `CryptoObject` contained in the storage location pointed to by the provided `IOInterface` after applying the transformation specified by the provided `SymmetricKeyWrapperCtx`. The function shall return the serialized data as a vector of bytes or

- `kEmptyContainer` if the underlying resource this `IOInterface` points to is empty
- `kIncompleteArgState` if the provided `SymmetricKeyWrapperCtx` is not fully initialized
- `kIncompatibleObject` if the flag `kAllowKeyExporting` of the `Symmetric Key` set in the provided `SymmetricKeyWrapperCtx` is not set
- `kModifiedResource` if this `IOInterface` points to an instance of a `KeySlot` that has been modified after the `IOInterface` has been opened.

]([RS_CRYPT_02006](#))

[SWS_CRYPT_04203]{DRAFT} Exporting public objects [The function `ara::crypto::cryp::CryptoProvider::ExportPublicObject` shall serialize the `CryptoObject` contained in the storage location pointed to by the provided `IOInterface`. The function shall return the serialized data as a vector of bytes or

- `kEmptyContainer` if the underlying resource this `IOInterface` points to is empty.
- `kUnexpectedValue` if the underlying resource this `IOInterface` points contains a `RestrictedUseObject`.
- `kModifiedResource` if this `IOInterface` points to an instance of a `KeySlot` that has been modified after the `IOInterface` has been opened.

]([RS_CRYPT_02004](#))

Both `ExportSecuredObject` interfaces can export internal objects in a secure manner. This allows exchanging cryptographic objects between platforms or different applications without exposing them to third parties.

[SWS_CRYPT_40958]{DRAFT} [The function `ara::crypto::cryp::CryptoObject::IsExportable` shall only return `TRUE`, if `kAllowExport` is set in the allowed usage flags of this `CryptoObject`.]([RS_CRYPT_02006](#))

[SWS_CRYPT_04204]{DRAFT} Importing secure objects [The function `ara::crypto::crypt::CryptoProvider::ImportSecuredObject` shall unwrap securely serialized data provided by the application according to the specified `SymmetricKeyWrapperCtx`. The unwrapped `CryptoObject` shall be deserialized and saved to the persistent or volatile storage represented by the provided `IOInterface`. The function shall return

- `kUnexpectedValue` if the payload (serialized `CryptoObject`) contains invalid data (errors in the cipher-text or plain-text), or the unwrapping operation failed.
- `kBadObjectType` if the contained `CryptoObject` does not match the provided `CryptoObjectType`.
- `kIncompleteArgState` if the provided `SymmetricKeyWrapperCtx` is not fully initialized.
- `kUsageViolation` if the flag `kAllowKeyImporting` of the `Symmetric Key` set in the provided `SymmetricKeyWrapperCtx` is not set to `TRUE`.
- `kInsufficientCapacity` if the capacity of the underlying resource pointed to by the provided `IOInterface` is insufficient to hold the deserialized `CryptoObject`.
- `kUnreservedResource` if the `IOInterface` is not opened writable.

]([RS_CRYPT_02004](#))

[SWS_CRYPT_04205]{DRAFT} Importing public objects [The function `ara::crypto::crypt::CryptoProvider::ImportPublicObject` shall deserialize the provided serialized data and save the contained `CryptoObject` to the persistent or volatile storage represented by the provided `IOInterface`. The function shall return

- `kUnexpectedValue` if the payload (serialized `CryptoObject` and associated meta-data) contains invalid data.
- `kBadObjectType` if the contained `CryptoObject` does not match the provided expected `CryptoObjectType`.
- `kInsufficientCapacity` if the capacity of the underlying resource pointed to by the provided `IOInterface` is insufficient to hold the deserialized `CryptoObject`.
- `kUnreservedResource` if the `IOInterface` is not opened writable.

]([RS_CRYPT_02004](#))

Vulnerability notice: using the interface `ara::crypto::crypt::CryptoProvider::ImportPublicObject` to import secret key-material without confidentiality protection is strongly discouraged.

This is an obvious attack path and may compromise security of the whole platform. It is assumed that all parties involved in such a setup are aware of the risk and implement sufficient countermeasures.

[SWS_CRYPT_04207]{DRAFT} [The function `ara::crypto::crypt::CryptoProvider::GetPayloadStorageSize` shall return the minimum required capacity of a KeySlot for storing a CryptoObject defined by the provided `ara::crypto::CryptoAlgId` and `CryptoObjectType`. The function shall return

- `kUnknownIdentifier` if the provided `ara::crypto::CryptoAlgId` is unsupported or the provided `ara::crypto::CryptoAlgId` equals `kUndefined`.
- `kIncompatibleArguments` if the provided pair of `ara::crypto::CryptoAlgId` and `CryptoObjectType` represents an unsupported combination.

]([RS_CRYPT_02004](#))

[SWS_CRYPT_04208]{DRAFT} [The function `ara::crypto::crypt::CryptoProvider::AllocVolatileContainer` shall allocate a volatile buffer with sufficient size to hold cryptographic data of the provided capacity and the meta-data associated with each CryptoObject. The function shall return an instance of `VolatileTrustedContainer` representing the allocated buffer or `kInsufficientResource`, if not enough volatile memory is available for allocation.]([RS_CRYPT_02004](#))

This type of containers could be used for execution of import operations described above.

[SWS_CRYPT_40959]{DRAFT} [The function `ara::crypto::crypt::CryptoProvider::AllocVolatileContainer` shall allocate a volatile buffer with sufficient size to hold cryptographic data and the meta-data associated with each CryptoObject. The necessary size of cryptographic data shall be computed from the provided pair of `ara::crypto::CryptoAlgId` and `CryptoObjectType`. The function shall return an instance of `VolatileTrustedContainer` representing the allocated buffer or

- `kInsufficientResource`, if not enough volatile memory is available for allocation
- `kInvalidArgument` if the provided pair of `ara::crypto::CryptoAlgId` and `CryptoObjectType` represents an unsupported combination.

]([RS_CRYPT_02004](#))

[SWS_CRYPT_04209]{DRAFT} [The `CryptoAPI` shall document all importing or exporting by a logging mechanism. This information can be queried.]([RS_CRYPT_02004](#))

7.4.2 Key Storage Provider

The Key Storage Provider (`KSP`, namespace `ara::crypto::keys`) is responsible for secure (confidential and or authentic) storage of different type `Key Material` (public, private, secret keys, or seeds) and other security critical cryptographic objects (digital

signatures, hash, MAC HMAC tags). These cryptographic objects are represented as a *Key Slots*.

Key Slots used by application are defined by the integrator in the manifest via *CryptoKeySlot*.

CryptoKeySlotInterface and *CryptoKeySlotToPortPrototypeMapping*

[SWS_CRYPT_10000]{DRAFT} [The FC Crypto shall provide access to the *CryptoKeySlots* for every *AdaptiveApplicationSwComponentType*. Every *CryptoKeySlot* is represented by *RPortPrototype* typed by *CryptoKeySlotInterface* in application design.](*RS_CRYPT_02004*, *RS_CRYPT_02305*)

Assignment of *CryptoKeySlots* to a *CryptoProvider* is described in the manifest. So with the usage of a *RPortPrototype* that is typed by a *CryptoKeySlotInterface* the assignment to *CryptoProvider* is established.

[SWS_CRYPT_10003]{DRAFT} [The *CryptoAPI* shall provide a function to obtain *Crypto Provider*. With a call of `ara::crypto::crypt::CryptoContext::MyProvider` the FC Crypto provides the corresponding *Crypto Provider* of a *Key Slot*.](*RS_CRYPT_02009*)

The manifest contains separate deployment data for each *Process*. The class *CryptoKeySlotToPortPrototypeMapping* defines the mapping between a *Process*, a *CryptoKeySlot*, and an *RPortPrototype*. Furthermore, the class *CryptoProviderToPortPrototypeMapping* defines the mapping between a *Process*, a *CryptoProvider*, and an *RPortPrototype*. Figure 7.7 shows the relevant model elements. Additional model elements and links are only shown for context.

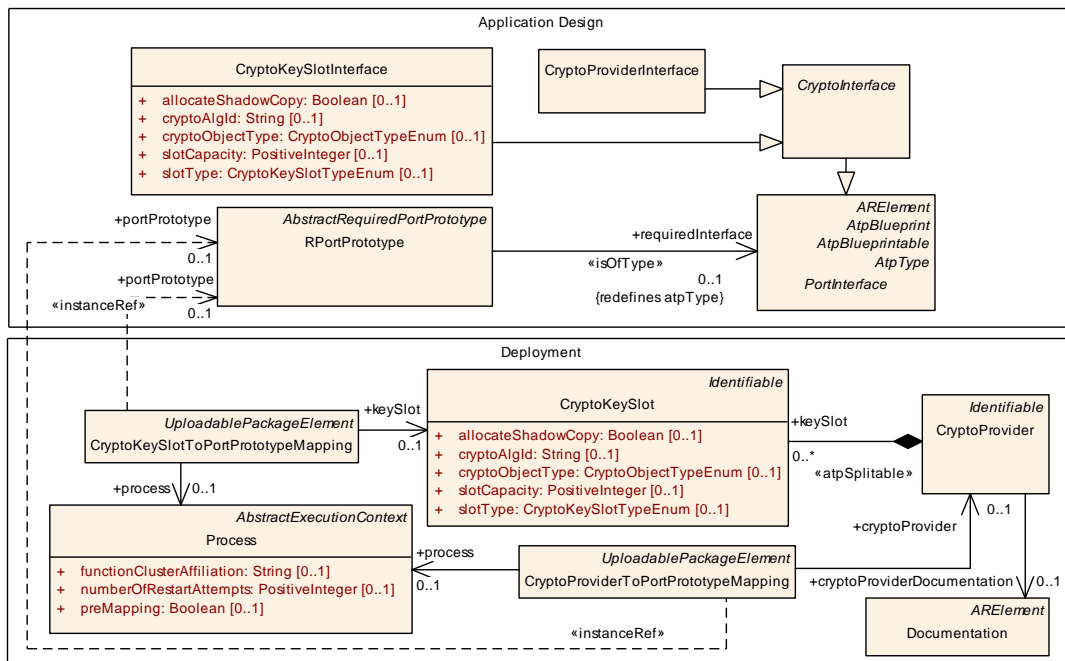

Figure 7.7: Key deployment

[SWS_CRYPT_10005]{DRAFT} [The `Key Slot` shall be identified during runtime. The `CryptoAPI` provides an interface with a call to `ara::crypto::keys::KeyStorageProvider::LoadKeySlot` to support this. The interface needs an `ara::core::InstanceSpecifier` as an input parameter. Here, `ara::core::InstanceSpecifier` represents a path to `RPortPrototype` mapped to needed `CryptoKeySlot`.] ([RS_CRYPT_02405](#))

`CryptoAPI` consumers work with logically single `KSP` that is used for access to all cryptographic objects independently from their physical hosting on the `ECU`. However, from the stack supplier point of view, each `HSM` may support own back-end `KSP` responsible for access control to internally stored cryptographic objects. All back-end `KSP` are hidden from the consumers (under public `CryptoAPI`).

[SWS_CRYPT_10004]{DRAFT} [The `FC Crypto` shall ensure confidentiality and authenticity of processed and stored objects with a correct `KSP` implementation (similar to Classic Platform). Thus, its implementation shall be isolated from the consumers' code space.] ([RS_CRYPT_02008](#), [RS_CRYPT_02009](#), [RS_CRYPT_02106](#))

The "Key Management" functionality is split into four parts:

1. Key Storage Provider API (namespace `crypto::keys`).
2. Certificate Management Provider API completely (namespace `crypto::x509`).
3. Key Material Generation, Secured Export, Public/Secured Import and auxiliary API (via methods of `crypto::crypt::CryptoProvider` interface). These methods represent all actions that need implementation of cryptographic transformations of keys. The usage of `HSM` is implemented in hardware and thus may not support all APIs as software solutions would.
4. Generic serialization of public cryptographic objects (via `crypto::Serializable` interface). Taking into account the deep dependence of 3rd category of the "Key Management" sub-API from other cryptographic functionality, possibility to reuse some functional blocks (including mechanisms of access control to `Key Material` in `HSM` realms), there is no practical sense to separate this sub-API from `Crypto Provider API`.

Key Storage & Certificate Management are realized by separated interfaces, because they can be implemented completely independent. This allows to combine both provided by different vendors.

7.4.2.1 Serializable interface

[SWS_CRYPT_10200]{DRAFT} [The `CryptoAPI` shall provide an interfaces `ara::crypto::Serializable::ExportPublicly`, `ara::crypto::Serializable::ExportPublicly` for exporting of any public (by nature) objects, where additional integrity or confidentiality protection are not needed.] ([RS_CRYPT_02112](#))

Interfaces of all public (non-confidential) cryptographic objects and certificates that principally support serialization in plain (non-encrypted and non-authenticated) form are derived from the `ara::crypto::Serializable` interface.

Actually, this interface provides only one serialization method `formatId`.

7.4.2.2 Key Generation

Key Generation is the process of generating cryptographic keys. There are two types of Key Generation based on the used cryptographic algorithms:

1. Symmetric Algorithms: A symmetric system consists of a key, which is shared between the different parties.

[SWS_CRYPT_10300]{DRAFT} Symmetric cryptography [The `FC Crypto` shall support symmetric cryptography.] ([RS_CRYPT_02101](#)).

[SWS_CRYPT_10301]{DRAFT} [The `FC Crypto` shall allocate a new `Symmetric Key` object by a call of function `ara::crypto::crypt::CryptoProvider::GenerateSymmetricKey` and fill it by a new randomly generated value. The function shall return

- `kUnknownIdentifier` error, if the `ara::crypto::CryptoAlgId` has an unsupported value.
- `kIncompatibleArguments` error, if `allowedUsage` is incompatible with target algorithm specified by `ara::crypto::CryptoAlgId`.

] ([RS_CRYPT_02101](#)).

2. Asymmetric Algorithms: Asymmetric systems consist of public and private key, which are generated. The public key is used for encryption, key encapsulation, or signature verification. The private key is used for decryption, key encapsulation, key exchange, or digital signature calculation.

[SWS_CRYPT_10303]{DRAFT} Asymmetric cryptography [The `FC Crypto` shall support asymmetric cryptography.] ([RS_CRYPT_02101](#)).

[SWS_CRYPT_10304]{DRAFT} [The `FC Crypto` shall support the `Asymmetric Key` generation. The `CryptoAPI` provide such functionality. The private key is generated by calling `ara::crypto::crypt::CryptoProvider::GeneratePrivateKey`.] ([RS_CRYPT_02101](#))

[SWS_CRYPT_10305]{DRAFT} [The corresponding public key can be obtained from a private key object by `ara::crypto::crypt::PrivateKey::GetPublicKey`. This function is part of the `CryptoAPI`.] ([RS_CRYPT_02002](#))

[SWS_CRYPT_10306]{DRAFT} [As private and public key are tightly coupled which each other, they should have the same `COUID`. A common `COUID` shall be shared for both private and public keys.] ([RS_CRYPT_02005](#))

7.4.2.3 Exporting and Importing of Key Material

Exporting of [Key Material](#) is sometimes necessary. This is useful during the setup of communication channels, for example. Importing [Key Material](#) is also important for a later use. Export and Import facilities of [Crypto Provider](#) are described in [7.4.1.13](#).

Another use case to export and import [Key Material](#) is the confidential delivery of [Symmetric Keys](#), e.g., transport keys. This technique is called data encapsulation mechanism and provides a "crypto envelope" or "digital envelope" that protects the secrecy and integrity of data using symmetric-key cryptographic techniques concept. The [FC Crypto](#) provides two contexts, [ara::crypto::cryp::KeyAgreementPrivateCtx](#) and [ara::crypto::cryp::KeyEncapsulatorPublicCtx](#), which implements the data encapsulation mechanism. Additionally, it is possible to assure non-repudiation by adding a digital signature. This is provided via the [ara::crypto::cryp::HashFunctionCtx](#) and [ara::crypto::cryp::SignerPrivateCtx](#). All contexts contains two building blocks:

- The encryption algorithm
- The decryption algorithm

[SWS_CRYPT_10403]{DRAFT} [The [FC Crypto](#) shall provide private key agreement functionality by a specific context. This context is the [ara::crypto::cryp::KeyAgreementPrivateCtx](#). The [CryptoAPI](#) generates this context via an interface. This interface needs an identifier of the target key-agreement cryptographic algorithm to setup the correct context.] ([RS_CRYPT_02105](#))

[SWS_CRYPT_10401]{DRAFT} [Key agreement private context shall provide functionality to produce a common secret seed [ara::crypto::cryp::SecretSeed](#).]
([RS_CRYPT_02007](#))

[SWS_CRYPT_10402]{DRAFT} [Key agreement private context shall provide functionality to produce a common symmetric key.] ([RS_CRYPT_02103](#))

7.4.3 Certificate handling (X.509 Provider)

[X.509 Certificate Management Provider](#) ([X.509 Provider](#)) is responsible for [X.509](#) certificates parsing, verification, authentic storage and local searching by different attributes. In addition, [X.509 Provider](#) is responsible for storage, management, and processing of Certificate Revocation Lists ([CRLs](#)) and Delta [CRLs](#). The [X.509 Provider](#) supports the preparation of requests, responses, and parsing according to the Online Certificate Status Protocol ([OCSP](#)) as defined in [\[30\]](#) and [\[31\]](#).

[SWS_CRYPT_20000]{DRAFT} [[FC Crypto](#) supports only a single instance of the [ara::crypto::x509::X509Provider](#). As the [X.509 Provider](#) is completely

independent from `ara::crypto::crypt::CryptoProvider` and `ara::crypto::keys::KeyStorageProvider` implementation details, it is possible that different vendors provide `X.509 Provider` and `Crypto Provider / Key Storage Provider`. Therefore, the standardized `CryptoAPI` guarantees interoperability between these independent building blocks. Applications or `Functional Clusters` can access certificates by `CryptoCertificateInterface`, which is provided by `X.509 Provider`.] ([RS_CRYPT_02307](#))

Any `FC Crypto` implementation shall include a single `X.509 Provider`. Responsibility of this provider is the support of Public Key Infrastructure (`PKI`) as defined in [32]. A `PKI` contains a root certificate and one or many certificates. Main feature are:

1. Storages of certificates, certification signing requests (`CSRs`), and certificate revocation lists (`CRLs`).
2. Complete parsing of `X.509` certificates and certificate signing requests (`CSR`).
3. Encoding of all public components of certificate signing requests (e.g. Distinguished Names and `X.509` Extensions).
4. Verification of certificates and certification chains (according to current set of trusted certificates).
5. Trust management of the stored certificates.
6. Search of certificates in local storage based on different parameters.
7. Automatic building of the trust chains according to saved certificates, `CRLs`, and trust configuration.

[**SWS_CRYPT_20001**]{DRAFT} [The `CryptoAPI` provides a secure local access to specific information. The minimal information, which shall be accessible, are the specific system name, the private key, which is associated with the caller, the name of the `CA`, which is used as a trust authority, and the `ara::crypto::x509::X509PublicKeyInfo` (or a fingerprint of the public key where a self-certified version is available elsewhere).] ([RS_CRYPT_02306](#))

[**SWS_CRYPT_20002**]{DRAFT} [The `ara::crypto::x509::X509Provider` shall store and provide the root `ara::crypto::x509::Certificate` and all needed `CAs` along the `certification path`, together with the reference to the corresponding public and private keys, which are handled by the `ara::crypto::keys::KeyStorageProvider`. All elements, which are relevant for the `certification path`, shall be stored with local access either hard-coded into the software or in a persistent and tamper-proof manner. The decision how to store the elements is based on:

- **Updatability of certificates:** When certificates shall be exchangeable or revocable, then these are stored in a volatile but persistent storage. Fixed certificates, which stay forever for example, can be stored hard-coded.

- Use case specific: An application or [Functional Cluster](#) can have pre-configured certificates, which are stored along side the configuration, e.g. in ARXML.
- Project specific

]([RS_CRYPTO_02306](#))

[SWS_CRYPT_20003]{DRAFT} [The [FC Crypto](#) shall provide all cryptographic algorithms to generate, validate, and process certificates, which are used in the system. Depending on the certificate the [X.509 Provider](#) uses the corresponding [Crypto Provider](#). However, the [X.509 Provider](#) can either directly access the cryptographic algorithm or use the exposed interfaces provided by the [CryptoAPI](#).] ([RS_CRYPTO_02204](#), [RS_CRYPTO_02306](#))

[SWS_CRYPT_20004]{DRAFT} [The [X.509 Provider](#) shall support [ASN.1](#) parsing. Thus it provides an [ASN.1](#) parser to read the specific syntax of [X.509](#) certificates. Typical [X.509](#) certificates must follow the definition given in [[32](#)] and [[33](#), RFC 5280]:

1. Certificate

- (a) Version Number
- (b) [ara::crypto::x509::Certificate::SerialNumber](#)
- (c) Signature Algorithm ID
- (d) [ara::crypto::x509::Certificate::IssuerDn](#)
- (e) Validity period
 - i. [ara::crypto::x509::Certificate::StartTime](#)
 - ii. [ara::crypto::x509::Certificate::EndTime](#)
- (f) [ara::crypto::x509::BasicCertInfo::SubjectDn](#)
- (g) Subject Public Key Info
 - i. Public Key Algorithm
 - ii. Subject Public Key
- (h) Issuer Unique Identifier (optional)
- (i) Subject Unique Identifier (optional)
- (j) Extensions (optional)

2. Certificate Signature Algorithm

3. Certificate Signature

Theses certificates are described by [CryptoServiceCertificate](#) with all elements.]([RS_CRYPTO_02306](#))

The `X.509 Provider` parses certificates when an application or `Functional Cluster` uses the `CryptoAPI` interfaces for importing, storing, or verifying of CSRs and certificates. This can be problematic when cross-certification or cross-signing is used. Cross-certification allows to trust one entity in another PKI. Here, one part of the PKI tree signs a part of another PKI tree and vice versa. The `X.509 Provider` shall handle this cross-signing in a correct manner, transparent for the application or `Functional Cluster`.

[SWS_CRYPT_20005]{DRAFT} Freedom of interference during update [It must be possible to regularly update any key pair of certificates, which are part of a PKI tree, without affecting any other key pair of related certificates, which can be also part of the same PKI tree or part of an independent tree.]([RS_CRYPTO_02112](#), [RS_CRYPTO_02306](#))

[SWS_CRYPT_20006]{DRAFT} [The `X.509 Provider` shall generate certificates, so called self-signed certificates, and CSRs based on standardized cryptographic algorithms. A specific algorithm can be chosen by the application or the `Functional Cluster` in the generation call. It shall be ensured that the `Crypto Provider` exposes the needed algorithms. During the CSR generation a key pair, public and private key, is generated as well. These keys are stored, by the `Key Storage Provider`. Therefore, the `X.509 Provider` shall use either internally or via exposed interfaces the functionality of the `Key Storage Provider` to create, store, and manage the keys.]([RS_CRYPTO_02306](#))

`X.509 Provider` supports two variants of long-term storage types:

1. "Persistent" storage is dedicated for `X.509` artifacts that should survive after ECU restart / shutdown.
2. "Volatile" (or "Session") is dedicated for `X.509` artifacts, that are valuable only in scope of current session of an application or `Functional Cluster`, importing these artifacts to the storage.

[SWS_CRYPT_20007]{DRAFT} [The `X.509 Provider` shall store issued certificates in a persistent manner.]([RS_CRYPTO_02306](#))

[SWS_CRYPT_20009]{DRAFT} [When a certificates expires, the `X.509 Provider` shall replace the certificate with a new certificate. Additionally, the `X.509 Provider` may add the certificate on revocation list. The `X.509 Provider` shall update the internal state to reflect this change.]([RS_CRYPTO_02306](#))

[SWS_CRYPT_20010]{DRAFT} [`X.509 Provider` implementation shall require especial capability "Trust Master" from applications that will set specific certificate as a root of trust `ara::crypto::x509::X509Provider::SetAsRootOfTrust`.]([RS_CRYPTO_02306](#))

[SWS_CRYPT_20011]{DRAFT} [`X.509 Provider` shall support the Proof-Of-Possession (POP) of the private key.]([RS_CRYPTO_02306](#))

[SWS_CRYPT_40943]{DRAFT} [The functions `ara::crypto::x509::X509Provider::ParseCustomCertExtensions`, `ara::crypto::x509::X509Provider::ParseCustomCertExtensions` shall parse the extension identified by the parameter oid of the provided Certificate and call the functions of the provided callback class `customExtensionsParser` in the order of occurrence of the ASN.1 elements in the parsed certificate. If the parameter oid is not given, then `ParseCustomCertExtensions` shall parse all extensions of the certificate.

- If the parameter oid is given but the certificate does not contain an extension with the given oid, then `ParseCustomCertExtensions` shall return `CryptoErrorDomain::kUnexpectedValue`.
- If a function of the callback class `customExtensionsParser` returns any error, then `ParseCustomCertExtensions` shall stop parsing the certificate and return `CryptoErrorDomain::kRuntimeFault`.

]([RS_CRYPT_02306](#))

7.4.3.1 Certificate Signing Request

[SWS_CRYPT_20301]{DRAFT} [The `X.509 Provider` produces the Certificate Signing Request by `ara::crypto::x509::X509Provider::CreateCertSignRequest`. This is done in a specific context, which needs an identifier of the target asymmetric cryptographic algorithm and the corresponding public-private key pair. The `ara::crypto::x509::CertSignRequest` (CSR) is signed by the private key and contains the public key.]([RS_CRYPT_02306](#)) The identification of the used algorithm is done by the common name, as specified in 7.5.

The `X.509 Provider` delegates the CSR self-signature creation to the corresponding context, which is also responsible for processing of the correspondent private key.

[SWS_CRYPT_20302]{DRAFT} [`X.509 Provider` shall encode all meta-information (`Distinguished name` and `X.509 Extensions`). This meta-information is added during the CSR generation to the CSR before the signature is generated. The `Distinguished name` and `X.509 Extensions`, can be either global or locally defined. The specific context is given either during the interface call (locally defined) or specified in the configuration (global). However, the specific local settings shall overwrite the global ones during the CSR generation. If no meta-information is provided, the global ones shall be used as default.]([RS_CRYPT_02306](#))

[SWS_CRYPT_20303]{DRAFT} [All meta-information shall be encoded according to the `X.509` specification (as given in [32], [34], [35], [36], [37], [38], and [2]).]([RS_CRYPT_02306](#))

`X.509 Provider` distinguishes three states of a CSR:

1. "New" - the CSR is created, but is not yet sent to the Certification Authority (CA).

2. "Pending" - the `CSR` was already sent to the `CA`, but the internal was not yet updated. Either the `CSR` was not returned or was not processed.
3. "Retrieved" - the `CSR` was returned from the `CA`, and is either processed or the processing was not started yet.

When a signed `CSR` is retrieved, the `X.509 Provider` will import the `CSR` and starts the processing.

[SWS_CRYPT_20304]{DRAFT} [Each `CSR` is an artifact produced by the `X.509 Provider` and is stored locally. The `CryptoAPI` provides an interface to allow an application or `Functional Cluster` to trigger the storing.] (*RS_CRYPT_02306*)

7.4.3.2 Using Certificates

[SWS_CRYPT_20601]{DRAFT} Importing / Installation [The `X.509 Provider` provides a mechanism for applications or `Functional Clusters` to import `ara::crypto::x509::X509Provider::Import` or install certificates, parts of `certification paths`, or full `certification paths`.] (*RS_CRYPT_02306*)

This allows the user to integrate certificates into the system, especially when these are generated outside the system itself. Therefore, the `CryptoAPI` provides an interface to import certificates. This interface can be configured during the integration phase by using the `PortInterface`, as shown in 7.8, or the specific API call. When a certificate is imported, the `X.509 Provider` validates the certificate or the `certification paths` with the corresponding `PKI`. Additionally, the `X.509 Provider` checks if all `Distinguished names` and `X.509 Extensions` are matching the pre-configured meta-information (global information) or specified ones (local information). Specific meta-information is provided by the application or `Functional Cluster` via the interface call. If no specific meta-information is provided, the global ones are used as default. Importing can be done either via a file, which is stored on the system, or as an `ASN.1` encoded information directly. If an internal error occurred or the internal policy prohibits the importing, the caller will be informed by an error.

[SWS_CRYPT_20602]{DRAFT} Exporting [The `X.509 Provider` exports a certificate, a bundle of certificates, a part of a `certification path`, or a full `certification path`. The private key of the corresponding export is not included in the export.] (*RS_CRYPT_02306*)

The export is done in `ASN.1` encoding according to `X.509` standard. The application or `Functional Cluster` can define the certificate format, such as `BER`, `DER`, or `PEM`, and specify if the export shall be stored as file or provided directly. The used meta-information, `Distinguished name` and `X.509 Extension`, can be provided locally during the export, or provided globally, as configured. However, the local ones will overwrite the global ones. If no meta-information is given, the global ones are used as default. Revoked certificates are not exported. In this case or the exporting cannot be done, either an internal error occurred or the internal policy prohibits it, the caller will be informed by an error.

[SWS_CRYPT_20603]{DRAFT} Getting or Querying [When an application or a `Functional Cluster` needs a specific certificate, it can either use a configured one (this is provided via the `CryptoCertificateInterface`) or can get a certificate via the `X.509 Provider` mechanism. If the user knows, which certificate it wants to access, it can do this by providing the direct handle or the `COUID`. However, it occurs that the user does not know exactly which certificate is needed. Therefore, the `X.509 Provider` allows to query the certificate. The application or `Functional Cluster` then can provide either certificate information, such as `certificate serial number` or issuer, the meta-information, part of the meta-information, the environment the certificate is used for (e.g., `IPsec` or `TLS`), or provide parts of the `certification path`. In this case the `X.509 Provider` provides a list of all matching certificates `ara::crypto::x509::BasicCertInfo` or an error, when no matching certificate was found or the caller has not the corresponding access rights for the found certificates.] ([RS_CRYPT_02306](#))

[SWS_CRYPT_40912]{DRAFT} Querying with wildcards [When an instance of class `ara::crypto::x509::X509DN` is created all attributes of this instance shall be none-initialized. None-initialized attributes shall serve as wildcards.] ([RS_CRYPT_02306](#))

[SWS_CRYPT_40913]{DRAFT} Sets of certificates [The function `ara::crypto::x509::X509Provider::FindCertByDn` shall provide a set of all certificates that match the attributes of parameter `subjectDn`. The function `findCertByDn` shall ignore none-initialized attributes of parameter `subjectDn` for the search for certificates.] ([RS_CRYPT_02306](#))

Figure 7.8 shows the model elements that are relevant for the deployment of certificates.

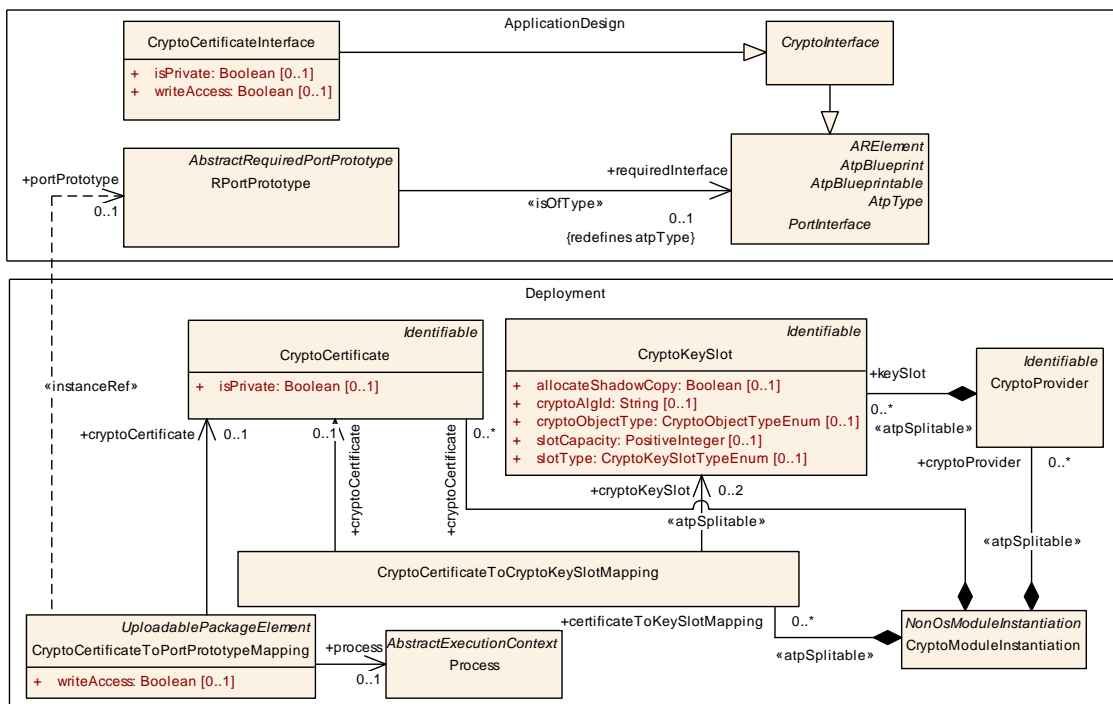

Figure 7.8: Certificate deployment

[SWS_CRYPT_20611]{DRAFT} Validation of [certification path](#) [When a certificate is installed, the whole certificate chain must be validated based on the whole tree path up to the root certificate (e.g., vehicle root) by [ara::crypto::x509::X509Provider::CheckCertStatus](#), [ara::crypto::x509::X509Provider::CheckCertStatus](#), [ara::crypto::x509::X509Provider::CountCertsInChain](#), [ara::crypto::x509::X509Provider::ParseCertChain](#), [ara::crypto::x509::X509Provider::ParseCertChain](#), [ara::crypto::x509::X509Provider::VerifyCertChain](#). Only certificates, which are not root certificates, are checked.]([RS_CRYPTO_02306](#))

Root certificates are not checked, because these are the trust anchors of the system. Because root certificates play this special role, root certificate shall be stored in a tamper proof manner to avoid malicious manipulation. How this is done is not part of this standard.

[SWS_CRYPT_20612]{DRAFT} [Supporting a full certificate life-cycle, the [FC Crypto](#) provides functionality to generate certificate signing request, where the needed encoding (i.e., [DER](#) or [PEM](#)) can be specified and the correct setting is ensured. The [CryptoAPI](#) provides this interface for CSR generation. Additionally, the [CryptoAPI](#) offers the specific interfaces to generate certificates and certificate chains, which can then be used by other protocols, i.e., [IKE](#).]([RS_CRYPTO_02306](#))

The [PKI](#) contains the certificates of the vehicle side, i.e. all certificates or artifacts that are part of the vehicle. It is structured based on functions on the [CA](#) level (level 2) and on distributed issuers on the Sub-CA level (level 3). The top level is defined by the vehicle root certificate, which is provided by every OEM and serves as a trust anchor. Also [X.509 Provider](#) may keep root certificates of 3rd party trusted [CAs](#) in order to communicate with external service providers.

[SWS_CRYPT_20613]{DRAFT} [The [FC Crypto](#) allows to encode and decode [ASN.1](#)-based standard formats (like [[39](#), [PKCS#8](#)], [[40](#), [PKCS#12](#)]), as specified in [[41](#), [X.680](#)], [[42](#), [X.682](#)], and [[43](#), [X.683](#)]. The [CryptoAPI](#) allows an application or [Functional Cluster](#) to select the encoding.]([RS_CRYPTO_02306](#))

[SWS_CRYPT_20614]{DRAFT} [The [CryptoAPI](#) provide all required [x.509](#) functionality related with access to the certification target private key (used for signature of own certificate request, via top-level context interface). The target private key can have a type different from signature (e.g., decryption or key-agreement). This is specified by the connection between [CryptoCertificate](#) and [CryptoKeySlot](#). This connection is done by a mapping.]([RS_CRYPTO_02306](#)) The mapping is provided by [CryptoCertificateToCryptoKeySlotMapping](#) as shown in [7.8](#).

[SWS_CRYPT_20615]{DRAFT} [The [X.509 Provider](#) shall verify self-signed certificates besides [PKI](#) based signatures. The [CryptoAPI](#) provides methods to specify the certificate and the used cryptographic algorithm. Based on the algorithm the [X.509 Provider](#) compares the given signature with the calculated one. If both are matching, the certificate is valid. Otherwise, the [X.509 Provider](#) will return an error.]([RS_CRYPTO_02306](#))

[SWS_CRYPT_20616]{DRAFT} [The access to the PKI-client's private key shall be used only internally and indirectly via the X.509 Provider interface. The private key will never leave the boundary of the FC Crypto.](RS_CRYPT_02306)

[SWS_CRYPT_20617]{DRAFT} [X.509 Provider is using the base cryptographic functions provided by the Crypto Provider. CryptoAPI provides related functions to store, retrieve, enumerate, verify, and use the information stored in the certificates.](RS_CRYPT_02306)

[SWS_CRYPT_20618]{DRAFT} [In the CryptoAPI context, the certificate store is protected from unauthorized access and tampering. This can be done by cryptographic mechanism, such as providing an MAC, or by storing the certificates in a secure storage, such as a TPM.](RS_CRYPT_02306)

[SWS_CRYPT_20619]{DRAFT} [During the initialization of the FC Crypto, all needed steps for service instantiation is done. This includes importing a root CA public key, setting up the certification path with all public keys along the path, checking the revocation status of certificates, updating the X.509 Provider internal management structure with certificate status, and the certificate ecosystem.](RS_CRYPT_02306)

7.4.3.3 Revocation of certificates

The X.509 Provider supports the revocation of certificates. This is done by using standard mechanism, such as certificate revocation lists (CRLs) and certificate trust lists (CTLs). The X.509 Provider is the organizational part of the FC Crypto, which handles and stores during run-time these CRLs and CTLs. The CryptoAPI provides interfaces, which allow application and Functional Clusters to import, export, and manage these lists.

[SWS_CRYPT_20901]{DRAFT} **CRL and CTL usage** [The X.509 Provider shall support CRL and CTL. The format of CRL and CTL are defined in [33, RFC 5280], [44, RFC 6518], [45, RFC 8398], and [46, RFC 8399] and is not part of this standard. The X.509 Provider can store the CRL and the CTL in an own internal used structure. However, the X.509 Provider can also use the provided information to update the corresponding elements. The update can be either the deletion of the element or setting a mark that the element was revoked.](RS_CRYPT_02306)

CRL is a list of digital certificates that have been revoked before their expiration date was reached. This list contains all the serial numbers of the revoked certificates and the revoked data.

[SWS_CRYPT_20902]{DRAFT} [Given in [33] the CRL can contain two different states:

1. Revoked: certificates that are irreversibly revoked.
2. Hold: certificates that are marked as temporally invalid.

](RS_CRYPT_02306)

CryptoAPI shall provide two ways to get CRL:

1. Offline: An application or `Functional Cluster` provides a CRL to the `X.509 Provider`.
2. Online: `X.509 Provider` opens a secure channel to a backend system. After a successful established connection, the `X.509 Provider` gets the matching CRL. The location of the specific backend system can either configured or provided via an application or `Functional Cluster`.

[SWS_CRYPT_20903]{DRAFT} Import [The `X.509 Provider` allows to import `ara::crypto::x509::X509Provider::ImportCrl` and update the CRL. These CRL can be either stored in the `X.509 Provider` separately or in combination with the certificate. The application or `Functional Cluster` can call the interface `ara::crypto::x509::X509Provider::ImportCrl`, which is provided by the `CryptoAPI`.] (*RS_CRYPT_02306*)

[SWS_CRYPT_20904]{DRAFT} [The `X.509 Provider` shall support the online mode to get and update CRL.] (*RS_CRYPT_02306*)

[SWS_CRYPT_20905]{DRAFT} Verify [The function `ara::crypto::x509::X509Provider::VerifyCert` shall verify if a certificate is valid. Therefore, the `X.509 Provider` checks additionally if a certificate was revoked, The revocation of the certificate is given via the CRL. This check can either be done via a call by an application or `Functional Cluster` (offline mode) or via a connection to a backend (online mode):

- In offline mode: An application or `Functional Cluster` provides the CRL to the `X.509 Provider` via an interface, which is exposed by the `CryptoAPI`.
- in online mode: The `X.509 Provider` uses a provided location to get the CRL. The location was provided by configuration or given in the interface call.

In both cases, the `X.509 Provider` uses the CRL to check if one of the internal stored certificate is listed. Is a certificate listed the `X.509 Provider` revokes the certificate internally.] (*RS_CRYPT_02306*)

[SWS_CRYPT_20906]{DRAFT} [The `X.509 Provider` shall support the standard protocol, `ara::crypto::x509::OcspResponse` (as defined in [31, RFC 6960]) and OCSP Stapling (as defined in [47, RFC 6066], [48, RFC 6961], and [49, RFC 8446]), to check if a certificate is revoked. OCSP is an alternative to CRLs.

] (*RS_CRYPT_02306*)

[SWS_CRYPT_20907]{DRAFT} [The `CryptoAPI` provides methods `ara::crypto::x509::X509Provider::CreateOcspRequest`, `ara::crypto::x509::X509Provider::CreateOcspRequest` to generate an `ara::crypto::x509::OcspRequest` request, which is defined in [31, RFC 6960]. The method can be used by an application or `Functional Cluster`.] (*RS_CRYPT_02306*)

[SWS_CRYPT_20908]{DRAFT} [The `X.509 Provider` shall support request generation for the revocation of certificates.] (*RS_CRYPT_02306*)

[SWS_CRYPT_20909]{DRAFT} Signalization of revoked certificate by application or functional cluster [Dedicated applications are allowed to inform the X.509 Provider of a misuse or of the invalidity of certificates. The X.509 Provider stores this information by revoking internally the specified certificate. This can either be done in the internal structure where certificates are stored or by updating the stored revocation list. When the X.509 Provider generates a CRL, it uses its internal information.] ([RS_CRYPT_02306](#))

[SWS_CRYPT_20910]{DRAFT} Internal signalization of revoked certificate [The X.509 Provider shall mark certificates in its internal structure or update the stored revocation list as revoked, when the X.509 Provider recognizes that a certificate is not valid anymore and thus shall be revoked. This can occur during *certification path* validation or verification of a certificate.] ([RS_CRYPT_02306](#))

[SWS_CRYPT_40972]{DRAFT} Configuration Options [The FC Crypto shall provide two configuration options. A configuration field contains either the URL or the identifier to specify either the URL for the backend (local / stack usage) or the required service interface.] ([RS_CRYPT_02306](#))

[SWS_CRYPT_40973]{DRAFT} [The FC Crypto shall report an error by calling the online functions if the configuration is empty, not performed or the configuration parameter is not a matching combination. This allows the application to react on the existing problem.] ([RS_CRYPT_02306](#))

[SWS_CRYPT_40974]{DRAFT} [The FC Crypto shall handle the additional behavior to send or request OCSP tickets via the configured mechanism.] ([RS_CRYPT_02306](#))

[SWS_CRYPT_40975]{DRAFT} [The FC Crypto shall inform the application via an return value that the CRL was updated via configured mechanism.] ([RS_CRYPT_02306](#))

[SWS_CRYPT_40976]{DRAFT} [The FC Crypto shall inform the application via an return value, that the online information was sent to the configured mechanism.] ([RS_CRYPT_02306](#))

[SWS_CRYPT_40977]{DRAFT} [The FC Crypto shall inform the application via an return value, that the validity of a given certificate was checked online via the configured mechanism.] ([RS_CRYPT_02306](#))

[SWS_CRYPT_40978]{DRAFT} [The FC Crypto shall provide a mechanism, which is used via the calling user (FC Crypto itself or application), allowing to get the last received OCSP ticket.] ([RS_CRYPT_02306](#))

[SWS_CRYPT_40979]{DRAFT} [The FC Crypto shall update the internal state of a certificate, if the certificate was invalidated via a given OCSP ticket and if the certificate is handled via the internal certificates management.] ([RS_CRYPT_02306](#))

[SWS_CRYPT_40980]{DRAFT} [The FC Crypto shall point to the successor of an invalidated certificate, if the OCSP ticket provides a successor.] ([RS_CRYPT_02306](#))

7.5 Cryptographic Primitives Naming Convention

`Crypto Providers` transforms the specific needed algorithm, which was configured during integration phase, into the by `FC Crypto` provided vendor specific algorithm. Supporting this decoupling of configuration from instantiation and enabling the support of future upcoming cryptographic algorithm, this specification does not provide a concrete list of cryptographic algorithms' identifiers and does not suppose usage of numerical identifiers. Instead of this, the vendor shall provide string names of supported algorithms in accompanying documentation.

The string names are used for the following:

- They are used as parameters by interface functions of a `Crypto Provider`.
- They serve as identifiers to cryptographic algorithms.
- The `Crypto Provider` interprets the string names and matches it to the algorithm, which is provided by `FC Crypto`.

[SWS_CRYPT_03910]{DRAFT} Configuration format for cryptographic algorithms [The string names to identify cryptographic algorithms shall satisfy the following rules:

1. The string names contains only Latin alphanumeric characters.
2. The string names contain up to 6 delimiters for cryptographic algorithm definition.
3. The string names is case insensitive. Thus, all comparisons of the identifiers shall be always case insensitive.
4. The string names to identify cryptographic algorithms shall satisfy the following structures:

```
"{TargetTransformation(Mode)} / {SupportingAlgorithms} /
  {Encoding&Padding}"
```

where

- `"{TargetTransformation(Mode)}"` – a specifier of target transformation: for complex transformations it is a mode name, but for fully-defined algorithms it is just their name.
- `"{SupportingAlgorithms}"` – a specifier of basic cryptographic algorithm(s) including key length and/or block length.
- `"{Encoding&Padding}"` – a specifier of encoding and/or padding method. It can support following predefined name (equal to empty specification):
 - `"Zero"` – a default encoding & padding method: if data are already aligned to the block boundary then it doesn't add anything, but if they are not aligned then applies a padding by `'\0'` bytes up to the block boundary.

Allowed delimiters:

- ' / ' – separator between main components of the whole algorithm specification.
- ' _ ' – separator instead of general separation characters (e.g.: ' . ', ' . ', ' : ', ' - ', ' ') in original name of standard. This delimiter can be applied between two digits or two letters only!
- ' - ' – separator between a base algorithm name and its precise specifiers that define key-length or block-length in bits.
- ' + ' – separator between a few base algorithms' specifications for a cascade transformation definition.
- ' , ' – separator between a few base algorithms' specifications for a case if the whole algorithm is based on a few types of basic transformations.
- ' . ' – separator between a common name of a standard and its specific part or its version that precises a specification of concrete transformation.

|(RS_CRYPT0_02308)

Examples of well-known algorithm names: "ECDSA-256", "ECDH-256", "AES-128", "Camellia-256", "3DES-168", "ChaCha20", "GOST28147_89", "SHA1", "SHA2-256", "GOSTR3410.94", "GOSTR3410.2001", "GOSTR3410.2012-512".

Examples of well-known modes names: "ECB", "OFB", "CFB", "CBC", "PCBC", "CTR", "HMAC", "CBC_MAC", "OMAC1", "OMAC2", "VMAC", "Poly1305", "CCM", "GCM", "OCB", "CWC", "EAX", "KDF1", "KDF2", "KDF3", "MGF1".

Examples of the encoding and padding names: "ANSI_X923", "ISO10126", "PKCS7", "ISO_IEC7816_4", "PKCS1.v1_5", "OAEP", "OAEPplus", "SAEP", "SAEPplus", "PSS", "EME", "EMSA".

Examples of fully defined transformations:

- "ECDSA-384" means ECDSA signature algorithm with private key-length 384 bit.
- "ECDH-512" means ECDH key agreement algorithm with private key-length 512 bit.
- "CTRAES-256" means a CTR-mode stream cipher based on AES algorithm with key-length 256 bit.
- "CBCAES-192+Camellia-192/PKCS7" means CBC-mode cipher based on cascade application of AES-192 and Camellia-192 with padding of last block according to PKCS#7.
- "HMACSHA-256" means HMAC based on SHA-256.

If an algorithm support a few variable length parameters then they shall be specified in following order:

key, IO-block or output digest, IV or input block (e.g.: "Kalyna-512-256" means block cipher Kalina with 512-bit key and 256-bit block).

If a transformation is based on a few basic cryptographic algorithms then they shall be specified in an order corresponding to the level of their application (see example below for RSA).

Following Mode specifications can be used for RSA-based algorithms:

- "SIG" – signature primitive (e.g., "SIGRSA-2048, SHA-160PKCS1.v1_5, EMSA")
- "VER" – verification primitive (e.g., "VERRSA-2048, SHA-160PKCS1.v1_5, EMSA")
- "ENC" – encryption primitive (e.g., "ENCRSA-2048, MGF1, SHA-160PKCS1.v1_5, EME", "ENCRSA-4096, MGF1, SHA2-256OAEP, EME")
- "DEC" – decryption primitive (e.g., "DECRSA-2048, MGF1, SHA-160PKCS1.v1_5, EME", "DECRSA-4096, MGF1, SHA2-256OAEP, EME")
- "KEM" – Key Encapsulation Mechanism (e.g., "KEM/RSA-2048, AES-128, KDF3, SHA-256")

A supplier should strive to use shortest names of algorithms, sufficient for their unambiguous identification.

8 API specification

8.1 C++ language binding Crypto Provider

[SWS_CRYPT_20100]{DRAFT} [

Kind:	class
Symbol:	AuthCipherCtx
Scope:	namespace ara::crypto::cryp
Base class:	CryptoContext
Syntax:	<code>class ara::crypto::cryp::AuthCipherCtx : public CryptoContext {...};</code>
Header file:	<code>#include "ara/crypto/cryp/auth_cipher_ctx.h"</code>
Description:	<p>Generalized Authenticated Cipher Context interface. Methods of the derived interface Buffered Digest are used for authentication of associated public data. Methods of the derived interface StreamCipherCtx are used for encryption/decryption and authentication of confidential part of message. The data processing must be executed in following order:</p> <p>Call one of the Start() methods. Process all associated public data via calls of Update() methods. Process the confidential part of the message via calls of ProcessBlocks(), ProcessBytes() (and optionally FinishBytes()) methods. Call the Finish() method due to finalize the authentication code calculation (and get it optionally). Copy of the calculated MAC may be extracted (by GetDigest()) or compared internally (by Compare()). Receiver side should not use decrypted data before finishing of the whole decryption and authentication process! I.e. decrypted data can be used only after successful MAC verification!</p>

]([RS_CRYPT_02207](#))

[SWS_CRYPT_29030]{DRAFT} [

Kind:	class
Symbol:	BlockService
Scope:	namespace ara::crypto::cryp
Base class:	ExtensionService
Syntax:	<code>class ara::crypto::cryp::BlockService : public ExtensionService {...};</code>
Header file:	<code>#include "ara/crypto/cryp/block_service.h"</code>
Description:	Extension meta-information service for block cipher contexts.

]([RS_CRYPT_02309](#))

[SWS_CRYPT_20400]{DRAFT} [

Kind:	class
Symbol:	CryptoContext
Scope:	namespace ara::crypto::cryp
Syntax:	<code>class ara::crypto::cryp::CryptoContext {...};</code>
Header file:	<code>#include "ara/crypto/cryp/crypto_context.h"</code>
Description:	A common interface of a mutable cryptographic context, i.e. that is not binded to a single crypto object.

]([RS_CRYPT_02008](#))

[SWS_CRYPT_20500]{DRAFT} [

Kind:	class
Symbol:	CryptoObject
Scope:	namespace ara::crypto::cryp
Syntax:	<code>class ara::crypto::cryp::CryptoObject {...};</code>
Header file:	<code>#include "ara/crypto/cryp/cryobj/crypto_object.h"</code>
Description:	A common interface for all cryptographic objects recognizable by the Crypto Provider. This interface (or any its derivative) represents a non-mutable (after completion) object loadable to a temporary transformation context.

] ([RS_CRYPT_02005](#))

[SWS_CRYPT_20600]{DRAFT} [

Kind:	class
Symbol:	CryptoPrimitiveId
Scope:	namespace ara::crypto::cryp
Syntax:	<code>class ara::crypto::cryp::CryptoPrimitiveId {...};</code>
Header file:	<code>#include "ara/crypto/cryp/cryobj/crypto_primitive_id.h"</code>
Description:	Common interface for identification of all Crypto Primitives and their keys & parameters.

] ([RS_CRYPT_02005](#))

[SWS_CRYPT_20700]{DRAFT} [

Kind:	class
Symbol:	CryptoProvider
Scope:	namespace ara::crypto::cryp
Syntax:	<code>class ara::crypto::cryp::CryptoProvider {...};</code>
Header file:	<code>#include "ara/crypto/cryp/crypto_provider.h"</code>
Description:	Crypto Provider is a "factory" interface of all supported Crypto Primitives and a "trusted environment" for internal communications between them. All Crypto Primitives should have an actual reference to their parent Crypto Provider. A Crypto Provider can be destroyed only after destroying of all its daughterly Crypto Primitives. Each method of this interface that creates a Crypto Primitive instance is non-constant, because any such creation increases a references counter of the Crypto Primitive.

] ([RS_CRYPT_02305](#), [RS_CRYPT_02307](#), [RS_CRYPT_02401](#))

[SWS_CRYPT_29020]{DRAFT} [

Kind:	class
Symbol:	CryptoService
Scope:	namespace ara::crypto::cryp
Base class:	ExtensionService
Syntax:	<code>class ara::crypto::cryp::CryptoService : public ExtensionService {...};</code>
Header file:	<code>#include "ara/crypto/cryp/crypto_service.h"</code>
Description:	Extension meta-information service for cryptographic contexts.

] ([RS_CRYPT_02309](#))

[SWS_CRYPT_20800]{DRAFT} [

Kind:	class
Symbol:	DecryptorPrivateCtx
Scope:	namespace ara::crypto::cryp
Base class:	CryptoContext
Syntax:	<pre>class ara::crypto::cryp::DecryptorPrivateCtx : public CryptoContext {...};</pre>
Header file:	#include "ara/crypto/cryp/decryptor_private_ctx.h"
Description:	Asymmetric Decryption Private key Context interface.

]([RS_CRYPT_02202](#))

[SWS_CRYPT_29010]{DRAFT} [

Kind:	class
Symbol:	DigestService
Scope:	namespace ara::crypto::cryp
Base class:	BlockService
Syntax:	<pre>class ara::crypto::cryp::DigestService : public BlockService {...};</pre>
Header file:	#include "ara/crypto/cryp/digest_service.h"
Description:	Extension meta-information service for digest producing contexts.

]([RS_CRYPT_02309](#))

[SWS_CRYPT_21000]{DRAFT} [

Kind:	class
Symbol:	EncryptorPublicCtx
Scope:	namespace ara::crypto::cryp
Base class:	CryptoContext
Syntax:	<pre>class ara::crypto::cryp::EncryptorPublicCtx : public CryptoContext {...};</pre>
Header file:	#include "ara/crypto/cryp/encryptor_public_ctx.h"
Description:	Asymmetric Encryption Public key Context interface.

]([RS_CRYPT_02202](#))

[SWS_CRYPT_29040]{DRAFT} [

Kind:	class
Symbol:	ExtensionService
Scope:	namespace ara::crypto::cryp
Syntax:	<pre>class ara::crypto::cryp::ExtensionService {...};</pre>
Header file:	#include "ara/crypto/cryp/extension_service.h"
Description:	Basic meta-information service for all contexts.

]([RS_CRYPT_02309](#))

[SWS_CRYPT_21100]{DRAFT} [

Kind:	class
Symbol:	HashFunctionCtx
Scope:	namespace ara::crypto::cryp
Base class:	CryptoContext
Syntax:	<pre>class ara::crypto::cryp::HashFunctionCtx : public CryptoContext {...};</pre>
Header file:	#include "ara/crypto/cryp/hash_function_ctx.h"
Description:	Hash function interface.

]([RS_CRYPT_02205](#))

[SWS_CRYPT_21300]{DRAFT} [

Kind:	class
Symbol:	KeyAgreementPrivateCtx
Scope:	namespace ara::crypto::cryp
Base class:	CryptoContext
Syntax:	<pre>class ara::crypto::cryp::KeyAgreementPrivateCtx : public Crypto Context {...};</pre>
Header file:	#include "ara/crypto/cryp/key_agreement_private_ctx.h"
Description:	Key Agreement Private key Context interface (Diffie Hellman or conceptually similar).

]([RS_CRYPT_02104](#))

[SWS_CRYPT_21400]{DRAFT} [

Kind:	class
Symbol:	KeyDecapsulatorPrivateCtx
Scope:	namespace ara::crypto::cryp
Base class:	CryptoContext
Syntax:	<pre>class ara::crypto::cryp::KeyDecapsulatorPrivateCtx : public Crypto Context {...};</pre>
Header file:	#include "ara/crypto/cryp/key_decapsulator_private_ctx.h"
Description:	Asymmetric Key Encapsulation Mechanism (KEM) Private key Context interface.

]([RS_CRYPT_02104](#), [RS_CRYPT_02209](#))

[SWS_CRYPT_21500]{DRAFT} [

Kind:	class
Symbol:	KeyDerivationFunctionCtx
Scope:	namespace ara::crypto::cryp
Base class:	CryptoContext
Syntax:	<pre>class ara::crypto::cryp::KeyDerivationFunctionCtx : public Crypto Context {...};</pre>
Header file:	#include "ara/crypto/cryp/key_derivation_function_ctx.h"
Description:	Key Derivation Function interface.

]([RS_CRYPT_02103](#))

[SWS_CRYPT_21800]{DRAFT} [

Kind:	class
Symbol:	KeyEncapsulatorPublicCtx
Scope:	namespace ara::crypto::cryp
Base class:	CryptoContext
Syntax:	<pre>class ara::crypto::cryp::KeyEncapsulatorPublicCtx : public CryptoContext {...};</pre>
Header file:	#include "ara/crypto/cryp/key_encapsulator_public_ctx.h"
Description:	Asymmetric Key Encapsulation Mechanism (KEM) Public key Context interface.

] ([RS_CRYPT_02104](#), [RS_CRYPT_02209](#))

[SWS_CRYPT_22100]{DRAFT} [

Kind:	class
Symbol:	MessageAuthnCodeCtx
Scope:	namespace ara::crypto::cryp
Base class:	CryptoContext
Syntax:	<pre>class ara::crypto::cryp::MessageAuthnCodeCtx : public CryptoContext {...};</pre>
Header file:	#include "ara/crypto/cryp/message_authn_code_ctx.h"
Description:	Keyed Message Authentication Code Context interface definition (MAC/HMAC).

] ([RS_CRYPT_02203](#))

[SWS_CRYPT_22200]{DRAFT} [

Kind:	class
Symbol:	MsgRecoveryPublicCtx
Scope:	namespace ara::crypto::cryp
Base class:	CryptoContext
Syntax:	<pre>class ara::crypto::cryp::MsgRecoveryPublicCtx : public CryptoContext {...};</pre>
Header file:	#include "ara/crypto/cryp/msg_recovery_public_ctx.h"
Description:	A public key context for asymmetric recovery of a short message and its signature verification (RSA-like). Restricted groups of trusted subscribers can use this primitive for simultaneous provisioning of confidentiality, authenticity and non-repudiation of short messages, if the public key is generated appropriately and kept in secret. If (0 == BlockCryptor::ProcessBlock(...)) then the input message-block is violated.

] ([RS_CRYPT_02202](#), [RS_CRYPT_02204](#))

[SWS_CRYPT_22500]{DRAFT} [

Kind:	class
Symbol:	PrivateKey
Scope:	namespace ara::crypto::cryp
Base class:	RestrictedUseObject
Syntax:	<pre>class ara::crypto::cryp::PrivateKey : public RestrictedUseObject {...};</pre>





Header file:	#include "ara/crypto/cryp/cryobj/private_key.h"
Description:	Generalized Asymmetric Private Key interface.

]([RS_CRYPT_02002](#), [RS_CRYPT_02403](#))

[SWS_CRYPT_22700]{DRAFT} [

Kind:	class
Symbol:	PublicKey
Scope:	namespace ara::crypto::cryp
Base class:	RestrictedUseObject
Syntax:	<pre>class ara::crypto::cryp::PublicKey : public RestrictedUseObject {...};</pre>
Header file:	#include "ara/crypto/cryp/cryobj/public_key.h"
Description:	General Asymmetric Public Key interface.

]([RS_CRYPT_02202](#))

[SWS_CRYPT_22900]{DRAFT} [

Kind:	class
Symbol:	RandomGeneratorCtx
Scope:	namespace ara::crypto::cryp
Base class:	CryptoContext
Syntax:	<pre>class ara::crypto::cryp::RandomGeneratorCtx : public CryptoContext {...};</pre>
Header file:	#include "ara/crypto/cryp/random_generator_ctx.h"
Description:	Interface of Random Number Generator Context.

]([RS_CRYPT_02206](#))

[SWS_CRYPT_24800]{DRAFT} [

Kind:	class
Symbol:	RestrictedUseObject
Scope:	namespace ara::crypto::cryp
Base class:	CryptoObject
Syntax:	<pre>class ara::crypto::cryp::RestrictedUseObject : public CryptoObject {...};</pre>
Header file:	#include "ara/crypto/cryp/cryobj/restricted_use_object.h"
Description:	A common interface for all objects supporting the usage restriction.

]([RS_CRYPT_02008](#))

[SWS_CRYPT_23000]{DRAFT} [

Kind:	class
Symbol:	SecretSeed
Scope:	namespace ara::crypto::cryp





Base class:	RestrictedUseObject
Syntax:	<pre>class ara::crypto::cryp::SecretSeed : public RestrictedUseObject {...};</pre>
Header file:	<pre>#include "ara/crypto/cryp/cryobj/secret_seed.h"</pre>
Description:	Secret Seed object interface. This object contains a raw bit sequence of specific length (without any filtering of allowed/disallowed values)! The secret seed value can be loaded only to a non-key input of a cryptographic transformation context (like IV/salt/nonce)! Bit length of the secret seed is specific to concret crypto algorithm and corresponds to maximum of its input/output/salt block-length.

]([RS_CRYPT_02007](#))

[SWS_CRYPT_23200]{DRAFT} [

Kind:	class
Symbol:	SigEncodePrivateCtx
Scope:	namespace ara::crypto::cryp
Base class:	CryptoContext
Syntax:	<pre>class ara::crypto::cryp::SigEncodePrivateCtx : public CryptoContext {...};</pre>
Header file:	<pre>#include "ara/crypto/cryp/sig_encode_private_ctx.h"</pre>
Description:	A private key context for asymmetric signature calculation and short message encoding (RSA-like). Restricted groups of trusted subscribers can use this primitive for simultaneous provisioning of confidentiality, authenticity and non-repudiation of short messages, if the public key is generated appropriately and kept in secret.

]([RS_CRYPT_02202](#), [RS_CRYPT_02204](#))

[SWS_CRYPT_29000]{DRAFT} [

Kind:	class
Symbol:	SignatureService
Scope:	namespace ara::crypto::cryp
Base class:	ExtensionService
Syntax:	<pre>class ara::crypto::cryp::SignatureService : public ExtensionService {...};</pre>
Header file:	<pre>#include "ara/crypto/cryp/signature_service.h"</pre>
Description:	Extension meta-information service for signature contexts.

]([RS_CRYPT_02309](#))

[SWS_CRYPT_23300]{DRAFT} [

Kind:	class
Symbol:	Signature
Scope:	namespace ara::crypto::cryp
Base class:	CryptoObject
Syntax:	<pre>class ara::crypto::cryp::Signature : public CryptoObject {...};</pre>
Header file:	<pre>#include "ara/crypto/cryp/cryobj/signature.h"</pre>





Description:	Signature container interface This interface is applicable for keeping the Digital Signature, Hash Digest, (Hash-based) Message Authentication Code (MAC/HMAC). In case of a keyed signature (Digital Signature or MAC/HMAC) a COUID of the signature verification key can be obtained by a call of CryptoObject::HasDependence()!
---------------------	--

|(RS_CRYPT_02203, RS_CRYPT_02204, RS_CRYPT_02205)

[SWS_CRYPT_23500]{DRAFT} [

Kind:	class
Symbol:	SignerPrivateCtx
Scope:	namespace ara::crypto::cryp
Base class:	CryptoContext
Syntax:	<pre>class ara::crypto::cryp::SignerPrivateCtx : public CryptoContext {...};</pre>
Header file:	#include "ara/crypto/cryp/signer_private_ctx.h"
Description:	Signature Private key Context interface.

|(RS_CRYPT_02204)

[SWS_CRYPT_23600]{DRAFT} [

Kind:	class
Symbol:	StreamCipherCtx
Scope:	namespace ara::crypto::cryp
Base class:	CryptoContext
Syntax:	<pre>class ara::crypto::cryp::StreamCipherCtx : public CryptoContext {...};</pre>
Header file:	#include "ara/crypto/cryp/stream_cipher_ctx.h"
Description:	Generalized Stream Cipher Context interface (it covers all modes of operation).

|(RS_CRYPT_02201)

[SWS_CRYPT_23700]{DRAFT} [

Kind:	class
Symbol:	SymmetricBlockCipherCtx
Scope:	namespace ara::crypto::cryp
Base class:	CryptoContext
Syntax:	<pre>class ara::crypto::cryp::SymmetricBlockCipherCtx : public CryptoContext {...};</pre>
Header file:	#include "ara/crypto/cryp/symmetric_block_cipher_ctx.h"
Description:	Interface of a Symmetric Block Cipher Context with padding.

|(RS_CRYPT_02201)

[SWS_CRYPT_23800]{DRAFT} [

Kind:	class
Symbol:	SymmetricKey
Scope:	namespace ara::crypto::cryp
Base class:	RestrictedUseObject
Syntax:	<pre>class ara::crypto::cryp::SymmetricKey : public RestrictedUseObject {...};</pre>
Header file:	#include "ara/crypto/cryp/cryobj/symmetric_key.h"
Description:	Symmetric Key interface.

] ([RS_CRYPT_02001](#), [RS_CRYPT_02403](#))

[SWS_CRYPT_24000]{DRAFT} [

Kind:	class
Symbol:	SymmetricKeyWrapperCtx
Scope:	namespace ara::crypto::cryp
Base class:	CryptoContext
Syntax:	<pre>class ara::crypto::cryp::SymmetricKeyWrapperCtx : public CryptoContext {...};</pre>
Header file:	#include "ara/crypto/cryp/symmetric_key_wrapper_ctx.h"
Description:	Context of a symmetric key wrap algorithm (for AES it should be compatible with RFC3394 or RFC5649). The public interface of this context is dedicated for raw key material wrapping/unwrapping, i.e. without any meta-information assigned to the key material in source crypto object. But additionally this context type should support some "hidden" low-level methods suitable for whole crypto object exporting/importing. Key Wrapping of a whole crypto object (including associated meta-information) can be done by methods: ExportSecuredObject() and ImportSecuredObject(), but without compliance to RFC3394 or RFC5649.

] ([RS_CRYPT_02104](#), [RS_CRYPT_02208](#))

[SWS_CRYPT_24100]{DRAFT} [

Kind:	class
Symbol:	VerifierPublicCtx
Scope:	namespace ara::crypto::cryp
Base class:	CryptoContext
Syntax:	<pre>class ara::crypto::cryp::VerifierPublicCtx : public CryptoContext {...};</pre>
Header file:	#include "ara/crypto/cryp/verifier_public_ctx.h"
Description:	Signature Verification Public key Context interface.

] ([RS_CRYPT_02204](#))

[SWS_CRYPT_20319]{DRAFT} [

Kind:	function
Symbol:	Check(const Signature &expected)
Scope:	class ara::crypto::cryp::AuthCipherCtx





Syntax:	virtual ara::core::Result<bool> ara::crypto::cryp::AuthCipher Ctx::Check (const Signature &expected) const noexcept=0;	
Parameters (in):	expected	the signature object containing an expected digest value
Return value:	ara::core::Result< bool >	true if value and meta-information of the provided "signature" object is identical to calculated digest and current configuration of the context respectively; but false otherwise
Exception Safety:	noexcept	
Thread Safety:	Thread-safe	
Errors:	CryptoErrorDomain::kProcessingNot Finished	if the digest calculation was not finished by a call of the Finish() method
	CryptoErrorDomain::kIncompatible Object	if the provided "signature" object was produced by another crypto primitive type
Header file:	#include "ara/crypto/cryp/auth_cipher_ctx.h"	
Description:	Check the calculated digest against an expected "signature" object. Entire digest value is kept in the context up to next call Start(), therefore it can be verified again or extracted. This method can be implemented as "inline" after standartization of function ara::core::memcmp().	

]([RS_CRYPTO_02203](#), [RS_CRYPTO_02204](#))

[SWS_CRYPT_20102]{DRAFT} [

Kind:	function	
Symbol:	GetDigestService()	
Scope:	class ara::crypto::cryp::AuthCipherCtx	
Syntax:	virtual DigestService::Uptr ara::crypto::cryp::AuthCipherCtx::GetDigestService () const noexcept=0;	
Return value:	DigestService::Uptr	–
Exception Safety:	noexcept	
Header file:	#include "ara/crypto/cryp/auth_cipher_ctx.h"	
Description:	Get DigestService instance.	

]([RS_CRYPTO_02006](#))

[SWS_CRYPT_20316]{DRAFT} [

Kind:	function	
Symbol:	GetDigest(std::size_t offset=0)	
Scope:	class ara::crypto::cryp::AuthCipherCtx	
Syntax:	virtual ara::core::Result<ara::core::Vector<ara::core::Byte> > ara::crypto::cryp::AuthCipherCtx::GetDigest (std::size_t offset=0) const noexcept=0;	
Parameters (in):	offset	position of the first byte of digest that should be placed to the output buffer
Return value:	ara::core::Result< ara::core::Vector< ara::core::Byte > >	an output buffer storing the requested digest fragment or the full digest
Exception Safety:	noexcept	
Thread Safety:	Thread-safe	
Errors:	CryptoErrorDomain::kProcessingNot Finished	if the digest calculation was not finished by a call of the Finish() method





	CryptoErrorDomain::kUsageViolation	if the buffered digest belongs to a MAC/HMAC/AE/AEAD context initialized by a key without kAllowSignature permission
Header file:	#include "ara/crypto/cryp/auth_cipher_ctx.h"	
Description:	Retrieve the calculated digest. The entire digest value is kept in the context until the next call of Start(). Therefore, the digest can be re-checked or extracted at any time. If the offset is larger than the digest, an empty buffer shall be returned. This method can be implemented as "inline" after standardization of function ara::core::memcpy().	

]([RS_CRYPT_02207](#))

[SWS_CRYPT_21715]{DRAFT} [

Kind:	function	
Symbol:	GetTransformation()	
Scope:	class ara::crypto::cryp::AuthCipherCtx	
Syntax:	virtual ara::core::Result<CryptoTransform> ara::crypto::cryp::AuthCipherCtx::GetTransformation () const noexcept=0;	
Return value:	ara::core::Result< CryptoTransform >	CryptoTransform
Exception Safety:	noexcept	
Thread Safety:	Thread-safe	
Errors:	CryptoErrorDomain::kUninitialized Context	if the transformation direction of this context is configurable during an initialization, but the context was not initialized yet
Header file:	#include "ara/crypto/cryp/auth_cipher_ctx.h"	
Description:	Get the kind of transformation configured for this context: kEncrypt or kDecrypt.	

]([RS_CRYPT_02309](#))

[SWS_CRYPT_20103]{DRAFT} [

Kind:	function	
Symbol:	GetMaxAssociatedDataSize()	
Scope:	class ara::crypto::cryp::AuthCipherCtx	
Syntax:	virtual std::uint64_t ara::crypto::cryp::AuthCipherCtx::GetMaxAssociatedDataSize () const noexcept=0;	
Return value:	std::uint64_t	maximal supported size of associated public data in bytes
Exception Safety:	noexcept	
Thread Safety:	Thread-safe	
Header file:	#include "ara/crypto/cryp/auth_cipher_ctx.h"	
Description:	Get maximal supported size of associated public data.	

]([RS_CRYPT_02309](#))

[SWS_CRYPT_23634]{DRAFT} [

Kind:	function	
Symbol:	ProcessConfidentialData(ReadOnlyMemRegion in, ara::core::Optional< ReadOnlyMemRegion > expectedTag)	





Scope:	class ara::crypto::cryp::AuthCipherCtx	
Syntax:	<pre>virtual ara::core::Result<ara::core::Vector<ara::core::Byte> > ara::crypto::cryp::AuthCipherCtx::ProcessConfidentialData (ReadOnlyMemRegion in, ara::core::Optional< ReadOnlyMemRegion > expectedTag) noexcept=0;</pre>	
Parameters (in):	in	the input buffer containing the full message
	expectedTag	optional pointer to read only mem region containing the auth-tag for verification.
Return value:	ara::core::Result< ara::core::Vector< ara::core::Byte > >	the processed data
Exception Safety:	noexcept	
Thread Safety:	Thread-safe	
Errors:	CryptoErrorDomain::kInvalidInputSize	if size of the input buffer is not divisible by the block size (see GetBlockSize())
	CryptoErrorDomain::kProcessingNot Started	if the data processing was not started by a call of the Start() method
	CryptoErrorDomain::kAuthTagNotValid	if the processed data cannot be authenticated
Header file:	#include "ara/crypto/cryp/auth_cipher_ctx.h"	
Description:	Process confidential data and return result. The input buffer will be overwritten by the processed message. This function is the final call, i.e. all associated data must have been already provided. Hence, the function will check the authentication tag and only return the processed data, if the tag is valid.	

]([RS_CRYPT_02302](#))

[SWS_CRYPT_23635]{DRAFT} [

Kind:	function	
Symbol:	ProcessConfidentialData(ReadWriteMemRegion inOut, ara::core::Optional< ReadOnlyMemRegion > expectedTag)	
Scope:	class ara::crypto::cryp::AuthCipherCtx	
Syntax:	<pre>virtual ara::core::Result<void> ara::crypto::cryp::AuthCipherCtx::ProcessConfidentialData (ReadWriteMemRegion inOut, ara::core::Optional< ReadOnlyMemRegion > expectedTag) noexcept=0;</pre>	
Parameters (in):	inOut	the input buffer containing the full message
	expectedTag	optional pointer to read only mem region containing the auth-tag for verification.
Return value:	ara::core::Result< void >	–
Exception Safety:	noexcept	
Thread Safety:	Thread-safe	
Errors:	CryptoErrorDomain::kInvalidInputSize	if size of the input buffer is not divisible by the block size (see GetBlockSize())
	CryptoErrorDomain::kProcessingNot Started	if the data processing was not started by a call of the Start() method
	CryptoErrorDomain::kAuthTagNotValid	if the processed data cannot be authenticated
Header file:	#include "ara/crypto/cryp/auth_cipher_ctx.h"	
Description:	Process confidential data and update the input buffer with the processed message. The input buffer will be overwritten by the processed message After this method is called no additional associated data may be updated.	

]([RS_CRYPT_02302](#))

[SWS_CRYPT_20414]{DRAFT} [

Kind:	function	
Symbol:	Reset()	
Scope:	class ara::crypto::cryp::AuthCipherCtx	
Syntax:	virtual ara::core::Result<void> ara::crypto::cryp::AuthCipherCtx::Reset () noexcept=0;	
Return value:	ara::core::Result< void >	–
Exception Safety:	noexcept	
Thread Safety:	Thread-safe	
Header file:	#include "ara/crypto/cryp/auth_cipher_ctx.h"	
Description:	Clear the crypto context. .	

] ([RS_CRYPT_02108](#))

[SWS_CRYPT_23911]{DRAFT} [

Kind:	function	
Symbol:	SetKey(const SymmetricKey &key, CryptoTransform transform=CryptoTransform::kEncrypt)	
Scope:	class ara::crypto::cryp::AuthCipherCtx	
Syntax:	virtual ara::core::Result<void> ara::crypto::cryp::AuthCipherCtx::SetKey (const SymmetricKey &key, CryptoTransform transform=CryptoTransform::kEncrypt) noexcept=0;	
Parameters (in):	key	the source key object
	transform	the "direction" indicator: deploy the key for encryption (if true) or for decryption (if false)
Return value:	ara::core::Result< void >	–
Exception Safety:	noexcept	
Thread Safety:	Thread-safe	
Errors:	CryptoErrorDomain::kIncompatibleObject	if the provided key object is incompatible with this symmetric key context
	CryptoErrorDomain::kUsageViolation	if the transformation type associated with this context (taking into account the direction specified by transform) is prohibited by the "allowed usage" restrictions of provided key object
Header file:	#include "ara/crypto/cryp/auth_cipher_ctx.h"	
Description:	Set (deploy) a key to the authenticated cipher symmetric algorithm context.	

] ([RS_CRYPT_02001](#), [RS_CRYPT_02003](#))

[SWS_CRYPT_24714]{DRAFT} [

Kind:	function	
Symbol:	Start(ReadOnlyMemRegion iv=ReadOnlyMemRegion())	
Scope:	class ara::crypto::cryp::AuthCipherCtx	
Syntax:	virtual ara::core::Result<void> ara::crypto::cryp::AuthCipherCtx::Start (ReadOnlyMemRegion iv=ReadOnlyMemRegion()) noexcept=0;	
Parameters (in):	iv	an optional Initialization Vector (IV) or "nonce" value
Return value:	ara::core::Result< void >	–
Exception Safety:	noexcept	
Thread Safety:	Thread-safe	





Errors:	CryptoErrorDomain::kUninitialized Context	if the context was not initialized
	CryptoErrorDomain::kInvalidInputSize	if the size of provided IV is not supported (i.e. if it is not enough for the initialization)
	CryptoErrorDomain::kUnsupported	if the base algorithm (or its current implementation) principally doesn't support the IV variation, but provided IV value is not empty, i.e. if (iv.empty() == false)
Header file:	#include "ara/crypto/cryp/auth_cipher_ctx.h"	
Description:	Initialize the context for a new data processing or generation (depending from the primitive). If IV size is greater than maximally supported by the algorithm then an implementation may use the leading bytes only from the sequence.	

](RS_CRYPT_02302)

[SWS_CRYPT_24715]{DRAFT} [

Kind:	function	
Symbol:	Start(const SecretSeed &iv)	
Scope:	class ara::crypto::cryp::AuthCipherCtx	
Syntax:	virtual ara::core::Result<void> ara::crypto::cryp::AuthCipherCtx::Start (const SecretSeed &iv) noexcept=0;	
Parameters (in):	iv	the Initialization Vector (IV) or "nonce" object
Return value:	ara::core::Result< void >	-
Exception Safety:	noexcept	
Thread Safety:	Thread-safe	
Errors:	CryptoErrorDomain::kUninitialized Context	if the context was not initialized
	CryptoErrorDomain::kInvalidInputSize	if the size of provided IV is not supported (i.e. if it is not enough for the initialization)
	CryptoErrorDomain::kUnsupported	if the base algorithm (or its current implementation) principally doesn't support the IV variation
	CryptoErrorDomain::kUsageViolation	if this transformation type is prohibited by the "allowed usage" restrictions of the provided Secret Seed object
Header file:	#include "ara/crypto/cryp/auth_cipher_ctx.h"	
Description:	Initialize the context for a new data processing or generation (depending from the primitive). If IV size is greater than maximally supported by the algorithm then an implementation may use the leading bytes only from the sequence.	

](RS_CRYPT_02302)

[SWS_CRYPT_20312]{DRAFT} [

Kind:	function	
Symbol:	UpdateAssociatedData(const RestrictedUseObject &in)	
Scope:	class ara::crypto::cryp::AuthCipherCtx	
Syntax:	virtual ara::core::Result<void> ara::crypto::cryp::AuthCipherCtx::UpdateAssociatedData (const RestrictedUseObject &in) noexcept=0;	
Parameters (in):	in	a part of input message that should be processed
Return value:	ara::core::Result< void >	-





Exception Safety:	noexcept	
Thread Safety:	Thread-safe	
Errors:	CryptoErrorDomain::kProcessingNot Started	if the digest calculation was not initiated by a call of the Start() method
	CryptoErrorDomain::kInvalidUsage Order	if ProcessConfidentialData has already been called
Header file:	#include "ara/crypto/cryp/auth_cipher_ctx.h"	
Description:	Update the digest calculation by the specified RestrictedUseObject. This method is dedicated for cases then the RestrictedUseObject is a part of the "message".	

](RS_CRYPT_02302)

[SWS_CRYPT_20313]{DRAFT} [

Kind:	function	
Symbol:	UpdateAssociatedData(ReadOnlyMemRegion in)	
Scope:	class ara::crypto::cryp::AuthCipherCtx	
Syntax:	virtual ara::core::Result<void> ara::crypto::cryp::AuthCipherCtx::UpdateAssociatedData (ReadOnlyMemRegion in) noexcept=0;	
Parameters (in):	in	a part of the input message that should be processed
Return value:	ara::core::Result< void >	–
Exception Safety:	noexcept	
Thread Safety:	Thread-safe	
Errors:	CryptoErrorDomain::kProcessingNot Started	if the digest calculation was not initiated by a call of the Start() method
	CryptoErrorDomain::kInvalidUsage Order	if ProcessConfidentialData has already been called
Header file:	#include "ara/crypto/cryp/auth_cipher_ctx.h"	
Description:	Update the digest calculation by a new chunk of associated data.	

](RS_CRYPT_02302)

[SWS_CRYPT_20314]{DRAFT} [

Kind:	function	
Symbol:	UpdateAssociatedData(std::uint8_t in)	
Scope:	class ara::crypto::cryp::AuthCipherCtx	
Syntax:	virtual ara::core::Result<void> ara::crypto::cryp::AuthCipherCtx::UpdateAssociatedData (std::uint8_t in) noexcept=0;	
Parameters (in):	in	a byte value that is a part of input message
Return value:	ara::core::Result< void >	–
Exception Safety:	noexcept	
Thread Safety:	Thread-safe	
Errors:	CryptoErrorDomain::kProcessingNot Started	if the digest calculation was not initiated by a call of the Start() method
	CryptoErrorDomain::kInvalidUsage Order	if ProcessConfidentialData has already been called
Header file:	#include "ara/crypto/cryp/auth_cipher_ctx.h"	
Description:	Update the digest calculation by the specified Byte. This method is convenient for processing of constant tags.	

](RS_CRYPT_02302)

[SWS_CRYPT_29035]{DRAFT} [

Kind:	function	
Symbol:	GetActualIvBitLength(ara::core::Optional< CryptoObjectUid > ivUid)	
Scope:	class ara::crypto::cryp::BlockService	
Syntax:	virtual std::size_t ara::crypto::cryp::BlockService::GetActualIvBitLength (ara::core::Optional< CryptoObjectUid > ivUid) const noexcept=0;	
Parameters (in):	ivUid	optional pointer to a buffer for saving an COUID of a IV object now loaded to the context. If the context was initialized by a SecretSeed object then the output buffer *ivUid must be filled by COUID of this loaded IV object, in other cases *ivUid must be filled by all zeros.
Return value:	std::size_t	actual length of the IV (now set to the algorithm context) in bits
Exception Safety:	noexcept	
Thread Safety:	Thread-safe	
Header file:	#include "ara/crypto/cryp/block_service.h"	
Description:	Get actual bit-length of an IV loaded to the context.	

](RS_CRYPT_02309)

[SWS_CRYPT_29033]{DRAFT} [

Kind:	function	
Symbol:	GetBlockSize()	
Scope:	class ara::crypto::cryp::BlockService	
Syntax:	virtual std::size_t ara::crypto::cryp::BlockService::GetBlockSize () const noexcept=0;	
Return value:	std::size_t	size of the block in bytes
Exception Safety:	noexcept	
Thread Safety:	Thread-safe	
Header file:	#include "ara/crypto/cryp/block_service.h"	
Description:	Get block (or internal buffer) size of the base algorithm.	

](RS_CRYPT_02309)

[SWS_CRYPT_29032]{DRAFT} [

Kind:	function	
Symbol:	GetIvSize()	
Scope:	class ara::crypto::cryp::BlockService	
Syntax:	virtual std::size_t ara::crypto::cryp::BlockService::GetIvSize () const noexcept=0;	
Return value:	std::size_t	default expected size of IV in bytes
Exception Safety:	noexcept	
Thread Safety:	Thread-safe	
Header file:	#include "ara/crypto/cryp/block_service.h"	
Description:	Get default expected size of the Initialization Vector (IV) or nonce.	

](RS_CRYPT_02309)

[SWS_CRYPT_29034]{DRAFT} [

Kind:	function	
Symbol:	IsValidIvSize(std::size_t ivSize)	
Scope:	class ara::crypto::cryp::BlockService	
Syntax:	virtual bool ara::crypto::cryp::BlockService::IsValidIvSize (std::size_t ivSize) const noexcept=0;	
Parameters (in):	ivSize	the length of the IV in bytes
Return value:	bool	true if provided IV length is supported by the algorithm and false otherwise
Exception Safety:	noexcept	
Thread Safety:	Thread-safe	
Header file:	#include "ara/crypto/cryp/block_service.h"	
Description:	Verify validity of specific Initialization Vector (IV) length.	

] ([RS_CRYPT_02309](#))

[SWS_CRYPT_20401]{DRAFT} [

Kind:	function	
Symbol:	~CryptoContext()	
Scope:	class ara::crypto::cryp::CryptoContext	
Syntax:	virtual ara::crypto::cryp::CryptoContext::~~CryptoContext () noexcept=default;	
Exception Safety:	noexcept	
Header file:	#include "ara/crypto/cryp/crypto_context.h"	
Description:	Destructor.	

] ([RS_CRYPT_02008](#))

[SWS_CRYPT_20411]{DRAFT} [

Kind:	function	
Symbol:	GetCryptoPrimitiveId()	
Scope:	class ara::crypto::cryp::CryptoContext	
Syntax:	virtual CryptoPrimitiveId::Uptr ara::crypto::cryp::CryptoContext::GetCryptoPrimitiveId () const noexcept=0;	
Return value:	CryptoPrimitiveId::Uptr	–
Exception Safety:	noexcept	
Header file:	#include "ara/crypto/cryp/crypto_context.h"	
Description:	Return CryptoPrimitiveId instance containing instance identification.	

] ([RS_CRYPT_02008](#))

[SWS_CRYPT_20412]{DRAFT} [

Kind:	function	
Symbol:	IsInitialized()	
Scope:	class ara::crypto::cryp::CryptoContext	





Syntax:	virtual bool ara::crypto::cryp::CryptoContext::IsInitialized () const noexcept=0;	
Return value:	bool	true if the crypto context is completely initialized and ready to use, and false otherwise
Exception Safety:	noexcept	
Thread Safety:	Thread-safe	
Header file:	#include "ara/crypto/cryp/crypto_context.h"	
Description:	Check if the crypto context is already initialized and ready to use. It checks all required values, including: key value, IV/seed, etc.	

](RS_CRYPT_02309)

[SWS_CRYPT_30214]{DRAFT} [

Kind:	function	
Symbol:	operator=(const CryptoContext &other)	
Scope:	class ara::crypto::cryp::CryptoContext	
Syntax:	CryptoContext& ara::crypto::cryp::CryptoContext::operator= (const CryptoContext &other)=default;	
Parameters (in):	other	the other instance
Return value:	CryptoContext &	*this, containing the contents of other
Header file:	#include "ara/crypto/cryp/crypto_context.h"	
Description:	Copy-assign another CryptoContext to this instance.	

](RS_CRYPT_02004)

[SWS_CRYPT_30215]{DRAFT} [

Kind:	function	
Symbol:	operator=(CryptoContext &&other)	
Scope:	class ara::crypto::cryp::CryptoContext	
Syntax:	CryptoContext& ara::crypto::cryp::CryptoContext::operator= (CryptoContext &&other)=default;	
Parameters (in):	other	the other instance
Return value:	CryptoContext &	*this, containing the contents of other
Header file:	#include "ara/crypto/cryp/crypto_context.h"	
Description:	Move-assign another CryptoContext to this instance.	

](RS_CRYPT_02004)

[SWS_CRYPT_20654]{DRAFT} [

Kind:	function	
Symbol:	MyProvider()	
Scope:	class ara::crypto::cryp::CryptoContext	
Syntax:	virtual CryptoProvider& ara::crypto::cryp::CryptoContext::MyProvider () const noexcept=0;	
Return value:	CryptoProvider &	a reference to Crypto Provider instance that provides this context





Exception Safety:	noexcept
Thread Safety:	Thread-safe
Header file:	#include "ara/crypto/cryp/crypto_context.h"
Description:	Get a reference to Crypto Provider of this context.

]([RS_CRYPT_02401](#))

[SWS_CRYPT_20503]{DRAFT} [

Kind:	function
Symbol:	~CryptoObject()
Scope:	class ara::crypto::cryp::CryptoObject
Syntax:	virtual ara::crypto::cryp::CryptoObject::~~CryptoObject () noexcept=default;
Exception Safety:	noexcept
Header file:	#include "ara/crypto/cryp/cryobj/crypto_object.h"
Description:	Destructor.

]([RS_CRYPT_02005](#))

[SWS_CRYPT_20518]{DRAFT} [

Kind:	function	
Symbol:	Downcast(CryptoObject::Uptrc &&object)	
Scope:	class ara::crypto::cryp::CryptoObject	
Syntax:	template <class ConcreteObject> static ara::core::Result<typename ConcreteObject::Uptrc> ara::crypto::cryp::CryptoObject::Downcast (CryptoObject::Uptrc &&object) noexcept;	
Template param:	ConcreteObject	target type (derived from CryptoObject) for downcasting
Parameters (in):	object	unique smart pointer to the constant generic Crypto Object interface
Return value:	ara::core::Result< typename Concrete Object::Uptrc >	unique smart pointer to downcasted constant interface of specified derived type
Exception Safety:	noexcept	
Thread Safety:	Thread-safe	
Errors:	CryptoErrorDomain::kBadObjectType	if an actual type of the object is not the specified ConcreteObject
Header file:	#include "ara/crypto/cryp/cryobj/crypto_object.h"	
Description:	Downcast and move unique smart pointer from the generic CryptoObject interface to concrete derived object.	

]([RS_CRYPT_02005](#))

[SWS_CRYPT_20505]{DRAFT} [

Kind:	function
Symbol:	GetCryptoPrimitiveId()
Scope:	class ara::crypto::cryp::CryptoObject





Syntax:	virtual <code>CryptoPrimitiveId::Uptr</code> ara::crypto::cryp::CryptoObject::GetCryptoPrimitiveId () const noexcept=0;	
Return value:	<code>CryptoPrimitiveId::Uptr</code>	–
Exception Safety:	noexcept	
Header file:	#include "ara/crypto/cryp/cryobj/crypto_object.h"	
Description:	Return the CryptoPrimitiveId of this CryptoObject.	

|(RS_CRYPT_02005)

[SWS_CRYPT_20514]{DRAFT} [

Kind:	function	
Symbol:	GetObjectId()	
Scope:	class ara::crypto::cryp::CryptoObject	
Syntax:	virtual <code>COIdentifier</code> ara::crypto::cryp::CryptoObject::GetObjectId () const noexcept=0;	
Return value:	<code>COIdentifier</code>	the object's COIdentifier including the object's type and COUID (or an empty COUID, if this object is not identifiable).
Exception Safety:	noexcept	
Thread Safety:	Thread-safe	
Header file:	#include "ara/crypto/cryp/cryobj/crypto_object.h"	
Description:	Return the object's COIdentifier, which includes the object's type and UID. An object that has no assigned COUID cannot be (securely) serialized / exported or saved to a non-volatile storage. An object should not have a COUID if it is session and non-exportable simultaneously. A few related objects of different types can share a single COUID (e.g. private and public keys), but a combination of COUID and object type must be unique always!	

|(RS_CRYPT_02005)

[SWS_CRYPT_20516]{DRAFT} [

Kind:	function	
Symbol:	GetPayloadSize()	
Scope:	class ara::crypto::cryp::CryptoObject	
Syntax:	virtual <code>std::size_t</code> ara::crypto::cryp::CryptoObject::GetPayloadSize () const noexcept=0;	
Return value:	<code>std::size_t</code>	size in bytes of the object's payload required for its storage
Exception Safety:	noexcept	
Thread Safety:	Thread-safe	
Header file:	#include "ara/crypto/cryp/cryobj/crypto_object.h"	
Description:	Return actual size of the object's payload. Returned value always must be less than or equal to the maximum payload size expected for this primitive and object type, it is available via call: MyProvider().GetPayloadStorageSize(GetObjectType(), GetPrimitiveId()).Value(); Returned value does not take into account the object's meta-information properties, but their size is fixed and common for all crypto objects independently from their actual type. During an allocation of a TrustedContainer, Crypto Providers (and Key Storage Providers) reserve space for an object's meta-information automatically, according to their implementation details.	

|(RS_CRYPT_02309)

[SWS_CRYPT_20515]{DRAFT} [

Kind:	function	
Symbol:	HasDependence()	
Scope:	class ara::crypto::cryp::CryptoObject	
Syntax:	virtual COIdentifier ara::crypto::cryp::CryptoObject::HasDependence () const noexcept=0;	
Return value:	COIdentifier	target COIdentifier of the existing dependence or CryptoObjectType::kUnknown and empty COUID, if the current object does not depend on another CryptoObject
Exception Safety:	noexcept	
Thread Safety:	Thread-safe	
Header file:	#include "ara/crypto/cryp/cryobj/crypto_object.h"	
Description:	Return the COIdentifier of the CryptoObject that this CryptoObject depends on. For signatures objects this method must return a reference to correspondent signature verification public key! Unambiguous identification of a CryptoObject requires both components: CryptoObjectUid and CryptoObjectType.	

]([RS_CRYPT_02005](#))

[SWS_CRYPT_20513]{DRAFT} [

Kind:	function	
Symbol:	IsExportable()	
Scope:	class ara::crypto::cryp::CryptoObject	
Syntax:	virtual bool ara::crypto::cryp::CryptoObject::IsExportable () const noexcept=0;	
Return value:	bool	true if the object is exportable (i.e. if it can be exported outside the trusted environment of the Crypto Provider)
Exception Safety:	noexcept	
Thread Safety:	Thread-safe	
Header file:	#include "ara/crypto/cryp/cryobj/crypto_object.h"	
Description:	Get the exportability attribute of the crypto object. An exportable object must have an assigned COUID (see GetObjectld()).	

]([RS_CRYPT_02005](#))

[SWS_CRYPT_20512]{DRAFT} [

Kind:	function	
Symbol:	IsSession()	
Scope:	class ara::crypto::cryp::CryptoObject	
Syntax:	virtual bool ara::crypto::cryp::CryptoObject::IsSession () const noexcept=0;	
Return value:	bool	true if the object is temporay (i.e. its life time is limited by the current session only)
Exception Safety:	noexcept	
Thread Safety:	Thread-safe	
Header file:	#include "ara/crypto/cryp/cryobj/crypto_object.h"	





Description:	Return the "session" (or "temporary") attribute of the object. A temporary object cannot be saved to a persistent storage location pointed to by an IOInterface! A temporary object will be securely destroyed together with this interface instance! A non-session object must have an assigned COUID (see GetObjectId()).
---------------------	---

](RS_CRYPT_02003)

[SWS_CRYPT_20517]{DRAFT} [

Kind:	function	
Symbol:	Save(IOInterface &container)	
Scope:	class ara::crypto::cryp::CryptoObject	
Syntax:	virtual ara::core::Result<void> ara::crypto::cryp::CryptoObject::Save (IOInterface &container) const noexcept=0;	
Parameters (in):	container	IOInterface representing underlying storage
Return value:	ara::core::Result< void >	–
Exception Safety:	noexcept	
Thread Safety:	Thread-safe	
Errors:	CryptoErrorDomain::kIncompatible Object	if the object is "session", but the IOInterface represents a KeySlot.
	CryptoErrorDomain::kContent Restrictions	if the object doesn't satisfy the slot restrictions (
	CryptoErrorDomain::kInsufficient Capacity	if the capacity of the target container is not enough, i.e. if (container.Capacity() < this->StorageSize())
	CryptoErrorDomain::kModified Resource	if the underlying resource has been modified after the IOInterface has been opened, i.e., the IOInterface has been invalidated.
	CryptoErrorDomain::kUnreserved Resource	if the IOInterface is not opened writeable.
Header file:	#include "ara/crypto/cryp/cryobj/crypto_object.h"	
Description:	Save itself to provided IOInterface A CryptoObject with property "session" cannot be saved in a KeySlot.	

](RS_CRYPT_02004)

[SWS_CRYPT_30208]{DRAFT} [

Kind:	function	
Symbol:	operator=(const CryptoObject &other)	
Scope:	class ara::crypto::cryp::CryptoObject	
Syntax:	CryptoObject& ara::crypto::cryp::CryptoObject::operator= (const CryptoObject &other)=default;	
Parameters (in):	other	the other instance
Return value:	CryptoObject &	*this, containing the contents of other
Header file:	#include "ara/crypto/cryp/cryobj/crypto_object.h"	
Description:	Copy-assign another CryptoObject to this instance.	

](RS_CRYPT_02009)

[SWS_CRYPT_30209]{DRAFT} [

Kind:	function	
Symbol:	operator=(CryptoObject &&other)	
Scope:	class ara::crypto::cryp::CryptoObject	
Syntax:	<code>CryptoObject& ara::crypto::cryp::CryptoObject::operator= (CryptoObject &&other)=default;</code>	
Parameters (in):	other	the other instance
Return value:	CryptoObject &	*this, containing the contents of other
Header file:	#include "ara/crypto/cryp/cryobj/crypto_object.h"	
Description:	Move-assign another CryptoObject to this instance.	

] ([RS_CRYPT_02004](#))

[SWS_CRYPT_10808]{DRAFT} [

Kind:	function	
Symbol:	~CryptoPrimitiveld()	
Scope:	class ara::crypto::cryp::CryptoPrimitiveld	
Syntax:	<code>virtual ara::crypto::cryp::CryptoPrimitiveId::~~CryptoPrimitiveId () noexcept=default;</code>	
Exception Safety:	noexcept	
Header file:	#include "ara/crypto/cryp/cryobj/crypto_primitive_id.h"	
Description:	Destructor.	

] ([RS_CRYPT_02005](#))

[SWS_CRYPT_20652]{DRAFT} [

Kind:	function	
Symbol:	GetPrimitiveld()	
Scope:	class ara::crypto::cryp::CryptoPrimitiveld	
Syntax:	<code>virtual AlgId ara::crypto::cryp::CryptoPrimitiveId::GetPrimitiveId () const noexcept=0;</code>	
Return value:	AlgId	the binary Crypto Primitive ID
Exception Safety:	noexcept	
Thread Safety:	Thread-safe	
Header file:	#include "ara/crypto/cryp/cryobj/crypto_primitive_id.h"	
Description:	Get vendor specific ID of the primitive.	

] ([RS_CRYPT_02309](#))

[SWS_CRYPT_20651]{DRAFT} [

Kind:	function	
Symbol:	GetPrimitiveName()	
Scope:	class ara::crypto::cryp::CryptoPrimitiveld	
Syntax:	<code>virtual const ara::core::StringView ara::crypto::cryp::CryptoPrimitiveId::GetPrimitiveName () const noexcept=0;</code>	
Return value:	const ara::core::StringView	the unified name of the crypto primitive





Exception Safety:	noexcept
Thread Safety:	Thread-safe
Header file:	#include "ara/crypto/cryp/cryobj/crypto_primitive_id.h"
Description:	Get a unified name of the primitive. The crypto primitive name can be fully or partially specified (see "Crypto Primitives Naming Convention" for more details). The life-time of the returned StringView instance should not exceed the life-time of this CryptoPrimitiveId instance!

]([RS_CRYPT_02308](#))

[SWS_CRYPT_30212]{DRAFT} [

Kind:	function	
Symbol:	operator=(const CryptoPrimitiveId &other)	
Scope:	class ara::crypto::cryp::CryptoPrimitiveId	
Syntax:	CryptoPrimitiveId& ara::crypto::cryp::CryptoPrimitiveId::operator=(const CryptoPrimitiveId &other)=default;	
Parameters (in):	other	the other instance
Return value:	CryptoPrimitiveId &	*this, containing the contents of other
Header file:	#include "ara/crypto/cryp/cryobj/crypto_primitive_id.h"	
Description:	Copy-assign another CryptoPrimitiveId to this instance.	

]([RS_CRYPT_02004](#))

[SWS_CRYPT_30213]{DRAFT} [

Kind:	function	
Symbol:	operator=(CryptoPrimitiveId &&other)	
Scope:	class ara::crypto::cryp::CryptoPrimitiveId	
Syntax:	CryptoPrimitiveId& ara::crypto::cryp::CryptoPrimitiveId::operator=(CryptoPrimitiveId &&other)=default;	
Parameters (in):	other	the other instance
Return value:	CryptoPrimitiveId &	*this, containing the contents of other
Header file:	#include "ara/crypto/cryp/cryobj/crypto_primitive_id.h"	
Description:	Move-assign another CryptoPrimitiveId to this instance.	

]([RS_CRYPT_02004](#))

[SWS_CRYPT_20726]{DRAFT} [

Kind:	function	
Symbol:	AllocVolatileContainer(std::size_t capacity=0)	
Scope:	class ara::crypto::cryp::CryptoProvider	
Syntax:	virtual ara::core::Result<VolatileTrustedContainer::Uptr> ara::crypto::cryp::CryptoProvider::AllocVolatileContainer (std::size_t capacity=0) noexcept=0;	
Parameters (in):	capacity	the capacity required for this volatile trusted container (in bytes)
Return value:	ara::core::Result< VolatileTrusted Container::Uptr >	unique smart pointer to an allocated volatile trusted container
Exception Safety:	noexcept	





Thread Safety:	Thread-safe
Header file:	#include "ara/crypto/cryp/crypto_provider.h"
Description:	Allocate a Volatile (virtual) Trusted Container according to directly specified capacity. The Volatile Trusted Container can be used for execution of the import operations. Current process obtains the "Owner" rights for allocated Container. If (capacity == 0) then the capacity of the container will be selected automatically according to a maximal size of supported crypto objects. A few volatile (temporary) containers can coexist at same time without any affecting each-other.

]([RS_CRYPT_02005](#), [RS_CRYPT_02006](#))

[SWS_CRYPT_20727]{DRAFT} [

Kind:	function	
Symbol:	AllocVolatileContainer(std::pair< AlgId, CryptoObjectType > theObjectDef)	
Scope:	class ara::crypto::cryp::CryptoProvider	
Syntax:	virtual ara::core::Result<VolatileTrustedContainer::Uptr> ara::crypto::cryp::CryptoProvider::AllocVolatileContainer (std::pair< AlgId, CryptoObjectType > theObjectDef) noexcept=0;	
Parameters (in):	theObjectDef	the list of objects that can be stored to this volatile trusted container
Return value:	ara::core::Result< VolatileTrusted Container::Uptr >	unique smart pointer to an allocated volatile trusted container
Exception Safety:	noexcept	
Thread Safety:	Thread-safe	
Errors:	CryptoErrorDomain::kInvalidArgument	if unsupported combination of object type and algorithm ID presents in the list
Header file:	#include "ara/crypto/cryp/crypto_provider.h"	
Description:	Allocate a Volatile (virtual) Trusted Container according to indirect specification of a minimal required capacity for hosting of any listed object. The Volatile Trusted Container can be used for execution of the import operations. Current process obtains the "Owner" rights for allocated Container. Real container capacity is calculated as a maximal storage size of all listed objects.	

]([RS_CRYPT_02005](#), [RS_CRYPT_02006](#))

[SWS_CRYPT_20711]{DRAFT} [

Kind:	function	
Symbol:	ConvertToAlgId(ara::core::StringView primitiveName)	
Scope:	class ara::crypto::cryp::CryptoProvider	
Syntax:	virtual AlgId ara::crypto::cryp::CryptoProvider::ConvertToAlgId (ara::core::StringView primitiveName) const noexcept=0;	
Parameters (in):	primitiveName	the unified name of the crypto primitive (see "Crypto Primitives Naming Convention" for more details)
Return value:	AlgId	vendor specific binary algorithm ID or kAlgId Undefined if a primitive with provided name is not supported
Exception Safety:	noexcept	
Thread Safety:	Thread-safe	
Header file:	#include "ara/crypto/cryp/crypto_provider.h"	
Description:	Convert a common name of crypto algorithm to a correspondent vendor specific binary algorithm ID.	

]([RS_CRYPT_02308](#))

[SWS_CRYPT_20712]{DRAFT} [

Kind:	function	
Symbol:	ConvertToAlgName(AlgId algId)	
Scope:	class ara::crypto::cryp::CryptoProvider	
Syntax:	virtual ara::core::Result<ara::core::String> ara::crypto::cryp::CryptoProvider::ConvertToAlgName (AlgId algId) const noexcept=0;	
Parameters (in):	algId	the vendor specific binary algorithm ID
Return value:	ara::core::Result< ara::core::String >	the common name of the crypto algorithm (see "Crypto Primitives Naming Convention" for more details)
Exception Safety:	noexcept	
Thread Safety:	Thread-safe	
Errors:	CryptoErrorDomain::kUnknown Identifier	if algId argument has an unsupported value
Header file:	#include "ara/crypto/cryp/crypto_provider.h"	
Description:	Convert a vendor specific binary algorithm ID to a correspondent common name of the crypto algorithm.	

] ([RS_CRYPT_02308](#))

[SWS_CRYPT_20745]{DRAFT} [

Kind:	function	
Symbol:	CreateAuthCipherCtx(AlgId algId)	
Scope:	class ara::crypto::cryp::CryptoProvider	
Syntax:	virtual ara::core::Result<AuthCipherCtx::Uptr> ara::crypto::cryp::CryptoProvider::CreateAuthCipherCtx (AlgId algId) noexcept=0;	
Parameters (in):	algId	identifier of the target crypto algorithm
Return value:	ara::core::Result< AuthCipherCtx::Uptr >	unique smart pointer to the created context
Exception Safety:	noexcept	
Thread Safety:	Thread-safe	
Errors:	CryptoErrorDomain::kInvalidArgument	if algId argument specifies a crypto algorithm different from symmetric authenticated stream cipher
	CryptoErrorDomain::kInvalidArgument	–
	CryptoErrorDomain::kUnknown Identifier	if algId argument has an unsupported value
Header file:	#include "ara/crypto/cryp/crypto_provider.h"	
Description:	Create a symmetric authenticated cipher context.	

] ([RS_CRYPT_02207](#), [RS_AP_00144](#))

[SWS_CRYPT_20751]{DRAFT} [

Kind:	function	
Symbol:	CreateDecryptorPrivateCtx(AlgId algId)	
Scope:	class ara::crypto::cryp::CryptoProvider	





Syntax:	virtual ara::core::Result<DecryptorPrivateCtx::Uptr> ara::crypto::cryp::CryptoProvider::CreateDecryptorPrivateCtx (AlgId algId) noexcept=0;	
Parameters (in):	algId	identifier of the target asymmetric encryption/ decryption algorithm
Return value:	ara::core::Result< DecryptorPrivate Ctx::Uptr >	unique smart pointer to the created context
Exception Safety:	noexcept	
Thread Safety:	Thread-safe	
Errors:	CryptoErrorDomain::kInvalidArgument	if algId argument specifies a crypto algorithm different from asymmetric encryption/decryption
	CryptoErrorDomain::kUnknown Identifier	if algId argument has an unsupported value
Header file:	#include "ara/crypto/cryp/crypto_provider.h"	
Description:	Create a decryption private key context.	

](RS_CRYPT_02202, RS_AP_00144)

[SWS_CRYPT_20750]{DRAFT} [

Kind:	function	
Symbol:	CreateEncryptorPublicCtx(AlgId algId)	
Scope:	class ara::crypto::cryp::CryptoProvider	
Syntax:	virtual ara::core::Result<EncryptorPublicCtx::Uptr> ara::crypto::cryp::CryptoProvider::CreateEncryptorPublicCtx (AlgId alg Id) noexcept=0;	
Parameters (in):	algId	identifier of the target asymmetric encryption/ decryption algorithm
Return value:	ara::core::Result< EncryptorPublic Ctx::Uptr >	unique smart pointer to the created context
Exception Safety:	noexcept	
Thread Safety:	Thread-safe	
Errors:	CryptoErrorDomain::kInvalidArgument	if algId argument specifies a crypto algorithm different from asymmetric encryption/decryption
	CryptoErrorDomain::kUnknown Identifier	if algId argument has an unsupported value
Header file:	#include "ara/crypto/cryp/crypto_provider.h"	
Description:	Create an encryption public key context.	

](RS_CRYPT_02202, RS_AP_00144)

[SWS_CRYPT_20761]{DRAFT} [

Kind:	function	
Symbol:	CreateHashDigest(AlgId hashAlgId, ReadOnlyMemRegion value)	
Scope:	class ara::crypto::cryp::CryptoProvider	
Syntax:	virtual ara::core::Result<Signature::Uptr> ara::crypto::cryp::Crypto Provider::CreateHashDigest (AlgId hashAlgId, ReadOnlyMemRegion value) noexcept=0;	
Parameters (in):	hashAlgId	identifier of an applied hash function crypto algorithm





	value	raw BLOB value of the hash digest
Return value:	ara::core::Result< Signature::Uptr >	unique smart pointer to the created Signature object
Exception Safety:	noexcept	
Thread Safety:	Thread-safe	
Errors:	CryptoErrorDomain::kUnknown Identifier	if hashAlgId argument has unsupported value
	CryptoErrorDomain::kInvalidArgument	if hashAlgId argument specifies crypto algorithm different from a hash function
	CryptoErrorDomain::kInvalidInputSize	if the value argument has invalid size (i.e. incompatible with the hashAlgId argument)
Header file:	#include "ara/crypto/cryp/crypto_provider.h"	
Description:	Construct Signature object from directly provided components of a hash digest.	

]([RS_CRYPT_02005](#), [RS_CRYPT_02006](#), [RS_AP_00144](#))

[SWS_CRYPT_20747]{DRAFT} [

Kind:	function	
Symbol:	CreateHashFunctionCtx(AlgId algId)	
Scope:	class ara::crypto::cryp::CryptoProvider	
Syntax:	virtual ara::core::Result<HashFunctionCtx::Uptr> ara::crypto::cryp::CryptoProvider::CreateHashFunctionCtx (AlgId algId) noexcept=0;	
Parameters (in):	algId	identifier of the target crypto algorithm
Return value:	ara::core::Result< HashFunction Ctx::Uptr >	unique smart pointer to the created context
Exception Safety:	noexcept	
Thread Safety:	Thread-safe	
Errors:	CryptoErrorDomain::kInvalidArgument	if algId argument specifies a crypto algorithm different from hash function
	CryptoErrorDomain::kUnknown Identifier	if algId argument has an unsupported value
Header file:	#include "ara/crypto/cryp/crypto_provider.h"	
Description:	Create a hash function context.	

]([RS_CRYPT_02205](#), [RS_AP_00144](#))

[SWS_CRYPT_20758]{DRAFT} [

Kind:	function	
Symbol:	CreateKeyAgreementPrivateCtx(AlgId algId)	
Scope:	class ara::crypto::cryp::CryptoProvider	
Syntax:	virtual ara::core::Result<KeyAgreementPrivateCtx::Uptr> ara::crypto::cryp::CryptoProvider::CreateKeyAgreementPrivateCtx (AlgId algId) noexcept=0;	
Parameters (in):	algId	identifier of the target key-agreement crypto algorithm
Return value:	ara::core::Result< KeyAgreement PrivateCtx::Uptr >	unique smart pointer to the created context
Exception Safety:	noexcept	





Thread Safety:	Thread-safe	
Errors:	CryptoErrorDomain::kInvalidArgument	if algId argument specifies a crypto algorithm different from key-agreement
	CryptoErrorDomain::kUnknown Identifier	if algId argument has an unsupported value
Header file:	#include "ara/crypto/cryp/crypto_provider.h"	
Description:	Create a key-agreement private key context.	

]([RS_CRYPT_02104](#), [RS_AP_00144](#))

[SWS_CRYPT_20753]{DRAFT} [

Kind:	function	
Symbol:	CreateKeyDecapsulatorPrivateCtx(AlgId algId)	
Scope:	class ara::crypto::cryp::CryptoProvider	
Syntax:	virtual ara::core::Result<KeyDecapsulatorPrivateCtx::Uptr> ara::crypto::cryp::CryptoProvider::CreateKeyDecapsulatorPrivateCtx (AlgId algId) noexcept=0;	
Parameters (in):	algId	identifier of the target KEM crypto algorithm
Return value:	ara::core::Result< KeyDecapsulator PrivateCtx::Uptr >	unique smart pointer to the created context
Exception Safety:	noexcept	
Thread Safety:	Thread-safe	
Errors:	CryptoErrorDomain::kInvalidArgument	if algId argument specifies a crypto algorithm different from asymmetric KEM
	CryptoErrorDomain::kUnknown Identifier	if algId argument has an unsupported value
Header file:	#include "ara/crypto/cryp/crypto_provider.h"	
Description:	Create a key-decapsulator private key context of a Key Encapsulation Mechanism (KEM).	

]([RS_CRYPT_02104](#), [RS_CRYPT_02209](#), [RS_AP_00144](#))

[SWS_CRYPT_20748]{DRAFT} [

Kind:	function	
Symbol:	CreateKeyDerivationFunctionCtx(AlgId algId)	
Scope:	class ara::crypto::cryp::CryptoProvider	
Syntax:	virtual ara::core::Result<KeyDerivationFunctionCtx::Uptr> ara::crypto::cryp::CryptoProvider::CreateKeyDerivationFunctionCtx (Alg Id algId) noexcept=0;	
Parameters (in):	algId	identifier of the target crypto algorithm
Return value:	ara::core::Result< KeyDerivation FunctionCtx::Uptr >	unique smart pointer to the created context
Exception Safety:	noexcept	
Thread Safety:	Thread-safe	
Errors:	CryptoErrorDomain::kInvalidArgument	if algId argument specifies a crypto algorithm different from key derivation function
	CryptoErrorDomain::kUnknown Identifier	if algId argument has an unsupported value
Header file:	#include "ara/crypto/cryp/crypto_provider.h"	
Description:	Create a key derivation function context.	

]([RS_CRYPT_02103](#), [RS_AP_00144](#))

[SWS_CRYPT_20752]{DRAFT} [

Kind:	function	
Symbol:	CreateKeyEncapsulatorPublicCtx(AlgId algId)	
Scope:	class ara::crypto::cryp::CryptoProvider	
Syntax:	virtual ara::core::Result<KeyEncapsulatorPublicCtx::Uptr> ara::crypto::cryp::CryptoProvider::CreateKeyEncapsulatorPublicCtx (AlgId algId) noexcept=0;	
Parameters (in):	algId	identifier of the target KEM crypto algorithm
Return value:	ara::core::Result< KeyEncapsulatorPublicCtx::Uptr >	unique smart pointer to the created context
Exception Safety:	noexcept	
Thread Safety:	Thread-safe	
Errors:	CryptoErrorDomain::kInvalidArgument	if algId argument specifies a crypto algorithm different from asymmetric KEM
	CryptoErrorDomain::kUnknownIdentifier	if algId argument has an unsupported value
Header file:	#include "ara/crypto/cryp/crypto_provider.h"	
Description:	Create a key-encapsulator public key context of a Key Encapsulation Mechanism (KEM).	

]([RS_CRYPT_02104](#), [RS_CRYPT_02209](#), [RS_AP_00144](#))

[SWS_CRYPT_20746]{DRAFT} [

Kind:	function	
Symbol:	CreateMessageAuthnCodeCtx(AlgId algId)	
Scope:	class ara::crypto::cryp::CryptoProvider	
Syntax:	virtual ara::core::Result<MessageAuthnCodeCtx::Uptr> ara::crypto::cryp::CryptoProvider::CreateMessageAuthnCodeCtx (AlgId algId) noexcept=0;	
Parameters (in):	algId	identifier of the target crypto algorithm
Return value:	ara::core::Result< MessageAuthnCodeCtx::Uptr >	unique smart pointer to the created context
Exception Safety:	noexcept	
Thread Safety:	Thread-safe	
Errors:	CryptoErrorDomain::kInvalidArgument	if algId argument specifies a crypto algorithm different from symmetric message authentication code
	CryptoErrorDomain::kUnknownIdentifier	if algId argument has an unsupported value
Header file:	#include "ara/crypto/cryp/crypto_provider.h"	
Description:	Create a symmetric message authentication code context.	

]([RS_CRYPT_02203](#), [RS_AP_00144](#))

[SWS_CRYPT_20755]{DRAFT} [

Kind:	function	
Symbol:	CreateMsgRecoveryPublicCtx(AlgId algId)	
Scope:	class ara::crypto::cryp::CryptoProvider	





Syntax:	virtual ara::core::Result<MsgRecoveryPublicCtx::Uptr> ara::crypto::cryp::CryptoProvider::CreateMsgRecoveryPublicCtx (AlgId algId) noexcept=0;	
Parameters (in):	algId	identifier of the target asymmetric crypto algorithm
Return value:	ara::core::Result< MsgRecoveryPublic Ctx::Uptr >	unique smart pointer to the created context
Exception Safety:	noexcept	
Thread Safety:	Thread-safe	
Errors:	CryptoErrorDomain::kInvalidArgument	if algId argument specifies a crypto algorithm different from asymmetric signature encoding with message recovery
	CryptoErrorDomain::kUnknown Identifier	if algId argument has an unsupported value
Header file:	#include "ara/crypto/cryp/crypto_provider.h"	
Description:	Create a message recovery public key context.	

]([RS_CRYPT_02202](#), [RS_CRYPT_02204](#), [RS_AP_00144](#))

[SWS_CRYPT_20741]{DRAFT} [

Kind:	function	
Symbol:	CreateRandomGeneratorCtx(AlgId algId=kAlgIdDefault, bool initialize=true)	
Scope:	class ara::crypto::cryp::CryptoProvider	
Syntax:	virtual ara::core::Result<RandomGeneratorCtx::Uptr> ara::crypto::cryp::CryptoProvider::CreateRandomGeneratorCtx (AlgId alg Id=kAlgIdDefault, bool initialize=true) noexcept=0;	
Parameters (in):	algId	identifier of target RNG algorithm. If no algId is given, the default RNG is returned
	initialize	indicates whether the returned context shall be initialized (i.e., seeded) by the stack
Return value:	ara::core::Result< RandomGenerator Ctx::Uptr >	unique smart pointer to the created RNG context
Exception Safety:	noexcept	
Thread Safety:	Thread-safe	
Errors:	CryptoErrorDomain::kUnknown Identifier	if algId argument has an unsupported value or if (alg Id == kAlgIdDefault) and the CryptoProvider does not provide any RandomGeneratorCtx
	CryptoErrorDomain::kBusyResource	if (initialize == true) but the context currently cannot be seeded (e.g., due to a lack of entropy)
Header file:	#include "ara/crypto/cryp/crypto_provider.h"	
Description:	Create a Random Number Generator (RNG) context.	

]([RS_CRYPT_02206](#))

[SWS_CRYPT_20754]{DRAFT} [

Kind:	function	
Symbol:	CreateSigEncodePrivateCtx(AlgId algId)	
Scope:	class ara::crypto::cryp::CryptoProvider	





Syntax:	virtual ara::core::Result<SigEncodePrivateCtx::Uptr> ara::crypto::cryp::CryptoProvider::CreateSigEncodePrivateCtx (AlgId algId) noexcept=0;	
Parameters (in):	algId	identifier of the target asymmetric crypto algorithm
Return value:	ara::core::Result< SigEncodePrivate Ctx::Uptr >	unique smart pointer to the created context
Exception Safety:	noexcept	
Thread Safety:	Thread-safe	
Errors:	CryptoErrorDomain::kInvalidArgument	if algId argument specifies a crypto algorithm different from asymmetric signature encoding with message recovery
	CryptoErrorDomain::kUnknown Identifier	if algId argument has an unsupported value
Header file:	#include "ara/crypto/cryp/crypto_provider.h"	
Description:	Create a signature encoding private key context.	

]([RS_CRYPT_02202](#), [RS_CRYPT_02204](#), [RS_AP_00144](#))

[SWS_CRYPT_20760]{DRAFT} [

Kind:	function	
Symbol:	CreateSignature(AlgId signAlgId, ReadOnlyMemRegion value, const RestrictedUseObject &key, AlgId hashAlgId=kAlgIdNone)	
Scope:	class ara::crypto::cryp::CryptoProvider	
Syntax:	virtual ara::core::Result<Signature::Uptr> ara::crypto::cryp::CryptoProvider::CreateSignature (AlgId signAlgId, ReadOnlyMemRegion value, const RestrictedUseObject &key, AlgId hashAlgId=kAlgIdNone) noexcept=0;	
Parameters (in):	signAlgId	identifier of an applied signature/MAC/AE/AEAD crypto algorithm
	value	raw BLOB value of the signature/MAC
	key	symmetric or asymmetric key (according to signAlgId) applied for the sign or MAC/AE/AEAD operation
	hashAlgId	identifier of a hash function algorithm applied together with the signature algorithm
Return value:	ara::core::Result< Signature::Uptr >	unique smart pointer to the created Signature object
Exception Safety:	noexcept	
Thread Safety:	Thread-safe	
Errors:	CryptoErrorDomain::kUnknown Identifier	if signAlgId or hashAlgId arguments have unsupported values
	CryptoErrorDomain::kInvalidArgument	if signAlgId or hashAlgId arguments specify crypto algorithms different from the signature/MAC/AE/AEAD and message digest respectively
	CryptoErrorDomain::kIncompatible Arguments	if signAlgId and hashAlgId arguments specify incompatible algorithms (if signAlgId includes hash function specification) or if a crypto primitive associated with the key argument is incompatible with provided signAlgId or hashAlgId arguments
	CryptoErrorDomain::kInvalidInputSize	if the value argument has invalid size (i.e. incompatible with the signAlgId argument)
Header file:	#include "ara/crypto/cryp/crypto_provider.h"	





Description:	Construct Signature object from directly provided components of a digital signature/MAC or authenticated encryption (AE/AEAD). All integers inside a digital signature BLOB value are always presented in Big Endian bytes order (i.e. MSF - Most Significant byte First).
---------------------	--

]([RS_CRYPTO_02005](#), [RS_CRYPTO_02006](#), [RS_AP_00144](#))

[SWS_CRYPT_20756]{DRAFT} [

Kind:	function	
Symbol:	CreateSignerPrivateCtx(AlgId algId)	
Scope:	class ara::crypto::cryp::CryptoProvider	
Syntax:	virtual ara::core::Result<SignerPrivateCtx::Uptr> ara::crypto::cryp::CryptoProvider::CreateSignerPrivateCtx (AlgId algId) noexcept=0;	
Parameters (in):	algId	identifier of the target signature crypto algorithm
Return value:	ara::core::Result< SignerPrivateCtx::Uptr >	unique smart pointer to the created context
Exception Safety:	noexcept	
Thread Safety:	Thread-safe	
Errors:	CryptoErrorDomain::kInvalidArgument	if algId argument specifies a crypto algorithm different from private key signature
	CryptoErrorDomain::kUnknownIdentifier	if algId argument has an unsupported value
Header file:	#include "ara/crypto/cryp/crypto_provider.h"	
Description:	Create a signature private key context.	

]([RS_CRYPTO_02204](#), [RS_AP_00144](#))

[SWS_CRYPT_20744]{DRAFT} [

Kind:	function	
Symbol:	CreateStreamCipherCtx(AlgId algId)	
Scope:	class ara::crypto::cryp::CryptoProvider	
Syntax:	virtual ara::core::Result<StreamCipherCtx::Uptr> ara::crypto::cryp::CryptoProvider::CreateStreamCipherCtx (AlgId algId) noexcept=0;	
Parameters (in):	algId	identifier of the target crypto algorithm
Return value:	ara::core::Result< StreamCipherCtx::Uptr >	unique smart pointer to the created context
Exception Safety:	noexcept	
Thread Safety:	Thread-safe	
Errors:	CryptoErrorDomain::kInvalidArgument	if algId argument specifies a crypto algorithm different from symmetric stream cipher
	CryptoErrorDomain::kUnknownIdentifier	if algId argument has an unsupported value
Header file:	#include "ara/crypto/cryp/crypto_provider.h"	
Description:	Create a symmetric stream cipher context.	

]([RS_CRYPTO_02201](#))

[SWS_CRYPT_20742]{DRAFT} [

Kind:	function	
Symbol:	CreateSymmetricBlockCipherCtx(AlgId algId)	
Scope:	class ara::crypto::cryp::CryptoProvider	
Syntax:	virtual ara::core::Result<SymmetricBlockCipherCtx::Uptr> ara::crypto::cryp::CryptoProvider::CreateSymmetricBlockCipherCtx (AlgId algId) noexcept=0;	
Parameters (in):	algId	identifier of the target crypto algorithm
Return value:	ara::core::Result< SymmetricBlock CipherCtx::Uptr >	unique smart pointer to the created context
Exception Safety:	noexcept	
Thread Safety:	Thread-safe	
Errors:	CryptoErrorDomain::kUnknown Identifier	if algId argument has an unsupported value
Header file:	#include "ara/crypto/cryp/crypto_provider.h"	
Description:	Create a symmetric block cipher context.	

] ([RS_CRYPT_02201](#))

[SWS_CRYPT_20743]{DRAFT} [

Kind:	function	
Symbol:	CreateSymmetricKeyWrapperCtx(AlgId algId)	
Scope:	class ara::crypto::cryp::CryptoProvider	
Syntax:	virtual ara::core::Result<SymmetricKeyWrapperCtx::Uptr> ara::crypto::cryp::CryptoProvider::CreateSymmetricKeyWrapperCtx (AlgId algId) noexcept=0;	
Parameters (in):	algId	identifier of the target crypto algorithm
Return value:	ara::core::Result< SymmetricKey WrapperCtx::Uptr >	unique smart pointer to the created context
Exception Safety:	noexcept	
Thread Safety:	Thread-safe	
Errors:	CryptoErrorDomain::kInvalidArgument	if algId argument specifies a crypto algorithm different from symmetric key-wrapping
	CryptoErrorDomain::kUnknown Identifier	if algId argument has an unsupported value
Header file:	#include "ara/crypto/cryp/crypto_provider.h"	
Description:	Create a symmetric key-wrap algorithm context.	

] ([RS_CRYPT_02104](#), [RS_CRYPT_02208](#))

[SWS_CRYPT_20757]{DRAFT} [

Kind:	function	
Symbol:	CreateVerifierPublicCtx(AlgId algId)	
Scope:	class ara::crypto::cryp::CryptoProvider	
Syntax:	virtual ara::core::Result<VerifierPublicCtx::Uptr> ara::crypto::cryp::CryptoProvider::CreateVerifierPublicCtx (AlgId algId) noexcept=0;	
Parameters (in):	algId	identifier of the target signature crypto algorithm





Return value:	ara::core::Result< VerifierPublic Ctx::Uptr >	unique smart pointer to the created context
Exception Safety:	noexcept	
Thread Safety:	Thread-safe	
Errors:	CryptoErrorDomain::kInvalidArgument	if algId argument specifies a crypto algorithm different from public key signature verification
	CryptoErrorDomain::kUnknown Identifier	if algId argument has an unsupported value
Header file:	#include "ara/crypto/cryp/crypto_provider.h"	
Description:	Create a signature verification public key context.	

|(RS_CRYPT_02204, RS_AP_00144)

[SWS_CRYPT_20710]{DRAFT} [

Kind:	function
Symbol:	~CryptoProvider()
Scope:	class ara::crypto::cryp::CryptoProvider
Syntax:	virtual ara::crypto::cryp::CryptoProvider::~~CryptoProvider () noexcept=default;
Exception Safety:	noexcept
Header file:	#include "ara/crypto/cryp/crypto_provider.h"
Description:	Destructor.

|(RS_CRYPT_02107)

[SWS_CRYPT_20731]{DRAFT} [

Kind:	function	
Symbol:	ExportPublicObject(const IOInterface &container, Serializable::FormatId format Id=Serializable::kFormatDefault)	
Scope:	class ara::crypto::cryp::CryptoProvider	
Syntax:	virtual ara::core::Result<ara::core::Vector<ara::core::Byte> > ara::crypto::cryp::CryptoProvider::ExportPublicObject (const IOInterface &container, Serializable::FormatId format Id=Serializable::kFormatDefault) noexcept=0;	
Parameters (in):	container	the IOInterface that contains an object for export
	formatId	the CryptoProvider specific identifier of the output format
Return value:	ara::core::Result< ara::core::Vector< ara::core::Byte > >	actual capacity required for the serialized data
Exception Safety:	noexcept	
Thread Safety:	Thread-safe	
Errors:	CryptoErrorDomain::kEmptyContainer	if the container is empty
	CryptoErrorDomain::kUnexpected Value	if the container contains a secret crypto object
	CryptoErrorDomain::kInsufficient Capacity	if (serialized.empty() == false), but its capacity is not enough for storing result
	CryptoErrorDomain::kModified Resource	if the underlying resource has been modified after the IOInterface has been opened, i.e., the IOInterface has been invalidated.





Header file:	#include "ara/crypto/cryp/crypto_provider.h"
Description:	Export publicly an object from a IOInterface (i.e. without an intermediate creation of a crypto object).

]([RS_CRYPT_02105](#), [RS_CRYPT_02112](#))

[SWS_CRYPT_20728]{DRAFT} [

Kind:	function	
Symbol:	ExportSecuredObject(const CryptoObject &object, SymmetricKeyWrapperCtx &transport Context)	
Scope:	class ara::crypto::cryp::CryptoProvider	
Syntax:	virtual ara::core::Result<ara::core::Vector<ara::core::Byte> > ara::crypto::cryp::CryptoProvider::ExportSecuredObject (const Crypto Object &object, SymmetricKeyWrapperCtx &transportContext) noexcept=0;	
Parameters (in):	object	the crypto object for export
	transportContext	the symmetric key wrap context initialized by a transport key (allowed usage: kAllowKeyExporting)
Return value:	ara::core::Result< ara::core::Vector< ara::core::Byte > >	the wrapped crypto object data
Exception Safety:	noexcept	
Thread Safety:	Thread-safe	
Errors:	CryptoErrorDomain::kIncompatible Object	if the object cannot be exported due to Is Exportable() returning false
	CryptoErrorDomain::kIncompleteArg State	if the transportContext is not initialized
	CryptoErrorDomain::kIncompatible Object	if a key loaded to the transportContext doesn't have required attributes (note: it is an optional error condition for this method)
Header file:	#include "ara/crypto/cryp/crypto_provider.h"	
Description:	Export a crypto object in a secure manner. if (serialized.empty() == true) then the method returns required size only, but content of the transportContext stays unchanged! Only an exportable and completed object (i.e. that have a UUID) can be exported!	

]([RS_CRYPT_02105](#), [RS_CRYPT_02112](#))

[SWS_CRYPT_20729]{DRAFT} [

Kind:	function	
Symbol:	ExportSecuredObject(const IOInterface &container, SymmetricKeyWrapperCtx &transport Context)	
Scope:	class ara::crypto::cryp::CryptoProvider	
Syntax:	virtual ara::core::Result<ara::core::Vector<ara::core::Byte> > ara::crypto::cryp::CryptoProvider::ExportSecuredObject (const IOInterface &container, SymmetricKeyWrapperCtx &transportContext) noexcept=0;	
Parameters (in):	container	the IOInterface that refers an object for export
	transportContext	the symmetric key wrap context initialized by a transport key (allowed usage: kAllowKeyExporting)
Return value:	ara::core::Result< ara::core::Vector< ara::core::Byte > >	actual capacity required for the serialized data
Exception Safety:	noexcept	





Thread Safety:	Thread-safe	
Errors:	CryptoErrorDomain::kEmptyContainer	if the container is empty
	CryptoErrorDomain::kInsufficientCapacity	if size of the serialized buffer is not enough for saving the output data
	CryptoErrorDomain::kIncompleteArgState	if the transportContext is not initialized
	CryptoErrorDomain::kIncompatibleObject	if a key loaded to the transportContext doesn't have required attributes (note: it is an optional error condition for this method)
	CryptoErrorDomain::kModifiedResource	if the underlying resource has been modified after the IOInterface has been opened, i.e., the IOInterface has been invalidated.
Header file:	#include "ara/crypto/cryp/crypto_provider.h"	
Description:	Export securely an object directly from an IOInterface (i.e. without an intermediate creation of a crypto object). if (serialized == nullptr) then the method returns required size only, but content of the transportContext stays unchanged. This method can be used for re-exporting of just imported object but on another transport key.	

]([RS_CRYPT_02105](#), [RS_CRYPT_02112](#))

[SWS_CRYPT_20722]{DRAFT} [

Kind:	function	
Symbol:	GeneratePrivateKey(AlgId algId, AllowedUsageFlags allowedUsage, bool isSession=false, bool isExportable=false)	
Scope:	class ara::crypto::cryp::CryptoProvider	
Syntax:	virtual ara::core::Result<PrivateKey::Uptr> ara::crypto::cryp::CryptoProvider::GeneratePrivateKey (AlgId algId, AllowedUsageFlags allowedUsage, bool isSession=false, bool isExportable=false) noexcept=0;	
Parameters (in):	algId	the identifier of target public-private key crypto algorithm
	allowedUsage	the flags that define a list of allowed transformations' types in which the target key can be used (see constants in scope of RestrictedUseObject)
	isSession	the "session" (or "temporary") attribute for the target key (if true)
	isExportable	the exportability attribute of the target key (if true)
Return value:	ara::core::Result< PrivateKey::Uptr >	smart unique pointer to the created private key object
Exception Safety:	noexcept	
Thread Safety:	Thread-safe	
Errors:	CryptoErrorDomain::kUnknownIdentifier	if algId has an unsupported value
	CryptoErrorDomain::kIncompatibleArguments	if allowedUsage argument is incompatible with target algorithm algId (note: it is an optional error condition for this method)
Header file:	#include "ara/crypto/cryp/crypto_provider.h"	
Description:	Allocate a new private key context of correspondent type and generates the key value randomly. A common COUID should be shared for both private and public keys. Any serializable (i.e. savable/non-session or exportable) key must generate own COUID!	

]([RS_CRYPT_02003](#), [RS_CRYPT_02101](#), [RS_CRYPT_02102](#), [RS_CRYPT_02107](#), [RS_CRYPT_02108](#), [RS_CRYPT_02111](#), [RS_CRYPT_02115](#))

[SWS_CRYPT_20723]{DRAFT} [

Kind:	function	
Symbol:	GenerateSeed(AlgId algId, SecretSeed::Usage allowedUsage, bool isSession=true, bool isExportable=false)	
Scope:	class ara::crypto::cryp::CryptoProvider	
Syntax:	virtual ara::core::Result< SecretSeed::Uptrc > ara::crypto::cryp::CryptoProvider::GenerateSeed (AlgId algId, SecretSeed::Usage allowedUsage, bool isSession=true, bool isExportable=false) noexcept=0;	
Parameters (in):	algId	the identifier of target crypto algorithm
	allowedUsage	the lags that define a list of allowed transformations' types in which the target seed can be used (see constants in scope of RestrictedUseObject)
	isSession	the "session" (or "temporary") attribute of the target seed (if true)
	isExportable	the exportability attribute of the target seed (if true)
Return value:	ara::core::Result< SecretSeed::Uptrc >	unique smart pointer to generated SecretSeed object
Exception Safety:	noexcept	
Thread Safety:	Thread-safe	
Errors:	CryptoErrorDomain::kUnknown Identifier	if algId has an unsupported value
	CryptoErrorDomain::kIncompatible Arguments	if allowedUsage argument is incompatible with target algorithm algId (note: it is an optional error condition for this method)
Header file:	#include "ara/crypto/cryp/crypto_provider.h"	
Description:	Generate a random Secret Seed object of requested algorithm.	

]([RS_CRYPT_02007](#))

[SWS_CRYPT_20721]{DRAFT} [

Kind:	function	
Symbol:	GenerateSymmetricKey(AlgId algId, AllowedUsageFlags allowedUsage, bool isSession=true, bool isExportable=false)	
Scope:	class ara::crypto::cryp::CryptoProvider	
Syntax:	virtual ara::core::Result< SymmetricKey::Uptrc > ara::crypto::cryp::CryptoProvider::GenerateSymmetricKey (AlgId algId, AllowedUsageFlags allowedUsage, bool isSession=true, bool isExportable=false) noexcept=0;	
Parameters (in):	algId	the identifier of target symmetric crypto algorithm
	allowedUsage	the flags that define a list of allowed transformations' types in which the target key can be used (see constants in scope of RestrictedUseObject)
	isSession	the "session" (or "temporary") attribute of the target key (if true)
	isExportable	the exportability attribute of the target key (if true)
Return value:	ara::core::Result< Symmetric Key::Uptrc >	smart unique pointer to the created symmetric key object
Exception Safety:	noexcept	
Thread Safety:	Thread-safe	
Errors:	CryptoErrorDomain::kUnknown Identifier	if algId has an unsupported value





	CryptoErrorDomain::kIncompatible Arguments	if allowedUsage argument is incompatible with target algorithm algId (note: it is an optional error condition for this method)
Header file:	#include "ara/crypto/cryp/crypto_provider.h"	
Description:	Allocate a new symmetric key object and fill it by a new randomly generated value. Any serializable (i.e. savable/non-session or exportable) key must generate own COUID! By default Crypto Provider should use an internal instance of a best from all supported RNG (ideally TRNG).	

|(RS_CRYPT_02003, RS_CRYPT_02101, RS_CRYPT_02102, RS_CRYPT_02107, RS_CRYPT_02108, RS_CRYPT_02111, RS_CRYPT_02115)

[SWS_CRYPT_20725]{DRAFT} [

Kind:	function	
Symbol:	GetPayloadStorageSize(CryptoObjectType cryptoObjectType, AlgId algId)	
Scope:	class ara::crypto::cryp::CryptoProvider	
Syntax:	virtual ara::core::Result<std::size_t> ara::crypto::cryp::CryptoProvider::GetPayloadStorageSize (CryptoObjectType cryptoObjectType, AlgId algId) const noexcept=0;	
Parameters (in):	cryptoObjectType	the type of the target object
	algId	a CryptoProvider algorithm ID of the target object
Return value:	ara::core::Result< std::size_t >	minimal size required for storing of the object in a TrustedContainer (persistent or volatile)
Exception Safety:	noexcept	
Thread Safety:	Thread-safe	
Errors:	CryptoErrorDomain::kUnknown Identifier	if any argument has an unsupported value
	CryptoErrorDomain::kIncompatible Arguments	if the arguments are incompatible
Header file:	#include "ara/crypto/cryp/crypto_provider.h"	
Description:	Return minimally required capacity of a key slot for saving of the object's payload. Returned value does not take into account the object's meta-information properties, but their size is fixed and common for all crypto objects independently from their actual type. During an allocation of a TrustedContainer, Crypto Providers (and Key Storage Providers) reserve space for an object's meta-information automatically, according to their implementation details.	

|(RS_CRYPT_02005, RS_CRYPT_02006)

[SWS_CRYPT_20724]{DRAFT} [

Kind:	function	
Symbol:	GetSerializedSize(CryptoObjectType cryptoObjectType, AlgId algId, Serializable::FormatId formatId=Serializable::kFormatDefault)	
Scope:	class ara::crypto::cryp::CryptoProvider	
Syntax:	virtual ara::core::Result<std::size_t> ara::crypto::cryp::CryptoProvider::GetSerializedSize (CryptoObjectType cryptoObjectType, AlgId algId, Serializable::FormatId formatId=Serializable::kFormatDefault) const noexcept=0;	
Parameters (in):	cryptoObjectType	the type of the target object
	algId	the Crypto Provider algorithm ID of the target object



△

	formatId	the Crypto Provider specific identifier of the output format
Return value:	ara::core::Result< std::size_t >	size required for storing of the object serialized in the specified format
Exception Safety:	noexcept	
Thread Safety:	Thread-safe	
Errors:	CryptoErrorDomain::kUnknown Identifier	if any argument has an unsupported value
	CryptoErrorDomain::kIncompatible Arguments	if any pair of the arguments are incompatible
Header file:	#include "ara/crypto/cryp/crypto_provider.h"	
Description:	Return required buffer size for serialization of an object in specific format.	

] ([RS_CRYPT_02005](#), [RS_CRYPT_02006](#))

[SWS_CRYPT_20732]{DRAFT} [

Kind:	function	
Symbol:	ImportPublicObject(IOInterface &container, ReadOnlyMemRegion serialized, CryptoObjectType expectedObject=CryptoObjectType::kUndefined)	
Scope:	class ara::crypto::cryp::CryptoProvider	
Syntax:	virtual ara::core::Result<void> ara::crypto::cryp::CryptoProvider::ImportPublicObject (IOInterface &container, ReadOnlyMemRegion serialized, CryptoObjectType expectedObject=CryptoObjectType::kUndefined) noexcept=0;	
Parameters (in):	serialized	the memory region that contains a securely serialized object that should be imported to the IOInterface
	expectedObject	the expected object type (default value CryptoObjectType::kUnknown means without check)
Parameters (out):	container	the IOInterface for storing of the imported object
Return value:	ara::core::Result< void >	–
Exception Safety:	noexcept	
Thread Safety:	Thread-safe	
Errors:	CryptoErrorDomain::kUnexpected Value	if the serialized contains incorrect data
	CryptoErrorDomain::kBadObjectType	if (expectedObject != CryptoObjectType::kUnknown), but the actual object type differs from the expected one
	CryptoErrorDomain::kInsufficient Capacity	if capacity of the container is not enough to save the de-serialized object
	CryptoErrorDomain::kModified Resource	if the underlying resource has been modified after the IOInterface has been opened, i.e., the IOInterface has been invalidated.
	CryptoErrorDomain::kUnreserved Resource	if the IOInterface is not opened writable.
Header file:	#include "ara/crypto/cryp/crypto_provider.h"	
Description:	Import publicly serialized object to a storage location pointed to by an IOInterface for following processing (without allocation of a crypto object). If (expectedObject != CryptoObjectType::kUnknown) and an actual object type differs from the expected one then this method fails. If the serialized contains incorrect data then this method fails.	

] ([RS_CRYPT_02105](#), [RS_CRYPT_02112](#))

[SWS_CRYPT_20730]{DRAFT} [

Kind:	function	
Symbol:	ImportSecuredObject(IOInterface &container, ReadOnlyMemRegion serialized, SymmetricKey WrapperCtx &transportContext, bool isExportable=false, CryptoObjectType expectedObject=CryptoObjectType::kUndefined)	
Scope:	class ara::crypto::cryp::CryptoProvider	
Syntax:	virtual ara::core::Result<void> ara::crypto::cryp::CryptoProvider::ImportSecuredObject (IOInterface &container, ReadOnlyMemRegion serialized, SymmetricKeyWrapperCtx &transportContext, bool isExportable=false, CryptoObjectType expectedObject=CryptoObjectType::kUndefined) noexcept=0;	
Parameters (in):	serialized	the memory region that contains a securely serialized object that should be imported to the IOInterface
	transportContext	the symmetric key wrap context initialized by a transport key (allowed usage: kAllowKeyImporting)
	isExportable	the exportability attribute of the target object
	expectedObject	the expected object type (default value CryptoObjectType::kUnknown means without check)
Parameters (out):	container	the IOInterface for storing of the imported object
Return value:	ara::core::Result< void >	–
Exception Safety:	noexcept	
Thread Safety:	Thread-safe	
Errors:	CryptoErrorDomain::kUnexpected Value	if the serialized contains incorrect data
	CryptoErrorDomain::kBadObjectType	if (expectedObject != CryptoObjectType::kUnknown), but the actual object type differs from the expected one
	CryptoErrorDomain::kIncompleteArg State	if the transportContext is not initialized
	CryptoErrorDomain::kIncompatible Object	if a key loaded to the transportContext doesn't have required attributes (note: it is an optional error condition for this method)
	CryptoErrorDomain::kInsufficient Capacity	if capacity of the container is not enough to save the deserialized object
	CryptoErrorDomain::kModified Resource	if the underlying resource has been modified after the IOInterface has been opened, i.e., the IOInterface has been invalidated.
	CryptoErrorDomain::kUnreserved Resource	if the IOInterface is not opened writeable.
Header file:	#include "ara/crypto/cryp/crypto_provider.h"	
Description:	Import securely serialized object to the persistent or volatile storage represented by an IOInterface for following processing.	

] ([RS_CRYPT_02105](#), [RS_CRYPT_02112](#))

[SWS_CRYPT_20733]{DRAFT} [

Kind:	function
Symbol:	LoadObject(const IOInterface &container)
Scope:	class ara::crypto::cryp::CryptoProvider





Syntax:	virtual ara::core::Result<CryptoObject::Uptrc> ara::crypto::cryp::CryptoProvider::LoadObject (const IOInterface &container) noexcept=0;	
Parameters (in):	container	the IOInterface that contains the crypto object for loading
Return value:	ara::core::Result< CryptoObject::Uptrc >	unique smart pointer to the created object
Exception Safety:	noexcept	
Thread Safety:	Thread-safe	
Errors:	CryptoErrorDomain::kEmptyContainer	if the container is empty
	CryptoErrorDomain::kResourceFault	if the container content is damaged
	CryptoErrorDomain::kModified Resource	if the underlying resource has been modified after the IOInterface has been opened, i.e., the IOInterface has been invalidated.
	CryptoErrorDomain::kIncompatible Object	if the underlying resource belongs to another, incompatible CryptoProvider
Header file:	#include "ara/crypto/cryp/crypto_provider.h"	
Description:	Load any crypto object from the IOInterface provided.	
Notes:	This method is one of the "binding" methods between a CryptoProvider and the Key Storage Provider.	

|(RS_CRYPT_02001, RS_CRYPT_02002, RS_CRYPT_02005, RS_CRYPT_02006)

[SWS_CRYPT_20764]{DRAFT} [

Kind:	function	
Symbol:	LoadPrivateKey(const IOInterface &container)	
Scope:	class ara::crypto::cryp::CryptoProvider	
Syntax:	virtual ara::core::Result<PrivateKey::Uptrc> ara::crypto::cryp::CryptoProvider::LoadPrivateKey (const IOInterface &container) noexcept=0;	
Parameters (in):	container	the IOInterface that contains the crypto object for loading
Return value:	ara::core::Result< PrivateKey::Uptrc >	unique smart pointer to the PrivateKey
Exception Safety:	noexcept	
Errors:	CryptoErrorDomain::kEmptyContainer	if the container is empty
	CryptoErrorDomain::kResourceFault	if the container content is damaged
	CryptoErrorDomain::kModified Resource	if the underlying resource has been modified after the IOInterface has been opened, i.e., the IOInterface has been invalidated.
	CryptoErrorDomain::kIncompatible Object	if the underlying resource belongs to another, incompatible CryptoProvider
Header file:	#include "ara/crypto/cryp/crypto_provider.h"	
Description:	Load a private key from the IOInterface provided.	

|(RS_CRYPT_02001, RS_CRYPT_02002)

[SWS_CRYPT_20763]{DRAFT} [

Kind:	function	
Symbol:	LoadPublicKey(const IOInterface &container)	
Scope:	class ara::crypto::cryp::CryptoProvider	
Syntax:	virtual ara::core::Result<PublicKey::Uptrc> ara::crypto::cryp::CryptoProvider::LoadPublicKey (const IOInterface &container) noexcept=0;	
Parameters (in):	container	the IOInterface that contains the crypto object for loading
Return value:	ara::core::Result< PublicKey::Uptrc >	unique smart pointer to the PublicKey
Exception Safety:	noexcept	
Errors:	CryptoErrorDomain::kEmptyContainer	if the container is empty
	CryptoErrorDomain::kResourceFault	if the container content is damaged
	CryptoErrorDomain::kModified Resource	if the underlying resource has been modified after the IOInterface has been opened, i.e., the IOInterface has been invalidated.
	CryptoErrorDomain::kIncompatible Object	if the underlying resource belongs to another, incompatible CryptoProvider
Header file:	#include "ara/crypto/cryp/crypto_provider.h"	
Description:	Load a public key from the IOInterface provided.	

] ([RS_CRYPT_02001](#), [RS_CRYPT_02002](#))

[SWS_CRYPT_20765]{DRAFT} [

Kind:	function	
Symbol:	LoadSecretSeed(const IOInterface &container)	
Scope:	class ara::crypto::cryp::CryptoProvider	
Syntax:	virtual ara::core::Result<SecretSeed::Uptrc> ara::crypto::cryp::CryptoProvider::LoadSecretSeed (const IOInterface &container) noexcept=0;	
Parameters (in):	container	the IOInterface that contains the crypto object for loading
Return value:	ara::core::Result< SecretSeed::Uptrc >	unique smart pointer to the SecretSeed
Exception Safety:	noexcept	
Errors:	CryptoErrorDomain::kEmptyContainer	if the container is empty
	CryptoErrorDomain::kResourceFault	if the container content is damaged
	CryptoErrorDomain::kModified Resource	if the underlying resource has been modified after the IOInterface has been opened, i.e., the IOInterface has been invalidated.
	CryptoErrorDomain::kIncompatible Object	if the underlying resource belongs to another, incompatible CryptoProvider
Header file:	#include "ara/crypto/cryp/crypto_provider.h"	
Description:	Load secret seed from the IOInterface provided.	

] ([RS_CRYPT_02001](#), [RS_CRYPT_02002](#))

[SWS_CRYPT_20762]{DRAFT} [

Kind:	function	
Symbol:	LoadSymmetricKey(const IOInterface &container)	
Scope:	class ara::crypto::cryp::CryptoProvider	





Syntax:	<pre>virtual ara::core::Result<SymmetricKey::Uptrc> ara::crypto::cryp::CryptoProvider::LoadSymmetricKey (const IOInterface &container) noexcept=0;</pre>	
Parameters (in):	container	the IOInterface that contains the crypto object for loading
Return value:	ara::core::Result< Symmetric Key::Uptrc >	unique smart pointer to the SymmetricKey
Exception Safety:	noexcept	
Errors:	CryptoErrorDomain::kEmptyContainer	if the container is empty
	CryptoErrorDomain::kResourceFault	if the container content is damaged
	CryptoErrorDomain::kModified Resource	if the underlying resource has been modified after the IOInterface has been opened, i.e., the IOInterface has been invalidated.
	CryptoErrorDomain::kIncompatible Object	if the underlying resource belongs to another, incompatible CryptoProvider
Header file:	#include "ara/crypto/cryp/crypto_provider.h"	
Description:	Load a symmetric key from the IOInterface provided.	

|(RS_CRYPT_02001, RS_CRYPT_02002)

[SWS_CRYPT_29023]{DRAFT} [

Kind:	function	
Symbol:	GetBlockSize()	
Scope:	class ara::crypto::cryp::CryptoService	
Syntax:	<pre>virtual std::size_t ara::crypto::cryp::CryptoService::GetBlockSize () const noexcept=0;</pre>	
Return value:	std::size_t	size of the block in bytes
Exception Safety:	noexcept	
Thread Safety:	Thread-safe	
Header file:	#include "ara/crypto/cryp/crypto_service.h"	
Description:	Get block (or internal buffer) size of the base algorithm. For digest, byte-wise stream cipher and RNG contexts it is an informative method, intended only for optimization of the interface usage.	

|(RS_CRYPT_02309)

[SWS_CRYPT_29021]{DRAFT} [

Kind:	function	
Symbol:	GetMaxInputSize(bool suppressPadding=false)	
Scope:	class ara::crypto::cryp::CryptoService	
Syntax:	<pre>virtual std::size_t ara::crypto::cryp::CryptoService::GetMaxInputSize (bool suppressPadding=false) const noexcept=0;</pre>	
Parameters (in):	suppressPadding	if true then the method calculates the size for the case when the whole space of the plain data block is used for the payload only
Return value:	std::size_t	maximum size of the input data block in bytes
Exception Safety:	noexcept	
Thread Safety:	Thread-safe	
Header file:	#include "ara/crypto/cryp/crypto_service.h"	
Description:	Get maximum expected size of the input data block. suppressPadding argument and it will be equal to the block size.	

]([RS_CRYPT_02309](#))

[SWS_CRYPT_29022]{DRAFT} [

Kind:	function	
Symbol:	GetMaxOutputSize(bool suppressPadding=false)	
Scope:	class ara::crypto::cryp::CryptoService	
Syntax:	virtual std::size_t ara::crypto::cryp::CryptoService::GetMaxOutputSize (bool suppressPadding=false) const noexcept=0;	
Parameters (in):	suppressPadding	if true then the method calculates the size for the case when the whole space of the plain data block is used for the payload only
Return value:	std::size_t	maximum size of the output data block in bytes
Exception Safety:	noexcept	
Thread Safety:	Thread-safe	
Header file:	#include "ara/crypto/cryp/crypto_service.h"	
Description:	Get maximum possible size of the output data block. If (IsEncryption() == true) then a value returned by this method is independent from the suppressPadding argument and will be equal to the block size.	

]([RS_CRYPT_02309](#))

[SWS_CRYPT_30216]{DRAFT} [

Kind:	function	
Symbol:	operator=(const CryptoProvider &other)	
Scope:	class ara::crypto::cryp::CryptoProvider	
Syntax:	CryptoProvider& ara::crypto::cryp::CryptoProvider::operator= (const CryptoProvider &other)=default;	
Parameters (in):	other	the other instance
Return value:	CryptoProvider &	*this, containing the contents of other
Header file:	#include "ara/crypto/cryp/crypto_provider.h"	
Description:	Copy-assign another CryptoProvider to this instance.	

]([RS_CRYPT_02004](#))

[SWS_CRYPT_30217]{DRAFT} [

Kind:	function	
Symbol:	operator=(CryptoProvider &&other)	
Scope:	class ara::crypto::cryp::CryptoProvider	
Syntax:	CryptoProvider& ara::crypto::cryp::CryptoProvider::operator= (Crypto Provider &&other)=default;	
Parameters (in):	other	the other instance
Return value:	CryptoProvider &	*this, containing the contents of other
Header file:	#include "ara/crypto/cryp/crypto_provider.h"	
Description:	Move-assign another CryptoProvider to this instance.	

]([RS_CRYPT_02004](#))

[SWS_CRYPT_20802]{DRAFT} [

Kind:	function	
Symbol:	GetCryptoService()	
Scope:	class ara::crypto::cryp::DecryptorPrivateCtx	
Syntax:	virtual CryptoService::Uptr ara::crypto::cryp::DecryptorPrivateCtx::GetCryptoService () const noexcept=0;	
Return value:	CryptoService::Uptr	–
Exception Safety:	noexcept	
Header file:	#include "ara/crypto/cryp/decryptor_private_ctx.h"	
Description:	Get CryptoService instance.	

]([RS_CRYPT_02006](#))

[SWS_CRYPT_20812]{DRAFT} [

Kind:	function	
Symbol:	ProcessBlock(ReadOnlyMemRegion in, bool suppressPadding=false)	
Scope:	class ara::crypto::cryp::DecryptorPrivateCtx	
Syntax:	virtual ara::core::Result<ara::core::Vector<ara::core::Byte> > ara::crypto::cryp::DecryptorPrivateCtx::ProcessBlock (ReadOnlyMemRegion in, bool suppressPadding=false) const noexcept=0;	
Parameters (in):	in	the input data block
	suppressPadding	if true then the method doesn't apply the padding, but the payload should fill the whole block of the plain data
Return value:	ara::core::Result< ara::core::Vector< ara::core::Byte > >	actual size of output data (it always <= out.size()) or 0 if the input data block has incorrect content
Exception Safety:	noexcept	
Thread Safety:	Thread-safe	
Errors:	CryptoErrorDomain::kIncorrectInput Size	if the mentioned above rules about the input size is violated
	CryptoErrorDomain::kInsufficient Capacity	if the out.size() is not enough to store the transformation result
	CryptoErrorDomain::kUninitialized Context	if the context was not initialized by a key value
Header file:	#include "ara/crypto/cryp/decryptor_private_ctx.h"	
Description:	Process (encrypt / decrypt) an input block according to the cryptor configuration. Encryption with (suppressPadding == true) expects that: in.size() == GetMaxInputSize(true) && out.size() >= GetMaxOutputSize(true). Encryption with (suppressPadding == false) expects that: in.size() <= GetMaxInputSize(false) && in.size() > 0 && out.size() >= GetMaxOutputSize(false). Decryption expects that: in.size() == GetMaxInputSize() && out.size() >= GetMaxOutputSize(suppressPadding). The case (out.size() < GetMaxOutputSize()) should be used with caution, only if you are strictly certain about the size of the output data! In case of (suppressPadding == true) the actual size of plain text should be equal to full size of the plain data block (defined by the algorithm)!	

]([RS_CRYPT_02202](#))

[SWS_CRYPT_20813]{DRAFT} [

Kind:	function	
Symbol:	ProcessBlock(ReadOnlyMemRegion in, bool suppressPadding=false)	
Scope:	class ara::crypto::cryp::DecryptorPrivateCtx	
Syntax:	<pre>template <typename Alloc = <implementation-defined>> ara::core::Result<ByteVector<Alloc> > ara::crypto::cryp::Decryptor PrivateCtx::ProcessBlock (ReadOnlyMemRegion in, bool suppress Padding=false) const noexcept;</pre>	
Template param:	Alloc	a custom allocator type of the output container
Parameters (in):	in	the input data block
	suppressPadding	if true then the method doesn't apply the padding, but the payload should fill the whole block of the plain data
Return value:	ara::core::Result< ByteVector< Alloc > >	the managed container for output block
Exception Safety:	noexcept	
Thread Safety:	Thread-safe	
Errors:	CryptoErrorDomain::kIncorrectInput Size	if the mentioned above rules about the input size is violated
	CryptoErrorDomain::kInsufficient Capacity	if the out.size() is not enough to store the transformation result
	CryptoErrorDomain::kUninitialized Context	if the context was not initialized by a key value
Header file:	#include "ara/crypto/cryp/decryptor_private_ctx.h"	
Description:	Process (encrypt / decrypt) an input block according to the cryptor configuration. This method sets the size of the output container according to actually saved value! Encryption with (suppressPadding == true) expects what: in.size() == GetMaxInputSize(true) && out.capacity() >= GetMaxOutputSize(true). Encryption with (suppressPadding == false) expects what: in.size() <= GetMaxInputSize(false) && in.size() > 0 && out.capacity() >= GetMaxOutputSize(false). Decryption expects what: in.size() == GetMaxInputSize() && out.capacity() >= GetMaxOutputSize(suppressPadding). The case (out.capacity() < GetMaxOutputSize()) should be used with caution, only if you are strictly certain about the size of the output data! In case of (suppressPadding == true) the actual size of plain text should be equal to full size of the plain data block (defined by the algorithm)!	

] ([RS_CRYPT_02202](#))

[SWS_CRYPT_20811]{DRAFT} [

Kind:	function	
Symbol:	Reset()	
Scope:	class ara::crypto::cryp::DecryptorPrivateCtx	
Syntax:	<pre>virtual ara::core::Result<void> ara::crypto::cryp::DecryptorPrivate Ctx::Reset () noexcept=0;</pre>	
Return value:	ara::core::Result< void >	-
Exception Safety:	noexcept	
Thread Safety:	Thread-safe	
Header file:	#include "ara/crypto/cryp/decryptor_private_ctx.h"	
Description:	Clear the crypto context.	

] ([RS_CRYPT_02202](#))

[SWS_CRYPT_20810]{DRAFT} [

Kind:	function	
Symbol:	SetKey(const PrivateKey &key)	
Scope:	class ara::crypto::cryp::DecryptorPrivateCtx	
Syntax:	virtual ara::core::Result<void> ara::crypto::cryp::DecryptorPrivateCtx::SetKey (const PrivateKey &key) noexcept=0;	
Parameters (in):	key	the source key object
Return value:	ara::core::Result< void >	–
Exception Safety:	noexcept	
Thread Safety:	Thread-safe	
Errors:	CryptoErrorDomain::kIncompatible Object	if the provided key object is incompatible with this symmetric key context
	CryptoErrorDomain::kUsageViolation	if the transformation type associated with this context is prohibited by the "allowed usage" restrictions of provided key object
Header file:	#include "ara/crypto/cryp/decryptor_private_ctx.h"	
Description:	Set (deploy) a key to the decryptor private algorithm context.	

] ([RS_CRYPT_02001](#), [RS_CRYPT_02003](#))

[SWS_CRYPT_29013]{DRAFT} [

Kind:	function	
Symbol:	Compare(ReadOnlyMemRegion expected, std::size_t offset=0)	
Scope:	class ara::crypto::cryp::DigestService	
Syntax:	virtual ara::core::Result<bool> ara::crypto::cryp::DigestService::Compare (ReadOnlyMemRegion expected, std::size_t offset=0) const noexcept=0;	
Parameters (in):	expected	the memory region containing an expected digest value
	offset	position of the first byte in calculated digest for the comparison starting
Return value:	ara::core::Result< bool >	true if the expected bytes sequence is identical to first bytes of calculated digest
Exception Safety:	noexcept	
Thread Safety:	Thread-safe	
Errors:	CryptoErrorDomain::kProcessingNot Finished	if the digest calculation was not finished by a call of the Finish() method
	CryptoErrorDomain::kBruteForceRisk	if the buffered digest belongs to a MAC/HMAC/AE/AEAD context, which was initialized by a key without kAllowSignature permission, but actual size of requested digest is less than 8 bytes (it is a protection from the brute-force attack)
Header file:	#include "ara/crypto/cryp/digest_service.h"	
Description:	Compare the calculated digest against an expected value. Entire digest value is kept in the context up to next call Start(), therefore any its part can be verified again or extracted. If (full_digest_size <= offset) (expected.size() == 0) then return false; else comparison_size = min(expected.size(), (full_digest_size - offset)) bytes. This method can be implemented as "inline" after standartization of function ara::core::memcmp().	

] ([RS_CRYPT_02309](#))

[SWS_CRYPT_29012]{DRAFT} [

Kind:	function	
Symbol:	GetDigestSize()	
Scope:	class ara::crypto::cryp::DigestService	
Syntax:	virtual std::size_t ara::crypto::cryp::DigestService::GetDigestSize () const noexcept=0;	
Return value:	std::size_t	size of the full output from this digest-function in bytes
Exception Safety:	noexcept	
Thread Safety:	Thread-safe	
Header file:	#include "ara/crypto/cryp/digest_service.h"	
Description:	Get the output digest size.	

]([RS_CRYPT_02309](#))

[SWS_CRYPT_29015]{DRAFT} [

Kind:	function	
Symbol:	IsFinished()	
Scope:	class ara::crypto::cryp::DigestService	
Syntax:	virtual bool ara::crypto::cryp::DigestService::IsFinished () const noexcept=0;	
Return value:	bool	true if a previously started stream processing was finished by a call of the Finish() or FinishBytes() methods
Exception Safety:	noexcept	
Thread Safety:	Thread-safe	
Header file:	#include "ara/crypto/cryp/digest_service.h"	
Description:	Check current status of the stream processing: finished or no.	

]([RS_CRYPT_02309](#))

[SWS_CRYPT_29014]{DRAFT} [

Kind:	function	
Symbol:	IsStarted()	
Scope:	class ara::crypto::cryp::DigestService	
Syntax:	virtual bool ara::crypto::cryp::DigestService::IsStarted () const noexcept=0;	
Return value:	bool	true if the processing was start by a call of the Start() methods and was not finished yet
Exception Safety:	noexcept	
Thread Safety:	Thread-safe	
Header file:	#include "ara/crypto/cryp/digest_service.h"	
Description:	Check current status of the stream processing: started or no.	

]([RS_CRYPT_02309](#))

[SWS_CRYPT_21002]{DRAFT} [

Kind:	function
Symbol:	GetCryptoService()
Scope:	class ara::crypto::crypt::EncryptorPublicCtx
Syntax:	virtual CryptoService::Uptr ara::crypto::crypt::EncryptorPublicCtx::GetCryptoService () const noexcept=0;
Return value:	CryptoService::Uptr -
Exception Safety:	noexcept
Header file:	#include "ara/crypto/cryp/encryptor_public_ctx.h"
Description:	Get CryptoService instance.

] ([RS_CRYPT_02006](#))

[SWS_CRYPT_21012]{DRAFT} [

Kind:	function				
Symbol:	ProcessBlock(ReadOnlyMemRegion in, bool suppressPadding=false)				
Scope:	class ara::crypto::crypt::EncryptorPublicCtx				
Syntax:	virtual ara::core::Result<ara::core::Vector<ara::core::Byte> > ara::crypto::crypt::EncryptorPublicCtx::ProcessBlock (ReadOnlyMemRegion in, bool suppressPadding=false) const noexcept=0;				
Parameters (in):	<table border="1"> <tr> <td>in</td> <td>the input data block</td> </tr> <tr> <td>suppressPadding</td> <td>if true then the method doesn't apply the padding, but the payload should fill the whole block of the plain data</td> </tr> </table>	in	the input data block	suppressPadding	if true then the method doesn't apply the padding, but the payload should fill the whole block of the plain data
in	the input data block				
suppressPadding	if true then the method doesn't apply the padding, but the payload should fill the whole block of the plain data				
Return value:	ara::core::Result< ara::core::Vector< ara::core::Byte > > actual size of output data (it always <= out.size()) or 0 if the input data block has incorrect content				
Exception Safety:	noexcept				
Thread Safety:	Thread-safe				
Errors:	<table border="1"> <tr> <td>CryptoErrorDomain::kIncorrectInput Size</td> <td>if the mentioned above rules about the input size is violated</td> </tr> <tr> <td>CryptoErrorDomain::kUninitialized Context</td> <td>if the context was not initialized by a key value</td> </tr> </table>	CryptoErrorDomain::kIncorrectInput Size	if the mentioned above rules about the input size is violated	CryptoErrorDomain::kUninitialized Context	if the context was not initialized by a key value
CryptoErrorDomain::kIncorrectInput Size	if the mentioned above rules about the input size is violated				
CryptoErrorDomain::kUninitialized Context	if the context was not initialized by a key value				
Header file:	#include "ara/crypto/cryp/encryptor_public_ctx.h"				
Description:	Process (encrypt / decrypt) an input block according to the cryptor configuration. Encryption with (suppressPadding == true) expects that: in.size() == GetMaxInputSize(true) && out.size() >= GetMaxOutputSize(true). Encryption with (suppressPadding == false) expects that: in.size() <= GetMaxInputSize(false) && in.size() > 0 && out.size() >= GetMaxOutputSize(false). Decryption expects that: in.size() == GetMaxInputSize() && out.size() >= GetMaxOutputSize(suppressPadding). The case (out.size() < GetMaxOutputSize()) should be used with caution, only if you are strictly certain about the size of the output data! In case of (suppressPadding == true) the actual size of plain text should be equal to full size of the plain data block (defined by the algorithm)!				

] ([RS_CRYPT_02202](#))

[SWS_CRYPT_21013]{DRAFT} [

Kind:	function
Symbol:	ProcessBlock(ReadOnlyMemRegion in, bool suppressPadding=false)
Scope:	class ara::crypto::crypt::EncryptorPublicCtx





Syntax:	<pre>template <typename Alloc = <implementation-defined>> ara::core::Result<ByteVector<Alloc> > ara::crypto::cryp::Encryptor PublicCtx::ProcessBlock (ReadOnlyMemRegion in, bool suppress Padding=false) const noexcept;</pre>	
Template param:	Alloc	a custom allocator type of the output container
Parameters (in):	in	the input data block
	suppressPadding	if true then the method doesn't apply the padding, but the payload should fill the whole block of the plain data
Return value:	ara::core::Result< ByteVector< Alloc > >	the managed container for output block
Exception Safety:	noexcept	
Thread Safety:	Thread-safe	
Errors:	CryptoErrorDomain::kIncorrectInput Size	if the mentioned above rules about the input size is violated
	CryptoErrorDomain::kInsufficient Capacity	if the out.size() is not enough to store the transformation result
	CryptoErrorDomain::kUninitialized Context	if the context was not initialized by a key value
Header file:	#include "ara/crypto/cryp/encryptor_public_ctx.h"	
Description:	Process (encrypt / decrypt) an input block according to the cryptor configuration. This method sets the size of the output container according to actually saved value! Encryption with (suppressPadding == true) expects what: in.size() == GetMaxInputSize(true) && out.capacity() >= GetMaxOutputSize(true). Encryption with (suppressPadding == false) expects what: in.size() <= GetMaxInputSize(false) && in.size() > 0 && out.capacity() >= GetMaxOutputSize(false). Decryption expects what: in.size() == GetMaxInputSize() && out.capacity() >= GetMaxOutputSize(suppressPadding). The case (out.capacity() < GetMaxOutputSize()) should be used with caution, only if you are strictly certain about the size of the output data! In case of (suppressPadding == true) the actual size of plain text should be equal to full size of the plain data block (defined by the algorithm)!	

]([RS_CRYPT_02202](#))

[SWS_CRYPT_21011]{DRAFT} [

Kind:	function	
Symbol:	Reset()	
Scope:	class ara::crypto::cryp::EncryptorPublicCtx	
Syntax:	<pre>virtual ara::core::Result<void> ara::crypto::cryp::EncryptorPublic Ctx::Reset () noexcept=0;</pre>	
Return value:	ara::core::Result< void >	-
Exception Safety:	noexcept	
Thread Safety:	Thread-safe	
Header file:	#include "ara/crypto/cryp/encryptor_public_ctx.h"	
Description:	Clear the crypto context.	

]([RS_CRYPT_02202](#))

[SWS_CRYPT_21010]{DRAFT} [

Kind:	function	
Symbol:	SetKey(const PublicKey &key)	
Scope:	class ara::crypto::cryp::EncryptorPublicCtx	
Syntax:	virtual ara::core::Result<void> ara::crypto::cryp::EncryptorPublicCtx::SetKey (const PublicKey &key) noexcept=0;	
Parameters (in):	key	the source key object
Return value:	ara::core::Result< void >	–
Exception Safety:	noexcept	
Thread Safety:	Thread-safe	
Errors:	CryptoErrorDomain::kIncompatible Object	if the provided key object is incompatible with this symmetric key context
	CryptoErrorDomain::kUsageViolation	if the transformation type associated with this context is prohibited by the "allowed usage" restrictions of provided key object
Header file:	#include "ara/crypto/cryp/encryptor_public_ctx.h"	
Description:	Set (deploy) a key to the encryptor public algorithm context.	

]([RS_CRYPT_02001](#), [RS_CRYPT_02003](#))

[SWS_CRYPT_29041]{DRAFT} [

Kind:	function	
Symbol:	~ExtensionService()	
Scope:	class ara::crypto::cryp::ExtensionService	
Syntax:	virtual ara::crypto::cryp::ExtensionService::~~ExtensionService () noexcept=default;	
Exception Safety:	noexcept	
Header file:	#include "ara/crypto/cryp/extension_service.h"	
Description:	Destructor.	

]([RS_CRYPT_02309](#))

[SWS_CRYPT_29045]{DRAFT} [

Kind:	function	
Symbol:	GetActualKeyBitLength()	
Scope:	class ara::crypto::cryp::ExtensionService	
Syntax:	virtual std::size_t ara::crypto::cryp::ExtensionService::GetActualKeyBitLength () const noexcept=0;	
Return value:	std::size_t	actual length of a key (now set to the algorithm context) in bits
Exception Safety:	noexcept	
Thread Safety:	Thread-safe	
Header file:	#include "ara/crypto/cryp/extension_service.h"	
Description:	Get actual bit-length of a key loaded to the context. If no key was set to the context yet then 0 is returned.	

]([RS_CRYPT_02309](#))

[SWS_CRYPT_29047]{DRAFT} [

Kind:	function	
Symbol:	GetActualKeyCOUID()	
Scope:	class ara::crypto::cryp::ExtensionService	
Syntax:	virtual CryptoObjectUId ara::crypto::cryp::ExtensionService::GetActualKeyCOUID () const noexcept=0;	
Return value:	CryptoObjectUId	the COUID of the CryptoObject
Exception Safety:	noexcept	
Thread Safety:	Thread-safe	
Header file:	#include "ara/crypto/cryp/extension_service.h"	
Description:	Get the COUID of the key deployed to the context this extension service is attached to. If no key was set to the context yet then an empty COUID (Nil) is returned.	

] ([RS_CRYPT_02309](#))

[SWS_CRYPT_29046]{DRAFT} [

Kind:	function	
Symbol:	GetAllowedUsage()	
Scope:	class ara::crypto::cryp::ExtensionService	
Syntax:	virtual AllowedUsageFlags ara::crypto::cryp::ExtensionService::GetAllowedUsage () const noexcept=0;	
Return value:	AllowedUsageFlags	a combination of bit-flags that specifies allowed usages of the context
Exception Safety:	noexcept	
Thread Safety:	Thread-safe	
Header file:	#include "ara/crypto/cryp/extension_service.h"	
Description:	Get allowed usages of this context (according to the key object attributes loaded to this context). If the context is not initialized by a key object yet then zero (all flags are reset) must be returned.	

] ([RS_CRYPT_02008](#))

[SWS_CRYPT_29044]{DRAFT} [

Kind:	function	
Symbol:	GetMaxKeyBitLength()	
Scope:	class ara::crypto::cryp::ExtensionService	
Syntax:	virtual std::size_t ara::crypto::cryp::ExtensionService::GetMaxKeyBitLength () const noexcept=0;	
Return value:	std::size_t	maximal supported length of the key in bits
Exception Safety:	noexcept	
Thread Safety:	Thread-safe	
Header file:	#include "ara/crypto/cryp/extension_service.h"	
Description:	Get maximal supported key length in bits.	

] ([RS_CRYPT_02309](#))

[SWS_CRYPT_29043]{DRAFT} [

Kind:	function	
Symbol:	GetMinKeyBitLength()	
Scope:	class ara::crypto::crypt::ExtensionService	
Syntax:	virtual std::size_t ara::crypto::crypt::ExtensionService::GetMinKeyBitLength () const noexcept=0;	
Return value:	std::size_t	minimal supported length of the key in bits
Exception Safety:	noexcept	
Thread Safety:	Thread-safe	
Header file:	#include "ara/crypto/cryp/extension_service.h"	
Description:	Get minimal supported key length in bits.	

] ([RS_CRYPT_02309](#))

[SWS_CRYPT_29048]{DRAFT} [

Kind:	function	
Symbol:	IsKeyBitLengthSupported(std::size_t keyBitLength)	
Scope:	class ara::crypto::crypt::ExtensionService	
Syntax:	virtual bool ara::crypto::crypt::ExtensionService::IsKeyBitLengthSupported (std::size_t keyBitLength) const noexcept=0;	
Parameters (in):	keyBitLength	length of the key in bits
Return value:	bool	true if provided value of the key length is supported by the context
Exception Safety:	noexcept	
Thread Safety:	Thread-safe	
Header file:	#include "ara/crypto/cryp/extension_service.h"	
Description:	Verify supportness of specific key length by the context.	

] ([RS_CRYPT_02309](#))

[SWS_CRYPT_29049]{DRAFT} [

Kind:	function	
Symbol:	IsKeyAvailable()	
Scope:	class ara::crypto::crypt::ExtensionService	
Syntax:	virtual bool ara::crypto::crypt::ExtensionService::IsKeyAvailable () const noexcept=0;	
Return value:	bool	FALSE if no key has been set
Exception Safety:	noexcept	
Thread Safety:	Thread-safe	
Header file:	#include "ara/crypto/cryp/extension_service.h"	
Description:	Check if a key has been set to this context.	

] ([RS_CRYPT_02309](#))

[SWS_CRYPT_30218]{DRAFT} [

Kind:	function	
Symbol:	operator=(const ExtensionService &other)	
Scope:	class ara::crypto::cryp::ExtensionService	
Syntax:	ExtensionService& ara::crypto::cryp::ExtensionService::operator=(const ExtensionService &other)=default;	
Parameters (in):	other	the other instance
Return value:	ExtensionService &	*this, containing the contents of other
Header file:	#include "ara/crypto/cryp/extension_service.h"	
Description:	Copy-assign another ExtensionService to this instance.	

]([RS_CRYPT_02004](#))

[SWS_CRYPT_30219]{DRAFT} [

Kind:	function	
Symbol:	operator=(ExtensionService &&other)	
Scope:	class ara::crypto::cryp::ExtensionService	
Syntax:	ExtensionService& ara::crypto::cryp::ExtensionService::operator=(ExtensionService &&other)=default;	
Parameters (in):	other	the other instance
Return value:	ExtensionService &	*this, containing the contents of other
Header file:	#include "ara/crypto/cryp/extension_service.h"	
Description:	Move-assign another ExtensionService to this instance.	

]([RS_CRYPT_02004](#))

[SWS_CRYPT_21115]{DRAFT} [

Kind:	function	
Symbol:	Finish()	
Scope:	class ara::crypto::cryp::HashFunctionCtx	
Syntax:	virtual ara::core::Result<ara::core::Vector<ara::core::Byte> > ara::crypto::cryp::HashFunctionCtx::Finish () noexcept=0;	
Return value:	ara::core::Result< ara::core::Vector< ara::core::Byte > >	output data buffer
Exception Safety:	noexcept	
Thread Safety:	Thread-safe	
Errors:	CryptoErrorDomain::kProcessingNot Started	if Start() has not been successfully called before.
	CryptoErrorDomain::kInvalidUsage Order	if Update() has not been called successfully after the last call to Start()
Header file:	#include "ara/crypto/cryp/hash_function_ctx.h"	
Description:	Finish the digest calculation and optionally produce the "signature" object. Only after call of this method the digest can be signed, verified, extracted or compared.	

]([RS_CRYPT_02302](#), [RS_CRYPT_02205](#))

[SWS_CRYPT_21102]{DRAFT} [

Kind:	function	
Symbol:	GetDigestService()	
Scope:	class ara::crypto::cryp::HashFunctionCtx	
Syntax:	virtual DigestService::Uptr ara::crypto::cryp::HashFunctionCtx::GetDigestService () const noexcept=0;	
Return value:	DigestService::Uptr	–
Exception Safety:	noexcept	
Header file:	#include "ara/crypto/cryp/hash_function_ctx.h"	
Description:	Get DigestService instance.	

] ([RS_CRYPT_02006](#))

[SWS_CRYPT_21116]{DRAFT} [

Kind:	function	
Symbol:	GetDigest(std::size_t offset=0)	
Scope:	class ara::crypto::cryp::HashFunctionCtx	
Syntax:	virtual ara::core::Result<ara::core::Vector<ara::core::Byte> > ara::crypto::cryp::HashFunctionCtx::GetDigest (std::size_t offset=0) const noexcept=0;	
Parameters (in):	offset	position of the first byte of digest that should be placed to the output buffer
Return value:	ara::core::Result< ara::core::Vector< ara::core::Byte > >	number of digest bytes really stored to the output buffer (they are always <= output.size() and denoted below as return_size)
Exception Safety:	noexcept	
Thread Safety:	Thread-safe	
Errors:	CryptoErrorDomain::kProcessingNot Finished	if the digest calculation was not finished by a call of the Finish() method
Header file:	#include "ara/crypto/cryp/hash_function_ctx.h"	
Description:	Get requested part of calculated digest. Entire digest value is kept in the context up to next call Start(), therefore any its part can be extracted again or verified. If (full_digest_size <= offset) then return_size = 0 bytes; else return_size = min(output.size(), (full_digest_size - offset)) bytes. This method can be implemented as "inline" after standartization of function ara::core::memcpy().	

] ([RS_CRYPT_02205](#))

[SWS_CRYPT_21117]{DRAFT} [

Kind:	function	
Symbol:	GetDigest(std::size_t offset=0)	
Scope:	class ara::crypto::cryp::HashFunctionCtx	
Syntax:	template <typename Alloc = <implementation-defined>> ara::core::Result<ByteVector<Alloc> > ara::crypto::cryp::HashFunctionCtx::GetDigest (std::size_t offset=0) const noexcept;	
Template param:	Alloc	a custom allocator type of the output container
Parameters (in):	offset	position of first byte of digest that should be placed to the output buffer
Return value:	ara::core::Result< ByteVector< Alloc > >	–





Exception Safety:	noexcept	
Thread Safety:	Thread-safe	
Errors:	CryptoErrorDomain::kProcessingNot Finished	if the digest calculation was not finished by a call of the Finish() method
	CryptoErrorDomain::kUsageViolation	if the buffered digest belongs to a MAC/HMAC/AE/AEAD context initialized by a key without kAllow Signature permission
Header file:	#include "ara/crypto/cryp/hash_function_ctx.h"	
Description:	Get requested part of calculated digest to pre-reserved managed container. This method sets the size of the output container according to actually saved value. Entire digest value is kept in the context up to next call Start(), therefore any its part can be extracted again or verified. If (full_digest_size <= offset) then return_size = 0 bytes; else return_size = min(output.capacity(), (full_digest_size - offset)) bytes.	

]([RS_CRYPT_02205](#))

[SWS_CRYPT_21118]{DRAFT} [

Kind:	function	
Symbol:	Start()	
Scope:	class ara::crypto::cryp::HashFunctionCtx	
Syntax:	virtual ara::core::Result<void> ara::crypto::cryp::HashFunction Ctx::Start () noexcept=0;	
Return value:	ara::core::Result< void >	–
Exception Safety:	noexcept	
Thread Safety:	Thread-safe	
Errors:	CryptoErrorDomain::kMissing Argument	the configured hash function expected an IV
Header file:	#include "ara/crypto/cryp/hash_function_ctx.h"	
Description:	Initialize the context for a new data stream processing or generation (depending on the primitive) without IV.	

]([RS_CRYPT_02302](#))

[SWS_CRYPT_21110]{DRAFT} [

Kind:	function	
Symbol:	Start(ReadOnlyMemRegion iv)	
Scope:	class ara::crypto::cryp::HashFunctionCtx	
Syntax:	virtual ara::core::Result<void> ara::crypto::cryp::HashFunction Ctx::Start (ReadOnlyMemRegion iv) noexcept=0;	
Parameters (in):	iv	an optional Initialization Vector (IV) or "nonce" value
Return value:	ara::core::Result< void >	–
Exception Safety:	noexcept	
Thread Safety:	Thread-safe	
Errors:	CryptoErrorDomain::kInvalidInputSize	if the size of provided IV is not supported (i.e. if it is not enough for the initialization)
	CryptoErrorDomain::kUnsupported	if the base algorithm (or its current implementation) principally doesn't support the IV variation, but provided IV value is not empty, i.e. if (iv.empty() == false)





Header file:	#include "ara/crypto/cryp/hash_function_ctx.h"
Description:	Initialize the context for a new data stream processing or generation (depending on the primitive). If IV size is greater than maximally supported by the algorithm then an implementation may use the leading bytes only from the sequence.

](RS_CRYPT_02302)

[SWS_CRYPT_21111]{DRAFT} [

Kind:	function	
Symbol:	Start(const SecretSeed &iv)	
Scope:	class ara::crypto::cryp::HashFunctionCtx	
Syntax:	virtual ara::core::Result<void> ara::crypto::cryp::HashFunctionCtx::Start (const SecretSeed &iv) noexcept=0;	
Parameters (in):	iv	the Initialization Vector (IV) or "nonce" object
Return value:	ara::core::Result< void >	–
Exception Safety:	noexcept	
Thread Safety:	Thread-safe	
Errors:	CryptoErrorDomain::kInvalidInputSize	if the size of provided IV is not supported (i.e. if it is not enough for the initialization)
	CryptoErrorDomain::kUnsupported	if the base algorithm (or its current implementation) principally doesn't support the IV variation
Header file:	#include "ara/crypto/cryp/hash_function_ctx.h"	
Description:	Initialize the context for a new data stream processing or generation (depending on the primitive). If IV size is greater than maximally supported by the algorithm then an implementation may use the leading bytes only from the sequence.	

](RS_CRYPT_02302)

[SWS_CRYPT_21112]{DRAFT} [

Kind:	function	
Symbol:	Update(const RestrictedUseObject &in)	
Scope:	class ara::crypto::cryp::HashFunctionCtx	
Syntax:	virtual ara::core::Result<void> ara::crypto::cryp::HashFunctionCtx::Update (const RestrictedUseObject &in) noexcept=0;	
Parameters (in):	in	a part of input message that should be processed
Return value:	ara::core::Result< void >	–
Exception Safety:	noexcept	
Thread Safety:	Thread-safe	
Errors:	CryptoErrorDomain::kProcessingNot Started	if the digest calculation was not initiated by a call of the Start() method
Header file:	#include "ara/crypto/cryp/hash_function_ctx.h"	
Description:	Update the digest calculation context by a new part of the message. This method is dedicated for cases then the RestrictedUseObject is a part of the "message".	

](RS_CRYPT_02302)

[SWS_CRYPT_21113]{DRAFT} [

Kind:	function	
Symbol:	Update(ReadOnlyMemRegion in)	
Scope:	class ara::crypto::cryp::HashFunctionCtx	
Syntax:	virtual ara::core::Result<void> ara::crypto::cryp::HashFunctionCtx::Update (ReadOnlyMemRegion in) noexcept=0;	
Parameters (in):	in	a part of the input message that should be processed
Return value:	ara::core::Result< void >	–
Exception Safety:	noexcept	
Thread Safety:	Thread-safe	
Errors:	CryptoErrorDomain::kProcessingNot Started	if the digest calculation was not initiated by a call of the Start() method
Header file:	#include "ara/crypto/cryp/hash_function_ctx.h"	
Description:	Update the digest calculation context by a new part of the message.	

] ([RS_CRYPT_02302](#))

[SWS_CRYPT_21114]{DRAFT} [

Kind:	function	
Symbol:	Update(std::uint8_t in)	
Scope:	class ara::crypto::cryp::HashFunctionCtx	
Syntax:	virtual ara::core::Result<void> ara::crypto::cryp::HashFunctionCtx::Update (std::uint8_t in) noexcept=0;	
Parameters (in):	in	a byte value that is a part of input message
Return value:	ara::core::Result< void >	–
Exception Safety:	noexcept	
Thread Safety:	Thread-safe	
Errors:	CryptoErrorDomain::kProcessingNot Started	if the digest calculation was not initiated by a call of the Start() method
Header file:	#include "ara/crypto/cryp/hash_function_ctx.h"	
Description:	Update the digest calculation context by a new part of the message. This method is convenient for processing of constant tags.	

] ([RS_CRYPT_02302](#))

[SWS_CRYPT_21312]{DRAFT} [

Kind:	function	
Symbol:	AgreeKey(const PublicKey &otherSideKey, CryptoAlgId targetAlgId, AllowedUsageFlags allowedUsage, ara::core::Optional< ReadOnlyMemRegion > salt, ara::core::Optional< ReadOnlyMemRegion > ctxLabel)	
Scope:	class ara::crypto::cryp::KeyAgreementPrivateCtx	
Syntax:	virtual ara::core::Result<SymmetricKey::Uptrc> ara::crypto::cryp::KeyAgreementPrivateCtx::AgreeKey (const PublicKey &otherSideKey, CryptoAlgId targetAlgId, AllowedUsageFlags allowedUsage, ara::core::Optional< ReadOnlyMemRegion > salt, ara::core::Optional< ReadOnlyMemRegion > ctxLabel) const noexcept=0;	
Parameters (in):	otherSideKey	the public key of the other side of the Key-Agreement



△

	targetAlgId	identifier of the target symmetric algorithm (also defines a target key-length)
	allowedUsage	the allowed usage scope of the target key
	salt	an optional salt value (if used, it should be unique for each instance of the target key)
	ctxLabel	an optional application specific "context label" (it can identify purpose of the target key and/or communication parties)
Return value:	ara::core::Result< SymmetricKey::Uptrc >	a unique pointer to SymmetricKey object, which contains the computed shared secret or key material produced by the Key-Agreement algorithm
Exception Safety:	noexcept	
Thread Safety:	Thread-safe	
Errors:	CryptoErrc::kUninitializedContext	if the context was not initialized by a key value
	CryptoErrc::kIncompatibleObject	if the public and private keys correspond to different algorithms
Header file:	#include "ara/crypto/cryp/key_agreement_private_ctx.h"	
Description:	Produce a common symmetric key via execution of the key-agreement algorithm between this private key and a public key of another side. Produced SymmetricKey object has following attributes: session, non-exportable. This method can be used for direct production of the target key, without creation of the intermediate SecretSeed object.	

] (RS_CRYPT_02115)

[SWS_CRYPT_21311]{DRAFT} [

Kind:	function	
Symbol:	AgreeSeed(const PublicKey &otherSideKey, ara::core::Optional< AllowedUsageFlags > allowed Usage)	
Scope:	class ara::crypto::cryp::KeyAgreementPrivateCtx	
Syntax:	virtual ara::core::Result<SecretSeed::Uptrc> ara::crypto::cryp::KeyAgreementPrivateCtx::AgreeSeed (const PublicKey &otherSideKey, ara::core::Optional< AllowedUsageFlags > allowedUsage) const noexcept=0;	
Parameters (in):	otherSideKey	the public key of the other side of the Key-Agreement
	allowedUsage	the allowed usage scope of the target seed
Return value:	ara::core::Result< SecretSeed::Uptrc >	unique pointer to SecretSeed object, which contains the key material produced by the Key-Agreement algorithm
Exception Safety:	noexcept	
Thread Safety:	Thread-safe	
Errors:	CryptoErrc::kUninitializedContext	if the context was not initialized by a key value
	CryptoErrc::kIncompatibleObject	if the public and private keys correspond to different algorithms
Header file:	#include "ara/crypto/cryp/key_agreement_private_ctx.h"	
Description:	Produce a common secret seed via execution of the key-agreement algorithm between this private key and a public key of another side. Produced SecretSeed object has following attributes: session, non-exportable, AlgID (this Key-Agreement Algorithm ID).	

] (RS_CRYPT_02007)

[SWS_CRYPT_21302]{DRAFT} [

Kind:	function	
Symbol:	GetExtensionService()	
Scope:	class ara::crypto::cryp::KeyAgreementPrivateCtx	
Syntax:	virtual ExtensionService::Uptr ara::crypto::cryp::KeyAgreementPrivateCtx::GetExtensionService () const noexcept=0;	
Return value:	ExtensionService::Uptr	–
Exception Safety:	noexcept	
Header file:	#include "ara/crypto/cryp/key_agreement_private_ctx.h"	
Description:	Get ExtensionService instance.	

]([RS_CRYPT_02006](#))

[SWS_CRYPT_21314]{DRAFT} [

Kind:	function	
Symbol:	Reset()	
Scope:	class ara::crypto::cryp::KeyAgreementPrivateCtx	
Syntax:	virtual ara::core::Result<void> ara::crypto::cryp::KeyAgreementPrivateCtx::Reset () noexcept=0;	
Return value:	ara::core::Result< void >	–
Exception Safety:	noexcept	
Thread Safety:	Thread-safe	
Header file:	#include "ara/crypto/cryp/key_agreement_private_ctx.h"	
Description:	Clear the crypto context.	

]([RS_CRYPT_02108](#))

[SWS_CRYPT_21313]{DRAFT} [

Kind:	function	
Symbol:	SetKey(const PrivateKey &key)	
Scope:	class ara::crypto::cryp::KeyAgreementPrivateCtx	
Syntax:	virtual ara::core::Result<void> ara::crypto::cryp::KeyAgreementPrivateCtx::SetKey (const PrivateKey &key) noexcept=0;	
Parameters (in):	key	the source key object
Return value:	ara::core::Result< void >	–
Exception Safety:	noexcept	
Thread Safety:	Thread-safe	
Errors:	CryptoErrc::kIncompatibleObject	if the provided key object is incompatible with this private key context
	CryptoErrc::kUsageViolation	if the transformation type associated with this context is prohibited by the "allowed usage" restrictions of provided key object
Header file:	#include "ara/crypto/cryp/key_agreement_private_ctx.h"	
Description:	Set (deploy) a key to the key agreement private algorithm context.	

]([RS_CRYPT_02001](#), [RS_CRYPT_02003](#))

[SWS_CRYPT_21315]{DRAFT} [

Kind:	function	
Symbol:	SetKDF(const KeyDerivationFunctionCtx &kdf)	
Scope:	class ara::crypto::cryp::KeyAgreementPrivateCtx	
Syntax:	virtual void ara::crypto::cryp::KeyAgreementPrivateCtx::SetKDF (const KeyDerivationFunctionCtx &kdf) const noexcept=0;	
Parameters (in):	kdf	the KeyDerivationFunctionCtx that shall be used to derive the final SymmetricKey or SecretSeed.
Return value:	None	
Exception Safety:	noexcept	
Thread Safety:	Thread-safe	
Header file:	#include "ara/crypto/cryp/key_agreement_private_ctx.h"	
Description:	This interface may be used to provide a KDF in case no KDF was specified during context creation or the default parameters of the specified KDF are insufficient or the specified KDF must be replaced.	

]([RS_CRYPTO_02115](#))

[SWS_CRYPT_21412]{DRAFT} [

Kind:	function	
Symbol:	DecapsulateKey(ReadOnlyMemRegion input, CryptoAlgId keyingDataAlgId, KeyDerivationFunctionCtx &kdf, CryptoAlgId kekAlgId, ara::core::Optional< AllowedUsageFlags > allowedUsage)	
Scope:	class ara::crypto::cryp::KeyDecapsulatorPrivateCtx	
Syntax:	virtual ara::core::Result<SymmetricKey::Uptrc> ara::crypto::cryp::KeyDecapsulatorPrivateCtx::DecapsulateKey (ReadOnlyMemRegion input, CryptoAlgId keyingDataAlgId, KeyDerivationFunctionCtx &kdf, CryptoAlgId kekAlgId, ara::core::Optional< AllowedUsageFlags > allowedUsage) const noexcept=0;	
Parameters (in):	input	an input buffer (its size should be equal GetEncapsulatedSize() bytes)
	keyingDataAlgId	algorithm ID of the returned symmetric key
	kdf	a context of a key derivation function, which should be used for KEK production
	kekAlgId	an algorithm ID of the KEK
	allowedUsage	the allowed usage scope of the returned symmetric key object (default = kAllowKdfMaterialAnyUsage)
Return value:	ara::core::Result< SymmetricKey::Uptrc >	unique smart pointer of the symmetric key object instantiated from the decapsulated keying data
Exception Safety:	noexcept	
Thread Safety:	Thread-safe	
Errors:	CryptoErrc::kUninitializedContext	if the context was not initialized by a private key value
	CryptoErrc::kInvalidArgument	if kekAlgId or kdf are incompatible with this context
	CryptoErrc::kInvalidInputSize	if this context does not support the size of input
Header file:	#include "ara/crypto/cryp/key_decapsulator_private_ctx.h"	
Description:	Decapsulate the keying data to be used for subsequent processing (e.g. secure communication). Produced SymmetricKey object has following attributes: session, non-exportable.	

]([RS_CRYPTO_02102](#), [RS_CRYPTO_02108](#), [RS_CRYPTO_02115](#))

[SWS_CRYPT_21411]{DRAFT} [

Kind:	function	
Symbol:	DecapsulateSeed(ReadOnlyMemRegion input, ara::core::Optional< AllowedUsageFlags > allowedUsage)	
Scope:	class ara::crypto::cryp::KeyDecapsulatorPrivateCtx	
Syntax:	virtual ara::core::Result<SecretSeed::Uptr> ara::crypto::cryp::KeyDecapsulatorPrivateCtx::DecapsulateSeed (ReadOnlyMemRegion input, ara::core::Optional< AllowedUsageFlags > allowedUsage) const noexcept=0;	
Parameters (in):	input	a buffer with the encapsulated seed (its size should be equal GetEncapsulatedSize() bytes)
	allowedUsage	the allowed usage scope of the target seed (default = kAllowKdfMaterialAnyUsage)
Return value:	ara::core::Result< SecretSeed::Uptr >	unique smart pointer to SecretSeed object, which keeps the key material decapsulated from the input buffer
Exception Safety:	noexcept	
Thread Safety:	Thread-safe	
Errors:	CryptoErrc::kUninitializedContext	if the context was not initialized by a private key value
	CryptoErrc::kInvalidInputSize	if this context does not support the size of input
Header file:	#include "ara/crypto/cryp/key_decapsulator_private_ctx.h"	
Description:	Decapsulate key material. Produced SecretSeed object has following attributes: session, non-exportable, AlgID = this KEM AlgID.	

] ([RS_CRYPT_02007](#))

[SWS_CRYPT_21416]{DRAFT} [

Kind:	function	
Symbol:	GetEncapsulatedSize()	
Scope:	class ara::crypto::cryp::KeyDecapsulatorPrivateCtx	
Syntax:	virtual std::size_t ara::crypto::cryp::KeyDecapsulatorPrivateCtx::GetEncapsulatedSize () const noexcept=0;	
Return value:	std::size_t	size of the encapsulated data block in bytes
Exception Safety:	noexcept	
Thread Safety:	Thread-safe	
Header file:	#include "ara/crypto/cryp/key_decapsulator_private_ctx.h"	
Description:	Get fixed size of the encapsulated data block.	

] ([RS_CRYPT_02309](#))

[SWS_CRYPT_21402]{DRAFT} [

Kind:	function	
Symbol:	GetExtensionService()	
Scope:	class ara::crypto::cryp::KeyDecapsulatorPrivateCtx	
Syntax:	virtual ExtensionService::Uptr ara::crypto::cryp::KeyDecapsulatorPrivateCtx::GetExtensionService () const noexcept=0;	
Return value:	ExtensionService::Uptr	-
Exception Safety:	noexcept	





Header file:	#include "ara/crypto/cryp/key_decapsulator_private_ctx.h"
Description:	Get ExtensionService instance.

]([RS_CRYPT_02006](#))

[SWS_CRYPT_21415]{DRAFT} [

Kind:	function
Symbol:	GetKekEntropy()
Scope:	class ara::crypto::cryp::KeyDecapsulatorPrivateCtx
Syntax:	virtual std::size_t ara::crypto::cryp::KeyDecapsulatorPrivateCtx::GetKekEntropy () const noexcept=0;
Return value:	std::size_t entropy of the KEK material in bits
Exception Safety:	noexcept
Thread Safety:	Thread-safe
Header file:	#include "ara/crypto/cryp/key_decapsulator_private_ctx.h"
Description:	Get entropy (bit-length) of the key encryption key (KEK) material. For RSA system the returned value corresponds to the length of module N (minus 1). For DH-like system the returned value corresponds to the length of module q (minus 1).

]([RS_CRYPT_02309](#))

[SWS_CRYPT_21414]{DRAFT} [

Kind:	function
Symbol:	Reset()
Scope:	class ara::crypto::cryp::KeyDecapsulatorPrivateCtx
Syntax:	virtual ara::core::Result<void> ara::crypto::cryp::KeyDecapsulatorPrivateCtx::Reset () noexcept=0;
Return value:	ara::core::Result< void > -
Exception Safety:	noexcept
Thread Safety:	Thread-safe
Header file:	#include "ara/crypto/cryp/key_decapsulator_private_ctx.h"
Description:	Clear the crypto context.

]([RS_CRYPT_02108](#))

[SWS_CRYPT_21413]{DRAFT} [

Kind:	function
Symbol:	SetKey(const PrivateKey &key)
Scope:	class ara::crypto::cryp::KeyDecapsulatorPrivateCtx
Syntax:	virtual ara::core::Result<void> ara::crypto::cryp::KeyDecapsulatorPrivateCtx::SetKey (const PrivateKey &key) noexcept=0;
Parameters (in):	key the source key object
Return value:	ara::core::Result< void > -
Exception Safety:	noexcept
Thread Safety:	Thread-safe





Errors:	CryptoErrc::kIncompatibleObject	if the provided key object is incompatible with this private key context
	CryptoErrc::kUsageViolation	if the transformation type associated with this context is prohibited by the "allowed usage" restrictions of provided key object
Header file:	#include "ara/crypto/cryp/key_decapsulator_private_ctx.h"	
Description:	Set (deploy) a key to the key decapsulator private algorithm context.	

]([RS_CRYPT_02001](#), [RS_CRYPT_02003](#))

[SWS_CRYPT_21512]{DRAFT} [

Kind:	function	
Symbol:	AddSalt(ReadOnlyMemRegion salt)	
Scope:	class ara::crypto::cryp::KeyDerivationFunctionCtx	
Syntax:	virtual ara::core::Result<void> ara::crypto::cryp::KeyDerivationFunctionCtx::AddSalt (ReadOnlyMemRegion salt) noexcept=0;	
Parameters (in):	salt	a salt value (if used, it should be unique for each instance of the target key)
Return value:	ara::core::Result< void >	–
Exception Safety:	noexcept	
Thread Safety:	Thread-safe	
Header file:	#include "ara/crypto/cryp/key_derivation_function_ctx.h"	
Description:	Add a salt value stored in a (non-secret) ReadOnlyMemRegion.	

]([RS_CRYPT_02102](#), [RS_CRYPT_02107](#), [RS_CRYPT_02108](#), [RS_CRYPT_02111](#))

[SWS_CRYPT_21513]{DRAFT} [

Kind:	function	
Symbol:	AddSecretSalt(const SecretSeed &salt)	
Scope:	class ara::crypto::cryp::KeyDerivationFunctionCtx	
Syntax:	virtual ara::core::Result<void> ara::crypto::cryp::KeyDerivationFunctionCtx::AddSecretSalt (const SecretSeed &salt) noexcept=0;	
Parameters (in):	salt	a salt value (if used, it should be unique for each instance of the target key)
Return value:	ara::core::Result< void >	–
Exception Safety:	noexcept	
Thread Safety:	Thread-safe	
Header file:	#include "ara/crypto/cryp/key_derivation_function_ctx.h"	
Description:	Add a secret salt value stored in a SecretSeed object.	

]([RS_CRYPT_02102](#), [RS_CRYPT_02107](#), [RS_CRYPT_02108](#), [RS_CRYPT_02111](#))

[SWS_CRYPT_21514]{DRAFT} [

Kind:	function	
Symbol:	ConfigIterations(std::uint32_t iterations=0)	
Scope:	class ara::crypto::cryp::KeyDerivationFunctionCtx	
Syntax:	virtual std::uint32_t ara::crypto::cryp::KeyDerivationFunctionCtx::ConfigIterations (std::uint32_t iterations=0) noexcept=0;	
Parameters (in):	iterations	the required number of iterations of the base function (0 means implementation default number)
Return value:	std::uint32_t	actual number of the iterations configured in the context now (after this method call)
Exception Safety:	noexcept	
Thread Safety:	Thread-safe	
Header file:	#include "ara/crypto/cryp/key_derivation_function_ctx.h"	
Description:	Configure the number of iterations that will be applied by default. Implementation can restrict minimal and/or maximal value of the iterations number.	

] ([RS_CRYPT_02309](#))

[SWS_CRYPT_21515]{DRAFT} [

Kind:	function	
Symbol:	DeriveKey(bool isSession=true, bool isExportable=false)	
Scope:	class ara::crypto::cryp::KeyDerivationFunctionCtx	
Syntax:	virtual ara::core::Result<SymmetricKey::Uptrc> ara::crypto::cryp::KeyDerivationFunctionCtx::DeriveKey (bool isSession=true, bool isExportable=false) const noexcept=0;	
Parameters (in):	isSession	the "session" (or "temporary") attribute for the target key (if true)
	isExportable	the exportability attribute for the target key (if true)
Return value:	ara::core::Result< SymmetricKey::Uptrc >	unique smart pointer to the created instance of derived symmetric key
Exception Safety:	noexcept	
Thread Safety:	Thread-safe	
Errors:	CryptoErrorDomain::kUninitialized Context	if the context was not sufficiently initialized
Header file:	#include "ara/crypto/cryp/key_derivation_function_ctx.h"	
Description:	Derive a symmetric key from the provided key material and provided context configuration.	

] ([RS_CRYPT_02102](#), [RS_CRYPT_02107](#), [RS_CRYPT_02108](#), [RS_CRYPT_02111](#), [RS_CRYPT_02115](#))

[SWS_CRYPT_21516]{DRAFT} [

Kind:	function	
Symbol:	DeriveSeed(bool isSession=true, bool isExportable=false)	
Scope:	class ara::crypto::cryp::KeyDerivationFunctionCtx	
Syntax:	virtual ara::core::Result<SecretSeed::Uptrc> ara::crypto::cryp::KeyDerivationFunctionCtx::DeriveSeed (bool isSession=true, bool isExportable=false) const noexcept=0;	
Parameters (in):	isSession	the "session" (or "temporary") attribute for the target key (if true)





	isExportable	the exportability attribute for the target key (if true)
Return value:	ara::core::Result< SecretSeed::Uptr >	unique smart pointer to the created SecretSeed object
Exception Safety:	noexcept	
Thread Safety:	Thread-safe	
Errors:	CryptoErrorDomain::kUninitialized Context	if the context was not sufficiently initialized
Header file:	#include "ara/crypto/cryp/key_derivation_function_ctx.h"	
Description:	Derive a "slave" key material (secret seed) from the provided "master" key material and provided context configuration.	

](RS_CRYPT_02007)

[SWS_CRYPT_21524]{DRAFT} [

Kind:	function
Symbol:	Reset()
Scope:	class ara::crypto::cryp::KeyDerivationFunctionCtx
Syntax:	virtual ara::core::Result<void> ara::crypto::cryp::KeyDerivationFunctionCtx::Reset () noexcept=0;
Return value:	ara::core::Result< void > -
Exception Safety:	noexcept
Thread Safety:	Thread-safe
Header file:	#include "ara/crypto/cryp/key_derivation_function_ctx.h"
Description:	Clear the crypto context.

](RS_CRYPT_02108)

[SWS_CRYPT_21517]{DRAFT} [

Kind:	function
Symbol:	GetExtensionService()
Scope:	class ara::crypto::cryp::KeyDerivationFunctionCtx
Syntax:	virtual ExtensionService::Uptr ara::crypto::cryp::KeyDerivationFunctionCtx::GetExtensionService () const noexcept=0;
Return value:	ExtensionService::Uptr -
Exception Safety:	noexcept
Header file:	#include "ara/crypto/cryp/key_derivation_function_ctx.h"
Description:	Get ExtensionService instance.

](RS_CRYPT_02006)

[SWS_CRYPT_21519]{DRAFT} [

Kind:	function
Symbol:	GetKeyIdSize()
Scope:	class ara::crypto::cryp::KeyDerivationFunctionCtx
Syntax:	virtual std::size_t ara::crypto::cryp::KeyDerivationFunctionCtx::GetKeyIdSize () const noexcept=0;



△

Return value:	std::size_t	size of the key ID in bytes the @c Init() call.
Exception Safety:	noexcept	
Thread Safety:	Thread-safe	
Header file:	#include "ara/crypto/cryp/key_derivation_function_ctx.h"	
Description:	Get the fixed size of the target key ID required by diversification algorithm. Returned value is constant for each instance of the interface, i.e. independent from configuration by. Returned value is constant for this instance of the key derivation context, i.e. independent from configuration by	

] ([RS_CRYPT_02103](#))

[SWS_CRYPT_21520]{DRAFT} [

Kind:	function	
Symbol:	GetTargetAlgId()	
Scope:	class ara::crypto::cryp::KeyDerivationFunctionCtx	
Syntax:	virtual AlgId ara::crypto::cryp::KeyDerivationFunctionCtx::GetTargetAlgId () const noexcept=0;	
Return value:	AlgId	the symmetric algorithm ID of the target key, configured by the last call of the Init() method returned.
Exception Safety:	noexcept	
Thread Safety:	Thread-safe	
Header file:	#include "ara/crypto/cryp/key_derivation_function_ctx.h"	
Description:	Get the symmetric algorithm ID of target (slave) key. If the context was not configured yet by a call of the Init() method then kAlgIdUndefined should be.	

] ([RS_CRYPT_02103](#))

[SWS_CRYPT_21521]{DRAFT} [

Kind:	function	
Symbol:	GetTargetAllowedUsage()	
Scope:	class ara::crypto::cryp::KeyDerivationFunctionCtx	
Syntax:	virtual AllowedUsageFlags ara::crypto::cryp::KeyDerivationFunctionCtx::GetTargetAllowedUsage () const noexcept=0;	
Return value:	AllowedUsageFlags	allowed key usage bit-flags of target keys
Exception Safety:	noexcept	
Thread Safety:	Thread-safe	
Header file:	#include "ara/crypto/cryp/key_derivation_function_ctx.h"	
Description:	Get allowed key usage of target (slave) key. The returned value depends on the source key-material allowed usage flags and the argument allowedUsage of last call of the Init() method. If the context has not yet been configured by a call of the Init() method, the allowed usage flags of the source key-material shall be returned. If the context has not yet been configured by a call of the Init() method and no source key-material has been set either, kAllowKdfMaterialAnyUsage shall be returned.	

] ([RS_CRYPT_02008](#))

[SWS_CRYPT_21522]{DRAFT} [

Kind:	function	
Symbol:	GetTargetKeyBitLength()	
Scope:	class ara::crypto::cryp::KeyDerivationFunctionCtx	
Syntax:	virtual std::size_t ara::crypto::cryp::KeyDerivationFunctionCtx::GetTargetKeyBitLength () const noexcept=0;	
Return value:	std::size_t	the length of target (diversified) key in bits the @c Init() calls.
Exception Safety:	noexcept	
Thread Safety:	Thread-safe	
Header file:	#include "ara/crypto/cryp/key_derivation_function_ctx.h"	
Description:	Get the bit-length of target (diversified) keys. Returned value is configured by the context factory method, i.e. independent from configuration by.	

] ([RS_CRYPT_02103](#))

[SWS_CRYPT_21523]{DRAFT} [

Kind:	function	
Symbol:	Init(ReadOnlyMemRegion targetKeyId, AlgId targetAlgId=kAlgIdAny, AllowedUsageFlags allowedUsage=kAllowKdfMaterialAnyUsage, ReadOnlyMemRegion ctxLabel=ReadOnlyMemRegion())	
Scope:	class ara::crypto::cryp::KeyDerivationFunctionCtx	
Syntax:	virtual ara::core::Result<void> ara::crypto::cryp::KeyDerivationFunctionCtx::Init (ReadOnlyMemRegion targetKeyId, AlgId targetAlgId=kAlgIdAny, AllowedUsageFlags allowedUsage=kAllowKdfMaterialAnyUsage, ReadOnlyMemRegion ctxLabel=ReadOnlyMemRegion()) noexcept=0;	
Parameters (in):	targetKeyId	ID of the target key
	targetAlgId	the identifier of the target symmetric crypto algorithm
	allowedUsage	bit-flags that define a list of allowed transformations' types in which the target key may be used
	ctxLabel	an optional application specific "context label" (this can identify the purpose of the target key and/or communication parties)
Return value:	ara::core::Result< void >	–
Exception Safety:	noexcept	
Thread Safety:	Thread-safe	
Errors:	CryptoErrorDomain::kIncompatible Arguments	if targetAlgId specifies a cryptographic algorithm different from a symmetric one with key length equal to GetTargetKeyBitLength();
	CryptoErrorDomain::kUsageViolation	if allowedUsage specifies more usages of the derived key-material than the source key-material, i.e. usage of the derived key-material may not be expanded beyond what the source key-material allows
Header file:	#include "ara/crypto/cryp/key_derivation_function_ctx.h"	
Description:	Initialize this context by setting at least the target key ID. The byte sequence provided via argument ctxLabel can include a few fields with different meaning separated by single 0x00 byte. If (targetAlgId == kAlgIdAny) then a diversified key can be loaded to any symmetric context that supports the same key length (if the "allowed usage" flags are also satisfied)!	

] ([RS_CRYPT_02102](#), [RS_CRYPT_02107](#), [RS_CRYPT_02108](#), [RS_CRYPT_02111](#), [RS_CRYPT_02115](#))

[SWS_CRYPT_21525]{DRAFT} [

Kind:	function	
Symbol:	SetSourceKeyMaterial(const RestrictedUseObject &sourceKM)	
Scope:	class ara::crypto::cryp::KeyDerivationFunctionCtx	
Syntax:	virtual ara::core::Result<void> ara::crypto::cryp::KeyDerivationFunctionCtx::SetSourceKeyMaterial (const RestrictedUseObject &source KM) noexcept=0;	
Parameters (in):	sourceKM	the source key-material
Return value:	ara::core::Result< void >	–
Exception Safety:	noexcept	
Thread Safety:	Thread-safe	
Errors:	CryptoErrorDomain::kIncompatible Object	if the provided key object is incompatible with this symmetric key context
	CryptoErrorDomain::kUsageViolation	if deriving a key is prohibited by the "allowed usage" restrictions of the provided source key-material
	CryptoErrorDomain::kBruteForceRisk	if key length of the sourceKm is below of an internally defined limitation
Header file:	#include "ara/crypto/cryp/key_derivation_function_ctx.h"	
Description:	Set (deploy) key-material to the key derivation algorithm context.	

] ([RS_CRYPT_02001](#), [RS_CRYPT_02003](#))

[SWS_CRYPT_21818]{DRAFT} [

Kind:	function	
Symbol:	GetEncapsulatedSize()	
Scope:	class ara::crypto::cryp::KeyEncapsulatorPublicCtx	
Syntax:	virtual std::size_t ara::crypto::cryp::KeyEncapsulatorPublicCtx::GetEncapsulatedSize () const noexcept=0;	
Return value:	std::size_t	size of the encapsulated data block in bytes
Exception Safety:	noexcept	
Thread Safety:	Thread-safe	
Header file:	#include "ara/crypto/cryp/key_encapsulator_public_ctx.h"	
Description:	Get fixed size of the encapsulated data block.	

] ([RS_CRYPT_02309](#))

[SWS_CRYPT_21802]{DRAFT} [

Kind:	function	
Symbol:	GetExtensionService()	
Scope:	class ara::crypto::cryp::KeyEncapsulatorPublicCtx	
Syntax:	virtual ExtensionService::Uptr ara::crypto::cryp::KeyEncapsulatorPublicCtx::GetExtensionService () const noexcept=0;	
Return value:	ExtensionService::Uptr	–
Exception Safety:	noexcept	
Header file:	#include "ara/crypto/cryp/key_encapsulator_public_ctx.h"	
Description:	Get ExtensionService instance.	

] ([RS_CRYPT_02006](#))

[SWS_CRYPT_21817]{DRAFT} [

Kind:	function	
Symbol:	GetKekEntropy()	
Scope:	class ara::crypto::cryp::KeyEncapsulatorPublicCtx	
Syntax:	virtual std::size_t ara::crypto::cryp::KeyEncapsulatorPublicCtx::GetKekEntropy () const noexcept=0;	
Return value:	std::size_t	entropy of the KEK material in bits
Exception Safety:	noexcept	
Thread Safety:	Thread-safe	
Header file:	#include "ara/crypto/cryp/key_encapsulator_public_ctx.h"	
Description:	Get entropy (bit-length) of the key encryption key (KEK) material. For RSA system the returned value corresponds to the length of module N (minus 1). For DH-like system the returned value corresponds to the length of module q (minus 1).	

] ([RS_CRYPT_02309](#))

[SWS_CRYPT_21810]{DRAFT} [

Kind:	function	
Symbol:	AddKeyingData(const RestrictedUseObject &keyingData)	
Scope:	class ara::crypto::cryp::KeyEncapsulatorPublicCtx	
Syntax:	virtual ara::core::Result<void> ara::crypto::cryp::KeyEncapsulatorPublicCtx::AddKeyingData (const RestrictedUseObject &keyingData) noexcept=0;	
Parameters (in):	keyingData	the payload to be protected
Return value:	ara::core::Result< void >	–
Exception Safety:	noexcept	
Thread Safety:	Thread-safe	
Errors:	CryptoErrc::kUsageViolation	if the keyingData cannot be exported due to Crypto Object::IsExportable() returning FALSE
	CryptoErrc::kIncompatibleObject	if the keyingData belongs to a different Crypto Provider
	CryptoErrc::kInvalidInputSize	if this context does not support the size of the keying Data
Header file:	#include "ara/crypto/cryp/key_encapsulator_public_ctx.h"	
Description:	Add the content to be encapsulated (payload) according to RFC 5990 ("keying data"). At the moment only SymmetricKey and SecretSeed objects are supported.	

] ([RS_CRYPT_02007](#))

[SWS_CRYPT_21813]{DRAFT} [

Kind:	function	
Symbol:	Encapsulate(KeyDerivationFunctionCtx &kdf, CryptoAlgId kekAlgId)	
Scope:	class ara::crypto::cryp::KeyEncapsulatorPublicCtx	
Syntax:	virtual ara::core::Result<ara::core::Vector<ara::core::Byte> > ara::crypto::cryp::KeyEncapsulatorPublicCtx::Encapsulate (Key DerivationFunctionCtx &kdf, CryptoAlgId kekAlgId) const noexcept=0;	
Parameters (in):	kdf	a context of a key derivation function, which should be used for the target KEK production
	kekAlgId	an algorithm ID of the target KEK





Return value:	ara::core::Result< ara::core::Vector< ara::core::Byte > >	the encapsulated data as a byte-vector
Exception Safety:	noexcept	
Thread Safety:	Thread-safe	
Errors:	CryptoErrc::kUninitializedContext	if the context was not initialized by a public key value
	CryptoErrc::kInvalidArgument	if kekAlgId or kdf are incompatible with this context
Header file:	#include "ara/crypto/cryp/key_encapsulator_public_ctx.h"	
Description:	Encapsulate the last set keying-data.	

]([RS_CRYPT_02102](#), [RS_CRYPT_02108](#), [RS_CRYPT_02115](#))

[SWS_CRYPT_21816]{DRAFT} [

Kind:	function	
Symbol:	Reset()	
Scope:	class ara::crypto::cryp::KeyEncapsulatorPublicCtx	
Syntax:	virtual ara::core::Result<void> ara::crypto::cryp::KeyEncapsulatorPublicCtx::Reset () noexcept=0;	
Return value:	ara::core::Result< void >	–
Exception Safety:	noexcept	
Thread Safety:	Thread-safe	
Header file:	#include "ara/crypto/cryp/key_encapsulator_public_ctx.h"	
Description:	Clear the crypto context.	

]([RS_CRYPT_02108](#))

[SWS_CRYPT_21815]{DRAFT} [

Kind:	function	
Symbol:	SetKey(const PublicKey &key)	
Scope:	class ara::crypto::cryp::KeyEncapsulatorPublicCtx	
Syntax:	virtual ara::core::Result<void> ara::crypto::cryp::KeyEncapsulatorPublicCtx::SetKey (const PublicKey &key) noexcept=0;	
Parameters (in):	key	the source key object
Return value:	ara::core::Result< void >	–
Exception Safety:	noexcept	
Thread Safety:	Thread-safe	
Errors:	CryptoErrc::kIncompatibleObject	if the provided key object is incompatible with this symmetric key context
	CryptoErrc::kUsageViolation	if the transformation type associated with this context is prohibited by the "allowed usage" restrictions of provided key object
Header file:	#include "ara/crypto/cryp/key_encapsulator_public_ctx.h"	
Description:	Set (deploy) a key to the key encapsulator public algorithm context.	

]([RS_CRYPT_02001](#), [RS_CRYPT_02003](#))

[SWS_CRYPT_22119]{DRAFT} [

Kind:	function	
Symbol:	Check(const Signature &expected)	
Scope:	class ara::crypto::cryp::MessageAuthnCodeCtx	
Syntax:	virtual ara::core::Result<bool> ara::crypto::cryp::MessageAuthnCodeCtx::Check (const Signature &expected) const noexcept=0;	
Parameters (in):	expected	the signature object containing an expected digest value
Return value:	ara::core::Result< bool >	true if value and meta-information of the provided "signature" object is identical to calculated digest and current configuration of the context respectively; but false otherwise
Exception Safety:	noexcept	
Thread Safety:	Thread-safe	
Errors:	CryptoErrorDomain::kProcessingNot Finished	if the digest calculation was not finished by a call of the Finish() method
	CryptoErrorDomain::kIncompatible Object	if the provided "signature" object was produced by another crypto primitive type
Header file:	#include "ara/crypto/cryp/message_authn_code_ctx.h"	
Description:	Check the calculated digest against an expected "signature" object. Entire digest value is kept in the context up to next call Start(), therefore it can be verified again or extracted. This method can be implemented as "inline" after standartization of function ara::core::memcmp().	

] ([RS_CRYPT_02203](#), [RS_CRYPT_02204](#))

[SWS_CRYPT_22115]{DRAFT} [

Kind:	function	
Symbol:	Finish(bool makeSignatureObject=false)	
Scope:	class ara::crypto::cryp::MessageAuthnCodeCtx	
Syntax:	virtual ara::core::Result< Signature::Uptrc > ara::crypto::cryp::MessageAuthnCodeCtx::Finish (bool makeSignatureObject=false) noexcept=0;	
Parameters (in):	makeSignatureObject	if this argument is true then the method will also produce the signature object
Return value:	ara::core::Result< Signature::Uptrc >	unique smart pointer to created signature object, if (makeSignatureObject == true) or nullptr if (makeSignatureObject == false)
Exception Safety:	noexcept	
Thread Safety:	Thread-safe	
Errors:	CryptoErrorDomain::kProcessingNot Started	if the digest calculation was not initiated by a call of the Start() method
	CryptoErrorDomain::kUsageViolation	if the buffered digest belongs to a MAC/HMAC/AE/AEAD context initialized by a key without kAllowSignature permission, but (makeSignatureObject == true)
Header file:	#include "ara/crypto/cryp/message_authn_code_ctx.h"	
Description:	Finish the digest calculation and optionally produce the "signature" object. Only after call of this method the digest can be signed, verified, extracted or compared! If the signature object produced by a keyed MAC/HMAC/AE/AEAD algorithm then the dependence COUID of the "signature" should be set to COUID of used symmetric key.	

] ([RS_CRYPT_02302](#), [RS_CRYPT_02203](#))

[SWS_CRYPT_22102]{DRAFT} [

Kind:	function
Symbol:	GetDigestService()
Scope:	class ara::crypto::cryp::MessageAuthnCodeCtx
Syntax:	virtual DigestService::Uptr ara::crypto::cryp::MessageAuthnCodeCtx::GetDigestService () const noexcept=0;
Return value:	DigestService::Uptr -
Exception Safety:	noexcept
Header file:	#include "ara/crypto/cryp/message_authn_code_ctx.h"
Description:	Get DigestService instance.

] ([RS_CRYPT_02006](#))

[SWS_CRYPT_22116]{DRAFT} [

Kind:	function				
Symbol:	GetDigest(std::size_t offset=0)				
Scope:	class ara::crypto::cryp::MessageAuthnCodeCtx				
Syntax:	virtual ara::core::Result<ara::core::Vector<ara::core::Byte> > ara::crypto::cryp::MessageAuthnCodeCtx::GetDigest (std::size_t offset=0) const noexcept=0;				
Parameters (in):	offset position of the first byte of digest that should be placed to the output buffer				
Return value:	ara::core::Result< ara::core::Vector< ara::core::Byte > > number of digest bytes really stored to the output buffer (they are always <= output.size() and denoted below as return_size)				
Exception Safety:	noexcept				
Thread Safety:	Thread-safe				
Errors:	<table border="0"> <tr> <td>CryptoErrorDomain::kProcessingNot Finished</td> <td>if the digest calculation was not finished by a call of the Finish() method</td> </tr> <tr> <td>CryptoErrorDomain::kUsageViolation</td> <td>if the buffered digest belongs to a MAC/HMAC/AE/AEAD context initialized by a key without kAllow Signature permission</td> </tr> </table>	CryptoErrorDomain::kProcessingNot Finished	if the digest calculation was not finished by a call of the Finish() method	CryptoErrorDomain::kUsageViolation	if the buffered digest belongs to a MAC/HMAC/AE/AEAD context initialized by a key without kAllow Signature permission
CryptoErrorDomain::kProcessingNot Finished	if the digest calculation was not finished by a call of the Finish() method				
CryptoErrorDomain::kUsageViolation	if the buffered digest belongs to a MAC/HMAC/AE/AEAD context initialized by a key without kAllow Signature permission				
Header file:	#include "ara/crypto/cryp/message_authn_code_ctx.h"				
Description:	Get requested part of calculated digest to existing memory buffer. Entire digest value is kept in the context up to next call Start(), therefore any its part can be extracted again or verified. If (full_digest_size <= offset) then return_size = 0 bytes; else return_size = min(output.size(), (full_digest_size - offset)) bytes. This method can be implemented as "inline" after standartization of function ara::core::memcpy().				

] ([RS_CRYPT_02203](#))

[SWS_CRYPT_22117]{DRAFT} [

Kind:	function
Symbol:	GetDigest(std::size_t offset=0)
Scope:	class ara::crypto::cryp::MessageAuthnCodeCtx
Syntax:	template <typename Alloc = <implementation-defined>> ara::core::Result<ByteVector<Alloc> > ara::crypto::cryp::MessageAuthnCodeCtx::GetDigest (std::size_t offset=0) const noexcept;
Template param:	Alloc a custom allocator type of the output container





Parameters (in):	offset	position of first byte of digest that should be placed to the output buffer
Return value:	ara::core::Result< ByteVector< Alloc > >	–
Exception Safety:	noexcept	
Thread Safety:	Thread-safe	
Errors:	CryptoErrorDomain::kProcessingNot Finished	if the digest calculation was not finished by a call of the Finish() method
	CryptoErrorDomain::kUsageViolation	if the buffered digest belongs to a MAC/HMAC/AE/AEAD context initialized by a key without kAllow Signature permission
Header file:	#include "ara/crypto/cryp/message_authn_code_ctx.h"	
Description:	Get requested part of calculated digest to pre-reserved managed container. This method sets the size of the output container according to actually saved value. Entire digest value is kept in the context up to next call Start(), therefore any its part can be extracted again or verified. If (full_digest_size <= offset) then return_size = 0 bytes; else return_size = min(output.capacity(), (full_digest_size - offset)) bytes.	

](RS_CRYPT_02203)

[SWS_CRYPT_22120]{DRAFT} [

Kind:	function	
Symbol:	Reset()	
Scope:	class ara::crypto::cryp::MessageAuthnCodeCtx	
Syntax:	virtual ara::core::Result<void> ara::crypto::cryp::MessageAuthnCodeCtx::Reset () noexcept=0;	
Return value:	ara::core::Result< void >	–
Exception Safety:	noexcept	
Thread Safety:	Thread-safe	
Header file:	#include "ara/crypto/cryp/message_authn_code_ctx.h"	
Description:	Clear the crypto context.	

](RS_CRYPT_02108)

[SWS_CRYPT_22118]{DRAFT} [

Kind:	function	
Symbol:	SetKey(const SymmetricKey &key, CryptoTransform transform=CryptoTransform::kMacGenerate)	
Scope:	class ara::crypto::cryp::MessageAuthnCodeCtx	
Syntax:	virtual ara::core::Result<void> ara::crypto::cryp::MessageAuthnCodeCtx::SetKey (const SymmetricKey &key, CryptoTransform transform=CryptoTransform::kMacGenerate) noexcept=0;	
Parameters (in):	key	the source key object
	transform	the "direction" indicator: deploy the key for direct transformation (if true) or for reverse one (if false)
Return value:	ara::core::Result< void >	–
Exception Safety:	noexcept	
Thread Safety:	Thread-safe	





Errors:	CryptoErrorDomain::kIncompatible Object	if the provided key object is incompatible with this symmetric key context
	CryptoErrorDomain::kUsageViolation	if the transformation type associated with this context (taking into account the direction specified by transform) is prohibited by the "allowed usage" restrictions of provided key object
Header file:	#include "ara/crypto/cryp/message_authn_code_ctx.h"	
Description:	Set (deploy) a key to the message authn code algorithm context.	

]([RS_CRYPT_02001](#), [RS_CRYPT_02003](#))

[SWS_CRYPT_22110]{DRAFT} [

Kind:	function	
Symbol:	Start(ReadOnlyMemRegion iv=ReadOnlyMemRegion())	
Scope:	class ara::crypto::cryp::MessageAuthnCodeCtx	
Syntax:	virtual ara::core::Result<void> ara::crypto::cryp::MessageAuthnCodeCtx::Start (ReadOnlyMemRegion iv=ReadOnlyMemRegion()) noexcept=0;	
Parameters (in):	iv	an optional Initialization Vector (IV) or "nonce" value
Return value:	ara::core::Result< void >	–
Exception Safety:	noexcept	
Thread Safety:	Thread-safe	
Errors:	CryptoErrorDomain::kUninitialized Context	if the context was not initialized by deploying a key
	CryptoErrorDomain::kInvalidInputSize	if the size of provided IV is not supported (i.e. if it is not enough for the initialization)
	CryptoErrorDomain::kUnsupported	if the base algorithm (or its current implementation) principally doesn't support the IV variation, but provided IV value is not empty, i.e. if (iv.empty() == false)
Header file:	#include "ara/crypto/cryp/message_authn_code_ctx.h"	
Description:	Initialize the context for a new data stream processing or generation (depending from the primitive). If IV size is greater than maximally supported by the algorithm then an implementation may use the leading bytes only from the sequence.	

]([RS_CRYPT_02302](#))

[SWS_CRYPT_22111]{DRAFT} [

Kind:	function	
Symbol:	Start(const SecretSeed &iv)	
Scope:	class ara::crypto::cryp::MessageAuthnCodeCtx	
Syntax:	virtual ara::core::Result<void> ara::crypto::cryp::MessageAuthnCodeCtx::Start (const SecretSeed &iv) noexcept=0;	
Parameters (in):	iv	the Initialization Vector (IV) or "nonce" object
Return value:	ara::core::Result< void >	–
Exception Safety:	noexcept	
Thread Safety:	Thread-safe	
Errors:	CryptoErrorDomain::kUninitialized Context	if the context was not initialized by deploying a key



△

	CryptoErrorDomain::kInvalidInputSize	if the size of provided IV is not supported (i.e. if it is not enough for the initialization)
	CryptoErrorDomain::kUnsupported	if the base algorithm (or its current implementation) principally doesn't support the IV variation
	CryptoErrorDomain::kUsageViolation	if this transformation type is prohibited by the "allowed usage" restrictions of the provided Secret Seed object
Header file:	#include "ara/crypto/cryp/message_authn_code_ctx.h"	
Description:	Initialize the context for a new data stream processing or generation (depending from the primitive). If IV size is greater than maximally supported by the algorithm then an implementation may use the leading bytes only from the sequence.	

] ([RS_CRYPT_02302](#))

[SWS_CRYPT_22112]{DRAFT} [

Kind:	function	
Symbol:	Update(const RestrictedUseObject &in)	
Scope:	class ara::crypto::cryp::MessageAuthnCodeCtx	
Syntax:	virtual ara::core::Result<void> ara::crypto::cryp::MessageAuthnCodeCtx::Update (const RestrictedUseObject &in) noexcept=0;	
Parameters (in):	in	a part of input message that should be processed
Return value:	ara::core::Result< void >	–
Exception Safety:	noexcept	
Thread Safety:	Thread-safe	
Errors:	CryptoErrorDomain::kProcessingNot Started	if the digest calculation was not initiated by a call of the Start() method
Header file:	#include "ara/crypto/cryp/message_authn_code_ctx.h"	
Description:	Update the digest calculation context by a new part of the message. This method is dedicated for cases then the RestrictedUseObject is a part of the "message".	

] ([RS_CRYPT_02302](#))

[SWS_CRYPT_22113]{DRAFT} [

Kind:	function	
Symbol:	Update(ReadOnlyMemRegion in)	
Scope:	class ara::crypto::cryp::MessageAuthnCodeCtx	
Syntax:	virtual ara::core::Result<void> ara::crypto::cryp::MessageAuthnCodeCtx::Update (ReadOnlyMemRegion in) noexcept=0;	
Parameters (in):	in	a part of the input message that should be processed
Return value:	ara::core::Result< void >	–
Exception Safety:	noexcept	
Thread Safety:	Thread-safe	
Errors:	CryptoErrorDomain::kProcessingNot Started	if the digest calculation was not initiated by a call of the Start() method
Header file:	#include "ara/crypto/cryp/message_authn_code_ctx.h"	
Description:	Update the digest calculation context by a new part of the message.	

] ([RS_CRYPT_02302](#))

[SWS_CRYPT_22114]{DRAFT} [

Kind:	function	
Symbol:	Update(std::uint8_t in)	
Scope:	class ara::crypto::cryp::MessageAuthnCodeCtx	
Syntax:	virtual ara::core::Result<void> ara::crypto::cryp::MessageAuthnCodeCtx::Update (std::uint8_t in) noexcept=0;	
Parameters (in):	in	a byte value that is a part of input message
Return value:	ara::core::Result< void >	–
Exception Safety:	noexcept	
Thread Safety:	Thread-safe	
Errors:	CryptoErrorDomain::kProcessingNot Started	if the digest calculation was not initiated by a call of the Start() method
Header file:	#include "ara/crypto/cryp/message_authn_code_ctx.h"	
Description:	Update the digest calculation context by a new part of the message. This method is convenient for processing of constant tags.	

] ([RS_CRYPT_02302](#))

[SWS_CRYPT_22210]{DRAFT} [

Kind:	function	
Symbol:	GetExtensionService()	
Scope:	class ara::crypto::cryp::MsgRecoveryPublicCtx	
Syntax:	virtual ExtensionService::Uptr ara::crypto::cryp::MsgRecoveryPublicCtx::GetExtensionService () const noexcept=0;	
Return value:	ExtensionService::Uptr	–
Exception Safety:	noexcept	
Header file:	#include "ara/crypto/cryp/msg_recovery_public_ctx.h"	
Description:	Get ExtensionService instance.	

] ([RS_CRYPT_02006](#))

[SWS_CRYPT_22213]{DRAFT} [

Kind:	function	
Symbol:	GetMaxInputSize(bool suppressPadding=false)	
Scope:	class ara::crypto::cryp::MsgRecoveryPublicCtx	
Syntax:	virtual std::size_t ara::crypto::cryp::MsgRecoveryPublicCtx::GetMaxInputSize (bool suppressPadding=false) const noexcept=0;	
Parameters (in):	suppressPadding	if true then the method calculates the size for the case when the whole space of the plain data block is used for the payload only
Return value:	std::size_t	maximum size of the input data block in bytes
Exception Safety:	noexcept	
Thread Safety:	Thread-safe	
Header file:	#include "ara/crypto/cryp/msg_recovery_public_ctx.h"	
Description:	Get maximum expected size of the input data block. If (IsEncryption() == false) then a value returned by this method is independent from the suppressPadding argument and it will be equal to the block size.	

] ([RS_CRYPT_02309](#))

[SWS_CRYPT_22214]{DRAFT} [

Kind:	function	
Symbol:	GetMaxOutputSize(bool suppressPadding=false)	
Scope:	class ara::crypto::cryp::MsgRecoveryPublicCtx	
Syntax:	virtual std::size_t ara::crypto::cryp::MsgRecoveryPublicCtx::GetMaxOutputSize (bool suppressPadding=false) const noexcept=0;	
Parameters (in):	suppressPadding	if true then the method calculates the size for the case when the whole space of the plain data block is used for the payload only
Return value:	std::size_t	maximum size of the output data block in bytes
Exception Safety:	noexcept	
Thread Safety:	Thread-safe	
Header file:	#include "ara/crypto/cryp/msg_recovery_public_ctx.h"	
Description:	Get maximum possible size of the output data block. If (IsEncryption() == true) then a value returned by this method is independent from the suppressPadding argument and will be equal to the block size.	

] ([RS_CRYPT_02309](#))

[SWS_CRYPT_22215]{DRAFT} [

Kind:	function	
Symbol:	DecodeAndVerify(ReadOnlyMemRegion in)	
Scope:	class ara::crypto::cryp::MsgRecoveryPublicCtx	
Syntax:	virtual ara::core::Result<ara::core::Vector<ara::core::Byte> > ara::crypto::cryp::MsgRecoveryPublicCtx::DecodeAndVerify (ReadOnlyMemRegion in) const noexcept=0;	
Parameters (in):	in	the input data block
Return value:	ara::core::Result< ara::core::Vector< ara::core::Byte > >	the output buffer actual size of output data (it always <= out.size()) or 0 if the input data block has incorrect content
Exception Safety:	noexcept	
Thread Safety:	Thread-safe	
Errors:	CryptoErrorDomain::kIncorrectInputSize	if the mentioned above rules about the input size is violated
	CryptoErrorDomain::kUninitializedContext	if the context was not initialized by a key value
Header file:	#include "ara/crypto/cryp/msg_recovery_public_ctx.h"	
Description:	Process (encrypt / decrypt) an input block according to the cryptor configuration. Encryption with (suppressPadding == true) expects that: in.size() == GetMaxInputSize(true) && out.size() >= GetMaxOutputSize(true). Encryption with (suppressPadding == false) expects that: in.size() <= GetMaxInputSize(false) && in.size() > 0 && out.size() >= GetMaxOutputSize(false). Decryption expects that: in.size() == GetMaxInputSize() && out.size() >= GetMaxOutputSize(suppressPadding). The case (out.size() < GetMaxOutputSize()) should be used with caution, only if you are strictly certain about the size of the output data! In case of (suppressPadding == true) the actual size of plain text should be equal to full size of the plain data block (defined by the algorithm)!	

] ([RS_CRYPT_02204](#))

[SWS_CRYPT_22216]{DRAFT} [

Kind:	function	
Symbol:	DecodeAndVerify(ReadOnlyMemRegion in)	
Scope:	class ara::crypto::cryp::MsgRecoveryPublicCtx	
Syntax:	<pre>template <typename Alloc = <implementation-defined>> ara::core::Result<ByteVector<Alloc> > ara::crypto::cryp::MsgRecovery PublicCtx::DecodeAndVerify (ReadOnlyMemRegion in) const noexcept;</pre>	
Template param:	Alloc	a custom allocator type of the output container
Parameters (in):	in	the input data block
Return value:	ara::core::Result< ByteVector< Alloc > >	the managed container for output block
Exception Safety:	noexcept	
Thread Safety:	Thread-safe	
Errors:	CryptoErrorDomain::kIncorrectInput Size	if the mentioned above rules about the input size is violated
	CryptoErrorDomain::kUninitialized Context	if the context was not initialized by a key value
Header file:	#include "ara/crypto/cryp/msg_recovery_public_ctx.h"	
Description:	Process (encrypt / decrypt) an input block according to the cryptor configuration. This method sets the size of the output container according to actually saved value! Encryption with (suppressPadding == true) expects what: in.size() == GetMaxInputSize(true) && out.capacity() >= GetMaxOutputSize(true). Encryption with (suppressPadding == false) expects what: in.size() <= GetMaxInputSize(false) && in.size() > 0 && out.capacity() >= GetMaxOutputSize(false). Decryption expects what: in.size() == GetMaxInputSize() && out.capacity() >= GetMaxOutputSize(suppressPadding). The case (out.capacity() < GetMaxOutputSize()) should be used with caution, only if you are strictly certain about the size of the output data! In case of (suppressPadding == true) the actual size of plain text should be equal to full size of the plain data block (defined by the algorithm)!	

] ([RS_CRYPT_02204](#))

[SWS_CRYPT_22212]{DRAFT} [

Kind:	function	
Symbol:	Reset()	
Scope:	class ara::crypto::cryp::MsgRecoveryPublicCtx	
Syntax:	<pre>virtual ara::core::Result<void> ara::crypto::cryp::MsgRecoveryPublic Ctx::Reset () noexcept=0;</pre>	
Return value:	ara::core::Result< void >	–
Exception Safety:	noexcept	
Thread Safety:	Thread-safe	
Header file:	#include "ara/crypto/cryp/msg_recovery_public_ctx.h"	
Description:	Clear the crypto context.	

] ([RS_CRYPT_02108](#))

[SWS_CRYPT_22211]{DRAFT} [

Kind:	function	
Symbol:	SetKey(const PublicKey &key)	
Scope:	class ara::crypto::cryp::MsgRecoveryPublicCtx	



△

Syntax:	virtual ara::core::Result<void> ara::crypto::cryp::MsgRecoveryPublic Ctx::SetKey (const PublicKey &key) noexcept=0;	
Parameters (in):	key	the source key object
Return value:	ara::core::Result< void >	–
Exception Safety:	noexcept	
Thread Safety:	Thread-safe	
Errors:	CryptoErrorDomain::kIncompatible Object	if the provided key object is incompatible with this symmetric key context
	CryptoErrorDomain::kUsageViolation	if the transformation type associated with this context is prohibited by the "allowed usage" restrictions of provided key object
Header file:	#include "ara/crypto/cryp/msg_recovery_public_ctx.h"	
Description:	Set (deploy) a key to the msg recovery public algorithm context.	

] ([RS_CRYPT_02001](#), [RS_CRYPT_02003](#))

[SWS_CRYPT_22511]{DRAFT} [

Kind:	function	
Symbol:	GetPublicKey()	
Scope:	class ara::crypto::cryp::PrivateKey	
Syntax:	virtual ara::core::Result< PublicKey::Uptrc > ara::crypto::cryp::PrivateKey::GetPublicKey () const noexcept=0;	
Return value:	ara::core::Result< PublicKey::Uptrc >	unique smart pointer to the public key correspondent to this private key
Exception Safety:	noexcept	
Thread Safety:	Thread-safe	
Header file:	#include "ara/crypto/cryp/cryobj/private_key.h"	
Description:	Get the public key correspondent to this private key.	

] ([RS_CRYPT_02108](#), [RS_CRYPT_02115](#))

[SWS_CRYPT_22711]{OBSOLETE} [

Kind:	function	
Symbol:	CheckKey(bool strongCheck=true)	
Scope:	class ara::crypto::cryp::PublicKey	
Syntax:	virtual bool ara::crypto::cryp::PublicKey::CheckKey (bool strong Check=true) const noexcept=0;	
Parameters (in):	strongCheck	the severeness flag that indicates type of the required check: strong (if true) or fast (if false)
Return value:	bool	true if the key is correct
Exception Safety:	noexcept	
Thread Safety:	Thread-safe	
Header file:	#include "ara/crypto/cryp/cryobj/public_key.h"	
Description:	Check the key for its correctness.	

] ([RS_CRYPT_02202](#))

[SWS_CRYPT_22712]{DRAFT} [

Kind:	function	
Symbol:	HashPublicKey(HashFunctionCtx &hashFunc)	
Scope:	class ara::crypto::cryp::PublicKey	
Syntax:	virtual ara::core::Result<ara::core::Vector<ara::core::Byte> > ara::crypto::cryp::PublicKey::HashPublicKey (HashFunctionCtx &hashFunc) const noexcept=0;	
Parameters (in):	hashFunc	a hash-function instance that should be used the hashing
Return value:	ara::core::Result< ara::core::Vector< ara::core::Byte > >	a buffer preallocated for the resulting hash value
Exception Safety:	noexcept	
Thread Safety:	Thread-safe	
Errors:	CryptoErrorDomain::kInsufficientCapacity	if size of the hash buffer is not enough for storing of the result
	CryptoErrorDomain::kIncompleteArgState	if the hashFunc context is not initialized
Header file:	#include "ara/crypto/cryp/cryobj/public_key.h"	
Description:	Calculate hash of the Public Key value. The original public key value BLOB is available via the Serializable interface.	

] ([RS_CRYPT_02202](#))

[SWS_CRYPT_22713]{DRAFT} [

Kind:	function	
Symbol:	HashPublicKey(HashFunctionCtx &hashFunc)	
Scope:	class ara::crypto::cryp::PublicKey	
Syntax:	template <typename Alloc = <i><implementation-defined></i> > ara::core::Result<ByteVector<Alloc> > ara::crypto::cryp::PublicKey::HashPublicKey (HashFunctionCtx &hashFunc) const noexcept;	
Template param:	Alloc	a custom allocator type of the output container
Parameters (in):	hashFunc	a hash-function instance that should be used the hashing
Return value:	ara::core::Result< ByteVector< Alloc > >	pre-reserved managed container for the resulting hash value
Exception Safety:	noexcept	
Thread Safety:	Thread-safe	
Errors:	CryptoErrorDomain::kInsufficientCapacity	if capacity of the hash buffer is not enough for storing of the result
	CryptoErrorDomain::kIncompleteArgState	if the hashFunc context is not initialized
Header file:	#include "ara/crypto/cryp/cryobj/public_key.h"	
Description:	Calculate hash of the Public Key value. This method sets the size of the output container according to actually saved value! The original public key value BLOB is available via the Serializable interface.	

] ([RS_CRYPT_02202](#))

[SWS_CRYPT_22914]{DRAFT} [

Kind:	function	
Symbol:	AddEntropy(ReadOnlyMemRegion entropy)	
Scope:	class ara::crypto::cryp::RandomGeneratorCtx	
Syntax:	virtual bool ara::crypto::cryp::RandomGeneratorCtx::AddEntropy (ReadOnlyMemRegion entropy) noexcept=0;	
Parameters (in):	entropy	a memory region with the additional entropy value
Return value:	bool	true if the method is supported and the entropy has been updated successfully
Exception Safety:	noexcept	
Thread Safety:	Thread-safe	
Header file:	#include "ara/crypto/cryp/random_generator_ctx.h"	
Description:	Update the internal state of the RNG by mixing it with the provided additional entropy. This method is optional for implementation. An implementation of this method may "accumulate" provided entropy for future use.	

] ([RS_CRYPT_02206](#))

[SWS_CRYPT_22915]{DRAFT} [

Kind:	function	
Symbol:	Generate(std::uint32_t count)	
Scope:	class ara::crypto::cryp::RandomGeneratorCtx	
Syntax:	virtual ara::core::Result<ara::core::Vector<ara::core::Byte> > ara::crypto::cryp::RandomGeneratorCtx::Generate (std::uint32_t count) noexcept=0;	
Parameters (in):	count	number of random bytes to generate
Return value:	ara::core::Result< ara::core::Vector< ara::core::Byte > >	a buffer filled with the generated random sequence
Exception Safety:	noexcept	
Thread Safety:	Thread-safe	
Errors:	CryptoErrorDomain::kUninitialized Context	if this context implements a local RNG (i.e., the RNG state is controlled by the application), and has to be seeded by the application because it either has not already been seeded or ran out of entropy.
	CryptoErrorDomain::kBusyResource	if this context implements a global RNG (i.e., the RNG state is controlled by the stack and not the application) that is currently out-of-entropy and therefore cannot provide the requested number of random bytes
Header file:	#include "ara/crypto/cryp/random_generator_ctx.h"	
Description:	Return an allocated buffer with a generated random sequence of the requested size.	

] ([RS_CRYPT_02206](#))

[SWS_CRYPT_22902]{DRAFT} [

Kind:	function	
Symbol:	GetExtensionService()	
Scope:	class ara::crypto::cryp::RandomGeneratorCtx	





Syntax:	virtual ExtensionService::Uptr ara::crypto::cryp::RandomGeneratorCtx::GetExtensionService () const noexcept=0;	
Return value:	ExtensionService::Uptr	–
Exception Safety:	noexcept	
Header file:	#include "ara/crypto/cryp/random_generator_ctx.h"	
Description:	Get ExtensionService instance.	

]([RS_CRYPT_02006](#))

[SWS_CRYPT_22911]{DRAFT} [

Kind:	function	
Symbol:	Seed(ReadOnlyMemRegion seed)	
Scope:	class ara::crypto::cryp::RandomGeneratorCtx	
Syntax:	virtual bool ara::crypto::cryp::RandomGeneratorCtx::Seed (ReadOnlyMemRegion seed) noexcept=0;	
Parameters (in):	seed	a memory region with the seed value
Return value:	bool	true if the method is supported and the state has been set successfully
Exception Safety:	noexcept	
Thread Safety:	Thread-safe	
Header file:	#include "ara/crypto/cryp/random_generator_ctx.h"	
Description:	Set the internal state of the RNG using the provided seed.	

]([RS_CRYPT_02206](#))

[SWS_CRYPT_22912]{DRAFT} [

Kind:	function	
Symbol:	Seed(const SecretSeed &seed)	
Scope:	class ara::crypto::cryp::RandomGeneratorCtx	
Syntax:	virtual bool ara::crypto::cryp::RandomGeneratorCtx::Seed (const SecretSeed &seed) noexcept=0;	
Parameters (in):	seed	a memory region with the seed value
Return value:	bool	true if the method is supported and the state has been set successfully
Exception Safety:	noexcept	
Thread Safety:	Thread-safe	
Header file:	#include "ara/crypto/cryp/random_generator_ctx.h"	
Description:	Set the internal state of the RNG using the provided seed.	

]([RS_CRYPT_02206](#))

[SWS_CRYPT_22913]{DRAFT} [

Kind:	function	
Symbol:	SetKey(const SymmetricKey &key)	
Scope:	class ara::crypto::cryp::RandomGeneratorCtx	



△

Syntax:	<code>virtual bool ara::crypto::cryp::RandomGeneratorCtx::SetKey (const SymmetricKey &key) noexcept=0;</code>	
Parameters (in):	key	a SymmetricKey with the key used as seed value
Return value:	bool	true if the method is supported and the key has been set successfully
Exception Safety:	noexcept	
Thread Safety:	Thread-safe	
Header file:	#include "ara/crypto/cryp/random_generator_ctx.h"	
Description:	Set the internal state of the RNG using the provided seed.	

]([RS_CRYPT_02001](#), [RS_CRYPT_02003](#))

[SWS_CRYPT_24811]{DRAFT} [

Kind:	function	
Symbol:	GetAllowedUsage()	
Scope:	class ara::crypto::cryp::RestrictedUseObject	
Syntax:	<code>virtual Usage ara::crypto::cryp::RestrictedUseObject::GetAllowedUsage () const noexcept=0;</code>	
Return value:	Usage	a combination of bit-flags that specifies allowed applications of the object
Exception Safety:	noexcept	
Thread Safety:	Thread-safe	
Header file:	#include "ara/crypto/cryp/cryobj/restricted_use_object.h"	
Description:	Get allowed usages of this object.	

]([RS_CRYPT_02008](#))

[SWS_CRYPT_23011]{DRAFT} [

Kind:	function	
Symbol:	Clone(ReadOnlyMemRegion xorDelta=ReadOnlyMemRegion())	
Scope:	class ara::crypto::cryp::SecretSeed	
Syntax:	<code>virtual ara::core::Result<SecretSeed::Uptr> ara::crypto::cryp::SecretSeed::Clone (ReadOnlyMemRegion xorDelta=ReadOnlyMemRegion()) const noexcept=0;</code>	
Parameters (in):	xorDelta	optional "delta" value that must be XOR-ed with the "cloned" copy of the original seed
Return value:	<code>ara::core::Result< SecretSeed::Uptr ></code>	unique smart pointer to "cloned" session Secret Seed object
Exception Safety:	noexcept	
Thread Safety:	Thread-safe	
Header file:	#include "ara/crypto/cryp/cryobj/secret_seed.h"	
Description:	Clone this Secret Seed object to new session object. Created object instance is session and non-exportable, AllowedUsageFlags attribute of the "cloned" object is identical to this attribute of the source object! If size of the xorDelta argument is less than the value size of this seed then only correspondent number of leading bytes of the original seed should be XOR-ed, but the rest should be copied without change. If size of the xorDelta argument is larger than the value size of this seed then extra bytes of the xorDelta should be ignored.	

]([RS_CRYPT_02007](#))

[SWS_CRYPT_23012]{OBSOLETE} [

Kind:	function	
Symbol:	JumpFrom(const SecretSeed &from, std::int64_t steps)	
Scope:	class ara::crypto::cryp::SecretSeed	
Syntax:	virtual ara::core::Result<void> ara::crypto::cryp::SecretSeed::JumpFrom (const SecretSeed &from, std::int64_t steps) noexcept=0;	
Parameters (in):	from	source object that keeps the initial value for jumping from
	steps	number of steps for the "jump"
Return value:	ara::core::Result< void >	reference to this updated object
Exception Safety:	noexcept	
Thread Safety:	Thread-safe	
Errors:	CryptoErrorDomain::kIncompatibleObject	if this object and the from argument are associated with incompatible cryptographic algorithms
	CryptoErrorDomain::kInvalidInputSize	if value size of the from seed is less then value size of this one
Header file:	#include "ara/crypto/cryp/cryobj/secret_seed.h"	
Description:	Set value of this seed object as a "jump" from an initial state to specified number of steps, according to "counting" expression defined by a cryptographic algorithm associated with this object. steps may have positive and negative values that correspond to forward and backward direction of the "jump" respectively, but 0 value means only copy from value to this seed object. Seed size of the from argument always must be greater or equal of this seed size.	

] ([RS_CRYPT_02007](#))

[SWS_CRYPT_23014]{OBSOLETE} [

Kind:	function	
Symbol:	Jump(std::int64_t steps)	
Scope:	class ara::crypto::cryp::SecretSeed	
Syntax:	virtual SecretSeed & ara::crypto::cryp::SecretSeed::Jump (std::int64_t steps) noexcept=0;	
Parameters (in):	steps	number of "steps" for jumping (forward or backward) from the current state
	SecretSeed &	reference to this updated object
Exception Safety:	noexcept	
Thread Safety:	Thread-safe	
Header file:	#include "ara/crypto/cryp/cryobj/secret_seed.h"	
Description:	Set value of this seed object as a "jump" from it's current state to specified number of steps, according to "counting" expression defined by a cryptographic algorithm associated with this object. steps may have positive and negative values that correspond to forward and backward direction of the "jump" respectively, but 0 value means no changes of the current seed value.	

] ([RS_CRYPT_02007](#))

[SWS_CRYPT_23013]{OBSOLETE} [

Kind:	function	
Symbol:	Next()	
Scope:	class ara::crypto::cryp::SecretSeed	
Syntax:	virtual SecretSeed & ara::crypto::cryp::SecretSeed::Next () noexcept=0;	



△

Return value:	SecretSeed &	–
Exception Safety:	noexcept	
Thread Safety:	Thread-safe	
Header file:	#include "ara/crypto/cryp/cryobj/secret_seed.h"	
Description:	Set next value of the secret seed according to "counting" expression defined by a cryptographic algorithm associated with this object. If the associated cryptographic algorithm doesn't specify a "counting" expression then generic increment operation must be implemented as default (little-endian notation, i.e. first byte is least significant). .	

](RS_CRYPT_02007)

[SWS_CRYPT_23015]{DRAFT} [

Kind:	function	
Symbol:	operator^(const SecretSeed &source)	
Scope:	class ara::crypto::cryp::SecretSeed	
Syntax:	virtual SecretSeed& ara::crypto::cryp::SecretSeed::operator^(const SecretSeed &source) noexcept=0;	
Parameters (in):	source	right argument for the XOR operation
Return value:	SecretSeed &	reference to this updated object
Exception Safety:	noexcept	
Thread Safety:	Thread-safe	
Header file:	#include "ara/crypto/cryp/cryobj/secret_seed.h"	
Description:	XOR value of this seed object with another one and save result to this object. If seed sizes in this object and in the source argument are different then only correspondent number of leading bytes in this seed object should be updated.	

](RS_CRYPT_02007)

[SWS_CRYPT_23016]{DRAFT} [

Kind:	function	
Symbol:	operator^(ReadOnlyMemRegion source)	
Scope:	class ara::crypto::cryp::SecretSeed	
Syntax:	virtual SecretSeed& ara::crypto::cryp::SecretSeed::operator^(ReadOnlyMemRegion source) noexcept=0;	
Parameters (in):	source	right argument for the XOR operation
Return value:	SecretSeed &	reference to this updated object
Exception Safety:	noexcept	
Thread Safety:	Thread-safe	
Header file:	#include "ara/crypto/cryp/cryobj/secret_seed.h"	
Description:	XOR value of this seed object with provided memory region and save result to this object. If seed sizes in this object and in the source argument are different then only correspondent number of leading bytes of this seed object should be updated.	

](RS_CRYPT_02007)

[SWS_CRYPT_19906]{DRAFT} [

Kind:	function	
Symbol:	CryptoException(ara::core::ErrorCode err)	
Scope:	class ara::crypto::CryptoException	
Syntax:	explicit ara::crypto::CryptoException::CryptoException (ara::core::ErrorCode err) noexcept;	
Parameters (in):	err	the ErrorCode
Exception Safety:	noexcept	
Header file:	#include "ara/crypto/common/crypto_error_domain.h"	
Description:	Construct a new CryptoException from an ErrorCode.	

]([RS_CRYPT_02310](#))

[SWS_CRYPT_23210]{DRAFT} [

Kind:	function	
Symbol:	GetExtensionService()	
Scope:	class ara::crypto::cryp::SigEncodePrivateCtx	
Syntax:	virtual ExtensionService::Uptr ara::crypto::cryp::SigEncodePrivate Ctx::GetExtensionService () const noexcept=0;	
Return value:	ExtensionService::Uptr	-
Exception Safety:	noexcept	
Header file:	#include "ara/crypto/cryp/sig_encode_private_ctx.h"	
Description:	Extension service member class.	

]([RS_CRYPT_02006](#))

[SWS_CRYPT_23213]{DRAFT} [

Kind:	function	
Symbol:	GetMaxInputSize(bool suppressPadding=false)	
Scope:	class ara::crypto::cryp::SigEncodePrivateCtx	
Syntax:	virtual std::size_t ara::crypto::cryp::SigEncodePrivateCtx::GetMax InputSize (bool suppressPadding=false) const noexcept=0;	
Parameters (in):	suppressPadding	if true then the method calculates the size for the case when the whole space of the plain data block is used for the payload only
Return value:	std::size_t	maximum size of the input data block in bytes
Exception Safety:	noexcept	
Thread Safety:	Thread-safe	
Header file:	#include "ara/crypto/cryp/sig_encode_private_ctx.h"	
Description:	Get maximum expected size of the input data block. If (IsEncryption() == false) then a value returned by this method is independent from the suppressPadding argument and it will be equal to the block size.	

]([RS_CRYPT_02309](#))

[SWS_CRYPT_23214]{DRAFT} [

Kind:	function	
Symbol:	GetMaxOutputSize(bool suppressPadding=false)	
Scope:	class ara::crypto::cryp::SigEncodePrivateCtx	
Syntax:	virtual std::size_t ara::crypto::cryp::SigEncodePrivateCtx::GetMaxOutputSize (bool suppressPadding=false) const noexcept=0;	
Parameters (in):	suppressPadding	if true then the method calculates the size for the case when the whole space of the plain data block is used for the payload only
Return value:	std::size_t	maximum size of the output data block in bytes
Exception Safety:	noexcept	
Thread Safety:	Thread-safe	
Header file:	#include "ara/crypto/cryp/sig_encode_private_ctx.h"	
Description:	Get maximum possible size of the output data block. If (IsEncryption() == true) then a value returned by this method is independent from the suppressPadding argument and will be equal to the block size.	

]([RS_CRYPT_02309](#))

[SWS_CRYPT_23215]{DRAFT} [

Kind:	function	
Symbol:	SignAndEncode(ReadOnlyMemRegion in)	
Scope:	class ara::crypto::cryp::SigEncodePrivateCtx	
Syntax:	virtual ara::core::Result<ara::core::Vector<ara::core::Byte> > ara::crypto::cryp::SigEncodePrivateCtx::SignAndEncode (ReadOnlyMemRegion in) const noexcept=0;	
Parameters (in):	in	the input data block
Return value:	ara::core::Result< ara::core::Vector< ara::core::Byte > >	the output buffer actual size of output data (it always <= out.size()) or 0 if the input data block has incorrect content
Exception Safety:	noexcept	
Thread Safety:	Thread-safe	
Errors:	CryptoErrorDomain::kIncorrectInputSize	if the mentioned above rules about the input size is violated
	CryptoErrorDomain::kUninitializedContext	if the context was not initialized by a key value
Header file:	#include "ara/crypto/cryp/sig_encode_private_ctx.h"	
Description:	Process (encrypt / decrypt) an input block according to the cryptor configuration. Encryption with (suppressPadding == true) expects that: in.size() == GetMaxInputSize(true) && out.size() >= GetMaxOutputSize(true). Encryption with (suppressPadding == false) expects that: in.size() <= GetMaxInputSize(false) && in.size() > 0 && out.size() >= GetMaxOutputSize(false). Decryption expects that: in.size() == GetMaxInputSize() && out.size() >= GetMaxOutputSize(suppressPadding). The case (out.size() < GetMaxOutputSize()) should be used with caution, only if you are strictly certain about the size of the output data! In case of (suppressPadding == true) the actual size of plain text should be equal to full size of the plain data block (defined by the algorithm)!	

]([RS_CRYPT_02202](#))

[SWS_CRYPT_23216]{DRAFT} [

Kind:	function	
Symbol:	SignAndEncode(ReadOnlyMemRegion in)	
Scope:	class ara::crypto::cryp::SigEncodePrivateCtx	
Syntax:	<pre>template <typename Alloc = <implementation-defined>> ara::core::Result<ByteVector<Alloc> > ara::crypto::cryp::SigEncode PrivateCtx::SignAndEncode (ReadOnlyMemRegion in) const noexcept;</pre>	
Template param:	Alloc	a custom allocator type of the output container
Parameters (in):	in	the input data block
Return value:	ara::core::Result< ByteVector< Alloc > >	the managed container for output block
Exception Safety:	noexcept	
Thread Safety:	Thread-safe	
Errors:	CryptoErrorDomain::kIncorrectInput Size	if the mentioned above rules about the input size is violated
	CryptoErrorDomain::kUninitialized Context	if the context was not initialized by a key value
Header file:	#include "ara/crypto/cryp/sig_encode_private_ctx.h"	
Description:	Process (encrypt / decrypt) an input block according to the cryptor configuration. This method sets the size of the output container according to actually saved value! Encryption with (suppressPadding == true) expects what: in.size() == GetMaxInputSize(true) && out.capacity() >= GetMaxOutputSize(true). Encryption with (suppressPadding == false) expects what: in.size() <= GetMaxInputSize(false) && in.size() > 0 && out.capacity() >= GetMaxOutputSize(false). Decryption expects what: in.size() == GetMaxInputSize() && out.capacity() >= GetMaxOutputSize(suppressPadding). The case (out.capacity() < GetMaxOutputSize()) should be used with caution, only if you are strictly certain about the size of the output data! In case of (suppressPadding == true) the actual size of plain text should be equal to full size of the plain data block (defined by the algorithm)!	

] ([RS_CRYPT_02202](#))

[SWS_CRYPT_23212]{DRAFT} [

Kind:	function	
Symbol:	Reset()	
Scope:	class ara::crypto::cryp::SigEncodePrivateCtx	
Syntax:	<pre>virtual ara::core::Result<void> ara::crypto::cryp::SigEncodePrivate Ctx::Reset () noexcept=0;</pre>	
Return value:	ara::core::Result< void >	–
Exception Safety:	noexcept	
Thread Safety:	Thread-safe	
Header file:	#include "ara/crypto/cryp/sig_encode_private_ctx.h"	
Description:	Clear the crypto context.	

] ([RS_CRYPT_02108](#))

[SWS_CRYPT_23211]{DRAFT} [

Kind:	function	
Symbol:	SetKey(const PrivateKey &key)	
Scope:	class ara::crypto::cryp::SigEncodePrivateCtx	





Syntax:	virtual ara::core::Result<void> ara::crypto::cryp::SigEncodePrivate Ctx::SetKey (const PrivateKey &key) noexcept=0;	
Parameters (in):	key	the source key object
Return value:	ara::core::Result< void >	–
Exception Safety:	noexcept	
Thread Safety:	Thread-safe	
Errors:	CryptoErrorDomain::kIncompatible Object	if the provided key object is incompatible with this symmetric key context
	CryptoErrorDomain::kUsageViolation	if the transformation type associated with this context is prohibited by the "allowed usage" restrictions of provided key object
Header file:	#include "ara/crypto/cryp/sig_encode_private_ctx.h"	
Description:	Set (deploy) a key to the sig encode private algorithm context.	

|(RS_CRYPT_02001, RS_CRYPT_02003)

[SWS_CRYPT_23311]{DRAFT} [

Kind:	function	
Symbol:	GetHashAlgId()	
Scope:	class ara::crypto::cryp::Signature	
Syntax:	virtual CryptoPrimitiveId::AlgId ara::crypto::cryp::Signature::GetHash AlgId () const noexcept=0;	
Return value:	CryptoPrimitiveId::AlgId	ID of used hash algorithm only (without signature algorithm specification)
Exception Safety:	noexcept	
Thread Safety:	Thread-safe	
Header file:	#include "ara/crypto/cryp/cryobj/signature.h"	
Description:	Get an ID of hash algorithm used for this signature object production.	

|(RS_CRYPT_02204, RS_CRYPT_02203, RS_CRYPT_02205)

[SWS_CRYPT_23312]{DRAFT} [

Kind:	function	
Symbol:	GetRequiredHashSize()	
Scope:	class ara::crypto::cryp::Signature	
Syntax:	virtual std::size_t ara::crypto::cryp::Signature::GetRequiredHashSize () const noexcept=0;	
Return value:	std::size_t	required hash size in bytes
Exception Safety:	noexcept	
Header file:	#include "ara/crypto/cryp/cryobj/signature.h"	
Description:	Get the hash size required by current signature algorithm.	

|(RS_CRYPT_02309)

[SWS_CRYPT_29003]{DRAFT} [

Kind:	function	
Symbol:	GetRequiredHashAlgId()	
Scope:	class ara::crypto::cryp::SignatureService	
Syntax:	virtual CryptoPrimitiveId::AlgId ara::crypto::cryp::SignatureService::GetRequiredHashAlgId () const noexcept=0;	
Return value:	CryptoPrimitiveId::AlgId	required hash algorithm ID or kAlgIdAny if the signature algorithm specification does not include a concrete hash function
Exception Safety:	noexcept	
Thread Safety:	Thread-safe	
Header file:	#include "ara/crypto/cryp/signature_service.h"	
Description:	Get an ID of hash algorithm required by current signature algorithm.	

]([RS_CRYPT_02309](#))

[SWS_CRYPT_29002]{DRAFT} [

Kind:	function	
Symbol:	GetRequiredHashSize()	
Scope:	class ara::crypto::cryp::SignatureService	
Syntax:	virtual std::size_t ara::crypto::cryp::SignatureService::GetRequiredHashSize () const noexcept=0;	
Return value:	std::size_t	required hash size in bytes
Exception Safety:	noexcept	
Header file:	#include "ara/crypto/cryp/signature_service.h"	
Description:	Get the hash size required by current signature algorithm.	

]([RS_CRYPT_02309](#))

[SWS_CRYPT_29004]{DRAFT} [

Kind:	function	
Symbol:	GetSignatureSize()	
Scope:	class ara::crypto::cryp::SignatureService	
Syntax:	virtual std::size_t ara::crypto::cryp::SignatureService::GetSignatureSize () const noexcept=0;	
Return value:	std::size_t	size of the signature value in bytes
Exception Safety:	noexcept	
Thread Safety:	Thread-safe	
Header file:	#include "ara/crypto/cryp/signature_service.h"	
Description:	Get size of the signature value produced and required by the current algorithm.	

]([RS_CRYPT_02309](#))

[SWS_CRYPT_23510]{DRAFT} [

Kind:	function	
Symbol:	GetSignatureService()	
Scope:	class ara::crypto::cryp::SignerPrivateCtx	
Syntax:	virtual SignatureService::Uptr ara::crypto::cryp::SignerPrivateCtx::GetSignatureService () const noexcept=0;	
Return value:	SignatureService::Uptr	–
Exception Safety:	noexcept	
Header file:	#include "ara/crypto/cryp/signer_private_ctx.h"	
Description:	Get SignatureService instance.	

]([RS_CRYPT_02006](#))

[SWS_CRYPT_23516]{DRAFT} [

Kind:	function	
Symbol:	Reset()	
Scope:	class ara::crypto::cryp::SignerPrivateCtx	
Syntax:	virtual ara::core::Result<void> ara::crypto::cryp::SignerPrivateCtx::Reset () noexcept=0;	
Return value:	ara::core::Result< void >	–
Exception Safety:	noexcept	
Thread Safety:	Thread-safe	
Header file:	#include "ara/crypto/cryp/signer_private_ctx.h"	
Description:	Clear the crypto context.	

]([RS_CRYPT_02108](#))

[SWS_CRYPT_23515]{DRAFT} [

Kind:	function	
Symbol:	SetKey(const PrivateKey &key)	
Scope:	class ara::crypto::cryp::SignerPrivateCtx	
Syntax:	virtual ara::core::Result<void> ara::crypto::cryp::SignerPrivateCtx::SetKey (const PrivateKey &key) noexcept=0;	
Parameters (in):	key	the source key object
Return value:	ara::core::Result< void >	–
Exception Safety:	noexcept	
Thread Safety:	Thread-safe	
Errors:	CryptoErrorDomain::kIncompatibleObject	if the provided key object is incompatible with this symmetric key context
	CryptoErrorDomain::kUsageViolation	if the transformation type associated with this context is prohibited by /// the "allowed usage" restrictions of provided key object
Header file:	#include "ara/crypto/cryp/signer_private_ctx.h"	
Description:	Set (deploy) a key to the signer private algorithm context.	

]([RS_CRYPT_02001](#), [RS_CRYPT_02003](#))

[SWS_CRYPT_23511]{DRAFT} [

Kind:	function	
Symbol:	SignPreHashed(const HashFunctionCtx &hashFn, ReadOnlyMemRegion context=ReadOnlyMemRegion())	
Scope:	class ara::crypto::cryp::SignerPrivateCtx	
Syntax:	virtual ara::core::Result<Signature::Uptrc> ara::crypto::cryp::SignerPrivateCtx::SignPreHashed (const HashFunctionCtx &hashFn, ReadOnlyMemRegion context=ReadOnlyMemRegion()) const noexcept=0;	
Parameters (in):	hashFn	a finalized hash-function context that contains a digest value ready for sign
	context	an optional user supplied "context" (its support depends from concrete algorithm)
Return value:	ara::core::Result< Signature::Uptrc >	unique smart pointer to serialized signature
Exception Safety:	noexcept	
Thread Safety:	Thread-safe	
Errors:	CryptoErrorDomain::kInvalidArgument	if hash-function algorithm does not comply with the signature algorithm specification of this context
	CryptoErrorDomain::kInvalidInputSize	if the user supplied context has incorrect (or unsupported) size
	CryptoErrorDomain::kProcessingNotFinished	if the method hash.Finish() was not called before the call of this method
	CryptoErrorDomain::kUninitializedContext	this context was not initialized by a key value
Header file:	#include "ara/crypto/cryp/signer_private_ctx.h"	
Description:	Sign a provided digest value stored in the hash-function context. This method must put the hash-function algorithm ID and a COUID of the used key-pair to the resulting signature object! The user supplied context may be used for such algorithms as: Ed25519ctx, Ed25519ph, Ed448ph. If the target algorithm doesn't support the context argument then the empty (default) value must be supplied!	

] ([RS_CRYPT_02204](#))

[SWS_CRYPT_23512]{DRAFT} [

Kind:	function	
Symbol:	Sign(ReadOnlyMemRegion value, ReadOnlyMemRegion context=ReadOnlyMemRegion())	
Scope:	class ara::crypto::cryp::SignerPrivateCtx	
Syntax:	virtual ara::core::Result<ara::core::Vector<ara::core::Byte> > ara::crypto::cryp::SignerPrivateCtx::Sign (ReadOnlyMemRegion value, ReadOnlyMemRegion context=ReadOnlyMemRegion()) const noexcept=0;	
Parameters (in):	value	the (pre-)hashed or direct message value that should be signed
	context	an optional user supplied "context" (its support depends from concrete algorithm)
Return value:	ara::core::Result< ara::core::Vector< ara::core::Byte > >	actual size of the signature value stored to the output buffer
Exception Safety:	noexcept	
Thread Safety:	Thread-safe	
Errors:	CryptoErrorDomain::kInvalidInputSize	if size of the input value or context arguments are incorrect / unsupported
	CryptoErrorDomain::kUninitializedContext	if the context was not initialized by a key value
Header file:	#include "ara/crypto/cryp/signer_private_ctx.h"	





Description:	Sign a directly provided hash or message value. This method can be used for implementation of the "multiple passes" signature algorithms that process a message directly, i.e. without "pre-hashing" (like Ed25519ctx). But also this method is suitable for implementation of the traditional signature schemes with pre-hashing (like Ed25519ph, Ed448ph, ECDSA). If the target algorithm doesn't support the context argument then the empty (default) value must be supplied!
---------------------	---

](RS_CRYPT_02204)

[SWS_CRYPT_23513]{DRAFT} [

Kind:	function	
Symbol:	SignPreHashed(AlgId hashAlgId, ReadOnlyMemRegion hashValue, ReadOnlyMemRegion context=ReadOnlyMemRegion())	
Scope:	class ara::crypto::cryp::SignerPrivateCtx	
Syntax:	virtual ara::core::Result<Signature::Uptrc> ara::crypto::cryp::SignerPrivateCtx::SignPreHashed (AlgId hashAlgId, ReadOnlyMemRegion hashValue, ReadOnlyMemRegion context=ReadOnlyMemRegion()) const noexcept=0;	
Parameters (in):	hashAlgId	hash function algorithm ID
	hashValue	hash function value (resulting digest without any truncations)
	context	an optional user supplied "context" (its support depends from concrete algorithm)
Return value:	ara::core::Result< Signature::Uptrc >	unique smart pointer to serialized signature
Exception Safety:	noexcept	
Thread Safety:	Thread-safe	
Errors:	CryptoErrorDomain::kInvalidArgument	if hash-function algorithm does not comply with the signature algorithm specification of this context
	CryptoErrorDomain::kInvalidInputSize	if the user supplied context has incorrect (or unsupported) size
	CryptoErrorDomain::kUninitialized Context	this context was not initialized by a key value
Header file:	#include "ara/crypto/cryp/signer_private_ctx.h"	
Description:	Sign a directly provided digest value and create the Signature object. This method must put the hash-function algorithm ID and a COUID of the used key-pair to the resulting signature object! The user supplied context may be used for such algorithms as: Ed25519ctx, Ed25519ph, Ed448ph. If the target algorithm doesn't support the context argument then the empty (default) value must be supplied!	

](RS_CRYPT_02204)

[SWS_CRYPT_23514]{DRAFT} [

Kind:	function	
Symbol:	Sign(ReadOnlyMemRegion value, ReadOnlyMemRegion context=ReadOnlyMemRegion())	
Scope:	class ara::crypto::cryp::SignerPrivateCtx	
Syntax:	template <typename Alloc = <implementation-defined>> ara::core::Result<ByteVector<Alloc> > ara::crypto::cryp::SignerPrivateCtx::Sign (ReadOnlyMemRegion value, ReadOnlyMemRegion context=ReadOnlyMemRegion()) const noexcept;	
Template param:	Alloc	a custom allocator type of the output container





Parameters (in):	value	the (pre-)hashed or direct message value that should be signed
	context	an optional user supplied "context" (its support depends from concrete algorithm)
Return value:	ara::core::Result< ByteVector< Alloc > >	–
Exception Safety:	noexcept	
Thread Safety:	Thread-safe	
Errors:	CryptoErrorDomain::kInvalidInputSize	if size of the input value or context arguments are incorrect / unsupported
	CryptoErrorDomain::kInsufficientCapacity	if capacity of the output signature container is not enough
	CryptoErrorDomain::kUninitializedContext	if the context was not initialized by a key value
Header file:	#include "ara/crypto/cryp/signer_private_ctx.h"	
Description:	Sign a directly provided hash or message value. This method can be used for implementation of the "multiple passes" signature algorithms that process a message directly, i.e. without "pre-hashing" (like Ed25519ctx). But also this method is suitable for implementation of the traditional signature schemes with pre-hashing (like Ed25519ph, Ed448ph, ECDSA). This method sets the size of the output container according to actually saved value! If the target algorithm doesn't support the context argument then the empty (default) value must be supplied!	

](RS_CRYPT_02204)

[SWS_CRYPT_23620]{DRAFT} [

Kind:	function	
Symbol:	CountBytesInCache()	
Scope:	class ara::crypto::cryp::StreamCipherCtx	
Syntax:	virtual std::size_t ara::crypto::cryp::StreamCipherCtx::CountBytesInCache () const noexcept=0;	
Return value:	std::size_t	number of bytes now kept in the context cache
Exception Safety:	noexcept	
Thread Safety:	Thread-safe	
Header file:	#include "ara/crypto/cryp/stream_cipher_ctx.h"	
Description:	Count number of bytes now kept in the context cache. In block-wise modes if an application has supplied input data chunks with incomplete last block then the context saves the rest part of the last (incomplete) block to internal "cache" memory and wait a next call for additional input to complete this block.	

](RS_CRYPT_02302)

[SWS_CRYPT_23621]{DRAFT} [

Kind:	function	
Symbol:	EstimateMaxInputSize(std::size_t outputCapacity)	
Scope:	class ara::crypto::cryp::StreamCipherCtx	
Syntax:	std::size_t ara::crypto::cryp::StreamCipherCtx::EstimateMaxInputSize (std::size_t outputCapacity) const noexcept;	
Parameters (in):	outputCapacity	capacity of the output buffer
Return value:	std::size_t	maximum number of input bytes





Exception Safety:	noexcept
Thread Safety:	Thread-safe
Header file:	#include "ara/crypto/cryp/stream_cipher_ctx.h"
Description:	Estimate maximal number of input bytes that may be processed for filling of an output buffer without overflow.

](RS_CRYPT_02302)

[SWS_CRYPT_23622]{DRAFT} [

Kind:	function	
Symbol:	EstimateRequiredCapacity(std::size_t inputSize, bool isFinal=false)	
Scope:	class ara::crypto::cryp::StreamCipherCtx	
Syntax:	std::size_t ara::crypto::cryp::StreamCipherCtx::EstimateRequiredCapacity (std::size_t inputSize, bool isFinal=false) const noexcept;	
Parameters (in):	inputSize	size of input data
	isFinal	flag that indicates processing of the last data chunk (if true)
Return value:	std::size_t	required capacity of the output buffer (in bytes)
Exception Safety:	noexcept	
Thread Safety:	Thread-safe	
Header file:	#include "ara/crypto/cryp/stream_cipher_ctx.h"	
Description:	Estimate minimal required capacity of the output buffer, which is enough for saving a result of input data processing.	

](RS_CRYPT_02302)

[SWS_CRYPT_23618]{DRAFT} [

Kind:	function	
Symbol:	FinishBytes(ReadOnlyMemRegion in)	
Scope:	class ara::crypto::cryp::StreamCipherCtx	
Syntax:	virtual ara::core::Result<ara::core::Vector<ara::core::Byte> > ara::crypto::cryp::StreamCipherCtx::FinishBytes (ReadOnlyMemRegion in) noexcept=0;	
Parameters (in):	in	an input data buffer
Return value:	ara::core::Result< ara::core::Vector< ara::core::Byte > >	an output data buffer
Exception Safety:	noexcept	
Thread Safety:	Thread-safe	
Errors:	CryptoErrorDomain::kInsufficientCapacity	if capacity of the output buffer is not enough
	CryptoErrorDomain::kInOutBuffersIntersect	if the input and output buffers intersect
	CryptoErrorDomain::kProcessingNotStarted	if data processing was not started by a call of the Start() method
Header file:	#include "ara/crypto/cryp/stream_cipher_ctx.h"	





Description:	<p>Process the final part of message (that may be not aligned to the block-size boundary). If (IsBytewiseMode() == false) then it must be: $bs = \text{GetBlockSize}(), \text{out.size}() \geq (((\text{in.size}() + bs * ((\text{CryptoTransform}::\text{kEncrypt} == \text{GetTransformation}().\text{Value}()) ? 2 : 1) - 1) / bs) * bs)$ If (IsBytewiseMode() == true) then it must be: $\text{out.size}() \geq \text{in.size}()$ The input and output buffers must not intersect! Usage of this method is mandatory for processing of the last data chunk in block-wise modes! This method may be used for processing of a whole message in a single call (in any mode)! in an input data buffer an output data buffer <code>CryptoErrorDomain::kInsufficientCapacity</code> if capacity of the output buffer is not enough <code>CryptoErrorDomain::kInOutBuffersIntersect</code> if the input and output buffers intersect <code>CryptoErrorDomain::kProcessingNotStarted</code> if data processing was not started by a call of the <code>Start()</code> method</p>
---------------------	---

](RS_CRYPT_02302)

[SWS_CRYPT_23619]{DRAFT} [

Kind:	function	
Symbol:	FinishBytes(ReadOnlyMemRegion in)	
Scope:	class ara::crypto::cryp::StreamCipherCtx	
Syntax:	<pre>template <typename Alloc = <implementation-defined>> ara::core::Result<ByteVector<Alloc> > ara::crypto::cryp::StreamCipherCtx::FinishBytes (ReadOnlyMemRegion in) noexcept;</pre>	
Template param:	Alloc	a custom allocator type of the output container
Parameters (in):	in	an input data buffer The input buffer must not point inside the output container!
Return value:	ara::core::Result< ByteVector< Alloc > >	a managed container for output data
Exception Safety:	noexcept	
Thread Safety:	Thread-safe	
Errors:	CryptoErrorDomain::kInsufficientCapacity	if capacity of the output container is not enough
	CryptoErrorDomain::kInOutBuffersIntersect	if the input and output buffers intersect
	CryptoErrorDomain::kProcessingNotStarted	if data processing was not started by a call of the <code>Start()</code> method
Header file:	#include "ara/crypto/cryp/stream_cipher_ctx.h"	
Description:	<p>Process the final part of message (that may be not aligned to the block-size boundary). This method sets the size of the output container according to actually saved value. If (IsBytewiseMode() == false) then it must be: $bs = \text{GetBlockSize}(), \text{out.capacity}() \geq (((\text{in.size}() + bs * ((\text{CryptoTransform}::\text{kEncrypt} == \text{GetTransformation}().\text{Value}()) ? 2 : 1) - 1) / bs) * bs)$ If (IsBytewiseMode() == true) then it must be: $\text{out.capacity}() \geq \text{in.size}()$ Usage of this method is mandatory for processing of the last data chunk in block-wise modes! This method may be used for processing of a whole message in a single call (in any mode)!</p>	

](RS_CRYPT_02302)

[SWS_CRYPT_23602]{DRAFT} [

Kind:	function	
Symbol:	GetBlockService()	
Scope:	class ara::crypto::cryp::StreamCipherCtx	
Syntax:	<pre>virtual BlockService::Uptr ara::crypto::cryp::StreamCipherCtx::GetBlockService () const noexcept=0;</pre>	
Return value:	BlockService::Uptr	-





Exception Safety:	noexcept
Header file:	#include "ara/crypto/cryp/stream_cipher_ctx.h"
Description:	Get BlockService instance.

]([RS_CRYPT_02006](#))

[SWS_CRYPT_23611]{DRAFT} [

Kind:	function	
Symbol:	IsBytewiseMode()	
Scope:	class ara::crypto::cryp::StreamCipherCtx	
Syntax:	virtual bool ara::crypto::cryp::StreamCipherCtx::IsBytewiseMode () const noexcept=0;	
Return value:	bool	true if the mode can process messages the byte-by-byte (without padding up to the block boundary) and false if only the block-by-block (only full blocks can be processed, the padding is mandatory)
Exception Safety:	noexcept	
Thread Safety:	Thread-safe	
Header file:	#include "ara/crypto/cryp/stream_cipher_ctx.h"	
Description:	Check the operation mode for the bytewise property.	

]([RS_CRYPT_02309](#))

[SWS_CRYPT_23624]{DRAFT} [

Kind:	function	
Symbol:	GetTransformation()	
Scope:	class ara::crypto::cryp::StreamCipherCtx	
Syntax:	virtual ara::core::Result<CryptoTransform> ara::crypto::cryp::StreamCipherCtx::GetTransformation () const noexcept=0;	
Return value:	ara::core::Result< CryptoTransform >	CryptoTransform
Exception Safety:	noexcept	
Thread Safety:	Thread-safe	
Errors:	CryptoErrorDomain::kUninitialized Context	if the transformation direction of this context is configurable during an initialization, but the context was not initialized yet
Header file:	#include "ara/crypto/cryp/stream_cipher_ctx.h"	
Description:	Get the kind of transformation configured for this context: kEncrypt or kDecrypt.	

]([RS_CRYPT_02309](#))

[SWS_CRYPT_23612]{DRAFT} [

Kind:	function	
Symbol:	IsSeekableMode()	
Scope:	class ara::crypto::cryp::StreamCipherCtx	





Syntax:	virtual bool ara::crypto::cryp::StreamCipherCtx::IsSeekableMode () const noexcept=0;	
Return value:	bool	true the seek operation is supported in the current mode and false otherwise
Exception Safety:	noexcept	
Thread Safety:	Thread-safe	
Header file:	#include "ara/crypto/cryp/stream_cipher_ctx.h"	
Description:	Check if the seek operation is supported in the current mode.	

](RS_CRYPT_02309)

[SWS_CRYPT_23614]{DRAFT} [

Kind:	function	
Symbol:	ProcessBlocks(ReadOnlyMemRegion in)	
Scope:	class ara::crypto::cryp::StreamCipherCtx	
Syntax:	virtual ara::core::Result<ara::core::Vector<ara::core::Byte> > ara::crypto::cryp::StreamCipherCtx::ProcessBlocks (ReadOnlyMemRegion in) noexcept=0;	
Parameters (in):	in	an input data buffer
Return value:	ara::core::Result< ara::core::Vector< ara::core::Byte > >	an output data buffer
Exception Safety:	noexcept	
Thread Safety:	Thread-safe	
Errors:	CryptoErrorDomain::kIncompatible Arguments	if sizes of the input and output buffers are not equal
	CryptoErrorDomain::kInvalidInputSize	if size of the input buffer is not divisible by the block size (see GetBlockSize())
	CryptoErrorDomain::kInOutBuffers Intersect	if the input and output buffers partially intersect
	CryptoErrorDomain::kInvalidUsage Order	if this method is called after processing of non-aligned data (to the block-size boundary)
	CryptoErrorDomain::kProcessingNot Started	if the data processing was not started by a call of the Start() method
Header file:	#include "ara/crypto/cryp/stream_cipher_ctx.h"	
Description:	Processe initial parts of message aligned to the block-size boundary. It is a copy-optimized method that doesn't use the internal cache buffer! It can be used only before processing of any non-aligned to the block-size boundary data. Pointers to the input and output buffers must be aligned to the block-size boundary! The input and output buffers may completely coincide, but they must not partially intersect!	

](RS_CRYPT_02302)

[SWS_CRYPT_23615]{DRAFT} [

Kind:	function	
Symbol:	ProcessBlocks(ReadWriteMemRegion inOut)	
Scope:	class ara::crypto::cryp::StreamCipherCtx	
Syntax:	virtual ara::core::Result<void> ara::crypto::cryp::StreamCipher Ctx::ProcessBlocks (ReadWriteMemRegion inOut) noexcept=0;	





Parameters (inout):	inOut	an input and output data buffer, i.e. the whole buffer should be updated
Return value:	ara::core::Result< void >	–
Exception Safety:	noexcept	
Thread Safety:	Thread-safe	
Errors:	CryptoErrorDomain::kInvalidInputSize	if size of the inOut buffer is not divisible by the block size (see GetBlockSize())
	CryptoErrorDomain::kInvalidUsageOrder	if this method is called after processing of non-aligned data (to the block-size boundary)
	CryptoErrorDomain::kProcessingNotStarted	if the data processing was not started by a call of the Start() method
Header file:	#include "ara/crypto/cryp/stream_cipher_ctx.h"	
Description:	Processe initial parts of message aligned to the block-size boundary. It is a copy-optimized method that doesn't use internal cache buffer! It can be used up to first non-block aligned data processing. Pointer to the input-output buffer must be aligned to the block-size boundary!	

](RS_CRYPT_02302)

[SWS_CRYPT_23616]{DRAFT} [

Kind:	function	
Symbol:	ProcessBytes(ReadOnlyMemRegion in)	
Scope:	class ara::crypto::cryp::StreamCipherCtx	
Syntax:	virtual ara::core::Result<ara::core::Vector<ara::core::Byte> > ara::crypto::cryp::StreamCipherCtx::ProcessBytes (ReadOnlyMemRegion in) noexcept=0;	
Parameters (in):	in	an input data buffer
Return value:	ara::core::Result< ara::core::Vector< ara::core::Byte > >	an output data buffer
Exception Safety:	noexcept	
Thread Safety:	Thread-safe	
Errors:	CryptoErrorDomain::kInsufficientCapacity	if the output buffer has capacity insufficient for placing of the transformation result
	CryptoErrorDomain::kInOutBuffersIntersect	if the input and output buffers intersect
	CryptoErrorDomain::kProcessingNotStarted	if data processing was not started by a call of the Start() method
Header file:	#include "ara/crypto/cryp/stream_cipher_ctx.h"	
Description:	Processe a non-final part of message (that is not aligned to the block-size boundary). If (IsBytewiseMode() == false) then it must be: bs = GetBlockSize(), out.size() >= (((in.size() + bs - 1) / bs) * bs) If (IsBytewiseMode() == true) then it must be: out.size() >= in.size() The input and output buffers must not intersect! This method is "copy inefficient", therefore it should be used only in conditions when an application cannot control the chunking of the original message!	

](RS_CRYPT_02302)

[SWS_CRYPT_23617]{DRAFT} [

Kind:	function	
Symbol:	ProcessBytes(ReadOnlyMemRegion in)	
Scope:	class ara::crypto::cryp::StreamCipherCtx	





Syntax:	<pre>template <typename Alloc = <implementation-defined>> ara::core::Result<ByteVector<Alloc> > ara::crypto::cryp::StreamCipher Ctx::ProcessBytes (ReadOnlyMemRegion in) noexcept;</pre>	
Template param:	Alloc	a custom allocator type of the output container
Parameters (in):	in	an input data buffer
Return value:	ara::core::Result< ByteVector< Alloc > >	a managed container for the output data
Exception Safety:	noexcept	
Thread Safety:	Thread-safe	
Errors:	CryptoErrorDomain::kInsufficient Capacity	if capacity of the output container is not enough
	CryptoErrorDomain::kInOutBuffers Intersect	if the input buffer points inside of the preallocated output container
	:	CryptoErrorDomain::kProcessingNotStarted if data processing was not started by a call of the Start() method
Header file:	#include "ara/crypto/cryp/stream_cipher_ctx.h"	
Description:	Processes a non-final part of message (that is not aligned to the block-size boundary). This method sets size of the output container according to actually saved value. If (IsBytewiseMode() == false) then it must be: $bs = \text{GetBlockSize}(), \text{out.capacity}() \geq (((\text{in.size}() + bs - 1) / bs) * bs)$ If (IsBytewiseMode() == true) then it must be: $\text{out.capacity}() \geq \text{in.size}()$ This method is "copy inefficient", therefore it should be used only in conditions when an application cannot control the chunking of the original message! The input buffer must not point inside the output container!	

](RS_CRYPT_02302)

[SWS_CRYPT_23627]{DRAFT} [

Kind:	function	
Symbol:	Reset()	
Scope:	class ara::crypto::cryp::StreamCipherCtx	
Syntax:	<pre>virtual ara::core::Result<void> ara::crypto::cryp::StreamCipher Ctx::Reset () noexcept=0;</pre>	
Return value:	ara::core::Result< void >	–
Exception Safety:	noexcept	
Thread Safety:	Thread-safe	
Header file:	#include "ara/crypto/cryp/stream_cipher_ctx.h"	
Description:	Clear the crypto context.	

](RS_CRYPT_02108)

[SWS_CRYPT_23613]{DRAFT} [

Kind:	function	
Symbol:	Seek(std::int64_t offset, bool fromBegin=true)	
Scope:	class ara::crypto::cryp::StreamCipherCtx	
Syntax:	<pre>virtual ara::core::Result<void> ara::crypto::cryp::StreamCipher Ctx::Seek (std::int64_t offset, bool fromBegin=true) noexcept=0;</pre>	
Parameters (in):	offset	the offset value in bytes, relative to begin or current position in the gamma stream
	fromBegin	the starting point for positioning within the stream: from begin (if true) or from current position (if false)





Return value:	ara::core::Result< void >	–
Exception Safety:	noexcept	
Thread Safety:	Thread-safe	
Errors:	CryptoErrorDomain::kUnsupported	if the seek operation is not supported by the current mode
	CryptoErrorDomain::kProcessingNot Started	if the data processing was not started by a call of the Start() method
	CryptoErrorDomain::kBelowBoundary	if the offset value is incorrect (in context of the fromBegin argument), i.e. it points before begin of the stream (note: it is an optional error condition)
	CryptoErrorDomain::kInvalidArgument	if the offset is not aligned to the required boundary (see IsBytewiseMode())
Header file:	#include "ara/crypto/cryp/stream_cipher_ctx.h"	
Description:	Set the position of the next byte within the stream of the encryption/decryption gamma.	

]([RS_CRYPT_02304](#))

[SWS_CRYPT_23623]{DRAFT} [

Kind:	function	
Symbol:	SetKey(const SymmetricKey &key, CryptoTransform transform=CryptoTransform::kEncrypt)	
Scope:	class ara::crypto::cryp::StreamCipherCtx	
Syntax:	virtual ara::core::Result<void> ara::crypto::cryp::StreamCipherCtx::SetKey (const SymmetricKey &key, CryptoTransform transform=CryptoTransform::kEncrypt) noexcept=0;	
Parameters (in):	key	the source key object
	transform	the "direction" indicator: deploy the key for direct transformation (if true) or for reverse one (if false)
Return value:	ara::core::Result< void >	–
Exception Safety:	noexcept	
Thread Safety:	Thread-safe	
Errors:	CryptoErrorDomain::kIncompatible Object	if the provided key object is incompatible with this symmetric key context
	CryptoErrorDomain::kUsageViolation	if the transformation type associated with this context (taking into account the direction specified by transform) is prohibited by the "allowed usage" restrictions of provided key object
Header file:	#include "ara/crypto/cryp/stream_cipher_ctx.h"	
Description:	Set (deploy) a key to the stream cipher algorithm context.	

]([RS_CRYPT_02001](#), [RS_CRYPT_02003](#))

[SWS_CRYPT_23625]{DRAFT} [

Kind:	function	
Symbol:	Start(ReadOnlyMemRegion iv=ReadOnlyMemRegion())	
Scope:	class ara::crypto::cryp::StreamCipherCtx	
Syntax:	virtual ara::core::Result<void> ara::crypto::cryp::StreamCipherCtx::Start (ReadOnlyMemRegion iv=ReadOnlyMemRegion()) noexcept=0;	
Parameters (in):	iv	an optional Initialization Vector (IV) or "nonce" value





Return value:	ara::core::Result< void >	–
Exception Safety:	noexcept	
Thread Safety:	Thread-safe	
Errors:	CryptoErrorDomain::kUninitialized Context	if the context was not initialized by deploying a key
	CryptoErrorDomain::kInvalidInputSize	if the size of provided IV is not supported (i.e. if it is not enough for the initialization)
	CryptoErrorDomain::kUnsupported	if the base algorithm (or its current implementation) principally doesn't support the IV variation, but provided IV value is not empty, i.e. if (iv.empty() == false)
Header file:	#include "ara/crypto/cryp/stream_cipher_ctx.h"	
Description:	Initialize the context for a new data stream processing or generation (depending from the primitive). If IV size is greater than maximally supported by the algorithm then an implementation may use the leading bytes only from the sequence.	

]([RS_CRYPT_02302](#))

[SWS_CRYPT_23626]{DRAFT} [

Kind:	function	
Symbol:	Start(const SecretSeed &iv)	
Scope:	class ara::crypto::cryp::StreamCipherCtx	
Syntax:	virtual ara::core::Result<void> ara::crypto::cryp::StreamCipherCtx::Start (const SecretSeed &iv) noexcept=0;	
Parameters (in):	iv	the Initialization Vector (IV) or "nonce" object
Return value:	ara::core::Result< void >	–
Exception Safety:	noexcept	
Thread Safety:	Thread-safe	
Errors:	CryptoErrorDomain::kUninitialized Context	if the context was not initialized by deploying a key
	CryptoErrorDomain::kInvalidInputSize	if the size of provided IV is not supported (i.e. if it is not enough for the initialization)
	CryptoErrorDomain::kUnsupported	if the base algorithm (or its current implementation) principally doesn't support the IV variation
	CryptoErrorDomain::kUsageViolation	if this transformation type is prohibited by the "allowed usage" restrictions of the provided Secret Seed object
Header file:	#include "ara/crypto/cryp/stream_cipher_ctx.h"	
Description:	Initialize the context for a new data stream processing or generation (depending from the primitive). If IV size is greater than maximally supported by the algorithm then an implementation may use the leading bytes only from the sequence.	

]([RS_CRYPT_02302](#))

[SWS_CRYPT_23702]{DRAFT} [

Kind:	function	
Symbol:	GetCryptoService()	
Scope:	class ara::crypto::cryp::SymmetricBlockCipherCtx	
Syntax:	virtual CryptoService::Uptr ara::crypto::cryp::SymmetricBlockCipherCtx::GetCryptoService () const noexcept=0;	



△

Return value:	CryptoService::Uptr	–
Exception Safety:	noexcept	
Header file:	#include "ara/crypto/cryp/symmetric_block_cipher_ctx.h"	
Description:	Get CryptoService instance.	

] ([RS_CRYPT_02006](#))

[SWS_CRYPT_23711]{DRAFT} [

Kind:	function	
Symbol:	GetTransformation()	
Scope:	class ara::crypto::cryp::SymmetricBlockCipherCtx	
Syntax:	virtual ara::core::Result<CryptoTransform> ara::crypto::cryp::SymmetricBlockCipherCtx::GetTransformation () const noexcept=0;	
Return value:	ara::core::Result< CryptoTransform >	CryptoTransform
Exception Safety:	noexcept	
Thread Safety:	Thread-safe	
Errors:	CryptoErrorDomain::kUninitialized Context,	if SetKey() has not been called yet.
Header file:	#include "ara/crypto/cryp/symmetric_block_cipher_ctx.h"	
Description:	Get the kind of transformation configured for this context: kEncrypt or kDecrypt.	

] ([RS_CRYPT_02309](#))

[SWS_CRYPT_23716]{DRAFT} [

Kind:	function	
Symbol:	ProcessBlock(ReadOnlyMemRegion in, bool suppressPadding=false)	
Scope:	class ara::crypto::cryp::SymmetricBlockCipherCtx	
Syntax:	virtual ara::core::Result<ara::core::Vector<ara::core::Byte> > ara::crypto::cryp::SymmetricBlockCipherCtx::ProcessBlock (ReadOnlyMem Region in, bool suppressPadding=false) const noexcept=0;	
Parameters (in):	in	the input data block
	suppressPadding	if true then this method doesn't apply padding, hence the input buffer be of the same size as the block-size, i.e. either the data to be processed exactly fits the block-size or the user must apply padding to the same effect.
Return value:	ara::core::Result< ara::core::Vector< ara::core::Byte > >	the output buffer containing the transformation result
Exception Safety:	noexcept	
Thread Safety:	Thread-safe	
Errors:	:	CryptoErrorDomain::kInvalidInputSize if the boolean parameter \ARApiRef{suppressPadding} was set to TRUE and the provided input buffer does not match the block-size.
	CryptoErrorDomain::kUninitialized Context	if the context was not initialized by calling SetKey()
Header file:	#include "ara/crypto/cryp/symmetric_block_cipher_ctx.h"	
Description:	Process (encrypt / decrypt) an input block according to the configuration.	

] ([RS_CRYPT_02201](#))

[SWS_CRYPT_23717]{DRAFT} [

Kind:	function	
Symbol:	ProcessBlock(ReadOnlyMemRegion in, bool suppressPadding=false)	
Scope:	class ara::crypto::cryp::SymmetricBlockCipherCtx	
Syntax:	<pre>template <typename Alloc = <implementation-defined>> ara::core::Result<ByteVector<Alloc> > ara::crypto::cryp::Symmetric BlockCipherCtx::ProcessBlock (ReadOnlyMemRegion in, bool suppress Padding=false) const noexcept;</pre>	
Template param:	Alloc	a custom allocator type of the output container
Parameters (in):	in	the input data block
	suppressPadding	if true then the method doesn't apply the padding, but the payload should fill the whole block of the plain data
Return value:	ara::core::Result< ByteVector< Alloc > >	the managed container for output block
Exception Safety:	noexcept	
Thread Safety:	Thread-safe	
Errors:	CryptoErrorDomain::kIncorrectInput Size	if the mentioned above rules about the input size is violated
	CryptoErrorDomain::kInsufficient Capacity	if the out.size() is not enough to store the transformation result
	CryptoErrorDomain::kUninitialized Context	if the context was not initialized by a key value
Header file:	#include "ara/crypto/cryp/symmetric_block_cipher_ctx.h"	
Description:	Process (encrypt / decrypt) an input block according to the configuration.	

] ([RS_CRYPTO_02201](#))

[SWS_CRYPT_23715]{DRAFT} [

Kind:	function	
Symbol:	ProcessBlocks(ReadOnlyMemRegion in)	
Scope:	class ara::crypto::cryp::SymmetricBlockCipherCtx	
Syntax:	<pre>virtual ara::core::Result<ara::core::Vector<ara::core::Byte> > ara::crypto::cryp::SymmetricBlockCipherCtx::ProcessBlocks (ReadOnlyMem Region in) const noexcept=0;</pre>	
Parameters (in):	in	an input data buffer
Return value:	ara::core::Result< ara::core::Vector< ara::core::Byte > >	an output data buffer
Exception Safety:	noexcept	
Thread Safety:	Thread-safe	
Errors:	CryptoErrorDomain::kUninitialized Context	if the context was not initialized by a key value
	CryptoErrorDomain::kInvalidInputSize	if size of the input buffer is not divisible by the block size (see GetBlockSize())
Header file:	#include "ara/crypto/cryp/symmetric_block_cipher_ctx.h"	
Description:	Process (encrypt / decrypt) an input block according to the configuration. The in must have a size that is divisible by the block size (see GetBlockSize()). The pointer to the input buffer must be aligned to the block-size boundary!	

] ([RS_CRYPTO_02302](#))

[SWS_CRYPT_23712]{DRAFT} [

Kind:	function	
Symbol:	Reset()	
Scope:	class ara::crypto::cryp::SymmetricBlockCipherCtx	
Syntax:	virtual ara::core::Result<void> ara::crypto::cryp::SymmetricBlockCipherCtx::Reset () noexcept=0;	
Return value:	ara::core::Result< void >	true if the transformation requires the maximum size of input data and false otherwise
Exception Safety:	noexcept	
Thread Safety:	Thread-safe	
Errors:	CryptoErrorDomain::kUninitialized Context	if the transformation direction of this context is configurable during an initialization, but the context was not initialized yet
Header file:	#include "ara/crypto/cryp/symmetric_block_cipher_ctx.h"	
Description:	Indicate that the currently configured transformation accepts only complete blocks of input data. Clear the crypto context.	

] ([RS_CRYPT_02309](#), [RS_CRYPT_02108](#))

[SWS_CRYPT_23710]{DRAFT} [

Kind:	function	
Symbol:	SetKey(const SymmetricKey &key, CryptoTransform transform=CryptoTransform::kEncrypt)	
Scope:	class ara::crypto::cryp::SymmetricBlockCipherCtx	
Syntax:	virtual ara::core::Result<void> ara::crypto::cryp::SymmetricBlockCipherCtx::SetKey (const SymmetricKey &key, CryptoTransform transform=CryptoTransform::kEncrypt) noexcept=0;	
Parameters (in):	key	the source key object
	transform	the "direction" indicator: deploy the key for direct transformation (if true) or for reverse one (if false)
Return value:	ara::core::Result< void >	–
Exception Safety:	noexcept	
Thread Safety:	Thread-safe	
Errors:	CryptoErrorDomain::kIncompatible Object	if the provided key object belongs to a different CryptoProvider instance
	CryptoErrorDomain::kUsageViolation	if the transformation type associated with this context (taking into account the direction specified by transform) is prohibited by the "allowed usage" restrictions of provided key object
Header file:	#include "ara/crypto/cryp/symmetric_block_cipher_ctx.h"	
Description:	Set (deploy) a key to the symmetric algorithm context.	

] ([RS_CRYPT_02001](#), [RS_CRYPT_02003](#))

[SWS_CRYPT_24013]{DRAFT} [

Kind:	function	
Symbol:	CalculateWrappedKeySize(std::size_t keyLength)	
Scope:	class ara::crypto::cryp::SymmetricKeyWrapperCtx	
Syntax:	virtual std::size_t ara::crypto::cryp::SymmetricKeyWrapperCtx::CalculateWrappedKeySize (std::size_t keyLength) const noexcept=0;	





Parameters (in):	keyLength	original key length in bits
Return value:	std::size_t	size of the wrapped key in bytes
Exception Safety:	noexcept	
Thread Safety:	Thread-safe	
Header file:	#include "ara/crypto/cryp/symmetric_key_wrapper_ctx.h"	
Description:	Calculate size of the wrapped key in bytes from original key length in bits. This method can be useful for some implementations different from RFC3394 / RFC5649.	

]([RS_CRYPT_02201](#))

[SWS_CRYPT_24002]{DRAFT} [

Kind:	function	
Symbol:	GetExtensionService()	
Scope:	class ara::crypto::cryp::SymmetricKeyWrapperCtx	
Syntax:	virtual ExtensionService::Uptr ara::crypto::cryp::SymmetricKeyWrapperCtx::GetExtensionService () const noexcept=0;	
Return value:	ExtensionService::Uptr	–
Exception Safety:	noexcept	
Header file:	#include "ara/crypto/cryp/symmetric_key_wrapper_ctx.h"	
Description:	Get ExtensionService instance.	

]([RS_CRYPT_02006](#))

[SWS_CRYPT_24012]{DRAFT} [

Kind:	function	
Symbol:	GetMaxTargetKeyLength()	
Scope:	class ara::crypto::cryp::SymmetricKeyWrapperCtx	
Syntax:	virtual std::size_t ara::crypto::cryp::SymmetricKeyWrapperCtx::GetMaxTargetKeyLength () const noexcept=0;	
Return value:	std::size_t	maximum length of the target key in bits
Exception Safety:	noexcept	
Thread Safety:	Thread-safe	
Header file:	#include "ara/crypto/cryp/symmetric_key_wrapper_ctx.h"	
Description:	Get maximum length of the target key supported by the implementation. This method can be useful for some implementations different from RFC3394 / RFC5649.	

]([RS_CRYPT_02201](#))

[SWS_CRYPT_24011]{DRAFT} [

Kind:	function	
Symbol:	GetTargetKeyGranularity()	
Scope:	class ara::crypto::cryp::SymmetricKeyWrapperCtx	
Syntax:	virtual std::size_t ara::crypto::cryp::SymmetricKeyWrapperCtx::GetTargetKeyGranularity () const noexcept=0;	
Return value:	std::size_t	size of the block in bytes
Exception Safety:	noexcept	





Thread Safety:	Thread-safe
Header file:	#include "ara/crypto/cryp/symmetric_key_wrapper_ctx.h"
Description:	Get expected granularity of the target key (block size). If the class implements RFC3394 (KW without padding) then this method should return 8 (i.e. 8 octets = 64 bits). If the class implements RFC5649 (KW with padding) then this method should return 1 (i.e. 1 octet = 8 bits).

]([RS_CRYPT_02201](#))

[SWS_CRYPT_24019]{DRAFT} [

Kind:	function
Symbol:	Reset()
Scope:	class ara::crypto::cryp::SymmetricKeyWrapperCtx
Syntax:	virtual ara::core::Result<void> ara::crypto::cryp::SymmetricKeyWrapperCtx::Reset () noexcept=0;
Return value:	ara::core::Result< void > –
Exception Safety:	noexcept
Thread Safety:	Thread-safe
Header file:	#include "ara/crypto/cryp/symmetric_key_wrapper_ctx.h"
Description:	Clear the crypto context.

]([RS_CRYPT_02108](#))

[SWS_CRYPT_24018]{DRAFT} [

Kind:	function
Symbol:	SetKey(const SymmetricKey &key, CryptoTransform transform)
Scope:	class ara::crypto::cryp::SymmetricKeyWrapperCtx
Syntax:	virtual ara::core::Result<void> ara::crypto::cryp::SymmetricKeyWrapperCtx::SetKey (const SymmetricKey &key, CryptoTransform transform) noexcept=0;
Parameters (in):	key the source key object
	transform the "direction" indicator: deploy the key for direct transformation (if true) or for reverse one (if false)
Return value:	ara::core::Result< void > –
Exception Safety:	noexcept
Thread Safety:	Thread-safe
Errors:	CryptoErrorDomain::kIncompatible Object if the provided key object is incompatible with this symmetric key context
	CryptoErrorDomain::kUsageViolation if the transformation type associated with this context (taking into account the direction specified by transform) is prohibited by the "allowed usage" restrictions of provided key object
Header file:	#include "ara/crypto/cryp/symmetric_key_wrapper_ctx.h"
Description:	Set (deploy) a key to the symmetric key wrapper algorithm context.

]([RS_CRYPT_02001](#), [RS_CRYPT_02003](#))

[SWS_CRYPT_24017]{DRAFT} [

Kind:	function	
Symbol:	UnwrapConcreteKey(ReadOnlyMemRegion wrappedKey, AlgId algId, AllowedUsageFlags allowedUsage)	
Scope:	class ara::crypto::cryp::SymmetricKeyWrapperCtx	
Syntax:	<pre>template <typename ExpectedKey> ara::core::Result<typename ExpectedKey::Uptrc> ara::crypto::cryp::SymmetricKeyWrapperCtx::UnwrapConcreteKey (ReadOnlyMemRegion wrappedKey, AlgId algId, AllowedUsageFlags allowedUsage) noexcept;</pre>	
Template param:	ExpectedKey	the expected type of concrete key
Parameters (in):	wrappedKey	a memory region that contains wrapped key
	algId	an identifier of the target symmetric crypto algorithm
	allowedUsage	bit-flags that define a list of allowed transformations' types in which the target key can be used
Return value:	ara::core::Result< typename ExpectedKey::Uptrc >	unique smart pointer to ExpectedKey object, which keeps unwrapped key material
Exception Safety:	noexcept	
Errors:	CryptoErrorDomain::kInvalidInputSize	if the size of provided wrapped key is unsupported
	CryptoErrorDomain::kUninitialized Context	if the context was not initialized by a key value
Header file:	#include "ara/crypto/cryp/symmetric_key_wrapper_ctx.h"	
Description:	Execute the "key unwrap" operation for provided BLOB and produce a Key object of expected type. For additional details see UnwrapKey()	

] ([RS_CRYPT_02115](#))

[SWS_CRYPT_24016]{DRAFT} [

Kind:	function	
Symbol:	UnwrapKey(ReadOnlyMemRegion wrappedKey, AlgId algId, AllowedUsageFlags allowed Usage)	
Scope:	class ara::crypto::cryp::SymmetricKeyWrapperCtx	
Syntax:	<pre>virtual ara::core::Result<RestrictedUseObject::Uptrc> ara::crypto::cryp::SymmetricKeyWrapperCtx::UnwrapKey (ReadOnlyMemRegion wrappedKey, AlgId algId, AllowedUsageFlags allowedUsage) const noexcept=0;</pre>	
Parameters (in):	wrappedKey	a memory region that contains wrapped key
	algId	an identifier of the target symmetric crypto algorithm
	allowedUsage	bit-flags that define a list of allowed transformations' types in which the target key can be used
Return value:	ara::core::Result< RestrictedUse Object::Uptrc >	unique smart pointer to Key object, which keeps unwrapped key material
Exception Safety:	noexcept	
Thread Safety:	Thread-safe	
Errors:	CryptoErrorDomain::kInvalidInputSize	if the size of provided wrapped key is unsupported
	CryptoErrorDomain::kUninitialized Context	if the context was not initialized by a key value
Header file:	#include "ara/crypto/cryp/symmetric_key_wrapper_ctx.h"	





Description:	Execute the "key unwrap" operation for provided BLOB and produce Key object. This method should be compliant to RFC3394 or RFC5649, if implementation is based on the AES block cipher and applied to an AES key. The created Key object has following attributes: session and non-exportable (because it was imported without meta-information)! SymmetricKey may be unwrapped in following way: SymmetricKey::Uptrc key = SymmetricKey::Cast(UnwrapKey(wrappedKey, ...)); PrivateKey may be unwrapped in following way: PrivateKey::Uptrc key = PrivateKey::Cast(UnwrapKey(wrappedKey, ...)); In both examples the Cast() method may additionally throw the BadObjectTypeException if an actual type of the unwrapped key differs from the target one!
---------------------	--

](RS_CRYPTO_02115)

[SWS_CRYPT_24015]{DRAFT} [

Kind:	function	
Symbol:	UnwrapSeed(ReadOnlyMemRegion wrappedSeed, AlgId targetAlgId, SecretSeed::Usage allowedUsage)	
Scope:	class ara::crypto::cryp::SymmetricKeyWrapperCtx	
Syntax:	<pre>virtual ara::core::Result<SecretSeed::Uptrc> ara::crypto::cryp::SymmetricKeyWrapperCtx::UnwrapSeed (ReadOnlyMemRegion wrappedSeed, AlgId targetAlgId, SecretSeed::Usage allowedUsage) const noexcept=0;</pre>	
Parameters (in):	wrappedSeed	a memory region that contains wrapped seed
	targetAlgId	the target symmetric algorithm identifier (also defines a target seed-length)
	allowedUsage	allowed usage scope of the target seed
Return value:	ara::core::Result< SecretSeed::Uptrc >	unique smart pointer to SecretSeed object, which keeps unwrapped key material
Exception Safety:	noexcept	
Thread Safety:	Thread-safe	
Errors:	CryptoErrorDomain::kInvalidInputSize	if the size of provided wrapped seed is unsupported
	CryptoErrorDomain::kUninitialized Context	if the context was not initialized by a key value
Header file:	#include "ara/crypto/cryp/symmetric_key_wrapper_ctx.h"	
Description:	Execute the "key unwrap" operation for provided BLOB and produce SecretSeed object. This method should be compliant to RFC3394 or RFC5649, if implementation is based on the AES block cipher and applied to an AES key material. The created SecretSeed object has following attributes: session and non-exportable (because it was imported without meta-information).	

](RS_CRYPTO_02007)

[SWS_CRYPT_24014]{DRAFT} [

Kind:	function	
Symbol:	WrapKeyMaterial(const RestrictedUseObject &key)	
Scope:	class ara::crypto::cryp::SymmetricKeyWrapperCtx	
Syntax:	<pre>virtual ara::core::Result<ara::core::Vector<ara::core::Byte> > ara::crypto::cryp::SymmetricKeyWrapperCtx::WrapKeyMaterial (const RestrictedUseObject &key) const noexcept=0;</pre>	
Parameters (in):	key	a key that should be wrapped
Return value:	ara::core::Result< ara::core::Vector< ara::core::Byte > >	-
Exception Safety:	noexcept	





Thread Safety:	Thread-safe	
Errors:	CryptoErrorDomain::kInsufficientCapacity	if the size of the wrapped buffer is not enough for storing the result
	CryptoErrorDomain::kInvalidInputSize	if the key object has an unsupported length
	CryptoErrorDomain::kUninitializedContext	if the context was not initialized by a key value
Header file:	#include "ara/crypto/cryp/symmetric_key_wrapper_ctx.h"	
Description:	Execute the "key wrap" operation for the provided key material. This method should be compliant to RFC3394 or RFC5649, if an implementation is based on the AES block cipher and applied to an AES key. Method CalculateWrappedKeySize() can be used for size calculation of the required output buffer.	

]([RS_CRYPT_02201](#))

[SWS_CRYPT_24102]{DRAFT} [

Kind:	function	
Symbol:	GetSignatureService()	
Scope:	class ara::crypto::cryp::VerifierPublicCtx	
Syntax:	virtual SignatureService::Uptr ara::crypto::cryp::VerifierPublicCtx::GetSignatureService () const noexcept=0;	
Return value:	SignatureService::Uptr	–
Exception Safety:	noexcept	
Header file:	#include "ara/crypto/cryp/verifier_public_ctx.h"	
Description:	Extension service member class.	

]([RS_CRYPT_02006](#))

[SWS_CRYPT_24116]{DRAFT} [

Kind:	function	
Symbol:	Reset()	
Scope:	class ara::crypto::cryp::VerifierPublicCtx	
Syntax:	virtual ara::core::Result<void> ara::crypto::cryp::VerifierPublicCtx::Reset () noexcept=0;	
Return value:	ara::core::Result< void >	–
Exception Safety:	noexcept	
Thread Safety:	Thread-safe	
Header file:	#include "ara/crypto/cryp/verifier_public_ctx.h"	
Description:	Clear the crypto context.	

]([RS_CRYPT_02108](#))

[SWS_CRYPT_24115]{DRAFT} [

Kind:	function	
Symbol:	SetKey(const PublicKey &key)	
Scope:	class ara::crypto::cryp::VerifierPublicCtx	
Syntax:	virtual ara::core::Result<void> ara::crypto::cryp::VerifierPublicCtx::SetKey (const PublicKey &key) noexcept=0;	



△

Parameters (in):	key	the source key object
Return value:	ara::core::Result< void >	–
Exception Safety:	noexcept	
Thread Safety:	Thread-safe	
Errors:	CryptoErrc::kIncompatibleObject	if the provided key object is incompatible with this symmetric key context
	CryptoErrc::kUsageViolation	if the transformation type associated with this context is prohibited by the "allowed usage" restrictions of provided key object
Header file:	#include "ara/crypto/cryp/verifier_public_ctx.h"	
Description:	Set (deploy) a key to the verifier public algorithm context.	

 | ([RS_CRYPT_02001](#), [RS_CRYPT_02003](#))

[SWS_CRYPT_24111]{DRAFT} [

Kind:	function	
Symbol:	VerifyPrehashed(CryptoAlgId hashAlgId, ReadOnlyMemRegion hashValue, const Signature &signature, ReadOnlyMemRegion context=ReadOnlyMemRegion())	
Scope:	class ara::crypto::cryp::VerifierPublicCtx	
Syntax:	virtual ara::core::Result<bool> ara::crypto::cryp::VerifierPublicCtx::VerifyPrehashed (CryptoAlgId hashAlgId, ReadOnlyMemRegion hashValue, const Signature &signature, ReadOnlyMemRegion context=ReadOnlyMemRegion()) const noexcept=0;	
Parameters (in):	hashAlgId	hash function algorithm ID
	hashValue	hash function value (resulting digest without any truncations)
	signature	the signature object for verification
	context	an optional user supplied "context" (its support depends from concrete algorithm)
Return value:	ara::core::Result< bool >	true if the signature was verified successfully and false otherwise
Exception Safety:	noexcept	
Thread Safety:	Thread-safe	
Errors:	CryptoErrc::kProcessingNotFinished	if the method hashFn.Finish() was not called before this method call
	CryptoErrc::kInvalidArgument	if the CryptoAlgId of hashFn differs from the CryptoAlgId of this context
	CryptoErrc::kInvalidInputSize	if the size of the supplied context is incompatible with the configured signature algorithm.
Header file:	#include "ara/crypto/cryp/verifier_public_ctx.h"	
Description:	Verify signature by a digest value stored in the hash-function context. This is a pass-through interface to SWS_CRYPT_24113 for developer convenience, i.e. it adds additional input checks and then calls the verify() interface from SWS_CRYPT_24113.	

 | ([RS_CRYPT_02204](#))

[SWS_CRYPT_24112]{DRAFT} [

Kind:	function	
Symbol:	Verify(ReadOnlyMemRegion value, ReadOnlyMemRegion signature, ReadOnlyMemRegion context=ReadOnlyMemRegion())	
Scope:	class ara::crypto::cryp::VerifierPublicCtx	
Syntax:	virtual ara::core::Result<bool> ara::crypto::cryp::VerifierPublicCtx::Verify (ReadOnlyMemRegion value, ReadOnlyMemRegion signature, ReadOnlyMemRegion context=ReadOnlyMemRegion()) const noexcept=0;	
Parameters (in):	value	the (pre-)hashed or direct message value that should be verified
	signature	the signature BLOB for the verification (the BLOB contains a plain sequence of the digital signature components located in fixed/maximum length fields defined by the algorithm specification, and each component is presented by a raw bytes sequence padded by zeroes to full length of the field; e.g. in case of (EC)DSA-256 (i.e. length of the q module is 256 bits) the signature BLOB must have two fixed-size fields: 32 + 32 bytes, for R and S components respectively, i.e. total BLOB size is 64 bytes)
	context	an optional user supplied "context" (its support depends from concrete algorithm)
Return value:	ara::core::Result< bool >	true if the signature was verified successfully and false otherwise
Exception Safety:	noexcept	
Thread Safety:	Thread-safe	
Errors:	CryptoErrc::kUninitializedContext	if the context was not initialized by a key value
	CryptoErrc::kInvalidInputSize	if the context argument has unsupported size
Header file:	#include "ara/crypto/cryp/verifier_public_ctx.h"	
Description:	Verify signature BLOB by a directly provided hash or message value. This method can be used for implementation of the "multiple passes" signature algorithms that process a message directly, i.e. without "pre-hashing" (like Ed25519ctx). But also this method is suitable for implementation of the traditional signature schemes with pre-hashing (like Ed25519ph, Ed448ph, ECDSA). If the target algorithm doesn't support the context argument then the empty (default) value must be supplied! The user supplied context may be used for such algorithms as: Ed25519ctx, Ed25519ph, Ed448ph.	

] ([RS_CRYPT_02204](#))

[SWS_CRYPT_24113]{DRAFT} [

Kind:	function	
Symbol:	VerifyPrehashed(const HashFunctionCtx &hashFn, const Signature &signature, ReadOnlyMemRegion context=ReadOnlyMemRegion())	
Scope:	class ara::crypto::cryp::VerifierPublicCtx	
Syntax:	virtual ara::core::Result<bool> ara::crypto::cryp::VerifierPublicCtx::VerifyPrehashed (const HashFunctionCtx &hashFn, const Signature &signature, ReadOnlyMemRegion context=ReadOnlyMemRegion()) const noexcept=0;	
Parameters (in):	hashFn	hash function to be used for hashing
	signature	the signature object for the verification
	context	an optional user supplied "context" (its support depends from concrete algorithm)





Return value:	ara::core::Result< bool >	true if the signature was verified successfully and false otherwise
Exception Safety:	noexcept	
Thread Safety:	Thread-safe	
Errors:	CryptoErrc::kIncompatibleObject	if the CryptoAlgId of this context does not match the CryptoAlgId of signature; or the required CryptoAlgId of the hash is not kAlgIdDefault and the required hash CryptoAlgId of this context does not match hashAlgId or the hash CryptoAlgId of signature
	CryptoErrc::kIncompatibleArguments	if the provided hashAlgId is not kAlgIdDefault and the CryptoAlgId of the provided signature object does not match the provided hashAlgId
	CryptoErrc::kBadObjectReference	if the provided signature object does not reference the public key loaded to the context, i.e. if the COUID of the public key in the context is not equal to the COUID referenced from the signature object.
	CryptoErrc::kInvalidInputSize	if the size of the supplied context or hashValue is incompatible with the configured signature algorithm.
Header file:	#include "ara/crypto/cryp/verifier_public_ctx.h"	
Description:	Verify signature by a digest value stored in the hash-function context. This is a pass-through interface to SWS_CRYPT_24112 for developer convenience, i.e. it adds additional input checks and then calls the default verify() interface.	

](RS_CRYPT_02204)

[SWS_CRYPT_24114]{DRAFT} [

Kind:	function	
Symbol:	VerifyPrehashed(const HashFunctionCtx &hashFn, ReadOnlyMemRegion signature, ReadOnlyMemRegion context=ReadOnlyMemRegion())	
Scope:	class ara::crypto::cryp::VerifierPublicCtx	
Syntax:	virtual ara::core::Result<bool> ara::crypto::cryp::VerifierPublicCtx::VerifyPrehashed (const HashFunctionCtx &hashFn, ReadOnlyMemRegion signature, ReadOnlyMemRegion context=ReadOnlyMemRegion()) const noexcept=0;	
Parameters (in):	hashFn	hash function to be used for hashing
	signature	the data BLOB to be verified
	context	an optional user supplied "context" (its support depends from concrete algorithm)
Return value:	ara::core::Result< bool >	true if the signature was verified successfully and false otherwise
Exception Safety:	noexcept	
Thread Safety:	Thread-safe	
Errors:	CryptoErrc::kProcessingNotFinished	if the method hashFn.Finish() was not called before this method call
	CryptoErrc::kInvalidArgument	if the CryptoAlgId of hashFn differs from the CryptoAlgId of this context
	CryptoErrc::kInvalidInputSize	if the size of the supplied context or signature is incompatible with the configured signature algorithm.
Header file:	#include "ara/crypto/cryp/verifier_public_ctx.h"	





Description:	Verify signature by a digest value stored in the hash-function context. This is a pass-through interface to SWS_CRYPT_24112 for developer convenience, i.e. it adds additional input checks and then calls the default verify() interface.
---------------------	--

](RS_CRYPT_02204)

[SWS_CRYPT_24101]{DRAFT} [

Kind:	type alias
Symbol:	Uptr
Scope:	class ara::crypto::cryp::VerifierPublicCtx
Derived from:	std::unique_ptr<VerifierPublicCtx>
Syntax:	using ara::crypto::cryp::VerifierPublicCtx::Uptr = std::unique_ptr<VerifierPublicCtx>;
Header file:	#include "ara/crypto/cryp/verifier_public_ctx.h"
Description:	Unique smart pointer of the interface.

](RS_CRYPT_02204)

[SWS_CRYPT_20101]{DRAFT} [

Kind:	type alias
Symbol:	Uptr
Scope:	class ara::crypto::cryp::AuthCipherCtx
Derived from:	std::unique_ptr<AuthCipherCtx>
Syntax:	using ara::crypto::cryp::AuthCipherCtx::Uptr = std::unique_ptr<AuthCipherCtx>;
Header file:	#include "ara/crypto/cryp/auth_cipher_ctx.h"
Description:	Unique smart pointer of the interface.

](RS_CRYPT_02207)

[SWS_CRYPT_24802]{DRAFT} [

Kind:	type alias
Symbol:	Uptrc
Scope:	class ara::crypto::cryp::RestrictedUseObject
Derived from:	std::unique_ptr<const RestrictedUseObject>
Syntax:	using ara::crypto::cryp::RestrictedUseObject::Uptrc = std::unique_ptr<const RestrictedUseObject>;
Header file:	#include "ara/crypto/cryp/cryobj/restricted_use_object.h"
Description:	Unique smart pointer of the interface.

](RS_CRYPT_02403)

[SWS_CRYPT_29031]{DRAFT} [

Kind:	type alias
Symbol:	Uptr
Scope:	class ara::crypto::cryp::BlockService
Derived from:	std::unique_ptr<BlockService>
Syntax:	using ara::crypto::cryp::BlockService::Uptr = std::unique_ptr<BlockService>;
Header file:	#include "ara/crypto/cryp/block_service.h"
Description:	Unique smart pointer of the interface.

] ([RS_CRYPT_02309](#))

[SWS_CRYPT_20402]{DRAFT} [

Kind:	type alias
Symbol:	AlgId
Scope:	class ara::crypto::cryp::CryptoContext
Derived from:	CryptoAlgId
Syntax:	using ara::crypto::cryp::CryptoContext::AlgId = CryptoAlgId;
Header file:	#include "ara/crypto/cryp/crypto_context.h"
Description:	Type definition of vendor specific binary Crypto Primitive ID.

] ([RS_CRYPT_02008](#))

[SWS_CRYPT_20504]{DRAFT} [

Kind:	struct
Symbol:	COIdentifier
Scope:	class ara::crypto::cryp::CryptoObject
Syntax:	struct ara::crypto::cryp::CryptoObject::COIdentifier {...};
Header file:	#include "ara/crypto/cryp/cryobj/crypto_object.h"
Description:	Unique identifier of this CryptoObject.

] ([RS_CRYPT_02005](#))

[SWS_CRYPT_20502]{DRAFT} [

Kind:	type alias
Symbol:	Uptrc
Scope:	class ara::crypto::cryp::CryptoObject
Derived from:	std::unique_ptr<const CryptoObject>
Syntax:	using ara::crypto::cryp::CryptoObject::Uptrc = std::unique_ptr<const CryptoObject>;
Header file:	#include "ara/crypto/cryp/cryobj/crypto_object.h"
Description:	Unique smart pointer of the constant interface.

] ([RS_CRYPT_02005](#))

[SWS_CRYPT_20501]{DRAFT} [

Kind:	type alias
Symbol:	Uptr
Scope:	class ara::crypto::cryp::CryptoObject
Derived from:	std::unique_ptr<CryptoObject>
Syntax:	using ara::crypto::cryp::CryptoObject::Uptr = std::unique_ptr<CryptoObject>;
Header file:	#include "ara/crypto/cryp/cryobj/crypto_object.h"
Description:	Unique smart pointer of the interface.

]([RS_CRYPT_02005](#))

[SWS_CRYPT_20641]{DRAFT} [

Kind:	type alias
Symbol:	AlgId
Scope:	class ara::crypto::cryp::CryptoPrimitiveld
Derived from:	CryptoAlgId
Syntax:	using ara::crypto::cryp::CryptoPrimitiveId::AlgId = CryptoAlgId;
Header file:	#include "ara/crypto/cryp/cryobj/crypto_primitive_id.h"
Description:	Type definition of vendor specific binary Crypto Primitive ID.

]([RS_CRYPT_02005](#))

[SWS_CRYPT_20644]{DRAFT} [

Kind:	type alias
Symbol:	Uptrc
Scope:	class ara::crypto::cryp::CryptoPrimitiveld
Derived from:	std::unique_ptr<const CryptoPrimitiveld>
Syntax:	using ara::crypto::cryp::CryptoPrimitiveId::Uptrc = std::unique_ptr<const CryptoPrimitiveld>;
Header file:	#include "ara/crypto/cryp/cryobj/crypto_primitive_id.h"
Description:	type definition pointer

]([RS_CRYPT_02005](#))

[SWS_CRYPT_20643]{DRAFT} [

Kind:	type alias
Symbol:	Uptr
Scope:	class ara::crypto::cryp::CryptoPrimitiveld
Derived from:	std::unique_ptr<CryptoPrimitiveld>
Syntax:	using ara::crypto::cryp::CryptoPrimitiveId::Uptr = std::unique_ptr<CryptoPrimitiveld>;
Header file:	#include "ara/crypto/cryp/cryobj/crypto_primitive_id.h"
Description:	type definition pointer to const

]([RS_CRYPT_02005](#))

[SWS_CRYPT_20703]{DRAFT} [

Kind:	type alias
Symbol:	AlgId
Scope:	class ara::crypto::cryp::CryptoProvider
Derived from:	CryptoPrimitiveId::AlgId
Syntax:	using ara::crypto::cryp::CryptoProvider::AlgId = CryptoPrimitiveId::AlgId;
Header file:	#include "ara/crypto/cryp/crypto_provider.h"
Description:	A short alias for Algorithm ID type definition.

]([RS_CRYPT_02005](#), [RS_CRYPT_02006](#))

[SWS_CRYPT_20701]{DRAFT} [

Kind:	type alias
Symbol:	Uptr
Scope:	class ara::crypto::cryp::CryptoProvider
Derived from:	std::unique_ptr<CryptoProvider>
Syntax:	using ara::crypto::cryp::CryptoProvider::Uptr = std::unique_ptr<CryptoProvider>;
Header file:	#include "ara/crypto/cryp/crypto_provider.h"
Description:	Shared smart pointer of the interface.

]([RS_CRYPT_02109](#))

[SWS_CRYPT_29024]{DRAFT} [

Kind:	type alias
Symbol:	Uptr
Scope:	class ara::crypto::cryp::CryptoService
Derived from:	std::unique_ptr<CryptoService>
Syntax:	using ara::crypto::cryp::CryptoService::Uptr = std::unique_ptr<CryptoService>;
Header file:	#include "ara/crypto/cryp/crypto_service.h"
Description:	Unique smart pointer of the interface.

]([RS_CRYPT_02309](#))

[SWS_CRYPT_20801]{DRAFT} [

Kind:	type alias
Symbol:	Uptr
Scope:	class ara::crypto::cryp::DecryptorPrivateCtx
Derived from:	std::unique_ptr<DecryptorPrivateCtx>
Syntax:	using ara::crypto::cryp::DecryptorPrivateCtx::Uptr = std::unique_ptr<DecryptorPrivateCtx>;
Header file:	#include "ara/crypto/cryp/decryptor_private_ctx.h"
Description:	Unique smart pointer of the interface.

]([RS_CRYPT_02202](#))

[SWS_CRYPT_29011]{DRAFT} [

Kind:	type alias
Symbol:	Uptr
Scope:	class ara::crypto::cryp::DigestService
Derived from:	std::unique_ptr<DigestService>
Syntax:	using ara::crypto::cryp::DigestService::Uptr = std::unique_ptr<DigestService>;
Header file:	#include "ara/crypto/cryp/digest_service.h"
Description:	Unique smart pointer of the interface.

]([RS_CRYPT_02309](#))

[SWS_CRYPT_21001]{DRAFT} [

Kind:	type alias
Symbol:	Uptr
Scope:	class ara::crypto::cryp::EncryptorPublicCtx
Derived from:	std::unique_ptr<EncryptorPublicCtx>
Syntax:	using ara::crypto::cryp::EncryptorPublicCtx::Uptr = std::unique_ptr<EncryptorPublicCtx>;
Header file:	#include "ara/crypto/cryp/encryptor_public_ctx.h"
Description:	Unique smart pointer of the interface.

]([RS_CRYPT_02202](#))

[SWS_CRYPT_29042]{DRAFT} [

Kind:	type alias
Symbol:	Uptr
Scope:	class ara::crypto::cryp::ExtensionService
Derived from:	std::unique_ptr<ExtensionService>
Syntax:	using ara::crypto::cryp::ExtensionService::Uptr = std::unique_ptr<ExtensionService>;
Header file:	#include "ara/crypto/cryp/extension_service.h"
Description:	Unique smart pointer of the interface.

]([RS_CRYPT_02309](#))

[SWS_CRYPT_21101]{DRAFT} [

Kind:	type alias
Symbol:	Uptr
Scope:	class ara::crypto::cryp::HashFunctionCtx
Derived from:	std::unique_ptr<HashFunctionCtx>
Syntax:	using ara::crypto::cryp::HashFunctionCtx::Uptr = std::unique_ptr<HashFunctionCtx>;
Header file:	#include "ara/crypto/cryp/hash_function_ctx.h"
Description:	Unique smart pointer of the interface.

]([RS_CRYPT_02205](#))

[SWS_CRYPT_21301]{DRAFT} [

Kind:	type alias
Symbol:	Uptr
Scope:	class ara::crypto::cryp::KeyAgreementPrivateCtx
Derived from:	std::unique_ptr<KeyAgreementPrivateCtx>
Syntax:	using ara::crypto::cryp::KeyAgreementPrivateCtx::Uptr = std::unique_ptr<KeyAgreementPrivateCtx>;
Header file:	#include "ara/crypto/cryp/key_agreement_private_ctx.h"
Description:	Unique smart pointer of this interface.

]([RS_CRYPT_02104](#))

[SWS_CRYPT_21401]{DRAFT} [

Kind:	type alias
Symbol:	Uptr
Scope:	class ara::crypto::cryp::KeyDecapsulatorPrivateCtx
Derived from:	std::unique_ptr<KeyDecapsulatorPrivateCtx>
Syntax:	using ara::crypto::cryp::KeyDecapsulatorPrivateCtx::Uptr = std::unique_ptr<KeyDecapsulatorPrivateCtx>;
Header file:	#include "ara/crypto/cryp/key_decapsulator_private_ctx.h"
Description:	Unique smart pointer of the interface.

]([RS_CRYPT_02104](#))

[SWS_CRYPT_21501]{DRAFT} [

Kind:	type alias
Symbol:	Uptr
Scope:	class ara::crypto::cryp::KeyDerivationFunctionCtx
Derived from:	std::unique_ptr<KeyDerivationFunctionCtx>
Syntax:	using ara::crypto::cryp::KeyDerivationFunctionCtx::Uptr = std::unique_ptr<KeyDerivationFunctionCtx>;
Header file:	#include "ara/crypto/cryp/key_derivation_function_ctx.h"
Description:	Unique smart pointer of the interface.

]([RS_CRYPT_02103](#))

[SWS_CRYPT_21801]{DRAFT} [

Kind:	type alias
Symbol:	Uptr
Scope:	class ara::crypto::cryp::KeyEncapsulatorPublicCtx
Derived from:	std::unique_ptr<KeyEncapsulatorPublicCtx>
Syntax:	using ara::crypto::cryp::KeyEncapsulatorPublicCtx::Uptr = std::unique_ptr<KeyEncapsulatorPublicCtx>;
Header file:	#include "ara/crypto/cryp/key_encapsulator_public_ctx.h"
Description:	Unique smart pointer of the interface.

]([RS_CRYPT_02209](#))

[SWS_CRYPT_22101]{DRAFT} [

Kind:	type alias
Symbol:	Uptr
Scope:	class ara::crypto::cryp::MessageAuthnCodeCtx
Derived from:	std::unique_ptr<MessageAuthnCodeCtx>
Syntax:	using ara::crypto::cryp::MessageAuthnCodeCtx::Uptr = std::unique_ptr<MessageAuthnCodeCtx>;
Header file:	#include "ara/crypto/cryp/message_authn_code_ctx.h"
Description:	Unique smart pointer of the interface.

]([RS_CRYPT_02203](#))

[SWS_CRYPT_22201]{DRAFT} [

Kind:	type alias
Symbol:	Uptr
Scope:	class ara::crypto::cryp::MsgRecoveryPublicCtx
Derived from:	std::unique_ptr<MsgRecoveryPublicCtx>
Syntax:	using ara::crypto::cryp::MsgRecoveryPublicCtx::Uptr = std::unique_ptr<MsgRecoveryPublicCtx>;
Header file:	#include "ara/crypto/cryp/msg_recovery_public_ctx.h"
Description:	Unique smart pointer of the interface.

]([RS_CRYPT_02204](#))

[SWS_CRYPT_22501]{DRAFT} [

Kind:	type alias
Symbol:	Uptrc
Scope:	class ara::crypto::cryp::PrivateKey
Derived from:	std::unique_ptr<const PrivateKey>
Syntax:	using ara::crypto::cryp::PrivateKey::Uptrc = std::unique_ptr<const PrivateKey>;
Header file:	#include "ara/crypto/cryp/cryobj/private_key.h"
Description:	Unique smart pointer of the interface.

]([RS_CRYPT_02306](#))

[SWS_CRYPT_22701]{DRAFT} [

Kind:	type alias
Symbol:	Uptrc
Scope:	class ara::crypto::cryp::PublicKey
Derived from:	std::unique_ptr<const PublicKey>
Syntax:	using ara::crypto::cryp::PublicKey::Uptrc = std::unique_ptr<const PublicKey>;
Header file:	#include "ara/crypto/cryp/cryobj/public_key.h"
Description:	Unique smart pointer of the interface.

]([RS_CRYPT_02202](#))

[SWS_CRYPT_22901]{DRAFT} [

Kind:	type alias
Symbol:	Uptr
Scope:	class ara::crypto::cryp::RandomGeneratorCtx
Derived from:	std::unique_ptr<RandomGeneratorCtx>
Syntax:	using ara::crypto::cryp::RandomGeneratorCtx::Uptr = std::unique_ptr<RandomGeneratorCtx>;
Header file:	#include "ara/crypto/cryp/random_generator_ctx.h"
Description:	Shared smart pointer of the interface.

]([RS_CRYPT_02206](#))

[SWS_CRYPT_24801]{DRAFT} [

Kind:	type alias
Symbol:	Usage
Scope:	class ara::crypto::cryp::RestrictedUseObject
Derived from:	AllowedUsageFlags
Syntax:	using ara::crypto::cryp::RestrictedUseObject::Usage = AllowedUsageFlags;
Header file:	#include "ara/crypto/cryp/cryobj/restricted_use_object.h"
Description:	Alias to the container type for bit-flags of allowed usages of the object.

]([RS_CRYPT_02008](#))

[SWS_CRYPT_23001]{DRAFT} [

Kind:	type alias
Symbol:	Uptrc
Scope:	class ara::crypto::cryp::SecretSeed
Derived from:	std::unique_ptr<const SecretSeed>
Syntax:	using ara::crypto::cryp::SecretSeed::Uptrc = std::unique_ptr<const SecretSeed>;
Header file:	#include "ara/crypto/cryp/cryobj/secret_seed.h"
Description:	Unique smart pointer of a constant interface instance.

]([RS_CRYPT_02007](#))

[SWS_CRYPT_23002]{DRAFT} [

Kind:	type alias
Symbol:	Uptr
Scope:	class ara::crypto::cryp::SecretSeed
Derived from:	std::unique_ptr<SecretSeed>
Syntax:	using ara::crypto::cryp::SecretSeed::Uptr = std::unique_ptr<SecretSeed>;
Header file:	#include "ara/crypto/cryp/cryobj/secret_seed.h"
Description:	Unique smart pointer of a volatile interface instance.

]([RS_CRYPT_02007](#))

[SWS_CRYPT_23201]{DRAFT} [

Kind:	type alias
Symbol:	Uptr
Scope:	class ara::crypto::cryp::SigEncodePrivateCtx
Derived from:	std::unique_ptr<SigEncodePrivateCtx>
Syntax:	using ara::crypto::cryp::SigEncodePrivateCtx::Uptr = std::unique_ptr<SigEncodePrivateCtx>;
Header file:	#include "ara/crypto/cryp/sig_encode_private_ctx.h"
Description:	Unique smart pointer of the interface.

]([RS_CRYPT_02204](#), [RS_CRYPT_02202](#))

[SWS_CRYPT_29001]{DRAFT} [

Kind:	type alias
Symbol:	Uptr
Scope:	class ara::crypto::cryp::SignatureService
Derived from:	std::unique_ptr<SignatureService>
Syntax:	using ara::crypto::cryp::SignatureService::Uptr = std::unique_ptr<SignatureService>;
Header file:	#include "ara/crypto/cryp/signature_service.h"
Description:	Unique smart pointer of the interface.

]([RS_CRYPT_02309](#))

[SWS_CRYPT_23301]{DRAFT} [

Kind:	type alias
Symbol:	Uptrc
Scope:	class ara::crypto::cryp::Signature
Derived from:	std::unique_ptr<const Signature>
Syntax:	using ara::crypto::cryp::Signature::Uptrc = std::unique_ptr<const Signature>;
Header file:	#include "ara/crypto/cryp/cryobj/signature.h"
Description:	Unique smart pointer of the interface.

]([RS_CRYPT_02204](#), [RS_CRYPT_02203](#), [RS_CRYPT_02205](#))

[SWS_CRYPT_23501]{DRAFT} [

Kind:	type alias
Symbol:	Uptr
Scope:	class ara::crypto::cryp::SignerPrivateCtx
Derived from:	std::unique_ptr<SignerPrivateCtx>
Syntax:	using ara::crypto::cryp::SignerPrivateCtx::Uptr = std::unique_ptr<SignerPrivateCtx>;
Header file:	#include "ara/crypto/cryp/signer_private_ctx.h"
Description:	Unique smart pointer of the interface.

]([RS_CRYPT_02204](#))

[SWS_CRYPT_23601]{DRAFT} [

Kind:	type alias
Symbol:	Uptr
Scope:	class ara::crypto::cryp::StreamCipherCtx
Derived from:	std::unique_ptr<StreamCipherCtx>
Syntax:	using ara::crypto::cryp::StreamCipherCtx::Uptr = std::unique_ptr<StreamCipherCtx>;
Header file:	#include "ara/crypto/cryp/stream_cipher_ctx.h"
Description:	Unique smart pointer of the interface.

]([RS_CRYPT_02201](#))

[SWS_CRYPT_23701]{DRAFT} [

Kind:	type alias
Symbol:	Uptr
Scope:	class ara::crypto::cryp::SymmetricBlockCipherCtx
Derived from:	std::unique_ptr<SymmetricBlockCipherCtx>
Syntax:	using ara::crypto::cryp::SymmetricBlockCipherCtx::Uptr = std::unique_ptr<SymmetricBlockCipherCtx>;
Header file:	#include "ara/crypto/cryp/symmetric_block_cipher_ctx.h"
Description:	Unique smart pointer of the interface.

]([RS_CRYPT_02201](#))

[SWS_CRYPT_23801]{DRAFT} [

Kind:	type alias
Symbol:	Uptrc
Scope:	class ara::crypto::cryp::SymmetricKey
Derived from:	std::unique_ptr<const SymmetricKey>
Syntax:	using ara::crypto::cryp::SymmetricKey::Uptrc = std::unique_ptr<const SymmetricKey>;
Header file:	#include "ara/crypto/cryp/cryobj/symmetric_key.h"
Description:	Unique smart pointer of the interface.

]([RS_CRYPT_02201](#))

[SWS_CRYPT_24001]{DRAFT} [

Kind:	type alias
Symbol:	Uptr
Scope:	class ara::crypto::cryp::SymmetricKeyWrapperCtx
Derived from:	std::unique_ptr<SymmetricKeyWrapperCtx>
Syntax:	using ara::crypto::cryp::SymmetricKeyWrapperCtx::Uptr = std::unique_ptr<SymmetricKeyWrapperCtx>;
Header file:	#include "ara/crypto/cryp/symmetric_key_wrapper_ctx.h"
Description:	Unique smart pointer of the interface.

]([RS_CRYPT_02201](#))

[SWS_CRYPT_20506]{DRAFT} [

Kind:	variable
Symbol:	mCOType
Scope:	struct ara::crypto::cryp::CryptoObject::COIdentifier
Type:	CryptoObjectType
Syntax:	CryptoObjectType ara::crypto::cryp::CryptoObject::COIdentifier::mCOType;
Header file:	#include "ara/crypto/cryp/cryobj/crypto_object.h"
Description:	type of object

]([RS_CRYPT_02005](#))

[SWS_CRYPT_20507]{DRAFT} [

Kind:	variable
Symbol:	mCoid
Scope:	struct ara::crypto::cryp::CryptoObject::COIdentifier
Type:	CryptoObjectUid
Syntax:	CryptoObjectUid ara::crypto::cryp::CryptoObject::COIdentifier::mCoid;
Header file:	#include "ara/crypto/cryp/cryobj/crypto_object.h"
Description:	object identifier

]([RS_CRYPT_02005](#))

[SWS_CRYPT_22503]{DRAFT} [

Kind:	variable
Symbol:	kObjectType
Scope:	class ara::crypto::cryp::PrivateKey
Type:	const CryptoObjectType
Syntax:	static const CryptoObjectType ara::crypto::cryp::PrivateKey::kObjectType = CryptoObjectType::kPrivateKey;
Header file:	#include "ara/crypto/cryp/cryobj/private_key.h"
Description:	Static mapping of this interface to specific value of CryptoObjectType enumeration.

]([RS_CRYPT_02306](#))

[SWS_CRYPT_22702]{DRAFT} [

Kind:	variable
Symbol:	kObjectType
Scope:	class ara::crypto::cryp::PublicKey
Type:	const CryptoObjectType
Syntax:	static const CryptoObjectType ara::crypto::cryp::PublicKey::kObjectType = CryptoObjectType::kPublicKey;
Header file:	#include "ara/crypto/cryp/cryobj/public_key.h"
Description:	const object type

]([RS_CRYPT_02202](#))

[SWS_CRYPT_23003]{DRAFT} [

Kind:	variable
Symbol:	kObjectType
Scope:	class ara::crypto::crypt::SecretSeed
Type:	const CryptoObjectType
Syntax:	static const CryptoObjectType ara::crypto::crypt::SecretSeed::kObjectType = CryptoObjectType::kSecretSeed;
Header file:	#include "ara/crypto/cryp/cryobj/secret_seed.h"
Description:	Static mapping of this interface to specific value of CryptoObjectType enumeration.

]([RS_CRYPT_02007](#))

[SWS_CRYPT_23302]{DRAFT} [

Kind:	variable
Symbol:	kObjectType
Scope:	class ara::crypto::crypt::Signature
Type:	const CryptoObjectType
Syntax:	static const CryptoObjectType ara::crypto::crypt::Signature::kObjectType = CryptoObjectType::kSignature;
Header file:	#include "ara/crypto/cryp/cryobj/signature.h"
Description:	Signature object initialized.

]([RS_CRYPT_02204](#), [RS_CRYPT_02203](#), [RS_CRYPT_02205](#))

[SWS_CRYPT_23802]{DRAFT} [

Kind:	variable
Symbol:	kObjectType
Scope:	class ara::crypto::crypt::SymmetricKey
Type:	const CryptoObjectType
Syntax:	static const CryptoObjectType ara::crypto::crypt::SymmetricKey::kObjectType = CryptoObjectType::kSymmetricKey;
Header file:	#include "ara/crypto/cryp/cryobj/symmetric_key.h"
Description:	const object type

]([RS_CRYPT_02201](#))

[SWS_CRYPT_10101]{DRAFT} [

Kind:	variable
Symbol:	mGeneratorUid
Scope:	struct ara::crypto::CryptoObjectUid
Type:	Uuid
Syntax:	Uuid ara::crypto::CryptoObjectUid::mGeneratorUid;
Header file:	#include "ara/crypto/common/crypto_object_uid.h"
Description:	UUID of a generator that has produced this COUID. This UUID can be associated with HSM, physical host/ECU or VM.

]([RS_CRYPT_02006](#))

8.2 C++ language binding Key Storage Provider

[SWS_CRYPT_30400]{DRAFT} [

Kind:	class
Symbol:	KeySlot
Scope:	namespace ara::crypto::keys
Syntax:	<code>class ara::crypto::keys::KeySlot { ...};</code>
Header file:	<code>#include "ara/crypto/keys/keyslot.h"</code>
Description:	Key slot port-prototype interface. This class enables access to a physical key-slot.

]([RS_CRYPT_02405](#))

[SWS_CRYPT_30100]{DRAFT} [

Kind:	class
Symbol:	KeyStorageProvider
Scope:	namespace ara::crypto::keys
Syntax:	<code>class ara::crypto::keys::KeyStorageProvider { ...};</code>
Header file:	<code>#include "ara/crypto/keys/key_storage_provider.h"</code>
Description:	Key Storage Provider interface. Any object is uniquely identified by the combination of its UUID and type. HSMs/TPMs implementing the concept of "non-extractable keys" should use own copies of externally supplied crypto objects. A few software Crypto Providers can share single key slot if they support same format.

]([RS_CRYPT_02109](#), [RS_CRYPT_02305](#), [RS_CRYPT_02401](#))

[SWS_CRYPT_30200]{DRAFT} [

Kind:	class
Symbol:	UpdatesObserver
Scope:	namespace ara::crypto::keys
Syntax:	<code>class ara::crypto::keys::UpdatesObserver { ...};</code>
Header file:	<code>#include "ara/crypto/keys/updates_observer.h"</code>
Description:	Definition of an "updates observer" interface. The "updates observer" interface should be implemented by a consumer application, if a software developer would like to get notifications about the slots' content update events.

]([RS_CRYPT_02004](#))

[SWS_CRYPT_30405]{DRAFT} [

Kind:	function
Symbol:	Clear()
Scope:	class ara::crypto::keys::KeySlot
Syntax:	<code>virtual ara::core::Result<void> ara::crypto::keys::KeySlot::Clear () noexcept=0;</code>
Return value:	ara::core::Result< void > -
Exception Safety:	noexcept
Thread Safety:	Thread-safe





Errors:	CryptoErrorDomain::kUnreserved Resource	if the target slot is not opened writeable.
Header file:	#include "ara/crypto/keys/keyslot.h"	
Description:	Clear the content of this key-slot. This method must perform a secure cleanup without the ability to restore the object data! This method may be used for atomic update of a key slot scoped to some transaction. In such case the the slot will be updated only after correspondent call of CommitTransaction().	

]([RS_CRYPT_02009](#))

[SWS_CRYPT_30510]{DRAFT} [

Kind:	function
Symbol:	KeySlotContentProps()
Scope:	struct ara::crypto::keys::KeySlotContentProps
Syntax:	ara::crypto::keys::KeySlotContentProps::KeySlotContentProps ()=default;
Header file:	#include "ara/crypto/keys/key_slot_content_props.h"
Description:	set content properties

]([RS_CRYPT_02111](#))

[SWS_CRYPT_30401]{DRAFT} [

Kind:	function
Symbol:	~KeySlot()
Scope:	class ara::crypto::keys::KeySlot
Syntax:	virtual ara::crypto::keys::KeySlot::~KeySlot () noexcept=default;
Exception Safety:	noexcept
Header file:	#include "ara/crypto/keys/keyslot.h"
Description:	Destructor.

]([RS_CRYPT_02405](#))

[SWS_CRYPT_30408]{DRAFT} [

Kind:	function	
Symbol:	GetContentProps()	
Scope:	class ara::crypto::keys::KeySlot	
Syntax:	virtual ara::core::Result< KeySlotContentProps > ara::crypto::keys::KeySlot::GetContentProps () const noexcept=0;	
Return value:	ara::core::Result< KeySlotContent Props >	-
Exception Safety:	noexcept	
Thread Safety:	Thread-safe	
Errors:	CryptoErrorDomain::kEmptyContainer	if the slot is empty
	CryptoErrorDomain::kAccessViolation	if this method is called by an Actor, which has no any ("Owner" or "User") access rights to the key slot
Header file:	#include "ara/crypto/keys/keyslot.h"	
Description:	Get an actual properties of a content in the key slot. If this method called by a "User" Actor then always: props.exportability == false.	

](RS_CRYPT_02004)

[SWS_CRYPT_30403]{DRAFT} [

Kind:	function	
Symbol:	MyProvider()	
Scope:	class ara::crypto::keys::KeySlot	
Syntax:	virtual ara::core::Result<cryp::CryptoProvider::Uptr> ara::crypto::keys::KeySlot::MyProvider () const noexcept=0;	
Return value:	ara::core::Result< cryp::Crypto Provider::Uptr >	a unique_pointer to the CryptoProvider to be used with this KeySlot
Exception Safety:	noexcept	
Thread Safety:	Thread-safe	
Header file:	#include "ara/crypto/keys/keyslot.h"	
Description:	Retrieve an instance of the CryptoProvider that owns this KeySlot. Any key slot always has an associated default Crypto Provider that can serve this key slot. In the simplest case all key slots can be served by a single Crypto Provider installed on the Adaptive Platform. But in a more complicated case a few different Crypto Providers may coexist in the system, for example if ECU has one or a few HSMs and software cryptography implementation too, and each of them has own physical key storage. In such case different dedicated Crypto Providers may serve mentioned HSMs and the software implementation. .	

](RS_CRYPT_02401)

[SWS_CRYPT_30407]{DRAFT} [

Kind:	function	
Symbol:	GetPrototypedProps()	
Scope:	class ara::crypto::keys::KeySlot	
Syntax:	virtual ara::core::Result<KeySlotPrototypeProps> ara::crypto::keys::KeySlot::GetPrototypedProps () const noexcept=0;	
Return value:	ara::core::Result< KeySlotPrototype Props >	–
Exception Safety:	noexcept	
Thread Safety:	Thread-safe	
Header file:	#include "ara/crypto/keys/keyslot.h"	
Description:	Get the prototyped properties of the key slot.	

](RS_CRYPT_02110)

[SWS_CRYPT_30404]{DRAFT} [

Kind:	function	
Symbol:	IsEmpty()	
Scope:	class ara::crypto::keys::KeySlot	
Syntax:	virtual bool ara::crypto::keys::KeySlot::IsEmpty () const noexcept=0;	
Return value:	bool	true if the slot is empty or false otherwise
Exception Safety:	noexcept	
Thread Safety:	Thread-safe	
Header file:	#include "ara/crypto/keys/keyslot.h"	
Description:	Check the slot for emptiness.	

](RS_CRYPT_02004)

[SWS_CRYPT_30409]{DRAFT} [

Kind:	function	
Symbol:	Open(bool subscribeForUpdates=false, bool writeable=false)	
Scope:	class ara::crypto::keys::KeySlot	
Syntax:	virtual ara::core::Result<IOInterface::Uptr> ara::crypto::keys::KeySlot::Open (bool subscribeForUpdates=false, bool writeable=false) const noexcept=0;	
Parameters (in):	subscribeForUpdates	if this flag is true then the UpdatesObserver instance (previously registered by a call of the method RegisterObserver()) will be subscribed for updates of the opened key slot
	writeable	indicates whether the key-slot shall be opened read-only (default) or with write access
Return value:	ara::core::Result< IOInterface::Uptr >	an unique smart pointer to the IOInterface associated with the slot content
Exception Safety:	noexcept	
Thread Safety:	Thread-safe	
Errors:	CryptoErrorDomain::kInvalidUsage Order	if (true == subscribeForUpdates), but there is no registered instance of the UpdatesObserver in the Key Storage Provider context
	CryptoErrorDomain::kBusyResource	if the specified slot is busy because writeable == true but (a) the keyslot is already opened writable, and/or (b) the keyslot is in scope of another ongoing transaction
	CryptoErrorDomain::kModified Resource	if the specified slot has been modified after the Key Slot has been opened
Header file:	#include "ara/crypto/keys/keyslot.h"	
Description:	Open this key slot and return an IOInterface to its content. If the UpdatesObserver interface was provided to the call of RegisterObserver() then the UpdatesObserver::OnUpdate() method should be called by Key Storage engine (in a dedicated thread) every time when this slot is updated (and become visible for "Users"). Monitoring of the opened key slot will be continued even after destruction of the returned TrustedContainer, because content of the slot may be loaded to volatile memory (as a CryptoObject or to a CryptoContext of a crypto primitive), but the TrustedContainer may be destroyed after this. Therefore if you need to terminate monitoring of the key slot then you should directly call method UnsubscribeObserver(SlotNumber).	

] ([RS_CRYPT_02004](#))

[SWS_CRYPT_30301]{DRAFT} [

Kind:	function
Symbol:	KeySlotPrototypeProps()
Scope:	struct ara::crypto::keys::KeySlotPrototypeProps
Syntax:	ara::crypto::keys::KeySlotPrototypeProps::KeySlotPrototypeProps ()=default;
Header file:	#include "ara/crypto/keys/key_slot_prototype_props.h"

] ([RS_CRYPT_02110](#))

[SWS_CRYPT_30406]{DRAFT} [

Kind:	function	
Symbol:	SaveCopy(const IOInterface &container)	
Scope:	class ara::crypto::keys::KeySlot	
Syntax:	virtual ara::core::Result<void> ara::crypto::keys::KeySlot::SaveCopy (const IOInterface &container) noexcept=0;	
Parameters (in):	container	the source IOInterface
Return value:	ara::core::Result< void >	true if successfully saved
Exception Safety:	noexcept	
Thread Safety:	Thread-safe	
Errors:	CryptoErrorDomain::kIncompatible Object	if the source object has property "session" or if the source IOInterface references a KeySlot from a different CryptoProvider
	CryptoErrorDomain::kEmptyContainer	if the source IOInterface is empty
	CryptoErrorDomain::kContent Restrictions	if the source object doesn't satisfy the slot restrictions (including version control)
	CryptoErrorDomain::kUnreserved Resource	if the target slot is not opened writeable.
Header file:	#include "ara/crypto/keys/keyslot.h"	
Description:	Save the content of a provided source IOInterface to this key-slot. The source container may represent a volatile trusted container or another KeySlot This method may be used for atomic update of a key slot scoped to some transaction. In such case the the slot will be updated only after correspondent call of CommitTransaction().	

] ([RS_CRYPT_02004](#))

[SWS_CRYPT_30220]{DRAFT} [

Kind:	function	
Symbol:	operator=(const KeySlot &other)	
Scope:	class ara::crypto::keys::KeySlot	
Syntax:	KeySlot& ara::crypto::keys::KeySlot::operator= (const KeySlot &other)=default;	
Parameters (in):	other	the other instance
Return value:	KeySlot &	*this, containing the contents of other
Header file:	#include "ara/crypto/keys/keyslot.h"	
Description:	Copy-assign another KeySlot to this instance.	

] ([RS_CRYPT_02004](#))

[SWS_CRYPT_30221]{DRAFT} [

Kind:	function	
Symbol:	operator=(KeySlot &&other)	
Scope:	class ara::crypto::keys::KeySlot	
Syntax:	KeySlot& ara::crypto::keys::KeySlot::operator= (KeySlot &&other)=default;	
Parameters (in):	other	the other instance
Return value:	KeySlot &	*this, containing the contents of other
Header file:	#include "ara/crypto/keys/keyslot.h"	
Description:	Move-assign another KeySlot to this instance.	

](RS_CRYPT_02004)

[SWS_CRYPT_30123]{DRAFT} [

Kind:	function	
Symbol:	BeginTransaction(const TransactionScope &targetSlots)	
Scope:	class ara::crypto::keys::KeyStorageProvider	
Syntax:	virtual ara::core::Result<TransactionId> ara::crypto::keys::KeyStorageProvider::BeginTransaction (const TransactionScope &targetSlots) noexcept=0;	
Parameters (in):	targetSlots	a list of KeySlots that should be updated during this transaction.
Return value:	ara::core::Result< TransactionId >	a unique ID assigned to this transaction
Exception Safety:	noexcept	
Thread Safety:	Thread-safe	
Errors:	CryptoErrorDomain::kUnreserved Resource	if targetSlots list has a slot that has not been configured with the reserveSpareSlot parameter in the manifest
	CryptoErrorDomain::kBusyResource	if targetSlots list has key slots that are already involved to another pending transaction or opened in writing mode
Header file:	#include "ara/crypto/keys/key_storage_provider.h"	
Description:	Begin new transaction for key slots update. In order for a keyslot to be part of a transaction scope, the reserveSpareSlot model parameter of the keyslot has to be set to true. A transaction is dedicated for updating related key slots simultaneously (in an atomic, all-or-nothing, way). All key slots that should be updated by the transaction have to be opened and provided to this function. Any changes to the slots in scope are executed by calling commit().	

](RS_CRYPT_02004)

[SWS_CRYPT_30124]{DRAFT} [

Kind:	function	
Symbol:	CommitTransaction(TransactionId id)	
Scope:	class ara::crypto::keys::KeyStorageProvider	
Syntax:	virtual ara::core::Result<void> ara::crypto::keys::KeyStorageProvider::CommitTransaction (TransactionId id) noexcept=0;	
Parameters (in):	id	an ID of a transaction that should be committed
Return value:	ara::core::Result< void >	–
Exception Safety:	noexcept	
Thread Safety:	Thread-safe	
Errors:	CryptoErrorDomain::kInvalidArgument	if provided id is invalid, i.e. this ID is unknown or correspondent transaction already was finished (committed or rolled back)
Header file:	#include "ara/crypto/keys/key_storage_provider.h"	
Description:	Commit changes of the transaction to Key Storage. Any changes of key slots made during a transaction are invisible up to the commit execution. The commit command permanently saves all changes made during the transaction in Key Storage.	

](RS_CRYPT_02004)

[SWS_CRYPT_30110]{DRAFT} [

Kind:	function
Symbol:	~KeyStorageProvider()
Scope:	class ara::crypto::keys::KeyStorageProvider
Syntax:	virtual ara::crypto::keys::KeyStorageProvider::~~KeyStorageProvider () noexcept=default;
Exception Safety:	noexcept
Header file:	#include "ara/crypto/keys/key_storage_provider.h"
Description:	Destructor.

]([RS_CRYPT_02004](#))

[SWS_CRYPT_30131]{DRAFT} [

Kind:	function
Symbol:	GetRegisteredObserver()
Scope:	class ara::crypto::keys::KeyStorageProvider
Syntax:	virtual UpdatesObserver::Uptr ara::crypto::keys::KeyStorage Provider::GetRegisteredObserver () const noexcept=0;
Return value:	UpdatesObserver::Uptr unique pointer to the registered Updates Observer interface (copy of an internal unique pointer is returned, i.e. the Key Storage provider continues to keep the ownership)
Exception Safety:	noexcept
Thread Safety:	Thread-safe
Header file:	#include "ara/crypto/keys/key_storage_provider.h"
Description:	Get pointer of registered Updates Observer. The method returns nullptr if no observers have been registered yet!

]([RS_CRYPT_02401](#))

[SWS_CRYPT_30115]{DRAFT} [

Kind:	function
Symbol:	LoadKeySlot(ara::core::InstanceSpecifier &iSpecify)
Scope:	class ara::crypto::keys::KeyStorageProvider
Syntax:	virtual ara::core::Result<KeySlot::Uptr> ara::crypto::keys::KeyStorage Provider::LoadKeySlot (ara::core::InstanceSpecifier &iSpecify) noexcept=0;
Parameters (in):	iSpecify the target key-slot instance specifier
Return value:	ara::core::Result< KeySlot::Uptr > an unique smart pointer to allocated key slot
Exception Safety:	noexcept
Thread Safety:	Thread-safe
Errors:	CryptoErrorDomain::kUnreserved Resource if the InstanceSpecifier is incorrect (the slot is not allocated)
Header file:	#include "ara/crypto/keys/key_storage_provider.h"
Description:	Load a key slot. The functions loads the information associated with a KeySlot into a KeySlot object.

]([RS_CRYPT_02004](#))

[SWS_CRYPT_30130]{DRAFT} [

Kind:	function	
Symbol:	RegisterObserver(UpdatesObserver::Uptr observer=nullptr)	
Scope:	class ara::crypto::keys::KeyStorageProvider	
Syntax:	virtual UpdatesObserver::Uptr ara::crypto::keys::KeyStorageProvider::RegisterObserver (UpdatesObserver::Uptr observer=nullptr) noexcept=0;	
Parameters (in):	observer	optional pointer to a client-supplied Updates Observer instance that should be registered inside Key Storage implementation and called every time, when an opened for usage/loading key slot is updated externally (by its "Owner" application)
Return value:	UpdatesObserver::Uptr	unique pointer to previously registered Updates Observer interface (the pointer ownership is "moved out" to the caller code)
Exception Safety:	noexcept	
Thread Safety:	Thread-safe	
Header file:	#include "ara/crypto/keys/key_storage_provider.h"	
Description:	Register consumer Updates Observer. Only one instance of the UpdatesObserver may be registered by an application process, therefore this method always unregister previous observer and return its unique pointer. If (nullptr == observer) then the method only unregister the previous observer! The method returns nullptr if no observers have been registered yet!	

] ([RS_CRYPT_02401](#))

[SWS_CRYPT_30125]{DRAFT} [

Kind:	function	
Symbol:	RollbackTransaction(TransactionId id)	
Scope:	class ara::crypto::keys::KeyStorageProvider	
Syntax:	virtual ara::core::Result<void> ara::crypto::keys::KeyStorageProvider::RollbackTransaction (TransactionId id) noexcept=0;	
Parameters (in):	id	an ID of a transaction that should be rolled back
Return value:	ara::core::Result< void >	–
Exception Safety:	noexcept	
Thread Safety:	Thread-safe	
Errors:	CryptoErrorDomain::kInvalidArgument	if provided id is invalid, i.e. this ID is unknown or correspondent transaction already was finished (committed or rolled back)
Header file:	#include "ara/crypto/keys/key_storage_provider.h"	
Description:	Rollback all changes executed during the transaction in Key Storage. The rollback command permanently cancels all changes made during the transaction in Key Storage. A rolled back transaction is completely invisible for all applications.	

] ([RS_CRYPT_02004](#))

[SWS_CRYPT_30126]{DRAFT} [

Kind:	function	
Symbol:	UnsubscribeObserver(KeySlot &slot)	
Scope:	class ara::crypto::keys::KeyStorageProvider	





Syntax:	virtual ara::core::Result<void> ara::crypto::keys::KeyStorageProvider::UnsubscribeObserver (KeySlot &slot) noexcept=0;	
Parameters (in):	slot	number of a slot that should be unsubscribed from the updates observing
Return value:	ara::core::Result< void >	–
Exception Safety:	noexcept	
Thread Safety:	Thread-safe	
Errors:	CryptoErrorDomain::kInvalidArgument	if the specified slot is not monitored now (i.e. if it was not successfully opened via OpenAsUser() or it was already unsubscribed by this method)
Header file:	#include "ara/crypto/keys/key_storage_provider.h"	
Description:	Unsubscribe the Update Observer from changes monitoring of the specified slot.	

](RS_CRYPT_02004)

[SWS_CRYPT_30222]{DRAFT} [

Kind:	function	
Symbol:	operator=(const KeyStorageProvider &other)	
Scope:	class ara::crypto::keys::KeyStorageProvider	
Syntax:	KeyStorageProvider& ara::crypto::keys::KeyStorageProvider::operator=(const KeyStorageProvider &other)=default;	
Parameters (in):	other	the other instance
Return value:	KeyStorageProvider &	*this, containing the contents of other
Header file:	#include "ara/crypto/keys/key_storage_provider.h"	
Description:	Copy-assign another KeyStorageProvider to this instance.	

](RS_CRYPT_02004)

[SWS_CRYPT_30223]{DRAFT} [

Kind:	function	
Symbol:	operator=(KeyStorageProvider &&other)	
Scope:	class ara::crypto::keys::KeyStorageProvider	
Syntax:	KeyStorageProvider& ara::crypto::keys::KeyStorageProvider::operator=(KeyStorageProvider &&other)=default;	
Parameters (in):	other	the other instance
Return value:	KeyStorageProvider &	*this, containing the contents of other
Header file:	#include "ara/crypto/keys/key_storage_provider.h"	
Description:	Move-assign another KeyStorageProvider to this instance.	

](RS_CRYPT_02004)

[SWS_CRYPT_30350]{DRAFT} [

Kind:	function	
Symbol:	operator==(const KeySlotPrototypeProps &lhs, const KeySlotPrototypeProps &rhs)	
Scope:	namespace ara::crypto::keys	



△

Syntax:	<code>constexpr bool ara::crypto::keys::operator==(const KeySlotPrototypeProps &lhs, const KeySlotPrototypeProps &rhs) noexcept;</code>	
Parameters (in):	lhs	left-hand side operand
	rhs	right-hand side operand
Return value:	bool	true if all members' values of lhs is equal to rhs, and false otherwise
Exception Safety:	noexcept	
Thread Safety:	Thread-safe	
Header file:	#include "ara/crypto/keys/key_slot_prototype_props.h"	
Description:	Comparison operator "equal" for KeySlotPrototypeProps operands.	

]([RS_CRYPT_02110](#))

[SWS_CRYPT_30351]{DRAFT} [

Kind:	function	
Symbol:	<code>operator!=(const KeySlotPrototypeProps &lhs, const KeySlotPrototypeProps &rhs)</code>	
Scope:	namespace ara::crypto::keys	
Syntax:	<code>constexpr bool ara::crypto::keys::operator!=(const KeySlotPrototypeProps &lhs, const KeySlotPrototypeProps &rhs) noexcept;</code>	
Parameters (in):	lhs	left-hand side operand
	rhs	right-hand side operand
Return value:	bool	true if at least one member of lhs has a value not equal to correspondent member of rhs, and false otherwise
Exception Safety:	noexcept	
Thread Safety:	Thread-safe	
Header file:	#include "ara/crypto/keys/key_slot_prototype_props.h"	
Description:	Comparison operator "not equal" for KeySlotPrototypeProps operands.	

]([RS_CRYPT_02110](#))

[SWS_CRYPT_30550]{DRAFT} [

Kind:	function	
Symbol:	<code>operator==(const KeySlotContentProps &lhs, const KeySlotContentProps &rhs)</code>	
Scope:	namespace ara::crypto::keys	
Syntax:	<code>constexpr bool ara::crypto::keys::operator==(const KeySlotContentProps &lhs, const KeySlotContentProps &rhs) noexcept;</code>	
Parameters (in):	lhs	left-hand side operand
	rhs	right-hand side operand
Return value:	bool	true if all members' values of lhs is equal to rhs, and false otherwise
Exception Safety:	noexcept	
Thread Safety:	Thread-safe	
Header file:	#include "ara/crypto/keys/key_slot_content_props.h"	
Description:	Comparison operator "equal" for KeySlotContentProps operands.	

]([RS_CRYPT_02111](#))

[SWS_CRYPT_30551]{DRAFT} [

Kind:	function	
Symbol:	operator!=(const KeySlotContentProps &lhs, const KeySlotContentProps &rhs)	
Scope:	namespace ara::crypto::keys	
Syntax:	constexpr bool ara::crypto::keys::operator!=(const KeySlotContentProps &lhs, const KeySlotContentProps &rhs) noexcept;	
Parameters (in):	lhs	left-hand side operand
	rhs	right-hand side operand
Return value:	bool	true if at least one member of lhs has a value not equal to correspondent member of rhs, and false otherwise
Exception Safety:	noexcept	
Thread Safety:	Thread-safe	
Header file:	#include "ara/crypto/keys/key_slot_content_props.h"	
Description:	Comparison operator "not equal" for KeySlotContentProps operands.	

] ([RS_CRYPT_02111](#))

[SWS_CRYPT_30210]{DRAFT} [

Kind:	function	
Symbol:	~UpdatesObserver()	
Scope:	class ara::crypto::keys::UpdatesObserver	
Syntax:	virtual ara::crypto::keys::UpdatesObserver::~UpdatesObserver () noexcept=default;	
Exception Safety:	noexcept	
Header file:	#include "ara/crypto/keys/updates_observer.h"	
Description:	Destructor.	

] ([RS_CRYPT_02004](#))

[SWS_CRYPT_30211]{DRAFT} [

Kind:	function	
Symbol:	OnUpdate(const TransactionScope &updatedSlots)	
Scope:	class ara::crypto::keys::UpdatesObserver	
Syntax:	virtual void ara::crypto::keys::UpdatesObserver::OnUpdate (const TransactionScope &updatedSlots) noexcept=0;	
Parameters (in):	updatedSlots	List of monitored slots that were updated after opening (for reading)
Return value:	None	
Exception Safety:	noexcept	
Thread Safety:	Thread-safe	
Header file:	#include "ara/crypto/keys/updates_observer.h"	
Description:	Notification method that should be called if content of specified slots was changed. Key Storage engine should call this method in a dedicated thread. The provided list may include only slots subscribed for observing (during opening with the "User" permissions, i.e. for "reading" via a call of the method OpenAsUser()). Each slot number may present in the provided list only one time!	

] ([RS_CRYPT_02004](#))

[SWS_CRYPT_30224]{DRAFT} [

Kind:	function	
Symbol:	operator=(const UpdatesObserver &other)	
Scope:	class ara::crypto::keys::UpdatesObserver	
Syntax:	<code>UpdatesObserver& ara::crypto::keys::UpdatesObserver::operator= (const UpdatesObserver &other)=default;</code>	
Parameters (in):	other	the other instance
Return value:	UpdatesObserver &	*this, containing the contents of other
Header file:	#include "ara/crypto/keys/updates_observer.h"	
Description:	Copy-assign another UpdatesObserver to this instance.	

]([RS_CRYPT_02004](#))

[SWS_CRYPT_30225]{DRAFT} [

Kind:	function	
Symbol:	operator=(UpdatesObserver &&other)	
Scope:	class ara::crypto::keys::UpdatesObserver	
Syntax:	<code>UpdatesObserver& ara::crypto::keys::UpdatesObserver::operator= (UpdatesObserver &&other)=default;</code>	
Parameters (in):	other	the other instance
Return value:	UpdatesObserver &	*this, containing the contents of other
Header file:	#include "ara/crypto/keys/updates_observer.h"	
Description:	Move-assign another UpdatesObserver to this instance.	

]([RS_CRYPT_02004](#))

[SWS_CRYPT_30500]{DRAFT} [

Kind:	struct	
Symbol:	KeySlotContentProps	
Scope:	namespace ara::crypto::keys	
Syntax:	<code>struct ara::crypto::keys::KeySlotContentProps {...};</code>	
Header file:	#include "ara/crypto/keys/key_slot_content_props.h"	
Description:	Properties of current Key Slot Content, i.e. of a current instance stored to the Key Slot. A value of the mAllowedUsage field is bitwise AND of the common usage flags defined at run-time and the usage flags defined by the UserPermissions prototype for current "Actor".	

]([RS_CRYPT_02005](#), [RS_CRYPT_02111](#))

[SWS_CRYPT_30511]{DRAFT} [

Kind:	type alias	
Symbol:	Uptr	
Scope:	struct ara::crypto::keys::KeySlotContentProps	
Derived from:	std::unique_ptr<KeySlotContentProps>	
Syntax:	<code>using ara::crypto::keys::KeySlotContentProps::Uptr = std::unique_ptr<KeySlotContentProps>;</code>	
Header file:	#include "ara/crypto/keys/key_slot_content_props.h"	
Description:	shared pointer of interface	

]([RS_CRYPTO_02111](#))

[SWS_CRYPT_30300]{DRAFT} [

Kind:	struct
Symbol:	KeySlotPrototypeProps
Scope:	namespace ara::crypto::keys
Syntax:	<code>struct ara::crypto::keys::KeySlotPrototypeProps {...};</code>
Header file:	<code>#include "ara/crypto/keys/key_slot_prototype_props.h"</code>
Description:	Prototyped Properties of a Key Slot.

]([RS_CRYPTO_02009](#), [RS_CRYPTO_02110](#), [RS_CRYPTO_02116](#))

[SWS_CRYPT_30302]{DRAFT} [

Kind:	type alias
Symbol:	Uptr
Scope:	struct ara::crypto::keys::KeySlotPrototypeProps
Derived from:	<code>std::unique_ptr<KeySlotPrototypeProps></code>
Syntax:	<code>using ara::crypto::keys::KeySlotPrototypeProps::Uptr = std::unique_ptr<KeySlotPrototypeProps>;</code>
Header file:	<code>#include "ara/crypto/keys/key_slot_prototype_props.h"</code>

]([RS_CRYPTO_02110](#))

[SWS_CRYPT_30402]{DRAFT} [

Kind:	type alias
Symbol:	Uptr
Scope:	class ara::crypto::keys::KeySlot
Derived from:	<code>std::unique_ptr<KeySlot></code>
Syntax:	<code>using ara::crypto::keys::KeySlot::Uptr = std::unique_ptr<KeySlot>;</code>
Header file:	<code>#include "ara/crypto/keys/keyslot.h"</code>
Description:	Unique smart pointer of the interface.

]([RS_CRYPTO_02405](#))

[SWS_CRYPT_30101]{DRAFT} [

Kind:	type alias
Symbol:	Uptr
Scope:	class ara::crypto::keys::KeyStorageProvider
Derived from:	<code>std::unique_ptr<KeyStorageProvider></code>
Syntax:	<code>using ara::crypto::keys::KeyStorageProvider::Uptr = std::unique_ptr<KeyStorageProvider>;</code>
Header file:	<code>#include "ara/crypto/keys/key_storage_provider.h"</code>

]([RS_CRYPTO_02004](#))

[SWS_CRYPT_30010]{DRAFT} [

Kind:	type alias
Symbol:	TransactionId
Scope:	namespace ara::crypto::keys
Derived from:	std::uint64_t
Syntax:	using ara::crypto::keys::TransactionId = std::uint64_t;
Header file:	#include "ara/crypto/keys/elementary_types.h"
Description:	Definition of a transaction identifier type. The zero value should be reserved for especial cases.

] ([RS_CRYPT_02004](#))

[SWS_CRYPT_30011]{DRAFT} [

Kind:	type alias
Symbol:	TransactionScope
Scope:	namespace ara::crypto::keys
Derived from:	ara::core::Vector<KeySlot>
Syntax:	using ara::crypto::keys::TransactionScope = ara::core::Vector<KeySlot>;
Header file:	#include "ara/crypto/keys/elementary_types.h"
Description:	Definition of a "transaction scope" type. The "transaction scope" defines a list of key slots that are target for update in a transaction.

] ([RS_CRYPT_02004](#))

[SWS_CRYPT_30201]{DRAFT} [

Kind:	type alias
Symbol:	Uptr
Scope:	class ara::crypto::keys::UpdatesObserver
Derived from:	std::unique_ptr<UpdatesObserver>
Syntax:	using ara::crypto::keys::UpdatesObserver::Uptr = std::unique_ptr<UpdatesObserver>;
Header file:	#include "ara/crypto/keys/updates_observer.h"
Description:	Shared smart pointer of the interface.

] ([RS_CRYPT_02004](#))

[SWS_CRYPT_30503]{DRAFT} [

Kind:	variable
Symbol:	mAlgId
Scope:	struct ara::crypto::keys::KeySlotContentProps
Type:	CryptoAlgId
Syntax:	CryptoAlgId ara::crypto::keys::KeySlotContentProps::mAlgId;
Header file:	#include "ara/crypto/keys/key_slot_content_props.h"
Description:	Cryptoalgorithm of actual object stored to the slot.

] ([RS_CRYPT_02111](#))

[SWS_CRYPT_30505]{DRAFT} [

Kind:	variable
Symbol:	mObjectSize
Scope:	struct ara::crypto::keys::KeySlotContentProps
Type:	std::size_t
Syntax:	std::size_t ara::crypto::keys::KeySlotContentProps::mObjectSize;
Header file:	#include "ara/crypto/keys/key_slot_content_props.h"
Description:	Actual size of an object currently stored to the slot.

]([RS_CRYPT_02111](#))

[SWS_CRYPT_30508]{DRAFT} [

Kind:	variable
Symbol:	mObjectType
Scope:	struct ara::crypto::keys::KeySlotContentProps
Type:	CryptoObjectType
Syntax:	CryptoObjectType ara::crypto::keys::KeySlotContentProps::mObjectType;
Header file:	#include "ara/crypto/keys/key_slot_content_props.h"
Description:	Actual type of an object stored to the slot.

]([RS_CRYPT_02111](#))

[SWS_CRYPT_30501]{DRAFT} [

Kind:	variable
Symbol:	mObjectUid
Scope:	struct ara::crypto::keys::KeySlotContentProps
Type:	CryptoObjectUid
Syntax:	CryptoObjectUid ara::crypto::keys::KeySlotContentProps::mObjectUid;
Header file:	#include "ara/crypto/keys/key_slot_content_props.h"
Description:	UID of a Crypto Object stored to the slot.

]([RS_CRYPT_02111](#))

[SWS_CRYPT_30506]{DRAFT} [

Kind:	variable
Symbol:	mContentAllowedUsage
Scope:	struct ara::crypto::keys::KeySlotContentProps
Type:	AllowedUsageFlags
Syntax:	AllowedUsageFlags ara::crypto::keys::KeySlotContentProps::mContentAllowedUsage;
Header file:	#include "ara/crypto/keys/key_slot_content_props.h"
Description:	Actual usage restriction flags of an object stored to the slot for the current "Actor".

]([RS_CRYPT_02111](#))

[SWS_CRYPT_30306]{DRAFT} [

Kind:	variable
Symbol:	mAlgId
Scope:	struct ara::crypto::keys::KeySlotPrototypeProps
Type:	CryptoAlgId
Syntax:	CryptoAlgId ara::crypto::keys::KeySlotPrototypeProps::mAlgId;
Header file:	#include "ara/crypto/keys/key_slot_prototype_props.h"
Description:	Cryptoalgorithm restriction (kAlgIdAny means without restriction). The algorithm can be specified partially: family & length, mode, padding.

] ([RS_CRYPT_02110](#))

[SWS_CRYPT_30309]{DRAFT} [

Kind:	variable
Symbol:	mAllocateSpareSlot
Scope:	struct ara::crypto::keys::KeySlotPrototypeProps
Type:	bool
Syntax:	bool ara::crypto::keys::KeySlotPrototypeProps::mAllocateSpareSlot;
Header file:	#include "ara/crypto/keys/key_slot_prototype_props.h"
Description:	Indicates whether FC Crypto shall allocate sufficient storage space for a shadow copy of this KeySlot.

] ([RS_CRYPT_02110](#))

[SWS_CRYPT_30310]{DRAFT} [

Kind:	variable
Symbol:	mAllowContentTypeChange
Scope:	struct ara::crypto::keys::KeySlotPrototypeProps
Type:	bool
Syntax:	bool ara::crypto::keys::KeySlotPrototypeProps::mAllowContentTypeChange;
Header file:	#include "ara/crypto/keys/key_slot_prototype_props.h"
Description:	Indicates whether the content of this key-slot may be changed, e.g. from storing a symmetric key to storing an RSA key. If this is set to false, then the mObjectType of this KeySlotPrototype Props must be a) valid and b) cannot be changed (i.e. only objects of mObjectType may be stored in this key-slot).

] ([RS_CRYPT_02110](#))

[SWS_CRYPT_30313]{DRAFT} [

Kind:	variable
Symbol:	mContentAllowedUsage
Scope:	struct ara::crypto::keys::KeySlotPrototypeProps
Type:	AllowedUsageFlags
Syntax:	AllowedUsageFlags ara::crypto::keys::KeySlotPrototypeProps::mContentAllowedUsage;
Header file:	#include "ara/crypto/keys/key_slot_prototype_props.h"





Description:	<p>Indicates how the content may be used. The following use cases of this attribute are considered:</p> <p>the object to be stored in this key-slot has it's AllowedUsageFlags set to kAllowPrototypedOnly. In this case this attribute must be observed when loading the content into a runtime instance (e.g. the AllowedUsageFlags of a SymmetricKey object should be set according to this attribute) mMaxUpdatesAllowed==0, in this case the content is provided during production while the AllowedUsageFlags is modeled using this attribute when this key-slot is flexibly updated the runtime object's AllowedUsageFlags override this attribute upon a later loading from this key-slot</p>
---------------------	---

](RS_CRYPT_02110)

[SWS_CRYPT_30312]{DRAFT} [

Kind:	variable
Symbol:	mExportAllowed
Scope:	struct ara::crypto::keys::KeySlotPrototypeProps
Type:	bool
Syntax:	bool ara::crypto::keys::KeySlotPrototypeProps::mExportAllowed;
Header file:	#include "ara/crypto/keys/key_slot_prototype_props.h"
Description:	Indicates whether the key-slot content may be exported.

](RS_CRYPT_02110)

[SWS_CRYPT_30311]{DRAFT} [

Kind:	variable
Symbol:	mMaxUpdateAllowed
Scope:	struct ara::crypto::keys::KeySlotPrototypeProps
Type:	std::int32_t
Syntax:	std::int32_t ara::crypto::keys::KeySlotPrototypeProps::mMaxUpdateAllowed;
Header file:	#include "ara/crypto/keys/key_slot_prototype_props.h"
Description:	<p>Specifies how many times this key-slot may be updated, e.g.:</p> <p>a value of 0 means the key-slot content will be pre-set during production a value of 1 means the key-slot content can be updated only once ("OTP") a negative value means the key-slot content can be updated infinitely</p>

](RS_CRYPT_02110)

[SWS_CRYPT_30305]{DRAFT} [

Kind:	variable
Symbol:	mSlotType
Scope:	struct ara::crypto::keys::KeySlotPrototypeProps
Type:	KeySlotType
Syntax:	KeySlotType ara::crypto::keys::KeySlotPrototypeProps::mSlotType;
Header file:	#include "ara/crypto/keys/key_slot_prototype_props.h"





Description:	Key-slot type configuration: all key-slots used by the adaptive machine to provide services such as secure communication, diagnostics, updates, secure storage etc. shall use the type kMachine. All key-slots that will be used by the adaptive user application must use kApplication. A key-manager user application may define kMachine key-slots as well; in this case the integrator must match a corresponding machine key-slot to be managed.
---------------------	---

](RS_CRYPT_02110)

[SWS_CRYPT_30307]{DRAFT} [

Kind:	variable
Symbol:	mSlotCapacity
Scope:	struct ara::crypto::keys::KeySlotPrototypeProps
Type:	std::size_t
Syntax:	std::size_t ara::crypto::keys::KeySlotPrototypeProps::mSlotCapacity;
Header file:	#include "ara/crypto/keys/key_slot_prototype_props.h"
Description:	Capacity of the slot in bytes.

](RS_CRYPT_02110)

[SWS_CRYPT_30308]{DRAFT} [

Kind:	variable
Symbol:	mObjectType
Scope:	struct ara::crypto::keys::KeySlotPrototypeProps
Type:	CryptoObjectType
Syntax:	CryptoObjectType ara::crypto::keys::KeySlotPrototypeProps::mObjectType;
Header file:	#include "ara/crypto/keys/key_slot_prototype_props.h"
Description:	Restriction of an object type that can be stored the slot. If this field contains CryptoObjectType::kUnknown then without restriction of the type.

](RS_CRYPT_02110)

8.3 C++ language binding X509 Certificate Management Provider

[SWS_CRYPT_40100]{DRAFT} [

Kind:	class
Symbol:	BasicCertInfo
Scope:	namespace ara::crypto::x509
Base class:	X509Object
Syntax:	class ara::crypto::x509::BasicCertInfo : public X509Object {...};
Header file:	#include "ara/crypto/x509/basic_cert_info.h"
Description:	Basic Certificate Information interface.

](RS_CRYPT_02306)

[SWS_CRYPT_40200]{DRAFT} [

Kind:	class
Symbol:	Certificate
Scope:	namespace ara::crypto::x509
Base class:	BasicCertInfo
Syntax:	<code>class ara::crypto::x509::Certificate : public BasicCertInfo {...};</code>
Header file:	<code>#include "ara/crypto/x509/certificate.h"</code>
Description:	X.509 Certificate interface.

]([RS_CRYPT_02306](#))

[SWS_CRYPT_40300]{DRAFT} [

Kind:	class
Symbol:	CertSignRequest
Scope:	namespace ara::crypto::x509
Base class:	BasicCertInfo
Syntax:	<code>class ara::crypto::x509::CertSignRequest : public BasicCertInfo {...};</code>
Header file:	<code>#include "ara/crypto/x509/cert_sign_request.h"</code>
Description:	Certificate Signing Request (CSR) object interface This interface is dedicated for complete parsing of the request content.

]([RS_CRYPT_02306](#))

[SWS_CRYPT_40700]{DRAFT} [

Kind:	class
Symbol:	OcspRequest
Scope:	namespace ara::crypto::x509
Base class:	X509Object
Syntax:	<code>class ara::crypto::x509::OcspRequest : public X509Object {...};</code>
Header file:	<code>#include "ara/crypto/x509/ocsp_request.h"</code>
Description:	On-line Certificate Status Protocol Request.

]([RS_CRYPT_02306](#))

[SWS_CRYPT_40800]{DRAFT} [

Kind:	class
Symbol:	OcspResponse
Scope:	namespace ara::crypto::x509
Base class:	X509Object
Syntax:	<code>class ara::crypto::x509::OcspResponse : public X509Object {...};</code>
Header file:	<code>#include "ara/crypto/x509/ocsp_response.h"</code>
Description:	On-line Certificate Status Protocol Response.

]([RS_CRYPT_02306](#))

[SWS_CRYPT_24400]{DRAFT} [

Kind:	class
Symbol:	X509PublicKeyInfo
Scope:	namespace ara::crypto::x509
Base class:	ara::crypto::Serializable
Syntax:	<pre>class ara::crypto::x509::X509PublicKeyInfo : public ara::crypto::Serializable {...};</pre>
Header file:	#include "ara/crypto/x509/x509_public_key_info.h"
Description:	X.509 Public Key Information interface.

]([RS_CRYPT_02307](#))

[SWS_CRYPT_40400]{DRAFT} [

Kind:	class
Symbol:	X509DN
Scope:	namespace ara::crypto::x509
Base class:	X509Object
Syntax:	<pre>class ara::crypto::x509::X509DN : public X509Object {...};</pre>
Header file:	#include "ara/crypto/x509/x509_dn.h"
Description:	Interface of X.509 Distinguished Name (DN).

]([RS_CRYPT_02306](#))

[SWS_CRYPT_40500]{DRAFT} [

Kind:	class
Symbol:	X509Extensions
Scope:	namespace ara::crypto::x509
Base class:	X509Object
Syntax:	<pre>class ara::crypto::x509::X509Extensions : public X509Object {...};</pre>
Header file:	#include "ara/crypto/x509/x509_extensions.h"
Description:	Interface of X.509 Extensions.

]([RS_CRYPT_02306](#))

[SWS_CRYPT_40900]{DRAFT} [

Kind:	class
Symbol:	X509Object
Scope:	namespace ara::crypto::x509
Base class:	ara::crypto::Serializable
Syntax:	<pre>class ara::crypto::x509::X509Object : public ara::crypto::Serializable {...};</pre>
Header file:	#include "ara/crypto/x509/x509_object.h"
Description:	Common interface of all objects created by X.509 Provider.

]([RS_CRYPT_02306](#))

[SWS_CRYPT_40600]{DRAFT} [

Kind:	class
Symbol:	X509Provider
Scope:	namespace ara::crypto::x509
Syntax:	<code>class ara::crypto::x509::X509Provider {...};</code>
Header file:	<code>#include "ara/crypto/x509/x509_provider.h"</code>
Description:	X.509 Provider interface. The X.509 Provider supports two internal storages: volatile (or session) and persistent. All X.509 objects created by the provider should have an actual reference to their parent X.509 Provider. The X.509 Provider can be destroyed only after destroying of all its daughterly objects. Each method of this interface that creates a X.509 object is non-constant, because any such creation increases a references counter of the X.509 Provider.

] ([RS_CRYPT_02306](#))

[SWS_CRYPT_40932]{DRAFT} [

Kind:	class
Symbol:	X509CustomExtensionsParser
Scope:	namespace ara::crypto::x509
Syntax:	<code>class ara::crypto::x509::X509CustomExtensionsParser {...};</code>
Header file:	<code>#include "ara/crypto/x509/x509_custom_extension_parser.h"</code>
Description:	X.509 custom extensions parser Callback class to be implemented by user. Implemented functions get called by X509Provider::ParseCustomCertExtensions when parsing a certificate. If any function of this class returns an error, the parsing will stop.

] ([RS_CRYPT_02306](#))

[SWS_CRYPT_24414]{DRAFT} [

Kind:	function		
Symbol:	GetPublicKey()		
Scope:	<code>class ara::crypto::x509::X509PublicKeyInfo</code>		
Syntax:	<code>virtual ara::core::Result<ara::crypto::crypt::PublicKey::Uptrc> ara::crypto::x509::X509PublicKeyInfo::GetPublicKey () const noexcept=0;</code>		
Return value:	<table border="1" style="width: 100%;"> <tr> <td style="width: 50%;"><code>ara::core::Result< ara::crypto::crypt::PublicKey::Uptrc ></code></td> <td>unique smart pointer to the created public key of the subject</td> </tr> </table>	<code>ara::core::Result< ara::crypto::crypt::PublicKey::Uptrc ></code>	unique smart pointer to the created public key of the subject
<code>ara::core::Result< ara::crypto::crypt::PublicKey::Uptrc ></code>	unique smart pointer to the created public key of the subject		
Exception Safety:	noexcept		
Thread Safety:	Thread-safe		
Header file:	<code>#include "ara/crypto/x509/x509_public_key_info.h"</code>		
Description:	Get public key object of the subject. Created PublicKey object is session and non-exportable, because generic X.509 certificate or certificate signing request (CSR) doesn't have COUID of the public key, therefore it should be saved or transmitted only as a part of correspondent certificate or CSR.		

] ([RS_CRYPT_02108](#), [RS_CRYPT_02306](#))

[SWS_CRYPT_24412]{DRAFT} [

Kind:	function	
Symbol:	GetRequiredHashAlgId()	
Scope:	class ara::crypto::x509::X509PublicKeyInfo	
Syntax:	virtual CryptoAlgId ara::crypto::x509::X509PublicKeyInfo::GetRequiredHashAlgId () const noexcept=0;	
Return value:	CryptoAlgId	required hash algorithm ID or kAlgIdAny if the signature algorithm specification does not include a concrete hash function
Exception Safety:	noexcept	
Thread Safety:	Thread-safe	
Header file:	#include "ara/crypto/x509/x509_public_key_info.h"	
Description:	Get an ID of hash algorithm required by current signature algorithm.	

]([RS_CRYPT_02309](#))

[SWS_CRYPT_24411]{DRAFT} [

Kind:	function	
Symbol:	GetRequiredHashSize()	
Scope:	class ara::crypto::x509::X509PublicKeyInfo	
Syntax:	virtual std::size_t ara::crypto::x509::X509PublicKeyInfo::GetRequiredHashSize () const noexcept=0;	
Return value:	std::size_t	required hash size in bytes
Exception Safety:	noexcept	
Header file:	#include "ara/crypto/x509/x509_public_key_info.h"	
Description:	Get the hash size required by current signature algorithm.	

]([RS_CRYPT_02309](#))

[SWS_CRYPT_24413]{DRAFT} [

Kind:	function	
Symbol:	GetSignatureSize()	
Scope:	class ara::crypto::x509::X509PublicKeyInfo	
Syntax:	virtual std::size_t ara::crypto::x509::X509PublicKeyInfo::GetSignatureSize () const noexcept=0;	
Return value:	std::size_t	size of the signature value in bytes
Exception Safety:	noexcept	
Thread Safety:	Thread-safe	
Header file:	#include "ara/crypto/x509/x509_public_key_info.h"	
Description:	Get size of the signature value produced and required by the current algorithm.	

]([RS_CRYPT_02309](#))

[SWS_CRYPT_24410]{DRAFT} [

Kind:	function	
Symbol:	GetAlgorithmId()	
Scope:	class ara::crypto::x509::X509PublicKeyInfo	
Syntax:	virtual ara::crypto::crypt::CryptoPrimitiveId::Uptrc ara::crypto::x509::X509PublicKeyInfo::GetAlgorithmId ()=0;	
Return value:	ara::crypto::crypt::CryptoPrimitive Id::Uptrc	–
Header file:	#include "ara/crypto/x509/x509_public_key_info.h"	
Description:	Get the CryptoPrimitiveId instance of this class.	

] ([RS_CRYPT_02307](#))

[SWS_CRYPT_24415]{DRAFT} [

Kind:	function	
Symbol:	IsSameKey(const ara::crypto::crypt::PublicKey &publicKey)	
Scope:	class ara::crypto::x509::X509PublicKeyInfo	
Syntax:	virtual bool ara::crypto::x509::X509PublicKeyInfo::IsSameKey (const ara::crypto::crypt::PublicKey &publicKey) const noexcept=0;	
Parameters (in):	publicKey	the public key object for comparison
Return value:	bool	true if values of the stored public key and object provided by the argument are identical and false otherwise
Exception Safety:	noexcept	
Thread Safety:	Thread-safe	
Header file:	#include "ara/crypto/x509/x509_public_key_info.h"	
Description:	Verify the sameness of the provided and kept public keys. This method compare the public key values only.	

] ([RS_CRYPT_02306](#))

[SWS_CRYPT_40115]{DRAFT} [

Kind:	function	
Symbol:	GetConstraints()	
Scope:	class ara::crypto::x509::BasicCertInfo	
Syntax:	virtual KeyConstraints ara::crypto::x509::BasicCertInfo::Get Constraints () const noexcept=0;	
Return value:	KeyConstraints	key constraints
Exception Safety:	noexcept	
Thread Safety:	Thread-safe	
Header file:	#include "ara/crypto/x509/basic_cert_info.h"	
Description:	Get the key constraints for the key associated with this PKCS#10 object.	

] ([RS_CRYPT_02306](#))

[SWS_CRYPT_40114]{DRAFT} [

Kind:	function	
Symbol:	GetPathLimit()	
Scope:	class ara::crypto::x509::BasicCertInfo	
Syntax:	virtual std::uint32_t ara::crypto::x509::BasicCertInfo::GetPathLimit () const noexcept=0;	
Return value:	std::uint32_t	certification path length limit
Exception Safety:	noexcept	
Thread Safety:	Thread-safe	
Header file:	#include "ara/crypto/x509/basic_cert_info.h"	
Description:	Get the constraint on the path length defined in the Basic Constraints extension.	

] ([RS_CRYPT_02306](#))

[SWS_CRYPT_40113]{DRAFT} [

Kind:	function	
Symbol:	IsCa()	
Scope:	class ara::crypto::x509::BasicCertInfo	
Syntax:	virtual bool ara::crypto::x509::BasicCertInfo::IsCa () const noexcept=0;	
Return value:	bool	true if it is a CA request and false otherwise
Exception Safety:	noexcept	
Thread Safety:	Thread-safe	
Header file:	#include "ara/crypto/x509/basic_cert_info.h"	
Description:	Check whether the CA attribute of X509v3 Basic Constraints is true (i.e. pathlen=0).	

] ([RS_CRYPT_02306](#))

[SWS_CRYPT_40112]{DRAFT} [

Kind:	function	
Symbol:	SubjectDn()	
Scope:	class ara::crypto::x509::BasicCertInfo	
Syntax:	virtual const X509DN& ara::crypto::x509::BasicCertInfo::SubjectDn () const noexcept=0;	
Return value:	const X509DN &	subject DN
Exception Safety:	noexcept	
Thread Safety:	Thread-safe	
Header file:	#include "ara/crypto/x509/basic_cert_info.h"	
Description:	Get the subject DN.	

] ([RS_CRYPT_02306](#))

[SWS_CRYPT_40111]{DRAFT} [

Kind:	function	
Symbol:	SubjectPubKey(cryp::CryptoProvider::Uptr cryptoProvider=nullptr)	
Scope:	class ara::crypto::x509::BasicCertInfo	
Syntax:	virtual const X509PublicKeyInfo& ara::crypto::x509::BasicCertInfo::SubjectPubKey (cryp::CryptoProvider::Uptr cryptoProvider=nullptr) const noexcept=0;	
Parameters (in):	cryptoProvider	unique pointer of a target Crypto Provider, where the public key will be used
Return value:	const X509PublicKeyInfo &	constant reference of the subject public key interface
Exception Safety:	noexcept	
Thread Safety:	Thread-safe	
Header file:	#include "ara/crypto/x509/basic_cert_info.h"	
Description:	Load the subject public key information object to realm of specified crypto provider. If (cryptoProvider == nullptr) then X509PublicKeyInfo object will be loaded in realm of the Stack-default Crypto Provider.	

] ([RS_CRYPT_02306](#))

[SWS_CRYPT_40217]{DRAFT} [

Kind:	function	
Symbol:	AuthorityKeyId()	
Scope:	class ara::crypto::x509::Certificate	
Syntax:	virtual ara::core::Result<ara::core::Vector<ara::core::Byte> > ara::crypto::x509::Certificate::AuthorityKeyId () const noexcept=0;	
Return value:	ara::core::Result< ara::core::Vector< ara::core::Byte > >	size of the DER encoded AuthorityKeyIdentifier in bytes
Exception Safety:	noexcept	
Thread Safety:	Thread-safe	
Errors:	CryptoErrorDomain::kInsufficientCapacity	if (id.empty() == false), but its size is not enough for storing the output value
Header file:	#include "ara/crypto/x509/certificate.h"	
Description:	Get the DER encoded AuthorityKeyIdentifier of this certificate. If (id.empty() == true) then this method only returns required size of the output buffer.	

] ([RS_CRYPT_02306](#))

[SWS_CRYPT_40215]{DRAFT} [

Kind:	function	
Symbol:	EndTime()	
Scope:	class ara::crypto::x509::Certificate	
Syntax:	virtual time_t ara::crypto::x509::Certificate::EndTime () const noexcept=0;	
Return value:	time_t	"Not After" of the certificate
Exception Safety:	noexcept	
Thread Safety:	Thread-safe	
Header file:	#include "ara/crypto/x509/certificate.h"	
Description:	Get the "Not After" of the certificate.	

] ([RS_CRYPT_02306](#))

[SWS_CRYPT_40220]{DRAFT} [

Kind:	function	
Symbol:	GetFingerprint(ReadWriteMemRegion fingerprint, cryp::HashFunctionCtx &hashCtx)	
Scope:	class ara::crypto::x509::Certificate	
Syntax:	virtual ara::core::Result<std::size_t> ara::crypto::x509::Certificate::GetFingerprint (ReadWriteMemRegion fingerprint, cryp::HashFunctionCtx &hashCtx) const noexcept=0;	
Parameters (in):	hashCtx	an initialized hash function context
Parameters (out):	fingerprint	output buffer for the fingerprint storage
Return value:	ara::core::Result< std::size_t >	number of bytes actually saved to the output buffer
Exception Safety:	noexcept	
Thread Safety:	Thread-safe	
Errors:	CryptoErrorDomain::kIncompleteArg State	if the hashCtx context is not initialized
Header file:	#include "ara/crypto/x509/certificate.h"	
Description:	Calculate a fingerprint from the whole certificate. The produced fingerprint value saved to the output buffer starting from leading bytes of the hash value. If the capacity of the output buffer is less than the digest size then the digest will be truncated and only leading bytes will be saved. If the capacity of the output buffer is higher than the digest size then only leading bytes of the buffer will be updated.	

] ([RS_CRYPT_02306](#))

[SWS_CRYPT_40221]{DRAFT} [

Kind:	function	
Symbol:	GetStatus()	
Scope:	class ara::crypto::x509::Certificate	
Syntax:	virtual Status ara::crypto::x509::Certificate::GetStatus () const noexcept=0;	
Return value:	Status	the certificate verification status
Exception Safety:	noexcept	
Thread Safety:	Thread-safe	
Header file:	#include "ara/crypto/x509/certificate.h"	
Description:	Return last verification status of the certificate.	

] ([RS_CRYPT_02306](#))

[SWS_CRYPT_40212]{DRAFT} [

Kind:	function	
Symbol:	IsRoot()	
Scope:	class ara::crypto::x509::Certificate	
Syntax:	virtual bool ara::crypto::x509::Certificate::IsRoot () const noexcept=0;	
Return value:	bool	true if the TrustMaster has set this certificate as root
Exception Safety:	noexcept	
Thread Safety:	Thread-safe	
Header file:	#include "ara/crypto/x509/certificate.h"	
Description:	Check whether this certificate belongs to a root CA.	

] ([RS_CRYPT_02306](#))

[SWS_CRYPT_40213]{DRAFT} [

Kind:	function	
Symbol:	IssuerDn()	
Scope:	class ara::crypto::x509::Certificate	
Syntax:	virtual const X509DN& ara::crypto::x509::Certificate::IssuerDn () const =0;	
Return value:	const X509DN &	Issuer DN of this certificate
Thread Safety:	Thread-safe	
Header file:	#include "ara/crypto/x509/certificate.h"	
Description:	Get the issuer certificate DN.	

]([RS_CRYPT_02306](#))

[SWS_CRYPT_40216]{DRAFT} [

Kind:	function	
Symbol:	SerialNumber()	
Scope:	class ara::crypto::x509::Certificate	
Syntax:	virtual ara::core::Result<ara::core::Vector<ara::core::Byte> > ara::crypto::x509::Certificate::SerialNumber () const noexcept=0;	
Return value:	ara::core::Result< ara::core::Vector< ara::core::Byte > >	size of the certificate serial number in bytes
Exception Safety:	noexcept	
Thread Safety:	Thread-safe	
Errors:	CryptoErrorDomain:kInsufficient Capacity	if (sn.empty() == false), but its size is not enough for storing the output value
Header file:	#include "ara/crypto/x509/certificate.h"	
Description:	Get the serial number of this certificate. If (sn.empty() == true) then this method only returns required size of the output buffer.	

]([RS_CRYPT_02306](#))

[SWS_CRYPT_40214]{DRAFT} [

Kind:	function	
Symbol:	StartTime()	
Scope:	class ara::crypto::x509::Certificate	
Syntax:	virtual time_t ara::crypto::x509::Certificate::StartTime () const noexcept=0;	
Return value:	time_t	"Not Before" of the certificate
Exception Safety:	noexcept	
Thread Safety:	Thread-safe	
Header file:	#include "ara/crypto/x509/certificate.h"	
Description:	Get the "Not Before" of the certificate.	

]([RS_CRYPT_02306](#))

[SWS_CRYPT_40218]{DRAFT} [

Kind:	function	
Symbol:	SubjectKeyId()	
Scope:	class ara::crypto::x509::Certificate	
Syntax:	virtual ara::core::Result<ara::core::Vector<ara::core::Byte> > ara::crypto::x509::Certificate::SubjectKeyId () const noexcept=0;	
Return value:	ara::core::Result< ara::core::Vector< ara::core::Byte > >	size of the DER encoded SubjectKeyIdentifier in bytes
Exception Safety:	noexcept	
Thread Safety:	Thread-safe	
Errors:	CryptoErrorDomain::kInsufficient Capacity	if (id.empty() == false), but its size is not enough for storing the output value
Header file:	#include "ara/crypto/x509/certificate.h"	
Description:	Get the DER encoded SubjectKeyIdentifier of this certificate. If (id.empty() == true) then this method only returns required size of the output buffer.	

] ([RS_CRYPT_02306](#))

[SWS_CRYPT_40219]{DRAFT} [

Kind:	function	
Symbol:	VerifyMe(ara::core::Optional< const Certificate::Uptr > caCert)	
Scope:	class ara::crypto::x509::Certificate	
Syntax:	virtual bool ara::crypto::x509::Certificate::VerifyMe (ara::core::Optional< const Certificate::Uptr > caCert) const noexcept=0;	
Parameters (in):	caCert	the optional pointer to a Certification Authority certificate used for signature of the current one
Return value:	bool	true if this certificate was verified successfully and false otherwise
Exception Safety:	noexcept	
Thread Safety:	Thread-safe	
Header file:	#include "ara/crypto/x509/certificate.h"	
Description:	Verify signature of the certificate. Call with (caCert == nullptr) is applicable only if this is a certificate of a root CA.	

] ([RS_CRYPT_02306](#))

[SWS_CRYPT_40211]{DRAFT} [

Kind:	function	
Symbol:	X509Version()	
Scope:	class ara::crypto::x509::Certificate	
Syntax:	virtual std::uint32_t ara::crypto::x509::Certificate::X509Version () const noexcept=0;	
Return value:	std::uint32_t	X.509 version
Exception Safety:	noexcept	
Thread Safety:	Thread-safe	
Header file:	#include "ara/crypto/x509/certificate.h"	
Description:	Get the X.509 version of this certificate object.	

] ([RS_CRYPT_02306](#))

[SWS_CRYPT_40311]{DRAFT} [

Kind:	function	
Symbol:	Verify()	
Scope:	class ara::crypto::x509::CertSignRequest	
Syntax:	virtual bool ara::crypto::x509::CertSignRequest::Verify () const noexcept=0;	
Return value:	bool	true if the signature is correct
Exception Safety:	noexcept	
Thread Safety:	Thread-safe	
Header file:	#include "ara/crypto/x509/cert_sign_request.h"	
Description:	Verifies self-signed signature of the certificate request.	

] ([RS_CRYPT_02306](#))

[SWS_CRYPT_40313]{DRAFT} [

Kind:	function	
Symbol:	ExportASN1CertSignRequest()	
Scope:	class ara::crypto::x509::CertSignRequest	
Syntax:	virtual ara::core::Result<ara::core::Vector<ara::core::Byte> > ara::crypto::x509::CertSignRequest::ExportASN1CertSignRequest () noexcept=0;	
Return value:	ara::core::Result< ara::core::Vector< ara::core::Byte > >	a buffer with the formatted CSR
Exception Safety:	noexcept	
Thread Safety:	Thread-safe	
Errors:	CryptoErrorDomain::kInvalidUsage Order	this error will be returned in case not all required information has been provided
Header file:	#include "ara/crypto/x509/cert_sign_request.h"	
Description:	Export this certificate signing request in DER encoded ASN1 format. Note: this is the CSR that can be sent to the CA for obtaining the certificate.	

] ([RS_CRYPT_02306](#))

[SWS_CRYPT_40315]{DRAFT} [

Kind:	function	
Symbol:	GetSignature()	
Scope:	class ara::crypto::x509::CertSignRequest	
Syntax:	virtual const ara::crypto::cryp::Signature& ara::crypto::x509::CertSignRequest::GetSignature () const noexcept=0;	
Return value:	const ara::crypto::cryp::Signature &	signature object of the request
Exception Safety:	noexcept	
Thread Safety:	Thread-safe	
Header file:	#include "ara/crypto/x509/cert_sign_request.h"	
Description:	Return signature object of the request.	

] ([RS_CRYPT_02306](#))

[SWS_CRYPT_40314]{DRAFT} [

Kind:	function
Symbol:	Version()
Scope:	class ara::crypto::x509::CertSignRequest
Syntax:	<code>virtual unsigned ara::crypto::x509::CertSignRequest::Version () const noexcept=0;</code>
Return value:	unsigned format version of the certificate request
Exception Safety:	noexcept
Thread Safety:	Thread-safe
Header file:	<code>#include "ara/crypto/x509/cert_sign_request.h"</code>
Description:	Return format version of the certificate request.

]([RS_CRYPT_02306](#))

[SWS_CRYPT_40711]{DRAFT} [

Kind:	function
Symbol:	Version()
Scope:	class ara::crypto::x509::OcspRequest
Syntax:	<code>virtual std::uint32_t ara::crypto::x509::OcspRequest::Version () const noexcept=0;</code>
Return value:	std::uint32_t OCSP request format version
Exception Safety:	noexcept
Thread Safety:	Thread-safe
Header file:	<code>#include "ara/crypto/x509/ocsp_request.h"</code>
Description:	Get version of the OCSP request format.

]([RS_CRYPT_02306](#))

[SWS_CRYPT_40811]{DRAFT} [

Kind:	function
Symbol:	Version()
Scope:	class ara::crypto::x509::OcspResponse
Syntax:	<code>virtual std::uint32_t ara::crypto::x509::OcspResponse::Version () const noexcept=0;</code>
Return value:	std::uint32_t OCSP response format version
Exception Safety:	noexcept
Thread Safety:	Thread-safe
Header file:	<code>#include "ara/crypto/x509/ocsp_response.h"</code>
Description:	Get version of the OCSP response format.

]([RS_CRYPT_02306](#))

[SWS_CRYPT_40413]{DRAFT} [

Kind:	function	
Symbol:	GetAttribute(Attributeld id)	
Scope:	class ara::crypto::x509::X509DN	
Syntax:	virtual ara::core::Result<ara::core::String> ara::crypto::x509::X509DN::GetAttribute (AttributeId id) const noexcept=0;	
Parameters (in):	id	the identifier of required attribute
Return value:	ara::core::Result< ara::core::String >	String of the attribute
Exception Safety:	noexcept	
Thread Safety:	Thread-safe	
Errors:	CryptoErrorDomain::kUnknown Identifier	if the id argument has unsupported value
	CryptoErrorDomain::kInsufficient Capacity	if (attribute != nullptr), but attribute->capacity() is less than required for storing of the output
Header file:	#include "ara/crypto/x509/x509_dn.h"	
Description:	Get DN attribute by its ID (this method is applicale to all attributes except kOrgUnit and kDomainComponent). Capacity of the output string must be enough for storing the output value! If (attribute == nullptr) then method only returns required buffer capacity.	

] ([RS_CRYPT_02306](#))

[SWS_CRYPT_40415]{DRAFT} [

Kind:	function	
Symbol:	GetAttribute(Attributeld id, unsigned index)	
Scope:	class ara::crypto::x509::X509DN	
Syntax:	virtual ara::core::Result<ara::core::String> ara::crypto::x509::X509DN::GetAttribute (AttributeId id, unsigned index) const noexcept=0;	
Parameters (in):	id	the identifier of required attribute
	index	the zero-based index of required component of the attribute
Return value:	ara::core::Result< ara::core::String >	String of the attribute
Exception Safety:	noexcept	
Thread Safety:	Thread-safe	
Errors:	CryptoErrorDomain::kUnknown Identifier	if the id argument has unsupported value
	CryptoErrorDomain::kInsufficient Capacity	if (attribute != nullptr), but attribute->capacity() is less than required for storing of the output
	CryptoErrorDomain::kInvalidArgument	if (id != kOrgUnit) && (id != kDomainComponent) && (index > 0)
	CryptoErrorDomain::kAboveBoundary	if ((id == kOrgUnit) (id == kDomainComponent)) and the index value is greater than or equal to the actual number of components in the specified attribute
Header file:	#include "ara/crypto/x509/x509_dn.h"	
Description:	Return DN attribute by its ID and sequential index (this method is applicale to attributes kOrgUnit and kDomainComponent). Capacity of the output string must be enough for storing the output value! If (attribute == nullptr) then method only returns required buffer capacity.	

] ([RS_CRYPT_02306](#))

[SWS_CRYPT_40411]{DRAFT} [

Kind:	function	
Symbol:	GetDnString()	
Scope:	class ara::crypto::x509::X509DN	
Syntax:	virtual ara::core::Result<ara::core::String> ara::crypto::x509::X509DN::GetDnString () const noexcept=0;	
Return value:	ara::core::Result< ara::core::String >	String of the whole DN string
Exception Safety:	noexcept	
Thread Safety:	Thread-safe	
Errors:	CryptoErrorDomain::kInsufficient Capacity	if (dn != nullptr), but dn->capacity() is less than required for the output value storing
Header file:	#include "ara/crypto/x509/x509_dn.h"	
Description:	Get the whole Distinguished Name (DN) as a single string. Capacity of the output string must be enough for storing the output value! If (dn == nullptr) then method only returns required buffer capacity.	

] ([RS_CRYPT_02306](#))

[SWS_CRYPT_40417]{DRAFT} [

Kind:	function	
Symbol:	operator==(const X509DN &other)	
Scope:	class ara::crypto::x509::X509DN	
Syntax:	virtual bool ara::crypto::x509::X509DN::operator== (const X509DN &other) const noexcept=0;	
Parameters (in):	other	another instance of DN for comparison
Return value:	bool	true if the provided DN is identical to this one and false otherwise
Exception Safety:	noexcept	
Thread Safety:	Thread-safe	
Header file:	#include "ara/crypto/x509/x509_dn.h"	
Description:	Check for equality of this and another Distinguished Name (DN) objects.	

] ([RS_CRYPT_02306](#))

[SWS_CRYPT_40418]{DRAFT} [

Kind:	function	
Symbol:	operator!=(const X509DN &other)	
Scope:	class ara::crypto::x509::X509DN	
Syntax:	bool ara::crypto::x509::X509DN::operator!= (const X509DN &other) const noexcept;	
Parameters (in):	other	another instance of DN for comparison
Return value:	bool	true if the provided DN is not identical to this one and false otherwise
Exception Safety:	noexcept	
Thread Safety:	Thread-safe	
Header file:	#include "ara/crypto/x509/x509_dn.h"	
Description:	Check for inequality of this and another Distinguished Name (DN) objects.	

] ([RS_CRYPT_02306](#))

[SWS_CRYPT_40414]{DRAFT} [

Kind:	function	
Symbol:	SetAttribute(AttributeId id, ara::core::StringView attribute)	
Scope:	class ara::crypto::x509::X509DN	
Syntax:	virtual ara::core::Result<void> ara::crypto::x509::X509DN::SetAttribute (AttributeId id, ara::core::StringView attribute) noexcept=0;	
Parameters (in):	id	the identifier of required attributet
	attribute	the attribute value
Return value:	ara::core::Result< void >	–
Exception Safety:	noexcept	
Thread Safety:	Thread-safe	
Errors:	CryptoErrorDomain::kUnknown Identifier	if the id argument has unsupported value
	CryptoErrorDomain::kUnexpected Value	if the attribute string contains incorrect characters or it has unsupported length
Header file:	#include "ara/crypto/x509/x509_dn.h"	
Description:	Set DN attribute by its ID (this method is applicale to all attributes except kOrgUnit and kDomainComponent).	

] ([RS_CRYPTO_02306](#))

[SWS_CRYPT_40416]{DRAFT} [

Kind:	function	
Symbol:	SetAttribute(AttributeId id, unsigned index, ara::core::StringView attribute)	
Scope:	class ara::crypto::x509::X509DN	
Syntax:	virtual ara::core::Result<void> ara::crypto::x509::X509DN::SetAttribute (AttributeId id, unsigned index, ara::core::StringView attribute) noexcept=0;	
Parameters (in):	id	the identifier of required attribute
	index	the zero-based index of required component of the attribute
	attribute	the attribute value
Return value:	ara::core::Result< void >	–
Exception Safety:	noexcept	
Thread Safety:	Thread-safe	
Errors:	CryptoErrorDomain::kUnknown Identifier	if the id argument has unsupported value
	CryptoErrorDomain::kUnexpected Value	if the attribute string contains incorrect characters or it has unsupported length
	CryptoErrorDomain::kInvalidArgument	if ((id != kOrgUnit) && (id != kDomainComponent) && (index > 0))
	CryptoErrorDomain::kAboveBoundary	if ((id == kOrgUnit) (id == kDomainComponent)) and the index value is greater than the current number of components in the specified attribute
Header file:	#include "ara/crypto/x509/x509_dn.h"	
Description:	Set DN attribute by its ID and sequential index (this method is applicale to attributes kOrgUnit and kDomainComponent).	

] ([RS_CRYPTO_02306](#))

[SWS_CRYPT_40412]{DRAFT} [

Kind:	function	
Symbol:	SetDn(ara::core::StringView dn)	
Scope:	class ara::crypto::x509::X509DN	
Syntax:	virtual ara::core::Result<void> ara::crypto::x509::X509DN::SetDn (ara::core::StringView dn) noexcept=0;	
Parameters (in):	dn	the single string containing the whole DN value in text format
Return value:	ara::core::Result< void >	–
Exception Safety:	noexcept	
Thread Safety:	Thread-safe	
Header file:	#include "ara/crypto/x509/x509_dn.h"	
Description:	Set whole Distinguished Name (DN) from a single string. [Error]: CryptoErrorDomain::kUnexpectedValue if the dn string has incorrect syntax.	

]([RS_CRYPT_02306](#))

[SWS_CRYPT_40511]{DRAFT} [

Kind:	function	
Symbol:	Count()	
Scope:	class ara::crypto::x509::X509Extensions	
Syntax:	virtual std::size_t ara::crypto::x509::X509Extensions::Count () const noexcept=0;	
Return value:	std::size_t	number of elements in the sequence
Exception Safety:	noexcept	
Thread Safety:	Thread-safe	
Header file:	#include "ara/crypto/x509/x509_extensions.h"	
Description:	Count number of elements in the sequence.	

]([RS_CRYPT_02306](#))

[SWS_CRYPT_40911]{DRAFT} [

Kind:	function	
Symbol:	MyProvider()	
Scope:	class ara::crypto::x509::X509Object	
Syntax:	virtual X509Provider& ara::crypto::x509::X509Object::MyProvider () const noexcept=0;	
Return value:	X509Provider &	a reference to X.509 Provider instance that provides this object
Exception Safety:	noexcept	
Thread Safety:	Thread-safe	
Header file:	#include "ara/crypto/x509/x509_object.h"	
Description:	Get a reference to X.509 Provider of this object.	

]([RS_CRYPT_02401](#))

[SWS_CRYPT_40612]{DRAFT} [

Kind:	function	
Symbol:	BuildDn(ara::core::StringView dn)	
Scope:	class ara::crypto::x509::X509Provider	
Syntax:	virtual ara::core::Result<X509DN::Uptrc> ara::crypto::x509::X509Provider::BuildDn (ara::core::StringView dn) noexcept=0;	
Parameters (in):	dn	string representation of the Distinguished Name
Return value:	ara::core::Result< X509DN::Uptrc >	unique smart pointer for the created X509DN object
Exception Safety:	noexcept	
Thread Safety:	Thread-safe	
Errors:	CryptoErrorDomain::kInvalidArgument	if the dn argument has incorrect format
	CryptoErrorDomain::kInvalidInputSize	if the dn argument has unsupported length (too large)
Header file:	#include "ara/crypto/x509/x509_provider.h"	
Description:	Create completed X.500 Distinguished Name structure from the provided string representation.	

]([RS_CRYPT_02306](#))

[SWS_CRYPT_40629]{DRAFT} [

Kind:	function	
Symbol:	CheckCertStatus(Certificate &cert, const OcsResponse &ocspResponse)	
Scope:	class ara::crypto::x509::X509Provider	
Syntax:	virtual ara::core::Result<bool> ara::crypto::x509::X509Provider::Check CertStatus (Certificate &cert, const OcsResponse &ocspResponse) const noexcept=0;	
Parameters (in):	cert	a certificate that should be verified
	ocspResponse	an OCSP response
Return value:	ara::core::Result< bool >	true if the certificate is verified successfully and false otherwise
Exception Safety:	noexcept	
Thread Safety:	Thread-safe	
Errors:	CryptoErrorDomain::kInvalidArgument	if the cert is invalid
	CryptoErrorDomain::kRuntimeFault	if the ocspResponse is invalid
Header file:	#include "ara/crypto/x509/x509_provider.h"	
Description:	Check certificate status by directly provided OCSP response. This method may be used for implementation of the "OCSP stapling". This method updates the Certificate::Status associated with the certificate.	

]([RS_CRYPT_02306](#))

[SWS_CRYPT_40630]{DRAFT} [

Kind:	function	
Symbol:	CheckCertStatus(const ara::core::Vector< Certificate * > &certList, const OcsResponse &ocspResponse)	
Scope:	class ara::crypto::x509::X509Provider	





Syntax:	virtual ara::core::Result<bool> ara::crypto::x509::X509Provider::CheckCertStatus (const ara::core::Vector< Certificate * > &certList, const OcsponseResponse &ocspResponse) const noexcept=0;	
Parameters (in):	certList	a certificates list that should be verified
	ocspResponse	an OCSP response
Return value:	ara::core::Result< bool >	true if the certificates list is verified successfully and false otherwise
Exception Safety:	noexcept	
Thread Safety:	Thread-safe	
Errors:	CryptoErrorDomain::kInvalidArgument	if the provided certificates are invalid
	CryptoErrorDomain::kRuntimeFault	if the ocspResponse is invalid
Header file:	#include "ara/crypto/x509/x509_provider.h"	
Description:	Check status of a certificates list by directly provided OCSP response. This method may be used for implementation of the "OCSP stapling". This method updates the Certificate::Status associated with the certificates in the list.	

]([RS_CRYPT_02306](#))

[SWS_CRYPT_40639]{DRAFT} [

Kind:	function	
Symbol:	CheckCertStatusOnline(Certificate &cert)	
Scope:	class ara::crypto::x509::X509Provider	
Syntax:	virtual ara::core::Result<Certificate::Status> ara::crypto::x509::X509Provider::CheckCertStatusOnline (Certificate &cert) noexcept=0;	
Parameters (in):	cert	a certificate that should be verified
Return value:	ara::core::Result< Certificate::Status >	certificate status This method updates the Certificate::Status associated with the certificate.
Exception Safety:	noexcept	
Thread Safety:	Thread-safe	
Errors:	CryptoErrorDomain::kInvalidArgument	if the provided certificate is invalid
	CryptoErrorDomain::kNoConnection	if a connection to the OCSP responder cannot be established
Header file:	#include "ara/crypto/x509/x509_provider.h"	
Description:	Check certificate status via On-line Certificate Status Protocol (OCSP).	

]([RS_CRYPT_02306](#))

[SWS_CRYPT_40635]{DRAFT} [

Kind:	function	
Symbol:	CleanupVolatileStorage()	
Scope:	class ara::crypto::x509::X509Provider	
Syntax:	virtual void ara::crypto::x509::X509Provider::CleanupVolatileStorage () noexcept=0;	
Return value:	None	
Exception Safety:	noexcept	
Thread Safety:	Thread-safe	
Header file:	#include "ara/crypto/x509/x509_provider.h"	





Description:	Cleanup the volatile certificates storage. After execution of this command the certificates previously imported to the volatile storage cannot be found by a search, but it doesn't influence to already loaded Certificate instances! .
---------------------	--

](RS_CRYPT_02306)

[SWS_CRYPT_40640]{DRAFT} [

Kind:	function	
Symbol:	CreateCertSignRequest(cryp::SignerPrivateCtx::Uptr signerCtx, ReadOnlyMemRegion derSubjectDN, ReadOnlyMemRegion x509Extensions=ReadOnlyMemRegion(), unsigned version=1)	
Scope:	class ara::crypto::x509::X509Provider	
Syntax:	virtual ara::core::Result<CertSignRequest::Uptrc> ara::crypto::x509::X509Provider::CreateCertSignRequest (cryp::SignerPrivateCtx::Uptr signerCtx, ReadOnlyMemRegion derSubjectDN, ReadOnlyMemRegion x509Extensions=ReadOnlyMemRegion(), unsigned version=1) const noexcept=0;	
Parameters (in):	signerCtx	the fully-configured SignerPrivateCtx to be used for signing this certificate request
	derSubjectDN	the DER-encoded subject distinguished name (DN) of the private key owner
	x509Extensions	the DER-encoded X.509 Extensions that should be included to the certification request
	version	the format version of the target certification request
Return value:	ara::core::Result< CertSignRequest::Uptrc >	unique smart pointer to created certification request
Exception Safety:	noexcept	
Thread Safety:	Thread-safe	
Errors:	CryptoErrorDomain::kUnexpected Value	if any of arguments has incorrect/unsupported value
Header file:	#include "ara/crypto/x509/x509_provider.h"	
Description:	Create certification request for a private key loaded to the context.	

](RS_CRYPT_02306)

[SWS_CRYPT_40615]{DRAFT} [

Kind:	function	
Symbol:	CountCertsInChain(ReadOnlyMemRegion certChain, Serializable::FormatId formatId=Serializable::kFormatDefault)	
Scope:	class ara::crypto::x509::X509Provider	
Syntax:	virtual ara::core::Result<std::size_t> ara::crypto::x509::X509Provider::CountCertsInChain (ReadOnlyMemRegion certChain, Serializable::FormatId formatId=Serializable::kFormatDefault) const noexcept=0;	
Parameters (in):	certChain	DER/PEM-encoded certificate chain (in form of a single BLOB)
	formatId	input format identifier (kFormatDefault means auto-detect)
Return value:	ara::core::Result< std::size_t >	number of certificates in the chain
Exception Safety:	noexcept	



△

Thread Safety:	Thread-safe	
Errors:	CryptoErrorDomain::kInvalidArgument	if the certChain argument cannot be pre-parsed
	CryptoErrorDomain::kUnknown Identifier	if the formatId argument has unknown value
Header file:	#include "ara/crypto/x509/x509_provider.h"	
Description:	Count number of certificates in a serialized certificate chain represented by a single BLOB.	

](RS_CRYPT_02306)

[SWS_CRYPT_40611]{DRAFT} [

Kind:	function	
Symbol:	CreateEmptyDn(std::size_t capacity=0)	
Scope:	class ara::crypto::x509::X509Provider	
Syntax:	virtual ara::core::Result<X509DN::Uptr> ara::crypto::x509::X509Provider::CreateEmptyDn (std::size_t capacity=0) noexcept=0;	
Parameters (in):	capacity	number of bytes that should be reserved for the content of the target X509DN object
Return value:	ara::core::Result< X509DN::Uptr >	Unique smart pointer to created empty X509DN object
Exception Safety:	noexcept	
Thread Safety:	Thread-safe	
Header file:	#include "ara/crypto/x509/x509_provider.h"	
Description:	Create an empty X.500 Distinguished Name (DN) structure. If (0 == capacity) then a maximally supported (by the implementation) capacity must be reserved.	

](RS_CRYPT_02306)

[SWS_CRYPT_40636]{DRAFT} [

Kind:	function	
Symbol:	CreateEmptyExtensions(std::size_t capacity=0)	
Scope:	class ara::crypto::x509::X509Provider	
Syntax:	virtual ara::core::Result<X509Extensions::Uptr> ara::crypto::x509::X509Provider::CreateEmptyExtensions (std::size_t capacity=0) noexcept=0;	
Parameters (in):	capacity	number of bytes that should be reserved for the content of the target X509Extensions object
Return value:	ara::core::Result< X509Extensions::Uptr >	Shared smart pointer to created empty X509X509Extensions object
Exception Safety:	noexcept	
Thread Safety:	Thread-safe	
Header file:	#include "ara/crypto/x509/x509_provider.h"	
Description:	Create an empty X.509 Extensions structure. If (0 == capacity) then a maximally supported (by the implementation) capacity must be reserved.	

](RS_CRYPT_02306)

[SWS_CRYPT_40626]{DRAFT} [

Kind:	function	
Symbol:	CreateOcsRequest(const Certificate &cert, ara::core::Optional< const cryp::SignerPrivateCtx::Uptr > signer)	
Scope:	class ara::crypto::x509::X509Provider	
Syntax:	virtual ara::core::Result<OcsRequest::Uptrc> ara::crypto::x509::X509Provider::CreateOcsRequest (const Certificate &cert, ara::core::Optional< const cryp::SignerPrivateCtx::Uptr > signer) noexcept=0;	
Parameters (in):	cert	a certificate that should be verified
	signer	an optional pointer to initialized signer context (if the request should be signed)
Return value:	ara::core::Result< OcsRequest::Uptrc >	unique smart pointer to the created OCSP request
Exception Safety:	noexcept	
Thread Safety:	Thread-safe	
Errors:	CryptoErrorDomain::kInvalidArgument	if the provided certificate is invalid
	CryptoErrorDomain::kIncompleteArg State	if the signer context is not initialized by a key
Header file:	#include "ara/crypto/x509/x509_provider.h"	
Description:	Create OCSP request for specified certificate. This method may be used for implementation of the "OCSP stapling".	

]([RS_CRYPT_02306](#))

[SWS_CRYPT_40627]{DRAFT} [

Kind:	function	
Symbol:	CreateOcsRequest(const ara::core::Vector< const Certificate * > &certList, ara::core::Optional< const cryp::SignerPrivateCtx::Uptr > signer)	
Scope:	class ara::crypto::x509::X509Provider	
Syntax:	virtual ara::core::Result<OcsRequest::Uptrc> ara::crypto::x509::X509Provider::CreateOcsRequest (const ara::core::Vector< const Certificate * > &certList, ara::core::Optional< const cryp::SignerPrivateCtx::Uptr > signer) noexcept=0;	
Parameters (in):	certList	a certificates' list that should be verified
	signer	an optional pointer to initialized signer context (if the request should be signed)
Return value:	ara::core::Result< OcsRequest::Uptrc >	unique smart pointer to the created OCSP request
Exception Safety:	noexcept	
Thread Safety:	Thread-safe	
Errors:	CryptoErrorDomain::kInvalidArgument	if the provided certificates are invalid
	CryptoErrorDomain::kIncompleteArg State	if the signer context is not initialized by a key
Header file:	#include "ara/crypto/x509/x509_provider.h"	
Description:	Create OCSP request for specified list of certificates. This method may be used for implementation of the "OCSP stapling".	

]([RS_CRYPT_02306](#))

[SWS_CRYPT_40613]{DRAFT} [

Kind:	function	
Symbol:	DecodeDn(ReadOnlyMemRegion dn, Serializable::FormatId formatId=Serializable::kFormatDefault)	
Scope:	class ara::crypto::x509::X509Provider	
Syntax:	virtual ara::core::Result<X509DN::Uptrc> ara::crypto::x509::X509Provider::DecodeDn (ReadOnlyMemRegion dn, Serializable::FormatId formatId=Serializable::kFormatDefault) noexcept=0;	
Parameters (in):	dn	DER/PEM-encoded representation of the Distinguished Name
	formatId	input format identifier (kFormatDefault means auto-detect)
Return value:	ara::core::Result< X509DN::Uptrc >	unique smart pointer for the created X509DN object
Exception Safety:	noexcept	
Thread Safety:	Thread-safe	
Errors:	CryptoErrorDomain::kInvalidArgument	if the dn argument cannot be parsed
	CryptoErrorDomain::kUnknownIdentifier	if the formatId argument has unknown value
Header file:	#include "ara/crypto/x509/x509_provider.h"	
Description:	Decode X.500 Distinguished Name structure from the provided serialized format.	

] ([RS_CRYPT_02306](#))

[SWS_CRYPT_40631]{DRAFT} [

Kind:	function	
Symbol:	FindCertByDn(const X509DN &subjectDn, const X509DN &issuerDn, time_t validityTimePoint)	
Scope:	class ara::crypto::x509::X509Provider	
Syntax:	virtual ara::core::Vector<Certificate::Uptrc> ara::crypto::x509::X509Provider::FindCertByDn (const X509DN &subjectDn, const X509DN &issuerDn, time_t validityTimePoint) noexcept=0;	
Parameters (in):	subjectDn	subject DN of the target certificate
	issuerDn	issuer DN of the target certificate
	validityTimePoint	a time point when the target certificate should be valid
Return value:	ara::core::Vector< Certificate::Uptrc >	a vector of unique smart pointers to found certificates; the vector is empty, if nothing is found
Exception Safety:	noexcept	
Thread Safety:	Thread-safe	
Header file:	#include "ara/crypto/x509/x509_provider.h"	
Description:	Find a certificate by the subject and issuer Distinguished Names (DN).	

] ([RS_CRYPT_02306](#))

[SWS_CRYPT_40632]{DRAFT} [

Kind:	function	
Symbol:	FindCertByKeyIds(ReadOnlyMemRegion subjectKeyId, ara::core::Optional< ReadOnlyMemRegion > authorityKeyId)	





Scope:	class ara::crypto::x509::X509Provider	
Syntax:	<pre>virtual ara::core::Vector<Certificate::Uptrc> ara::crypto::x509::X509Provider::FindCertByKeyIds (ReadOnlyMemRegion subjectKeyId, ara::core::Optional< ReadOnlyMemRegion > authorityKeyId) noexcept=0;</pre>	
Parameters (in):	subjectKeyId	subject key identifier (SKID)
	authorityKeyId	optional authority key identifier (AKID)
Return value:	ara::core::Vector< Certificate::Uptrc >	a vector of unique smart pointers to found certificates; the vector is empty, if nothing is found k UnknownIdentifier
Exception Safety:	noexcept	
Thread Safety:	Thread-safe	
Header file:	#include "ara/crypto/x509/x509_provider.h"	
Description:	Find a certificate by its SKID & AKID.	

]([RS_CRYPTO_02306](#))

[SWS_CRYPT_40633]{DRAFT} [

Kind:	function	
Symbol:	FindCertBySn(ReadOnlyMemRegion sn, const X509DN &issuerDn)	
Scope:	class ara::crypto::x509::X509Provider	
Syntax:	<pre>virtual ara::core::Result<Certificate::Uptrc> ara::crypto::x509::X509Provider::FindCertBySn (ReadOnlyMemRegion sn, const X509DN &issuerDn) noexcept=0;</pre>	
Parameters (in):	sn	serial number of the target certificate
	issuerDn	authority's Distinguished Names (DN)
Return value:	ara::core::Result< Certificate::Uptrc >	the specified certificate or an error, if the certificate cannot be found
Exception Safety:	noexcept	
Thread Safety:	Thread-safe	
Errors:	CryptoErrorDomain::kUnknown Identifier	if the specified certificate could not be found
Header file:	#include "ara/crypto/x509/x509_provider.h"	
Description:	Find a certificate by its serial number and issue DN.	

]([RS_CRYPTO_02306](#))

[SWS_CRYPT_40634]{DRAFT} [

Kind:	function	
Symbol:	ParseCertSignRequest(ReadOnlyMemRegion csr, bool withMetaData=true)	
Scope:	class ara::crypto::x509::X509Provider	
Syntax:	<pre>virtual ara::core::Result<CertSignRequest::Uptrc> ara::crypto::x509::X509Provider::ParseCertSignRequest (ReadOnlyMem Region csr, bool withMetaData=true) noexcept=0;</pre>	
Parameters (in):	csr	the buffer containing a certificate signing request





	withMetaData	specifies the format of the buffer content: TRUE means the object has been previously serialized by using the Serializable interface; FALSE means the CSR was exported using the CertSign Request::ExportASN1CertSignRequest() interface
Return value:	ara::core::Result< CertSign Request::Uptrc >	unique smart pointer to the certificate signing request
Exception Safety:	noexcept	
Thread Safety:	Thread-safe	
Errors:	CryptoErrorDomain::kUnsupported Format	is returned in case the provided buffer does not contain the expected format
Header file:	#include "ara/crypto/x509/x509_provider.h"	
Description:	Parse a certificate signing request (CSR) provided by the user.	

](RS_CRYPT_02306)

[SWS_CRYPT_40620]{DRAFT} [

Kind:	function	
Symbol:	ImportCrl(ReadOnlyMemRegion crl)	
Scope:	class ara::crypto::x509::X509Provider	
Syntax:	virtual ara::core::Result<bool> ara::crypto::x509::X509Provider::ImportCrl (ReadOnlyMemRegion crl) noexcept=0;	
Parameters (in):	crl	serialized CRL or Delta CRL (in form of a BLOB)
Return value:	ara::core::Result< bool >	true if the CRL is valid and false if it is already expired
Exception Safety:	noexcept	
Thread Safety:	Thread-safe	
Errors:	CryptoErrorDomain::kUnexpected Value	if the provided BLOB is not a CRL/DeltaCRL
	CryptoErrorDomain::kRuntimeFault	if the CRL validation has failed
Header file:	#include "ara/crypto/x509/x509_provider.h"	
Description:	Import Certificate Revocation List (CRL) or Delta CRL from a memory BLOB. If the imported CRL lists some certificates kept in the persistent or volatile storages then their status must be automatically updated to Status::kInvalid. If some of these certificates were already opened during this operation, then this status change becomes available immediately (via method call Certificate::GetStatus())! All certificates with the status kInvalid should be automatically removed from correspondent storages (immediately if a certificate not in use now or just after its closing otherwise).	

](RS_CRYPT_02306)

[SWS_CRYPT_40621]{DRAFT} [

Kind:	function	
Symbol:	Import(const Certificate &cert, ara::core::Optional< ara::core::InstanceSpecifier > iSpecify)	
Scope:	class ara::crypto::x509::X509Provider	
Syntax:	virtual ara::core::Result<void> ara::crypto::x509::X509Provider::Import (const Certificate &cert, ara::core::Optional< ara::core::InstanceSpecifier > iSpecify) noexcept=0;	





Parameters (in):	cert	a valid certificate that should be imported
	iSpecify	optionally a valid InstanceSpecifier can be provided that points to a CertificateSlot for persistent storage of the certificate, otherwise the certificate shall be stored in volatile (session) storage
Return value:	ara::core::Result< void >	–
Exception Safety:	noexcept	
Thread Safety:	Thread-safe	
Errors:	CryptoErrorDomain::kInvalidArgument	if the provided certificate is invalid
	CryptoErrorDomain::kIncompatibleObject	if provided certificate has partial collision with a matched CSR in the storage
	CryptoErrorDomain::kContentDuplication	if the provided certificate already exists in the storage
	CryptoErrorDomain::kAccessViolation	if the InstanceSpecifier points to a CertificateSlot, which the application may only read
Header file:	#include "ara/crypto/x509/x509_provider.h"	
Description:	Import the certificate to volatile or persistent storage. Only imported certificate may be found by a search and applied for automatic verifications! A certificate can be imported to only one of storage: volatile or persistent. Therefore if you import a certificate already kept in the persistent storage to the volatile one then nothing changes. But if you import a certificate already kept in the volatile storage to the persistent one then it is "moved" to the persistent realm. If an application successfully imports a certificate that correspond to a CSR existing in the storage then this CSR should be removed.	

|(RS_CRYPT_02306)

[SWS_CRYPT_40641]{DRAFT} [

Kind:	function	
Symbol:	LoadCertificate(ara::core::InstanceSpecifier &iSpecify)	
Scope:	class ara::crypto::x509::X509Provider	
Syntax:	virtual ara::core::Result<Certificate::Uptr> ara::crypto::x509::X509Provider::LoadCertificate (ara::core::InstanceSpecifier &iSpecify) noexcept=0;	
Parameters (in):	iSpecify	the target certificate instance specifier
Return value:	ara::core::Result< Certificate::Uptr >	an unique smart pointer to the instantiated certificate
Exception Safety:	noexcept	
Thread Safety:	Thread-safe	
Errors:	CryptoErrorDomain::kUnreservedResource	if the InstanceSpecifier is incorrect (the certificate cannot be found)
Header file:	#include "ara/crypto/x509/x509_provider.h"	
Description:	Load a certificate from the persistent certificate storage.	

|(RS_CRYPT_02306)

[SWS_CRYPT_40616]{DRAFT} [

Kind:	function	
Symbol:	ParseCertChain(ara::core::Vector< Certificate::Uptr > &outcome, ReadOnlyMemRegion certChain, Serializable::FormatId formatId=Serializable::kFormatDefault)	
Scope:	class ara::crypto::x509::X509Provider	





Syntax:	<pre>virtual ara::core::Result<void> ara::crypto::x509::X509Provider::Parse CertChain (ara::core::Vector< Certificate::Uptr > &outcome, ReadOnly MemRegion certChain, Serializable::FormatId formatId=Serializable::k FormatDefault) noexcept=0;</pre>	
Parameters (in):	certChain	DER/PEM-encoded certificate chain (in form of a single BLOB)
	formatId	input format identifier (kFormatDefault means auto-detect)
Parameters (out):	outcome	an output vector for imported certificates
Return value:	ara::core::Result< void >	–
Exception Safety:	noexcept	
Thread Safety:	Thread-safe	
Errors:	CryptoErrorDomain::kInsufficient Capacity	if the capacity of outcome vector is less than actual number of certificates in the chain
	CryptoErrorDomain::kInvalidArgument	if the certChain argument cannot be parsed
	CryptoErrorDomain::kUnknown Identifier	if the formatId argument has unknown value
Header file:	#include "ara/crypto/x509/x509_provider.h"	
Description:	Parse a serialized representation of the certificate chain and create their instances. Off-line validation of the parsed certification chain may be done via call VerifyCertChainByCrl(). After validation the certificates may be saved to the session or persistent storage for following search and usage. If the certificates are not imported then they will be lost after destroy of the returned instances! Only imported certificates may be found by a search and applied for automatic verifications! Certificates in the outcome vector will be placed from the root CA certificate (zero index) to the final end-entity certificate (last used index of the vector).	

|(RS_CRYPT_02306)

[SWS_CRYPT_40617]{DRAFT} [

Kind:	function	
Symbol:	ParseCertChain(ara::core::Vector< Certificate::Uptr > &outcome, const ara::core::Vector< ReadOnlyMemRegion > &certChain, Serializable::FormatId formatId=Serializable::kFormatDefault)	
Scope:	class ara::crypto::x509::X509Provider	
Syntax:	<pre>virtual ara::core::Result<void> ara::crypto::x509::X509Provider::Parse CertChain (ara::core::Vector< Certificate::Uptr > &outcome, const ara::core::Vector< ReadOnlyMemRegion > &certChain, Serializable::FormatId formatId=Serializable::kFormatDefault) noexcept=0;</pre>	
Parameters (in):	certChain	DER/PEM-encoded certificates chain (each certificate is presented by a separate BLOB in the input vector)
	formatId	input format identifier (kFormatDefault means auto-detect)
Parameters (out):	outcome	output vector of imported certificates
Return value:	ara::core::Result< void >	–
Exception Safety:	noexcept	
Thread Safety:	Thread-safe	
Errors:	CryptoErrorDomain::kInsufficient Capacity	if capacity of the outcome vector is less than number of elements in the certChain
	CryptoErrorDomain::kInvalidArgument	if an element of certChain argument cannot be parsed
	CryptoErrorDomain::kUnknown Identifier	if the formatId argument has unknown value





Header file:	#include "ara/crypto/x509/x509_provider.h"
Description:	Parse a serialized representation of the certificate chain and create their instances. Off-line validation of the parsed certification chain may be done via call VerifyCertChainByCrl(). After validation the certificates may be imported to the session or persistent storage for following search and usage. Capacity of the outcome vector must be equal to the size of the certChain vector. If the certificates are not imported then they will be lost after destroy of the returned instances! Only imported certificates may be found by a search and applied for automatic verifications! Certificates in the outcome vector will be placed from the root CA certificate (zero index) to the final end-entity certificate (last used index of the vector).

](RS_CRYPT_02306)

[SWS_CRYPT_40614]{DRAFT} [

Kind:	function	
Symbol:	ParseCert(ReadOnlyMemRegion cert, Serializable::FormatId formatId=Serializable::kFormatDefault)	
Scope:	class ara::crypto::x509::X509Provider	
Syntax:	virtual ara::core::Result<Certificate::Uptr> ara::crypto::x509::X509Provider::ParseCert (ReadOnlyMemRegion cert, Serializable::FormatId formatId=Serializable::kFormatDefault) noexcept=0;	
Parameters (in):	cert	DER/PEM-encoded certificate
	formatId	input format identifier (kFormatDefault means auto-detect)
Return value:	ara::core::Result< Certificate::Uptr >	unique smart pointer to created certificate
Exception Safety:	noexcept	
Thread Safety:	Thread-safe	
Errors:	CryptoErrorDomain::kInvalidArgument	if the cert argument cannot be parsed
	CryptoErrorDomain::kUnknownIdentifier	if the formatId argument has unknown value
Header file:	#include "ara/crypto/x509/x509_provider.h"	
Description:	Parse a serialized representation of the certificate and create its instance. Off-line validation of the parsed certificate may be done via call VerifyCertByCrl(). After validation the certificate may be imported to the session or persistent storage for following search and usage. If the parsed certificate is not imported then it will be lost after destroy of the returned instance! Only imported certificate may be found by a search and applied for automatic verifications!	

](RS_CRYPT_02306)

[SWS_CRYPT_40628]{DRAFT} [

Kind:	function	
Symbol:	ParseOcsResponse(ReadOnlyMemRegion response)	
Scope:	class ara::crypto::x509::X509Provider	
Syntax:	virtual OcsResponse::Uptr ara::crypto::x509::X509Provider::ParseOcsResponse (ReadOnlyMemRegion response) const noexcept=0;	
Parameters (in):	response	a serialized OCSP response
Return value:	OcsResponse::Uptr	unique smart pointer to the created OCSP response instance
Exception Safety:	noexcept	
Thread Safety:	Thread-safe	



△

Errors:	CryptoErrorDomain::kUnexpected Value	if the provided BLOB response doesn't keep an OCSP response
Header file:	#include "ara/crypto/x509/x509_provider.h"	
Description:	Parse serialized OCSP response and create correspondent interface instance. This method may be used for implementation of the "OCSP stapling".	

] ([RS_CRYPT_02306](#))

[SWS_CRYPT_40622]{DRAFT} [

Kind:	function	
Symbol:	Remove(Certificate::Uptrc &&cert)	
Scope:	class ara::crypto::x509::X509Provider	
Syntax:	virtual bool ara::crypto::x509::X509Provider::Remove (Certificate::Uptrc &&cert) noexcept=0;	
Parameters (in):	cert	a unique smart pointer to a certificate that should be removed
Return value:	bool	true if the certificate was found and removed from the storage, false if it was not found
Exception Safety:	noexcept	
Thread Safety:	Thread-safe	
Header file:	#include "ara/crypto/x509/x509_provider.h"	
Description:	Remove specified certificate from the storage (volatile or persistent) and destroy it.	

] ([RS_CRYPT_02306](#))

[SWS_CRYPT_40638]{DRAFT} [

Kind:	function	
Symbol:	SendRequest(const CertSignRequest &request, bool toVolatile=true)	
Scope:	class ara::crypto::x509::X509Provider	
Syntax:	virtual ara::core::Result<void> ara::crypto::x509::X509Provider::Send Request (const CertSignRequest &request, bool toVolatile=true) noexcept=0;	
Parameters (in):	request	a valid certificate request that should be send to CA
	toVolatile	if this flag true then the request should be saved to the volatile (session) storage, otherwise to the persistent storage
Return value:	ara::core::Result< void >	–
Exception Safety:	noexcept	
Thread Safety:	Thread-safe	
Errors:	CryptoErrorDomain::kInvalidArgument	if the provided certification request is invalid
	CryptoErrorDomain::kNoConnection	if connection to the CA cannot be established
Header file:	#include "ara/crypto/x509/x509_provider.h"	
Description:	Send prepared certificate request to CA and save it to volatile or persistent storage.	

] ([RS_CRYPT_02306](#))

[SWS_CRYPT_40625]{DRAFT} [

Kind:	function	
Symbol:	SetAsRootOfTrust(const Certificate &caCert)	
Scope:	class ara::crypto::x509::X509Provider	
Syntax:	virtual ara::core::Result<void> ara::crypto::x509::X509Provider::SetAsRootOfTrust (const Certificate &caCert) noexcept=0;	
Parameters (in):	caCert	a valid CA certificate that should be trusted
Return value:	ara::core::Result< void >	–
Exception Safety:	noexcept	
Thread Safety:	Thread-safe	
Errors:	CryptoErrorDomain::kInvalidArgument	if the provided certificate is invalid
	CryptoErrorDomain::kIncompatible Object	if provided certificate doesn't belong to a CA
	CryptoErrorDomain::kAccessViolation	if the method called by an application without the "Trust Master" permission
Header file:	#include "ara/crypto/x509/x509_provider.h"	
Description:	Set specified CA certificate as a "root of trust". Only a certificate saved to the volatile or persistent storage may be marked as the "root of trust"! Only CA certificate can be a "root of trust"! Multiple certificates on an ECU may be marked as the "root of trust". Only an application with permissions "Trust Master" has the right to call this method!	

] ([RS_CRYPT_02306](#))

[SWS_CRYPT_40624]{DRAFT} [

Kind:	function	
Symbol:	SetPendingStatus(const CertSignRequest &request)	
Scope:	class ara::crypto::x509::X509Provider	
Syntax:	virtual ara::core::Result<void> ara::crypto::x509::X509Provider::SetPendingStatus (const CertSignRequest &request) noexcept=0;	
Parameters (in):	request	certificate signing request that should be marked as "pending"
Return value:	ara::core::Result< void >	–
Exception Safety:	noexcept	
Thread Safety:	Thread-safe	
Errors:	CryptoErrorDomain::kAccessViolation	if the method called by an application without the "CA Connector" permission
Header file:	#include "ara/crypto/x509/x509_provider.h"	
Description:	Set the "pending" status associated to the CSR that means that the CSR already sent to CA. This method do nothing if the CSR already marked as "pending". Only an application with permissions "CA Connector" has the right to call this method!	

] ([RS_CRYPT_02306](#))

[SWS_CRYPT_40637]{DRAFT} [

Kind:	function	
Symbol:	UpdateCrIOnline(const Certificate &caCert)	
Scope:	class ara::crypto::x509::X509Provider	





Syntax:	virtual ara::core::Result<bool> ara::crypto::x509::X509Provider::UpdateCrlOnline (const Certificate &caCert) noexcept=0;	
Parameters (in):	caCert	valid CA certificate
Return value:	ara::core::Result< bool >	true if the CRL was updated succesfully and false if there is no fresh updates
Exception Safety:	noexcept	
Thread Safety:	Thread-safe	
Errors:	CryptoErrorDomain::kInvalidArgument	if the provided certificate is invalid
	CryptoErrorDomain::kNoConnection	if the connection cannot be established
Header file:	#include "ara/crypto/x509/x509_provider.h"	
Description:	Get Certificate Revocation List (CRL) or Delta CRL via on-line connection. CRL Distribution Point (CRL DP) should be extracted from the provided CA certificate.	

]([RS_CRYPTO_02306](#))

[SWS_CRYPT_40618]{DRAFT} [

Kind:	function	
Symbol:	VerifyCert(Certificate &cert, Certificate::Uptr myRoot=nullptr)	
Scope:	class ara::crypto::x509::X509Provider	
Syntax:	virtual Certificate::Status ara::crypto::x509::X509Provider::Verify Cert (Certificate &cert, Certificate::Uptr myRoot=nullptr) noexcept=0;	
Parameters (in):	cert	target certificate for verification
	myRoot	root certificate to be used for verification - if this is nullptr, use machine root certificates
Return value:	Certificate::Status	verification status of the provided certificate
Exception Safety:	noexcept	
Thread Safety:	Thread-safe	
Header file:	#include "ara/crypto/x509/x509_provider.h"	
Description:	Verify status of the provided certificate by locally stored CA certificates and CRLs only. This method updates the Certificate::Status associated with the certificate.	

]([RS_CRYPTO_02306](#))

[SWS_CRYPT_40619]{DRAFT} [

Kind:	function	
Symbol:	VerifyCertChain(ara::core::Span< const Certificate::Uptr > chain, Certificate::Uptr myRoot=nullptr)	
Scope:	class ara::crypto::x509::X509Provider	
Syntax:	virtual Certificate::Status ara::crypto::x509::X509Provider::Verify CertChain (ara::core::Span< const Certificate::Uptr > chain, Certificate::Uptr myRoot=nullptr) const noexcept=0;	
Parameters (in):	chain	target certificate chain for verification
	myRoot	root certificate to be used for verification - if this is nullptr, use machine root certificates
Return value:	Certificate::Status	verification status of the provided certificate chain
Exception Safety:	noexcept	
Thread Safety:	Thread-safe	





Header file:	#include "ara/crypto/x509/x509_provider.h"
Description:	Verify status of the provided certification chain by locally stored CA certificates and CRLs only. Verification status of the certificate chain is Certificate::Status::kValid only if all certificates in the chain have such status! Certificates in the chain (presented by container vector) must be placed from the root CA certificate (zero index) to the target end-entity certificate (last used index of the vector). Verification is executed in same order. If the chain verification is failed then status of the first failed certificate is returned. This method updates the Certificate::Status associated with the certificates in the chain.

](RS_CRYPT_02306)

[SWS_CRYPT_40914]{DRAFT} [

Kind:	function	
Symbol:	ParseCustomCertExtensions(const Certificate &cert, std::unique_ptr< X509CustomExtensionsParser > customExtensionsParser)	
Scope:	class ara::crypto::x509::X509Provider	
Syntax:	virtual ara::core::Result<void> ara::crypto::x509::X509Provider::ParseCustomCertExtensions (const Certificate &cert, std::unique_ptr< X509CustomExtensionsParser > customExtensionsParser) const noexcept=0;	
Parameters (in):	cert	Certificate object to be parsed
	customExtensionsParser	Custom extensions parser that implements the callbacks
Return value:	ara::core::Result< void >	–
Exception Safety:	noexcept	
Thread Safety:	Thread-safe	
Errors:	CryptoErrorDomain::kRuntimeFault	If parsing the extensions fails or calling one of the callback returns an error.
Header file:	#include "ara/crypto/x509/x509_provider.h"	
Description:	Parse the custom X.509 extensions This method parses the extensions of the provided certificate and calls the corresponding callbacks of the provided customExtensionsParser for each parsed ASN.1 element. If any call to one of the callbacks returns an error, the parsing stops and returns kRuntimeFault. Parsing starts at the first extension of the certificate and parses all extensions of the certificate.	

](RS_CRYPT_02306)

[SWS_CRYPT_40915]{DRAFT} [

Kind:	function	
Symbol:	ParseCustomCertExtensions(const Certificate &cert, std::unique_ptr< X509CustomExtensionsParser > customExtensionsParser, X509CustomExtensionsParser::Oid oid)	
Scope:	class ara::crypto::x509::X509Provider	
Syntax:	virtual ara::core::Result<void> ara::crypto::x509::X509Provider::ParseCustomCertExtensions (const Certificate &cert, std::unique_ptr< X509CustomExtensionsParser > customExtensionsParser, X509CustomExtensionsParser::Oid oid) const noexcept=0;	
Parameters (in):	cert	Certificate object to be parsed
	customExtensionsParser	Custom extensions parser that implements the callbacks
	oid	extension object identifier
Return value:	ara::core::Result< void >	–
Exception Safety:	noexcept	





Thread Safety:	Thread-safe	
Errors:	CryptoErrorDomain::kRuntimeFault	If parsing the extensions fails or calling one of the callback returns an error.
	CryptoErrorDomain::kUnexpected Value	If the certificate doesn't contain an extension with the provided Oid.
Header file:	#include "ara/crypto/x509/x509_provider.h"	
Description:	Parse the custom X.509 extensions This method parses the extension identified by the provided oid of the provided certificate and calls the corresponding callbacks of the provided customExtensionsParser for each parsed ASN.1 element. If any call to one of the callbacks returns an error, the parsing stops and returns kRuntimeFault. Only the sequence of the extension identified by the oid is parsed.	

|(RS_CRYPT_02306)

[SWS_CRYPT_40604]{DRAFT} [

Kind:	function	
Symbol:	~X509Provider()	
Scope:	class ara::crypto::x509::X509Provider	
Syntax:	virtual ara::crypto::x509::X509Provider::~X509Provider () noexcept=default;	
Exception Safety:	noexcept	
Header file:	#include "ara/crypto/x509/x509_provider.h"	
Description:	Destructor.	

|(RS_CRYPT_02306)

[SWS_CRYPT_30226]{DRAFT} [

Kind:	function	
Symbol:	operator=(const X509Provider &other)	
Scope:	class ara::crypto::x509::X509Provider	
Syntax:	X509Provider& ara::crypto::x509::X509Provider::operator= (const X509Provider &other)=default;	
Parameters (in):	other	the other instance
Return value:	X509Provider &	*this, containing the contents of other
Header file:	#include "ara/crypto/x509/x509_provider.h"	
Description:	Copy-assign another X509Provider to this instance.	

|(RS_CRYPT_02004)

[SWS_CRYPT_30227]{DRAFT} [

Kind:	function	
Symbol:	operator=(X509Provider &&other)	
Scope:	class ara::crypto::x509::X509Provider	
Syntax:	X509Provider& ara::crypto::x509::X509Provider::operator= (X509Provider &&other)=default;	
Parameters (in):	other	the other instance
Return value:	X509Provider &	*this, containing the contents of other





Header file:	#include "ara/crypto/x509/x509_provider.h"
Description:	Move-assign another X509Provider to this instance.

](RS_CRYPT_02004)

[SWS_CRYPT_40922]{DRAFT} [

Kind:	function	
Symbol:	OnBitString(BitString parsed_bit_string)	
Scope:	class ara::crypto::x509::X509CustomExtensionsParser	
Syntax:	virtual ara::core::Result<void> ara::crypto::x509::X509CustomExtensionsParser::OnBitString (BitString parsed_bit_string) noexcept=0;	
Parameters (in):	parsed_bit_string	Parsed bit string value
Return value:	ara::core::Result< void >	–
Exception Safety:	noexcept	
Errors:	CryptoErrorDomain::kRuntimeFault	Indicates an error to the parser to stop parsing
Header file:	#include "ara/crypto/x509/x509_custom_extension_parser.h"	
Description:	Called when a bit string is encountered.	

](RS_CRYPT_02306)

[SWS_CRYPT_40920]{DRAFT} [

Kind:	function	
Symbol:	OnBool(bool parsed_bool)	
Scope:	class ara::crypto::x509::X509CustomExtensionsParser	
Syntax:	virtual ara::core::Result<void> ara::crypto::x509::X509CustomExtensionsParser::OnBool (bool parsed_bool) noexcept=0;	
Parameters (in):	parsed_bool	Parsed boolean value
Return value:	ara::core::Result< void >	–
Exception Safety:	noexcept	
Errors:	CryptoErrorDomain::kRuntimeFault	Indicates an error to the parser to stop parsing
Header file:	#include "ara/crypto/x509/x509_custom_extension_parser.h"	
Description:	Called when a boolean is encountered.	

](RS_CRYPT_02306)

[SWS_CRYPT_40929]{DRAFT} [

Kind:	function	
Symbol:	OnGeneralizedTime(GeneralizedTime parsed_generalized_time)	
Scope:	class ara::crypto::x509::X509CustomExtensionsParser	
Syntax:	virtual ara::core::Result<void> ara::crypto::x509::X509CustomExtensionsParser::OnGeneralizedTime (GeneralizedTime parsed_generalized_time) noexcept=0;	
Parameters (in):	parsed_generalized_time	Parsed generalized time value
Return value:	ara::core::Result< void >	–
Exception Safety:	noexcept	





Errors:	CryptoErrorDomain::kRuntimeFault	Indicates an error to the parser to stop parsing
Header file:	#include "ara/crypto/x509/x509_custom_extension_parser.h"	
Description:	Called when a generalized time is encountered.	

]([RS_CRYPT_02306](#))

[SWS_CRYPT_40928]{DRAFT} [

Kind:	function	
Symbol:	OnIa5String(Ia5String parsed_ia5_string)	
Scope:	class ara::crypto::x509::X509CustomExtensionsParser	
Syntax:	virtual ara::core::Result<void> ara::crypto::x509::X509CustomExtensionsParser::OnIa5String (Ia5String parsed_ia5_string) noexcept=0;	
Parameters (in):	parsed_ia5_string	Parsed IA5 string value
Return value:	ara::core::Result< void >	–
Exception Safety:	noexcept	
Errors:	CryptoErrorDomain::kRuntimeFault	Indicates an error to the parser to stop parsing
Header file:	#include "ara/crypto/x509/x509_custom_extension_parser.h"	
Description:	Called when an IA5 string is encountered.	

]([RS_CRYPT_02306](#))

[SWS_CRYPT_40921]{DRAFT} [

Kind:	function	
Symbol:	OnInteger(Integer parsed_integer)	
Scope:	class ara::crypto::x509::X509CustomExtensionsParser	
Syntax:	virtual ara::core::Result<void> ara::crypto::x509::X509CustomExtensionsParser::OnInteger (Integer parsed_integer) noexcept=0;	
Parameters (in):	parsed_integer	Parsed integer value
Return value:	ara::core::Result< void >	–
Exception Safety:	noexcept	
Errors:	CryptoErrorDomain::kRuntimeFault	Indicates an error to the parser to stop parsing
Header file:	#include "ara/crypto/x509/x509_custom_extension_parser.h"	
Description:	Called when an integer is encountered.	

]([RS_CRYPT_02306](#))

[SWS_CRYPT_40924]{DRAFT} [

Kind:	function	
Symbol:	OnNull()	
Scope:	class ara::crypto::x509::X509CustomExtensionsParser	
Syntax:	virtual ara::core::Result<void> ara::crypto::x509::X509CustomExtensionsParser::OnNull () noexcept=0;	
Return value:	ara::core::Result< void >	–
Exception Safety:	noexcept	
Errors:	CryptoErrorDomain::kRuntimeFault	Indicates an error to the parser to stop parsing





Header file:	#include "ara/crypto/x509/x509_custom_extension_parser.h"
Description:	Called when a NULL is encountered.

](RS_CRYPT_02306)

[SWS_CRYPT_40923]{DRAFT} [

Kind:	function	
Symbol:	OnOctetString(OctetString parsed_octet_string)	
Scope:	class ara::crypto::x509::X509CustomExtensionsParser	
Syntax:	virtual ara::core::Result<void> ara::crypto::x509::X509CustomExtensionsParser::OnOctetString (OctetString parsed_octet_string) noexcept=0;	
Parameters (in):	parsed_octet_string	Parsed octet string value
Return value:	ara::core::Result< void >	–
Exception Safety:	noexcept	
Errors:	CryptoErrorDomain::kRuntimeFault	Indicates an error to the parser to stop parsing
Header file:	#include "ara/crypto/x509/x509_custom_extension_parser.h"	
Description:	Called when an octet string is encountered.	

](RS_CRYPT_02306)

[SWS_CRYPT_40925]{DRAFT} [

Kind:	function	
Symbol:	OnOid(Oid parsed_oid)	
Scope:	class ara::crypto::x509::X509CustomExtensionsParser	
Syntax:	virtual ara::core::Result<void> ara::crypto::x509::X509CustomExtensionsParser::OnOid (Oid parsed_oid) noexcept=0;	
Parameters (in):	parsed_oid	Parsed oid value
Return value:	ara::core::Result< void >	–
Exception Safety:	noexcept	
Errors:	CryptoErrorDomain::kRuntimeFault	Indicates an error to the parser to stop parsing
Header file:	#include "ara/crypto/x509/x509_custom_extension_parser.h"	
Description:	Called when an oid is encountered.	

](RS_CRYPT_02306)

[SWS_CRYPT_40931]{DRAFT} [

Kind:	function	
Symbol:	OnParsingEnd()	
Scope:	class ara::crypto::x509::X509CustomExtensionsParser	
Syntax:	virtual ara::core::Result<void> ara::crypto::x509::X509CustomExtensionsParser::OnParsingEnd () noexcept=0;	
Return value:	ara::core::Result< void >	–
Exception Safety:	noexcept	
Errors:	CryptoErrorDomain::kRuntimeFault	Indicates an error to the parser to stop parsing
Header file:	#include "ara/crypto/x509/x509_custom_extension_parser.h"	
Description:	Called when the parsing is completed.	

]([RS_CRYPT_02306](#))

[SWS_CRYPT_40927]{DRAFT} [

Kind:	function	
Symbol:	OnPrintableString(PrintableString parsed_printable_string)	
Scope:	class ara::crypto::x509::X509CustomExtensionsParser	
Syntax:	virtual ara::core::Result<void> ara::crypto::x509::X509CustomExtensionsParser::OnPrintableString (PrintableString parsed_printable_string) noexcept=0;	
Parameters (in):	parsed_printable_string	Parsed printable string value
Return value:	ara::core::Result< void >	–
Exception Safety:	noexcept	
Errors:	CryptoErrorDomain::kRuntimeFault	Indicates an error to the parser to stop parsing
Header file:	#include "ara/crypto/x509/x509_custom_extension_parser.h"	
Description:	Called when a printable string is encountered.	

]([RS_CRYPT_02306](#))

[SWS_CRYPT_40917]{DRAFT} [

Kind:	function	
Symbol:	OnSequenceEnd()	
Scope:	class ara::crypto::x509::X509CustomExtensionsParser	
Syntax:	virtual ara::core::Result<void> ara::crypto::x509::X509CustomExtensionsParser::OnSequenceEnd () noexcept=0;	
Return value:	ara::core::Result< void >	–
Exception Safety:	noexcept	
Errors:	CryptoErrorDomain::kRuntimeFault	Indicates an error to the parser to stop parsing
Header file:	#include "ara/crypto/x509/x509_custom_extension_parser.h"	
Description:	Called when a sequence ends.	

]([RS_CRYPT_02306](#))

[SWS_CRYPT_40916]{DRAFT} [

Kind:	function	
Symbol:	OnSequenceStart()	
Scope:	class ara::crypto::x509::X509CustomExtensionsParser	
Syntax:	virtual ara::core::Result<void> ara::crypto::x509::X509CustomExtensionsParser::OnSequenceStart () noexcept=0;	
Return value:	ara::core::Result< void >	–
Exception Safety:	noexcept	
Errors:	CryptoErrorDomain::kRuntimeFault	Indicates an error to the parser to stop parsing
Header file:	#include "ara/crypto/x509/x509_custom_extension_parser.h"	
Description:	Called when a sequence starts.	

]([RS_CRYPT_02306](#))

[SWS_CRYPT_40919]{DRAFT} [

Kind:	function	
Symbol:	OnSetEnd()	
Scope:	class ara::crypto::x509::X509CustomExtensionsParser	
Syntax:	virtual ara::core::Result<void> ara::crypto::x509::X509CustomExtensionsParser::OnSetEnd () noexcept=0;	
Return value:	ara::core::Result< void >	–
Exception Safety:	noexcept	
Errors:	CryptoErrorDomain::kRuntimeFault	Indicates an error to the parser to stop parsing
Header file:	#include "ara/crypto/x509/x509_custom_extension_parser.h"	
Description:	Called when a set ends.	

] ([RS_CRYPT_02306](#))

[SWS_CRYPT_40918]{DRAFT} [

Kind:	function	
Symbol:	OnSetStart()	
Scope:	class ara::crypto::x509::X509CustomExtensionsParser	
Syntax:	virtual ara::core::Result<void> ara::crypto::x509::X509CustomExtensionsParser::OnSetStart () noexcept=0;	
Return value:	ara::core::Result< void >	–
Exception Safety:	noexcept	
Errors:	CryptoErrorDomain::kRuntimeFault	Indicates an error to the parser to stop parsing
Header file:	#include "ara/crypto/x509/x509_custom_extension_parser.h"	
Description:	Called when a set starts.	

] ([RS_CRYPT_02306](#))

[SWS_CRYPT_40930]{DRAFT} [

Kind:	function	
Symbol:	OnUtcTime(UtcTime parsed_utc_time)	
Scope:	class ara::crypto::x509::X509CustomExtensionsParser	
Syntax:	virtual ara::core::Result<void> ara::crypto::x509::X509CustomExtensionsParser::OnUtcTime (UtcTime parsed_utc_time) noexcept=0;	
Parameters (in):	parsed_utc_time	Parsed UTC time value
Return value:	ara::core::Result< void >	–
Exception Safety:	noexcept	
Errors:	CryptoErrorDomain::kRuntimeFault	Indicates an error to the parser to stop parsing
Header file:	#include "ara/crypto/x509/x509_custom_extension_parser.h"	
Description:	Called when a UTC time is encountered.	

] ([RS_CRYPT_02306](#))

[SWS_CRYPT_40926]{DRAFT} [

Kind:	function	
Symbol:	OnUtf8String(Utf8String parsed_utf8_string)	
Scope:	class ara::crypto::x509::X509CustomExtensionsParser	
Syntax:	virtual ara::core::Result<void> ara::crypto::x509::X509CustomExtensionsParser::OnUtf8String (Utf8String parsed_utf8_string) noexcept=0;	
Parameters (in):	parsed_utf8_string	Parsed UTF8 string value
Return value:	ara::core::Result< void >	–
Exception Safety:	noexcept	
Errors:	CryptoErrorDomain::kRuntimeFault	Indicates an error to the parser to stop parsing
Header file:	#include "ara/crypto/x509/x509_custom_extension_parser.h"	
Description:	Called when an UTF8 string is encountered.	

] ([RS_CRYPT_02306](#))

[SWS_CRYPT_40981]{DRAFT} [

Kind:	function	
Symbol:	~X509CustomExtensionsParser()	
Scope:	class ara::crypto::x509::X509CustomExtensionsParser	
Syntax:	virtual ara::crypto::x509::X509CustomExtensionsParser::~~X509CustomExtensionsParser () noexcept=default;	
Exception Safety:	noexcept	
Header file:	#include "ara/crypto/x509/x509_custom_extension_parser.h"	
Description:	Destructor.	

] ([RS_CRYPT_02306](#))

[SWS_CRYPT_40101]{DRAFT} [

Kind:	type alias	
Symbol:	KeyConstraints	
Scope:	class ara::crypto::x509::BasicCertInfo	
Derived from:	std::uint32_t	
Syntax:	using ara::crypto::x509::BasicCertInfo::KeyConstraints = std::uint32_t;	
Header file:	#include "ara/crypto/x509/basic_cert_info.h"	
Description:	X.509 v3 Key Constraints type definition.	

] ([RS_CRYPT_02306](#))

[SWS_CRYPT_40203]{DRAFT} [

Kind:	enumeration	
Symbol:	Status	
Scope:	class ara::crypto::x509::Certificate	
Underlying type:	std::uint32_t	
Syntax:	enum class Status : std::uint32_t {...};	





Values:	kValid= 0	The certificate is valid.
	kInvalid= 1	The certificate is invalid.
	kUnknown= 2	Status of the certificate is unknown yet.
	kNoTrust= 3	The certificate has correct signature, but the ECU has no a root of trust for this certificate.
	kExpired= 4	The certificate has correct signature, but it is already expired (its validity period has ended)
	kFuture= 5	The certificate has correct signature, but its validity period is not started yet.
Header file:	#include "ara/crypto/x509/certificate.h"	
Description:	Certificate verification status.	

]([RS_CRYPT_02306](#))

[SWS_CRYPT_40202]{DRAFT} [

Kind:	type alias
Symbol:	Uptrc
Scope:	class ara::crypto::x509::Certificate
Derived from:	std::unique_ptr<const Certificate>
Syntax:	using ara::crypto::x509::Certificate::Uptrc = std::unique_ptr<const Certificate>;
Header file:	#include "ara/crypto/x509/certificate.h"
Description:	Unique smart pointer of the interface.

]([RS_CRYPT_02306](#))

[SWS_CRYPT_40201]{DRAFT} [

Kind:	type alias
Symbol:	Uptr
Scope:	class ara::crypto::x509::Certificate
Derived from:	std::unique_ptr<Certificate>
Syntax:	using ara::crypto::x509::Certificate::Uptr = std::unique_ptr<Certificate>;
Header file:	#include "ara/crypto/x509/certificate.h"
Description:	Unique smart pointer of the interface.

]([RS_CRYPT_02306](#))

[SWS_CRYPT_40301]{DRAFT} [

Kind:	type alias
Symbol:	Uptrc
Scope:	class ara::crypto::x509::CertSignRequest
Derived from:	std::unique_ptr<const CertSignRequest>
Syntax:	using ara::crypto::x509::CertSignRequest::Uptrc = std::unique_ptr<const CertSignRequest>;
Header file:	#include "ara/crypto/x509/cert_sign_request.h"
Description:	Unique smart pointer of the constant interface.

](RS_CRYPT_02306)

[SWS_CRYPT_40302]{DRAFT} [

Kind:	type alias
Symbol:	Uptr
Scope:	class ara::crypto::x509::CertSignRequest
Derived from:	std::unique_ptr<CertSignRequest>
Syntax:	using ara::crypto::x509::CertSignRequest::Uptr = std::unique_ptr<CertSignRequest>;
Header file:	#include "ara/crypto/x509/cert_sign_request.h"
Description:	Unique smart pointer of the interface.

](RS_CRYPT_02306)

[SWS_CRYPT_40002]{DRAFT} [

Kind:	enumeration						
Symbol:	OcspCertStatus						
Scope:	namespace ara::crypto::x509						
Underlying type:	std::uint32_t						
Syntax:	enum class OcspCertStatus : std::uint32_t {...};						
Values:	<table border="1"> <tr> <td>kGood= 0</td> <td>The certificate is not revoked.</td> </tr> <tr> <td>kRevoked= 1</td> <td>The certificate has been revoked (either permanently or temporarily (on hold))</td> </tr> <tr> <td>kUnknown= 2</td> <td>The responder doesn't know about the certificate being requested.</td> </tr> </table>	kGood= 0	The certificate is not revoked.	kRevoked= 1	The certificate has been revoked (either permanently or temporarily (on hold))	kUnknown= 2	The responder doesn't know about the certificate being requested.
kGood= 0	The certificate is not revoked.						
kRevoked= 1	The certificate has been revoked (either permanently or temporarily (on hold))						
kUnknown= 2	The responder doesn't know about the certificate being requested.						
Header file:	#include "ara/crypto/x509/ocsp_response.h"						
Description:	On-line Certificate Status Protocol (OCSP) Certificate Status.						

](RS_CRYPT_02306)

[SWS_CRYPT_40702]{DRAFT} [

Kind:	type alias
Symbol:	Uptrc
Scope:	class ara::crypto::x509::OcspRequest
Derived from:	std::unique_ptr<const OcspRequest>
Syntax:	using ara::crypto::x509::OcspRequest::Uptrc = std::unique_ptr<const OcspRequest>;
Header file:	#include "ara/crypto/x509/ocsp_request.h"
Description:	Shared smart pointer of the interface.

](RS_CRYPT_02306)

[SWS_CRYPT_40701]{DRAFT} [

Kind:	type alias
Symbol:	Uptr
Scope:	class ara::crypto::x509::OcspRequest





Derived from:	std::unique_ptr<OcspRequest>
Syntax:	using ara::crypto::x509::OcspRequest::Uptr = std::unique_ptr<OcspRequest>;
Header file:	#include "ara/crypto/x509/ocsp_request.h"
Description:	Shared smart pointer of the interface.

]([RS_CRYPTO_02306](#))

[SWS_CRYPT_40001]{DRAFT} [

Kind:	enumeration												
Symbol:	OcspResponseStatus												
Scope:	namespace ara::crypto::x509												
Underlying type:	std::uint32_t												
Syntax:	enum class OcspResponseStatus : std::uint32_t {...};												
Values:	<table border="1"> <tr> <td>kSuccessful= 0</td> <td>Response has valid confirmations.</td> </tr> <tr> <td>kMalformedRequest= 1</td> <td>Illegal confirmation request.</td> </tr> <tr> <td>kInternalError= 2</td> <td>Internal error in issuer.</td> </tr> <tr> <td>kTryLater= 3</td> <td>Try again later.</td> </tr> <tr> <td>kSigRequired= 5</td> <td>Must sign the request.</td> </tr> <tr> <td>kUnauthorized= 6</td> <td>Request unauthorized.</td> </tr> </table>	kSuccessful= 0	Response has valid confirmations.	kMalformedRequest= 1	Illegal confirmation request.	kInternalError= 2	Internal error in issuer.	kTryLater= 3	Try again later.	kSigRequired= 5	Must sign the request.	kUnauthorized= 6	Request unauthorized.
kSuccessful= 0	Response has valid confirmations.												
kMalformedRequest= 1	Illegal confirmation request.												
kInternalError= 2	Internal error in issuer.												
kTryLater= 3	Try again later.												
kSigRequired= 5	Must sign the request.												
kUnauthorized= 6	Request unauthorized.												
Header file:	#include "ara/crypto/x509/ocsp_response.h"												
Description:	On-line Certificate Status Protocol (OCSP) Response Status.												

]([RS_CRYPTO_02306](#))

[SWS_CRYPT_40802]{DRAFT} [

Kind:	type alias
Symbol:	Uptrc
Scope:	class ara::crypto::x509::OcspResponse
Derived from:	std::unique_ptr<const OcspResponse>
Syntax:	using ara::crypto::x509::OcspResponse::Uptrc = std::unique_ptr<const OcspResponse>;
Header file:	#include "ara/crypto/x509/ocsp_response.h"
Description:	Shared smart pointer of the interface.

]([RS_CRYPTO_02306](#))

[SWS_CRYPT_40801]{DRAFT} [

Kind:	type alias
Symbol:	Uptr
Scope:	class ara::crypto::x509::OcspResponse
Derived from:	std::unique_ptr<OcspResponse>
Syntax:	using ara::crypto::x509::OcspResponse::Uptr = std::unique_ptr<OcspResponse>;





Header file:	#include "ara/crypto/x509/ocsp_response.h"
Description:	Shared smart pointer of the interface.

](RS_CRYPT_02306)

[SWS_CRYPT_40403]{DRAFT} [

Kind:	enumeration	
Symbol:	Attributeld	
Scope:	class ara::crypto::x509::X509DN	
Underlying type:	std::uint32_t	
Syntax:	enum class AttributeId : std::uint32_t {...};	
Values:	kCommonName= 0	Common Name.
	kCountry= 1	Country.
	kState= 2	State.
	kLocality= 3	Locality.
	kOrganization= 4	Organization.
	kOrgUnit= 5	Organization Unit.
	kStreet= 6	Street.
	kPostalCode= 7	Postal Code.
	kTitle= 8	Title.
	kSurname= 9	Surname.
	kGivenName= 10	Given Name.
	kInitials= 11	Initials.
	kPseudonym= 12	Pseudonym.
	kGenerationQualifier= 13	Generation Qualifier.
	kDomainComponent= 14	Domain Component.
	kDnQualifier= 15	Distinguished Name Qualifier.
	kEmail= 16	E-mail.
	kUri= 17	URI.
kDns= 18	DNS.	
kHostName= 19	Host Name (UNSTRUCTUREDNAME)	
kIpAddress= 20	IP Address (UNSTRUCTUREDADDRESS)	
kSerialNumbers= 21	Serial Numbers.	
kUserId= 22	User ID.	
Header file:	#include "ara/crypto/x509/x509_dn.h"	
Description:	Enumeration of DN attributes' identifiers.	

](RS_CRYPT_02306)

[SWS_CRYPT_40402]{DRAFT} [

Kind:	type alias
Symbol:	Uptrc
Scope:	class ara::crypto::x509::X509DN
Derived from:	std::unique_ptr<const X509DN>





Syntax:	<code>using ara::crypto::x509::X509DN::Uptrc = std::unique_ptr<const X509DN>;</code>
Header file:	<code>#include "ara/crypto/x509/x509_dn.h"</code>
Description:	Unique smart pointer of the constant interface.

]([RS_CRYPTO_02306](#))

[SWS_CRYPT_40401]{DRAFT} [

Kind:	type alias
Symbol:	Uptr
Scope:	class ara::crypto::x509::X509DN
Derived from:	<code>std::unique_ptr<X509DN></code>
Syntax:	<code>using ara::crypto::x509::X509DN::Uptr = std::unique_ptr<X509DN>;</code>
Header file:	<code>#include "ara/crypto/x509/x509_dn.h"</code>
Description:	Unique smart pointer of the interface.

]([RS_CRYPTO_02306](#))

[SWS_CRYPT_40501]{DRAFT} [

Kind:	type alias
Symbol:	Uptr
Scope:	class ara::crypto::x509::X509Extensions
Derived from:	<code>std::unique_ptr<X509Extensions></code>
Syntax:	<code>using ara::crypto::x509::X509Extensions::Uptr = std::unique_ptr<X509Extensions>;</code>
Header file:	<code>#include "ara/crypto/x509/x509_extensions.h"</code>
Description:	Shared smart pointer of the interface.

]([RS_CRYPTO_02306](#))

[SWS_CRYPT_24401]{DRAFT} [

Kind:	type alias
Symbol:	Uptrc
Scope:	class ara::crypto::x509::X509PublicKeyInfo
Derived from:	<code>std::unique_ptr<const X509PublicKeyInfo></code>
Syntax:	<code>using ara::crypto::x509::X509PublicKeyInfo::Uptrc = std::unique_ptr<const X509PublicKeyInfo>;</code>
Header file:	<code>#include "ara/crypto/x509/x509_public_key_info.h"</code>
Description:	Unique smart pointer of the interface.

]([RS_CRYPTO_02307](#))

[SWS_CRYPT_40601]{DRAFT} [

Kind:	type alias
Symbol:	Uptr
Scope:	class ara::crypto::x509::X509Provider
Derived from:	std::unique_ptr<X509Provider>
Syntax:	using ara::crypto::x509::X509Provider::Uptr = std::unique_ptr<X509Provider>;
Header file:	#include "ara/crypto/x509/x509_provider.h"
Description:	Shared smart pointer of the interface.

]([RS_CRYPT_02306](#))

[SWS_CRYPT_40602]{DRAFT} [

Kind:	type alias
Symbol:	StorageIndex
Scope:	class ara::crypto::x509::X509Provider
Derived from:	std::size_t
Syntax:	using ara::crypto::x509::X509Provider::StorageIndex = std::size_t;
Header file:	#include "ara/crypto/x509/x509_provider.h"
Description:	Type of an internal index inside the certificate storage.

]([RS_CRYPT_02306](#))

[SWS_CRYPT_40935]{DRAFT} [

Kind:	type alias
Symbol:	BitString
Scope:	class ara::crypto::x509::X509CustomExtensionsParser
Derived from:	std::pair<ara::crypto::ReadOnlyMemRegion, NumberOfUnusedBits>
Syntax:	using ara::crypto::x509::X509CustomExtensionsParser::BitString = std::pair<ara::crypto::ReadOnlyMemRegion, NumberOfUnusedBits>;
Header file:	#include "ara/crypto/x509/x509_custom_extension_parser.h"
Description:	Type alias.

]([RS_CRYPT_02306](#))

[SWS_CRYPT_40941]{DRAFT} [

Kind:	type alias
Symbol:	GeneralizedTime
Scope:	class ara::crypto::x509::X509CustomExtensionsParser
Derived from:	ara::core::StringView
Syntax:	using ara::crypto::x509::X509CustomExtensionsParser::GeneralizedTime = ara::core::StringView;
Header file:	#include "ara/crypto/x509/x509_custom_extension_parser.h"
Description:	Type alias.

]([RS_CRYPT_02306](#))

[SWS_CRYPT_40940]{DRAFT} [

Kind:	type alias
Symbol:	Ia5String
Scope:	class ara::crypto::x509::X509CustomExtensionsParser
Derived from:	ara::core::StringView
Syntax:	using ara::crypto::x509::X509CustomExtensionsParser::Ia5String = ara::core::StringView;
Header file:	#include "ara/crypto/x509/x509_custom_extension_parser.h"
Description:	Type alias.

]([RS_CRYPT_02306](#))

[SWS_CRYPT_40933]{DRAFT} [

Kind:	type alias
Symbol:	Integer
Scope:	class ara::crypto::x509::X509CustomExtensionsParser
Derived from:	ara::crypto::ReadOnlyMemRegion
Syntax:	using ara::crypto::x509::X509CustomExtensionsParser::Integer = ara::crypto::ReadOnlyMemRegion;
Header file:	#include "ara/crypto/x509/x509_custom_extension_parser.h"
Description:	Type alias.

]([RS_CRYPT_02306](#))

[SWS_CRYPT_40934]{DRAFT} [

Kind:	type alias
Symbol:	NumberOfUnusedBits
Scope:	class ara::crypto::x509::X509CustomExtensionsParser
Derived from:	std::uint8_t
Syntax:	using ara::crypto::x509::X509CustomExtensionsParser::NumberOfUnusedBits = std::uint8_t;
Header file:	#include "ara/crypto/x509/x509_custom_extension_parser.h"
Description:	Type alias.

]([RS_CRYPT_02306](#))

[SWS_CRYPT_40936]{DRAFT} [

Kind:	type alias
Symbol:	OctetString
Scope:	class ara::crypto::x509::X509CustomExtensionsParser
Derived from:	ara::crypto::ReadOnlyMemRegion
Syntax:	using ara::crypto::x509::X509CustomExtensionsParser::OctetString = ara::crypto::ReadOnlyMemRegion;
Header file:	#include "ara/crypto/x509/x509_custom_extension_parser.h"
Description:	Type alias.

]([RS_CRYPT_02306](#))

[SWS_CRYPT_40937]{DRAFT} [

Kind:	type alias
Symbol:	Oid
Scope:	class ara::crypto::x509::X509CustomExtensionsParser
Derived from:	ara::core::StringView
Syntax:	using ara::crypto::x509::X509CustomExtensionsParser::Oid = ara::core::StringView;
Header file:	#include "ara/crypto/x509/x509_custom_extension_parser.h"
Description:	Type alias.

]([RS_CRYPT_02306](#))

[SWS_CRYPT_40939]{DRAFT} [

Kind:	type alias
Symbol:	PrintableString
Scope:	class ara::crypto::x509::X509CustomExtensionsParser
Derived from:	ara::core::StringView
Syntax:	using ara::crypto::x509::X509CustomExtensionsParser::PrintableString = ara::core::StringView;
Header file:	#include "ara/crypto/x509/x509_custom_extension_parser.h"
Description:	Type alias.

]([RS_CRYPT_02306](#))

[SWS_CRYPT_40942]{DRAFT} [

Kind:	type alias
Symbol:	UtcTime
Scope:	class ara::crypto::x509::X509CustomExtensionsParser
Derived from:	ara::core::StringView
Syntax:	using ara::crypto::x509::X509CustomExtensionsParser::UtcTime = ara::core::StringView;
Header file:	#include "ara/crypto/x509/x509_custom_extension_parser.h"
Description:	Type alias.

]([RS_CRYPT_02306](#))

[SWS_CRYPT_40938]{DRAFT} [

Kind:	type alias
Symbol:	Utf8String
Scope:	class ara::crypto::x509::X509CustomExtensionsParser
Derived from:	ara::crypto::ReadOnlyMemRegion
Syntax:	using ara::crypto::x509::X509CustomExtensionsParser::Utf8String = ara::crypto::ReadOnlyMemRegion;
Header file:	#include "ara/crypto/x509/x509_custom_extension_parser.h"
Description:	Type alias.

]([RS_CRYPT_02306](#))

[SWS_CRYPT_40157]{DRAFT} [

Kind:	variable
Symbol:	kConstrCrlSign
Scope:	class ara::crypto::x509::BasicCertInfo
Type:	const KeyConstraints
Syntax:	static const KeyConstraints ara::crypto::x509::BasicCertInfo::kConstrCrlSign = 0x0200;
Header file:	#include "ara/crypto/x509/basic_cert_info.h"
Description:	The key can be used for Certificates Revokation Lists (CRL) signing.

]([RS_CRYPT_02306](#))

[SWS_CRYPT_40154]{DRAFT} [

Kind:	variable
Symbol:	kConstrDataEncipherment
Scope:	class ara::crypto::x509::BasicCertInfo
Type:	const KeyConstraints
Syntax:	static const KeyConstraints ara::crypto::x509::BasicCertInfo::kConstrDataEncipherment = 0x1000;
Header file:	#include "ara/crypto/x509/basic_cert_info.h"
Description:	The key can be used for data encipherment.

]([RS_CRYPT_02306](#))

[SWS_CRYPT_40159]{DRAFT} [

Kind:	variable
Symbol:	kConstrDecipherOnly
Scope:	class ara::crypto::x509::BasicCertInfo
Type:	const KeyConstraints
Syntax:	static const KeyConstraints ara::crypto::x509::BasicCertInfo::kConstrDecipherOnly = 0x0080;
Header file:	#include "ara/crypto/x509/basic_cert_info.h"
Description:	The enciphermet key can be used for deciphering only.

]([RS_CRYPT_02306](#))

[SWS_CRYPT_40151]{DRAFT} [

Kind:	variable
Symbol:	kConstrDigitalSignature
Scope:	class ara::crypto::x509::BasicCertInfo
Type:	const KeyConstraints
Syntax:	static const KeyConstraints ara::crypto::x509::BasicCertInfo::kConstrDigitalSignature = 0x8000;
Header file:	#include "ara/crypto/x509/basic_cert_info.h"
Description:	The key can be used for digital signature production.

]([RS_CRYPT_02306](#))

[SWS_CRYPT_40158]{DRAFT} [

Kind:	variable
Symbol:	kConstrEncipherOnly
Scope:	class ara::crypto::x509::BasicCertInfo
Type:	const KeyConstraints
Syntax:	static const KeyConstraints ara::crypto::x509::BasicCertInfo::kConstrEncipherOnly = 0x0100;
Header file:	#include "ara/crypto/x509/basic_cert_info.h"
Description:	The enciphermet key can be used for enciphering only.

]([RS_CRYPT_02306](#))

[SWS_CRYPT_40155]{DRAFT} [

Kind:	variable
Symbol:	kConstrKeyAgreement
Scope:	class ara::crypto::x509::BasicCertInfo
Type:	const KeyConstraints
Syntax:	static const KeyConstraints ara::crypto::x509::BasicCertInfo::kConstrKeyAgreement = 0x0800;
Header file:	#include "ara/crypto/x509/basic_cert_info.h"
Description:	The key can be used for a key agreement protocol execution.

]([RS_CRYPT_02306](#))

[SWS_CRYPT_40156]{DRAFT} [

Kind:	variable
Symbol:	kConstrKeyCertSign
Scope:	class ara::crypto::x509::BasicCertInfo
Type:	const KeyConstraints
Syntax:	static const KeyConstraints ara::crypto::x509::BasicCertInfo::kConstrKeyCertSign = 0x0400;
Header file:	#include "ara/crypto/x509/basic_cert_info.h"
Description:	The key can be used for certificates signing.

]([RS_CRYPT_02306](#))

[SWS_CRYPT_40153]{DRAFT} [

Kind:	variable
Symbol:	kConstrKeyEncipherment
Scope:	class ara::crypto::x509::BasicCertInfo
Type:	const KeyConstraints
Syntax:	static const KeyConstraints ara::crypto::x509::BasicCertInfo::kConstrKeyEncipherment = 0x2000;
Header file:	#include "ara/crypto/x509/basic_cert_info.h"
Description:	The key can be used for key encipherment.

]([RS_CRYPT_02306](#))

[SWS_CRYPT_40152]{DRAFT} [

Kind:	variable
Symbol:	kConstrNonRepudiation
Scope:	class ara::crypto::x509::BasicCertInfo
Type:	const KeyConstraints
Syntax:	static const KeyConstraints ara::crypto::x509::BasicCertInfo::kConstrNonRepudiation = 0x4000;
Header file:	#include "ara/crypto/x509/basic_cert_info.h"
Description:	The key can be used in cases requiring the "non-repudiation" guarantee.

]([RS_CRYPT_02306](#))

[SWS_CRYPT_40150]{DRAFT} [

Kind:	variable
Symbol:	kConstrNone
Scope:	class ara::crypto::x509::BasicCertInfo
Type:	const KeyConstraints
Syntax:	static const KeyConstraints ara::crypto::x509::BasicCertInfo::kConstrNone = 0;
Header file:	#include "ara/crypto/x509/basic_cert_info.h"
Description:	No key constraints.

]([RS_CRYPT_02306](#))

[SWS_CRYPT_40603]{DRAFT} [

Kind:	variable
Symbol:	kInvalidIndex
Scope:	class ara::crypto::x509::X509Provider
Type:	const StorageIndex
Syntax:	static const StorageIndex ara::crypto::x509::X509Provider::kInvalidIndex = static_cast<std::size_t>(-1LL);
Header file:	#include "ara/crypto/x509/x509_provider.h"
Description:	Reserved "invalid index" value for navigation inside the certificate storage.

]([RS_CRYPT_02306](#))

8.4 API Common Data Types

[SWS_CRYPT_10015]{DRAFT} [

Kind:	type alias
Symbol:	AllowedUsageFlags
Scope:	namespace ara::crypto
Derived from:	std::uint32_t





Syntax:	<code>using ara::crypto::AllowedUsageFlags = std::uint32_t;</code>
Header file:	<code>#include "ara/crypto/common/base_id_types.h"</code>
Description:	A container type and constant bit-flags of allowed usages of a key or a secret seed object. Only directly specified usages of a key are allowed, all other are prohibited! Similar set of flags are defined for the usage restrictions of original key/seed and for a symmetric key or seed that potentially can be derived from the original one. A symmetric key or secret seed can be derived from the original one, only if it supports <code>kAllowKeyAgreement</code> or <code>kAllowKeyDiversify</code> or <code>kAllowKeyDerivation</code> !

]([RS_CRYPTO_02111](#))

[SWS_CRYPT_10042]{DRAFT} [

Kind:	type alias	
Symbol:	ByteVector	
Scope:	namespace ara::crypto	
Derived from:	ara::core::Vector<std::uint8_t, Alloc>	
Syntax:	<code>using ara::crypto::ByteVector = ara::core::Vector<std::uint8_t, Alloc>;</code>	
Template param:	Alloc	custom allocator of bytes sequences
Header file:	<code>#include "ara/crypto/common/base_id_types.h"</code>	
Description:	Alias of a bytes' vector template with customizable allocator.	

]([RS_CRYPTO_02201](#), [RS_CRYPTO_02202](#), [RS_CRYPTO_02203](#), [RS_CRYPTO_02204](#), [RS_CRYPTO_02205](#), [RS_CRYPTO_02206](#), [RS_CRYPTO_02207](#), [RS_CRYPTO_02208](#), [RS_CRYPTO_02209](#))

[SWS_CRYPT_10014]{DRAFT} [

Kind:	type alias	
Symbol:	CryptoAlgId	
Scope:	namespace ara::crypto	
Derived from:	std::uint64_t	
Syntax:	<code>using ara::crypto::CryptoAlgId = std::uint64_t;</code>	
Header file:	<code>#include "ara/crypto/common/base_id_types.h"</code>	
Description:	Container type of the Crypto Algorithm Identifier.	

]([RS_CRYPTO_02102](#), [RS_CRYPTO_02107](#))

[SWS_CRYPT_10016]{DRAFT} [

Kind:	enumeration	
Symbol:	CryptoObjectType	
Scope:	namespace ara::crypto	
Underlying type:	std::uint32_t	
Syntax:	<code>enum class CryptoObjectType : std::uint32_t {...};</code>	
Values:	kUndefined= 0	Object type is currently not defined (empty container)
	kSymmetricKey= 1	crypt::SymmetricKey object



△

	kPrivateKey= 2	crypt::PrivateKey object
	kPublicKey= 3	crypt::PublicKey object
	kSignature= 4	crypt::Signature object (asymmetric digital signature or symmetric MAC/HMAC or hash digest)
	kSecretSeed= 5	crypt::SecretSeed object. Note: the seed cannot have an associated crypto algorithm!
Header file:	#include "ara/crypto/common/base_id_types.h"	
Description:	Enumeration of all types of crypto objects, i.e. types of content that can be stored to a key slot.	

] ([RS_CRYPT_02004](#))

[SWS_CRYPT_10100]{DRAFT} [

Kind:	struct
Symbol:	CryptoObjectUid
Scope:	namespace ara::crypto
Syntax:	struct ara::crypto::CryptoObjectUid {...};
Header file:	#include "ara/crypto/common/crypto_object_uid.h"
Description:	Definition of Crypto Object Unique Identifier (COUID) type.

] ([RS_CRYPT_02005](#), [RS_CRYPT_02006](#))

[SWS_CRYPT_10017]{DRAFT} [

Kind:	enumeration								
Symbol:	ProviderType								
Scope:	namespace ara::crypto								
Underlying type:	std::uint32_t								
Syntax:	enum class ProviderType : std::uint32_t {...};								
Values:	<table border="1"> <tr> <td>kUndefinedProvider= 0</td> <td>Undefined/Unknown Provider type (or applicable for the whole Crypto Stack)</td> </tr> <tr> <td>kCryptoProvider= 1</td> <td>Cryptography Provider.</td> </tr> <tr> <td>kKeyStorageProvider= 2</td> <td>Key Storage Provider.</td> </tr> <tr> <td>kX509Provider= 3</td> <td>X.509 Provider.</td> </tr> </table>	kUndefinedProvider= 0	Undefined/Unknown Provider type (or applicable for the whole Crypto Stack)	kCryptoProvider= 1	Cryptography Provider.	kKeyStorageProvider= 2	Key Storage Provider.	kX509Provider= 3	X.509 Provider.
kUndefinedProvider= 0	Undefined/Unknown Provider type (or applicable for the whole Crypto Stack)								
kCryptoProvider= 1	Cryptography Provider.								
kKeyStorageProvider= 2	Key Storage Provider.								
kX509Provider= 3	X.509 Provider.								
Header file:	#include "ara/crypto/common/base_id_types.h"								
Description:	Enumeration of all known Provider types.								

] ([RS_CRYPT_02401](#), [RS_CRYPT_02109](#))

[SWS_CRYPT_10033]{DRAFT} [

Kind:	type alias
Symbol:	ReadOnlyMemRegion
Scope:	namespace ara::crypto
Derived from:	ara::core::Span<const std::uint8_t>
Syntax:	using ara::crypto::ReadOnlyMemRegion = ara::core::Span<const std::uint8_t>;
Header file:	#include "ara/crypto/common/mem_region.h"
Description:	Read-Only Memory Region (intended for [in] arguments)

](RS_CRYPT_02004)

[SWS_CRYPT_10031]{DRAFT} [

Kind:	type alias
Symbol:	ReadWriteMemRegion
Scope:	namespace ara::crypto
Derived from:	ara::core::Span<std::uint8_t>
Syntax:	using ara::crypto::ReadWriteMemRegion = ara::core::Span<std::uint8_t>;
Header file:	#include "ara/crypto/common/mem_region.h"
Description:	Read-Write Memory Region (intended for [in/out] arguments)

](RS_CRYPT_02004)

[SWS_CRYPT_10099]{DRAFT} [

Kind:	enumeration	
Symbol:	CryptoErrc	
Scope:	namespace ara::crypto	
Underlying type:	ara::core::ErrorDomain::CodeType	
Syntax:	enum class CryptoErrc : ara::core::ErrorDomain::CodeType {...};	
Values:	kErrorClass= 0x1000000	Reserved (a multiplier of error class IDs)
	kErrorSubClass= 0x10000	Reserved (a multiplier of error sub-class IDs)
	kErrorSubSubClass= 0x100	Reserved (a multiplier of error sub-sub-class IDs)
	kResourceFault= 1 * kErrorClass	ResourceException: Generic resource fault!
	kBusyResource= kResourceFault + 1	ResourceException: Specified resource is busy!
	kInsufficientResource= kResourceFault + 2	ResourceException: Insufficient capacity of specified resource!
	kUnreservedResource= kResourceFault + 3	ResourceException: Specified resource was not reserved!
	kModifiedResource= kResourceFault + 4	ResourceException: Specified resource has been modified!
	kLogicFault= 2 * kErrorClass	LogicException: Generic logic fault!
	kInvalidArgument= kLogicFault + 1 * kErrorSubClass	InvalidArgumentException: An invalid argument value is provided!
	kUnknownIdentifier= kInvalidArgument + 1	InvalidArgumentException: Unknown identifier is provided!
	kInsufficientCapacity= kInvalidArgument + 2	InvalidArgumentException: Insufficient capacity of the output buffer!
	kInvalidInputSize= kInvalidArgument + 3	InvalidArgumentException: Invalid size of an input buffer!
	kIncompatibleArguments= kInvalidArgument + 4	InvalidArgumentException: Provided values of arguments are incompatible!
	kInOutBuffersIntersect= kInvalidArgument + 5	InvalidArgumentException: Input and output buffers are intersect!
kBelowBoundary= kInvalidArgument + 6	InvalidArgumentException: Provided value is below the lower boundary!	
kAboveBoundary= kInvalidArgument + 7	InvalidArgumentException: Provided value is above the upper boundary!	
kAuthTagNotValid= kInvalidArgument + 8	AuthTagNotValidException: Provided authentication-tag cannot be verified!	



△

	kUnsupported= kInvalidArgument + 1 * kErrorSubSubClass	UnsupportedException: Unsupported request (due to limitations of the implementation)!
	kInvalidUsageOrder= kLogicFault + 2 * kErrorSubClass	InvalidUsageOrderException: Invalid usage order of the interface!
	kUninitializedContext= kInvalidUsageOrder + 1	InvalidUsageOrderException: Context of the interface was not initialized!
	kProcessingNotStarted= kInvalidUsageOrder + 2	InvalidUsageOrderException: Data processing was not started yet!
	kProcessingNotFinished= kInvalidUsageOrder + 3	InvalidUsageOrderException: Data processing was not finished yet!
	kRuntimeFault= 3 * kErrorClass	RuntimeException: Generic runtime fault!
	kUnsupportedFormat= kRuntimeFault + 1	RuntimeException: Unsupported serialization format for this object type!
	kBruteForceRisk= kRuntimeFault + 2	RuntimeException: Operation is prohibited due to a risk of a brute force attack!
	kContentRestrictions= kRuntimeFault + 3	RuntimeException: The operation violates content restrictions of the target container!
	kBadObjectReference= kRuntimeFault + 4	RuntimeException: Incorrect reference between objects!
	kContentDuplication= kRuntimeFault + 6	RuntimeException: Provided content already exists in the target storage!
	kUnexpectedValue= kRuntimeFault + 1 * kErrorSubClass	UnexpectedValueException: Unexpected value of an argument is provided!
	kIncompatibleObject= kUnexpectedValue + 1	UnexpectedValueException: The provided object is incompatible with requested operation or its configuration!
	kIncompleteArgState= kUnexpectedValue + 2	UnexpectedValueException: Incomplete state of an argument!
	kEmptyContainer= kUnexpectedValue + 3	UnexpectedValueException: Specified container is empty!
	kMissingArgument= kUnexpectedValue + 4	kMissingArgumentException: Expected argument, but none provided!
	kBadObjectType= kUnexpectedValue + 1 * kErrorSubSubClass	BadObjectTypeException: Provided object has unexpected type!
	kUsageViolation= kRuntimeFault + 2 * kErrorSubClass	UsageViolationException: Violation of allowed usage for the object!
	kAccessViolation= kRuntimeFault + 3 * kErrorSubClass	AccessViolationException: Access rights violation!
Header file:	#include "ara/crypto/common/crypto_error_domain.h"	
Description:	Enumeration of all Crypto Error Code values that may be reported by ara::crypto.	

|(RS_CRYPT_02310)

[SWS_CRYPT_30001]{DRAFT} [

Kind:	struct
Symbol:	SecureCounter
Scope:	namespace ara::crypto
Syntax:	<code>struct ara::crypto::SecureCounter {...};</code>
Header file:	#include "ara/crypto/common/entry_point.h"
Description:	128 bit secure counter made up of most significant and least significant quad-word of the hardware counter.

|(RS_CRYPT_02401)

[SWS_CRYPT_10701]{DRAFT} [

Kind:	type alias
Symbol:	FormatId
Scope:	class ara::crypto::Serializable
Derived from:	std::uint32_t
Syntax:	using ara::crypto::Serializable::FormatId = std::uint32_t;
Header file:	#include "ara/crypto/common/serializable.h"
Description:	A container type for the encoding format identifiers.

] ([RS_CRYPT_02004](#), [RS_CRYPT_02302](#))

[SWS_CRYPT_10019]{DRAFT} [

Kind:	enumeration	
Symbol:	CryptoTransform	
Scope:	namespace ara::crypto	
Underlying type:	std::uint32_t	
Syntax:	enum class CryptoTransform : std::uint32_t {...};	
Values:	kEncrypt= 1	encryption
	kDecrypt= 2	decryption
	kMacVerify= 3	MAC verification.
	kMacGenerate= 4	MAC generation.
	kWrap= 5	key wrapping
	kUnwrap= 6	key unwrapping
	kSigVerify= 7	signature verification
	kSigGenerate= 8	signature generation
Header file:	#include "ara/crypto/common/base_id_types.h"	
Description:	Enumeration of cryptographic transformations.	

] ([RS_CRYPT_02004](#))

[SWS_CRYPT_10852]{DRAFT} [

Kind:	type alias
Symbol:	Uptr
Scope:	class ara::crypto::VolatileTrustedContainer
Derived from:	std::unique_ptr<VolatileTrustedContainer>
Syntax:	using ara::crypto::VolatileTrustedContainer::Uptr = std::unique_ptr<VolatileTrustedContainer>;
Header file:	#include "ara/crypto/common/volatile_trusted_container.h"
Description:	Unique smart pointer of the interface.

] ([RS_CRYPT_02004](#))

[SWS_CRYPT_10400]{DRAFT} [

Kind:	struct
Symbol:	Uuid
Scope:	namespace ara::crypto
Syntax:	<code>struct ara::crypto::Uuid {...};</code>
Header file:	<code>#include "ara/crypto/common/uuid.h"</code>
Description:	Definition of Universally Unique Identifier (UUID) type. Independently from internal definition details of this structure, it's size must be 16 bytes and entropy of this ID should be close to 128 bit!

]([RS_CRYPT_02005](#))

[SWS_CRYPT_10801]{DRAFT} [

Kind:	type alias
Symbol:	Uptr
Scope:	class ara::crypto::IOInterface
Derived from:	<code>std::unique_ptr<IOInterface></code>
Syntax:	<code>using ara::crypto::IOInterface::Uptr = std::unique_ptr<IOInterface>;</code>
Header file:	<code>#include "ara/crypto/common/io_interface.h"</code>
Description:	Unique smart pointer of the interface.

]([RS_CRYPT_02109](#))

[SWS_CRYPT_10802]{DRAFT} [

Kind:	type alias
Symbol:	Uptrc
Scope:	class ara::crypto::IOInterface
Derived from:	<code>std::unique_ptr<const IOInterface></code>
Syntax:	<code>using ara::crypto::IOInterface::Uptrc = std::unique_ptr<const IOInterface>;</code>
Header file:	<code>#include "ara/crypto/common/io_interface.h"</code>
Description:	Unique smart pointer of the constant interface.

]([RS_CRYPT_02109](#))

[SWS_CRYPT_19903]{DRAFT} [

Kind:	type alias
Symbol:	Errc
Scope:	class ara::crypto::CryptoErrorDomain
Derived from:	CryptoErrc
Syntax:	<code>using ara::crypto::CryptoErrorDomain::Errc = CryptoErrc;</code>
Header file:	<code>#include "ara/crypto/common/crypto_error_domain.h"</code>
Description:	crypto error

]([RS_CRYPT_02310](#))

[SWS_CRYPT_19904]{DRAFT} [

Kind:	type alias
Symbol:	Exception
Scope:	class ara::crypto::CryptoErrorDomain
Derived from:	CryptoException
Syntax:	<code>using ara::crypto::CryptoErrorDomain::Exception = CryptoException;</code>
Header file:	<code>#include "ara/crypto/common/crypto_error_domain.h"</code>
Description:	Alias for the exception base class.

]([RS_CRYPT_02310](#))

[SWS_CRYPT_10018]{DRAFT} [

Kind:	enumeration	
Symbol:	KeySlotType	
Scope:	namespace ara::crypto	
Underlying type:	std::uint32_t	
Syntax:	<code>enum class KeySlotType : std::uint32_t {...};</code>	
Values:	kMachine= 1	machine type key-slot - can be managed by application
	kApplication= 2	application exclusive type key-slot
Header file:	<code>#include "ara/crypto/common/base_id_types.h"</code>	
Description:	Enumeration of key-slot types; currently only machine and applicaiton key-slots are defined.	

]([RS_CRYPT_02004](#))

8.5 API Reference

[SWS_CRYPT_10800]{DRAFT} [

Kind:	class
Symbol:	IOInterface
Scope:	namespace ara::crypto
Syntax:	<code>class ara::crypto::IOInterface {...};</code>
Header file:	<code>#include "ara/crypto/common/io_interface.h"</code>
Description:	Formal interface of an IOInterface is used for saving and loading of security objects. Actual saving and loading should be implemented by internal methods known to a trusted pair of Crypto Provider and Storage Provider. Each object should be uniquely identified by its type and Crypto Object Unique Identifier (COUID). This interface suppose that objects in the container are compressed i.e. have a minimal size optimized for.

]([RS_CRYPT_02004](#))

[SWS_CRYPT_10700]{DRAFT} [

Kind:	class
Symbol:	Serializable
Scope:	namespace ara::crypto
Syntax:	<code>class ara::crypto::Serializable {...};</code>
Header file:	<code>#include "ara/crypto/common/serializable.h"</code>
Description:	Serializable object interface.

]([RS_CRYPT_02105](#))

[SWS_CRYPT_10850]{DRAFT} [

Kind:	class
Symbol:	VolatileTrustedContainer
Scope:	namespace ara::crypto
Syntax:	<code>class ara::crypto::VolatileTrustedContainer {...};</code>
Header file:	<code>#include "ara/crypto/common/volatile_trusted_container.h"</code>
Description:	This explicit interface of a volatile Trusted Container is used for buffering CryptoAPI objects in RAM. This class represents a "smart buffer" in that it provides access to the IOInterface, which can be used for querying meta-data of the buffer content.

]([RS_CRYPT_02004](#))

[SWS_CRYPT_19905]{DRAFT} [

Kind:	class
Symbol:	CryptoException
Scope:	namespace ara::crypto
Base class:	ara::core::Exception
Syntax:	<code>class ara::crypto::CryptoException : public ara::core::Exception {...};</code>
Header file:	<code>#include "ara/crypto/common/crypto_error_domain.h"</code>
Description:	Exception type thrown for CRYPTO errors.

]([RS_CRYPT_02310](#))

[SWS_CRYPT_19900]{DRAFT} [

Kind:	class
Symbol:	CryptoErrorDomain
Scope:	namespace ara::crypto
Base class:	ara::core::ErrorDomain
Syntax:	<code>class ara::crypto::CryptoErrorDomain final : public ara::core::ErrorDomain {...};</code>
Unique ID:	0x8000'0000'0000'0801
Header file:	<code>#include "ara/crypto/common/crypto_error_domain.h"</code>





Description:	Crypto Error Domain class that provides interfaces as defined by <code>ara::core::ErrorDomain</code> such as a name of the Crypto Error Domain or messages for each error code. This class represents an error domain responsible for all errors that may be reported by public APIs in <code>ara::crypto</code> namespace. .
---------------------	---

]([RS_AP_00130](#))

[SWS_CRYPT_19951]{DRAFT} [

Kind:	function	
Symbol:	MakeErrorCode(CryptoErrorDomain::Errc code, ara::core::ErrorDomain::SupportDataType data)	
Scope:	namespace ara::crypto	
Syntax:	constexpr ara::core::ErrorCode ara::crypto::MakeErrorCode (CryptoErrorDomain::Errc code, ara::core::ErrorDomain::SupportDataType data) noexcept;	
Parameters (in):	code	an error code identifier from the CryptoErrc enumeration
	data	supplementary data for the error description
Return value:	ara::core::ErrorCode	an instance of ErrorCode created according the arguments
Exception Safety:	noexcept	
Header file:	#include "ara/crypto/common/crypto_error_domain.h"	
Description:	Makes Error Code instances from the Crypto Error Domain. The returned ErrorCode instance always references to CryptoErrorDomain.	

]([RS_CRYPT_02310](#))

[SWS_CRYPT_20099]{DRAFT} [

Kind:	function	
Symbol:	LoadCryptoProvider(const ara::core::InstanceSpecifier &iSpecify)	
Scope:	namespace ara::crypto	
Syntax:	ara::crypto::crypt::CryptoProvider::Uptr ara::crypto::LoadCryptoProvider (const ara::core::InstanceSpecifier &iSpecify) noexcept;	
Parameters (in):	iSpecify	the globally unique identifier of required Crypto Provider
Return value:	ara::crypto::crypt::CryptoProvider::Uptr	unique smart pointer to loaded Crypto Provider
Exception Safety:	noexcept	
Thread Safety:	Thread-safe	
Header file:	#include "ara/crypto/common/entry_point.h"	
Description:	Factory that creates or return existing single instance of specific Crypto Provider. If (providerUid == nullptr) then platform default provider should be loaded.	

]([RS_CRYPT_02401](#), [RS_CRYPT_02301](#))

[SWS_CRYPT_30099]{DRAFT} [

Kind:	function	
Symbol:	LoadKeyStorageProvider()	
Scope:	namespace ara::crypto	





Syntax:	<code>ara::crypto::keys::KeyStorageProvider::Uptr ara::crypto::LoadKeyStorageProvider () noexcept;</code>	
Return value:	<code>ara::crypto::keys::KeyStorageProvider::Uptr</code>	unique smart pointer to loaded Key Storage Provider
Exception Safety:	noexcept	
Thread Safety:	Thread-safe	
Errors:	<code>CryptoErrorDomain::kRuntimeFault</code>	if the Key Storage Provider instance cannot be created
Header file:	<code>#include "ara/crypto/common/entry_point.h"</code>	
Description:	Factory that creates or return existing single instance of the Key Storage Provider.	

]([RS_CRYPT_02109](#), [RS_CRYPT_02401](#), [RS_CRYPT_02301](#))

[SWS_CRYPT_40099]{DRAFT} [

Kind:	function	
Symbol:	<code>LoadX509Provider()</code>	
Scope:	namespace <code>ara::crypto</code>	
Syntax:	<code>ara::crypto::x509::X509Provider::Uptr ara::crypto::LoadX509Provider () noexcept;</code>	
Return value:	<code>ara::crypto::x509::X509Provider::Uptr</code>	unique smart pointer to loaded X.509 Provider
Exception Safety:	noexcept	
Thread Safety:	Thread-safe	
Errors:	<code>CryptoErrorDomain::kRuntimeFault</code>	if the X.509 Provider cannot be loaded
Header file:	<code>#include "ara/crypto/common/entry_point.h"</code>	
Description:	Factory that creates or return existing single instance of the X.509 Provider. X.509 Provider should use the default Crypto Provider for hashing and signature verification! Therefore when you load the X.509 Provider, in background it loads the default Crypto Provider too.	

]([RS_CRYPT_02306](#), [RS_CRYPT_02301](#))

[SWS_CRYPT_30098]{DRAFT} [

Kind:	function	
Symbol:	<code>GenerateRandomData(std::uint32_t count)</code>	
Scope:	namespace <code>ara::crypto</code>	
Syntax:	<code>ara::core::Result<ara::core::Vector<ara::core::Byte> > ara::crypto::GenerateRandomData (std::uint32_t count) noexcept;</code>	
Parameters (in):	<code>count</code>	number of random bytes to generate
Return value:	<code>ara::core::Result< ara::core::Vector< ara::core::Byte > ></code>	a buffer filled with the generated random sequence
Exception Safety:	noexcept	
Thread Safety:	Thread-safe	
Errors:	<code>CryptoErrorDomain::kBusyResource</code>	if the used RNG is currently out-of-entropy and therefore cannot provide the requested number of random bytes
Header file:	<code>#include "ara/crypto/common/entry_point.h"</code>	
Description:	Return an allocated buffer with a generated random sequence of the requested size.	

]([RS_CRYPT_02206](#))

[SWS_CRYPT_20098]{DRAFT} [

Kind:	function	
Symbol:	GetSecureCounter()	
Scope:	namespace ara::crypto	
Syntax:	<pre>ara::core::Result<SecureCounter> ara::crypto::GetSecureCounter () noexcept;</pre>	
Return value:	ara::core::Result< SecureCounter >	a SecureCounter struct made up of the two unsigned 64 bit values (LSQW and MSQW)
Exception Safety:	noexcept	
Thread Safety:	Thread-safe	
Errors:	CryptoErrorDomain::kUnsupported	if the Secure Counter is unsupported by the Crypto Stack implementation on this Platform
	CryptoErrorDomain::kAccessViolation	if current Actor has no permission to call this routine
Header file:	#include "ara/crypto/common/entry_point.h"	
Description:	<p>Get current value of 128 bit Secure Counter supported by the Crypto Stack. Secure Counter is a non-rollover monotonic counter that ensures incrementation of its value for each following call. The Secure Counter is presented by two 64 bit components: Most Significant Quadword (MSQW) and Least Significant Quadword (LSQW). During normal operation of the Crypto Stack, the MSQW value is fixed (unchangeable) and only LSQW should be incremented. The LSQW counter can be implemented in the "low-power" (always-powered-up) domain of the main CPU, but the MSQW in the Flash/EEPROM storage. But the MSQW must be incremented if the LSQW reaches the maximum value of all ones. Also the MSQW must be incremented during reinitialisation of the whole Crypto Stack (e.g. if the "low-power" supply was interrupted by some reason). Permission to execute this routine is subject of Identity and Access Management control and may be restricted by application manifest!</p>	

] ([RS_CRYPT_02401](#))

[SWS_CRYPT_10112]{DRAFT} [

Kind:	function	
Symbol:	HasEarlierVersionThan(const CryptoObjectUid &anotherId)	
Scope:	struct ara::crypto::CryptoObjectUid	
Syntax:	<pre>constexpr bool ara::crypto::CryptoObjectUid::HasEarlierVersionThan (const CryptoObjectUid &anotherId) const noexcept;</pre>	
Parameters (in):	anotherId	another identifier for the comparison
Return value:	bool	true if this identifier was generated earlier than the anotherId
Exception Safety:	noexcept	
Thread Safety:	Reentrant	
Header file:	#include "ara/crypto/common/crypto_object_uid.h"	
Description:	Check whether this identifier was generated earlier than the one provided by the argument.	

] ([RS_CRYPT_02006](#))

[SWS_CRYPT_10113]{DRAFT} [

Kind:	function	
Symbol:	HasLaterVersionThan(const CryptoObjectUid &anotherId)	
Scope:	struct ara::crypto::CryptoObjectUid	





Syntax:	<code>constexpr bool ara::crypto::CryptoObjectUid::HasLaterVersionThan (const CryptoObjectUid &anotherId) const noexcept;</code>	
Parameters (in):	<code>anotherId</code>	another identifier for the comparison
Return value:	<code>bool</code>	true if this identifier was generated later than the <code>anotherId</code>
Exception Safety:	<code>noexcept</code>	
Thread Safety:	<code>Reentrant</code>	
Header file:	<code>#include "ara/crypto/common/crypto_object_uid.h"</code>	
Description:	Check whether this identifier was generated later than the one provided by the argument.	

|(RS_CRYPT_02006)

[SWS_CRYPT_10111]{DRAFT} [

Kind:	function	
Symbol:	<code>HasSameSourceAs(const CryptoObjectUid &anotherId)</code>	
Scope:	struct ara::crypto::CryptoObjectUid	
Syntax:	<code>constexpr bool ara::crypto::CryptoObjectUid::HasSameSourceAs (const CryptoObjectUid &anotherId) const noexcept;</code>	
Parameters (in):	<code>anotherId</code>	another identifier for the comparison
Return value:	<code>bool</code>	true if both identifiers has common source (identical value of the <code>mGeneratorUid</code> field)
Exception Safety:	<code>noexcept</code>	
Thread Safety:	<code>Reentrant</code>	
Header file:	<code>#include "ara/crypto/common/crypto_object_uid.h"</code>	
Description:	Check whether this identifier has a common source with the one provided by the argument.	

|(RS_CRYPT_02006)

[SWS_CRYPT_10114]{DRAFT} [

Kind:	function	
Symbol:	<code>IsNil()</code>	
Scope:	struct ara::crypto::CryptoObjectUid	
Syntax:	<code>bool ara::crypto::CryptoObjectUid::IsNil () const noexcept;</code>	
Return value:	<code>bool</code>	true if this identifier is "Nil" and false otherwise
Exception Safety:	<code>noexcept</code>	
Thread Safety:	<code>Reentrant</code>	
Header file:	<code>#include "ara/crypto/common/crypto_object_uid.h"</code>	
Description:	Check whether this identifier is "Nil".	

|(RS_CRYPT_02006)

[SWS_CRYPT_10115]{DRAFT} [

Kind:	function	
Symbol:	<code>SourcesNil()</code>	
Scope:	struct ara::crypto::CryptoObjectUid	





Syntax:	<code>bool ara::crypto::CryptoObjectUId::SourceIsNil () const noexcept;</code>	
Return value:	<code>bool</code>	true if this identifier is "Nil" and false otherwise
Exception Safety:	noexcept	
Thread Safety:	Reentrant	
Header file:	<code>#include "ara/crypto/common/crypto_object_uid.h"</code>	
Description:	Check whether this object's generator identifier is "Nil".	

]([RS_CRYPT_02006](#))

[SWS_CRYPT_10810]{DRAFT} [

Kind:	function	
Symbol:	<code>~IOInterface()</code>	
Scope:	class ara::crypto::IOInterface	
Syntax:	<code>virtual ara::crypto::IOInterface::~~IOInterface () noexcept=default;</code>	
Exception Safety:	noexcept	
Header file:	<code>#include "ara/crypto/common/io_interface.h"</code>	
Description:	Destructor.	

]([RS_CRYPT_02004](#))

[SWS_CRYPT_10819]{DRAFT} [

Kind:	function	
Symbol:	<code>GetAllowedUsage()</code>	
Scope:	class ara::crypto::IOInterface	
Syntax:	<code>virtual AllowedUsageFlags ara::crypto::IOInterface::GetAllowedUsage () const noexcept=0;</code>	
Return value:	<code>AllowedUsageFlags</code>	allowed key/seed usage flags
Exception Safety:	noexcept	
Thread Safety:	Thread-safe	
Header file:	<code>#include "ara/crypto/common/io_interface.h"</code>	
Description:	Return actual allowed key/seed usage flags defined by the key slot prototype for this "Actor" and current content of the container. Volatile containers don't have any prototyped restrictions, but can have restrictions defined at run-time for a current instance of object. A value returned by this method is bitwise AND of the common usage flags defined at run-time and the usage flags defined by the UserPermissions prototype for current "Actor". This method is especially useful for empty permanent prototyped containers.	

]([RS_CRYPT_02008](#))

[SWS_CRYPT_10813]{DRAFT} [

Kind:	function	
Symbol:	<code>GetCapacity()</code>	
Scope:	class ara::crypto::IOInterface	
Syntax:	<code>virtual std::size_t ara::crypto::IOInterface::GetCapacity () const noexcept=0;</code>	
Return value:	<code>std::size_t</code>	capacity of the underlying buffer of this IOInterface (in bytes)





Exception Safety:	noexcept
Thread Safety:	Thread-safe
Header file:	#include "ara/crypto/common/io_interface.h"
Description:	Return capacity of the underlying resource.

]([RS_CRYPT_02110](#))

[SWS_CRYPT_10812]{DRAFT} [

Kind:	function
Symbol:	GetCryptoObjectType()
Scope:	class ara::crypto::IOInterface
Syntax:	virtual CryptoObjectType ara::crypto::IOInterface::GetCryptoObjectType () const noexcept=0;
Return value:	CryptoObjectType the CryptoObjectType stored inside the referenced resource
Exception Safety:	noexcept
Thread Safety:	Thread-safe
Header file:	#include "ara/crypto/common/io_interface.h"
Description:	Return the CryptoObjectType of the object referenced by this IOInterface.

]([RS_CRYPT_02110](#))

[SWS_CRYPT_10811]{DRAFT} [

Kind:	function
Symbol:	GetObjectId()
Scope:	class ara::crypto::IOInterface
Syntax:	virtual CryptoObjectId ara::crypto::IOInterface::GetObjectId () const noexcept=0;
Return value:	CryptoObjectId type of the content stored in the container
Exception Safety:	noexcept
Thread Safety:	Thread-safe
Header file:	#include "ara/crypto/common/io_interface.h"
Description:	Return COUID of an object stored to this IOInterface. If the container is empty then this method returns CryptoObjectType::KUndefined. Unambiguous identification of a crypto object requires both components: CryptoObjectId and CryptoObjectType.

]([RS_CRYPT_02004](#))

[SWS_CRYPT_10817]{DRAFT} [

Kind:	function
Symbol:	GetPayloadSize()
Scope:	class ara::crypto::IOInterface
Syntax:	virtual std::size_t ara::crypto::IOInterface::GetPayloadSize () const noexcept=0;
Return value:	std::size_t size of an object payload stored in the underlying buffer of this IOInterface (in bytes)





Exception Safety:	noexcept
Thread Safety:	Thread-safe
Header file:	#include "ara/crypto/common/io_interface.h"
Description:	Return size of an object payload stored in the underlying buffer of this IOInterface. If the container is empty then this method returns 0. Returned value does not take into account the object's meta-information properties, but their size is fixed and common for all crypto objects independently from their actual type. space for an object's meta-information automatically, according to their implementation details.

]([RS_CRYPT_02109](#))

[SWS_CRYPT_10822]{DRAFT} [

Kind:	function
Symbol:	GetPrimitiveId()
Scope:	class ara::crypto::IOInterface
Syntax:	virtual CryptoAlgId ara::crypto::IOInterface::GetPrimitiveId () const noexcept=0;
Return value:	CryptoAlgId the binary Crypto Primitive ID
Exception Safety:	noexcept
Thread Safety:	Thread-safe
Header file:	#include "ara/crypto/common/io_interface.h"
Description:	Get vendor specific ID of the primitive.

]([RS_CRYPT_02004](#))

[SWS_CRYPT_10818]{DRAFT} [

Kind:	function
Symbol:	GetTypeRestriction()
Scope:	class ara::crypto::IOInterface
Syntax:	virtual CryptoObjectType ara::crypto::IOInterface::GetTypeRestriction () const noexcept=0;
Return value:	CryptoObjectType an object type of allowed content (CryptoObjectType::kUndefined means without restriction)
Exception Safety:	noexcept
Thread Safety:	Thread-safe
Header file:	#include "ara/crypto/common/io_interface.h"
Description:	Return content type restriction of this IOInterface. If KeySlotPrototypeProps::mAllowContentTypeChange==TRUE, then kUndefined shall be returned. If a container has a type restriction different from CryptoObjectType::kUndefined then only objects of the mentioned type can be saved to this container. Volatile containers don't have any content type restrictions.

]([RS_CRYPT_02004](#), [RS_CRYPT_02110](#))

[SWS_CRYPT_10816]{DRAFT} [

Kind:	function
Symbol:	IsObjectExportable()
Scope:	class ara::crypto::IOInterface





Syntax:	<code>virtual bool ara::crypto::IOInterface::IsObjectExportable () const noexcept=0;</code>	
Return value:	bool	true if an object stored to the container has set the "exportable" attribute
Exception Safety:	noexcept	
Thread Safety:	Thread-safe	
Header file:	#include "ara/crypto/common/io_interface.h"	
Description:	Return the "exportable" attribute of an object stored to the container. The exportability of an object doesn't depend from the volatility of its container.	

](RS_CRYPT_02109)

[SWS_CRYPT_10815]{DRAFT} [

Kind:	function	
Symbol:	IsObjectSession()	
Scope:	class ara::crypto::IOInterface	
Syntax:	<code>virtual bool ara::crypto::IOInterface::IsObjectSession () const noexcept=0;</code>	
Return value:	bool	true if the object referenced by this IOInterface has set the "session" attribute
Exception Safety:	noexcept	
Thread Safety:	Thread-safe	
Header file:	#include "ara/crypto/common/io_interface.h"	
Description:	Return the "session" (or "temporary") attribute of an object as set e.g. by KeyDerivation FunctionCtx::DeriveKey(). A "session" object can be stored to a VolatileTrustedContainer only! If this IOInterface is linked to a KeySlot this returns always false.	

](RS_CRYPT_02109)

[SWS_CRYPT_10814]{DRAFT} [

Kind:	function	
Symbol:	IsVolatile()	
Scope:	class ara::crypto::IOInterface	
Syntax:	<code>virtual bool ara::crypto::IOInterface::IsVolatile () const noexcept=0;</code>	
Return value:	bool	true if the container has a volatile nature (i.e. "temporary" or "in RAM") or false otherwise
Exception Safety:	noexcept	
Thread Safety:	Thread-safe	
Header file:	#include "ara/crypto/common/io_interface.h"	
Description:	Return volatility of the the underlying buffer of this IOInterface. A "session" object can be stored to a "volatile" container only. A content of a "volatile" container will be destroyed together with the interface instance.	

](RS_CRYPT_02109)

[SWS_CRYPT_10823]{DRAFT} [

Kind:	function	
Symbol:	IsValid()	
Scope:	class ara::crypto::IOInterface	
Syntax:	virtual bool ara::crypto::IOInterface::IsValid () const noexcept=0;	
Return value:	bool	true if the underlying resource can be valid, false otherwise
Exception Safety:	noexcept	
Thread Safety:	Thread-safe	
Header file:	#include "ara/crypto/common/io_interface.h"	
Description:	Get whether the underlying KeySlot is valid. An IOInterface is invalidated if the underlying resource has been modified after the IOInterface has been opened.	

]([RS_CRYPT_02004](#))

[SWS_CRYPT_10821]{DRAFT} [

Kind:	function	
Symbol:	IsWritable()	
Scope:	class ara::crypto::IOInterface	
Syntax:	virtual bool ara::crypto::IOInterface::IsWritable () const noexcept=0;	
Return value:	bool	true if the underlying resource can be written
Exception Safety:	noexcept	
Thread Safety:	Thread-safe	
Header file:	#include "ara/crypto/common/io_interface.h"	
Description:	Get whether the underlying KeySlot is writable - if this IOInterface is linked to a VolatileTrusted Container always return true.	

]([RS_CRYPT_02004](#))

[SWS_CRYPT_30202]{DRAFT} [

Kind:	function	
Symbol:	operator=(const IOInterface &other)	
Scope:	class ara::crypto::IOInterface	
Syntax:	IOInterface& ara::crypto::IOInterface::operator= (const IOInterface &other)=default;	
Parameters (in):	other	the other instance
Return value:	IOInterface &	*this, containing the contents of other
Header file:	#include "ara/crypto/common/io_interface.h"	
Description:	Copy-assign another IOInterface to this instance.	

]([RS_CRYPT_02004](#))

[SWS_CRYPT_30203]{DRAFT} [

Kind:	function	
Symbol:	operator=(IOInterface &&other)	
Scope:	class ara::crypto::IOInterface	



△

Syntax:	<code>IOInterface& ara::crypto::IOInterface::operator= (IOInterface &&other)=default;</code>	
Parameters (in):	other	the other instance
Return value:	IOInterface &	*this, containing the contents of other
Header file:	#include "ara/crypto/common/io_interface.h"	
Description:	Move-assign another IOInterface to this instance.	

]([RS_CRYPT_02004](#))

[SWS_CRYPT_10150]{DRAFT} [

Kind:	function	
Symbol:	<code>operator==(const CryptoObjectUid &lhs, const CryptoObjectUid &rhs)</code>	
Scope:	namespace ara::crypto	
Syntax:	<code>constexpr bool ara::crypto::operator==(const CryptoObjectUid &lhs, const CryptoObjectUid &rhs) noexcept;</code>	
Parameters (in):	lhs	left-hand side operand
	rhs	right-hand side operand
Return value:	bool	true if all members' values of lhs is equal to rhs, and false otherwise
Exception Safety:	noexcept	
Thread Safety:	Thread-safe	
Header file:	#include "ara/crypto/common/crypto_object_uid.h"	
Description:	Comparison operator "equal" for CryptoObjectUid operands.	

]([RS_CRYPT_02005](#))

[SWS_CRYPT_10151]{DRAFT} [

Kind:	function	
Symbol:	<code>operator<(const CryptoObjectUid &lhs, const CryptoObjectUid &rhs)</code>	
Scope:	namespace ara::crypto	
Syntax:	<code>constexpr bool ara::crypto::operator<(const CryptoObjectUid &lhs, const CryptoObjectUid &rhs) noexcept;</code>	
Parameters (in):	lhs	left-hand side operand
	rhs	right-hand side operand
Return value:	bool	true if a binary representation of lhs is less than rhs, and false otherwise
Exception Safety:	noexcept	
Thread Safety:	Thread-safe	
Header file:	#include "ara/crypto/common/crypto_object_uid.h"	
Description:	Comparison operator "less than" for CryptoObjectUid operands.	

]([RS_CRYPT_02005](#))

[SWS_CRYPT_10152]{DRAFT} [

Kind:	function	
Symbol:	operator>(const CryptoObjectUId &lhs, const CryptoObjectUId &rhs)	
Scope:	namespace ara::crypto	
Syntax:	constexpr bool ara::crypto::operator> (const CryptoObjectUId &lhs, const CryptoObjectUId &rhs) noexcept;	
Parameters (in):	lhs	left-hand side operand
	rhs	right-hand side operand
Return value:	bool	true if a binary representation of lhs is greater than rhs, and false otherwise
Exception Safety:	noexcept	
Thread Safety:	Thread-safe	
Header file:	#include "ara/crypto/common/crypto_object_uid.h"	
Description:	Comparison operator "greater than" for CryptoObjectUId operands.	

] ([RS_CRYPT_02005](#))

[SWS_CRYPT_10153]{DRAFT} [

Kind:	function	
Symbol:	operator!=(const CryptoObjectUId &lhs, const CryptoObjectUId &rhs)	
Scope:	namespace ara::crypto	
Syntax:	constexpr bool ara::crypto::operator!= (const CryptoObjectUId &lhs, const CryptoObjectUId &rhs) noexcept;	
Parameters (in):	lhs	left-hand side operand
	rhs	right-hand side operand
Return value:	bool	true if at least one member of lhs has a value not equal to correspondent member of rhs, and false otherwise
Exception Safety:	noexcept	
Thread Safety:	Thread-safe	
Header file:	#include "ara/crypto/common/crypto_object_uid.h"	
Description:	Comparison operator "not equal" for CryptoObjectUId operands.	

] ([RS_CRYPT_02005](#))

[SWS_CRYPT_10154]{DRAFT} [

Kind:	function	
Symbol:	operator<=(const CryptoObjectUId &lhs, const CryptoObjectUId &rhs)	
Scope:	namespace ara::crypto	
Syntax:	constexpr bool ara::crypto::operator<= (const CryptoObjectUId &lhs, const CryptoObjectUId &rhs) noexcept;	
Parameters (in):	lhs	left-hand side operand
	rhs	right-hand side operand
Return value:	bool	true if a binary representation of lhs is less than or equal to rhs, and false otherwise
Exception Safety:	noexcept	
Thread Safety:	Thread-safe	





Header file:	#include "ara/crypto/common/crypto_object_uid.h"
Description:	Comparison operator "less than or equal" for CryptoObjectUid operands.

](RS_CRYPT_02005)

[SWS_CRYPT_10155]{DRAFT} [

Kind:	function	
Symbol:	operator>=(const CryptoObjectUid &lhs, const CryptoObjectUid &rhs)	
Scope:	namespace ara::crypto	
Syntax:	constexpr bool ara::crypto::operator>= (const CryptoObjectUid &lhs, const CryptoObjectUid &rhs) noexcept;	
Parameters (in):	lhs	left-hand side operand
	rhs	right-hand side operand
Return value:	bool	true if a binary representation of lhs is greater than or equal to rhs, and false otherwise
Exception Safety:	noexcept	
Thread Safety:	Thread-safe	
Header file:	#include "ara/crypto/common/crypto_object_uid.h"	
Description:	Comparison operator "greater than or equal" for CryptoObjectUid operands.	

](RS_CRYPT_02005)

[SWS_CRYPT_10451]{DRAFT} [

Kind:	function	
Symbol:	operator==(const Uuid &lhs, const Uuid &rhs)	
Scope:	namespace ara::crypto	
Syntax:	constexpr bool ara::crypto::operator== (const Uuid &lhs, const Uuid &rhs) noexcept;	
Parameters (in):	lhs	left-hand side operand
	rhs	right-hand side operand
Return value:	bool	true if a binary representation of lhs is equal to rhs, and false otherwise
Exception Safety:	noexcept	
Thread Safety:	Thread-safe	
Header file:	#include "ara/crypto/common/uuid.h"	
Description:	Comparison operator "equal" for Uuid operands.	

](RS_CRYPT_02112)

[SWS_CRYPT_10452]{DRAFT} [

Kind:	function	
Symbol:	operator<(const Uuid &lhs, const Uuid &rhs)	
Scope:	namespace ara::crypto	
Syntax:	constexpr bool ara::crypto::operator< (const Uuid &lhs, const Uuid &rhs) noexcept;	
Parameters (in):	lhs	left-hand side operand



△

	rhs	right-hand side operand
Return value:	bool	true if a binary representation of lhs is less than rhs, and false otherwise
Exception Safety:	noexcept	
Thread Safety:	Thread-safe	
Header file:	#include "ara/crypto/common/uuid.h"	
Description:	Comparison operator "less than" for Uuid operands.	

]([RS_CRYPT_02112](#))

[SWS_CRYPT_10453]{DRAFT} [

Kind:	function	
Symbol:	operator>(const Uuid &lhs, const Uuid &rhs)	
Scope:	namespace ara::crypto	
Syntax:	constexpr bool ara::crypto::operator> (const Uuid &lhs, const Uuid &rhs) noexcept;	
Parameters (in):	lhs	left-hand side operand
	rhs	right-hand side operand
Return value:	bool	true if a binary representation of lhs is greater than rhs, and false otherwise
Exception Safety:	noexcept	
Thread Safety:	Thread-safe	
Header file:	#include "ara/crypto/common/uuid.h"	
Description:	Comparison operator "greater than" for Uuid operands.	

]([RS_CRYPT_02112](#))

[SWS_CRYPT_10454]{DRAFT} [

Kind:	function	
Symbol:	operator!=(const Uuid &lhs, const Uuid &rhs)	
Scope:	namespace ara::crypto	
Syntax:	constexpr bool ara::crypto::operator!= (const Uuid &lhs, const Uuid &rhs) noexcept;	
Parameters (in):	lhs	left-hand side operand
	rhs	right-hand side operand
Return value:	bool	true if a binary representation of lhs is not equal to rhs, and false otherwise
Exception Safety:	noexcept	
Thread Safety:	Thread-safe	
Header file:	#include "ara/crypto/common/uuid.h"	
Description:	Comparison operator "not equal" for Uuid operands.	

]([RS_CRYPT_02112](#))

[SWS_CRYPT_10455]{DRAFT} [

Kind:	function	
Symbol:	operator<=(const Uuid &lhs, const Uuid &rhs)	
Scope:	namespace ara::crypto	
Syntax:	constexpr bool ara::crypto::operator<= (const Uuid &lhs, const Uuid &rhs) noexcept;	
Parameters (in):	lhs	left-hand side operand
	rhs	right-hand side operand
Return value:	bool	true if a binary representation of lhs is less than or equal to rhs, and false otherwise
Exception Safety:	noexcept	
Thread Safety:	Thread-safe	
Header file:	#include "ara/crypto/common/uuid.h"	
Description:	Comparison operator "less than or equal" for Uuid operands.	

]([RS_CRYPT_02112](#))

[SWS_CRYPT_10456]{DRAFT} [

Kind:	function	
Symbol:	operator>=(const Uuid &lhs, const Uuid &rhs)	
Scope:	namespace ara::crypto	
Syntax:	constexpr bool ara::crypto::operator>= (const Uuid &lhs, const Uuid &rhs) noexcept;	
Parameters (in):	lhs	left-hand side operand
	rhs	right-hand side operand
Return value:	bool	true if a binary representation of lhs is greater than or equal to rhs, and false otherwise
Exception Safety:	noexcept	
Thread Safety:	Thread-safe	
Header file:	#include "ara/crypto/common/uuid.h"	
Description:	Comparison operator "greater than or equal" for Uuid operands.	

]([RS_CRYPT_02112](#))

[SWS_CRYPT_19954]{DRAFT} [

Kind:	function	
Symbol:	ThrowAsException(const ara::core::ErrorCode &errorCode)	
Scope:	class ara::crypto::CryptoErrorDomain	
Syntax:	void ara::crypto::CryptoErrorDomain::ThrowAsException (const ara::core::ErrorCode &errorCode) const override;	
Parameters (in):	errorCode	an error code identifier from the CryptoErrc enumeration
Return value:	None	
Header file:	#include "ara/crypto/common/crypto_error_domain.h"	
Description:	throws exception of error code	

]([RS_CRYPT_02310](#))

[SWS_CRYPT_19902]{DRAFT} [

Kind:	function
Symbol:	CryptoErrorDomain()
Scope:	class ara::crypto::CryptoErrorDomain
Syntax:	<code>constexpr ara::crypto::CryptoErrorDomain::CryptoErrorDomain () noexcept;</code>
Exception Safety:	noexcept
Header file:	<code>#include "ara/crypto/common/crypto_error_domain.h"</code>
Description:	Ctor of the CryptoErrorDomain.

]([RS_CRYPT_02310](#))

[SWS_CRYPT_19950]{DRAFT} [

Kind:	function
Symbol:	Name()
Scope:	class ara::crypto::CryptoErrorDomain
Syntax:	<code>const char* ara::crypto::CryptoErrorDomain::Name () const noexcept override;</code>
Return value:	const char * "Crypto" text
Exception Safety:	noexcept
Header file:	<code>#include "ara/crypto/common/crypto_error_domain.h"</code>
Description:	returns Text "Crypto"

]([RS_CRYPT_02310](#))

[SWS_CRYPT_19953]{DRAFT} [

Kind:	function
Symbol:	Message(ara::core::ErrorDomain::CodeType errorCode)
Scope:	class ara::crypto::CryptoErrorDomain
Syntax:	<code>const char* ara::crypto::CryptoErrorDomain::Message (ara::core::ErrorDomain::CodeType errorCode) const noexcept override;</code>
Parameters (in):	errorCode an error code identifier from the CryptoErrc enumeration
Return value:	const char * message text of error code
Exception Safety:	noexcept
Header file:	<code>#include "ara/crypto/common/crypto_error_domain.h"</code>
Description:	Translate an error code value into a text message.

]([RS_CRYPT_02310](#))

[SWS_CRYPT_10710]{DRAFT} [

Kind:	function
Symbol:	~Serializable()
Scope:	class ara::crypto::Serializable
Syntax:	<code>virtual ara::crypto::Serializable::~~Serializable () noexcept=default;</code>
Exception Safety:	noexcept





Header file:	#include "ara/crypto/common/serializable.h"
Description:	Destructor.

]([RS_CRYPTO_02004](#), [RS_CRYPTO_02302](#))

[SWS_CRYPT_10711]{DRAFT} [

Kind:	function	
Symbol:	ExportPublicly(FormatId formatId=kFormatDefault)	
Scope:	class ara::crypto::Serializable	
Syntax:	virtual ara::core::Result<ara::core::Vector<ara::core::Byte> > ara::crypto::Serializable::ExportPublicly (FormatId formatId=kFormatDefault) const noexcept=0;	
Parameters (in):	formatId	the Crypto Provider specific identifier of the output format
Return value:	ara::core::Result< ara::core::Vector< ara::core::Byte > >	a buffer with the serialized object
Exception Safety:	noexcept	
Thread Safety:	Thread-safe	
Errors:	CryptoErrorDomain::kInsufficientCapacity	if (output.empty() == false), but it's capacity is less than required
	CryptoErrorDomain::kUnknownIdentifier	if an unknown format ID was specified
	CryptoErrorDomain::kUnsupportedFormat	if the specified format ID is not supported for this object type
Header file:	#include "ara/crypto/common/serializable.h"	
Description:	Serialize itself publicly.	

]([RS_CRYPTO_02112](#))

[SWS_CRYPT_10712]{DRAFT} [

Kind:	function	
Symbol:	ExportPublicly(FormatId formatId=kFormatDefault)	
Scope:	class ara::crypto::Serializable	
Syntax:	template <typename Alloc = <implementation-defined>> ara::core::Result<ByteVector<Alloc> > ara::crypto::Serializable::ExportPublicly (FormatId formatId=kFormatDefault) const noexcept;	
Template param:	Alloc	custom allocator type of the output container
Parameters (in):	formatId	the Crypto Provider specific identifier of the output format
Return value:	ara::core::Result< ByteVector< Alloc > >	pre-reserved managed container for the serialization output
Exception Safety:	noexcept	
Thread Safety:	Thread-safe	
Errors:	CryptoErrorDomain::kInsufficientCapacity	if capacity of the output buffer is less than required
	CryptoErrorDomain::kUnknownIdentifier	if an unknown format ID was specified



△

	CryptoErrorDomain::kUnsupported Format	if the specified format ID is not supported for this object type
Header file:	#include "ara/crypto/common/serializable.h"	
Description:	Serialize itself publicly. This method sets the size of the output container according to actually saved value!	

] ([RS_CRYPT_02112](#))

[SWS_CRYPT_30204]{DRAFT} [

Kind:	function	
Symbol:	operator=(const Serializable &other)	
Scope:	class ara::crypto::Serializable	
Syntax:	<code>Serializable& ara::crypto::Serializable::operator= (const Serializable &other)=default;</code>	
Parameters (in):	other	the other instance
Return value:	Serializable &	*this, containing the contents of other
Header file:	#include "ara/crypto/common/serializable.h"	
Description:	Copy-assign another Serializable to this instance.	

] ([RS_CRYPT_02004](#))

[SWS_CRYPT_30205]{DRAFT} [

Kind:	function	
Symbol:	operator=(Serializable &&other)	
Scope:	class ara::crypto::Serializable	
Syntax:	<code>Serializable& ara::crypto::Serializable::operator= (Serializable &&other)=default;</code>	
Parameters (in):	other	the other instance
Return value:	Serializable &	*this, containing the contents of other
Header file:	#include "ara/crypto/common/serializable.h"	
Description:	Move-assign another Serializable to this instance.	

] ([RS_CRYPT_02004](#))

[SWS_CRYPT_10851]{DRAFT} [

Kind:	function	
Symbol:	~VolatileTrustedContainer()	
Scope:	class ara::crypto::VolatileTrustedContainer	
Syntax:	<code>virtual ara::crypto::VolatileTrustedContainer::~VolatileTrustedContainer () noexcept=default;</code>	
Exception Safety:	noexcept	
Header file:	#include "ara/crypto/common/volatile_trusted_container.h"	
Description:	Destructor.	

] ([RS_CRYPT_02004](#))

[SWS_CRYPT_10853]{DRAFT} [

Kind:	function	
Symbol:	GetIOInterface()	
Scope:	class ara::crypto::VolatileTrustedContainer	
Syntax:	virtual IOInterface& ara::crypto::VolatileTrustedContainer::GetIOInterface () const noexcept=0;	
Return value:	IOInterface &	a reference to the IOInterface of this container
Exception Safety:	noexcept	
Header file:	#include "ara/crypto/common/volatile_trusted_container.h"	
Description:	Retrieve the IOInterface used for importing/exporting objects into this container.	

] ([RS_CRYPT_02004](#))

[SWS_CRYPT_30206]{DRAFT} [

Kind:	function	
Symbol:	operator=(const VolatileTrustedContainer &other)	
Scope:	class ara::crypto::VolatileTrustedContainer	
Syntax:	VolatileTrustedContainer& ara::crypto::VolatileTrustedContainer::operator= (const VolatileTrustedContainer &other)=default;	
Parameters (in):	other	the other instance
Return value:	VolatileTrustedContainer &	*this, containing the contents of other
Header file:	#include "ara/crypto/common/volatile_trusted_container.h"	
Description:	Copy-assign another VolatileTrustedContainer to this instance.	

] ([RS_CRYPT_02004](#))

[SWS_CRYPT_30207]{DRAFT} [

Kind:	function	
Symbol:	operator=(VolatileTrustedContainer &&other)	
Scope:	class ara::crypto::VolatileTrustedContainer	
Syntax:	VolatileTrustedContainer& ara::crypto::VolatileTrustedContainer::operator= (VolatileTrustedContainer &&other)=default;	
Parameters (in):	other	the other instance
Return value:	VolatileTrustedContainer &	*this, containing the contents of other
Header file:	#include "ara/crypto/common/volatile_trusted_container.h"	
Description:	Move-assign another VolatileTrustedContainer to this instance.	

] ([RS_CRYPT_02004](#))

[SWS_CRYPT_10411]{DRAFT} [

Kind:	function	
Symbol:	IsNil()	
Scope:	struct ara::crypto::Uuid	
Syntax:	bool ara::crypto::Uuid::IsNil () const noexcept;	
Return value:	bool	true if this identifier is "Nil" and false otherwise
Exception Safety:	noexcept	





Thread Safety:	Thread-safe
Header file:	#include "ara/crypto/common/uuid.h"
Description:	Check whether this identifier is the "Nil UUID" (according to RFC4122).

]([RS_CRYPT_02005](#))

[SWS_CRYPT_13000]{DRAFT} [

Kind:	variable
Symbol:	kAlgIdUndefined
Scope:	namespace ara::crypto
Type:	const CryptoAlgId
Syntax:	const CryptoAlgId ara::crypto::kAlgIdUndefined = 0u;
Header file:	#include "ara/crypto/common/base_id_types.h"
Description:	<p>Algorithm ID is undefined. Also this value may be used in meanings: Any or Default algorithm, None of algorithms.</p> <p>Effective values of Crypto Algorithm IDs are specific for concrete Crypto Stack implementation. But the zero value is reserved for especial purposes, that can differ depending from a usage context. This group defines a few constant names of the single zero value, but semantically they have different meaning specific for concrete application of the constant.</p>

]([RS_CRYPT_02107](#))

[SWS_CRYPT_13001]{DRAFT} [

Kind:	variable
Symbol:	kAlgIdAny
Scope:	namespace ara::crypto
Type:	const CryptoAlgId
Syntax:	const CryptoAlgId ara::crypto::kAlgIdAny = kAlgIdUndefined;
Header file:	#include "ara/crypto/common/base_id_types.h"
Description:	Any Algorithm ID is allowed.

]([RS_CRYPT_02107](#))

[SWS_CRYPT_13002]{DRAFT} [

Kind:	variable
Symbol:	kAlgIdDefault
Scope:	namespace ara::crypto
Type:	const CryptoAlgId
Syntax:	const CryptoAlgId ara::crypto::kAlgIdDefault = kAlgIdUndefined;
Header file:	#include "ara/crypto/common/base_id_types.h"
Description:	Default Algorithm ID (in current context/primitive).

]([RS_CRYPT_02107](#))

[SWS_CRYPT_13003]{DRAFT} [

Kind:	variable
Symbol:	kAlgIdNone
Scope:	namespace ara::crypto
Type:	const CryptoAlgId
Syntax:	const CryptoAlgId ara::crypto::kAlgIdNone = kAlgIdUndefined;
Header file:	#include "ara/crypto/common/base_id_types.h"
Description:	None of Algorithm ID (i.e. an algorithm definition is not applicable).

] ([RS_CRYPT_02107](#))

[SWS_CRYPT_13102]{DRAFT} [

Kind:	variable
Symbol:	kAllowDataDecryption
Scope:	namespace ara::crypto
Type:	const AllowedUsageFlags
Syntax:	const AllowedUsageFlags ara::crypto::kAllowDataDecryption = 0x0002;
Header file:	#include "ara/crypto/common/base_id_types.h"
Description:	The key/seed can be used for data decryption initialization (applicable to symmetric and asymmetric algorithms).

] ([RS_CRYPT_02111](#))

[SWS_CRYPT_13101]{DRAFT} [

Kind:	variable
Symbol:	kAllowDataEncryption
Scope:	namespace ara::crypto
Type:	const AllowedUsageFlags
Syntax:	const AllowedUsageFlags ara::crypto::kAllowDataEncryption = 0x0001;
Header file:	#include "ara/crypto/common/base_id_types.h"
Description:	The key/seed can be used for data encryption initialization (applicable to symmetric and asymmetric algorithms).

] ([RS_CRYPT_02111](#))

[SWS_CRYPT_13113]{DRAFT} [

Kind:	variable
Symbol:	kAllowDerivedDataDecryption
Scope:	namespace ara::crypto
Type:	const AllowedUsageFlags
Syntax:	const AllowedUsageFlags ara::crypto::kAllowDerivedDataDecryption = kAllowDataDecryption << 16;
Header file:	#include "ara/crypto/common/base_id_types.h"
Description:	A derived seed or symmetric key can be used for data decryption.

] ([RS_CRYPT_02111](#))

[SWS_CRYPT_13112]{DRAFT} [

Kind:	variable
Symbol:	kAllowDerivedDataEncryption
Scope:	namespace ara::crypto
Type:	const AllowedUsageFlags
Syntax:	<code>const AllowedUsageFlags ara::crypto::kAllowDerivedDataEncryption = kAllowDataEncryption << 16;</code>
Header file:	<code>#include "ara/crypto/common/base_id_types.h"</code>
Description:	A derived seed or symmetric key can be used for data encryption.

]([RS_CRYPT_02111](#))

[SWS_CRYPT_13117]{DRAFT} [

Kind:	variable
Symbol:	kAllowDerivedRngInit
Scope:	namespace ara::crypto
Type:	const AllowedUsageFlags
Syntax:	<code>const AllowedUsageFlags ara::crypto::kAllowDerivedRngInit = kAllowRngInit << 16;</code>
Header file:	<code>#include "ara/crypto/common/base_id_types.h"</code>
Description:	A derived seed or symmetric key can be used for seeding of a RandomGeneratorContext.

]([RS_CRYPT_02111](#))

[SWS_CRYPT_13121]{DRAFT} [

Kind:	variable
Symbol:	kAllowDerivedExactModeOnly
Scope:	namespace ara::crypto
Type:	const AllowedUsageFlags
Syntax:	<code>const AllowedUsageFlags ara::crypto::kAllowDerivedExactModeOnly = kAllowExactModeOnly << 16;</code>
Header file:	<code>#include "ara/crypto/common/base_id_types.h"</code>
Description:	Restrict usage of derived objects to specified operation mode only. A derived seed or symmetric key can be used only for the mode directly specified by Key::AlgId.

]([RS_CRYPT_02111](#))

[SWS_CRYPT_13118]{DRAFT} [

Kind:	variable
Symbol:	kAllowDerivedKdfMaterial
Scope:	namespace ara::crypto
Type:	const AllowedUsageFlags
Syntax:	<code>const AllowedUsageFlags ara::crypto::kAllowDerivedKdfMaterial = kAllowKdfMaterial << 16;</code>
Header file:	<code>#include "ara/crypto/common/base_id_types.h"</code>
Description:	A derived seed or symmetric key can be used as a RestrictedUseObject for slave-keys derivation via a Key Derivation Function (KDF).

]([RS_CRYPT_02111](#))

[SWS_CRYPT_13122]{DRAFT} [

Kind:	variable
Symbol:	kAllowKdfMaterialAnyUsage
Scope:	namespace ara::crypto
Type:	const AllowedUsageFlags
Syntax:	<pre>const AllowedUsageFlags ara::crypto::kAllowKdfMaterialAnyUsage = k AllowKdfMaterial kAllowDerivedDataEncryption kAllowDerivedData Decryption kAllowDerivedSignature kAllowDerivedVerification k AllowDerivedKeyDiversify kAllowDerivedRngInit kAllowDerivedKdf Material kAllowDerivedKeyExporting kAllowDerivedKeyImporting;</pre>
Header file:	#include "ara/crypto/common/base_id_types.h"
Description:	Allow usage of the object as a key material for KDF and any usage of derived objects. The seed or symmetric key can be used as a RestrictedUseObject for a Key Derivation Function (KDF) and the derived "slave" keys can be used without limitations.

]([RS_CRYPTO_02111](#))

[SWS_CRYPT_13116]{DRAFT} [

Kind:	variable
Symbol:	kAllowDerivedKeyDiversify
Scope:	namespace ara::crypto
Type:	const AllowedUsageFlags
Syntax:	<pre>const AllowedUsageFlags ara::crypto::kAllowDerivedKeyDiversify = k AllowKeyDiversify << 16;</pre>
Header file:	#include "ara/crypto/common/base_id_types.h"
Description:	A derived seed or symmetric key can be used for slave-keys diversification.

]([RS_CRYPTO_02111](#))

[SWS_CRYPT_13119]{DRAFT} [

Kind:	variable
Symbol:	kAllowDerivedKeyExporting
Scope:	namespace ara::crypto
Type:	const AllowedUsageFlags
Syntax:	<pre>const AllowedUsageFlags ara::crypto::kAllowDerivedKeyExporting = k AllowKeyExporting << 16;</pre>
Header file:	#include "ara/crypto/common/base_id_types.h"
Description:	A derived seed or symmetric key can be used as a "transport" one for Key-Wrap transformation.

]([RS_CRYPTO_02111](#))

[SWS_CRYPT_13120]{DRAFT} [

Kind:	variable
Symbol:	kAllowDerivedKeyImporting
Scope:	namespace ara::crypto
Type:	const AllowedUsageFlags



△

Syntax:	<code>const AllowedUsageFlags ara::crypto::kAllowDerivedKeyImporting = kAllowKeyImporting << 16;</code>
Header file:	<code>#include "ara/crypto/common/base_id_types.h"</code>
Description:	A derived seed or symmetric key can be used as a "transport" one for Key-Unwrap transformation.

|(RS_CRYPT_02111)

[SWS_CRYPT_13114]{DRAFT} [

Kind:	variable
Symbol:	kAllowDerivedSignature
Scope:	namespace ara::crypto
Type:	const AllowedUsageFlags
Syntax:	<code>const AllowedUsageFlags ara::crypto::kAllowDerivedSignature = kAllowSignature << 16;</code>
Header file:	<code>#include "ara/crypto/common/base_id_types.h"</code>
Description:	A derived seed or symmetric key can be used for MAC/HMAC production.

|(RS_CRYPT_02111)

[SWS_CRYPT_13115]{DRAFT} [

Kind:	variable
Symbol:	kAllowDerivedVerification
Scope:	namespace ara::crypto
Type:	const AllowedUsageFlags
Syntax:	<code>const AllowedUsageFlags ara::crypto::kAllowDerivedVerification = kAllowVerification << 16;</code>
Header file:	<code>#include "ara/crypto/common/base_id_types.h"</code>
Description:	A derived seed or symmetric key can be used for MAC/HMAC verification.

|(RS_CRYPT_02111)

[SWS_CRYPT_13111]{DRAFT} [

Kind:	variable
Symbol:	kAllowExactModeOnly
Scope:	namespace ara::crypto
Type:	const AllowedUsageFlags
Syntax:	<code>const AllowedUsageFlags ara::crypto::kAllowExactModeOnly = 0x8000;</code>
Header file:	<code>#include "ara/crypto/common/base_id_types.h"</code>
Description:	The key can be used only for the mode directly specified by Key::AlgId.

|(RS_CRYPT_02111)

[SWS_CRYPT_13108]{DRAFT} [

Kind:	variable
Symbol:	kAllowKdfMaterial
Scope:	namespace ara::crypto
Type:	const AllowedUsageFlags
Syntax:	const AllowedUsageFlags ara::crypto::kAllowKdfMaterial = 0x0080;
Header file:	#include "ara/crypto/common/base_id_types.h"
Description:	The object can be used as an input key material to KDF. The seed or symmetric key can be used as a RestrictedUseObject for slave-keys derivation via a Key Derivation Function (KDF).

]([RS_CRYPT_02111](#))

[SWS_CRYPT_13105]{DRAFT} [

Kind:	variable
Symbol:	kAllowKeyAgreement
Scope:	namespace ara::crypto
Type:	const AllowedUsageFlags
Syntax:	const AllowedUsageFlags ara::crypto::kAllowKeyAgreement = 0x0010;
Header file:	#include "ara/crypto/common/base_id_types.h"
Description:	The seed or asymmetric key can be used for key-agreement protocol execution.

]([RS_CRYPT_02111](#))

[SWS_CRYPT_13106]{DRAFT} [

Kind:	variable
Symbol:	kAllowKeyDiversify
Scope:	namespace ara::crypto
Type:	const AllowedUsageFlags
Syntax:	const AllowedUsageFlags ara::crypto::kAllowKeyDiversify = 0x0020;
Header file:	#include "ara/crypto/common/base_id_types.h"
Description:	The seed or symmetric key can be used for slave-keys diversification.

]([RS_CRYPT_02111](#))

[SWS_CRYPT_13109]{DRAFT} [

Kind:	variable
Symbol:	kAllowKeyExporting
Scope:	namespace ara::crypto
Type:	const AllowedUsageFlags
Syntax:	const AllowedUsageFlags ara::crypto::kAllowKeyExporting = 0x0100;
Header file:	#include "ara/crypto/common/base_id_types.h"
Description:	The key can be used as "transport" one for Key-Wrap or Encapsulate transformations (applicable to symmetric and asymmetric keys).

]([RS_CRYPT_02111](#))

[SWS_CRYPT_13110]{DRAFT} [

Kind:	variable
Symbol:	kAllowKeyImporting
Scope:	namespace ara::crypto
Type:	const AllowedUsageFlags
Syntax:	const AllowedUsageFlags ara::crypto::kAllowKeyImporting = 0x0200;
Header file:	#include "ara/crypto/common/base_id_types.h"
Description:	The key can be used as "transport" one for Key-Unwrap or Decapsulate transformations (applicable to symmetric and asymmetric keys).

]([RS_CRYPT_02111](#))

[SWS_CRYPT_13100]{DRAFT} [

Kind:	variable
Symbol:	kAllowPrototypedOnly
Scope:	namespace ara::crypto
Type:	const AllowedUsageFlags
Syntax:	const AllowedUsageFlags ara::crypto::kAllowPrototypedOnly = 0;
Header file:	#include "ara/crypto/common/base_id_types.h"
Description:	This group contains list of constant 1-bit values predefined for Allowed Usage flags. The key/seed usage will be fully specified by a key slot prototype (the object can be used only after reloading from the slot).

]([RS_CRYPT_02111](#))

[SWS_CRYPT_13107]{DRAFT} [

Kind:	variable
Symbol:	kAllowRngInit
Scope:	namespace ara::crypto
Type:	const AllowedUsageFlags
Syntax:	const AllowedUsageFlags ara::crypto::kAllowRngInit = 0x0040;
Header file:	#include "ara/crypto/common/base_id_types.h"
Description:	The seed or symmetric key can be used for seeding of a RandomGeneratorCtx.

]([RS_CRYPT_02111](#))

[SWS_CRYPT_13103]{DRAFT} [

Kind:	variable
Symbol:	kAllowSignature
Scope:	namespace ara::crypto
Type:	const AllowedUsageFlags
Syntax:	const AllowedUsageFlags ara::crypto::kAllowSignature = 0x0004;
Header file:	#include "ara/crypto/common/base_id_types.h"
Description:	The key/seed can be used for digital signature or MAC/HMAC production (applicable to symmetric and asymmetric algorithms).

]([RS_CRYPT_02111](#))

[SWS_CRYPT_13104]{DRAFT} [

Kind:	variable
Symbol:	kAllowVerification
Scope:	namespace ara::crypto
Type:	const AllowedUsageFlags
Syntax:	const AllowedUsageFlags ara::crypto::kAllowVerification = 0x0008;
Header file:	#include "ara/crypto/common/base_id_types.h"
Description:	The key/seed can be used for digital signature or MAC/HMAC verification (applicable to symmetric and asymmetric algorithms).

]([RS_CRYPT_02111](#))

[SWS_CRYPT_10102]{DRAFT} [

Kind:	variable
Symbol:	mVersionStamp
Scope:	struct ara::crypto::CryptoObjectUid
Type:	std::uint64_t
Syntax:	std::uint64_t ara::crypto::CryptoObjectUid::mVersionStamp = 0u;
Header file:	#include "ara/crypto/common/crypto_object_uid.h"
Description:	Sequential value of a steady timer or simple counter, representing version of correspondent Crypto Object.

]([RS_CRYPT_02006](#))

[SWS_CRYPT_30002]{DRAFT} [

Kind:	variable
Symbol:	mLSQW
Scope:	struct ara::crypto::SecureCounter
Type:	std::uint64_t
Syntax:	std::uint64_t ara::crypto::SecureCounter::mLSQW;
Header file:	#include "ara/crypto/common/entry_point.h"
Description:	least significant 64 bits

]([RS_CRYPT_02401](#))

[SWS_CRYPT_30003]{DRAFT} [

Kind:	variable
Symbol:	mMSQW
Scope:	struct ara::crypto::SecureCounter
Type:	std::uint64_t
Syntax:	std::uint64_t ara::crypto::SecureCounter::mMSQW;
Header file:	#include "ara/crypto/common/entry_point.h"
Description:	most significant 64 bits

]([RS_CRYPT_02401](#))

[SWS_CRYPT_10750]{DRAFT} [

Kind:	variable
Symbol:	kFormatDefault
Scope:	class ara::crypto::Serializable
Type:	const FormatId
Syntax:	<code>static const FormatId ara::crypto::Serializable::kFormatDefault = 0;</code>
Header file:	<code>#include "ara/crypto/common/serializable.h"</code>
Description:	Default serialization format.

]([RS_CRYPT_02004](#), [RS_CRYPT_02302](#))

[SWS_CRYPT_10752]{DRAFT} [

Kind:	variable
Symbol:	kFormatDerEncoded
Scope:	class ara::crypto::Serializable
Type:	const FormatId
Syntax:	<code>static const FormatId ara::crypto::Serializable::kFormatDerEncoded = 2;</code>
Header file:	<code>#include "ara/crypto/common/serializable.h"</code>
Description:	Export DER-encoded value of an object.

]([RS_CRYPT_02004](#), [RS_CRYPT_02302](#))

[SWS_CRYPT_10753]{DRAFT} [

Kind:	variable
Symbol:	kFormatPemEncoded
Scope:	class ara::crypto::Serializable
Type:	const FormatId
Syntax:	<code>static const FormatId ara::crypto::Serializable::kFormatPemEncoded = 3;</code>
Header file:	<code>#include "ara/crypto/common/serializable.h"</code>
Description:	Export PEM-encoded value of an object.

]([RS_CRYPT_02004](#), [RS_CRYPT_02302](#))

[SWS_CRYPT_10751]{DRAFT} [

Kind:	variable
Symbol:	kFormatRawValueOnly
Scope:	class ara::crypto::Serializable
Type:	const FormatId
Syntax:	<code>static const FormatId ara::crypto::Serializable::kFormatRawValueOnly = 1;</code>
Header file:	<code>#include "ara/crypto/common/serializable.h"</code>
Description:	Export only raw value of an object.

]([RS_CRYPT_02004](#), [RS_CRYPT_02302](#))

[SWS_CRYPT_10412]{DRAFT} [

Kind:	variable
Symbol:	mQwordLs
Scope:	struct ara::crypto::Uuid
Type:	std::uint64_t
Syntax:	std::uint64_t ara::crypto::Uuid::mQwordLs = 0u;
Header file:	#include "ara/crypto/common/uuid.h"
Description:	Less significant QWORD.

]([RS_CRYPT_02005](#))

[SWS_CRYPT_10413]{DRAFT} [

Kind:	variable
Symbol:	mQwordMs
Scope:	struct ara::crypto::Uuid
Type:	std::uint64_t
Syntax:	std::uint64_t ara::crypto::Uuid::mQwordMs = 0u;
Header file:	#include "ara/crypto/common/uuid.h"
Description:	Most significant QWORD.

]([RS_CRYPT_02005](#))

9 Service Interfaces

No content defined.

9.1 Type definitions

No types are defined for service interfaces.

9.2 Provided Service Interfaces

No service interfaces are provided.

9.3 Required Service Interfaces

No service interfaces are required.

9.4 Application Errors

No application errors are defined.

A Mentioned Manifest Elements

For the sake of completeness, this chapter contains a set of class tables representing meta-classes mentioned in the context of this document but which are not contained directly in the scope of describing specific meta-model semantics.

Chapter is generated.

Class	AdaptiveApplicationSwComponentType			
Package	M2::AUTOSARTemplates::AdaptivePlatform::ApplicationDesign::ApplicationStructure			
Note	This meta-class represents the ability to support the formal modeling of application software on the AUTOSAR adaptive platform. Consequently, it shall only be used on the AUTOSAR adaptive platform. Tags: atp.recommendedPackage=AdaptiveApplicationSwComponentTypes			
Base	<i>ARElement, ARObject, AtpBlueprint, AtpBlueprintable, AtpClassifier, AtpType, CollectableElement, Identifiable, MultilanguageReferrable, PackageableElement, Referrable, SwComponentType</i>			
Aggregated by	ARPackage.element			
Attribute	Type	Mult.	Kind	Note
internalBehavior	AdaptiveSwcInternalBehavior	0..1	aggr	This aggregation represents the internal behavior of the AdaptiveApplicationSwComponentType for the AUTOSAR adaptive platform. Stereotypes: atpSplitable; atpVariation Tags: atp.Splitkey=internalBehavior.shortName, internalBehavior.variationPoint.shortLabel vh.latestBindingTime=preCompileTime

Table A.1: AdaptiveApplicationSwComponentType

Class	CryptoCertificate			
Package	M2::AUTOSARTemplates::AdaptivePlatform::PlatformModuleDeployment::CryptoDeployment			
Note	This meta-class represents the ability to model a cryptographic certificate.			
Base	<i>ARObject, Identifiable, MultilanguageReferrable, Referrable</i>			
Aggregated by	CryptoModuleInstantiation.cryptoCertificate			
Attribute	Type	Mult.	Kind	Note
isPrivate	Boolean	0..1	attr	This attribute controls the possibility to access the content of the CryptoCertificateSlot by Find() interfaces of the X509 Provider.

Table A.2: CryptoCertificate

Class	CryptoCertificateInterface			
Package	M2::AUTOSARTemplates::AdaptivePlatform::ApplicationDesign::CryptoDesign			
Note	This meta-class provides the ability to define a PortInterface for a CryptoCertificate. Tags: atp.Status=candidate atp.recommendedPackage=CryptoInterfaces			
Base	<i>ARElement, ARObject, AtpBlueprint, AtpBlueprintable, AtpClassifier, AtpType, CollectableElement, CryptoInterface, Identifiable, MultilanguageReferrable, PackageableElement, PortInterface, Referrable</i>			
Aggregated by	ARPackage.element			
Attribute	Type	Mult.	Kind	Note





Class		CryptoCertificateInterface		
isPrivate	Boolean	0..1	attr	This attribute controls the possibility to access the content of the CryptoCertificateSlot by Find() interfaces of the X509 Provider. Tags: atp.Status=candidate
writeAccess	Boolean	0..1	attr	This attribute defines whether the application has write-access to the CryptoCertificate (True) or only read-access (False). Tags: atp.Status=candidate

Table A.3: CryptoCertificateInterface

Class		CryptoCertificateToCryptoKeySlotMapping		
Package	M2::AUTOSARTemplates::AdaptivePlatform::PlatformModuleDeployment::CryptoDeployment			
Note	This meta-class represents the ability to define a mapping between a CryptoKeySlot and a Crypto Certificate.			
Base	ARObject			
Aggregated by	CryptoModuleInstantiation.certificateToKeySlotMapping			
Attribute	Type	Mult.	Kind	Note
crypto Certificate	CryptoCertificate	0..1	ref	This reference represents the mapped cryptoCertificate.
cryptoKeySlot	CryptoKeySlot	0..2	ref	This reference represents the mapped cryptoKeySlot.

Table A.4: CryptoCertificateToCryptoKeySlotMapping

Class		CryptoKeySlot		
Package	M2::AUTOSARTemplates::AdaptivePlatform::PlatformModuleDeployment::CryptoDeployment			
Note	This meta-class represents the ability to define a concrete key to be used for a crypto operation. Tags: atp.ManifestKind=MachineManifest			
Base	ARObject, Identifiable, MultilanguageReferrable, Referrable			
Aggregated by	CryptoProvider.keySlot			
Attribute	Type	Mult.	Kind	Note
allocateShadow Copy	Boolean	0..1	attr	This attribute defines whether a shadow copy of this Key Slot shall be allocated to enable rollback of a failed Key Slot update campaign (see interface BeginTransaction).
cryptoAlgid	String	0..1	attr	This attribute defines a crypto algorithm restriction (kAlgid Any means without restriction). The algorithm can be specified partially: family & length, mode, padding. Future Crypto Providers can support some crypto algorithms that are not well known/ standardized today, therefore AUTOSAR doesn't provide a concrete list of crypto algorithms' identifiers and doesn't suppose usage of numerical identifiers. Instead of this a provider supplier should provide string names of supported algorithms in accompanying documentation. The name of a crypto algorithm shall follow the rules defined in the specification of cryptography for Adaptive Platform.
cryptoObject Type	CryptoObjectTypeEnum	0..1	attr	Object type that can be stored in the slot. If this field contains "Undefined" then mSlotCapacity must be provided and larger then 0. Tags: atp.Status=candidate





Class	CryptoKeySlot			
keySlotAllowedModification	CryptoKeySlotAllowedModification	0..1	aggr	Restricts how this keySlot may be used Tags: atp.Status=candidate
keySlotContentAllowedUsage	CryptoKeySlotContentAllowedUsage	*	aggr	Restriction of allowed usage of a key stored to the slot. Tags: atp.Status=candidate
slotCapacity	PositiveInteger	0..1	attr	Capacity of the slot in bytes to be reserved by the stack vendor. One use case is to define this value in case that the cryptoObjectType is undefined and the slot size can not be deduced from cryptoObjectType and cryptoAlgId. "0" means slot size can be deduced from cryptoObjectType and cryptoAlgId.
slotType	CryptoKeySlotTypeEnum	0..1	attr	This attribute defines whether the keySlot is exclusively used by the Application; or whether it is used by Stack Services and managed by a Key Manager Application. Tags: atp.Status=candidate

Table A.5: CryptoKeySlot

Class	CryptoKeySlotInterface			
Package	M2::AUTOSARTemplates::AdaptivePlatform::ApplicationDesign::CryptoDesign			
Note	This meta-class provides the ability to define a PortInterface for Crypto Key Slots. Tags: atp.Status=candidate atp.recommendedPackage=CryptoInterfaces			
Base	ARElement, ARObject, AtpBlueprint, AtpBlueprintable, AtpClassifier, AtpType, CollectableElement, CryptoInterface, Identifiable, MultilanguageReferrable, PackageableElement, PortInterface , Referrable			
Aggregated by	ARPackage.element			
Attribute	Type	Mult.	Kind	Note
allocateShadowCopy	Boolean	0..1	attr	This attribute defines whether a shadow copy of this Key Slot shall be allocated to enable rollback of a failed Key Slot update campaign (see interface BeginTransaction). Tags: atp.Status=candidate
cryptoAlgId	String	0..1	attr	This attribute defines a crypto algorithm restriction (kAlgId Any means without restriction). The algorithm can be specified partially: family & length, mode, padding. Future Crypto Providers can support some crypto algorithms that are not well known/ standardized today, therefore AUTOSAR doesn't provide a concrete list of crypto algorithms' identifiers and doesn't suppose usage of numerical identifiers. Instead of this a provider supplier should provide string names of supported algorithms in accompanying documentation. The name of a crypto algorithm shall follow the rules defined in the specification of cryptography for Adaptive Platform. Tags: atp.Status=candidate
cryptoObjectType	CryptoObjectTypeEnum	0..1	attr	Object type that can be stored in the slot. If this field contains "Undefined" then mSlotCapacity must be provided and larger than 0 Tags: atp.Status=candidate
keySlotAllowedModification	CryptoKeySlotAllowedModification	0..1	aggr	Restricts how this keySlot may be used Tags: atp.Status=candidate





Class	CryptoKeySlotInterface			
keySlotContent AllowedUsage	CryptoKeySlotContent AllowedUsage	*	aggr	Restriction of allowed usage of a key stored to the slot. Tags: atp.Status=candidate
slotCapacity	PositiveInteger	0..1	attr	Capacity of the slot in bytes to be reserved by the stack vendor. One use case is to define this value in case that the cryptoObjectType is undefined and the slot size can not be deduced from cryptoObjectType and cryptoAlgId. "0" means slot size can be deduced from cryptoObjectType and cryptoAlgId. Tags: atp.Status=candidate
slotType	CryptoKeySlotType Enum	0..1	attr	This attribute defines whether the keySlot is exclusively used by the Application; or whether it is used by Stack Services and managed by a Key Manager Application. Tags: atp.Status=candidate

Table A.6: CryptoKeySlotInterface

Class	CryptoKeySlotToPortPrototypeMapping			
Package	M2::AUTOSARTemplates::AdaptivePlatform::PlatformModuleDeployment::CryptoDeployment			
Note	This meta-class represents the ability to define a mapping between a CryptoKeySlot on deployment level to a given PortPrototype that is typed by a CryptoKeySlotInterface. Tags: atp.recommendedPackage=CryptoKeySlotToPortPrototypeMappings			
Base	<i>ARElement, ARObjct, CollectableElement, Identifiable, MultilanguageReferrable, Packageable Element, Referrable, UploadablePackageElement</i>			
Aggregated by	ARPackage.element			
Attribute	Type	Mult.	Kind	Note
keySlot	CryptoKeySlot	0..1	ref	This reference represents the mapped CryptoKeySlot.
portPrototype	RPortPrototype	0..1	iref	This reference represents the mapped PortPrototype. InstanceRef implemented by: RPortPrototypeIn ExecutableInstanceRef
process	Process	0..1	ref	This reference represents the process required as context for the mapping.

Table A.7: CryptoKeySlotToPortPrototypeMapping

Class	CryptoProvider			
Package	M2::AUTOSARTemplates::AdaptivePlatform::PlatformModuleDeployment::CryptoDeployment			
Note	CryptoProvider implements cryptographic primitives (algorithms) supported by the stack. Implementation of this component may be software or hardware based (HSM/TPM).			
Base	<i>ARObject, Identifiable, MultilanguageReferrable, Referrable</i>			
Aggregated by	CryptoModuleInstantiation.cryptoProvider			
Attribute	Type	Mult.	Kind	Note
cryptoProvider Documentation	Documentation	0..1	ref	Documentation of the CryptoProvider that describes the implemented cryptographic primitives.
keySlot	CryptoKeySlot	*	aggr	This aggregation represents the key slots that are allocated by the CryptoProvider. Stereotypes: atpSplitable Tags: atp.Splitkey=keySlot.shortName

Table A.8: CryptoProvider

Class	CryptoProviderInterface			
Package	M2::AUTOSARTemplates::AdaptivePlatform::ApplicationDesign::CryptoDesign			
Note	This meta-class provides the ability to define a PortInterface for a CryptoProvider. Tags: atp.Status=candidate atp.recommendedPackage=CryptoInterfaces			
Base	ARElement, ARObject, AtpBlueprint, AtpBlueprintable, AtpClassifier, AtpType, CollectableElement, CryptoInterface, Identifiable, MultilanguageReferrable, PackageableElement, PortInterface , Referrable			
Aggregated by	ARPackage.element			
Attribute	Type	Mult.	Kind	Note
-	-	-	-	-

Table A.9: CryptoProviderInterface

Class	CryptoProviderToPortPrototypeMapping			
Package	M2::AUTOSARTemplates::AdaptivePlatform::PlatformModuleDeployment::CryptoDeployment			
Note	This meta-class represents the ability to define a mapping between a CryptoProvider on deployment level to a given PortPrototype that is typed by a CryptoProviderInterface. Tags: atp.recommendedPackage=CryptoProviderToPortPrototypeMappings			
Base	ARElement, ARObject, CollectableElement, Identifiable, MultilanguageReferrable, PackageableElement, Referrable, UploadablePackageElement			
Aggregated by	ARPackage.element			
Attribute	Type	Mult.	Kind	Note
cryptoProvider	CryptoProvider	0..1	ref	This reference represents the mapped cryptoProvider.
portPrototype	RPortPrototype	0..1	iref	This reference represents the mapped PortPrototype. InstanceRef implemented by: RPortPrototypeInExecutableInstanceRef
process	Process	0..1	ref	This reference represents the process required as context for the mapping.

Table A.10: CryptoProviderToPortPrototypeMapping

Class	CryptoServiceCertificate			
Package	M2::AUTOSARTemplates::SystemTemplate::SecureCommunication			
Note	This meta-class represents the ability to model a cryptographic certificate. Tags: atp.recommendedPackage=CryptoServiceCertificates			
Base	ARElement, ARObject, CollectableElement, Identifiable, MultilanguageReferrable, PackageableElement, Referrable			
Aggregated by	ARPackage.element			
Attribute	Type	Mult.	Kind	Note
algorithmFamily	CryptoCertificate AlgorithmFamilyEnum	0..1	attr	This attribute represents a description of the family of crypto algorithm used to generate public key and signature of the cryptographic certificate.
format	CryptoCertificateFormat Enum	0..1	attr	This attribute can be used to provide information about the format used to create the certificate
maximumLength	PositiveInteger	0..1	attr	This attribute represents the ability to define the maximum length of the certificate in bytes.
nextHigherCertificate	CryptoServiceCertificate	0..1	ref	The reference identifies the next higher certificate in the certificate chain.





Class	CryptoServiceCertificate			
serverName Identification	String	0..1	attr	Server Name Indication (SNI) is needed if the IP address hosts multiple servers (on the same port), each of them using a different certificate. If the client sends the SNI to the Server in the client hello, the server looks the SNI up in its certificate list and uses the certificate identified by the SNI.

Table A.11: CryptoServiceCertificate

Class	PortInterface (abstract)			
Package	M2::AUTOSARTemplates::SWComponentTemplate::PortInterface			
Note	Abstract base class for an interface that is either provided or required by a port of a software component.			
Base	ARElement, ARObject, AtpBlueprint, AtpBlueprintable, AtpClassifier, AtpType, CollectableElement, Identifiable, MultilanguageReferrable, PackageableElement, Referrable			
Subclasses	AbstractRawDataStreamInterface, AbstractSynchronizedTimeBaseInterface, ClientServerInterface, CryptoInterface, DataInterface, DiagnosticPortInterface, FirewallStateSwitchInterface, LogAndTraceInterface, ModeSwitchInterface, PersistencyInterface, PlatformHealthManagementInterface, SecurityEventReportInterface, ServiceInterface, StateManagementPortInterface, TriggerInterface			
Aggregated by	ARPackage.element			
Attribute	Type	Mult.	Kind	Note
namespace (ordered)	SymbolProps	*	aggr	This represents the SymbolProps used for the definition of a hierarchical namespace applicable for the generation of code artifacts out of the definition of a ServiceInterface. Stereotypes: atpSplitable Tags: atp.Splitkey=namespace.shortName atp.Status=draft

Table A.12: PortInterface

Class	Process			
Package	M2::AUTOSARTemplates::AdaptivePlatform::ExecutionManifest			
Note	This meta-class provides information required to execute the referenced executable. Tags: atp.recommendedPackage=Processes			
Base	ARElement, ARObject, AbstractExecutionContext, AtpClassifier, CollectableElement, Identifiable, MultilanguageReferrable, PackageableElement, Referrable, UploadablePackageElement			
Aggregated by	ARPackage.element			
Attribute	Type	Mult.	Kind	Note
design	ProcessDesign	0..1	ref	This reference represents the identification of the design-time representation for the Process that owns the reference.
executable	Executable	*	ref	Reference to executable that is executed in the process. Stereotypes: atpUriDef
functionCluster Affiliation	String	0..1	attr	This attribute specifies which functional cluster the process is affiliated with.
numberOf RestartAttempts	PositiveInteger	0..1	attr	This attribute defines how often a process shall be restarted if the start fails. numberOfRestartAttempts = "0" OR Attribute not existing, start once numberOfRestartAttempts = "1", start a second time





Class	Process			
preMapping	Boolean	0..1	attr	This attribute describes whether the executable is preloaded into the memory.
processState Machine	ModeDeclarationGroup Prototype	0..1	aggr	Set of Process States that are defined for the process.
securityEvent	SecurityEventDefinition	*	ref	The reference identifies the collection of SecurityEvents that can be reported by the enclosing SoftwareCluster. Stereotypes: atpSplittable; atpUriDef Tags: atp.Splitkey=securityEvent atp.Status=candidate
stateDependent StartupConfig	StateDependentStartup Config	*	aggr	Applicable startup configurations.

Table A.13: Process

Class	RPortPrototype			
Package	M2::AUTOSARTemplates::SWComponentTemplate::Components			
Note	Component port requiring a certain port interface.			
Base	<i>ARObject, AbstractRequiredPortPrototype, AtpBlueprintable, AtpFeature, AtpPrototype, Identifiable, MultilanguageReferrable, PortPrototype, Referrable</i>			
Aggregated by	<i>AtpClassifier.atpFeature, SwComponentType.port</i>			
Attribute	Type	Mult.	Kind	Note
required Interface	PortInterface	0..1	tref	The interface that this port requires. Stereotypes: isOfType

Table A.14: RPortPrototype

B Interfaces to other Functional Clusters (informative)

B.1 Overview

AUTOSAR decided not to standardize interfaces which are exclusively used between [Functional Clusters](#) (on platform-level only), to allow efficient implementations, which might depend e.g. on the used Operating System.

This chapter provides informative guidelines how the interaction between [Functional Clusters](#) looks like, by clustering the relevant requirements of this document to describe Inter-Functional Cluster (IFC) interfaces. In addition, the standardized public interfaces which are accessible by user space applications (see chapters [8](#) and [9](#)) can also be used for interaction between [Functional Clusters](#).

The goal is to provide a clear understanding of [Functional Cluster](#) boundaries and interaction, without specifying syntactical details. This ensures compatibility between documents specifying different [Functional Clusters](#) and supports parallel implementation of different [Functional Clusters](#). Details of the interfaces are up to the platform provider. Additional interfaces, parameters and return values can be added.

B.2 Interface Tables

No content defined.