

<b>Document Title</b>	Specification of FlexRay AUTOSAR Transport Layer
<b>Document Owner</b>	AUTOSAR
<b>Document Responsibility</b>	AUTOSAR
<b>Document Identification No</b>	601
<b>Document Status</b>	published
<b>Part of AUTOSAR Standard</b>	Classic Platform
<b>Part of Standard Release</b>	R21-11

<b>Document Change History</b>			
<b>Date</b>	<b>Release</b>	<b>Changed by</b>	<b>Change Description</b>
2021-11-25	R21-11	AUTOSAR Release Management	<ul style="list-style-type: none"> <li>No content changes</li> </ul>
2020-11-30	R20-11	AUTOSAR Release Management	<ul style="list-style-type: none"> <li>Chapter 7.7 Error detection removed</li> <li>Chapter 7.8 Error notification removed</li> <li>SWS_FrArTp_00291 moved to Chapter 8.</li> </ul>
2019-11-28	R19-11	AUTOSAR Release Management	<ul style="list-style-type: none"> <li>No content changes</li> <li>Changed Document Status from Final to published</li> </ul>
2017-10-31	4.4.0	AUTOSAR Release Management	<ul style="list-style-type: none"> <li>SWS_FrArTp_00292 removed as it is covered by BSW General</li> </ul>
2017-12-08	4.3.1	AUTOSAR Release Management	<ul style="list-style-type: none"> <li>Editorial changes</li> </ul>
2016-11-30	4.3.0	AUTOSAR Release Management	<ul style="list-style-type: none"> <li>Chapters Runtime Errors, and Transient Faults have been established</li> <li>Development Error Tracer has been replaced by Default Error Tracer</li> <li>Meta Data handling has been introduced</li> <li>Requirements about handling negative TxConfirmations has been added.</li> </ul>

<b>Document Change History</b>			
<b>Date</b>	<b>Release</b>	<b>Changed by</b>	<b>Change Description</b>
2015-07-31	4.2.2	AUTOSAR Release Management	<ul style="list-style-type: none"> <li>• Changed attribute Ecuc.postBuildVariantValue to false for FrArTpSduRxId and FrArTpSduTxId</li> </ul>
2014-10-31	4.2.1	AUTOSAR Release Management	<ul style="list-style-type: none"> <li>• Clarification regarding NULL pointer handling</li> <li>• Removed obsolete ECU configuration elements</li> </ul>
2014-03-31	4.1.3	AUTOSAR Release Management	<ul style="list-style-type: none"> <li>• Clarified meaning of FrArTpTc</li> <li>• Clarified requirements for sending FC(OVFLW)</li> <li>• Revised routing path const correctness</li> <li>• Harmonization of API descriptions</li> </ul>
2013-10-31	4.1.2	AUTOSAR Release Management	<ul style="list-style-type: none"> <li>• Retry of FrIf_Transmit mechanism has been removed in case this API returns E_NOT_OK</li> <li>• Removed FRARTP prefix for fields of FrTp frames and used camel case notation consistently for EcuC parameters</li> <li>• Removed NotifResultType from ComStackTypes and replaced by Std_ReturnType in the APIs</li> <li>• Removed the 'Timing' row from the API table(s) of chapter 'Scheduled Functions'</li> <li>• Editorial changes</li> <li>• Removed chapter(s) on change documentation</li> </ul>
2013-03-15	4.1.1	AUTOSAR Administration	<ul style="list-style-type: none"> <li>• Organization of PDUs in PDU pools</li> <li>• Dynamic assignment of Tx N-PDUs to connections at runtime</li> <li>• Reserved Tx N-PDUs for high priority connections</li> <li>• TP API improvements and fixes</li> <li>• Adapted to new BSW General</li> </ul>

<b>Document Change History</b>			
<b>Date</b>	<b>Release</b>	<b>Changed by</b>	<b>Change Description</b>
2011-12-22	4.0.3	AUTOSAR Administration	<ul style="list-style-type: none"> <li>• Adapted to the 4.x TP API</li> <li>• Removed private types FrTp_ParameterValueType, FrTp_ChangeResultType, FrTp_CancelResultType, FrTp_PduInfoType</li> <li>• Added parameter configPtr to FrArTp_Init</li> <li>• Adapted service IDs of standardized Com Stack API functions</li> </ul>
2011-04-15	4.0.2	AUTOSAR Administration	<ul style="list-style-type: none"> <li>• Added new TP layer status to Table 3</li> <li>• Corrected inconsistencies of the attributes Synchronicity and Reentrancy for FrTp_CancelTransmitRequest, FrTp_CancelReceiveRequest and FrTp_ChangeParameterRequest APIs</li> <li>• Added information about selection of FlexRay TP Protocol Engine</li> <li>• Added support for TP receive cancelation</li> <li>• Updated FrTp_ChangeParameter API syntax</li> </ul>
2010-09-30	3.1.5	AUTOSAR Administration	<ul style="list-style-type: none"> <li>• Added FRTP222, FRTP223</li> <li>• Modified FRTP195</li> <li>• Use parameter PduInfoType in callback RxIndication</li> <li>• Legal disclaimer revised</li> </ul>
2008-08-13	3.1.1	AUTOSAR Administration	<ul style="list-style-type: none"> <li>• Legal disclaimer revised</li> </ul>

<b>Document Change History</b>			
<b>Date</b>	<b>Release</b>	<b>Changed by</b>	<b>Change Description</b>
2008-02-01	3.0.2	AUTOSAR Administration	<ul style="list-style-type: none"><li>• Clarified the role and purpose of the functions PduR_FrTpChangeParameterConfirmation() and PduR_FrTpCancelTransmitConfirmation() with respect to the PDU Router.</li><li>• Document meta information extended</li><li>• Small layout adaptations made</li></ul>
2007-12-21	3.0.1	AUTOSAR Administration	<ul style="list-style-type: none"><li>• “Advice for users” revised</li><li>• “Revision Information” added</li></ul>
2007-01-24	2.1.15	AUTOSAR Administration	<ul style="list-style-type: none"><li>• Correction in Interaction Diagram</li><li>• Various descriptions adapted in Chapter 10</li><li>• Added BSW00435 due to WP112 decision</li><li>• Changing API FrTp_Transmit</li><li>• Several wording corrections</li><li>• Adaptation of chapter 5.4.2 to new SRS Requirement</li><li>• Legal disclaimer revised</li></ul>
2006-05-16	2.0	AUTOSAR Administration	<ul style="list-style-type: none"><li>• Document structure adapted to common Release 2.0 SWS Template.</li></ul>
2005-05-31	1.0	AUTOSAR Administration	<ul style="list-style-type: none"><li>• Initial Release</li></ul>

## Disclaimer

This work (specification and/or software implementation) and the material contained in it, as released by AUTOSAR, is for the purpose of information only. AUTOSAR and the companies that have contributed to it shall not be liable for any use of the work.

The material contained in this work is protected by copyright and other types of intellectual property rights. The commercial exploitation of the material contained in this work requires a license to such intellectual property rights.

This work may be utilized or reproduced without any modification, in any form or by any means, for informational purposes only. For any other purpose, no part of the work may be utilized or reproduced, in any form or by any means, without permission in writing from the publisher.

The work has been developed for automotive applications only. It has neither been developed, nor tested for non-automotive applications.

The word AUTOSAR and the AUTOSAR logo are registered trademarks.

## Table of Contents

1	Introduction and functional overview .....	9
2	Acronyms and abbreviations .....	11
3	Related documentation .....	12
3.1	Input documents.....	12
3.2	Related standards and norms.....	12
3.3	Related specification.....	13
4	Constraints and assumptions .....	14
4.1	Limitations .....	14
4.2	Applicability to car domains .....	14
5	Dependencies to other modules .....	15
5.1	PDU Router.....	15
5.2	FlexRay Interface.....	16
5.3	ECU State Manager.....	17
5.4	File structure .....	17
5.4.1	Code file structure.....	17
5.4.2	Design Rules.....	17
6	Requirements traceability .....	18
7	Functional specification.....	19
7.1	Overview .....	19
7.1.1	Extensions of ISO 15765-2.....	19
7.1.2	Connections .....	19
7.1.3	Channels .....	20
7.1.4	PDU Pools.....	20
7.1.5	Active Connections .....	20
7.2	Protocol Processes .....	20
7.2.1	1:1 Connections .....	20
7.2.1.1	1:1 Connection in a channel without Acknowledgement .....	21
7.2.1.2	1:1 Connection in a channel with Acknowledgement without Retry .....	23
7.2.1.3	1:1 Connection in a channel with Acknowledgement with Retry .....	25
7.2.2	1:n Connections .....	28
7.3	Frame Layout.....	29
7.3.1	General .....	29
7.3.2	Single Frames (SF-x).....	31
7.3.2.1	ISO 15765-2 Single Frame (SF-I) .....	31
7.3.2.2	Extended Single Frame (SF-E) .....	32
7.3.3	First Frames (FF-x) .....	34
7.3.3.1	First Frame ISO 15765-2 (FF-I).....	34
7.3.3.2	First Frame Extended (FF-E) .....	35
7.3.4	Consecutive Frames .....	36
7.3.5	Flow Control (FC).....	37
7.3.6	Acknowledgement Frame (AF) .....	39

7.3.7	Error Handling of the FT Field .....	41
7.3.8	Addressing Errors .....	43
7.4	Further Principles of Working .....	43
7.4.1	Decision of Segmentation .....	43
7.4.2	Scheduling of PDUs during Transmission .....	44
7.4.3	Detection of Receiving Connection .....	44
7.4.4	Single Frame Handling during Reception .....	45
7.4.5	Addressing with Meta Data .....	45
7.4.6	Sending and Receiving within the same connection .....	46
7.4.7	Behavior on Timeouts and Errors .....	46
7.4.7.1	Handling of negative TxConfirmations .....	46
7.4.7.2	No Acknowledgement configured for the Channel .....	46
7.4.7.3	Acknowledgement without Retry configured for the Channel .....	47
7.4.7.4	Acknowledgement with Retry configured for the Channel .....	47
7.4.8	Transmit Cancellation .....	48
7.4.9	Receive Cancellation .....	49
7.4.10	Parameter Changing .....	49
7.4.11	Data Handling, Block Size and WAIT-Frames .....	49
7.4.11.1	Unsegmented Transfer .....	50
7.4.11.2	Segmented Transfer .....	51
7.4.11.3	Buffer Locking .....	53
7.4.11.4	Data Bytes in First Frames .....	53
7.4.12	Ignored Frames .....	53
7.5	Buffer Access Modes in the FlexRay Interface .....	54
7.6	Error classification .....	54
7.6.1	Development Errors .....	54
7.6.2	Runtime Errors .....	54
7.6.3	Transient Faults .....	54
7.6.4	Production Errors .....	55
7.6.5	Extended Production Errors .....	55
8	API specification .....	56
8.1	Imported types .....	56
8.2	Type definitions .....	56
8.3	Function definitions .....	57
8.3.1	Standard functions .....	57
8.3.1.1	FrArTp_GetVersionInfo .....	57
8.3.2	Initialization and Shutdown .....	57
8.3.2.1	FrArTp_Init .....	58
8.3.2.2	FrArTp_Shutdown .....	58
8.3.3	Normal Operation .....	59
8.3.3.1	FrArTp_Transmit .....	59
8.3.3.2	FrArTp_CancelTransmit .....	59
8.3.3.3	FrArTp_CancelReceive .....	60
8.3.3.4	FrArTp_ChangeParameter .....	61
8.4	Call-back notifications .....	61
8.4.1	FrArTp_TriggerTransmit .....	61
8.4.2	FrArTp_RxIndication .....	62
8.4.3	FrArTp_TxConfirmation .....	63
8.5	Scheduled functions .....	64

8.5.1	FrArTp_MainFunction .....	64
8.6	Expected Interfaces .....	64
8.6.1	Mandatory Interfaces .....	64
8.6.2	Optional Interfaces .....	65
9	Sequence diagrams .....	66
9.1	N-SDU Transmission .....	66
9.1.1	Unsegmented N-SDU Transmission .....	66
9.1.2	Segmented N-SDU Transmission without Retry .....	66
9.1.3	Segmented N-SDU Transmission with Retry .....	67
9.1.3.1	N-PDU Transmission during N-SDU Transmission .....	69
9.1.4	N-PDU Data Copying during N-SDU Transmission .....	70
9.1.4.1	Transmit Cancellation .....	71
9.2	N-SDU Reception .....	71
9.2.1	Unsegmented N-SDU Reception .....	72
9.2.2	N-PDU Data Copying during Unsegmented N-SDU Reception .....	72
9.2.3	Segmented N-SDU Reception .....	74
9.2.4	Wait for Buffer during Segmented N-SDU Reception .....	76
9.2.5	N-PDU Data Copying during Segmented N-SDU Reception .....	77
9.2.6	N-PDU Transmission during N-SDU Reception .....	77
9.2.7	Receive Cancellation .....	78
10	Configuration specification .....	79
10.1	How to read this chapter .....	79
10.2	Containers and configuration parameters .....	79
10.2.1	FrArTp .....	82
10.2.2	FrArTpGeneral .....	82
10.2.3	FrArTpChannel .....	84
10.2.4	FrArTpPdu .....	91
10.2.5	FrArTpConnection .....	93
10.2.6	FrArTpTxSdu .....	95
10.2.7	FrArTpRxSdu .....	95
10.2.8	FrArTpMultipleConfig .....	96
10.3	Published Information .....	97
10.4	Important Issues on Configuration .....	97
10.4.1	Start and Stop of the Timing Parameters .....	97
10.4.2	How to get an ISO 15765-2 compliant Channel / Connection .....	97
10.4.3	Dependencies among the Parameters .....	98
10.4.4	Timing Constraints .....	98
10.4.5	Configuration Requirements on the FlexRay AUTOSAR Transport Layer .....	99
10.4.6	Configuration Requirements on the FlexRay Interface .....	99
11	Not applicable requirements .....	101



## 1 Introduction and functional overview

This specification describes the functionality, API, and configuration of the AUTOSAR basic software module FlexRay AUTOSAR Transport Layer (FrArTp).

The FlexRay AUTOSAR Transport Layer module resides between the PDU Router [6] and the FlexRay Interface [5] (see Figure 1, according to [2]). The main purpose of FlexRay AUTOSAR Transport Layer module is segmentation and reassembly of messages that do not fit in a single FlexRay L-SDU.

The PDU Router deploys I-PDUs of AUTOSAR COM or DCM to different communication protocols. The routing through a network system type (e.g. CAN, LIN and FlexRay) depends on the I-PDU identifier. The PDU-Router is also in charge of determining whether a transport protocol has to be used or not.

The FlexRay Interface (Frlf) provides mechanisms to access a FlexRay bus channel regardless of its location ( $\mu$ C internal/external). It abstracts from the location of FlexRay controllers (on chip / onboard), the ECU hardware layout and the number of FlexRay drivers. The Frlf is in charge to route received PDUs to the FlexRay AUTOSAR Transport Layer module, the PDU Router, the FlexRay NM and the XCP.

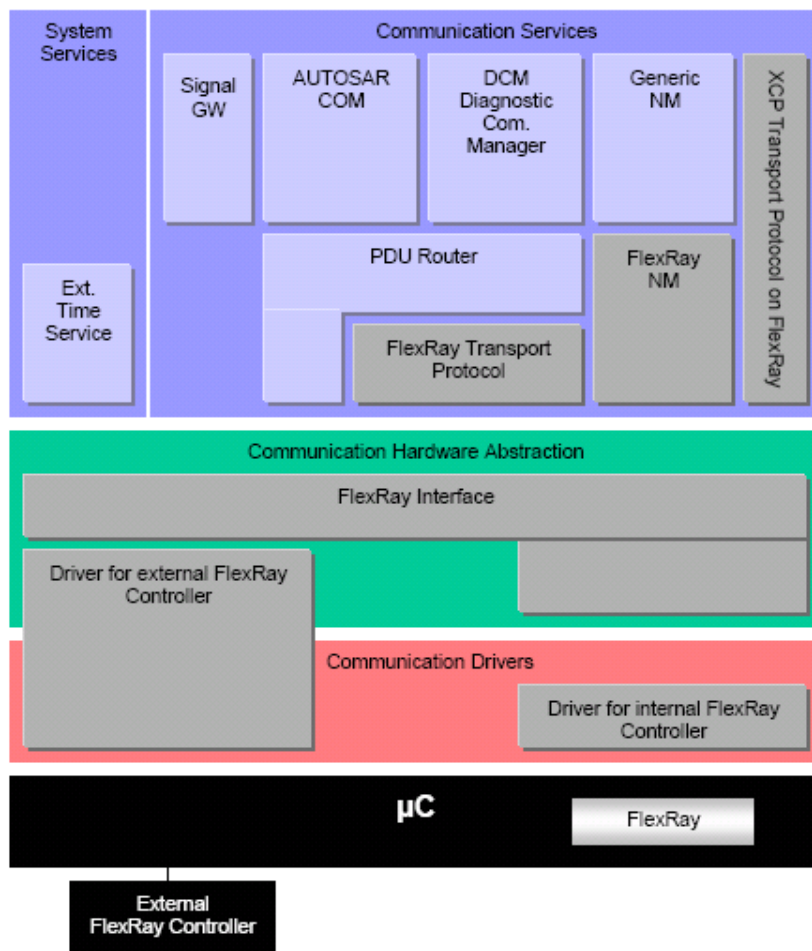

Figure 1: AUTOSAR FlexRay Layered Architecture

Among others, the FlexRay AUTOSAR Transport Layer includes the following features:

- Segmentation of data in send direction
- Collection of data in receive direction
- Control of data flow
- Detection of errors
- Acknowledgement (and Retry)
- 1:1 and 1:n connections
- 2 or 4 Bytes address information
- Transfer of up to  $2^{32}-1$  Bytes payload
- Configurable to be compliant to ISO 15765-2 regarding frame layout and sequences

This specification supports only the AUTOSAR FlexRay transport protocol derived from ISO 15765-2, which was used as standard in AUTOSAR release 3.x and below. Since AUTOSAR release 4.0, the standard FlexRay transport layer [11] is compatible to ISO 10681-2. For AUTOSAR release 3.2, a back port of the ISO 10681-2 compliant FlexRay transport layer has been created as a separate document named FlexRay ISO Transport Layer. Thus, both in AUTOSAR release 3.2 and 4.0, users must be cautious in choosing which specification to use for FlexRay Transport Layer.

It is an AUTOSAR decision to base the specification of Basic Software modules on existing standards. The FlexRay AUTOSAR Transport Layer specification is based on the international standard ISO 15765-2 (Diagnostics on CAN), which is the most common in automotive area.

The basic idea is to have an ISO 15765-2 compliant Transport Layer, which allows by the means of static configuration to add one or more optional features (like acknowledgement) per channel independently of each other. Of course, by adding such a feature the compliance to ISO 15765-2 gets lost for this particular channel.

Additionally, the features are deactivatable at compile time. Even if they are compiled in, they are still deactivatable by static configuration.

The rationale behind some of the provided features is the usage of this transport layer not only for diagnostic purposes but also for Inter-ECU communication.

Since addressing within ISO 15765-2 is specific for the CAN bus system (CAN identifier), it is obvious that another approach is taken within FlexRay AUTOSAR Transport Layer.

Although FlexRay transport protocol is at first set to vehicle diagnostic systems, it has been developed to also deal with requirements from other FlexRay based systems needing a transport layer protocol.

## 2 Acronyms and abbreviations

Following acronyms and abbreviations have a local scope only and therefore are not contained in the AUTOSAR glossary.

<b>Acronym:</b>	<b>Description:</b>
Channel	A channel hosts a group of connections sharing the properties configurable by the parameters in section 10.2.
Connection	Communication path between two nodes (1:1) or one node and the network (1:n), characterized by the parameters in section 10.2.
Frame	Synonymous for N-PDU or L-SDU.
I-PDU	PDU of the AUTOSAR COM module; corresponds to an N-SDU of the FlexRay Transport Layer.
L-SDU	This is the SDU of the FlexRay Interface. It represents the same entity as the N-PDU, but from the FlexRay Interface's point of view.
L-SDU ID	Unique identifier of an L-SDU; used by upper layers such as the FlexRay AUTOSAR Transport Layer module to interact with the FlexRay Interface.
Message	Synonymous for N-SDU or I-PDU.
N-PDU	This is a PDU of the FlexRay AUTOSAR Transport Layer, which is given to the FlexRay Interface for Sending. It consists of address information, protocol control information and the payload (N-SDU).
N-SDU	This is the SDU of the FlexRay AUTOSAR Transport Layer. In the AUTOSAR architecture, it is a set of data exchanged with the PDU Router.
N-SDU ID	Unique identifier of an SDU; used by upper layers such as the PDU Router to interact with the FlexRay Transport Layer.
PDU pool	Set of FlexRay N-PDUs that share the same size and same addressing type.

<b>Abbreviation:</b>	<b>Description:</b>
AF	Acknowledgement Frame
CF	Consecutive Frame
COM	AUTOSAR COM module
FC	Flow Control
FF	First Frame
Fr	FlexRay
PCI	Protocol Control Information
FrIf	FlexRay Interface
FrArTp	FlexRay AUTOSAR Transport Layer (derived from ISO 15765-2)
FrIsoTp	FlexRay ISO Transport Layer (ISO 10681-2)
FrTp	FlexRay Transport Layer
NM	Network Management
PDU	Protocol Data Unit
PduR	PDU Router
SDU	Service Data Unit
SF	Single Frame
XCP	Universal Calibration Protocol

## 3 Related documentation

### 3.1 Input documents

- [1] List of Basic Software Modules  
AUTOSAR\_TR\_BSWModuleList.pdf
- [2] Layered Software Architecture  
AUTOSAR\_EXP\_LayeredSoftwareArchitecture.pdf
- [3] General Requirements of Basic Software Modules  
AUTOSAR\_SRS\_BSWGeneral.pdf
- [4] Requirements on FlexRay  
AUTOSAR\_SRS\_FlexRay.pdf
- [5] Specification of FlexRay Interface  
AUTOSAR\_SWS\_FlexRayInterface.pdf
- [6] Specification of PDU Router  
AUTOSAR\_SWS\_PDURouter.pdf
- [7] Specification of Communication Stack Types  
AUTOSAR\_SWS\_CommunicationStackTypes.pdf
- [8] Specification of Standard Types  
AUTOSAR\_SWS\_StandardTypes.pdf
- [9] Specification of Platform Types  
AUTOSAR\_SWS\_PlatformTypes.pdf
- [10] AUTOSAR Basic Software Module Description Template,  
AUTOSAR\_TPS\_BSWModuleDescriptionTemplate.pdf
- [11] Specification of FlexRay ISO Transport Layer  
AUTOSAR\_SWS\_FlexRayISOTransportLayer.pdf
- [12] General Specification of Basic Software Modules  
AUTOSAR\_SWS\_BSWGeneral.pdf

### 3.2 Related standards and norms

- [13] ISO 15765-2(2003-11-11), Road vehicles — Diagnostics on Controller Area Networks (CAN) — Part2: Network layer services
- [14] ISO 10681-2, Road vehicles — Communication on FlexRay — Part2: Communication Layer Services

[15] FlexRay Communications System Protocol Specification Version 2.1

### **3.3 Related specification**

AUTOSAR provides a General Specification on Basic Software modules [12] (SWS BSW General), which is also valid for FlexRay AUTOSAR Transport Layer.

Thus, the specification SWS BSW General shall be considered as additional and required specification for FlexRay AUTOSAR Transport Layer.

## **4 Constraints and assumptions**

### **4.1 Limitations**

AUTOSAR architecture defines protocol specific transport layer (CanTp, LinTp, Fr[Ar]Tp, etc.). The FlexRay AUTOSAR Transport Layer covers only FlexRay transport protocol specifics.

The FlexRay AUTOSAR Transport Layer has an interface to a single underlying FlexRay Interface Layer and a single upper PDU Router.

### **4.2 Applicability to car domains**

The FlexRay AUTOSAR Transport Layer can always be used for applications if the FlexRay protocol was used.

## 5 Dependencies to other modules

This section sets out relations between the FlexRay AUTOSAR Transport Layer module (FrArTp) and other AUTOSAR Basic Software modules. It contains brief descriptions of the services of the FrArTp that are called by other modules and of the services of other modules that are called by the FrArTp. The following picture gives a brief overview of the interactions.

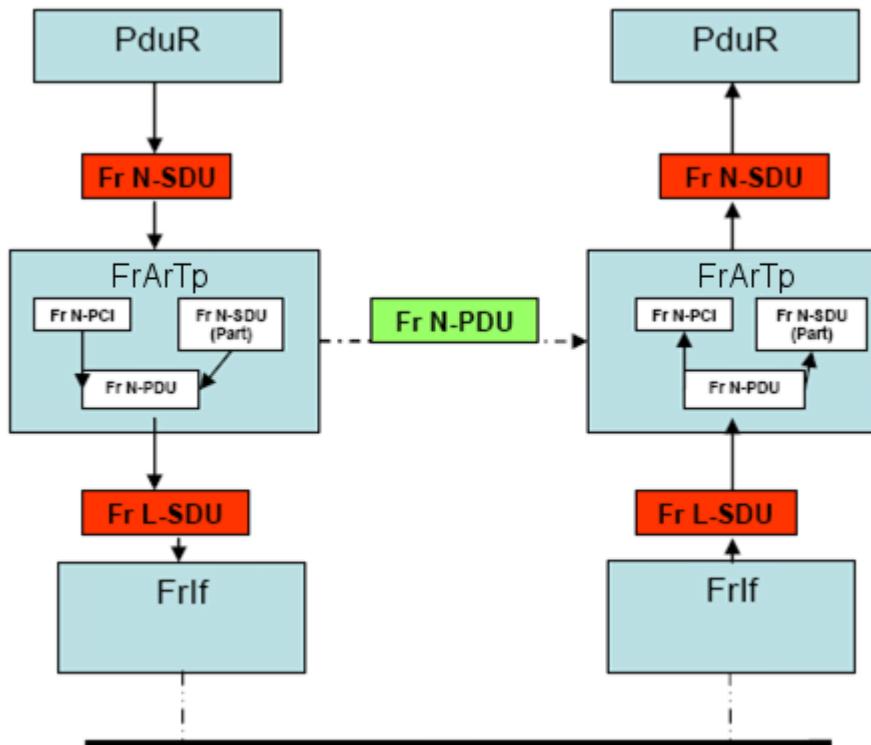

Figure 2: FrArTp interactions

### 5.1 PDU Router

The following services of the PDU Router are called by the FlexRay AUTOSAR Transport Layer module:

- *PduR\_FrArTpStartOfReception*  
By this API service, the FlexRay AUTOSAR Transport Layer module informs the upper layer (e.g. DCM via PDU Router) that a new message is being received.
- *PduR\_FrArTpCopyRxData*  
By this API service, the FlexRay AUTOSAR Transport Layer module provides the data of one received segmented message part (N-PDU) to the upper layer.

- *PduR\_FrArTpRxIndication*  
By this API service, the FlexRay AUTOSAR Transport Layer module indicates the completed (un)successful reception of a message (N-SDU).
- *PduR\_FrArTpCopyTxData*  
By this API service, the FlexRay AUTOSAR Transport Layer module asks the upper layer (e.g. DCM via PDU Router) of the message to provide data for the next segmented message part (N-PDU).
- *PduR\_FrArTpTxConfirmation*  
By this API service, the FlexRay AUTOSAR Transport Layer module confirms the (un)successful sending of the complete message (N-SDU) to the actual sender (e.g. DCM).

The following services of the FlexRay AUTOSAR Transport Layer module are called by the PDU Router:

- *FrArTp\_Transmit*  
By this API service, the sending of a message (N-SDU) is triggered.
- *FrArTp\_CancelTransmit*  
By this API service, the sending of a message (N-SDU) is cancelled. This service is optional (per channel).
- *FrArTp\_CancelReceive*  
By this API service, the receiving of a message (N-SDU) is cancelled. This service is optional (per channel).
- *FrArTp\_ChangeParameter*  
By this API service, the STmin and BS values of a connection can be changed.

## 5.2 FlexRay Interface

The following services of the FlexRay Interface are called by the FlexRay AUTOSAR Transport Layer module:

- *Frlf\_Transmit*  
By this API service, the sending of a frame (N-PDU) is triggered. Depending on configuration on the FlexRay Interface, the N-PDU is sent immediately or after the call of FrArTp\_TriggerTransmit.

The following services of the FlexRay AUTOSAR Transport Layer module are called by the FlexRay Interface:

- *FrArTp\_RxIndication*  
By this API service, the FlexRay Interface indicates the reception of an FrArTp frame (N-PDU, please do not mistake this with a FlexRay frame) to the FrArTp. The FrArTp then processes this frame.
- *FrArTp\_TxConfirmation*  
By this API service, the FlexRay Interface confirms the (un)successful sending of the frame containing the N-PDU over the FlexRay network.



- *FrArTp\_TriggerTransmit*  
By this API service, the FlexRay Interface makes the FrArTp to copy the N-PDU into the buffer provided by the FlexRay Interface. The FlexRay interface then can start sending the FlexRay frame containing the N-PDU.

### 5.3 ECU State Manager

The following services of the FrArTp are called by the ECU State Manager:

- *FrArTp\_Init*  
By this API service, all global variables are initialized and each connection is set into the idle state.
- *FrArTp\_Shutdown*  
By this API service, all pending transport connections are closed, resources are freed and the module is stopped.

### 5.4 File structure

#### 5.4.1 Code file structure

For details, refer to the section 5.1.6 “Code file structure” in *SWS\_BSWGeneral*.

#### 5.4.2 Design Rules

**[SWS\_FrArTp\_00213]** [The source code of the FrArTp shall not be processor and compiler dependent.](SRS\_BSW\_00006)

## 6 Requirements traceability

Requirement	Description	Satisfied by
SRS_BSW_00004	All Basic SW Modules shall perform a pre-processor check of the versions of all imported include files	SWS_FrArTp_00201
SRS_BSW_00006	The source code of software modules above the $\mu$ C Abstraction Layer (MCAL) shall not be processor and compiler dependent.	SWS_FrArTp_00213
SRS_BSW_00101	The Basic Software Module shall be able to initialize variables and hardware in a separate initialization function	SWS_FrArTp_00147
SRS_BSW_00159	All modules of the AUTOSAR Basic Software shall support a tool based configuration	SWS_FrArTp_00180, SWS_FrArTp_00181
SRS_BSW_00323	All AUTOSAR Basic Software Modules shall check passed API parameters for validity	SWS_FrArTp_00291
SRS_BSW_00336	Basic SW module shall be able to shutdown	SWS_FrArTp_00148
SRS_BSW_00337	Classification of development errors	SWS_FrArTp_00179
SRS_BSW_00369	All AUTOSAR Basic Software Modules shall not return specific development error codes via the API	SWS_FrArTp_00149, SWS_FrArTp_00154
SRS_BSW_00411	All AUTOSAR Basic Software Modules shall apply a naming rule for enabling/disabling the existence of the API	SWS_FrArTp_00215
SRS_Fr_05075	The FlexRay Transport Layer implementation shall be independent of the network configuration	SWS_FrArTp_00149
SRS_Fr_05088	FlexRay Transport Layer's variables shall be initialized	SWS_FrArTp_00147
SRS_Fr_05089	The FlexRay Transport Layer services shall not be operational before initializing the module.	SWS_FrArTp_00179
SRS_Fr_05090	The FlexRay Transport Layer shall support per connection the ISO 10681-2 / ISO 15765-2 service N_ChangeParameter	SWS_FrArTp_00104
SRS_Fr_05093	A cancellation service of transmission shall be provided at any time	SWS_FrArTp_00099

## 7 Functional specification

The FlexRay AUTOSAR Transport Layer module (FrArTp) offers services for segmentation, transmission with flow control, and reassembly of messages (N-SDUs). Its main purpose is to transfer messages that may or may not fit in a single FlexRay frame.

**[SWS\_FrArTp\_00192]** 「The FlexRay AUTOSAR Transport Layer provides full duplex capabilities for PDU pools and connections.」()

**[SWS\_FrArTp\_00201]**「The FrArTp shall perform a preprocessor-check if its source and header files belong to the same version.」(SRS\_BSW\_00004)

### 7.1 Overview

#### 7.1.1 Extensions of ISO 15765-2

**[SWS\_FrArTp\_00009]** 「Beside the features according to ISO 15765-2 (7 byte data per frame, 4 kByte message length, unsegmented 1:n connections, multiple logical channels concurrently, flow control, service request confirmation) it allows to configure independently of each other the following features for a specific channel at both pre- and post-compile time:

- Acknowledgement (with or without Retry) for 1:1 connections
- Segmented 1:n connections (without flow control)
- Transmission cancellation
- Up to  $2^{32}-1$  Byte message length」()

For the rest of this document, sections or features that are not compliant to ISO 15765-2 will be marked as “**Not compliant to ISO 15765-2**”.

#### 7.1.2 Connections

Connections are used to transfer data from one sender to one (1:1) or more (1:n) receivers. Connections with one sender and one receiver are bi-directional; data can be transferred in both directions. To transport parts of a possibly much larger message, connections use FlexRay PDUs that are grouped into PDU pools. Connections may specify a number of prioritized PDUs that must be reserved for exclusive use as long as the connection is active.

### 7.1.3 Channels

A Channel is used to group several connections with similar properties and to manage access to the transport PDUs. Consequently, the channel itself carries all relevant properties, like addressing type, timing and handshake parameters, and acknowledgement and retry capability, and the transport PDUs of at most one received and one transmitted PDU pool.

### 7.1.4 PDU Pools

A PDU pool is a conceptual element, which groups the transport PDUs of several channels. The PDUs in a PDU pool need to have identical PDU sizes and addressing type. For a specific ECU, a PDU pool is either received or transmitted. The PDUs in a PDU pool may be used by one or more channels. To ensure the pool semantics in a configuration, channels must reference either all PDUs of a Pool, or none. It must also be ensured that no two connections assigned to the same PDU pool have identical addresses. The PDUs of a PDU pool are evenly distributed to all open connections at runtime, but only after all PDU required by open connections with prioritized PDUs have been assigned.

### 7.1.5 Active Connections

The maximum number of concurrently active connections is configurable separately for each channel via `FrArTpConcurrentConnections`. This number can range from one connection at a time to all connections of the channel. For each active connection, two separate state machines are required, because connections can be bi-directional. These state machines belong to the channel, and are therefore associated with the PDU pool used by this channel.

State machines are assigned to connections at runtime when a new data-transmission is requested, or when frames of an incoming connection are received. When the maximum number of state machines is reached, further transmission requests or new incoming connections must be rejected or ignored, respectively.

For each state machine, a RAM buffer will be needed to store the content of the next to-be-transmitted frame(s) until enough data is available, and until the frame has been transferred to Frlf via *FrArTp\_TriggerTransmit*.

## 7.2 Protocol Processes

There are, as will be shown later on, different types of First Frames and Single Frames, but in the sequence diagrams, always FF or SF will be used, regardless of the concrete sub type.

### 7.2.1 1:1 Connections

This type of connections exists between two nodes and is bidirectional. Within the FlexRay AUTOSAR Transport Layer, the following subtypes are possible.

### 7.2.1.1 1:1 Connection in a channel without Acknowledgement

#### Unsegmented Transfer

When a message does not exceed the possible amount of payload for a SF (which can be derived from the N-PDU length, FrArTpAdrType and FrArTpLm), there is no need to segment this message.

The transfer takes place as illustrated in Figure 3:

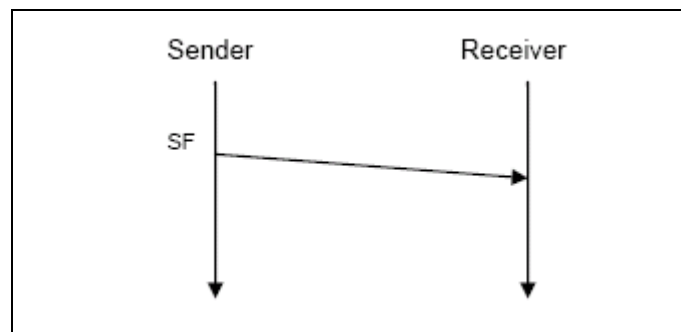

**Figure 3: Unsegmented 1:1 transfer without acknowledgement**

The sending Transport Layer packs the payload (N-SDU) into an N-PDU and sends it to the receiving Transport Layer. This is done via a Single Frame (SF).

#### Segmented Transfer

In case a message does not fit into an SF, it needs to be split up into several parts and flow control is applied to control the data flow taking into account the needs of the receiver.

In this case, the transfer takes place as shown in Figure 4:

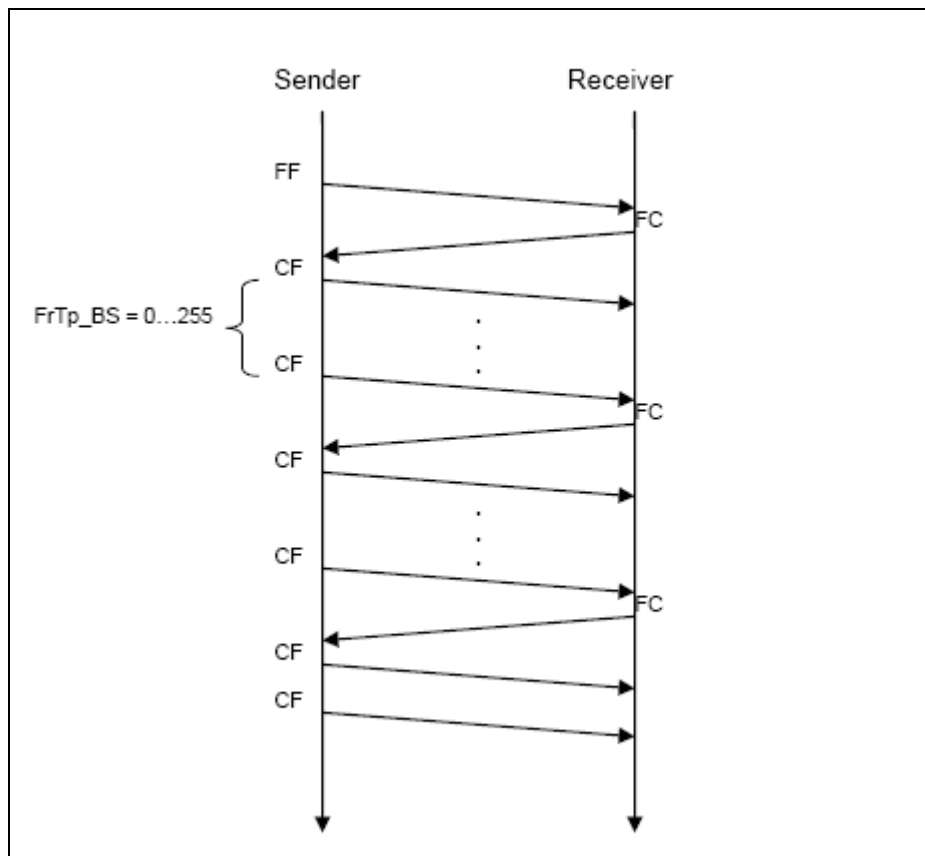

**Figure 4: Segmented 1:1 transfer without acknowledgement**

The transfer starts with sending a First Frame (FF) from the sender to the receiver. This frame contains the length of the whole message (e.g. 1000 Byte) and even the first data bytes.

The receiving peer reacts to the reception of a FF with sending of a Flow Control frame (FC) back to the sender. This FC frame contains the value of three parameters: FS,BS and STmin.

FS states the flow status. The possible values are:

- CTS: Clear To Send  
The sender can continue transmitting the message
- WT: Wait  
The sender shall wait for another FC frame.
- OVFLW: Overflow  
The sender shall abort the transfer, because the receiver has not enough buffer space for the whole message available.

There shall be a statically defined upper limit (FrArTpMaxWft) for the number of allowed WT's. If this number has been reached, the transmission shall be aborted and within *PduR\_FrArTpTxConfirmation*, the result E\_NOT\_OK shall be returned.

BS specifies the block size. This is the number of Consecutive Frames (CF) the sender is allowed to send between two FC Frames. The possible range is from 0x00 to 0xFF, whereas 0x00 states that no more FC Frames will be transmitted by the receiver, i.e. the whole message shall be sent in one big block.

STmin defines the minimum gap between two CFs in milliseconds or microseconds. The valid values range from 0x00 to 0x7F and from 0xF1 to 0xF9. The range from 0x00 to 0x7F specifies the minimum gap in milliseconds (0ms .. 127ms), the one from 0xF1 to 0xF9 defines the gap in microseconds (100 µs, 200 µs, .. 900 µs). The supported values of STmin are restricted by the placement of N-PDUs in FlexRay cycles, and are subject to the jitter created by the placement of N-PDUs in the slots of a cycle.

The alternating transmission of CF blocks and a FC frame lasts, until the whole message is sent.

The STmin parameter can be changed during runtime by using the respective API call.

### 7.2.1.2 1:1 Connection in a channel with Acknowledgement without Retry

This section is **Not compliant to ISO 15765-2** and describes how a simple acknowledgement mechanism looks like.

#### Unsegmented Transfer

This is mostly done like in section Unsegmented Transfer of section 7.2.1.1, except that there is an additional Acknowledge Frame (AF) which is sent from the receiver to the sender. This is illustrated in Figure 5:

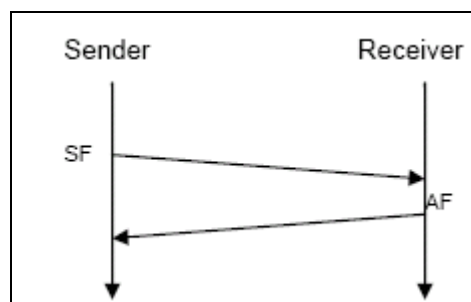

**Figure 5: Unsegmented 1:1 transfer with Acknowledgement without Retry**

The AF contains among others the field ACK, which has two possible values, Positive Acknowledgement (POS\_ACK) or Negative Acknowledgement (NEG\_ACK). Thus, the sender is informed about the (un)successful reception of a message by the receiving peer. If the FS field of an AF frame (see section 7.3.6) contains the value WT, another AF, up to FrArTpMaxRn, will arrive.

### **Segmented Transfer**

This is done very similar to section Segmented Transfer of section 7.2.1.1. There are only three differences:

The first difference is the transmission of an AF after the last block, because this one has to be acknowledged as well. This frame is similar to an ordinary Flow Control frame but contains additionally the ACK parameter (for positive or negative acknowledgement) and the sequence number of the first faulty frame of the transmitted block.

The second difference is the transmission of an AF with a negative acknowledgement after a block in which an error occurred. This AF also contains the sequence number of the first faulty or missing frame.

The third difference is, that the block size shall be in the range from 1 to 16 (due to the 4 bit sequence number, see section 7.3.4)



The procedure can be seen in Figure 6:

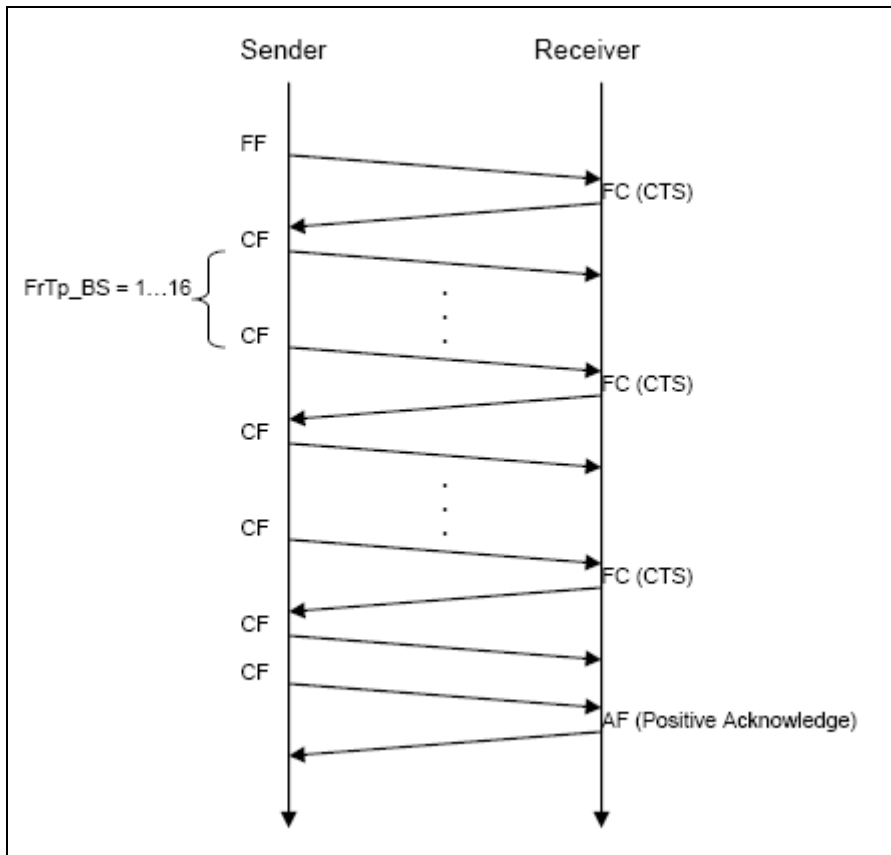

**Figure 6: Segmented 1:1 transfer with Acknowledgement without Retry**

Obviously, the acknowledgement is done on a “per block” basis, depending on the current block size.

In case of a negative acknowledgement after a block (in that case instead of an FC frame an AF with a negative acknowledgement is sent to the sender and the receiver aborts the reception and indicates an appropriate result to its upper layer (*PduR\_FrArTpRxIndication*) the sender aborts the transmission and informs its upper layer (*PduR\_FrArTpTxConfirmation*).

### 7.2.1.3 1:1 Connection in a channel with Acknowledgement with Retry

This section is **Not compliant to ISO 15765-2**

#### Unsegmented Transfer

This section is quite similar to the corresponding one in section 7.2.1.2. The only difference is that in case of a negative acknowledgement the frame is retransmitted.

This behavior is depicted in Figure 7 and Figure 8:

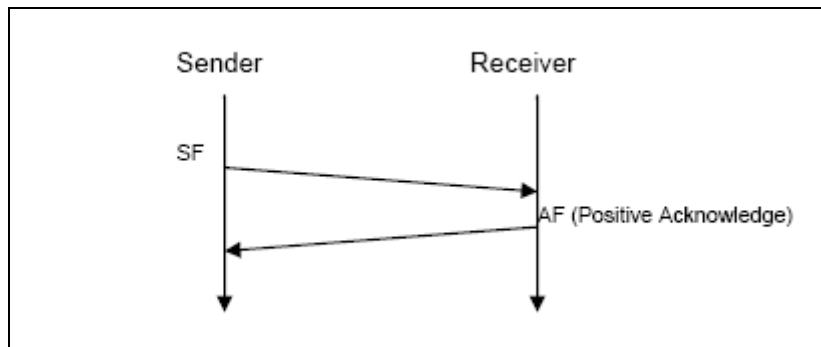

**Figure 7: Unsegmented 1:1 transfer, Acknowledgement with Retry configured, Positive Acknowledgement**

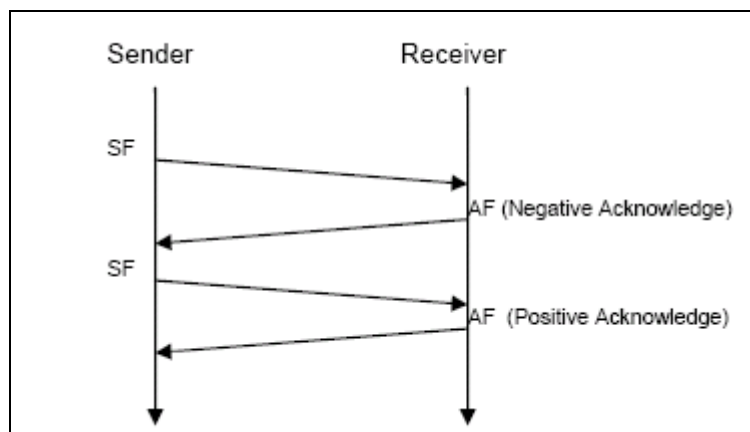

**Figure 8: Unsegmented 1:1 transfer, Acknowledgement with Retry configured, Negative Acknowledgement**

If in Figure 8 the second try of sending the message also failed, there would be a third one and so on.

In order to prevent infinite retransmissions in the case of a permanent failure, an upper limit (*FrArTpMaxRn*) has to be defined. If the number of retries has reached this value, the transmission of the corresponding message shall be stopped and within *PduR\_FrArTpTxConfirmation* and *PduR\_FrArTpRxIndication*, an adequate result (see section 8.2.1) shall be returned.

### Segmented Transfer

Compared to the segmented transfer in section 7.2.1.2, the difference is the Retry mechanism and, coming with it, the alternating block mechanism.

The Retry mechanism works as follows:

In the case a negative acknowledge arrives at the sender, this also contains the sequence number of the first faulty frame in the currently transmitted block. Now the sender transmits, starting with the stated sequence number, all remaining frames of the just transmitted block again.

In order to prevent infinite retransmissions in case of a permanent failure, the parameter FrArTpMaxRn limits the retry attempts.

The Retry mechanism is shown in Figure 9 for the case of a block size of 4:

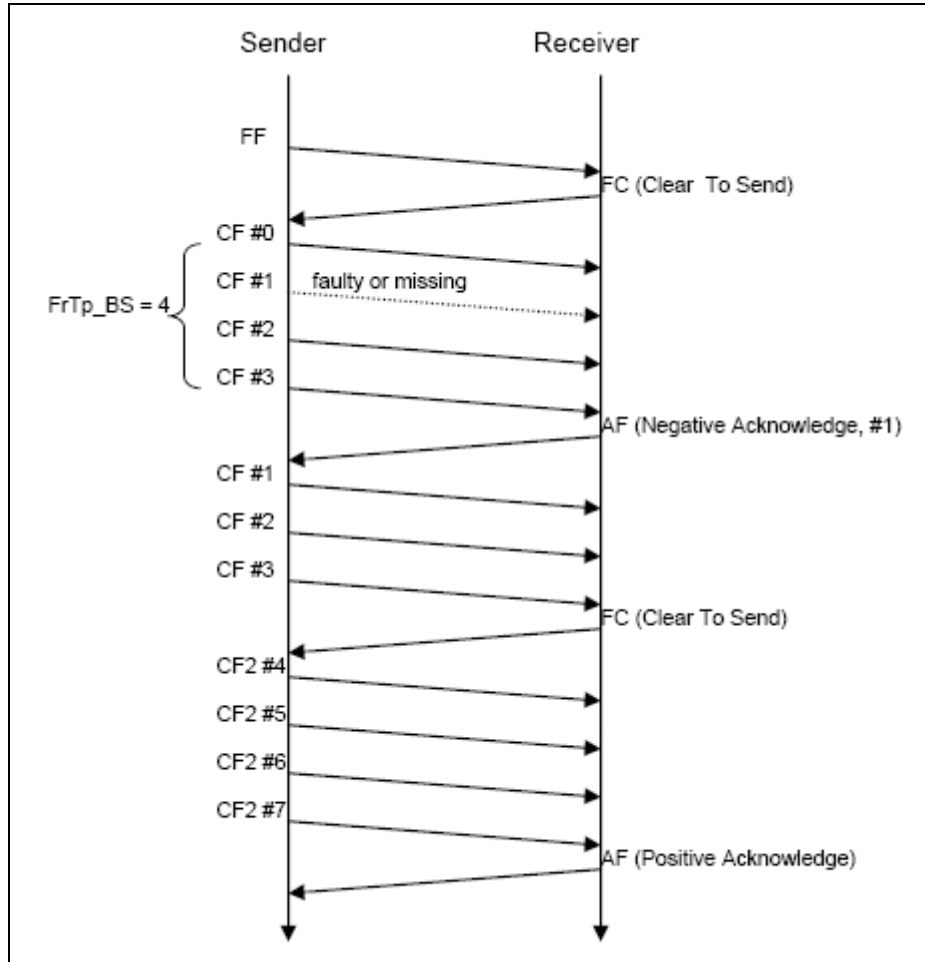

**Figure 9: Segmented 1:1 transfer with Acknowledgement with Retry**

If the retry starts with a lower sequence number than requested, this shall be tolerated, i.e. all frames until the requested shall be ignored and errors within the ignored frames shall be ignored, too. If it starts with a higher number than requested, this shall lead to another negative acknowledgement after the block end.

### Alternating Block Mechanism

When using the Retry mechanism, the FlexRay AUTOSAR Transport Layer module transfers blocks using the Alternating Block Mechanism. This works as follows: The first block is transferred using normal CF frames. The second block is transferred using CF2 frames, the third one with CF frames and so on. When a retry occurs, a CF block is again transferred with CF frames and, of course, a CF2 block is retried with CF2 frames.

This mechanism ensures correct behavior in case at the block end an FC frame is lost, especially if it is an FC with flow status CTS, by allowing the detection of the unnecessary retries.

### 7.2.2 1:n Connections

In the case of 1:n connections (1 sender, multiple receivers) there is no further distinction in subtypes (with or without acknowledgement). The reason for this is that the size of the receiving group is often not known a priori, so it is not possible to apply flow control or acknowledgement mechanisms to 1:n connections.

Therefore, the only distinction made is between unsegmented and segmented transfer.

1:n connections are unidirectional by nature.

#### Unsegmented Transfer

This is exactly the same like in the section Unsegmented Transfer of section 7.2.1.1. The only difference is the multiple receivers instead of one. Thus, the procedure looks like the following:

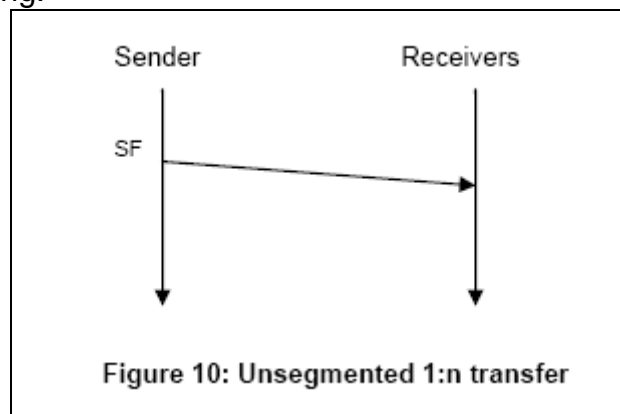

Figure 10: Unsegmented 1:n transfer

Figure 10: Unsegmented 1:n transfer

One sender sends its message to a group of receivers.

#### Segmented Transfer Not compliant to ISO 15765-2

Since no flow control or acknowledgement is possible in this case, a segmented 1:n transfer only consists of a FF and the number of necessary CFs.

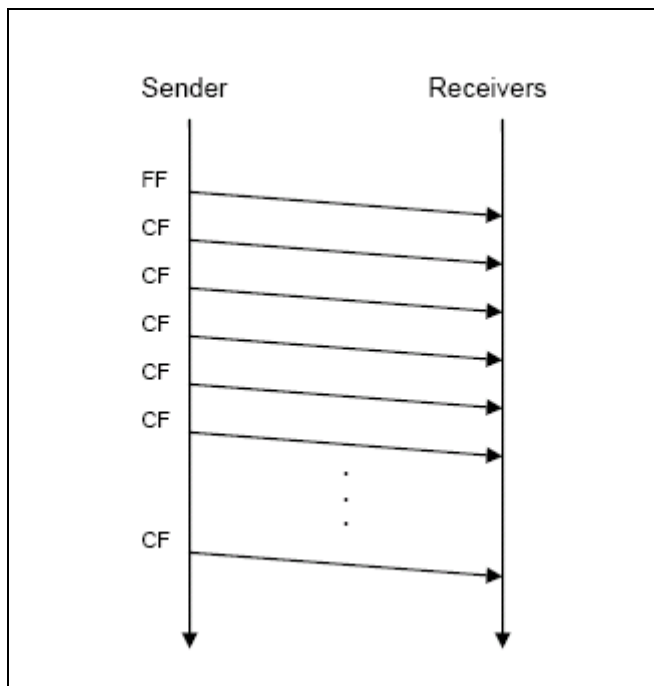

Figure 11: Segmented 1:n transfer

When an error occurs, the reception will be terminated, and the appropriate result will be given within *PduR\_FrArTpRxIndication()*.

The distance of consecutive CFs is defined by the configuration parameter *FrArTpStMinGrpSeg*, similar to *FrArTpStMin* for segmented 1:1 connections.

### 7.3 Frame Layout

As seen in section 7.2 there are different types of frames. A detailed explanation of all the types follows below.

#### 7.3.1 General

The general structure of a frame is shown in Figure 12:

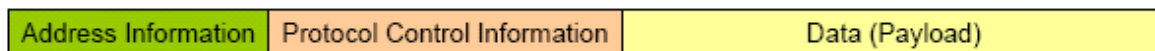

Figure 12: Structure of a FlexRay AUTOSAR transport protocol frame

It is common to all frames that they are headed by address information. Depending on static configuration (per channel), in a way whether 1 Byte or 2 Byte addressing is used, this address information consists of 1 Byte for Target Address and 1 Byte for Source Address or 2 Bytes for Target address and 2 Bytes for Source Address. Since it depends on the interpretation of the address information, it is not further

specified whether this address information is utilized for the in automotive area so called “Physical” or for “Functional” addressing.

**[SWS\_FrArTp\_00255]** [When the FrArTp frame does not require the whole length of its N-PDU (in a SingleFrame, a FirstFrame, or the last ConsecutiveFrame in a transfer), the remaining space (bits) in the N-PDU shall be set to 0.]()

**1 Byte Addressing Not compliant to ISO 15765-2**

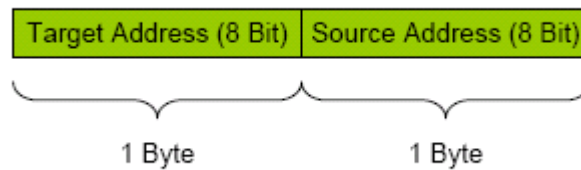

**Figure 13: Address header for 1 Byte addressing**

For both target and source address 1 Byte is provided, so up to 256 receivers are addressable.

**2 Byte Addressing Not compliant to ISO 15765-2**

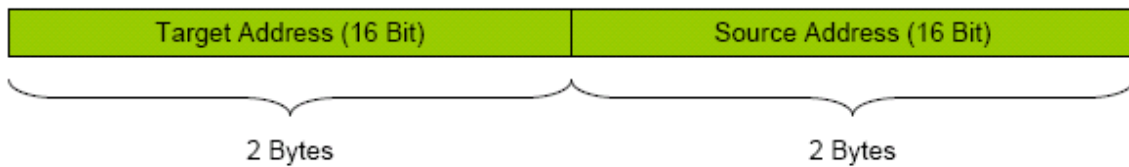

**Figure 14: Address header for 2 Byte addressing**

Looking at this scheme it is possible to address up to 65536 different receivers.

As seen in Figure 12, frames generally consist of the address information, protocol control information and the data. The length and content of the protocol control information (PCI) varies from frame type to frame type.

Before explaining the details of each frame, a short overview is given by the following table (the mentioned bytes and nibbles regard to the PCI):

**[SWS\_FrArTp\_00021]**

ISO 15765-2	Name	1st Nibble	2nd Nibble	2nd Byte	3rd Byte	4th Byte	5th Byte	Description
YES	SF-I	0x0	DL	data				ISO 15765-2 Single Frame
NO	SF-E	0x4	Res (0x0)	DL	data			Extended Single Frame
YES	FF-I	0x1	DL		data			ISO 15765-2 First Frame
NO	FF-E	0x5	Res (0x0)	DL				Extended First Frame
YES	CF	0x2	SN	data				ISO 15765-2 Consecutive Frame
NO	CF2	0x6	SN	data				Consecutive Frame used in Retry Channels
YES / NO	FC	0x3	FS	BS	STmin	--	--	(ISO 15765-2) Flow Control Frame
NO	AF	0x7	FS	BS	STmin	ACK (4 Bit) / SN (4 Bit)	--	Acknowledgement Frame

**Table 1: Overview of the different frames format**

**Note:** Unused bytes in this table shall be set to 0x00.

### Endianness

In case a protocol value transmitted over the bus consists of more than 1 Byte (e.g. Source Address and Target Address when using 2-Byte addressing), the endianness shall be Most Significant Byte first, Least Significant Byte last.

## 7.3.2 Single Frames (SF-x)

**[SWS\_FrArTp\_00022]** A SF is sent when a message does not exceed the available amount of payload of this frame type or if ISO 15765-2 compliance is required. To be compliant with ISO 15765-2 on the one hand and to allow using the possibilities of FlexRay on the other hand, there are two types of Single Frames. In ISO 15765-2 compliant channels only SF-I is allowed, in non ISO 15765-2 compliant channels (i.e. FrArTpLm = FRARTP\_L4G) only SF-E is allowed.

### 7.3.2.1 ISO 15765-2 Single Frame (SF-I)

**[SWS\_FrArTp\_00023]** A SF-I looks as follows (address information header is not depicted):

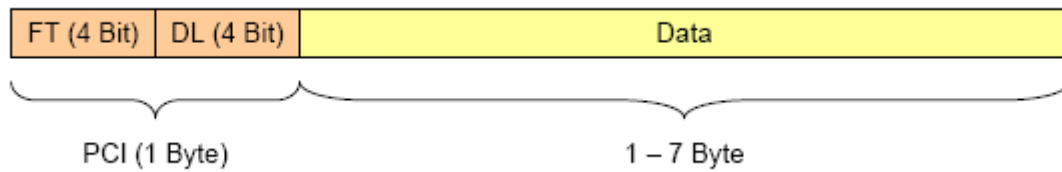

**Figure 15: Single Frame ISO 15765-2**

In a SF-I the PCI consists of only one byte. This byte is divided in two parts, called FT (Frame Type) and DL (Data Length). Both parts are 4 Bit long.

The FT field is common to every frame type because it identifies the respective type.

**[SWS\_FrArTp\_00024]** For ISO 15765-2 Single Frames the FT field shall be set to 0x0.

**[SWS\_FrArTp\_00025]** The DL field states the amount of the actual data bytes, according to ISO 15765-2 the values 0x1 – 0x7 (0x6 in FRARTP\_ISO6 mode) are valid, so in an ISO 15765-2 compliant connection the size of the associated N-PDU has to be, depending on the addressing mode, 10 (9) or 12 (11) Bytes long, since the SF has this length.

Including address information, the length of an SF-I reaches from 4 Byte (1 Byte payload, 1 Byte addressing) to 12 Bytes. The actual frame length can be derived considering the addressing mode and looking in the length statement of the corresponding PduInfoType struct in the configuration.

## Error Handling

### **[SWS\_FrArTp\_00028] DL field**

Incoming SF-I frames with an invalid DL value of 0x0 or higher than 0x7 (0x6 in FRARTP\_ISO6 mode) shall be ignored. This shall also be done if a value arrives which is higher than the amount of payload that can be derived from the length statement of the corresponding PduInfoType struct in the configuration and the addressing mode.

If acknowledgement is configured, additionally an AF with a negative acknowledgement shall be sent back to the sender in the cases above.

### 7.3.2.2 Extended Single Frame (SF-E)

This section is **Not compliant to ISO 15765-2**.

**[SWS\_FrArTp\_00029]** An SF-E allows using the whole possible FlexRay payload of 254 Bytes for an unsegmented transfer. It looks as depicted in Figure 16:



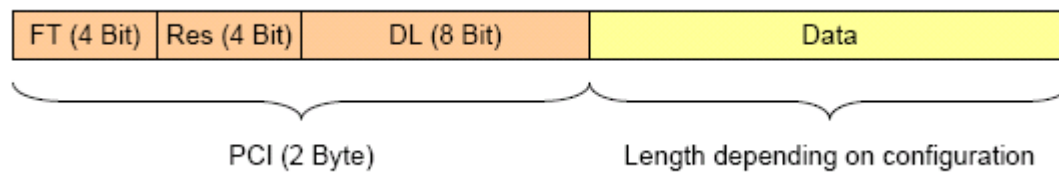

**Figure 16: Single Frame Extended<sub>J</sub>()**

**[SWS\_FrArTp\_00030]** The PCI of an SF-E consists of two bytes. The FT field is 4 Bit long; for an SF-E, it shall be set to 0x4. The following nibble is reserved; it shall be set to 0x0.<sub>J</sub>()

**[SWS\_FrArTp\_00031]** The next byte is the DL field and states the amount of payload contained in the SF-E. Depending on the configuration of the addressing mode (1 Byte or 2 Byte) and the length of the associated N-PDU, all values except 0x00 and above 0xFA (1 Byte addressing) or above 0xF8 (2 Byte addressing) are valid here.<sub>J</sub>()

The minimum length of such a frame is 5 Byte (1 Byte addressing, 1 Byte payload), the maximum is 254 Byte (FlexRay limit according to [15]). The actual frame length can be derived considering the addressing mode and looking in the length statement of the corresponding PduInfoType struct.

## Error Handling

### **[SWS\_FrArTp\_00286] DL field**

If this field contains the value 0x00 or, depending on the addressing mode, a value higher than 0xFA or higher than 0xF8, the SF-E shall be ignored. If acknowledgement is configured, additionally an AF with a negative acknowledgement shall be sent back to the sender.<sub>J</sub>()

### **[SWS\_FrArTp\_00287] General**

If messages longer than allowed by ISO 15765-2 are not configured (FrArTpLm) for the corresponding channel, this frame shall be ignored. This shall also be done if a value arrives which is higher than the amount of payload that can be derived from the length statement of the corresponding PduInfoType struct and the addressing mode or if a value different from 0x0 arrives in the reserved nibble. If acknowledgement is configured, additionally an AF with a negative acknowledgement shall be sent back to the sender in the cases above.<sub>J</sub>()

### 7.3.3 First Frames (FF-x)

If a message does not fit into a SF, it has to be segmented.

**[SWS\_FrArTp\_00034]** 「The FrArTp takes the decision whether a message has to be segmented based on the message length, the possibility (depending on per channel configuration) to use SF-E frames and the size of the assigned N-PDU (see also section 7.4.1). Therefore, to start the transfer of such a long message, a First Frame is used.」()

**[SWS\_FrArTp\_00035]** 「To enable compliance with ISO 15765-2 on the one hand and to allow messages longer than  $2^{12}-1$  Byte on the other hand, there are several types of First Frames.」()

#### **[SWS\_FrArTp\_00036]** Not compliant to ISO 15765-2

「It can be statically per channel configured, whether a First Frame can also start a segmented message in a 1:n connection. 」()

#### 7.3.3.1 First Frame ISO 15765-2 (FF-I)

**[SWS\_FrArTp\_00237]** 「The figure below shows the layout of a FF-I:

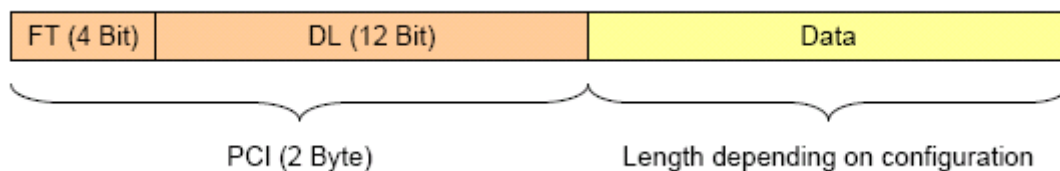

**Figure 17: First Frame ISO 15765-2」()**

In an FF-I the PCI consists of 2 Bytes. As in an SF, the FT field is 4 Bit long, the DL field 12 Bit.

**[SWS\_FrArTp\_00037]** 「For a FF-I, the FT field shall be set to 0x1.」()

**[SWS\_FrArTp\_00299]** 「The DL field contains the length of the whole message. Due to the 12 bit length of this field, messages up to  $2^{12}-1$  Bytes can be transferred. 」()

The overall length of a First Frame including address information lasts (depending on the per channel configuration) from 4 Byte to a connection specific maximum.

This maximum on its part depends on the use case (e.g. for communication with CAN for which full ISO 15765-2 compliance is necessary, it will be 10 or 12 (9 or 11 in FRARTP\_ISO6 mode)) as well as on the size of the associated N-PDU. The actual amount of payload of an FF-I can be derived by considering the addressing type (1 or

2 Byte) and e.g. looking in the length designation of the corresponding PduInfoType struct.

## Error Handling

### [SWS\_FrArTp\_00039] DL field

「Incoming FF-I frames with DL = 0x000 shall be ignored. Moreover, if the DL value is lower than the possible (from the PDU size, the addressing type and the channel specific Long Messages switch derivable) payload of a SF, the frame shall also be ignored.

If acknowledgment is configured, in all the cases above additionally an AF with a negative acknowledgement shall be sent back to the sender.」()

### 7.3.3.2 First Frame Extended (FF-E)

This section is **Not compliant to ISO 15765-2**.

[SWS\_FrArTp\_00238] 「The layout of FF-E is shown below:

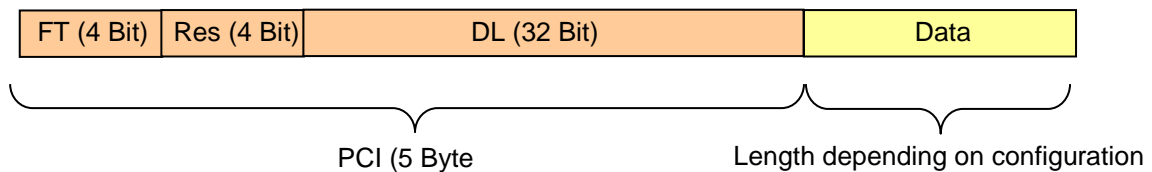

**Figure 18: First Frame Extended**」()

In an FF-E, the PCI consists of 5 Bytes. The FT field is 4 Bit long, 4 Bits are reserved, the DL field 32 Bit.

[SWS\_FrArTp\_00054] 「The DL field is 4 Byte long, so it allows transporting up to  $2^{32}-1$  bytes.」()

[SWS\_FrArTp\_00055] 「The FT field is set to 0x5.」()

[SWS\_FrArTp\_00056] 「The Res field (reserved) is set to 0x0.」()

The overall length of an FF-E reaches from 7 Byte to a connection specific maximum, which depends on the size of the associated N-PDU.

## Error Handling

### [SWS\_FrArTp\_00057] DL field

「If the FR\_DL value is lower than the possible (from the PDU size and the addressing type derivable) payload of an SF, the frame shall be ignored. If acknowledgement is configured for the corresponding channel, an AF with a negative acknowledgement shall be sent back to the sender.」()

### 7.3.4 Consecutive Frames

[SWS\_FrArTp\_00058] 「If no error occurred, an FF-x is followed by Consecutive Frames until the whole message is transmitted.」()

### [SWS\_FrArTp\_00059] Not compliant to ISO 15765-2

「If configured for the specific channel, a Consecutive Frame can also appear in a 1:n connection.」()

[SWS\_FrArTp\_00239] 「As shown below, Consecutive Frames consist of one byte PCI and the payload.」()

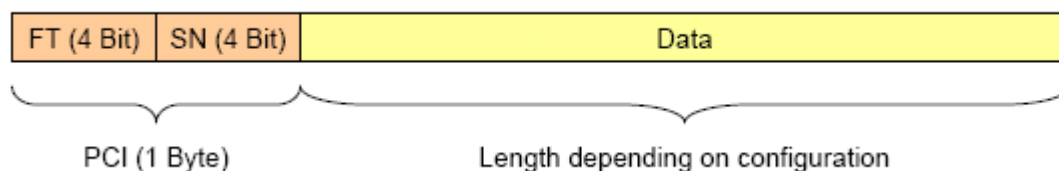

Figure 19: Consecutive Frame」()

The PCI of a Consecutive Frame consists of one byte, which is divided in two 4-bit parts.

[SWS\_FrArTp\_00060] 「The FT field again states the frame type, for a CF it shall be set to 0x2, for a CF2 it shall be 0x6 (CF2 frames are Not compliant to ISO 15765-2).」()

[SWS\_FrArTp\_00061] 「The SN (Sequence Number) field gives the current sequence number of the Consecutive Frame. **Please note that the SN of the CF that immediately follows the FF-x is set to 1 and then incremented with each frame until it wraps around to 0 and so on.**」()

The overall length of a Consecutive Frame including address information ranges (depending on the per connection configuration) from 4 Byte to a connection specific

maximum. This maximum depends on the use case (e.g. for communication with CAN for which full ISO 15765-2 compliance is necessary it will be 10 or 12 (9 or 11 in FRARTP\_ISO6 mode) as well as on the size of the associated PDU.

The receiving peer can derive the actual data length by looking in the associated PduInfoType struct und considering the addressing mode.

## Error Handling

### [SWS\_FrArTp\_00063] SN field

⌈If no acknowledgement is configured, then in case of a wrong SN, i.e. after SN x does not follow SN x+1, the transfer shall be aborted and within *PduR\_FrArTpRxIndication* the result E\_NOT\_OK shall be returned.If acknowledgment is configured, after the block end, a negative acknowledgement shall take place and then the transfer shall be aborted as described above.If Retry is configured too, then the transfer shall not be aborted but the Retry shall take place (up to FrArTpMaxRn times).⌋()

## 7.3.5 Flow Control (FC)

[SWS\_FrArTp\_00064] ⌈A Flow Control frame is used in segmented 1:1 connections (see section 7.2.1.1). Thus, it cannot appear in a 1:n connection. It allows the receiver to send information to the sender. It is sent after reception of an FF-x and after the last CF of a block if no error occurred. ⌋()

[SWS\_FrArTp\_00240] ⌈The layout of FC is shown below:

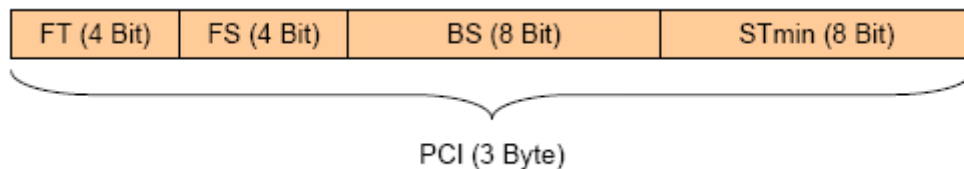

Figure 20: Flow Control frame ⌋()

[SWS\_FrArTp\_00065]⌈A Flow Control frame only consists of Protocol Control Information.⌋()

[SWS\_FrArTp\_00066]⌈As usual, the FT field states the frame type, thus for Flow control frames, it shall be set to 0x3.⌋()

**[SWS\_FrArTp\_00067]** The FS field may contain the following three flow status values (see also section 7.2.1.1):

- CTS (value 0x0): Clear To Send  
The sender can continue transmitting the message.
- WT (value 0x1): Wait  
The sender shall wait for another FC frame (and therefore restart its timer FrArTpTimeoutBs). If the number of consecutive Flow Control frames with FS = WT reaches a per channel defined maximum, the transfer shall be aborted.
- OVFLW (value 0x2): Overflow  
The transfer shall be aborted, because the receiver has not enough buffer for the whole message available (according to the value of the DL field of the FF-x).()

**[SWS\_FrArTp\_00068]** BS states the block size (the number of CFs between the Flow Control frames). If no acknowledgement is configured, all values from 0x00 to 0xFF are valid whereas 0x00 indicates that no more flow control shall take place and the rest of the pending message will be transmitted within one big block. Otherwise, only the values 0x01 – 0x10 are valid.()

**[SWS\_FrArTp\_00069]** The last byte contains STmin, which defines the minimum gap between two CFs. The valid values range from 0x00 to 0x7F and from 0xF1 to 0xF9. The range from 0x00 to 0x7F specifies the minimum gap in milliseconds (0ms .. 127ms), the one from 0xF1 to 0xF9 defines the gap in microseconds (100 µs, 200 µs, .. 900µs). The supported values of STmin are restricted by the placement of N-PDUs in FlexRay cycles, and are subject to the jitter created by the placement of N-PDUs in the slots of a cycle.()

Depending on addressing configuration, a Flow Control frame is 5 or 7 byte long.

## Error Handling

### **[SWS\_FrArTp\_00285] FS field**

⌈ If acknowledgment with Retry is configured, instead of abortion of the transfer, the frame shall be ignored. ⌋()

### **[SWS\_FrArTp\_00244] BS field**

⌈ All values are valid if no acknowledgement is configured. Otherwise, only the values from 0x1 to 0x10 are valid. If no Retry is configured in the latter case, the transfer

shall be aborted and *PduR\_FrArTpTxConfirmation* shall be called with E\_NOT\_OK, otherwise the frame shall be ignored. ]()

**[SWS\_FrArTp\_00245] STmin field**

⌈The invalid values of this parameter range from 0x80 to 0xF0 and from 0xFA to 0xFF. If such a value is received, the value 0x7F shall be taken instead. ]()

**7.3.6 Acknowledgement Frame (AF)**

This section is **Not compliant to ISO 15765-2**.

**[SWS\_FrArTp\_00072]** ⌈If acknowledgement is configured, every block of CFs is in the case of a positive acknowledgement acknowledged by an FC frame (as it is in unacknowledged connections). Additionally an SF-x, the last block of CFs is acknowledged by an AF in 1:1 connections, and, in the case of a negative acknowledgement, also other blocks. This frame type cannot appear in a 1:n connection.

This type of frame looks similar to an FC frame (section 7.3.5) but it has an additional byte. ]()

**[SWS\_FrArTp\_00241]** ⌈The layout of FC is shown below:

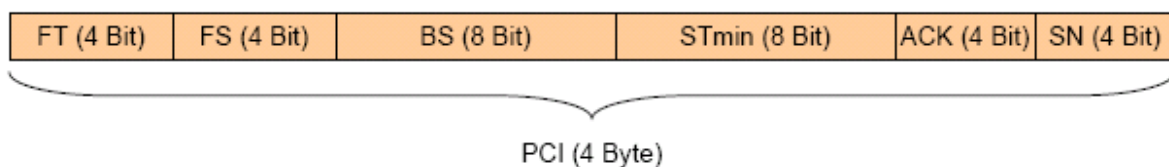

**Figure 21: Acknowledgement Frame ]()**

**[SWS\_FrArTp\_00073]** ⌈This frame is identified by the value 0x7 of the FT field. ]()

**[SWS\_FrArTp\_00074]** ⌈FS field is the same as in an FC frame. ]()

**[SWS\_FrArTp\_00075]** ⌈BS field can only be set to the values 0x01 to 0x10 due to the 4 Bit Sequence Number counter in a CF (section 7.3.4). ]()

**[SWS\_FrArTp\_00076]** ⌈STmin is the same as in FC frames. ]()

**[SWS\_FrArTp\_00077]** ACK field gives the type of the acknowledgement, Positive (0x0) or Negative (0x1). All other values are reserved. ]()

**[SWS\_FrArTp\_00078]** 「SN field contains the number of the first faulty CF within the last block. All values are valid.」()

Depending on addressing type, this frame is 6 or 8 Byte long.

### **Error Handling**

The following only holds if an AF arrives when it is expected. Otherwise, see section 7.3.7.

### **[SWS\_FrArTp\_00284] FS field**

「In a segmented transfer, all values higher than 0x2 shall lead to the abortion of the transfer and *PduR\_FrArTpTxConfirmation* shall be called with the result E\_NOT\_OK. If additionally Retry is configured, such values shall not lead to the abortion of the transfer. Instead, the frame shall be ignored.」()

### **[SWS\_FrArTp\_00251] FS field with Acknowledgement**

「In case an AF with negative acknowledgement and FS = OVFLW arrives in an unsegmented acknowledged transfer or at the end of an segmented acknowledged transfer at the sender, regardless of Retry being configured or not, the transfer shall be aborted and *PduR\_FrArTpTxConfirmation* shall be called with the result E\_NOT\_OK.」()

### **[SWS\_FrArTp\_00246] BS field**

「The value 0x00 and all values higher than 0x10 shall cause the abortion of the transfer and *PduR\_FrArTpTxConfirmation* shall be called with the result E\_NOT\_OK. If additionally Retry is configured, such values shall not lead to the abortion of the transfer. Instead, the frame shall be ignored.」()

### **[SWS\_FrArTp\_00247] STmin field**

「The invalid values of this parameter range from 0x80 to 0xF0 and from 0xFA to 0xFF. If such a value is received, the value 0x7F shall be taken instead.」()

### **[SWS\_FrArTp\_00248] ACK field**

「Values higher than 0x1 are invalid and shall cause the abortion of the transfer and *PduR\_FrArTpTxConfirmation* shall be called with the result E\_NOT\_OK. If additionally Retry is configured, such values shall not lead to the abortion of the transfer. Instead, the frame shall be ignored.」()

### **[SWS\_FrArTp\_00249] SN field**

「If a frame arrives that contains an SN of a CF that has not been transmitted within the block, e.g. block size is 10 and this field has value 12, the transfer shall be aborted and *PduR\_FrArTpTxConfirmation* shall be called with the result E\_NOT\_OK.



If additionally Retry is configured, the transfer shall not be aborted. Instead, the frame shall be ignored.」()

**[SWS\_FrArTp\_00250] General**

「If for the channel no acknowledgement is configured, this frame type shall be ignored.

In an unsegmented acknowledged transfer, the expected value for the fields BS, STmin, and SN is 0x0. Other values shall be tolerated.」()

For a better understanding, the following table depicts the possible combinations (and their meaning) of the FS and ACK field in an Acknowledgment Frame:

Possible combinations of FS and ACK field in Acknowledgement Frames	ACK = 0x0	Meaning / Appearance	Leads to Retry (if configured)	ACK = 0x1	Meaning / Appearance	Leads to Retry (if configured)
FS = CTS	X	Positive Acknowledge after SF or after end of Segmented Transfer	NO	X	Negative Acknowledge after SF or after block end in Segmented Transfer	YES
FS = WT	--	--	NO	X	Negative Acknowledge after SF (if currently no Receive buffer is available)	NO
FS = OVFLW	--	--	NO	X	Negative Acknowledge after SF (if no Receive buffer is available)	NO

**Table 2: Possible combinations of FS and ACK field**

**7.3.7 Error Handling of the FT Field**

Not every frame type is accepted at any point in time and in any configuration of a channel/connection. Thus, a detailed description is given below.

**[SWS\_FrArTp\_00082]** 「A value of the FR\_FT field higher than 0x7 shall always be ignored.」()

**[SWS\_FrArTp\_00083]** 「If the corresponding channel and connection is set to be ISO 15765-2 compliant, then the following table holds.」()

<i>TP Layer Status</i>	<i>SF-I</i>	<i>FF-I (1:1)</i>	<i>CF (1:1)</i>	<i>FC</i>	<i>Other</i>
<b>Segmented Transmit within this connection in progress</b>	If reception is in progress within the connection, see corresponding cell below. Otherwise, process the SF-I as start of a new reception.	If reception is in progress within the connection, see corresponding cell below. Otherwise, process the FF-I as start of a new reception.	If reception is in progress within the connection, see corresponding cell below. Otherwise, ignore it.	If awaited then process, otherwise ignore it.	Ignore
<b>Segmented Receive within this connection in progress</b>	Terminate the current reception, report a <i>PduR_FrArTpRxI ndication</i> with the result E_NOT_OK and process the SF-I as the start of a new reception.	Terminate the current reception, report a <i>PduR_FrArTpRxI ndication</i> with the result E_NOT_OK and process the FF-I as the start of a new reception.	If awaited then process, otherwise ignore	If transmission is in progress within the connection, see corresponding cell above. Otherwise ignore it	Ignore
<b>Idle</b>	Process the SF-I as the start of a new reception	Process the FF-I as the start of a new reception	Ignore	Ignore	Ignore

**Table 3: FT Error Handling in ISO 15765-2 compliant channels/connections**

Otherwise, the behavior is explained below:

**[SWS\_FrArTp\_00283] SF-x, FF-x, CF/CF2 and FC frames**

「The behavior shall be as depicted in Table 3 (also for 1:n connections).

The ignoring of an FF-E shall be according to the value of FrArTpLm.

Regarding CF and CF2 frames there is a special error handling in case Retry is configured (otherwise CF2 frames are ignored):

If the sender starts a block with another frame than expected, i.e. CF instead of CF2 or CF2 instead of CF, then the sender is doing a Retry that has not been requested by the receiver (maybe because of losing the FC-CTS frame on the bus). Therefore, the receiver always has to remember the old block size and send another FC-CTS at the end of this retransmitted block. Errors in the unnecessarily retransmitted block shall be ignored.」()

**[SWS\_FrArTp\_00252] AF frame**

「If no acknowledgement is activated, this frame shall be ignored. Otherwise, on the receiver side or in idle state, these frames shall be ignored, too.」()

On the sender side, the behavior in case of an incoming AF shall be the following:

- **[SWS\_FrArTp\_00269]** 「If an AF arrives when it is expected, the action is as described in section 7.2.1.3 and in section error handling of section 7.3.6.」()
- **[SWS\_FrArTp\_00270]** 「If a non-faulty AF with positive acknowledgement arrives during a block, it shall be ignored.」()
- **[SWS\_FrArTp\_00271]** 「If a non-faulty AF with negative acknowledgement arrives during a block, it shall be processed depending on the activation of the Retry mechanism. If no Retry is configured the transfer shall be aborted. Otherwise, the AF shall be processed, i.e. starting with the stated sequence number the Retry shall take place.」()
- **[SWS\_FrArTp\_00272]** 「If a faulty AF arrives during a block, it shall be ignored.」()

### 7.3.8 Addressing Errors

#### SF-x frame

No restrictions.

#### **[SWS\_FrArTp\_00086] FF-x and CF frames**

「If not explicitly configured by the parameter FrArTpGrpSeg for the particular channel, a FF-x or CF in a 1:n connection shall be ignored.」()

#### **[SWS\_FrArTp\_00087] FC and AF frames**

「These frame types are not allowed to appear in 1:n connections; thus, they shall be ignored in that case.」()

## 7.4 Further Principles of Working

### 7.4.1 Decision of Segmentation

As mentioned earlier in this specification, there are several factors influencing the decision of the FlexRay AUTOSAR Transport Layer module to segment a message (N-SDU) or not.

The values of the following parameters play a role hereby:

N-PDU length, FrArTpLm, FrArTpAdrType, FrArTpMultRec, FrArTpGrpSeg, and the length of the to-be-transmitted message (N-SDU).

**[SWS\_FrArTp\_00091]** 「The amount of bytes of an N-PDU that is usable for payload, i.e. for the N-SDU, depends on the length of the PCI of the used frames, i.e. if two or

four bytes (FrArTpAdrType) are needed to state to address information. The frames that are allowed to be utilized, and the payload they can carry depend on the value of FrArTpLm (e.g. SF-E is allowed or not, SF-I can carry 7 or 6 bytes etc.). In case the connection is a 1:n connection (FrArTpMultRec), the parameter FrArTpGrpSeg states whether segmentation is allowed or not.

With all this information and the length of the to-be-transmitted N-SDU, the FrArTp can decide whether it has to segment the N-SDU or not.」()

#### 7.4.2 Scheduling of PDUs during Transmission

PDUs of a PDU pool must be assigned to all active connections in a way that no connection freezes, while connections with prioritized PDUs are served first.

**[SWS\_FrArTp\_00256]** 「To achieve an even distribution of PDUs to all currently transmitting and/or receiving connections associated with a PDU pool, the PDUs of this pool shall be assigned to active connections using round robin scheduling. A connection that is currently receiving and transmitting may claim two PDUs in one round of the assignment: one for the FC, and one for an SF/FF/CF.」()

**[SWS\_FrArTp\_00257]** 「The scheduling shall be executed in the context of the main function, and shall start with the connection where the scheduling stopped in the previous cycle.」()

**[SWS\_FrArTp\_00258]** 「Each PDU assignment cycle shall start with the prioritized PDUs. In this phase, PDUs are only assigned to active connections with prioritized PDUs, until their needs are satisfied. Afterwards, PDU assignment continues for all active connections.」()

**[SWS\_FrArTp\_00259]** 「It must be ensured that the last PDU of a PDU pool within a FlexRay cycle is always used by the scheduling.」()

**[SWS\_FrArTp\_00260]** 「If not all PDUs of the pool are used, the positions of the unused PDUs are not relevant; gaps are allowed in any place.」()

#### 7.4.3 Detection of Receiving Connection

When an SF-x or FF-x frame is received, the N-PDU-ID is used to identify the relevant pool. Because a PDU pool may only be used by channels with identical addressing type, the address information can be extracted from the N-PDU, by which the receiving connection can be identified, because no two connections using the same PDU pool have identical addresses.

**[SWS\_FrArTp\_00261]** 「If the receiving connection is not active, and all state machines of the associated channel are in use, the incoming message shall be ignored.」()

#### 7.4.4 Single Frame Handling during Reception

**[SWS\_FrArTp\_00262]** 「No state machine shall be used for the reception of an SF-x. When the corresponding connection is free, the single frame shall be forwarded immediately by calling *PduR\_FrArTpStartOfReception* and, upon successful return of this function, *PduR\_FrArTpCopyRxData* and *PduR\_FrArTpRxIndication*.」()

The behavior in case of unsuccessful reception is described in **[SWS\_FrArTp\_00298]** and **[SWS\_FrArTp\_00289]**.

#### 7.4.5 Addressing with Meta Data

**[SWS\_FrArTp\_00401]** 「During transmission, the FrArTp shall use addressing information provided by the upper layer via the meta data items SOURCE\_ADDRESS\_16 and TARGET\_ADDRESS\_16 as local address and remote address of the transmitted N-PDUs and to identify received flow control N-PDUs.」()

**[SWS\_FrArTp\_00402]** 「During reception, the FrArTp shall forward addressing information received as remote address and local address in the N-PDU to the upper layer via the meta data items SOURCE\_ADDRESS\_16 and TARGET\_ADDRESS\_16, and shall use the same address information when transmitting flow control N-PDUs.」()

**[SWS\_FrArTp\_00403]** 「If FrArTpLa and/or FrArTpRa are configured for a transmitted N-SDU, they are used even when the addressing information is provided by the upper layer. If not, the address information in the N-PDU shall be set according to the provided address information.」()

**[SWS\_FrArTp\_00404]** 「If FrArTpLa and/or FrArTpRa are not configured for a received N-SDU, any received addressing information can be assigned to this N-SDU. N-SDUs with configured FrArTpLa and/or FrArTpRa shall be preferred during reception over those without these configuration parameters.」()

#### 7.4.6 Sending and Receiving within the same connection

**[SWS\_FrArTp\_00094]** 「The FrArTp shall be implemented to support both sending and receiving within one connection. So the same connection can be utilized for sending and receiving.」()

To explain it more in detail, imagine a connection being in idle state. If now the call *FrArTp\_Transmit()* occurs, the local peer becomes the sender in this connection (Source Address of TP frame = FrArTpLa, Target Address of TP frame = FrArTpRa). Otherwise, if an *FrArTp\_RxIndication()* occurred for an N-PDU which is mapped on the N-SDU of this connection, it would become the receiver (Source Address of TP frame = FrArTpRa, Target Address of TP frame = FrArTpLa).

This feature is intended for connections in which sometimes one peer has to send data and sometimes the other in order not to need two connections in this case.

#### 7.4.7 Behavior on Timeouts and Errors

**[SWS\_FrArTp\_00095]** 「The behavior in case a timeout occurs depends on the value of FrArTpAckType, i.e. what kind of acknowledgement is configured for the corresponding channel.」()

**[SWS\_FrArTp\_00302]** 「The FrArTp shall abort the connection when Frlf\_Transmit returns E\_NOT\_OK」()

##### 7.4.7.1 Handling of negative TxConfirmations

**[SWS\_FrArTp\_00410]** 「 If the API *FrArTp\_TxConfirmation* called with result E\_NOT\_OK for an ongoing reception process, the reception of the SDU shall be terminated immediately and within *PduR\_FrArTpRxIndication* the result E\_NOT\_OK shall be returned.」()

**[SWS\_FrArTp\_00411]** 「 If the API *FrArTp\_TxConfirmation* called with result E\_NOT\_OK for an ongoing transmission process, the transmission of the SDU shall be terminated immediately and within *PduR\_FrArTpTxConfirmation* the result E\_NOT\_OK shall be returned.」()

##### 7.4.7.2 No Acknowledgement configured for the Channel

In this case, the behavior shall be as described in [13], i.e.:

- **[SWS\_FrArTp\_00282]** 「If the AS timer (FrArTpTimeoutAs) expires, depending on the value of FrArTpMaxAs, sending shall be retried (because of

still remaining attempts) or the transmission shall be aborted, and within *PduR\_FrArTpTxConfirmation* the result `E_NOT_OK` shall be returned. ]()

- **[SWS\_FrArTp\_00263]** [ If the AR timer (`FrArTpTimeoutAr`) expires, depending on the value of `FrArTpMaxAr`, sending shall be retried (because of still remaining attempts) or the transmission shall be aborted, and within *PduR\_FrArTpRxIndication* the result `E_NOT_OK` shall be returned. ]()
- **[SWS\_FrArTp\_00264]** [ If the BS timer (`FrArTpTimeoutBs`) expires, the transmission shall be aborted, and within *PduR\_FrArTpTxConfirmation* the result `E_NOT_OK` shall be returned. ]()
- **[SWS\_FrArTp\_00265]** [ If the CR timer (`FrArTpTimeoutCr`) expires, the transmission shall be aborted, and within *PduR\_FrArTpRxIndication*, the result `E_NOT_OK` shall be returned. If previously in the current block a sequence error occurred, this error shall be reported at the block end in *PduR\_FrArTpRxIndication*. ]()

#### 7.4.7.3 Acknowledgement without Retry configured for the Channel

This section is **Not compliant to ISO 15765-2**.

In this case, the behavior is the following:

- **[SWS\_FrArTp\_00281]** [ In case of a timeout of timer AS, AR or BS, the behavior shall be as mentioned in section 7.4.7.2. ]()
- **[SWS\_FrArTp\_00266]** [ If the CR timer (`FrArTpTimeoutCr`) expires, an AF with negative acknowledgement shall be sent, the transmission shall be aborted, and within *PduR\_FrArTpRxIndication*, the result `E_NOT_OK` shall be returned. If previously in the current block a sequence error occurred, this error shall be reported at the block end in *PduR\_FrArTpRxIndication*. ]()

#### 7.4.7.4 Acknowledgement with Retry configured for the Channel

This section is **Not compliant to ISO 15765-2**.

In this case, the behavior shall be the following:



- **[SWS\_FrArTp\_00280]** 「In case of a timeout of timer AS or AR, the behavior shall be as mentioned in section 7.4.7.2.」()
- **[SWS\_FrArTp\_00267]** 「If the BS timer (FrArTpTimeoutBs) expires, the sender shall retransmit the whole block up to FrArTpMaxRn times. After that, the transmission shall be aborted, and within *PduR\_FrArTpTxConfirmation* the result E\_NOT\_OK shall be returned.」()
- **[SWS\_FrArTp\_00268]** 「If the CR timer (FrArTpTimeoutCr) expires, the receiver shall send an AF with negative acknowledgement and the sequence number of the missed CF. This shall be done up to FrArTpMaxRn times. After that, the transmission shall be aborted, and within *PduR\_FrArTpRxIndication*, the result E\_NOT\_OK shall be returned. If previously in the current block a sequence error occurred, this error shall be reported at the block end in *PduR\_FrArTpRxIndication*.」()

#### 7.4.8 Transmit Cancellation

**[SWS\_FrArTp\_00099]** 「This feature can be (de)activated by static configuration (parameter FrArTpTc). Transmit Cancellation is triggered by the call of *FrArTp\_CancelTransmit*.」(SRS\_Fr\_05093)

**[SWS\_FrArTp\_00236]** 「When a transmission is still in progress, *FrArTp\_CancelTransmit* shall return E\_OK, and the transmission shall be stopped. When a connection is not active, or when the last N-PDU of a transmission without acknowledgement has already been forwarded to the Frlf, *FrArTp\_CancelTransmit* shall return E\_NOT\_OK.」()

The service works at the sender side of a connection as follows:

- **[SWS\_FrArTp\_00279]** 「If no transmit request is pending for the corresponding connection, there is nothing to do.」()
- **[SWS\_FrArTp\_00273]** 「If a request is pending but the transmission has not been started, the FrArTp shall immediately call *PduR\_FrArTpTxConfirmation* and free the connection.」()
- **[SWS\_FrArTp\_00274]** 「If the transmission already has been started, the FrArTp shall immediately call *PduR\_FrArTpTxConfirmation*, and remember that the N-PDUs that have already been allocated for this connection cannot be used again before they have been confirmed. When requested via *TriggerTransmit*, the pending N-PDUs shall either be transferred to the Frlf as if they had not been canceled, or E\_NOT\_OK shall be returned.」()



**[SWS\_FrArTp\_00103]** 「If a transfer was cancelled by the call of *FrArTp\_CancelTransmit*, *PduR\_FrArTpTxConfirmation* shall be called with *E\_NOT\_OK*.」()

#### 7.4.9 Receive Cancellation

**[SWS\_FrArTp\_00224]** 「If development error detection is enabled the function *FrArTp\_CancelReceive* shall check the validity of *FrArTpRxSduId* parameter.」()

**[SWS\_FrArTp\_00226]** 「The *FrArTp* shall abort the reception of the current N-SDU if the service *FrArTp\_CancelReceive* provides a valid *FrArTpRxSduId*.」()

**[SWS\_FrArTp\_00227]** 「The *FrArTp* shall reject the request for receive cancellation by returning *E\_NOT\_OK* when

- a) the cancelled connection is not active, or when
- b) the *FrArTp* has already received the last frame of an unacknowledged connection, or when
- c) the *FrArTp* has already provided the final AF of an acknowledged connection.」()

**[SWS\_FrArTp\_00228]** 「If the *FrArTp\_CancelReceive* service has been successfully executed, the *FrArTp* shall call the *PduR\_FrArTpRxIndication* with *E\_NOT\_OK*.」()

#### 7.4.10 Parameter Changing

**[SWS\_FrArTp\_00104]** 「The *FrArTp* also supports the optional service for changing the parameters *FrArTpMaxBs* and *FrArTpStMin / FrArTpStMinGrpSeg* mentioned in [13] via the API call *FrArTp\_ChangeParameter*. A change is not possible during an ongoing reception and shall lead to the return value *E\_NOT\_OK*.」(*SRS\_Fr\_05090*)

#### 7.4.11 Data Handling, Block Size and WAIT-Frames

The FlexRay AUTOSAR Transport Layer does not provide message buffers, neither for sending nor for receiving. Instead, it provides received data and requests transmitted data chunk wise from/to the upper layer.

**[SWS\_FrArTp\_00221]** 「When a new reception is initiated by the reception of a FF or SF, the TP checks for the availability of the associated channel and then calls

*PduR\_FrArTpStartOfReception* to inform the upper layer of the expected message size, and to retrieve information about the currently available buffer. With this call, the FrArTp provides the total size of the received data (SDU), and the data and size of the FF or SF to the upper layer. When this call succeeds, the connection is set to established, and *PduR\_FrArTpCopyRxData* is called to provide the payload of the frame to the upper layer. ]()

**[SWS\_FrArTp\_00230]** 「When a new transmission is initiated by the call of *FrArTp\_Transmit*, the TP checks for the availability of the associated channel, and sets the connection to established. Then the TP calls *PduR\_FrArTpCopyTxData* to acquire the data for the SF or FF and following CFs. ]()

**[SWS\_FrArTp\_00105]** 「Depending on the message length and configuration of the FrArTp, a segmented or an unsegmented transfer will take place. ]()

**[SWS\_FrArTp\_00232]** 「The API function *PduR\_FrArTpCopyTxData* has a parameter named *retry*, which is a pointer to a structure of type *RetryInfoType*. When Retry is disabled, *retry* shall always be set to *NULL*. Otherwise, the different values of *retry.TpDataState* shall be used to handle retries. ]()

#### 7.4.11.1 Unsegmented Transfer

**[SWS\_FrArTp\_00106]** 「At the sender side, this principle works as follows:

1. The PDU Router calls the service *FrArTp\_Transmit*.
2. The FrArTp shall call *PduR\_FrArTpCopyTxData* in order to get all the data bytes of the SF-x. *retry.TpDataState* shall be set to *TP\_CONFENDING* when Retry is enabled. ]()

**[SWS\_FrArTp\_00107]** 「If *PduR\_FrArTpCopyTxData* for the SF-x returns *BUFREQ\_E\_BUSY*, the call shall be repeated until *FrArTpTimeCs* expires. When the return value is *BUFREQ\_E\_NOT\_OK* or after *FrArTpTimeCs* expired, the transfer shall be aborted by calling *PduR\_FrArTpTxConfirmation* with *E\_NOT\_OK*. ]()

**[SWS\_FrArTp\_00233]** 「If Retry is enabled, the SF-x shall be sent again after reception of a negative AF. The FrArTp shall finish the transfer after reception of a positive AF by the call to *PduR\_FrArTpTxConfirmation* with *E\_OK*. ]()

**[SWS\_FrArTp\_00108]** 「At the receiver side, the principle works as follows:

1. FrIf calls the service *FrArTp\_RxIndication*.
2. The FrArTp shall call *PduR\_FrArTpStartOfReception* to prepare reception.

3. The FrArTp shall call *PduR\_FrArTpCopyRxData* to forward SF data. ]()

**[SWS\_FrArTp\_00298]** [If *PduR\_FrArTpStartOfReception* for the SF-x returns `BUFREQ_E_NOT_OK` or `BUFREQ_E_OVFL`, the transfer shall be aborted immediately without calling *PduR\_FrArTpRxIndication*. ]()

**[SWS\_FrArTp\_00289]** [If the available buffer reported by *PduR\_FrArTpStartOfReception* is too small for the SF-x, or if *PduR\_FrArTpCopyRxData* for the SF-x returns `BUFREQ_E_NOT_OK`, the FrArTp shall abort the transfer and call *PduR\_FrArTpRxIndication* with `E_NOT_OK`. ]()

**[SWS\_FrArTp\_00253]** [If acknowledgement is configured: In case of failing to copy the received data (either `BUFREQ_E_NOT_OK` or `BUFREQ_E_OVFL` was returned, or the available buffer is too small), an AF with a negative acknowledgement and FS = OVFLW is sent back to the sender. ]()

#### 7.4.11.2 Segmented Transfer

**[SWS\_FrArTp\_00110]** [At the sender side, this principle works as follows:

1. The PDU Router calls the service *FrArTp\_Transmit*.
2. The FrArTp shall call *PduR\_FrArTpCopyTxData* in order to get the data bytes of the FF and following CFs. ]()

**[SWS\_FrArTp\_00111]** [When Retry is enabled, the TP sends the FF-x without data. After reception of an FC, the data for the first CF is acquired with `retry.TpDataState` set to `TP_DATACONF`. For the following CFs, `retry.TpDataState` shall be set to `TP_CONFENDING`. ]()

**[SWS\_FrArTp\_00234]** [When Retry is enabled, after reception of a negative AF, the last block must be retransmitted. To achieve this, the data for the first CF of the block is acquired with `retry.TpDataState` set to `TP_DATARETRY` while `retry.TxTpDataCnt` contains the size of the previously sent block in bytes. The buffer of the last block in the upper layer is only freed after reception of a positive AF by the call to *PduR\_FrArTpTxConfirmation* with `E_OK`. ]()

**[SWS\_FrArTp\_00296]** [If *PduR\_FrArTpCopyTxData* for the FF-x (Retry not configured) or any of the CFs returns `BUFREQ_E_BUSY`, the call shall be repeated until `FrArTpTimeCs` expires. ]()

**[SWS\_FrArTp\_00293]** 「If *PduR\_FrArTpCopyTxData* returns `BUFREQ_E_NOT_OK` or when `FrArTpTimeCs` expired, the transfer shall be aborted by calling *PduR\_FrArTpTxConfirmation* with `E_NOT_OK`.」()

**[SWS\_FrArTp\_00114]** 「At the receiver side, this principle works as follows:

1. FrIf calls the service *FrArTp\_RxIndication*.
2. The FrArTp shall call *PduR\_FrArTpStartOfReception* to prepare reception.
3. The FrArTp shall call *PduR\_FrArTpCopyRxData* to forward FF and CF data.」()

**[SWS\_FrArTp\_00115]** 「The block size used during reception is constant. The value is configured via `FrArTpMaxBs`, and can be changed via the API *FrArTp\_ChangeParameter*.」()

**[SWS\_FrArTp\_00294]** 「If Retry is not enabled, and *PduR\_FrArTpStartOfReception* returns an available buffer size that is too small for the FF-x, FrArTp shall abort the transfer and call *PduR\_FrArTpRxIndication* with `E_NOT_OK`.」()

**[SWS\_FrArTp\_00300]** 「If Retry is enabled, and *PduR\_FrArTpStartOfReception* returns an available buffer size that is too small for the first block, FrArTp shall call *PduR\_FrArTpCopyRxData* with `info.SduLength` equal to 0 until the available buffer is large enough for the first block. The calls shall be repeated until `FrArTpTimeBr` expires.」()

**[SWS\_FrArTp\_00297]** 「If *PduR\_FrArTpCopyRxData* for the FF-x (Retry not enabled) or for the last CF of a block (independent of Retry configuration) returns an available buffer size that is not large enough for the next block, *PduR\_FrArTpCopyRxData* shall be called repeatedly with `info.SduLength` equal to 0 until the available buffer is large enough. The calls shall be repeated until `FrArTpTimeBr` expires.」()

**[SWS\_FrArTp\_00301]** 「When `FrArTpTimeBr` expires during calls to *PduR\_FrArTpCopyRxData* with `info.SduLength` equal to 0, a WAIT frame (FC frame with `FS = WT`) shall be sent, and the retry phase shall start again, but at most `FrArTpMaxWft` times.」()

**[SWS\_FrArTp\_00295]** 「If *PduR\_FrArTpCopyRxData* returns `BUFREQ_E_NOT_OK`, or when `FrArTpMaxWft` expired, the transfer shall be aborted and *PduR\_FrArTpRxIndication* shall be called with `E_NOT_OK`.」()

**[SWS\_FrArTp\_00117]** 「In case of failing to copy the received data, the remaining CFs of the current block shall be discarded. When the failure occurred in the last block, and acknowledgement is enabled, an AF with a negative acknowledgement and FS = OVFLW shall be sent back to the sender. Otherwise, an FC with FS = OVFLW shall be sent back, but only if the initial call to *PduR\_FrTpStartOfReception* returned *BUFREQ\_E\_OVFL*.」()

### 7.4.11.3 Buffer Locking

At the sender side, the originator of the transmission (e.g. DCM or COM) shall not change the buffer after a successful Transmit call until the connection is closed by a call to *TxConfirmation*. When a cyclic buffer is used, the data in this buffer must be kept until it is explicitly freed by *PduR\_FrArTpCopyTxData* with *retry.TpDataState* set to *TP\_DATACONF*.

At the receiver side, the module that provides the receive buffer (e.g. DCM or COM) shall not change this buffer after a successful call to *StartOfReception* until the connection is closed by a call to *PduR\_FrArTpRxIndication*. When a cyclic buffer is used, it may assume that all data provided via *PduR\_FrArTpCopyRxData* is valid and may be discarded immediately.

### 7.4.11.4 Data Bytes in First Frames

#### **[SWS\_FrArTp\_00120]** Not compliant to ISO 15765-2

「As stated in 7.4.11.2, if acknowledgement with Retry is configured for the corresponding channel, no payload is sent within an FF-x if a segmented transfer takes place.」()

This is necessary to retain backwards compatibility to the AUTOSAR release 3 FrTp on bus level.

**[SWS\_FrArTp\_00121]** 「If acknowledgment without Retry (or no acknowledgement) is configured, there are data bytes within an FF-x.」()

### 7.4.12 Ignored Frames

**[SWS\_FrArTp\_00139]** 「Throughout this specification, many times the ignoring of frames is mentioned. Please note that an ignored frame does never affect a timer, i.e. never causes the restarting of a timer.」()

**[SWS\_FrArTp\_00140]** 「The only exception is at the receiver side when retry is configured and due to an erroneous frame an AF with negative acknowledgement is

sent and therefore it is waited for the retry frame(s). In this case, the timer CR will be reset by the erroneous frame. ]()

## 7.5 Buffer Access Modes in the FlexRay Interface

**[SWS\_FrArTp\_00187]** [The FrArTp shall be implemented being able to work both with N-PDUs configured (in the FlexRay Interface) for Immediate Buffer Access and for Decoupled Buffer Access, i.e. it shall reuse its channel specific temporary buffers, in case the local peer is the sender, not before the TxConfirmation for the respective PDU pool has arrived.

In the receiving case, from FrArTp's point of view, there is no difference between an N-PDU being configured for Decoupled Buffer Access or Immediate Buffer Access. ]()

## 7.6 Error classification

Section 7.x "Error Handling" of the document "General Specification of Basic Software Modules" describes the error handling of the Basic Software in detail. Above all, it constitutes a classification scheme consisting of five error types which may occur in BSW modules.

Based on this foundation, the following section specifies particular errors arranged in the respective subsections below.

### 7.6.1 Development Errors

**[SWS\_FrArTp\_00179]**[

<i>Type of error</i>	<i>Related error code</i>	<i>Error value</i>
API service called while module is not initialized	FRARTP_E_UNINIT	0x1
API service called with invalid pointer	FRARTP_E_PARAM_POINTER	0x2
API service called with invalid SDU or PDU ID	FRARTP_E_INVALID_PDU_SDU_ID	0x3
Invalid configuration set selection	FRARTP_E_INIT_FAILED	0x4

](SRS\_BSW\_00337, SRS\_Fr\_05089)

### 7.6.2 Runtime Errors

There are no runtime errors.

### 7.6.3 Transient Faults

There are no transient faults.

#### **7.6.4 Production Errors**

There are no production errors.

#### **7.6.5 Extended Production Errors**

There are no extended production errors.

## 8 API specification

[SWS\_FrArTp\_00291] [If development error detection is enabled, all APIs with a parameter containing an SDU or a PDU identifier shall check the identifier and raise the development error FRARTP\_E\_INVALID\_PDU\_SDU\_ID when the identifier has not been configured.](SRS\_BSW\_00323)

### 8.1 Imported types

The following types are defined within AUTOSAR and used for the FrArTp:

[SWS\_FrArTp\_00141]

<i>Module</i>	<i>Header File</i>	<i>Imported Type</i>
ComStack_Types	ComStack_Types.h	BufReq_ReturnType
	ComStack_Types.h	PduIdType
	ComStack_Types.h	PduInfoType
	ComStack_Types.h	PduLengthType
	ComStack_Types.h	RetryInfoType
	ComStack_Types.h	TPParameterType
	ComStack_Types.h	TpDataStateType
Std	Std_Types.h	Std_ReturnType
	Std_Types.h	Std_VersionInfoType

()

### 8.2 Type definitions

[SWS\_FrArTp\_00288]

<b>Name</b>	FrArTp_ConfigType	
<b>Kind</b>	Structure	
<b>Elements</b>	implementation specific	
	<b>Type</b>	--
	<b>Comment</b>	--
<b>Description</b>	<p>This is the base type for the configuration of the FlexRay Transport Protocol. A pointer to an instance of this structure will be used in the initialization of the Flex Ray Transport Protocol.</p> <p>The outline of the structure is defined in chapter 10 Configuration Specification.</p>	
<b>Available via</b>	FrArTp.h	



]()

### 8.3 Function definitions

This is a list of functions provided for upper layer modules.

#### 8.3.1 Standard functions

##### 8.3.1.1 FrArTp\_GetVersionInfo

[SWS\_FrArTp\_00215]

<b>Service Name</b>	FrArTp_GetVersionInfo	
<b>Syntax</b>	<pre>void FrArTp_GetVersionInfo (     Std_VersionInfoType* versioninfo )</pre>	
<b>Service ID [hex]</b>	0x27	
<b>Sync/Async</b>	Synchronous	
<b>Reentrancy</b>	Reentrant	
<b>Parameters (in)</b>	None	
<b>Parameters (inout)</b>	None	
<b>Parameters (out)</b>	versioninfo	Pointer to where to store the version information of this module.
<b>Return value</b>	None	
<b>Description</b>	Returns the version information.	
<b>Available via</b>	FrArTp.h	

](SRS\_BSW\_00411)

#### 8.3.2 Initialization and Shutdown

### 8.3.2.1 FrArTp\_Init

#### [SWS\_FrArTp\_00147]

<b>Service Name</b>	FrArTp_Init	
<b>Syntax</b>	<pre>void FrArTp_Init (     const FrArTp_ConfigType* configPtr )</pre>	
<b>Service ID [hex]</b>	0x00	
<b>Sync/Async</b>	Synchronous	
<b>Reentrancy</b>	Non Reentrant	
<b>Parameters (in)</b>	configPtr	Pointer to FlexRay Transport Protocol configuration.
<b>Parameters (inout)</b>	None	
<b>Parameters (out)</b>	None	
<b>Return value</b>	None	
<b>Description</b>	This service initializes all global variables of the FlexRay AUTOSAR Transport Layer and sets all states to idle.	
<b>Available via</b>	FrArTp.h	

](SRS\_BSW\_00101, SRS\_Fr\_05088)

Please note: The call of this service is mandatory before using the FrArTp for further processing.

### 8.3.2.2 FrArTp\_Shutdown

#### [SWS\_FrArTp\_00148]

<b>Service Name</b>	FrArTp_Shutdown	
<b>Syntax</b>	<pre>void FrArTp_Shutdown (     void )</pre>	
<b>Service ID [hex]</b>	0x01	
<b>Sync/Async</b>	Synchronous	
<b>Reentrancy</b>	Non Reentrant	
<b>Parameters (in)</b>	None	
<b>Parameters (inout)</b>	None	
<b>Parameters</b>	None	

<b>(out)</b>	
<b>Return value</b>	None
<b>Description</b>	This service closes all pending transport protocol connections by simply stopping operation, frees all resources and stops the FrArTp Module
<b>Available via</b>	FrArTp.h

](SRS\_BSW\_00336)

### 8.3.3 Normal Operation

#### 8.3.3.1 FrArTp\_Transmit

[SWS\_FrArTp\_00149][

<b>Service Name</b>	FrArTp_Transmit	
<b>Syntax</b>	<pre>Std_ReturnType FrArTp_Transmit (     PduIdType TxPduId,     const PduInfoType* PduInfoPtr )</pre>	
<b>Service ID [hex]</b>	0x49	
<b>Sync/Async</b>	Synchronous	
<b>Reentrancy</b>	Reentrant for different PduIds. Non reentrant for the same PduId.	
<b>Parameters (in)</b>	TxPduId	Identifier of the PDU to be transmitted
	PduInfoPtr	Length of and pointer to the PDU data and pointer to Meta Data.
<b>Parameters (inout)</b>	None	
<b>Parameters (out)</b>	None	
<b>Return value</b>	Std_Return-Type	E_OK: Transmit request has been accepted. E_NOT_OK: Transmit request has not been accepted.
<b>Description</b>	Requests transmission of a PDU.	
<b>Available via</b>	FrArTp.h	

](SRS\_BSW\_00369, SRS\_Fr\_05075)

#### 8.3.3.2 FrArTp\_CancelTransmit

[SWS\_FrArTp\_00150][

<b>Service Name</b>	FrArTp_CancelTransmit
---------------------	-----------------------

<b>Syntax</b>	Std_ReturnType FrArTp_CancelTransmit ( PduIdType TxPduId )	
<b>Service ID [hex]</b>	0x4a	
<b>Sync/Async</b>	Synchronous	
<b>Reentrancy</b>	Reentrant for different PduIds. Non reentrant for the same PduId.	
<b>Parameters (in)</b>	TxPduId	Identification of the PDU to be cancelled.
<b>Parameters (inout)</b>	None	
<b>Parameters (out)</b>	None	
<b>Return value</b>	Std_Return- Type	E_OK: Cancellation was executed successfully by the destination module. E_NOT_OK: Cancellation was rejected by the destination module.
<b>Description</b>	Requests cancellation of an ongoing transmission of a PDU in a lower layer communication module.	
<b>Available via</b>	FrArTp.h	

}]()

Please note: When a transfer is successfully cancelled, the function PduR\_FrArTpTxConfirmation will be called with E\_NOT\_OK.

### 8.3.3.3 FrArTp\_CancelReceive

[SWS\_FrArTp\_00229]

<b>Service Name</b>	FrArTp_CancelReceive	
<b>Syntax</b>	Std_ReturnType FrArTp_CancelReceive ( PduIdType RxPduId )	
<b>Service ID [hex]</b>	0x4c	
<b>Sync/Async</b>	Synchronous	
<b>Reentrancy</b>	Non Reentrant	
<b>Parameters (in)</b>	RxPduId	Identification of the PDU to be cancelled.
<b>Parameters (inout)</b>	None	
<b>Parameters (out)</b>	None	
<b>Return value</b>	Std_Return- Type	E_OK: Cancellation was executed successfully by the destination module. E_NOT_OK: Cancellation was rejected by the destination module.

<b>Description</b>	Requests cancellation of an ongoing reception of a PDU in a lower layer transport protocol module.
<b>Available via</b>	FrArTp.h

]()

### 8.3.3.4 FrArTp\_ChangeParameter

[SWS\_FrArTp\_00151]

<b>Service Name</b>	FrArTp_ChangeParameter	
<b>Syntax</b>	<pre>Std_ReturnType FrArTp_ChangeParameter (     PduIdType id,     TPParameterType parameter,     uint16 value )</pre>	
<b>Service ID [hex]</b>	0x4b	
<b>Sync/Async</b>	Synchronous	
<b>Reentrancy</b>	Non Reentrant	
<b>Parameters (in)</b>	id	Identification of the PDU which the parameter change shall affect.
	parameter	ID of the parameter that shall be changed.
	value	The new value of the parameter.
<b>Parameters (inout)</b>	None	
<b>Parameters (out)</b>	None	
<b>Return value</b>	Std_Return-Type	E_OK: The parameter was changed successfully. E_NOT_OK: The parameter change was rejected.
<b>Description</b>	Request to change a specific transport protocol parameter (e.g. block size).	
<b>Available via</b>	FrArTp.h	

]()

Caveats: According to ISO 15765-2, it is not possible to change a parameter value during an ongoing reception.

## 8.4 Call-back notifications

### 8.4.1 FrArTp\_TriggerTransmit

[SWS\_FrArTp\_00154]

<b>Service</b>	FrArTp_TriggerTransmit
----------------	------------------------

<b>Name</b>		
<b>Syntax</b>	<pre>Std_ReturnType FrArTp_TriggerTransmit (     PduIdType TxPduId,     PduInfoType* PduInfoPtr )</pre>	
<b>Service ID [hex]</b>	0x41	
<b>Sync/Async</b>	Synchronous	
<b>Reentrancy</b>	Reentrant for different PduIds. Non reentrant for the same PduId.	
<b>Parameters (in)</b>	TxPduId	ID of the SDU that is requested to be transmitted.
<b>Parameters (inout)</b>	PduInfoPtr	Contains a pointer to a buffer (SduDataPtr) to where the SDU data shall be copied, and the available buffer size in SduLength. On return, the service will indicate the length of the copied SDU data in SduLength.
<b>Parameters (out)</b>	None	
<b>Return value</b>	Std_Return- Type	E_OK: SDU has been copied and SduLength indicates the number of copied bytes. E_NOT_OK: No SDU data has been copied. PduInfoPtr must not be used since it may contain a NULL pointer or point to invalid data.
<b>Description</b>	Within this API, the upper layer module (called module) shall check whether the available data fits into the buffer size reported by PduInfoPtr->SduLength. If it fits, it shall copy its data into the buffer provided by PduInfoPtr->SduDataPtr and update the length of the actual copied data in PduInfoPtr->SduLength. If not, it returns E_NOT_OK without changing PduInfoPtr.	
<b>Available via</b>	FrArTp.h	

](SRS\_BSW\_00369)

Please note: This function might be called in interrupt context

## 8.4.2 FrArTp\_RxIndication

[SWS\_FrArTp\_00152]

<b>Service Name</b>	FrArTp_RxIndication	
<b>Syntax</b>	<pre>void FrArTp_RxIndication (     PduIdType RxPduId,     const PduInfoType* PduInfoPtr )</pre>	
<b>Service ID [hex]</b>	0x42	
<b>Sync/Async</b>	Synchronous	
<b>Reentrancy</b>	Reentrant for different PduIds. Non reentrant for the same PduId.	

<b>Parameters (in)</b>	RxPduId	ID of the received PDU.
	PduInfoPtr	Contains the length (SduLength) of the received PDU, a pointer to a buffer (SduDataPtr) containing the PDU, and the MetaData related to this PDU.
<b>Parameters (inout)</b>	None	
<b>Parameters (out)</b>	None	
<b>Return value</b>	None	
<b>Description</b>	Indication of a received PDU from a lower layer communication interface module.	
<b>Available via</b>	FrArTp.h	

]()

### 8.4.3 FrArTp\_TxConfirmation

[SWS\_FrArTp\_00153]

<b>Service Name</b>	FrArTp_TxConfirmation	
<b>Syntax</b>	<pre>void FrArTp_TxConfirmation (     PduIdType TxPduId,     Std_ReturnType result )</pre>	
<b>Service ID [hex]</b>	0x40	
<b>Sync/Async</b>	Synchronous	
<b>Reentrancy</b>	Reentrant for different PduIds. Non reentrant for the same PduId.	
<b>Parameters (in)</b>	TxPduId	ID of the PDU that has been transmitted.
	result	E_OK: The PDU was transmitted. E_NOT_OK: Transmission of the PDU failed.
<b>Parameters (inout)</b>	None	
<b>Parameters (out)</b>	None	
<b>Return value</b>	None	
<b>Description</b>	The lower layer communication interface module confirms the transmission of a PDU, or the failure to transmit a PDU.	
<b>Available via</b>	FrArTp.h	

]()

## 8.5 Scheduled functions

### 8.5.1 FrArTp\_MainFunction

[SWS\_FrArTp\_00162]

<b>Service Name</b>	FrArTp_MainFunction
<b>Syntax</b>	void FrArTp_MainFunction ( void )
<b>Service ID [hex]</b>	0x10
<b>Description</b>	Schedules the FlexRay TP. (Entry point for scheduling)
<b>Available via</b>	SchM_FrArTp.h

]()

Please note: This function is called directly by the Basic Software Scheduler (SchM).

## 8.6 Expected Interfaces

This section lists all interfaces required from other modules.

### 8.6.1 Mandatory Interfaces

This section defines all interfaces that are required to fulfill the core functionality of the module.

[SWS\_FrArTp\_00219]

<b>API Function</b>	<b>Header File</b>	<b>Description</b>
Frlf_Transmit	Frlf.h	Requests transmission of a PDU.
PduR_FrArTp-CopyRxData	PduR_FrArTp.h	This function is called to provide the received data of an I-PDU segment (N-PDU) to the upper layer. Each call to this function provides the next part of the I-PDU data. The size of the remaining buffer is written to the position indicated by bufferSizePtr.
PduR_FrArTp-CopyTxData	PduR_FrArTp.h	This function is called to acquire the transmit data of an I-PDU segment (N-PDU). Each call to this function provides the next part of the I-PDU data unless retry->TpDataState is TP_DATARETRY. In this case the function restarts to copy the data beginning at the offset from the current position indicated by retry->TxTpDataCnt. The size of the remaining data is written to the position indicated by availableDataPtr.
PduR_FrArTp-RxIndication	PduR_FrArTp.h	Called after an I-PDU has been received via the TP API, the result indicates whether the transmission was successful or not.
PduR_FrArTp-StartOf-	PduR_FrArTp.h	This function is called at the start of receiving an N-SDU. The N-SDU might be fragmented into multiple N-PDUs (FF with one or more



Reception		following CFs) or might consist of a single N-PDU (SF). The service shall provide the currently available maximum buffer size when invoked with TpSduLength equal to 0.
PduR_FrArTp-TxConfirmation	PduR_FrArTp.h	This function is called after the I-PDU has been transmitted on its network, the result indicates whether the transmission was successful or not.

]()

### 8.6.2 Optional Interfaces

This section defines all interfaces that are required to fulfill an optional functionality of the module.

#### [SWS\_FrArTp\_00220]

<i>API Function</i>	<i>Header File</i>	<i>Description</i>
Det_ReportError	Det.h	Service to report development errors.

]()

## 9 Sequence diagrams

Although the following sequence diagrams are quite detailed, they do not depict every detail. Thus, they should be seen as an addendum to this specification.

### 9.1 N-SDU Transmission

#### 9.1.1 Unsegmented N-SDU Transmission

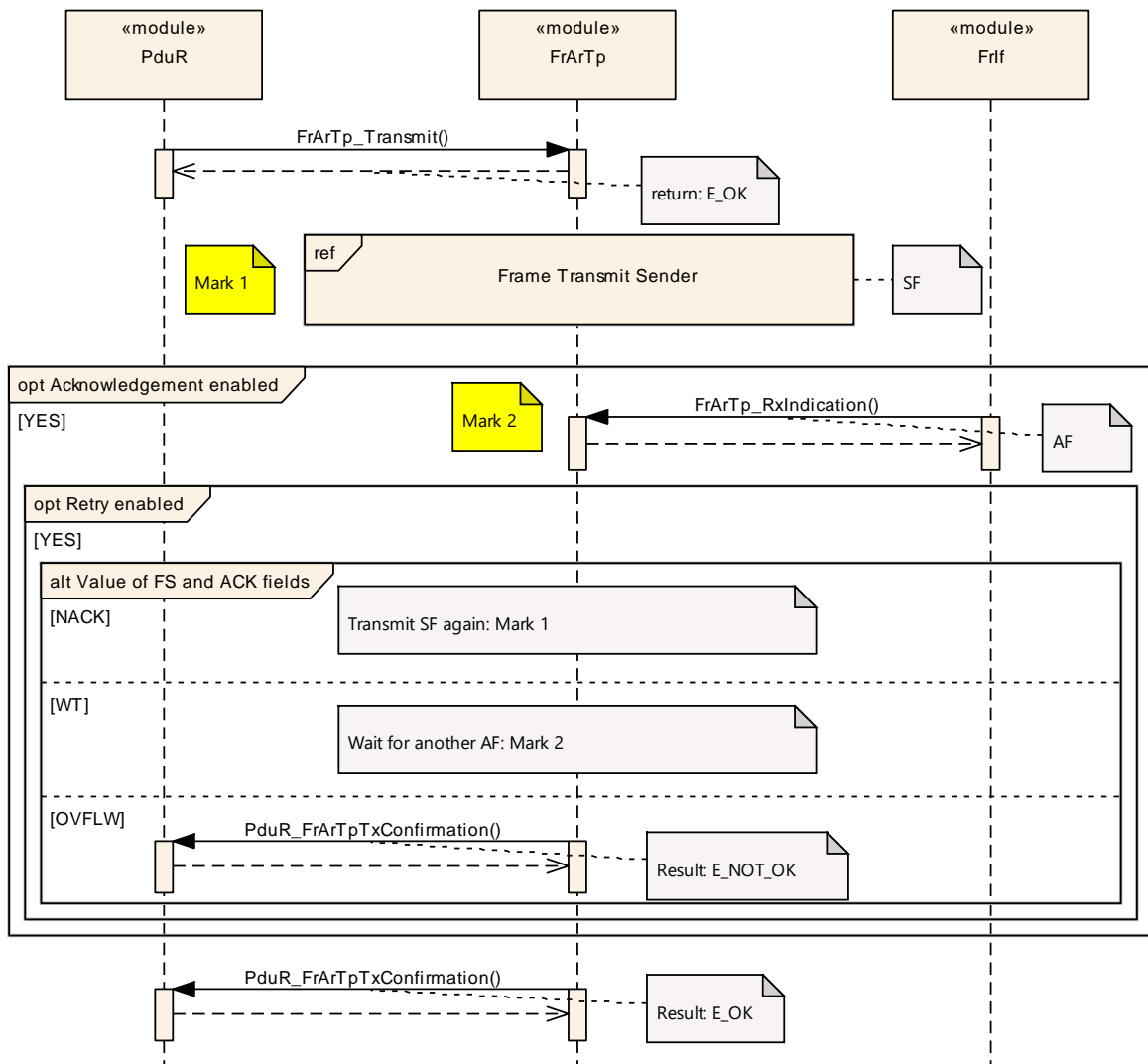

#### 9.1.2 Segmented N-SDU Transmission without Retry

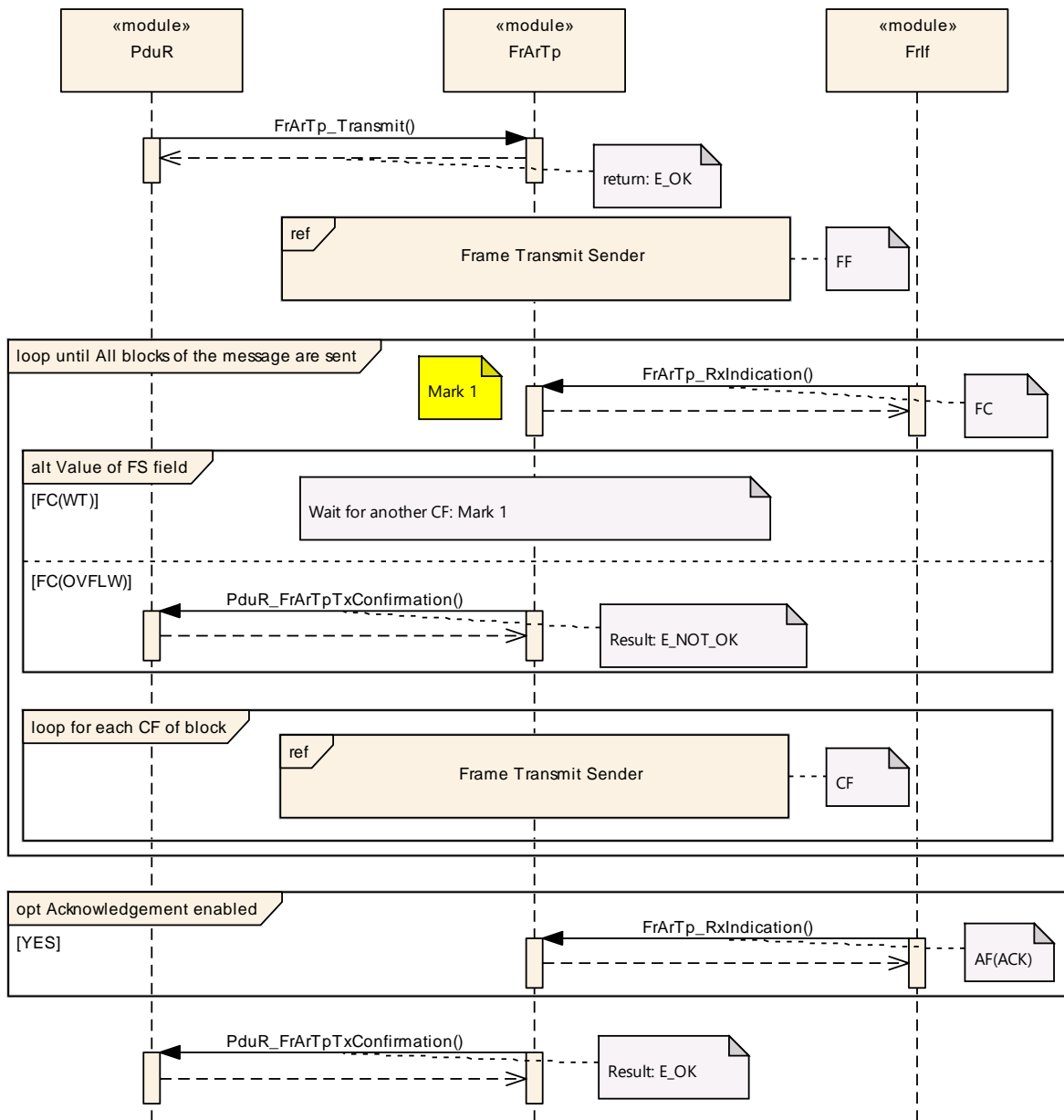

### 9.1.3 Segmented N-SDU Transmission with Retry

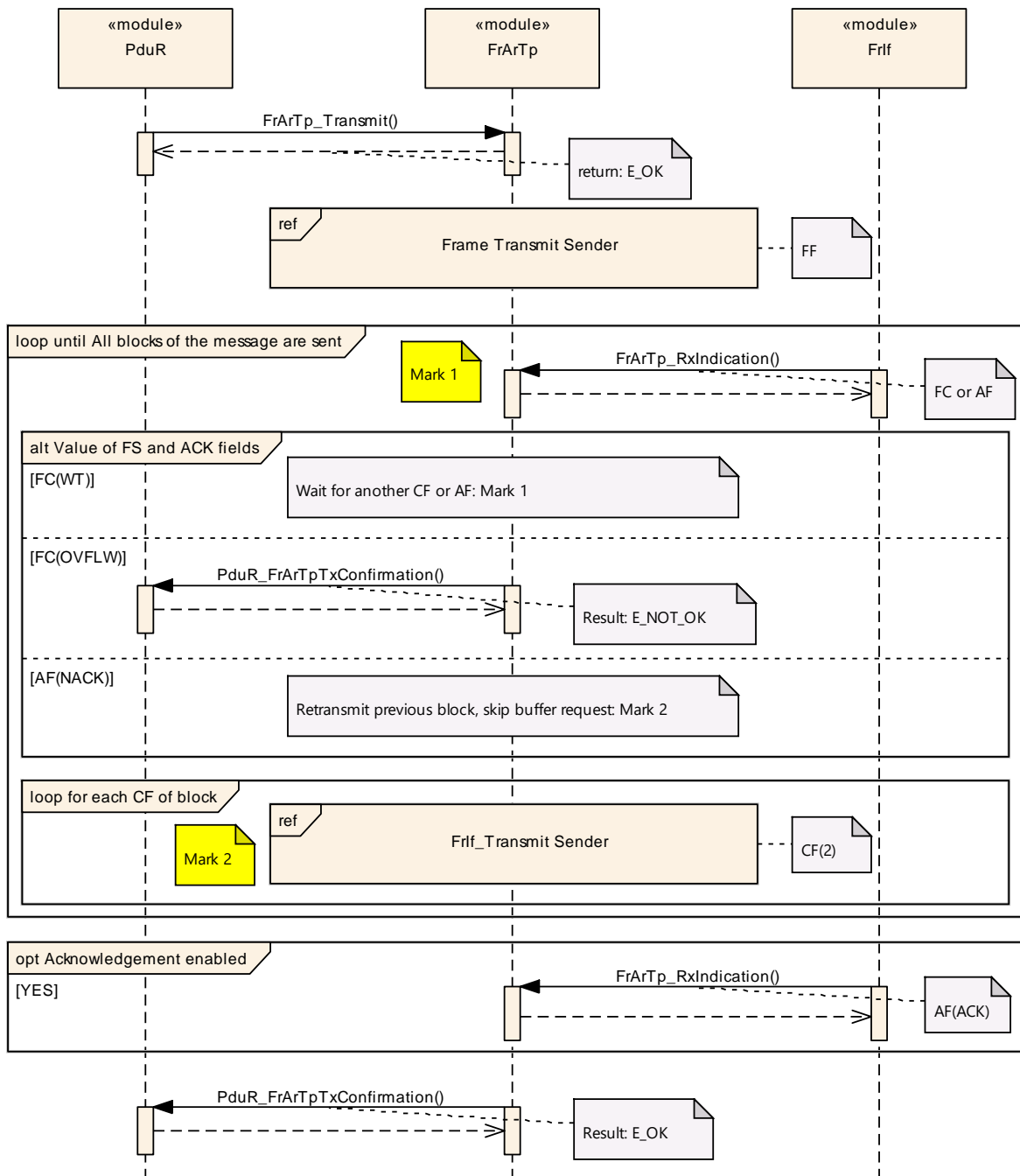

9.1.3.1 N-PDU Transmission during N-SDU Transmission

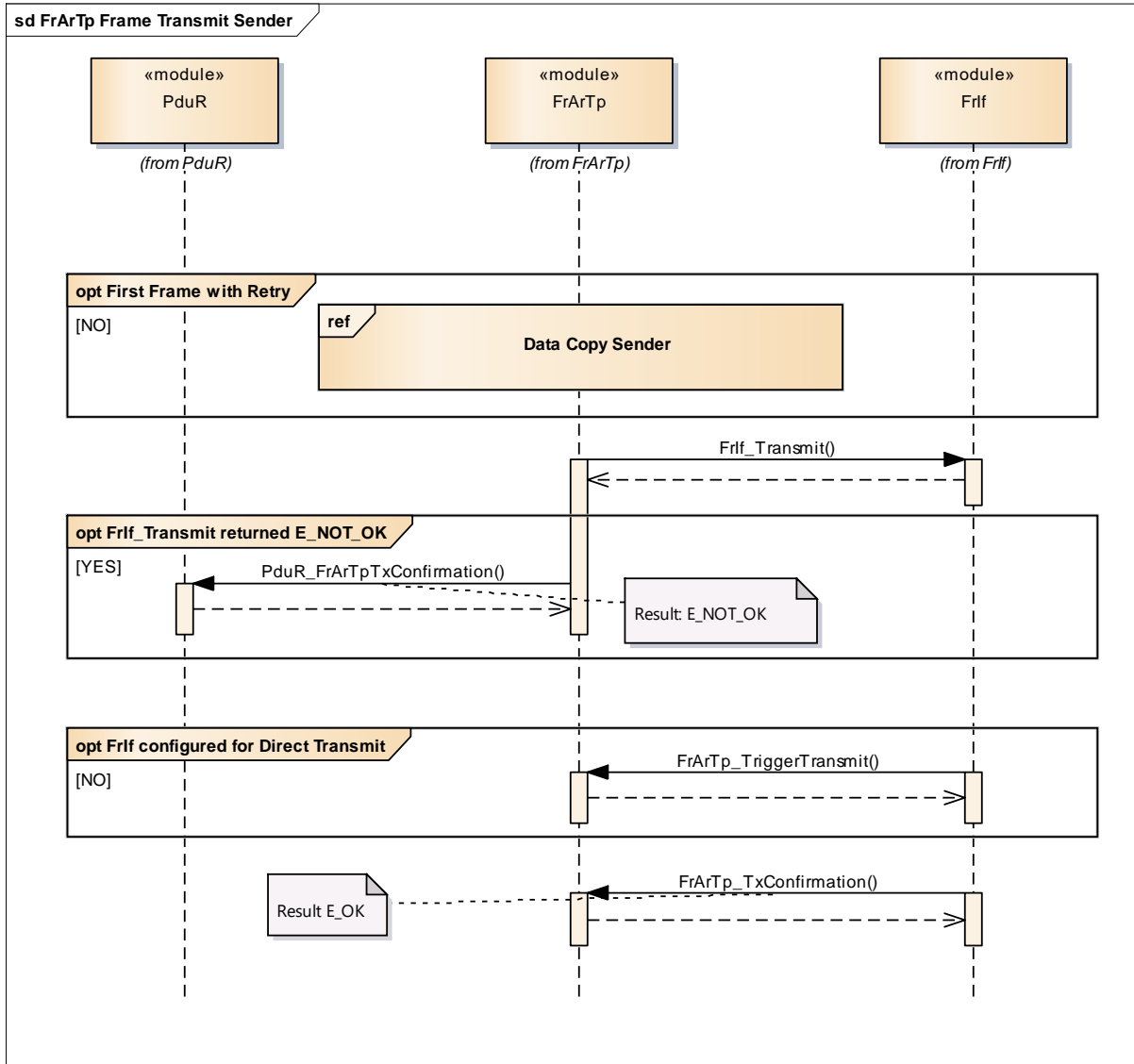

### 9.1.4 N-PDU Data Copying during N-SDU Transmission

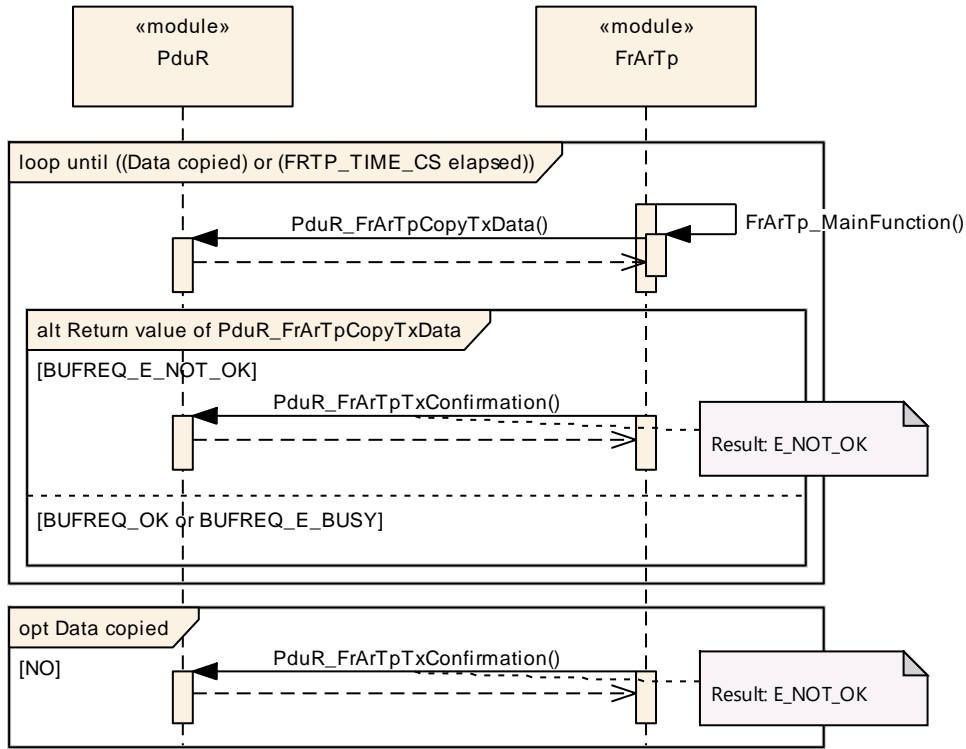

**9.1.4.1 Transmit Cancellation**

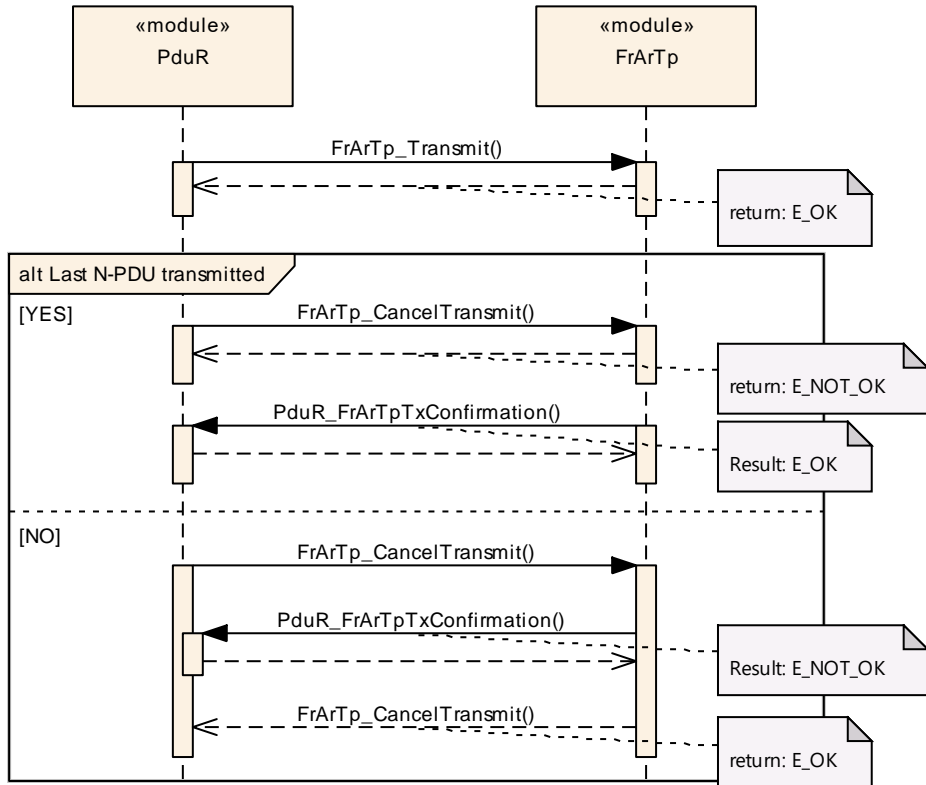

**9.2 N-SDU Reception**

### 9.2.1 Unsegmented N-SDU Reception

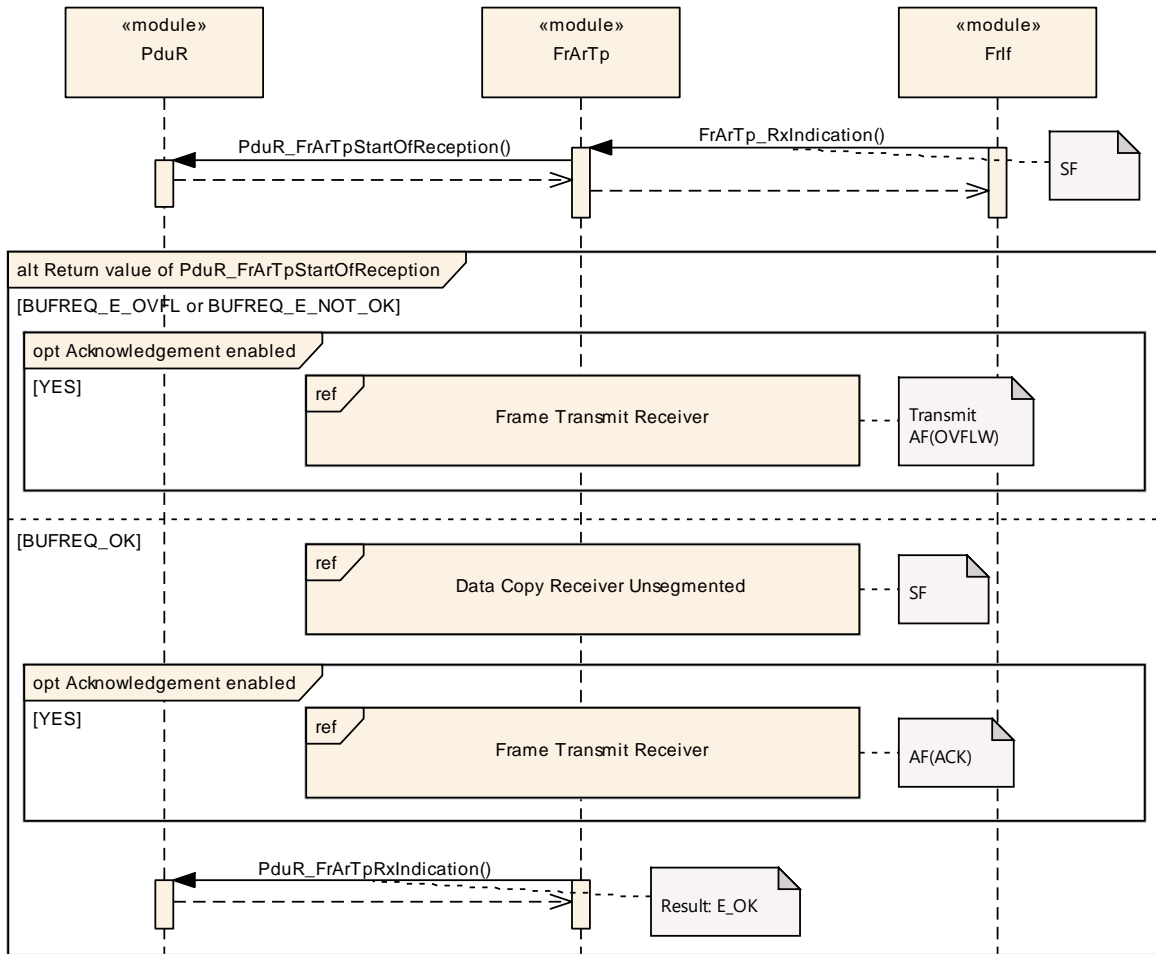

### 9.2.2 N-PDU Data Copying during Unsegmented N-SDU Reception



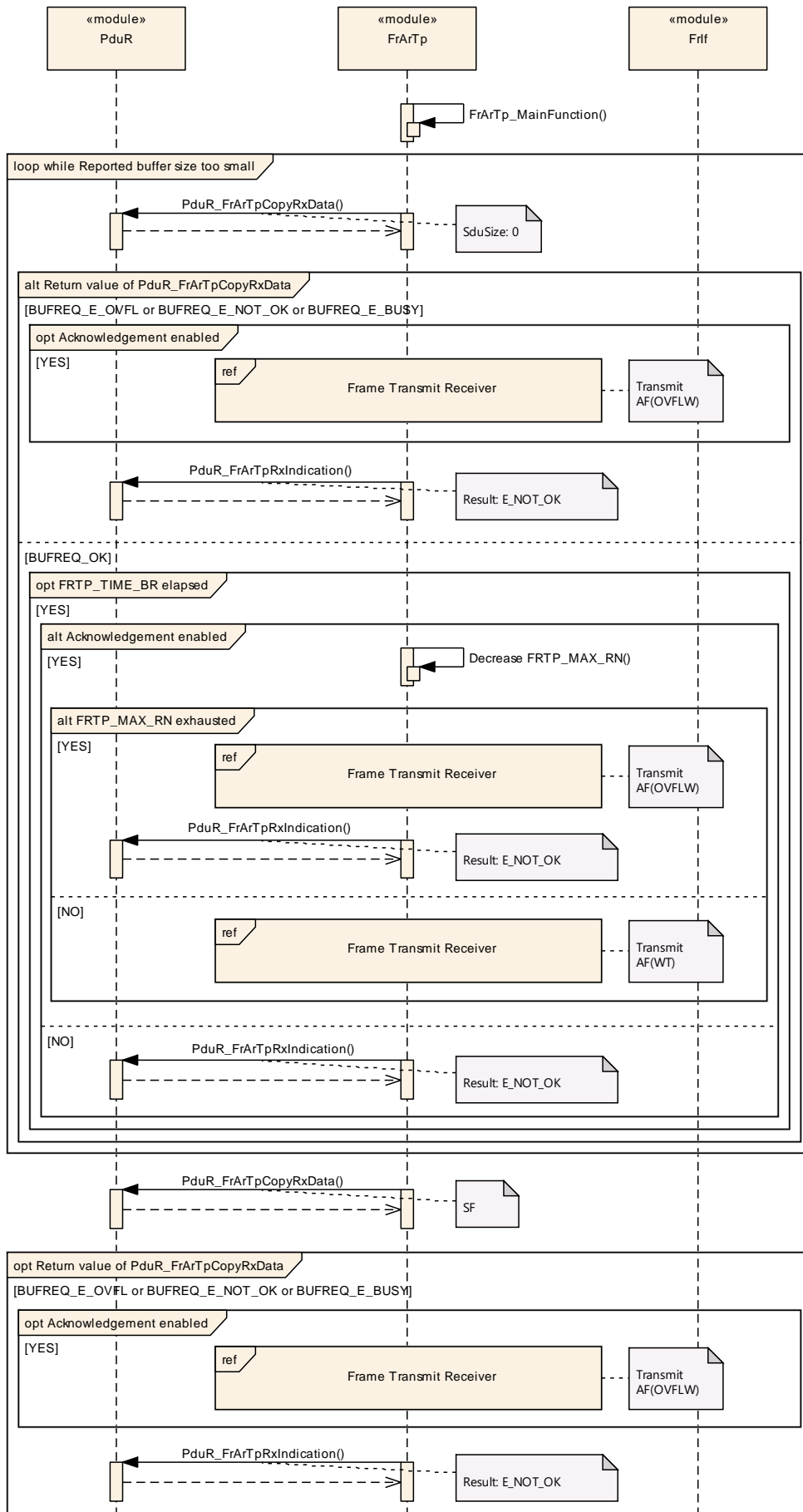

### 9.2.3 Segmented N-SDU Reception

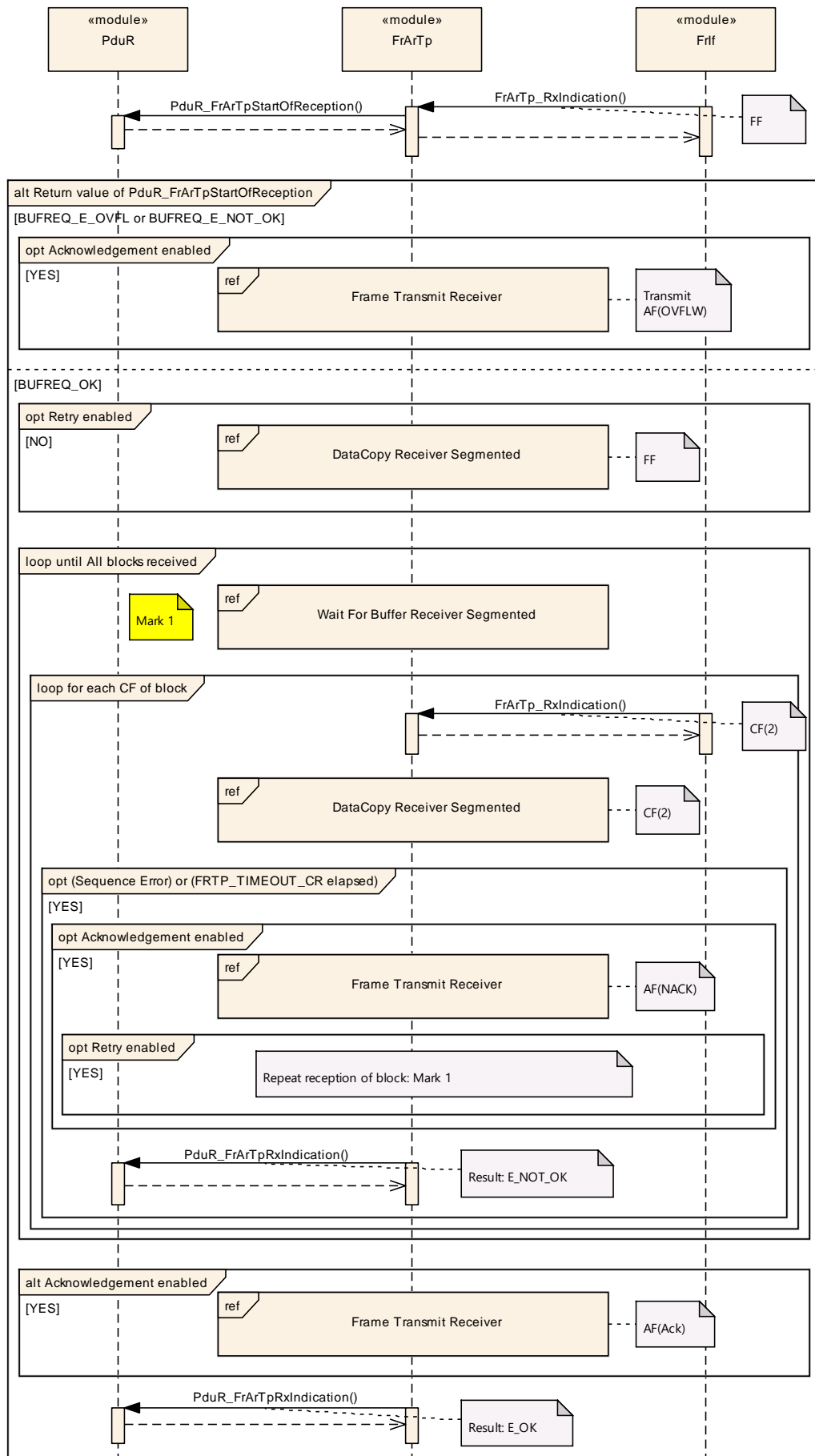

### 9.2.4 Wait for Buffer during Segmented N-SDU Reception

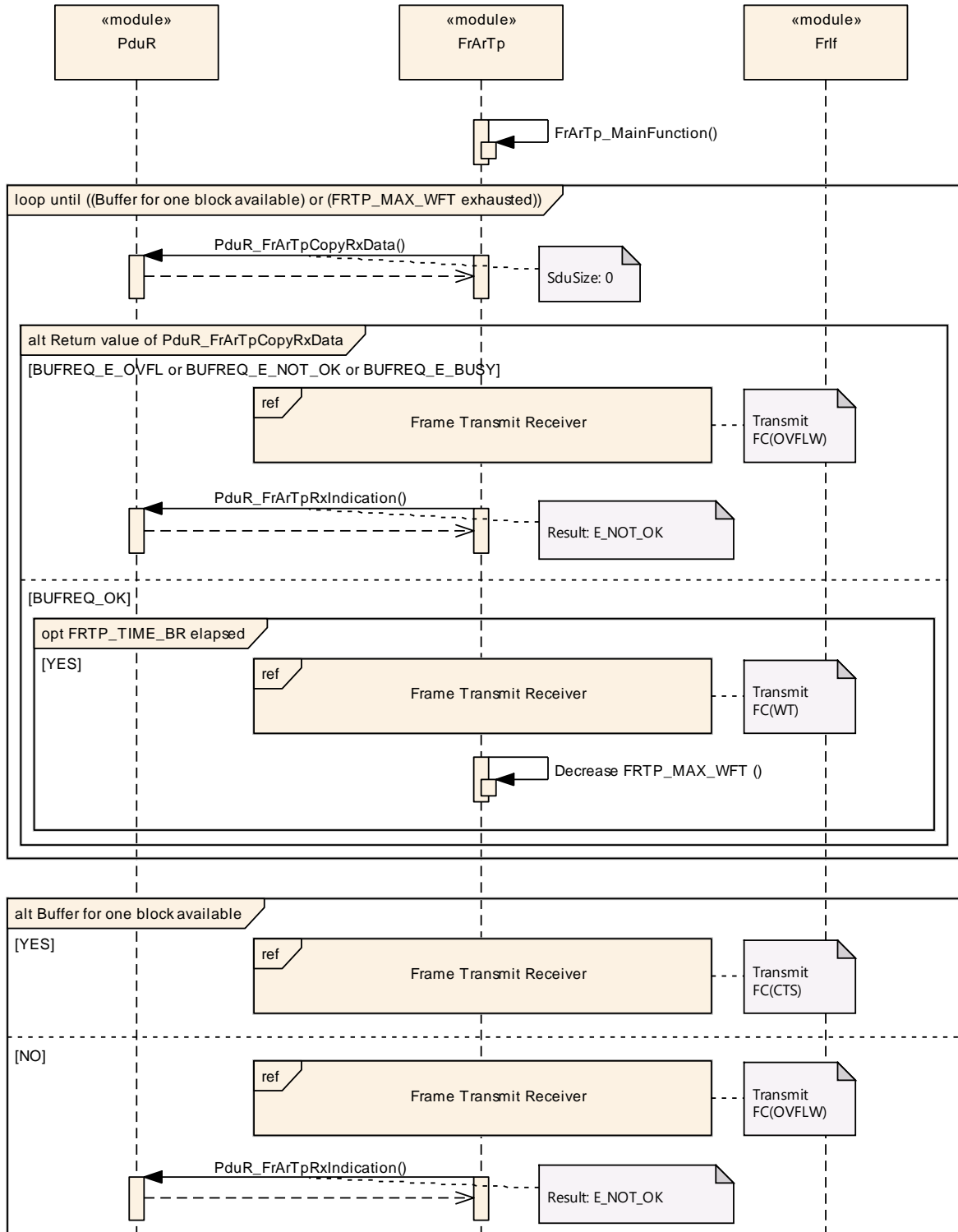

### 9.2.5 N-PDU Data Copying during Segmented N-SDU Reception

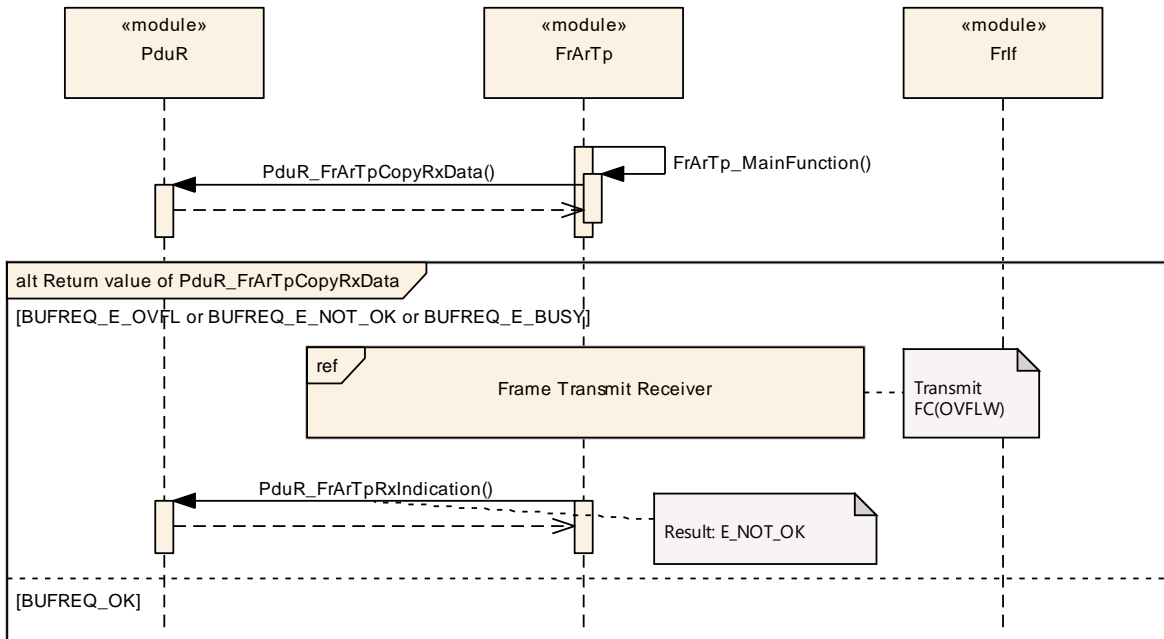

### 9.2.6 N-PDU Transmission during N-SDU Reception

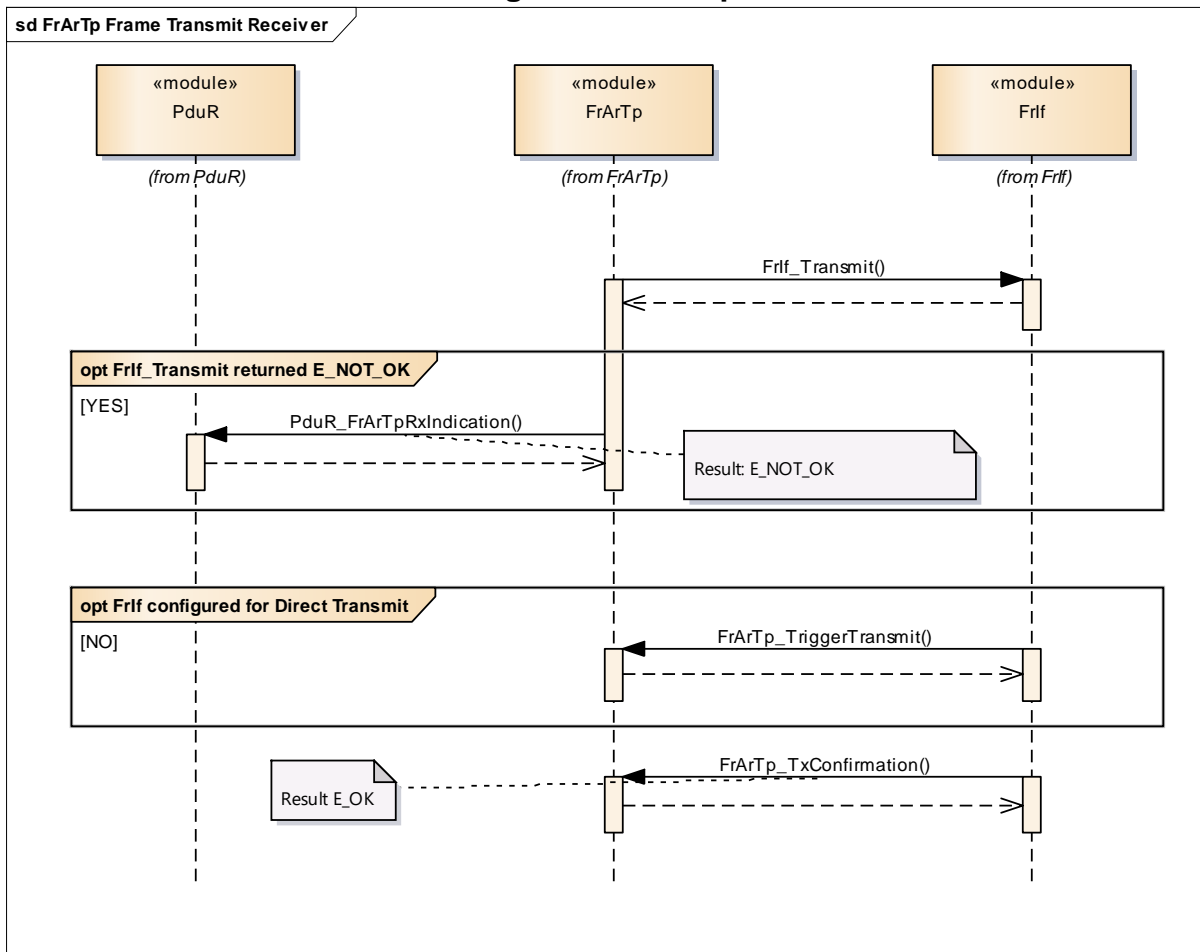

**9.2.7 Receive Cancellation**

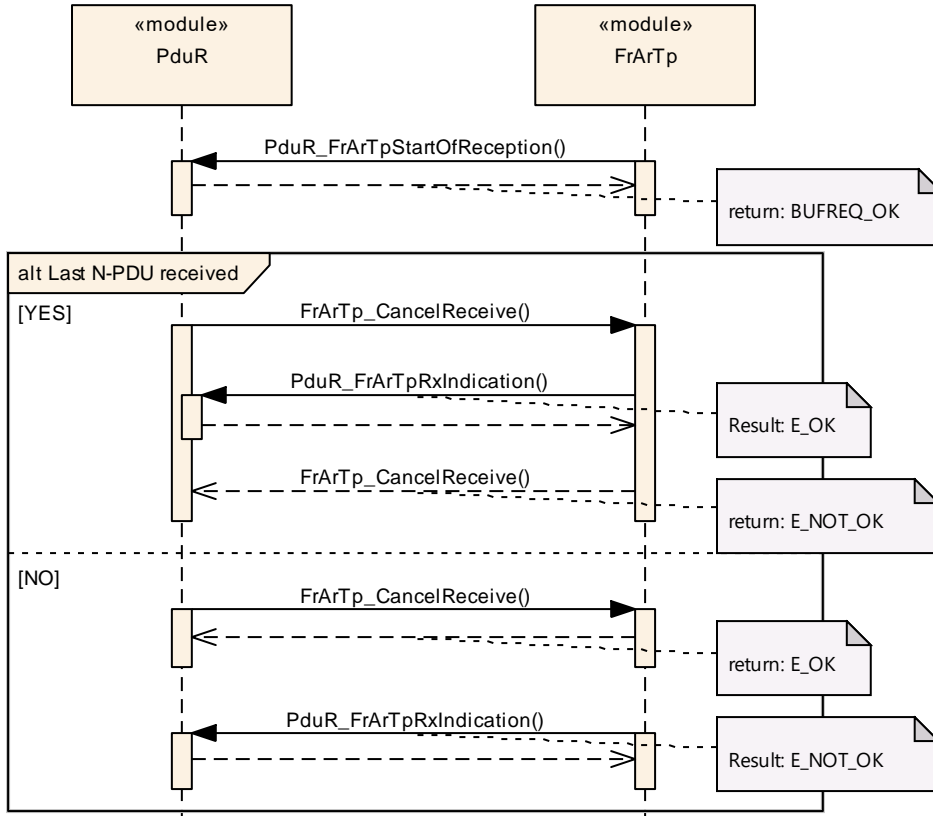

## 10 Configuration specification

In general, this chapter defines configuration parameters and their clustering into containers.

Sections 10.1 and 10.3 refer to the corresponding sections in the SWS BSW General.

Section 10.2 specifies the structure (containers) and the parameters of the FlexRay AUTOSAR Transport Layer module.

Section 10.4 specifies restrictions on some of the parameters of the FlexRay AUTOSAR Transport Layer module.

### 10.1 How to read this chapter

For details, refer to the section 10.1 “Introduction to configuration specification” in *SWS\_BSWGeneral*.

### 10.2 Containers and configuration parameters

The following sections summarize all configuration parameters. The detailed meaning of these parameters is described in chapters 7 and 8.

The following pictures give an overview of the configuration:

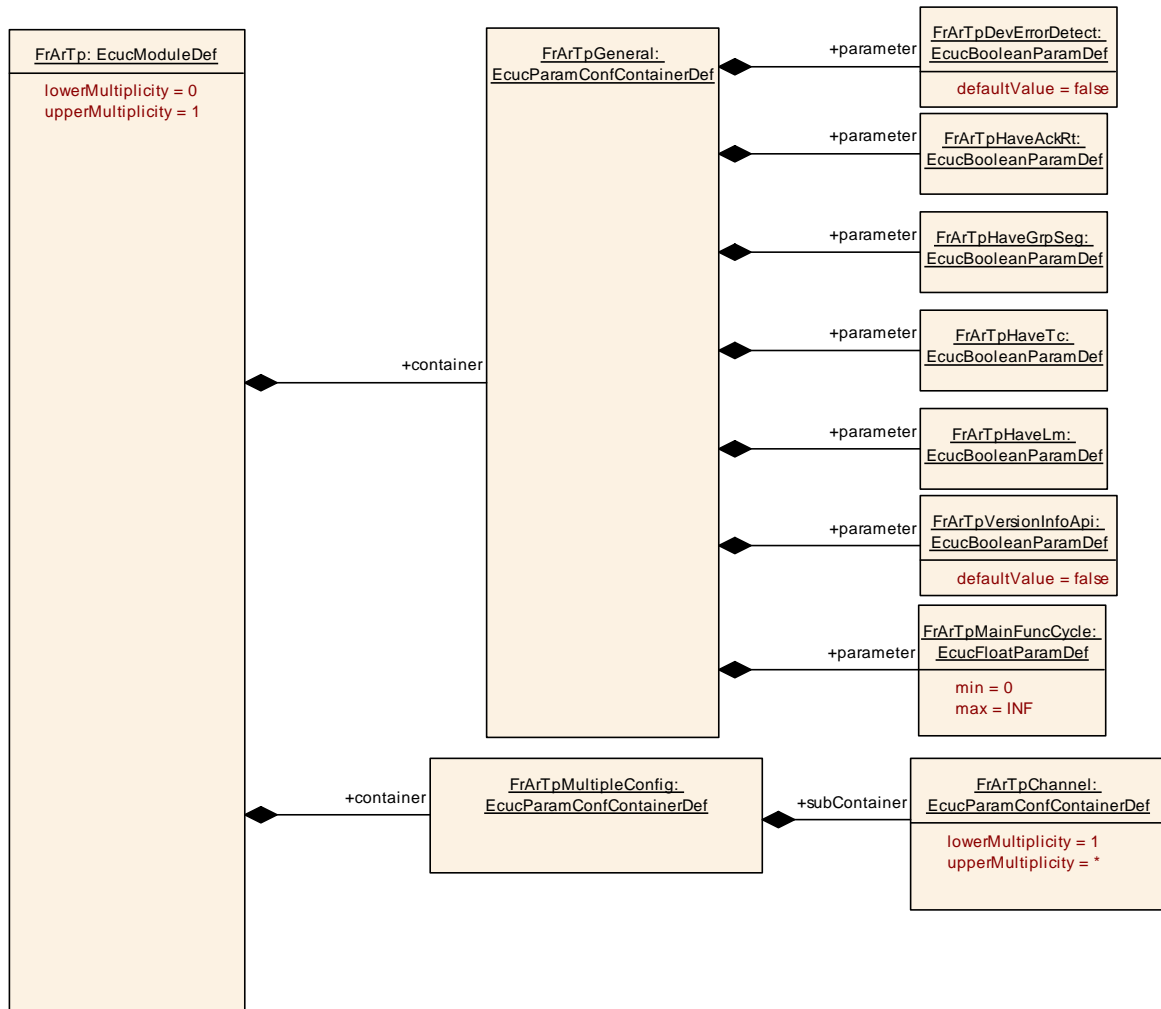

Figure 22: FrArTp main configuration



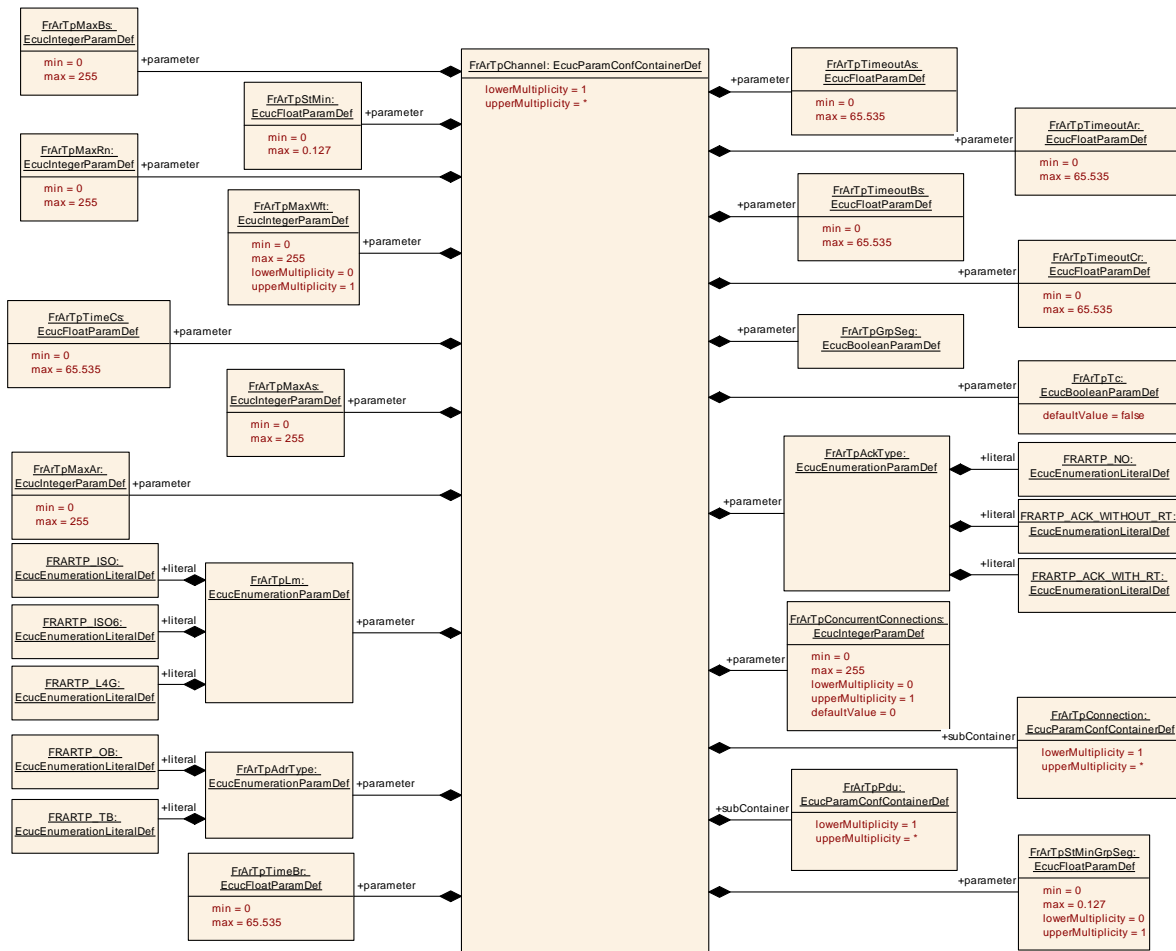

Figure 23: FrArTpChannel configuration

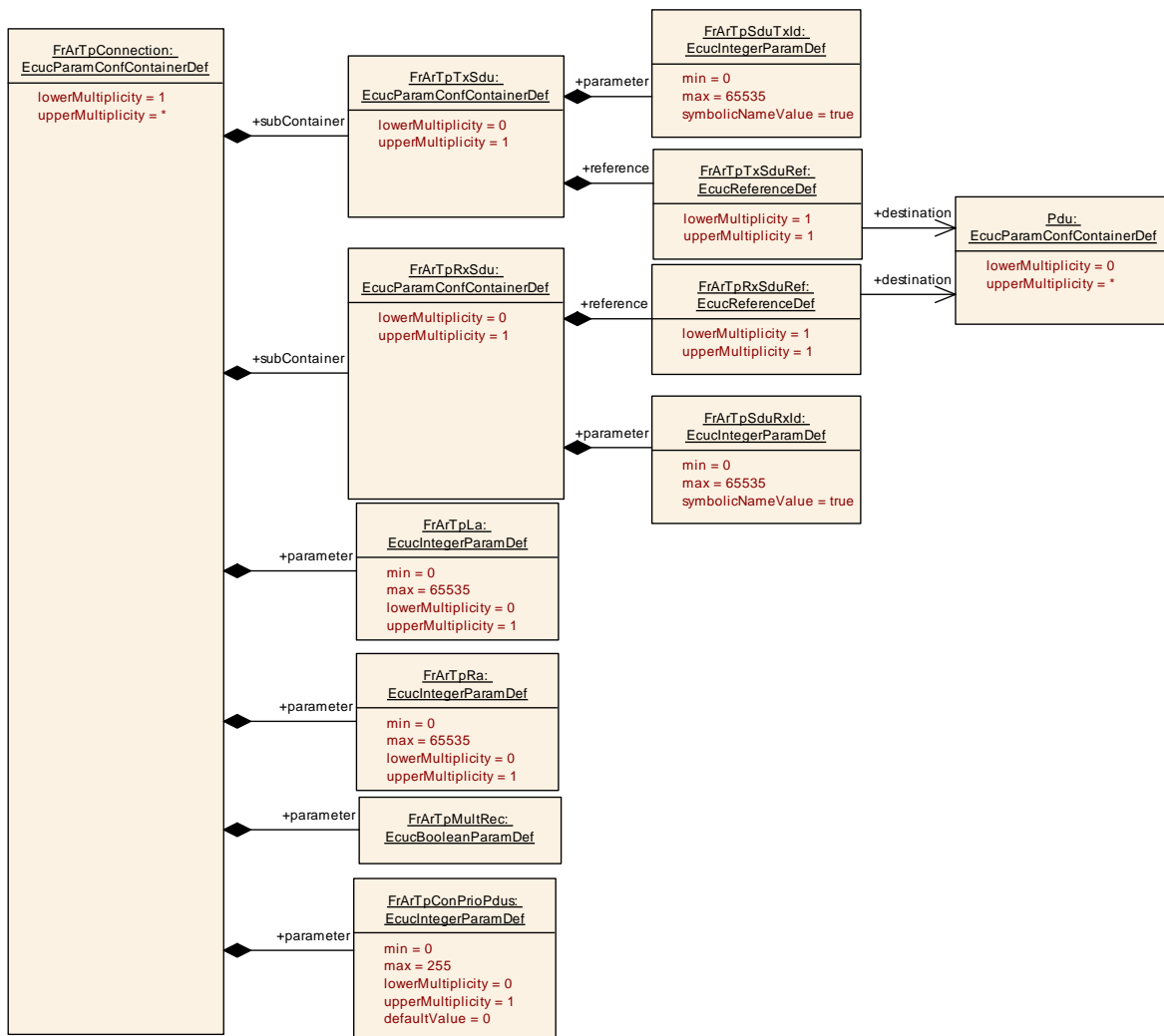

Figure 24: FrArTpConnection configuration

### 10.2.1 FrArTp

<b>SWS Item</b>	<b>ECUC_FrArTp_00001 :</b>
<b>Module Name</b>	FrArTp
<b>Module Description</b>	Configuration of the FrArTp (FlexRay Transport Protocol) module.
<b>Post-Build Variant Support</b>	true
<b>Supported Config Variants</b>	VARIANT-POST-BUILD, VARIANT-PRE-COMPILE

Included Containers		
Container Name	Multiplicity	Scope / Dependency
FrArTpGeneral	1	This container contains the general configuration (parameters) of the FlexRay TP.
FrArTpMultipleConfig	1	This container contains the configuration parameters and sub containers of the AUTOSAR FrArTp module.

### 10.2.2 FrArTpGeneral

<b>SWS Item</b>	<b>ECUC_FrArTp_00012 :</b>
<b>Container Name</b>	FrArTpGeneral
<b>Parent Container</b>	FrArTp
<b>Description</b>	This container contains the general configuration (parameters) of the FlexRay TP.

**Configuration Parameters**

<b>SWS Item</b>	<b>ECUC_FrArTp_00011 :</b>		
<b>Name</b>	FrArTpDevErrorDetect		
<b>Parent Container</b>	FrArTpGeneral		
<b>Description</b>	Switches the development error detection and notification on or off. <ul style="list-style-type: none"> <li>• true: detection and notification is enabled.</li> <li>• false: detection and notification is disabled.</li> </ul>		
<b>Multiplicity</b>	1		
<b>Type</b>	EcucBooleanParamDef		
<b>Default value</b>	false		
<b>Post-Build Variant Value</b>	false		
<b>Value Configuration Class</b>	<b>Pre-compile time</b>	X	All Variants
	<b>Link time</b>	--	
	<b>Post-build time</b>	--	
<b>Scope / Dependency</b>	scope: local		

<b>SWS Item</b>	<b>ECUC_FrArTp_00014 :</b>		
<b>Name</b>	FrArTpHaveAckRt		
<b>Parent Container</b>	FrArTpGeneral		
<b>Description</b>	Preprocessor switch for enabling the Acknowledgement and retry mechanisms.		
<b>Multiplicity</b>	1		
<b>Type</b>	EcucBooleanParamDef		
<b>Default value</b>	--		
<b>Post-Build Variant Value</b>	false		
<b>Value Configuration Class</b>	<b>Pre-compile time</b>	X	All Variants
	<b>Link time</b>	--	
	<b>Post-build time</b>	--	
<b>Scope / Dependency</b>	scope: local		

<b>SWS Item</b>	<b>ECUC_FrArTp_00015 :</b>		
<b>Name</b>	FrArTpHaveGrpSeg		
<b>Parent Container</b>	FrArTpGeneral		
<b>Description</b>	Preprocessor switch for enabling segmentation of 1:n messages.		
<b>Multiplicity</b>	1		
<b>Type</b>	EcucBooleanParamDef		
<b>Default value</b>	--		
<b>Post-Build Variant Value</b>	false		
<b>Value Configuration Class</b>	<b>Pre-compile time</b>	X	All Variants
	<b>Link time</b>	--	
	<b>Post-build time</b>	--	
<b>Scope / Dependency</b>	scope: local		

<b>SWS Item</b>	<b>ECUC_FrArTp_00016 :</b>		
<b>Name</b>	FrArTpHaveLm		
<b>Parent Container</b>	FrArTpGeneral		
<b>Description</b>	Preprocessor switch for enabling the mechanism for message longer than allowed by.		
<b>Multiplicity</b>	1		
<b>Type</b>	EcucBooleanParamDef		
<b>Default value</b>	--		
<b>Post-Build Variant Value</b>	false		
<b>Value Configuration Class</b>	<b>Pre-compile time</b>	X	All Variants
	<b>Link time</b>	--	
	<b>Post-build time</b>	--	

	<b>Link time</b>	--	
	<b>Post-build time</b>	--	
<b>Scope / Dependency</b>	scope: local		

<b>SWS Item</b>	<b>ECUC_FrArTp_00017 :</b>		
<b>Name</b>	FrArTpHaveTc		
<b>Parent Container</b>	FrArTpGeneral		
<b>Description</b>	Preprocessor switch for enabling Transmit Cancellation and Receive Cancellation.		
<b>Multiplicity</b>	1		
<b>Type</b>	EcucBooleanParamDef		
<b>Default value</b>	--		
<b>Post-Build Variant Value</b>	false		
<b>Value Configuration Class</b>	<b>Pre-compile time</b>	X	All Variants
	<b>Link time</b>	--	
	<b>Post-build time</b>	--	
<b>Scope / Dependency</b>	scope: local		

<b>SWS Item</b>	<b>ECUC_FrArTp_00020 :</b>		
<b>Name</b>	FrArTpMainFuncCycle		
<b>Parent Container</b>	FrArTpGeneral		
<b>Description</b>	This parameter contains the calling period of the TPs Main Function. The parameter is specified in seconds.		
<b>Multiplicity</b>	1		
<b>Type</b>	EcucFloatParamDef		
<b>Range</b>	]0 .. INF[		
<b>Default value</b>	--		
<b>Post-Build Variant Value</b>	true		
<b>Value Configuration Class</b>	<b>Pre-compile time</b>	X	VARIANT-PRE-COMPILE
	<b>Link time</b>	--	
	<b>Post-build time</b>	X	VARIANT-POST-BUILD
<b>Scope / Dependency</b>	scope: ECU		

<b>SWS Item</b>	<b>ECUC_FrArTp_00054 :</b>		
<b>Name</b>	FrArTpVersionInfoApi		
<b>Parent Container</b>	FrArTpGeneral		
<b>Description</b>	Preprocessor switch for enabling the Version info API.		
<b>Multiplicity</b>	1		
<b>Type</b>	EcucBooleanParamDef		
<b>Default value</b>	false		
<b>Post-Build Variant Value</b>	false		
<b>Value Configuration Class</b>	<b>Pre-compile time</b>	X	All Variants
	<b>Link time</b>	--	
	<b>Post-build time</b>	--	
<b>Scope / Dependency</b>	scope: local		

<b>No Included Containers</b>
-------------------------------

All parameters within section 10.2.3 are global and, of course, only present once for the whole module.

### 10.2.3 FrArTpChannel

<b>SWS Item</b>	<b>ECUC_FrArTp_00005 :</b>		
<b>Container Name</b>	FrArTpChannel		

<b>Parent Container</b>	FrArTpMultipleConfig		
<b>Description</b>	This container contains the configuration (parameters) of one FlexRay TP channel.		
<b>Post-Build Variant Multiplicity</b>	true		
<b>Multiplicity Configuration Class</b>	<b>Pre-compile time</b>	X	VARIANT-PRE-COMPILE
	<b>Link time</b>	--	
	<b>Post-build time</b>	X	VARIANT-POST-BUILD
<b>Configuration Parameters</b>			

<b>SWS Item</b>	<b>ECUC_FrArTp_00002 :</b>		
<b>Name</b>	FrArTpAckType		
<b>Parent Container</b>	FrArTpChannel		
<b>Description</b>	This parameter defines the type of acknowledgement which is used for the specific channel.		
<b>Multiplicity</b>	1		
<b>Type</b>	EcucEnumerationParamDef		
<b>Range</b>	FRARTP_ACK_WITHOUT_RT	Acknowledgement without retry	
	FRARTP_ACK_WITH_RT	Acknowledgement with retry	
	FRARTP_NO	No acknowledgement	
<b>Post-Build Variant Value</b>	true		
<b>Value Configuration Class</b>	<b>Pre-compile time</b>	X	VARIANT-PRE-COMPILE
	<b>Link time</b>	--	
	<b>Post-build time</b>	X	VARIANT-POST-BUILD
<b>Scope / Dependency</b>	scope: local		

<b>SWS Item</b>	<b>ECUC_FrArTp_00008 :</b>		
<b>Name</b>	FrArTpAdrType		
<b>Parent Container</b>	FrArTpChannel		
<b>Description</b>	This parameter states the addressing type this connection has. The meanings of the values are one byte and two byte.		
<b>Multiplicity</b>	1		
<b>Type</b>	EcucEnumerationParamDef		
<b>Range</b>	FRARTP_OB	One Byte	
	FRARTP_TB	Two Bytes	
<b>Post-Build Variant Value</b>	true		
<b>Value Configuration Class</b>	<b>Pre-compile time</b>	X	VARIANT-PRE-COMPILE
	<b>Link time</b>	--	
	<b>Post-build time</b>	X	VARIANT-POST-BUILD
<b>Scope / Dependency</b>	scope: local		

<b>SWS Item</b>	<b>ECUC_FrArTp_00057 :</b>		
<b>Name</b>	FrArTpConcurrentConnections		
<b>Parent Container</b>	FrArTpChannel		
<b>Description</b>	This parameter defines the number of connections that can be active at the same time. If set to 0, all configured connections can be active at the same time.		
<b>Multiplicity</b>	0..1		
<b>Type</b>	EcucIntegerParamDef		
<b>Range</b>	0 .. 255		
<b>Default value</b>	0		
<b>Post-Build Variant</b>	true		

<b>Multiplicity</b>			
<b>Post-Build Variant Value</b>	true		
<b>Multiplicity Configuration Class</b>	<b>Pre-compile time</b>	X	VARIANT-PRE-COMPILE
	<b>Link time</b>	--	
	<b>Post-build time</b>	X	VARIANT-POST-BUILD
<b>Value Configuration Class</b>	<b>Pre-compile time</b>	X	VARIANT-PRE-COMPILE
	<b>Link time</b>	--	
	<b>Post-build time</b>	X	VARIANT-POST-BUILD
<b>Scope / Dependency</b>	scope: local		

<b>SWS Item</b>	<b>ECUC_FrArTp_00013 :</b>		
<b>Name</b>	FrArTpGrpSeg		
<b>Parent Container</b>	FrArTpChannel		
<b>Description</b>	Here can be specified, whether segmentation within a 1:n connection is allowed or not.		
<b>Multiplicity</b>	1		
<b>Type</b>	EcucBooleanParamDef		
<b>Default value</b>	--		
<b>Post-Build Variant Value</b>	true		
<b>Value Configuration Class</b>	<b>Pre-compile time</b>	X	VARIANT-PRE-COMPILE
	<b>Link time</b>	--	
	<b>Post-build time</b>	X	VARIANT-POST-BUILD
<b>Scope / Dependency</b>	scope: local		

<b>SWS Item</b>	<b>ECUC_FrArTp_00019 :</b>		
<b>Name</b>	FrArTpLm		
<b>Parent Container</b>	FrArTpChannel		
<b>Description</b>	This specifies the maximum message length for the particular channel.		
<b>Multiplicity</b>	1		
<b>Type</b>	EcucEnumerationParamDef		
<b>Range</b>	FRARTP_ISO	Up to (2**12)-1 Byte message length (No FF-Ex or SF-E or AF shall be used and recognized)	
	FRARTP_ISO6	As ISO, but the maximum payload length is limited to 6 byte (SF-I, FF-I, CF). This is necessary to route TP on CAN when using Extended Addressing or Mixed Addressing on CAN.	
	FRARTP_L4G	SF-E allowed (SF of arbitrary length depending on FrArTpPduLength), up to (2**32)-1 byte message length (all FF-x allowed).	
<b>Post-Build Variant Value</b>	true		
<b>Value Configuration Class</b>	<b>Pre-compile time</b>	X	VARIANT-PRE-COMPILE
	<b>Link time</b>	--	
	<b>Post-build time</b>	X	VARIANT-POST-BUILD
<b>Scope / Dependency</b>	scope: local		

<b>SWS Item</b>	<b>ECUC_FrArTp_00021 :</b>		
<b>Name</b>	FrArTpMaxAr		
<b>Parent Container</b>	FrArTpChannel		
<b>Description</b>	This parameter defines the maximum number of trying to send a frame when a TIMEOUT AR occurs.		
<b>Multiplicity</b>	1		

<b>Type</b>	EcucIntegerParamDef		
<b>Range</b>	0 .. 255		
<b>Default value</b>	--		
<b>Post-Build Variant Value</b>	true		
<b>Value Configuration Class</b>	<b>Pre-compile time</b>	X	VARIANT-PRE-COMPILE
	<b>Link time</b>	--	
	<b>Post-build time</b>	X	VARIANT-POST-BUILD
<b>Scope / Dependency</b>	scope: local		

<b>SWS Item</b>	<b>ECUC_FrArTp_00022 :</b>		
<b>Name</b>	FrArTpMaxAs		
<b>Parent Container</b>	FrArTpChannel		
<b>Description</b>	This parameter defines the maximum number of trying to send a frame when a TIMEOUT AS occurs.		
<b>Multiplicity</b>	1		
<b>Type</b>	EcucIntegerParamDef		
<b>Range</b>	0 .. 255		
<b>Default value</b>	--		
<b>Post-Build Variant Value</b>	true		
<b>Value Configuration Class</b>	<b>Pre-compile time</b>	X	VARIANT-PRE-COMPILE
	<b>Link time</b>	--	
	<b>Post-build time</b>	X	VARIANT-POST-BUILD
<b>Scope / Dependency</b>	scope: local		

<b>SWS Item</b>	<b>ECUC_FrArTp_00023 :</b>		
<b>Name</b>	FrArTpMaxBs		
<b>Parent Container</b>	FrArTpChannel		
<b>Description</b>	This parameter defines the number of consecutive CFs between two FCs (block size). Valid values are 1 .. 16 when retry is activated, and 0 .. 255 otherwise.		
<b>Multiplicity</b>	1		
<b>Type</b>	EcucIntegerParamDef		
<b>Range</b>	0 .. 255		
<b>Default value</b>	--		
<b>Post-Build Variant Value</b>	true		
<b>Value Configuration Class</b>	<b>Pre-compile time</b>	X	VARIANT-PRE-COMPILE
	<b>Link time</b>	--	
	<b>Post-build time</b>	X	VARIANT-POST-BUILD
<b>Scope / Dependency</b>	scope: local		

<b>SWS Item</b>	<b>ECUC_FrArTp_00026 :</b>		
<b>Name</b>	FrArTpMaxRn		
<b>Parent Container</b>	FrArTpChannel		
<b>Description</b>	This parameter defines the maximum number of retries (if retry is configured for the particular channel).		
<b>Multiplicity</b>	1		
<b>Type</b>	EcucIntegerParamDef		
<b>Range</b>	0 .. 255		
<b>Default value</b>	--		
<b>Post-Build Variant Value</b>	true		
<b>Value Configuration Class</b>	<b>Pre-compile time</b>	X	VARIANT-PRE-COMPILE
	<b>Link time</b>	--	
	<b>Post-build time</b>	X	VARIANT-POST-BUILD
<b>Scope / Dependency</b>	scope: local		

<b>SWS Item</b>	<b>ECUC_FrArTp_00059 :</b>		
-----------------	----------------------------	--	--

<b>Name</b>	FrArTpMaxWft		
<b>Parent Container</b>	FrArTpChannel		
<b>Description</b>	This parameter defines the maximal number of wait frames to be sent for a pending connection.		
<b>Multiplicity</b>	0..1		
<b>Type</b>	EcucIntegerParamDef		
<b>Range</b>	0 .. 255		
<b>Default value</b>	--		
<b>Post-Build Variant Multiplicity</b>	true		
<b>Post-Build Variant Value</b>	true		
<b>Multiplicity Configuration Class</b>	<b>Pre-compile time</b>	X	VARIANT-PRE-COMPILE
	<b>Link time</b>	--	
	<b>Post-build time</b>	X	VARIANT-POST-BUILD
<b>Value Configuration Class</b>	<b>Pre-compile time</b>	X	VARIANT-PRE-COMPILE
	<b>Link time</b>	--	
	<b>Post-build time</b>	X	VARIANT-POST-BUILD
<b>Scope / Dependency</b>	scope: local		

<b>SWS Item</b>	<b>ECUC_FrArTp_00042 :</b>		
<b>Name</b>	FrArTpStMin		
<b>Parent Container</b>	FrArTpChannel		
<b>Description</b>	<p>This parameter defines the minimum amount of time between two succeeding CFs of a 1:1 segmented transmission in seconds. Valid values are 0, 100µs, 200µs .. 900µs, 1ms, 2ms .. 127ms. The value can be changed at runtime using the FrArTp_ChangeParameter interface. FrArTpStMin must be an integer multiple of the cycle length multiplied with the multiplexing factor, i.e. <math>FrArTpStMin = n * FrlfGdCycle * m</math>, where n is an integer <math>\geq 0</math> and m is the cycle multiplexor of those cycles where PDUs of the PDU pool are scheduled.</p> <p>Please note: Due to the scheduling strategies of FrArTp, FrArTpStMin can only be kept to a degree defined by the maximum temporal distance of the PDUs of a PDU pool within one FlexRay cycle.</p>		
<b>Multiplicity</b>	1		
<b>Type</b>	EcucFloatParamDef		
<b>Range</b>	[0 .. 0.127]		
<b>Default value</b>	--		
<b>Post-Build Variant Value</b>	true		
<b>Value Configuration Class</b>	<b>Pre-compile time</b>	X	VARIANT-PRE-COMPILE
	<b>Link time</b>	--	
	<b>Post-build time</b>	X	VARIANT-POST-BUILD
<b>Scope / Dependency</b>	scope: local		

<b>SWS Item</b>	<b>ECUC_FrArTp_00060 :</b>		
<b>Name</b>	FrArTpStMinGrpSeg		
<b>Parent Container</b>	FrArTpChannel		
<b>Description</b>	<p>This parameter defines the minimum amount of time between two succeeding CFs of a 1:n segmented transmission in seconds. Valid values are 0, 100µs, 200µs ... 900µs, 1ms, 2ms .. 127ms. The value can be changed at runtime using the FrArTp_ChangeParameter interface. FrArTpStMinGrpSeg must be an integer multiple of the cycle length multiplied with the multiplexing factor, i.e. <math>FrArTpStMinGrpSeg = n * FrlfGdCycle * m</math>, where n is an integer <math>\geq 0</math> and m is the cycle multiplexor of those cycles where PDUs of the PDU pool are scheduled.</p> <p>Please note: Due to the scheduling strategies of FrArTp,</p>		



	FrArTpStMinGrpSeg can only be kept to a degree defined by the maximum temporal distance of the PDUs of a PDU pool within one FlexRay cycle.		
<b>Multiplicity</b>	0..1		
<b>Type</b>	EcucFloatParamDef		
<b>Range</b>	[0 .. 0.127]		
<b>Default value</b>	--		
<b>Post-Build Variant Multiplicity</b>	true		
<b>Post-Build Variant Value</b>	true		
<b>Multiplicity Configuration Class</b>	<b>Pre-compile time</b>	X	VARIANT-PRE-COMPILE
	<b>Link time</b>	--	
	<b>Post-build time</b>	X	VARIANT-POST-BUILD
<b>Value Configuration Class</b>	<b>Pre-compile time</b>	X	VARIANT-PRE-COMPILE
	<b>Link time</b>	--	
	<b>Post-build time</b>	X	VARIANT-POST-BUILD
<b>Scope / Dependency</b>	scope: local		

<b>SWS Item</b>	<b>ECUC_FrArTp_00043 :</b>		
<b>Name</b>	FrArTpTc		
<b>Parent Container</b>	FrArTpChannel		
<b>Description</b>	With this switch Transmit Cancellation and Receive Cancellation can be turned on or off for this channel.		
<b>Multiplicity</b>	1		
<b>Type</b>	EcucBooleanParamDef		
<b>Default value</b>	false		
<b>Post-Build Variant Value</b>	true		
<b>Value Configuration Class</b>	<b>Pre-compile time</b>	X	VARIANT-PRE-COMPILE
	<b>Link time</b>	--	
	<b>Post-build time</b>	X	VARIANT-POST-BUILD
<b>Scope / Dependency</b>	scope: local		

<b>SWS Item</b>	<b>ECUC_FrArTp_00044 :</b>		
<b>Name</b>	FrArTpTimeBr		
<b>Parent Container</b>	FrArTpChannel		
<b>Description</b>	<p>This parameter defines the time in seconds between receiving the last CF of a block or an FF-x (or SF-x) and sending out an FC or AF. It is obvious that <math>FRARTP\_TIME\_BR + (FRARTP\_TIMEOUT\_AR * FRARTP\_MAX\_AR) &lt; FRARTP\_TIMEOUT\_BS</math> must hold (because the transmission duration on the bus has also to be considered).</p> <p>This parameter is defined in ISO 15765-2. It is contained in the configuration as a performance requirement.</p>		
<b>Multiplicity</b>	1		
<b>Type</b>	EcucFloatParamDef		
<b>Range</b>	[0 .. 65.535]		
<b>Default value</b>	--		
<b>Post-Build Variant Value</b>	true		
<b>Value Configuration Class</b>	<b>Pre-compile time</b>	X	VARIANT-PRE-COMPILE
	<b>Link time</b>	--	
	<b>Post-build time</b>	X	VARIANT-POST-BUILD
<b>Scope / Dependency</b>	scope: local		

<b>SWS Item</b>	<b>ECUC_FrArTp_00046 :</b>		
<b>Name</b>	FrArTpTimeCs		
<b>Parent Container</b>	FrArTpChannel		
<b>Description</b>	This parameter defines the time in seconds between the sending of two		

	consecutive CFs or between reception of an FC or AF and sending of the next CF . It is obvious that $FRARTP\_TIME\_CS + (FRARTP\_TIMEOUT\_AS * FRARTP\_MAX\_AS) < FRARTP\_TIMEOUT\_CR$ must hold (because the transmission duration on the bus has also to be considered).  This parameter is defined in ISO 15765-2. It is contained in the configuration as a performance requirement.		
<b>Multiplicity</b>	1		
<b>Type</b>	EcucFloatParamDef		
<b>Range</b>	[0 .. 65.535]		
<b>Default value</b>	--		
<b>Post-Build Variant Value</b>	true		
<b>Value Configuration Class</b>	<b>Pre-compile time</b>	X	VARIANT-PRE-COMPILE
	<b>Link time</b>	--	
	<b>Post-build time</b>	X	VARIANT-POST-BUILD
<b>Scope / Dependency</b>	scope: local		

<b>SWS Item</b>	<b>ECUC_FrArTp_00048 :</b>		
<b>Name</b>	FrArTpTimeoutAr		
<b>Parent Container</b>	FrArTpChannel		
<b>Description</b>	This parameter states the timeout in seconds between the PDU transmit request of the Transport Layer to the FlexRay Interface and the corresponding confirmation of the FlexRay Interface on the receiver side (for FC or AF).		
<b>Multiplicity</b>	1		
<b>Type</b>	EcucFloatParamDef		
<b>Range</b>	[0 .. 65.535]		
<b>Default value</b>	--		
<b>Post-Build Variant Value</b>	true		
<b>Value Configuration Class</b>	<b>Pre-compile time</b>	X	VARIANT-PRE-COMPILE
	<b>Link time</b>	--	
	<b>Post-build time</b>	X	VARIANT-POST-BUILD
<b>Scope / Dependency</b>	scope: local		

<b>SWS Item</b>	<b>ECUC_FrArTp_00049 :</b>		
<b>Name</b>	FrArTpTimeoutAs		
<b>Parent Container</b>	FrArTpChannel		
<b>Description</b>	This parameter states the timeout in seconds between the PDU transmit request for the first PDU of the group used in the current connection of the Transport Layer to the FlexRay Interface and the corresponding confirmation of the FlexRay Interface (when having sent the last PDU of the group used in this connection) on the sender side (SF-x, FF-x, CF).		
<b>Multiplicity</b>	1		
<b>Type</b>	EcucFloatParamDef		
<b>Range</b>	[0 .. 65.535]		
<b>Default value</b>	--		
<b>Post-Build Variant Value</b>	true		
<b>Value Configuration Class</b>	<b>Pre-compile time</b>	X	VARIANT-PRE-COMPILE
	<b>Link time</b>	--	
	<b>Post-build time</b>	X	VARIANT-POST-BUILD
<b>Scope / Dependency</b>	scope: local		

<b>SWS Item</b>	<b>ECUC_FrArTp_00050 :</b>		
<b>Name</b>	FrArTpTimeoutBs		
<b>Parent Container</b>	FrArTpChannel		

<b>Description</b>	This parameter defines the timeout in seconds for waiting for an FC or AF on the sender side in a 1:1 connection.		
<b>Multiplicity</b>	1		
<b>Type</b>	EcucFloatParamDef		
<b>Range</b>	[0 .. 65.535]		
<b>Default value</b>	--		
<b>Post-Build Variant Value</b>	true		
<b>Value Configuration Class</b>	<b>Pre-compile time</b>	X	VARIANT-PRE-COMPILE
	<b>Link time</b>	--	
	<b>Post-build time</b>	X	VARIANT-POST-BUILD
<b>Scope / Dependency</b>	scope: local		

<b>SWS Item</b>	<b>ECUC_FrArTp_00051 :</b>		
<b>Name</b>	FrArTpTimeoutCr		
<b>Parent Container</b>	FrArTpChannel		
<b>Description</b>	This parameter defines the timeout value in seconds for waiting for a CF or FF-x (in case of retry) after receiving the last CF or after sending an FC or AF on the receiver side.		
<b>Multiplicity</b>	1		
<b>Type</b>	EcucFloatParamDef		
<b>Range</b>	[0 .. 65.535]		
<b>Default value</b>	--		
<b>Post-Build Variant Value</b>	true		
<b>Value Configuration Class</b>	<b>Pre-compile time</b>	X	VARIANT-PRE-COMPILE
	<b>Link time</b>	--	
	<b>Post-build time</b>	X	VARIANT-POST-BUILD
<b>Scope / Dependency</b>	scope: local		

<b>Included Containers</b>		
<b>Container Name</b>	<b>Multiplicity</b>	<b>Scope / Dependency</b>
FrArTpConnection	1..*	This container contains the configuration (parameters) of one FlexRay TP connection. A connection can only belong to one channel.
FrArTpPdu	1..*	Container to hold the PDU parameters. ImplementationType: PduInfoType

All parameters within this section are present for each channel and read-only. They shall be placed outside the source code of the module in order to be modifiable by a flashing process without re-flashing the code itself.

### Performance Requirements according to [13]

The two parameters, FrArTpTimeBr and FrArTpTimeCs, are **not software configuration parameters**, they are contained in [13] as performance requirements. They are just for information.

## 10.2.4 FrArTpPdu

<b>SWS Item</b>	<b>ECUC_FrArTp_00029 :</b>		
<b>Container Name</b>	FrArTpPdu		
<b>Parent Container</b>	FrArTpChannel		
<b>Description</b>	Container to hold the PDU parameters. ImplementationType: PduInfoType		
<b>Post-Build Variant Multiplicity</b>	true		

<b>Multiplicity Configuration Class</b>	<b>Pre-compile time</b>	X	VARIANT-PRE-COMPILE
	<b>Link time</b>	--	
	<b>Post-build time</b>	X	VARIANT-POST-BUILD
<b>Configuration Parameters</b>			

<b>SWS Item</b>	<b>ECUC_FrArTp_00030 :</b>		
<b>Name</b>	FrArTpPduDirection		
<b>Parent Container</b>	FrArTpPdu		
<b>Description</b>	This parameter defines the direction of the PDU.		
<b>Multiplicity</b>	1		
<b>Type</b>	EcucEnumerationParamDef		
<b>Range</b>	FRARTP_RX		Received PDU
	FRARTP_TX		Transmitted PDU
<b>Post-Build Variant Value</b>	true		
<b>Value Configuration Class</b>	<b>Pre-compile time</b>	X	VARIANT-PRE-COMPILE
	<b>Link time</b>	--	
	<b>Post-build time</b>	X	VARIANT-POST-BUILD
<b>Scope / Dependency</b>	scope: local		

<b>SWS Item</b>	<b>ECUC_FrArTp_00035 :</b>		
<b>Name</b>	FrArTpPduld		
<b>Parent Container</b>	FrArTpPdu		
<b>Description</b>	<p>This is the identifier of the FlexRay Interface PDUs (Fr N-PDU, Fr L-SDU) in which the Transport Layer Frames of this channel should be transmitted. For FrArTpPduDirection == FRARTP_RX, this parameter specifies the ID that is used by FrIf when calling FrArTp_RxIndication, while for FrArTpPduDirection == FRARTP_TX this ID is used by FrIf when calling FrArTp_TxConfirmation or FrArTp_TriggerTransmit.</p> <p>ImplementationType: PduldType</p>		
<b>Multiplicity</b>	1		
<b>Type</b>	EcucIntegerParamDef (Symbolic Name generated for this parameter)		
<b>Range</b>	0 .. 65535		
<b>Default value</b>	--		
<b>Post-Build Variant Value</b>	false		
<b>Value Configuration Class</b>	<b>Pre-compile time</b>	X	All Variants
	<b>Link time</b>	--	
	<b>Post-build time</b>	--	
<b>Scope / Dependency</b>	scope: ECU		

<b>SWS Item</b>	<b>ECUC_FrArTp_00036 :</b>		
<b>Name</b>	FrArTpPduRef		
<b>Parent Container</b>	FrArTpPdu		
<b>Description</b>	--		
<b>Multiplicity</b>	1		
<b>Type</b>	Reference to [ Pdu ]		
<b>Post-Build Variant Value</b>	true		
<b>Value Configuration Class</b>	<b>Pre-compile time</b>	X	VARIANT-PRE-COMPILE
	<b>Link time</b>	--	
	<b>Post-build time</b>	X	VARIANT-POST-BUILD
<b>Scope / Dependency</b>	scope: local		

**No Included Containers**

### 10.2.5 FrArTpConnection

<b>SWS Item</b>	<b>ECUC_FrArTp_00010 :</b>		
<b>Container Name</b>	FrArTpConnection		
<b>Parent Container</b>	FrArTpChannel		
<b>Description</b>	This container contains the configuration (parameters) of one FlexRay TP connection.  A connection can only belong to one channel.		
<b>Post-Build Variant Multiplicity</b>	true		
<b>Multiplicity Configuration Class</b>	<b>Pre-compile time</b>	X	VARIANT-PRE-COMPILE
	<b>Link time</b>	--	
	<b>Post-build time</b>	X	VARIANT-POST-BUILD
<b>Configuration Parameters</b>			

<b>SWS Item</b>	<b>ECUC_FrArTp_00058 :</b>		
<b>Name</b>	FrArTpConPrioPdus		
<b>Parent Container</b>	FrArTpConnection		
<b>Description</b>	This parameter defines the number of TxNPdus to which this connection has prioritized access. It must be ensured that the number of prioritized PDUs of all connections is smaller than the total number of TxNPdus in the associated PDU pool.		
<b>Multiplicity</b>	0..1		
<b>Type</b>	EcucIntegerParamDef		
<b>Range</b>	0 .. 255		
<b>Default value</b>	0		
<b>Post-Build Variant Multiplicity</b>	true		
<b>Post-Build Variant Value</b>	true		
<b>Multiplicity Configuration Class</b>	<b>Pre-compile time</b>	X	VARIANT-PRE-COMPILE
	<b>Link time</b>	--	
	<b>Post-build time</b>	X	VARIANT-POST-BUILD
<b>Value Configuration Class</b>	<b>Pre-compile time</b>	X	VARIANT-PRE-COMPILE
	<b>Link time</b>	--	
	<b>Post-build time</b>	X	VARIANT-POST-BUILD
<b>Scope / Dependency</b>	scope: local		

<b>SWS Item</b>	<b>ECUC_FrArTp_00018 :</b>		
<b>Name</b>	FrArTpLa		
<b>Parent Container</b>	FrArTpConnection		
<b>Description</b>	This parameter defines the Local Address for the respective connection. When the local instance is the sender, this is the Source Address within the TP frame. When the local instance is the receiver, this is the Target Address within the TP frame. Note that in case of 1 byte addressing only the values from 0x0000 - 0x00FF are valid.  If this parameter is not configured, all related Rx N-SDUs must be configured to use the meta data item TARGET_ADDRESS_16, and all related Tx-N-SDUs must be configured to use the meta data item SOURCE_ADDRESS_16.		
<b>Multiplicity</b>	0..1		
<b>Type</b>	EcucIntegerParamDef		
<b>Range</b>	0 .. 65535		
<b>Default value</b>	--		

<b>Post-Build Variant Value</b>	true		
<b>Value Configuration Class</b>	<b>Pre-compile time</b>	X	VARIANT-PRE-COMPILE
	<b>Link time</b>	--	
	<b>Post-build time</b>	X	VARIANT-POST-BUILD
<b>Scope / Dependency</b>	scope: local		

<b>SWS Item</b>	<b>ECUC_FrArTp_00027 :</b>		
<b>Name</b>	FrArTpMultRec		
<b>Parent Container</b>	FrArTpConnection		
<b>Description</b>	<p>This parameter defines, whether this connection is an 1:1 ('false') or an 1:n ('true') connection.</p> <p>Of course, if the channel to which the connection is configured has retry or acknowledgement enabled, no retry or acknowledgement will occur in case the connection is an 1:n connection.</p>		
<b>Multiplicity</b>	1		
<b>Type</b>	EcucBooleanParamDef		
<b>Default value</b>	--		
<b>Post-Build Variant Value</b>	true		
<b>Value Configuration Class</b>	<b>Pre-compile time</b>	X	VARIANT-PRE-COMPILE
	<b>Link time</b>	--	
	<b>Post-build time</b>	X	VARIANT-POST-BUILD
<b>Scope / Dependency</b>	scope: local		

<b>SWS Item</b>	<b>ECUC_FrArTp_00037 :</b>		
<b>Name</b>	FrArTpRa		
<b>Parent Container</b>	FrArTpConnection		
<b>Description</b>	<p>This parameter defines the Remote Address for the respective connection. When the local instance is the sender, this is the Target Address within the TP frame.</p> <p>When the local instance is the receiver, this is the Source Address within the TP frame.</p> <p>Note that in case of 1 byte addressing only the values from 0x0000 - 0x00FF are valid.</p> <p>If this parameter is not configured, all related Rx N-SDUs must be configured to use the meta data item SOURCE_ADDRESS_16, and all related Tx-N-SDUs must be configured to use the meta data item TARGET_ADDRESS_16.</p>		
<b>Multiplicity</b>	0..1		
<b>Type</b>	EcucIntegerParamDef		
<b>Range</b>	0 .. 65535		
<b>Default value</b>	--		
<b>Post-Build Variant Value</b>	true		
<b>Value Configuration Class</b>	<b>Pre-compile time</b>	X	VARIANT-PRE-COMPILE
	<b>Link time</b>	--	
	<b>Post-build time</b>	X	VARIANT-POST-BUILD
<b>Scope / Dependency</b>	scope: local		

<b>Included Containers</b>		
<b>Container Name</b>	<b>Multiplicity</b>	<b>Scope / Dependency</b>
FrArTpRxSdu	0..1	Describes the Rx N-SDU. This N-SDU can produce meta data items of type SOURCE_ADDRESS_16 and TARGET_ADDRESS_16.
FrArTpTxSdu	0..1	Describes the Tx N-SDU. This N-SDU can consume meta data items of type SOURCE_ADDRESS_16 and TARGET_ADDRESS_16.

All parameters within this section are present for each connection and read-only. They shall be placed outside the source code of the module in order to be modifiable by a flashing process without re-flashing the code itself.

### 10.2.6 FrArTpTxSdu

<b>SWS Item</b>	<b>ECUC_FrArTp_00055 :</b>		
<b>Container Name</b>	FrArTpTxSdu		
<b>Parent Container</b>	FrArTpConnection		
<b>Description</b>	Describes the Tx N-SDU. This N-SDU can consume meta data items of type SOURCE_ADDRESS_16 and TARGET_ADDRESS_16.		
<b>Post-Build Variant Multiplicity</b>	true		
<b>Multiplicity Configuration Class</b>	<b>Pre-compile time</b>	X	VARIANT-PRE-COMPILE
	<b>Link time</b>	--	
	<b>Post-build time</b>	X	VARIANT-POST-BUILD
<b>Configuration Parameters</b>			

<b>SWS Item</b>	<b>ECUC_FrArTp_00041 :</b>		
<b>Name</b>	FrArTpSduTxId		
<b>Parent Container</b>	FrArTpTxSdu		
<b>Description</b>	This is a unique identifier for a received or a to be transmitted message. With this (and by means of e.g. a lookup table) the PDU Router can route the message appropriately without dealing with the particularities of the Transport Layer. This parameter can also be seen as the identifier of a connection. ImplementationType: PduIdType		
<b>Multiplicity</b>	1		
<b>Type</b>	EcucIntegerParamDef (Symbolic Name generated for this parameter)		
<b>Range</b>	0 .. 65535		
<b>Default value</b>	--		
<b>Post-Build Variant Value</b>	false		
<b>Value Configuration Class</b>	<b>Pre-compile time</b>	X	All Variants
	<b>Link time</b>	--	
	<b>Post-build time</b>	--	
<b>Scope / Dependency</b>	scope: ECU		

<b>SWS Item</b>	<b>ECUC_FrArTp_00052 :</b>		
<b>Name</b>	FrArTpTxSduRef		
<b>Parent Container</b>	FrArTpTxSdu		
<b>Description</b>	Reference to a PDU in the global PDU structure.		
<b>Multiplicity</b>	1		
<b>Type</b>	Reference to [ Pdu ]		
<b>Post-Build Variant Value</b>	true		
<b>Value Configuration Class</b>	<b>Pre-compile time</b>	X	VARIANT-PRE-COMPILE
	<b>Link time</b>	--	
	<b>Post-build time</b>	X	VARIANT-POST-BUILD
<b>Scope / Dependency</b>	scope: local		

**No Included Containers**

### 10.2.7 FrArTpRxSdu

<b>SWS Item</b>	<b>ECUC_FrArTp_00038 :</b>		
<b>Container Name</b>	FrArTpRxSdu		



<b>Parent Container</b>	FrArTpConnection		
<b>Description</b>	Describes the Rx N-SDU. This N-SDU can produce meta data items of type SOURCE_ADDRESS_16 and TARGET_ADDRESS_16.		
<b>Post-Build Variant Multiplicity</b>	true		
<b>Multiplicity Configuration Class</b>	<b>Pre-compile time</b>	X	VARIANT-PRE-COMPILE
	<b>Link time</b>	--	
	<b>Post-build time</b>	X	VARIANT-POST-BUILD
<b>Configuration Parameters</b>			

<b>SWS Item</b>	<b>ECUC_FrArTp_00040 :</b>		
<b>Name</b>	FrArTpSduRxId		
<b>Parent Container</b>	FrArTpRxSdu		
<b>Description</b>	This is a unique identifier for a received message. This Id is used in the CancelReceive and ChangeParameter API call. ImplementationType: PduldType		
<b>Multiplicity</b>	1		
<b>Type</b>	EcucIntegerParamDef (Symbolic Name generated for this parameter)		
<b>Range</b>	0 .. 65535		
<b>Default value</b>	--		
<b>Post-Build Variant Value</b>	false		
<b>Value Configuration Class</b>	<b>Pre-compile time</b>	X	All Variants
	<b>Link time</b>	--	
	<b>Post-build time</b>	--	
<b>Scope / Dependency</b>	scope: ECU		

<b>SWS Item</b>	<b>ECUC_FrArTp_00039 :</b>		
<b>Name</b>	FrArTpRxSduRef		
<b>Parent Container</b>	FrArTpRxSdu		
<b>Description</b>	Reference to a PDU in the global PDU structure.		
<b>Multiplicity</b>	1		
<b>Type</b>	Reference to [ Pdu ]		
<b>Post-Build Variant Value</b>	true		
<b>Value Configuration Class</b>	<b>Pre-compile time</b>	X	VARIANT-PRE-COMPILE
	<b>Link time</b>	--	
	<b>Post-build time</b>	X	VARIANT-POST-BUILD
<b>Scope / Dependency</b>	scope: local		

**No Included Containers**

### 10.2.8 FrArTpMultipleConfig

<b>SWS Item</b>	<b>ECUC_FrArTp_00028 :</b>		
<b>Container Name</b>	FrArTpMultipleConfig		
<b>Parent Container</b>	FrArTp		
<b>Description</b>	This container contains the configuration parameters and sub containers of the AUTOSAR FrArTp module.		
<b>Configuration Parameters</b>			

<b>Included Containers</b>			
<b>Container Name</b>	<b>Multiplicity</b>	<b>Scope / Dependency</b>	
FrArTpChannel	1..*	This container contains the configuration (parameters) of one FlexRay TP channel.	



### 10.3 Published Information

For details, refer to the section 10.3 “Published Information” in *SWS\_BSWGeneral*.

### 10.4 Important Issues on Configuration

#### 10.4.1 Start and Stop of the Timing Parameters

**[SWS\_FrArTp\_00169]** [Table 4 gives an overview when the time of each of these parameters start to run and when it is stopped. Note that if SF-x is mentioned it is meant in the case acknowledgement is configured (the same for AF).]()

**[SWS\_FrArTp\_00170]** [For 1:n connections only the parameters FrArTpTimeoutAs, FrArTpTimeCs (only CF) and FrArTpTimeoutCr (only CF) hold, since no flow control or acknowledgement is allowed in that case.]()

<b>Timing Parameter</b>	<b>Start</b>	<b>Stop</b>
FrArTpTimeoutAs	<i>FrIf_Transmit</i> (first PDU of the group used by the current connection)	<i>FrArTp_TxConfirmation</i> (for the last PDU of the group used by the current connection)
FrArTpTimeoutAr	<i>FrIf_Transmit</i> (FC or AF)	<i>FrArTp_TxConfirmation</i> (FC or AF)
FrArTpTimeoutBs	<i>FrArTp_TxConfirmation</i> (SF-x, FF-x or last CF of a block), <i>FrArTp_RxIndication</i> (FC or AF, both in case of FR_FS = WAIT)	<i>FrArTp_RxIndication</i> (FC or AF)
FrArTpTimeBr	<i>FrArTp_RxIndication</i> (FF-x, last CF of a block or SF-x), <i>FrArTp_TxConfirmation</i> (FC or AF, both in case of FR_FS = WAIT)	<i>FrIf_Transmit</i> (FC or AF)
FrArTpTimeoutCr	<i>FrArTp_RxIndication</i> (CF), <i>FrArTp_TxConfirmation</i> (FC or AF)	<i>FrArTp_RxIndication</i> (CF or SF-x, FF-x (the latter two in case of retry))
FrArTpTimeCs	<i>FrArTp_TxConfirmation</i> (CF), <i>FrArTp_RxIndication</i> (FC or AF (not after the last one))	<i>FrIf_Transmit</i> (CF)

**Table 4: Start and Stop of the different timeouts and times**

#### 10.4.2 How to get an ISO 15765-2 compliant Channel / Connection

**[SWS\_FrArTp\_00171]** [To achieve ISO 15765-2 compliance within a channel/connection, there are restrictions for some parameters. Those marked with a “\*” are only relevant, if the features are compiled in (see section 10.2).]()

These and those are explained in the table below:

Parameter	Allowed values
FrArTpAckType (*)	'FRARTP_NO'
FrArTpGrpSeg (*)	false
FrArTpTc (*)	false
FrArTpLm (*)	'FRARTP_ISO', 'FRARTP_ISO6'
N-PDU length	9 [FrArTpAdrType == FRARTP_OB, FrArTpLm == FRARTP_ISO6], 10 [FrArTpAdrType == FRARTP_OB, FrArTpLm == FRARTP_ISO], 11 [FrArTpAdrType == FRARTP_TB, FrArTpLm == FRARTP_ISO6], 12 [FrArTpAdrType == FRARTP_TB, FrArTpLm == FRARTP_ISO]

**Table 5: Parameter Setting for ISO 15765-2 compliance**

All not mentioned parameters can have arbitrary values.

### 10.4.3 Dependencies among the Parameters

**[SWS\_FrArTp\_00172]** 「There are several dependencies among the connection specific and channel specific configuration parameters:」()

- If FrArTpMultRec sets the connection to be a 1:1 connection, then the value of FrArTpGrpSeg does not play a role for this connection since it is only relevant for 1:n connections.
- If FrArTpMultRec sets the connection to be a 1:n connection, then the values of FrArTpAckType, FrArTpMaxBs, and FrArTpMaxRn do not play a role for this connection, since they are only relevant for 1:1 connections.
- If FrArTpMultRec sets the connection to be a 1:n connection or FrArTpAckType does not activate retry (FRARTP\_NO, FRARTP\_ACK\_WITHOUT\_RT) then the value of FrArTpMaxBs does not play a role for this connections since it is only relevant in 1:1 connections within channels with retry being activated.

### 10.4.4 Timing Constraints

The following Constraints shall hold for the Timing parameters:

**[SWS\_FrArTp\_00242]**  $\lceil V_E + FrArTpTimeBr + (FrArTpTimeoutAr * FrArTpMaxAr) + V_S < FrArTpTimeoutBs \rceil()$

**[SWS\_FrArTp\_00243]**  $\lceil V_S + FrArTpTimeCs + (FrArTpTimeoutAs * FrArTpMaxAs) + V_E < FrArTpTimeoutCr \rceil()$

Where  $v_B$  is the time from starting the BS timer until recognition of the frame in the receiver TP and  $v_S$  is the time from starting the CR timer until recognition of the frame in the sender TP.

#### 10.4.5 Configuration Requirements on the FlexRay AUTOSAR Transport Layer

**[SWS\_FrArTp\_00180]**  $\lceil$  It has to be assured, that  $FrArTpStMin < FrArTpTimeoutCr$  since there will always be a timeout of the latter one otherwise.  $\rfloor$ (SRS\_BSW\_00159)

**[SWS\_FrArTp\_00181]**  $\lceil$  The configuration of a connection and a channel shall be, of course, the same at the sender and the receiver side. Only the values of  $FrArTpLa$  and  $FrArTpRa$  are swapped.  $\rfloor$ (SRS\_BSW\_00159)

**[SWS\_FrArTp\_00275]**  $\lceil$  If a channel references one PDU of a certain direction (received or transmitted) that is also referenced by another channel, both channels must reference exactly the same set of PDUs for this direction. This restriction ensures the pool semantics of referenced PDUs.  $\rfloor$ ()

**[SWS\_FrArTp\_00276]**  $\lceil$  All PDUs of a PDU pool must have the same size, and all channels that reference these PDUs must have the same addressing type.  $\rfloor$ ()

**[SWS\_FrArTp\_00277]**  $\lceil$  In the set of connections that are associated with a PDU pool, no two connections have the same address information, not even with reversed addresses.  $\rfloor$ ()

**[SWS\_FrArTp\_00278]**  $\lceil$  The number of prioritized PDUs of all connections associated with a PDU pool must be less than the number of PDUs in the pool; otherwise, a set of active prioritized connections can lead to timeout in other connections.  $\rfloor$ ()

#### 10.4.6 Configuration Requirements on the FlexRay Interface

**[SWS\_FrArTp\_00174]**  $\lceil$  If more than one N-PDU is used for one N-SDU within a connection, the FrIf shall guarantee, that the N-PDUs (L-SDUs) are scheduled (sent over the bus) in the same order the FlexRay AUTOSAR Transport Layer uses them, i.e. in ascending order regarding the N-PDU IDs used in the FlexRay AUTOSAR Transport Layer. To simplify configuration, all PDUs of a pool shall be arranged such that they are always received in the same order in which they have been transmitted, independent of the current cycle in the FlexRay communication round.  $\rfloor$ ()

This is necessary to avoid CFs coming out of order in a segmented transfer.

**[SWS\_FrArTp\_00175]** 「For every FrArTp L-SDU the PDU-Update/Valid Information of the FrIf shall be activated unless this is the only PDU in a frame.」()

This is necessary to avoid Rx-Indication at the FrArTp for in the current transfer not used N-PDUs or if e.g. in every 2<sup>nd</sup> FlexRay bus cycle an N-PDU is scheduled.

**[SWS\_FrArTp\_00182]** 「For the last PDU (in temporal order) of each PDU pool, a TxConfirmation shall be configured.」()

## 11 Not applicable requirements

**[SWS\_FrArTp\_00999]** 「These requirements are not applicable to this specification.」

(BSW00161, BSW00162, BSW00172, SRS\_BSW\_00301, SRS\_BSW\_00302, SRS\_BSW\_00307, SRS\_BSW\_00321, SRS\_BSW\_00325, SRS\_BSW\_00326, SRS\_BSW\_00334, SRS\_BSW\_00335, SRS\_BSW\_00339, SRS\_BSW\_00341, SRS\_BSW\_00342, SRS\_BSW\_00344, SRS\_BSW\_00347, SRS\_BSW\_00348, SRS\_BSW\_00375, SRS\_BSW\_00395, SRS\_BSW\_00400, SRS\_BSW\_00405, SRS\_BSW\_00409, SRS\_BSW\_00412, SRS\_BSW\_00415, SRS\_BSW\_00416, SRS\_BSW\_00417, SRS\_BSW\_00419, SRS\_BSW\_00422, SRS\_BSW\_00425, SRS\_BSW\_00426, SRS\_BSW\_00427, SRS\_BSW\_00428, SRS\_BSW\_00429, BSW00431, SRS\_BSW\_00433, BSW00434, SRS\_BSW\_00005, SRS\_BSW\_00010, SRS\_BSW\_00164, SRS\_BSW\_00168, and SRS\_BSW\_00170)