

Document Title	Software Component Template
Document Owner	AUTOSAR
Document Responsibility	AUTOSAR
Document Identification No	62

Document Status	published
Part of AUTOSAR Standard	Classic Platform
Part of Standard Release	R19-11

Document Change History			
Date	Release	Changed by	Description
2019-11-28	R19-11	AUTOSAR Release Management	<ul style="list-style-type: none"> • Support for optimized access to coding data • Support for meta-data on application level • Support for optimized storing of bitfields in NvRAM • minor corrections / clarifications / editorial changes; For details please refer to the ChangeDocumentation • Changed Document Status from Final to published
2018-10-31	4.4.0	AUTOSAR Release Management	<ul style="list-style-type: none"> • Support for optional elements in structured data types • Improved description of service use cases • minor corrections / clarifications / editorial changes; For details please refer to the ChangeDocumentation
2017-12-08	4.3.1	AUTOSAR Release Management	<ul style="list-style-type: none"> • minor corrections / clarifications / editorial changes; For details please refer to the ChangeDocumentation

2016-11-30	4.3.0	AUTOSAR Release Management	<ul style="list-style-type: none"> • Improved support for Unions • Improved upstream mapping • Improved description of service use cases • Minor corrections / clarifications / editorial changes; For details please refer to the ChangeDocumentation
2015-07-31	4.2.2	AUTOSAR Release Management	<ul style="list-style-type: none"> • Minor corrections / clarifications / editorial changes; For details please refer to the ChangeDocumentation
2014-10-31	4.2.1	AUTOSAR Release Management	<ul style="list-style-type: none"> • Efficient NV data handling • Introduction of data transformation • Support for variable-size Arrays of arbitrary data types • Support for ASIL/QM development • Minor corrections / clarifications / editorial changes; For details please refer to the BWCStatement
2014-03-31	4.1.3	AUTOSAR Release Management	<ul style="list-style-type: none"> • Various fixes and clarifications
2013-10-31	4.1.2	AUTOSAR Release Management	<ul style="list-style-type: none"> • Various fixes and clarifications

2013-03-15	4.1.1	AUTOSAR Administration	<ul style="list-style-type: none"> • Introduction of PRPortPrototype • Definition of implicit communication behavior • Support for the formal analysis of resource locking • Introduction of refined scheduling of RunnableEntityS • Get information about activating RTEEvent • Connection of Mode Managers and Mode Users with different number of ModeDeclarations • Support activation of RunnableEntityS on remote ECUs • Support for ModeTransition • Support for the definition of the network representation of composite data types • ServiceNeeds for diagnostics over IP • Various fixes and clarifications
2011-12-22	4.0.3	AUTOSAR Administration	<ul style="list-style-type: none"> • Added <code>CompuMethod</code> categories <code>SCALE_LINEAR_AND_TEXTTABLE</code> and <code>SCALE_RATIONAL_AND_TEXTTABLE</code> (table 5.78) • Clarification concerning the usage of invalid values • Revised support for data filters • Support for partial networking • Support for the specification of local connections between software-components • Improved description of service needs • Change history of constraints and specification items • Miscellaneous improvements and clarifications • “Support for Standardization” moved to Standardization Template [1]

2011-04-15	4.0.2	AUTOSAR Administration	<ul style="list-style-type: none"> • Remove restriction on data type of inter-runnable variables • Rework end-to-end communication protection • Add more constraints on the usage of the meta-model • Various fixes and clarifications
2009-12-18	4.0.1	AUTOSAR Administration	<ul style="list-style-type: none"> • New requirements tracing table • Support for fixed data exchange • Implementation of meta-model cleanup • Fundamental revision of the data type concept • Support for variant handling • Support for end-to-end communication protection • Support for documentation • Support for stopping and restarting of software-components • Support for triggered events • Support for explicit mapping of interface elements • Revised concept of mode management • Support for integrity and scaling at ports • Support for standardization within AUTOSAR
2008-08-13	3.1.1	AUTOSAR Administration	<ul style="list-style-type: none"> • Improved support for on-board diagnostics • Small layout adaptations made
2007-12-21	3.0.1	AUTOSAR Administration	<ul style="list-style-type: none"> • Improved support for measurement and calibration • Improved semantics of delegation ports • Introduction of abstract memory classes • Document meta information extended • Small layout adaptations made

2007-01-24	2.1.15	AUTOSAR Administration	<ul style="list-style-type: none"> • Harmonization of the document with other specifications (e.g. RTE) • Introduction of a new concept to support calibration and measurement - harmonized with RTE • Description of needs of the Software Component Template toward AUTOSAR services and of the interaction of the Software Component Template and services (on XML level) • Legal disclaimer revised • Release notes added • “Advice for users” added • “Revision information” added
2006-05-16	2.0.0	AUTOSAR Administration	Second
2005-05-31	1.0.0	AUTOSAR Administration	Initial release

Disclaimer

This work (specification and/or software implementation) and the material contained in it, as released by AUTOSAR, is for the purpose of information only. AUTOSAR and the companies that have contributed to it shall not be liable for any use of the work.

The material contained in this work is protected by copyright and other types of intellectual property rights. The commercial exploitation of the material contained in this work requires a license to such intellectual property rights.

This work may be utilized or reproduced without any modification, in any form or by any means, for informational purposes only. For any other purpose, no part of the work may be utilized or reproduced, in any form or by any means, without permission in writing from the publisher.

The work has been developed for automotive applications only. It has neither been developed, nor tested for non-automotive applications.

The word AUTOSAR and the AUTOSAR logo are registered trademarks.

Table of Contents

1	Introduction	28
1.1	Overview	28
1.2	Scope	28
1.3	Organization of the Meta-Model	29
1.4	Structure of the Template	31
1.4.1	Description of Software Components on VFB Level	31
1.4.2	Description of Software Components on RTE Level	31
1.4.3	Descriptions of Software Components on Implementation Level	32
1.5	Abbreviations	32
1.6	Document Conventions	34
1.7	Requirements Tracing	35
2	Conceptual Aspects	43
2.1	Introduction	43
2.2	Measurement and Calibration	43
2.2.1	Basic Approach of Measurement and Calibration	43
2.2.2	Calibration Parameters Overview	43
2.2.3	Using Calibration Parameters	44
2.2.3.1	Sharing Calibration Parameters within Compositions	44
2.2.3.2	Sharing Calibration Parameters between SwComponentPrototypes of the Same SwComponentType	47
2.2.3.3	Providing Instance Individual Characteristic Data	48
2.3	Runtime and Data Consistency Aspects	49
2.3.1	Background: the Issues	49
2.3.1.1	Mutual Exclusion with Semaphores	50
2.3.1.2	Interrupt Disabling	50
2.3.1.3	Priority Ceiling	51
2.3.1.4	Implicit Communication by Means of Variable Copies	51
2.3.2	Data Consistency at Runtime	52
2.3.3	Modeling Aspects of Data Consistency	52
2.4	Variant Handling in the Software Component Template	53
2.5	Communication Specification of Composition Component Types	55
2.5.1	Rationale	55
2.6	PRPortPrototype	57
2.6.1	Use Case 1	57
2.6.2	Use Case 2	57
2.6.3	Use Case 3	58
2.6.4	Solution	59
2.7	Pretended Networking	59
2.8	Variable-size Array Data Types	61
2.8.1	Overview and Use cases	61
2.8.1.1	“Old-world” dynamic-size Arrays	61
2.8.1.2	“New-world” variable-size Arrays	62
2.8.2	Modeling Aspects regarding Application Data Types	65

2.8.3	Modeling Aspects regarding Implementation Data Types . . .	66
2.9	Optional Elements in Structures	67
2.9.1	Background	67
3	Overview: Software Components, Ports, and Interfaces	69
3.1	Introduction	69
3.2	Software Component	69
3.2.1	Overview	69
3.2.2	PortPrototype	71
3.2.3	AtomicSwComponentType	75
3.2.4	ParameterSwComponentType	78
3.2.5	Symbolic Name of a Software-Component	78
3.3	Composition	80
3.3.1	Overview	80
3.3.2	SwComponentPrototype	81
3.3.3	Connectors	84
3.3.4	Instantiation-specific RTEEvents	89
3.4	Port Interface	91
4	Details: Software Components, Ports, and Interfaces	97
4.1	Introduction	97
4.2	Port Interface Details	97
4.2.1	Introduction	97
4.2.2	Sender Receiver Communication	98
4.2.2.1	Sender Receiver Interface	98
4.2.2.2	Meta-data on the Application Software Level	102
4.2.3	Client Server Communication	104
4.2.3.1	Client Server Interface	104
4.2.3.2	Error Handling in Client/Server Communication	109
4.2.4	External Trigger Event Communication	111
4.2.5	Communication of Modes	114
4.2.6	Parameter Communication	121
4.3	PortInterface Mapping and Data Scaling	121
4.3.1	PortInterface Mapping	123
4.3.1.1	Mapping of Sender Receiver Interface, Parameter In- terface and Non Volatile Data Interface Elements	125
4.3.1.2	Mapping of Client Server Interface Elements	127
4.3.1.3	Mapping of Mode Interface Elements	131
4.3.1.4	Mapping of Trigger Interface Elements	135
4.3.1.5	Mapping of Elements of a composite Data Type	136
4.3.2	Data Conversion	143
4.3.2.1	Linear Data Scaling	144
4.3.2.2	Table Conversion	146
4.3.3	Relevance for Data Transformation	150
4.4	Port Annotation	153
4.4.1	Introduction	153
4.4.2	SenderReceiverAnnotation	155

4.4.3	ClientServerAnnotation	159
4.4.4	Annotation for the I/O Hardware Abstraction Layer	160
4.4.5	Parameter Port Annotation	162
4.4.6	Mode Port Annotation	163
4.4.7	Trigger Port Annotation	164
4.4.8	Non Volatile Data Port Annotation	165
4.4.9	Delegated Port Annotations	166
4.4.10	General Annotation	167
4.5	Communication Specification	168
4.5.1	Communication Specification for Sender-Receiver Communication	172
4.5.2	Communication Specification for Client-Server Communication	185
4.5.3	Communication Specification for Mode Switch Communication	188
4.5.4	Communication Specification for Parameters	191
4.5.5	Communication Specification for NV Data	193
4.5.6	Configuration of Data Transformation	196
4.6	Port Groups within Component Types	202
4.7	End to End Protection	204
4.8	Partial Networking	214
4.8.1	VFC Control Ports	215
4.8.2	VFC Status Ports	216
4.9	Formal Definition of implicit Communication Behavior	217
4.9.1	Consistency Needs on Receiver Side	221
4.9.2	Consistency Needs on Sender Side	222
4.9.3	Consistency Needs for Senders and receivers of the same Data inside on RunnableEntityGroup	223
5	Data Description	224
5.1	Introduction	224
5.2	Data Types	228
5.2.1	Overview	228
5.2.2	Data Type Mapping	230
5.2.3	Data Categories	234
5.2.4	Application Data Type	238
5.2.4.1	Application Primitive Data Types	241
5.2.4.2	Application Composite Data Types	258
5.2.5	Implementation Data Type	273
5.2.5.1	Modeling of Optional Element Structure with ImplementationDataType	297
5.2.6	Base Type	299
5.2.7	Data Type Terminology	305
5.2.7.1	Primitive Type	305
5.2.7.2	Compound Primitive Data Type	306
5.2.7.3	Integral Primitive Type	306
5.2.7.4	Variable-Size Array Data Type	308
5.2.7.5	Wrapped Union Data Type	308

5.2.7.6	Optional Element Structure	311
5.3	Data Prototypes	311
5.3.1	Overview	311
5.3.2	Data Constraints for DataPrototypes typed by Array DataTypes	319
5.3.3	Reference to Data Prototypes	321
5.3.3.1	AUTOSAR Variable Ref	322
5.3.3.2	AUTOSAR Parameter Ref	323
5.3.3.3	Modeling Approach	325
5.3.3.4	Access into VariableDataPrototype typed by an ImplementationDataType	327
5.3.3.5	Access into ParameterDataPrototype typed by an ImplementationDataType	330
5.4	Properties of Data Definitions	332
5.4.1	Overview	332
5.4.2	Invalid Value	346
5.4.3	Properties for Measurement	352
5.4.4	Properties of Curves and Maps	353
5.4.4.1	Specification of fix Axes	363
5.4.5	Setting an Axis Input Value	369
5.4.6	Setting a Group Axis	374
5.4.7	Specifying Data Dependencies	380
5.4.8	Precedence of data properties with respect to data elements, axis elements, computation methods, units	383
5.5	Elements used in Properties of Data Definitions	388
5.5.1	Computation Methods	388
5.5.1.1	Category Values in the context of a CompuMethod	400
5.5.1.2	Applicability of Attributes in the context of a CompuMethod	401
5.5.1.3	CompuMethod and AutosarDataType	403
5.5.1.4	Example for Enumeration	405
5.5.1.5	Example for Linear Conversion	406
5.5.1.6	Example for Linear Conversion with texttable	406
5.5.1.7	Example for conversion specified by a rational function	407
5.5.1.8	Example for BITFIELD_TEXTTABLE	408
5.5.2	Physical Units, Physical Dimensions and Unit Groups	411
5.5.3	Data Constraints	419
5.5.3.1	Physical Limits	426
5.5.4	Addressing Methods	427
5.5.5	Record Layouts	435
5.5.5.1	Specifying Record Layouts	436
5.5.5.2	RecordLayouts and DataTypes	445
5.5.5.3	Record Layouts and Interpolation Routines	453
5.5.6	Display Presentation	455
5.6	Specification of Constant Values	457
5.6.1	Overview	457
5.6.2	Specification of Values based on Rules	463

5.6.2.1	Support for primitive Data Types	463
5.6.2.2	Support for composite Data Types	470
5.6.3	Reference to Constant	475
5.6.4	Values for Variable-Size Array	475
5.6.5	Values for Compound Primitive Data Types	478
5.6.6	Values for BITFIELD_TEXTTABLE	486
5.6.7	Examples	488
5.6.7.1	Example for Constant Specification for CURVE	488
5.6.7.2	Example for Constant Specification for MAP	489
5.6.7.3	Example for Constant Specification for MAP with two STD_AXIS	490
5.6.7.4	Example for Constant Specification for COM_AXIS	491
5.7	Initial Values	492
5.7.1	Overview	492
5.7.2	Initial Value Representation	493
5.7.3	Constant Specification Mapping	495
5.7.4	Initial Values For CalibrationParameters	497
5.7.5	Initial Value for optional Element	499
5.7.5.1	Initial Value for optional ApplicationRecordElement	499
5.7.5.2	Initial Value for optional ImplementationDataType-Element	499
6	Compatibility	501
6.1	Introduction	501
6.2	Compatibility of Data Types	501
6.2.1	ApplicationDataType	501
6.2.1.1	ApplicationPrimitiveDataType	501
6.2.1.2	ApplicationCompositeDataType	502
6.2.2	ImplementationDataType	503
6.2.3	Compatibility of SwBaseType	505
6.2.4	Compatibility of SwDataDefProps	505
6.2.4.1	Compatibility of Units	506
6.2.4.2	Compatibility of PhysicalDimensions	507
6.2.4.3	Compatibility of Data Constraints	508
6.2.4.4	Compatibility in case of ImplementationDataType	508
6.2.4.5	Compatibility of CompuMethods	509
6.2.4.6	Compatibility of Record Layouts	511
6.2.5	Compatibility of ApplicationDataType and Implementation-DataType	512
6.3	Compatibility of Variable Data Prototypes and Parameter Data Prototypes	515
6.4	Compatibility of Sender Receiver Interfaces, Parameter Interfaces and Non Volatile Data Interfaces	517
6.4.1	Connection of Required and Provided Port via AssemblySwConnector	517
6.4.2	Connection of Inner and Outer Port via DelegationSwConnector	518

6.4.3	Connection of Required and Provided Port via PassThroughSwConnector	519
6.4.4	Compatibility of ParameterDataPrototype and VariableDataPrototype depending on PortInterface Type	520
6.5	Compatibility of Mode Switch Interfaces	521
6.5.1	Connection of Required and Provided Port via AssemblySwConnector	521
6.5.2	Connection of Inner and Outer Port via DelegationSwConnector	522
6.5.3	Connection of Outer and Outer Port via PassThroughSwConnector	522
6.6	Compatibility of Mode Declaration Group Prototypes	523
6.7	Compatibility of Mode Declaration Groups	523
6.8	Compatibility of Argument Prototypes	524
6.9	Compatibility of Application Errors	525
6.10	Compatibility of Client/Server Operations	525
6.11	Compatibility of Client Server Interfaces	526
6.11.1	Connection of Required and Provided Port via AssemblySwConnector	526
6.11.2	Connection of Inner and Outer Port via DelegationSwConnector	526
6.11.3	Connection of Outer and Outer Port via PassThroughSwConnector	527
6.12	Compatibility of Trigger Interfaces	527
6.12.1	Connection of Required and Provided Port via AssemblySwConnector	528
6.12.2	Connection of Inner and Outer Port via DelegationSwConnector	528
6.12.3	Connection of Outer and Outer Port via PassThroughSwConnector	529
6.13	Compatibility of Trigger	529
6.14	Entire Delegation of a Provided Port Prototype	529
6.14.1	Split and Merge of PortInterface Elements	531
6.15	Compatibility in Case of a Flat ECU Extract	531
6.16	Compatibility Examples	532
6.16.1	Compatibility on Assembly Level	532
6.16.1.1	Legal Use	532
6.16.1.2	Illegal Use	533
6.16.2	Compatibility on Delegation Level	534
6.16.2.1	Legal Use	534
6.16.2.2	Illegal Use	537
7	Internal Behavior	540
7.1	Introduction	540
7.2	Runnable Entity	546

7.2.1	Concurrency and Reentrancy of a RunnableEntity that cannot be Invoked Concurrently	553
7.2.2	Concurrency and Reentrancy of a RunnableEntity that can be Invoked Concurrently	554
7.2.3	Timed Activation of Runnable Entities	555
7.2.4	Additional Remarks and Clarifications	557
7.2.4.1	Reentrancy and Multiple Instantiation	557
7.2.4.2	Reentrancy and “Library Functions”	557
7.2.4.3	Compatibility of ClientServerOperations triggering the same RunnableEntity	558
7.2.4.4	Categories of Runnable Entities	559
7.2.4.5	Arguments of a Runnable Entity	560
7.2.5	Activation Reason of a Runnable Entity	561
7.2.6	Runnable Entity for Initialization Purpose	564
7.3	RTEEvent	565
7.3.1	Defining an Event	571
7.3.2	Defining how to Respond to an Event	573
7.4	Communication among Runnable Entities	575
7.4.1	Description Possibility 1: Exclusive Area	576
7.4.1.1	Entire Runnable Runs in the Exclusive Area	580
7.4.1.2	Runnable would Dynamically Enter and Leave the Exclusive Area	580
7.4.1.3	Configuration of API Generation	581
7.4.2	Description Possibility 2: Inter-Runnable Variable	582
7.4.3	Inter Runnable Triggering	585
7.5	Data Access of RunnableEntities	587
7.5.1	RunnableEntities and Sender Receiver Communication	590
7.5.1.1	Terminology	590
7.5.1.2	Data Access	591
7.5.1.3	Explicit Sending and Receiving	594
7.5.1.4	Implicit Sending and Receiving	598
7.5.1.5	DataSendCompletedEvent	599
7.5.1.6	DataWriteCompletedEvent	599
7.5.1.7	DataReceivedEvent	601
7.5.1.8	DataReceiveErrorEvent	601
7.5.2	RunnableEntities and Client Server Communication	603
7.5.2.1	Invoking an Operation	603
7.5.2.2	Providing an Implementation of an Operation	607
7.5.2.3	Reacting on Data Transformation Errors	608
7.5.3	RunnableEntities and External Trigger Event Communication	609
7.5.3.1	Trigger Source	609
7.5.3.2	Trigger Sink	611
7.5.4	RunnableEntities and Parameter Access	612
7.5.4.1	InstantiationDataDefProps	614
7.5.5	RunnableEntities and Mode Communication	616
7.6	Port API Options	617

7.6.1	Enable to Take Address	619
7.6.2	Indirect API Generation	619
7.6.3	Port Defined Argument Value	620
7.6.4	Supported Features	621
7.6.4.1	Buffer Locking	622
7.7	PerInstanceMemory	622
7.7.1	PerInstanceMemory typed by “C” Data Types	624
7.7.2	PerInstanceMemory typed by AUTOSAR Data Types	625
7.8	Static Memory and Constant Memory	625
7.9	Included AUTOSAR Data Types	627
7.10	Included Mode Declaration Groups	628
7.11	Service Needs	630
7.11.1	Overview	630
7.11.2	Assignment of Service Needs to Ports and Data	636
7.12	Variation Point Proxy	645
8	Implementation	652
9	Mode Management	656
9.1	Declaration of Modes	656
9.2	Modes and Events	661
9.3	Initialization / Finalization	666
9.4	Mode Error Behavior	666
9.5	Summary Meta-Model Excerpt Related to Modes	670
10	ECU Abstraction and Complex Drivers	673
10.1	Introduction	673
10.2	High Level Hardware and Software Architecture	673
10.3	Interfaces and APIs	676
10.3.1	ECU Abstraction and its AUTOSAR Interfaces	677
10.4	Sensors/Actuators	678
10.5	I/O Hardware Abstraction	679
10.6	Complex Driver	681
11	Services	683
11.1	Overview: Generation of Service-related Model Elements	683
11.2	Extending the ECU Software Composition	686
11.3	Service Software Component Type	687
11.4	Service Proxy Component Type	690
11.5	Non Volatile Memory	693
11.5.1	Introduction	693
11.5.2	NvBlockComponent	693
11.5.3	Software-Components using <i>NVRAM data</i> of NvBlockCom- ponents	695
11.5.4	Software-Components connected to NvBlockComponents	699
11.5.5	NvBlockDescriptor	701
11.5.5.1	Writing Strategies	705

11.5.5.2	NvBlockNeeds	713
11.5.5.3	RAM Block and ROM Block	715
11.5.5.4	NvBlockDataMapping	716
11.5.5.5	Client Server Ports	725
11.5.6	BulkNvDataDescriptor	727
11.5.7	SwcInternalBehavior of an NvBlockSwComponentType	730
12	Software Component Documentation	734
13	Service Dependencies and Service Use Cases	738
13.1	Overview	738
13.2	NvM Service Dependencies	738
13.2.1	Nvm Use Case: Permanent RAM Block	739
13.2.2	Nvm Use Case: Temporary RAM Block	740
13.2.3	Nvm Use Case: RAM Block with explicit synchronization using Mirror Interfaces	741
13.2.4	NVM Use Case: Software-Components using Nv Data provided by NvBlockSwComponentType (not ServiceSwComponent of NvM)	742
13.3	Watchdog Service Dependencies	743
13.3.1	Watchdog Service use Case: Local Supervision	743
13.3.2	Watchdog Service use Case: <i>Global Supervision Status</i> notification	746
13.3.3	Watchdog Service use Case: Control global supervision or get global supervision status	746
13.4	COM Manager Service Needs	747
13.4.1	ComM Use Case: read current ComM Mode	748
13.4.2	ComM Use Case: request ComM Mode	748
13.4.3	ComM Use Case: Software-Component acts as a Mode Manager that influences the ECU State	749
13.5	ECU State Manager Service Needs	749
13.5.1	EcuM Use Case: select Shutdown Target	750
13.5.2	EcuM Use Case: select Boot Target	750
13.5.3	EcuM Use Case: use Alarm Clock	751
13.6	BswM	751
13.6.1	Partial Networking	751
13.6.2	Mode Manager	752
13.6.3	Mode User	754
13.6.4	Mode Requester	755
13.7	Crypto Service Dependencies	755
13.7.1	Overview	755
13.7.2	Crypto Service Use Cases	757
13.7.2.1	Crypto Service Use Case: Hash calculation	757
13.7.2.2	Crypto Service Use Case: MAC calculation	758
13.7.2.3	Crypto Service Use Case: MAC verification	758
13.7.2.4	Crypto Service Use Case: generation of random numbers	759

13.7.2.5	Crypto Service Use Case: Encryption with Authenticated Encryption with Associated Data (AEAD) . . .	760
13.7.2.6	Crypto Service Use Case: Decryption with Authenticated Encryption with Associated Data (AEAD) . . .	760
13.7.2.7	Crypto Service Use Case: encryption	761
13.7.2.8	Crypto Service Use Case: decryption	761
13.7.2.9	Crypto Service Use Case: signature generation . . .	762
13.7.2.10	Crypto Service Use Case: signature verification . . .	763
13.7.2.11	Crypto Service Use Case: usage of key management	763
13.7.3	Crypto Service Job Use Cases	764
13.7.3.1	Crypto Service Use Case: usage of job API to set key valid	764
13.7.3.2	Crypto Service Use Case: usage of job API to create a random seed	764
13.7.3.3	Crypto Service Use Case: usage of job API to generate a key	765
13.7.3.4	Crypto Service Use Case: usage of job API to derive a key	765
13.7.3.5	Crypto Service Use Case: usage of job API to execute calculation of the public value for key exchange	766
13.7.3.6	Crypto Service Use Case: usage of job API to execute calculation of shared secret for key exchange .	767
13.7.3.7	Crypto Service Use Case: usage of job API to execute certificate parsing	767
13.7.3.8	Crypto Service Use Case: usage of job API to execute certificate verification	768
13.8	Diagnostic Service Dependency	768
13.8.1	Development Approach	769
13.8.2	Function Inhibition Needs	770
13.8.2.1	Function Inhibition Manager Service use Case: read function permission	772
13.8.2.2	Function Inhibition Manager Use Case: react on suppressed or unavailable events	772
13.8.3	Diagnostic Event Needs	773
13.8.3.1	Dem Service Use Case: diagnostic monitor, debouncing by Dem	784
13.8.3.2	Dem Service Use Case: diagnostic monitor, debouncing by SWC	785
13.8.3.3	Dem Service Use Case: software-component provides information about operation cycles	786
13.8.3.4	Dem Service Use Case: software-component enables reporting of DTCs in general	786
13.8.3.5	Dem Service Use Case: software-component enables storage of subsequent DTCs	787
13.8.3.6	Dem Service Use Case: retrieve information of the lamp status	787

13.8.3.7	Dem Service Use Case: DEM provides information that the fault storage overflows	788
13.8.3.8	Dem Service Use Case: software-component suppresses the storage of DTCs	789
13.8.3.9	Dem Service Use Case: software-component informs that the PTO is active	789
13.8.3.10	Dem Service Use Case: software-component needs information about any DTC status change	790
13.8.3.11	Dem Service Use Case: call operation if the data of a given diagnostic event changes (I)	790
13.8.3.12	Dem Service Use Case: call operation if the data or status of any diagnostic event changes (II)	791
13.8.3.13	Dem Service Use Case: software-component provides data for diagnostic purposes	792
13.8.3.14	Dem Service Use Case: software-component gets information about a specific DTC	792
13.8.3.15	Dem Service Use Case: Software-Component wants to be triggered on Monitor Status Changes	793
13.8.3.16	Dem Service Use Case: write parameter identifier by software-component	793
13.8.3.17	Dem Service Use Case: read parameter identifier by software-component	794
13.8.3.18	Dem Service Use Case: diagnostic monitor provides monitor data, debouncing by Dem	795
13.8.3.19	Dem Service Use Case: diagnostic monitor provides monitor data, debouncing by software-component	795
13.8.4	Diagnostic Communication Needs	796
13.8.4.1	Dcm Service Use Case: read/write current values by Client Server Interface	801
13.8.4.2	Dcm Service Use Case: read/write current values of specific DID by Client Server Interface	802
13.8.4.3	Dcm Service Use Case: read/write current values by Sender Receiver Interface	802
13.8.4.4	Dcm Service Use Case: start/stop or request routine results	803
13.8.4.5	Dcm Service Use Case: IO control by Client Server Interface	804
13.8.4.6	Dcm Service Use Case: IO control by Sender Receiver Interface	805
13.8.4.7	Dcm Service Use Case: Access to protocol, session and security information	808
13.8.4.8	Dcm Service Use Case: Verify the access to security level	808
13.8.4.9	Dcm Service Use Case: multiple testers access one ECU	809
13.8.4.10	Dcm Service Use Case: Service Request Notification	809

13.8.4.11	Dcm Service Use Case: read/write and IOCtrl current values by Client Server Interface	810
13.8.4.12	Dcm Service Use Case: A software-component acts as a "file server" to a diagnostic tester	811
13.8.5	OBd related Needs	812
13.8.5.1	Dem Service Use Case: In-Use-Monitor Performance Ratio calculation	815
13.8.5.2	Dcm Service Use Case: read parameter identifier via diagnostic services by Client Server Interface	816
13.8.5.3	Dcm Service Use Case: read parameter identifier via diagnostic services by Sender Receiver Interface	816
13.8.5.4	Dcm Service Use Case: Request vehicle information	817
13.8.5.5	Dem Service Use Case: Read DTR data from SW-C for OBd Service \$06	818
13.8.5.6	Dcm Service Use Case: request control of on-board system, test or component	819
13.8.5.7	Dem Service Use Case: In-Use-Monitoring Performance Ratio Denominator interface	819
13.8.6	Diagnostics over IP	820
13.8.6.1	DoIP Service Use Case: GID synchronization can be necessary if the ECU is DoIP Gid synchronization master	824
13.8.6.2	DoIP Service Use Case: Vehicle information is broadcast or can be requested by the tester	824
13.8.6.3	DoIP Service Use Case: Tester could also request the power status with respect to diagnostics	825
13.8.6.4	DoIP Service Use Case: Routing activation mechanism is used which can lead to additional impact regarding authentication or confirmation	825
13.8.6.5	DoIP Service Use Case: a DoIP entity needs to be informed when an external tester is attached or activated.	826
13.8.6.6	Service Use Case: Set and reset Warning Indicator Request bit	826
13.8.6.7	DoIP Service Use Case: Atomic Software-Component provides the further action byte to the DoIP Service Component	827
13.8.7	Miscellaneous Diagnostic Service Use-Cases	828
13.8.7.1	Dcm Service Use Case: DiagnosticSessionControl	828
13.8.7.2	Dcm Service Use Case: EcuReset	829
13.8.7.3	Dcm Service Use Case: EcuReset ModeRapidPowerShutDown	829
13.8.7.4	Dcm Service Use Case: CommunicationControl	830
13.8.7.5	Dcm Service Use Case: ControlDTCSetting	830
13.8.7.6	Dcm Service Use Case: Response On Event via diagnostic services	831

13.8.7.7	Dcm Service Use Case: SecurityAccess	832
13.8.7.8	Service Use Case: Atomic Software-Component implements a Hardware Shutdown	832
13.8.7.9	Service Use Case: Upload and download of data	833
13.9	Diagnostic Log and Trace Dependency	834
13.9.1	Dlt use Case:Application software component transmits debug information	834
13.10	Synchronized Time-Base Manager Dependency	835
13.10.1	StbM Use Case: start timer and potentially get notified about its expiration	836
13.10.2	StbM Use Case: Software-Components wants to get notifications of status changes	837
13.10.3	StbM Use Case: Process time snapshot obtained from global time slave for diagnostics purposes	837
13.10.4	StbM Use Case: Software-component represents a global time master	838
13.10.5	StbM Use Case: Software-component represents a global time slave	839
13.11	Secure On-Board Communication	839
13.11.1	SecOc Use Case: obtain the verification status of secure communication	840
13.11.2	SecOc Use Case: software component retires from secure communication for a given period	841
13.11.3	SecOc Use Case: deliver freshness to SecOC I	841
13.11.4	SecOc Use Case: deliver freshness to SecOC II	842
13.11.5	SecOc Use Case: deliver freshness to SecOC III	842
13.11.6	SecOc Use Case: enable the sending of Pdus even if computation of the MAC is not possible	843
13.12	J1939 Communication	843
13.12.1	J1939RM Use Case: AtomicSwComponentType sends requests to the bus	844
13.12.2	J1939RM Use Case: AtomicSwComponentType accepts requests from the bus	845
13.13	Error Tracer	845
13.13.1	Error Tracer Use Case: Default Error Tracer Service use Case: report failure	847
13.14	Vehicle-2-X Facilities	848
13.14.1	V2xFac Use Case: Application software component provides Vehicle specific data to the V2X-Stack for CAM transmission	849
13.14.2	V2xFac Use Case: V2xFac notifies application software component about received messages	849
13.14.3	V2xFac Use Case: Application software component triggers transmission of DENM message	850
13.14.4	V2xFac Use Case: Application software component processes the <i>MAP (topology) Extended Message</i>	851

13.14.5	V2xFac Use Case: Application software component processes Infrastructure to Vehicle Information Message	852
13.14.6	V2xFac Use Case: Application software component processes Signal Phase And Timing Extended Message	852
13.15	Vehicle-2-X Management	853
13.15.1	V2xM Use Case: Application software component provides Vehicle specific data to the V2X-Stack for Position and Time information	854
13.15.2	V2xM Use Case: Application software component needs V2X specific data from the V2X Manager	854
13.15.3	V2xM Use Case: Application software component has soft-control over Pseudonym-Change within V2X Manager	855
13.15.4	V2xM Use Case: Application software component has the ability to do Verification-on-Demand	855
13.15.5	V2xM Use Case: Application software component do location based calculations	856
13.16	Hardware Test Manager	857
13.16.1	HtssM Service Use Case: Query results of hardware tests	857
14	Rapid Prototyping Scenarios	859
14.1	Definition of Rapid Prototyping Scenario	859
14.2	Usage of RptContainers on M1	863
14.3	Usage of atpSplitable for RptContainers on M1	864
14.4	Modifications of the Meta-Model for supporting the RPT scenario	865
14.5	Extended Buffer Access Method	868
14.5.1	RP Preparation	869
14.5.2	Service Points	873
14.5.2.1	Service Functions	873
A	Glossary	876
B	Supported Special Use Cases	880
B.1	Asymmetric Data Transformation between a Software-Component and a Complex Driver	880
B.1.1	Overview	880
B.1.2	Modeling Aspects	881
C	History of Constraints and Specification Items	883
C.1	Constraint History of this Document according to AUTOSAR R4.0.1	883
C.1.1	Changed Constraints in R4.0.1	883
C.1.2	Added Constraints in R4.0.1	883
C.1.3	Deleted Constraints	888
C.2	Constraint History of this Document according to AUTOSAR R4.0.2	889
C.2.1	Changed Constraints in R4.0.2	889
C.2.2	Added Constraints in R4.0.2	889
C.2.3	Deleted Constraints in R4.0.2	890
C.3	Constraint History of this Document according to AUTOSAR R4.0.3	890

C.3.1	Changed Constraints in R4.0.3	890
C.3.2	Added Constraints in R4.0.3	891
C.3.3	Added Specification Items in R4.0.3	893
C.3.4	Deleted Constraints in R4.0.3	909
C.3.5	Deleted Specification Items	910
C.4	Constraint History of this Document according to AUTOSAR R4.1.1	910
C.4.1	Changed Constraints in R4.1.1	910
C.4.2	Added Constraints in R4.1.1	911
C.4.3	Changed Specification Items in R4.1.1	915
C.4.4	Added Specification Items in R4.1.1	915
C.4.5	Deleted Constraints in R4.1.1	919
C.4.6	Deleted Specification Items in R4.1.1	919
C.5	Constraint History of this Document according to AUTOSAR R4.1.2	919
C.5.1	Changed Constraints in R4.1.2	919
C.5.2	Added Constraints in R4.1.2	920
C.5.3	Changed Specification Items in R4.1.2	921
C.5.4	Added Specification Items in R4.1.2	921
C.5.5	Deleted Constraints in R4.1.2	922
C.5.6	Deleted Specification Items in R4.1.2	922
C.6	Constraint History of this Document according to AUTOSAR R4.1.3	922
C.6.1	Added Traceables in R4.1.3	922
C.6.2	Changed Traceables in R4.1.3	923
C.6.3	Deleted Traceables in R4.1.3	923
C.6.4	Added Constraints in R4.1.3	923
C.6.5	Changed Constraints in R4.1.3	923
C.6.6	Deleted Constraints in R4.1.3	924
C.7	Constraint History of this Document according to AUTOSAR R4.2.1	924
C.7.1	Added Traceables in R4.2.1	924
C.7.2	Changed Traceables in R4.2.1	926
C.7.3	Deleted Traceables in R4.2.1	927
C.7.4	Added Constraints in R4.2.1	928
C.7.5	Changed Constraints in R4.2.1	929
C.7.6	Deleted Constraints in R4.2.1	929
C.8	Constraint History of this Document according to AUTOSAR R4.2.2	930
C.8.1	Added Traceables in R4.2.2	930
C.8.2	Changed Traceables in R4.2.2	931
C.8.3	Deleted Traceables in R4.2.2	931
C.8.4	Added Constraints in R4.2.2	932
C.8.5	Changed Constraints in R4.2.2	933
C.8.6	Deleted Constraints in R4.2.2	933
C.9	Constraint History of this Document according to AUTOSAR R4.3.0	934
C.9.1	Added Traceables in R4.3.0	934
C.9.2	Changed Traceables in R4.3.0	936
C.9.3	Deleted Traceables in R4.3.0	938
C.9.4	Added Constraints in R4.3.0	939
C.9.5	Changed Constraints in R4.3.0	940

C.9.6	Deleted Constraints in R4.3.0	941
C.10	Constraint History of this Document according to AUTOSAR R4.3.1 . .	942
C.10.1	Added Traceables in 4.3.1	942
C.10.2	Changed Traceables in 4.3.1	942
C.10.3	Deleted Traceables in 4.3.1	943
C.10.4	Added Constraints in 4.3.1	943
C.10.5	Changed Constraints in 4.3.1	944
C.10.6	Deleted Constraints in 4.3.1	945
C.11	Constraint History of this Document according to AUTOSAR R4.4.0 . .	945
C.11.1	Added Traceables in 4.4.0	945
C.11.2	Changed Traceables in 4.4.0	947
C.11.3	Deleted Traceables in 4.4.0	948
C.11.4	Added Constraints in 4.4.0	949
C.11.5	Changed Constraints in 4.4.0	950
C.11.6	Deleted Constraints in 4.4.0	950
C.12	Constraint History of this Document according to AUTOSAR R19-11 .	951
C.12.1	Added Traceables in 19-11	951
C.12.2	Changed Traceables in 19-11	952
C.12.3	Deleted Traceables in 19-11	952
C.12.4	Added Constraints in 19-11	952
C.12.5	Changed Constraints in 19-11	954
C.12.6	Deleted Constraints in 19-11	954
D	Modeling of InstanceRef	955
D.1	Introduction	955
D.2	Modeling	956
D.2.1	Components and Compositions	956
D.2.2	Definition of implicit Communication Behavior	974
D.2.3	Internal Behavior	984
E	Examples	993
E.1	Examples for the Definition of variable-size Arrays	993
F	Mentioned Class Tables	997
G	Upstream Mapping	1033
G.1	Introduction	1033
G.2	NvM	1033
G.3	Com	1041
G.4	WdgM	1059
G.5	Dcm	1059
G.6	Dem	1094
G.7	BswM	1101
G.8	MemMap	1106
G.9	RTE	1107
G.10	ECUC	1113
G.11	OS	1118

H	Splitable Elements in the Scope of this Document	1120
I	Variation Points in the Scope of this Document	1122

References

- [1] Standardization Template
AUTOSAR_TPS_StandardizationTemplate
- [2] Specification of RTE Software
AUTOSAR_SWS_RTE
- [3] Virtual Functional Bus
AUTOSAR_EXP_VFB
- [4] Methodology
AUTOSAR_TR_Methodology
- [5] Layered Software Architecture
AUTOSAR_EXP_LayeredSoftwareArchitecture
- [6] Basic Software Module Description Template
AUTOSAR_TPS_BSWModuleDescriptionTemplate
- [7] Specification of Timing Extensions
AUTOSAR_TPS_TimingExtensions
- [8] Requirements on Timing Extensions
AUTOSAR_RS_TimingExtensions
- [9] Specification of ECU Resource Template
AUTOSAR_TPS_ECUResourceTemplate
- [10] System Template
AUTOSAR_TPS_SystemTemplate
- [11] Generic Structure Template
AUTOSAR_TPS_GenericStructureTemplate
- [12] Requirements on Software Component Template
AUTOSAR_RS_SoftwareComponentTemplate
- [13] Supplementary material of general blueprints for AUTOSAR
AUTOSAR_TR_GeneralBlueprintsSupplement
- [14] Specification of Basic Software Mode Manager
AUTOSAR_SWS_BSWModeManager
- [15] Information technology – Universal Coded Character Set (UCS)
<http://www.iso.org>
- [16] Specification of Manifest
AUTOSAR_TPS_ManifestSpecification
- [17] Specification of I/O Hardware Abstraction
AUTOSAR_SWS_IOHardwareAbstraction

- [18] ISO 17356-4: Road vehicles – Open interface for embedded automotive applications – Part 4: OSEK/VDX Communication (COM)
- [19] Specification of SW-C End-to-End Communication Protection Library
AUTOSAR_SWS_E2ELibrary
- [20] Specification of Communication Manager
AUTOSAR_SWS_COMManager
- [21] Specification of Communication
AUTOSAR_SWS_COM
- [22] Specification of Platform Types
AUTOSAR_SWS_PlatformTypes
- [23] ISO/IEC 9899:1990
<http://www.iso.org>
- [24] ASAM MCD 2MC ASAP2 Interface Specification
<http://www.asam.net>
ASAP2-V1.51.pdf
- [25] ASAM MCD 2 Harmonized Data Objects Version 1.1
harmonized-data-objects-V1.1.pdf
- [26] Collection of blueprints for AUTOSAR M1 models
AUTOSAR_MOD_GeneralBlueprints
- [27] ISO 26262 (Part 1-10) – Road vehicles – Functional Safety, First edition
<http://www.iso.org>
- [28] ASAM AE Calibration Data Format V2.0.0
<http://www.asam.net>
ASAM-AE-CDF-V2_0_0-Users-Guide.pdf
- [29] Specification of Operating System
AUTOSAR_SWS_OS
- [30] ISO 17356-3: Road vehicles – Open interface for embedded automotive applications – Part 3: OSEK/VDX Operating System (OS)
- [31] Specification of ECU Configuration Parameters (XML)
AUTOSAR_MOD_ECUConfigurationParameters
- [32] Glossary
AUTOSAR_TR_Glossary
- [33] Specification of NVRAM Manager
AUTOSAR_SWS_NVRAMManager
- [34] ASAM AE Functional Specification Exchange Format V1.0.0
<http://www.asam.net>
AE-FSX_V1.0.0.pdf

- [35] Specification of Watchdog Manager
AUTOSAR_SWS_WatchdogManager
- [36] Specification of ECU State Manager
AUTOSAR_SWS_ECUStateManager
- [37] Diagnostic Extract Template
AUTOSAR_TPS_DiagnosticExtractTemplate
- [38] Specification of Function Inhibition Manager
AUTOSAR_SWS_FunctionInhibitionManager
- [39] Specification of Diagnostic Event Manager
AUTOSAR_SWS_DiagnosticEventManager
- [40] Specification of Diagnostic Communication Manager
AUTOSAR_SWS_DiagnosticCommunicationManager
- [41] Road vehicles – Diagnostic communication over Internet Protocol (DoIP)
<http://www.iso.org>
- [42] Specification of Diagnostic Log and Trace
AUTOSAR_SWS_DiagnosticLogAndTrace
- [43] Specification of Synchronized Time-Base Manager
AUTOSAR_SWS_SynchronizedTimeBaseManager
- [44] Specification of Secure Onboard Communication
AUTOSAR_SWS_SecureOnboardCommunication
- [45] Specification of a Request Manager for SAE J1939
AUTOSAR_SWS_SAEJ1939RequestManager
- [46] Specification of Default Error Tracer
AUTOSAR_SWS_DefaultErrorTracer
- [47] Specification of Vehicle-2-X Facilities
AUTOSAR_SWS_V2XFacilities
- [48] Specification of Vehicle-2-X Management
AUTOSAR_SWS_V2XManagement
- [49] Software Process Engineering Meta-Model Specification
<http://www.omg.org/spec/SPEM/2.0/>
- [50] Specification of SOME/IP Transformer
AUTOSAR_SWS_SOMEIPTransformer

1 Introduction

1.1 Overview

This document contains the specification of the AUTOSAR `Software-Component Template`. Actually, it has been created as a supplement to the formal definition of the `Software-Component Template` by means of the AUTOSAR meta-model. In other words, this document in addition to the formal specification provides introductory description and rationale for the part of the AUTOSAR meta-model relevant for the definition of software-components.

In this context, the term software-component refers to a formally described piece of software existing that needs the AUTOSAR RTE [2] for execution.

Please note that the general ideas behind the semantics of application software-components have been described in the specification of the `Virtual Functional Bus` [3]. The latter, however, represents conceptual work that strongly influences but does not totally govern the formal definition of software-components.

Note further that this document does not provide any “best practice” recommendations of software-component modeling nor does it require or enforce a certain methodology. Note however, that the methodology aspect is covered by the specification of the AUTOSAR methodology [4].

Although it is beyond any doubt reasonable to use a suitable AUTOSAR Authoring Tool for dealing with AUTOSAR software-components, this specification does not make any assumptions nor does it give recommendations regarding the tooling.

1.2 Scope

As already mentioned in chapter 1.1, the Scope of this document is the description of AUTOSAR software-components. This work covers the following three aspects:

- A general description of `SwComponentTypes` using `PortPrototypes` and `PortInterfaces`, i.e. this document defines the `SwComponentType` as an entity which can be described through `PortPrototypes` which provide or require `PortInterfaces`.
- A description of `CompositionSwComponentTypes` which are sub-systems consisting out of connected instances of software-components, i.e. software-components may be defined in the form of hierarchical subsystems which in turn consist of software-components again. The description of such hierarchical structures is in scope of this document.
- A description of `AtomicSwComponentType` which is implemented as a piece of software that can be mapped to an AUTOSAR ECU.
An `AtomicSwComponentType` therefore shows up in the ECU Software Archi-

ecture depicted in Figure 1.1. In this figure, the green (vertically striped) and blue (diagonally striped) borders show the aspects that are described by the Software-Component Template.

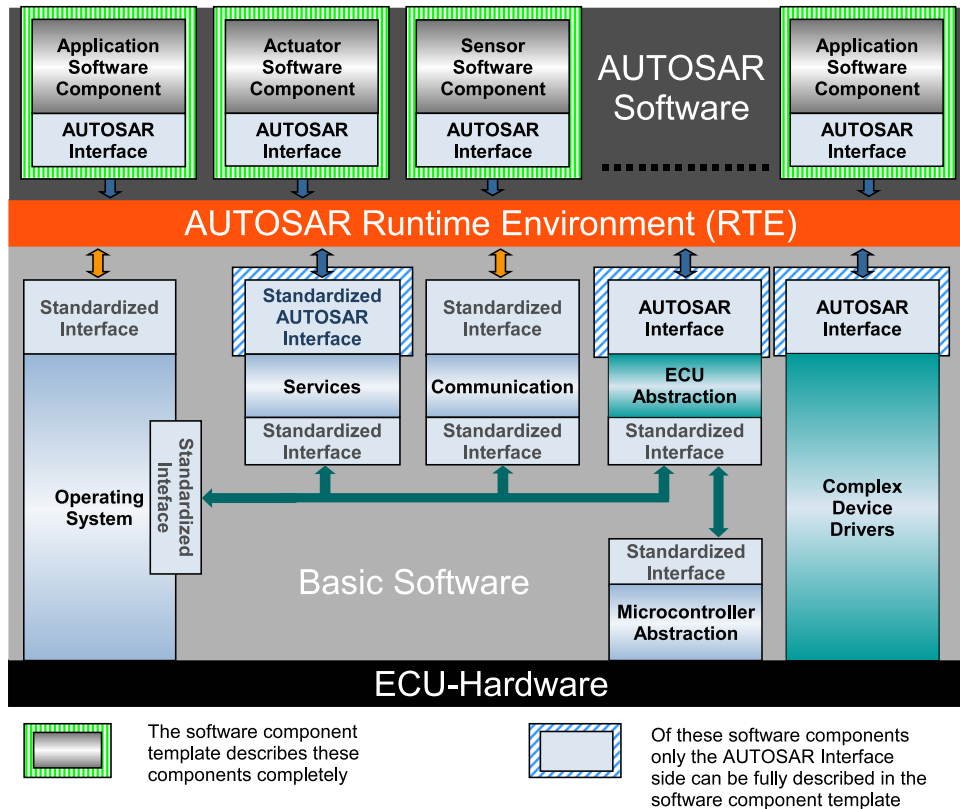

Figure 1.1: Scope of this document in the ECU SW Architecture [5]

Aspects of AUTOSAR Basic Software not relevant for the RTE are out of scope; these are covered by the Basic Software Module Description Template [6].

Also, the document does not cover aspects of timing analysis with respect to the execution of AUTOSAR software-components. This issue is explained in the Specification of Timing Extensions [7] as well as the corresponding requirement specification [8].

1.3 Organization of the Meta-Model

Figure 1.2 sketches the overall structure of the meta-model which formally defines the vocabulary required to describe AUTOSAR software-components. As the diagram points out, other template specifications (e.g. ECU Resource Template [9] and System Template [10]) also use the same modeling approach in order to define an overall consistent model of AUTOSAR software description.

The dashed arrows in the diagram describe dependencies in terms of import-relationships between the packages within the meta-model. For example, the package

SWComponentTemplate imports meta-classes defined in the packages GenericStructure [11] and ECUResourceTemplate [9].

Please note that this specification document will (with some well-defined exceptions) mostly discuss meta-model elements defined in the package SWComponentTemplate.

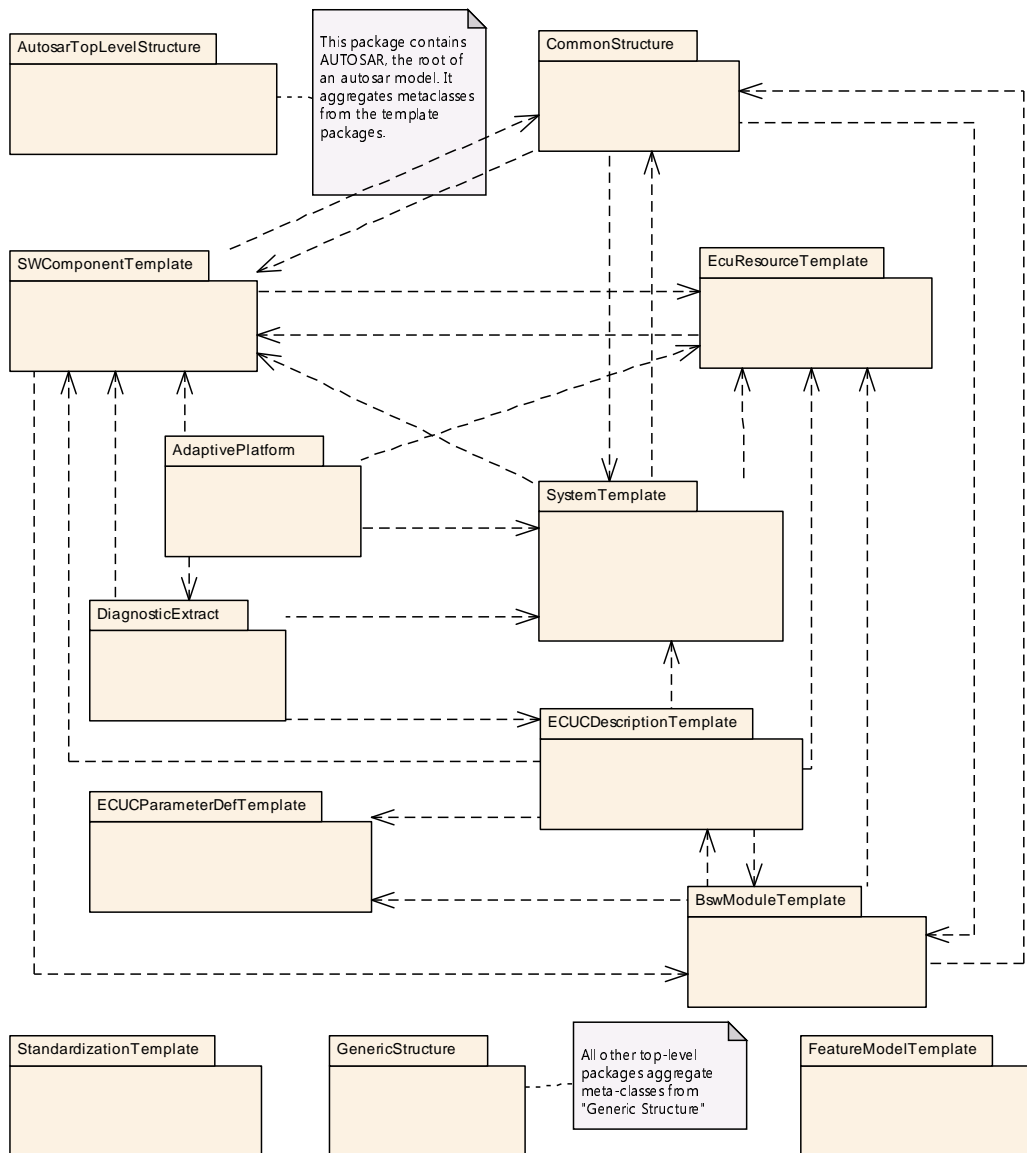

Figure 1.2: Structure of the meta-model

For clarification, please note that the package `GenericStructure` contains some fundamental infrastructure meta-classes and common patterns that are described in [11]. As these are used by all other template specification the dependency associations are not depicted in the diagram for the sake of clarity.

1.4 Structure of the Template

AUTOSAR software components are described on three distinctive levels, as shown in Figure 1.3.

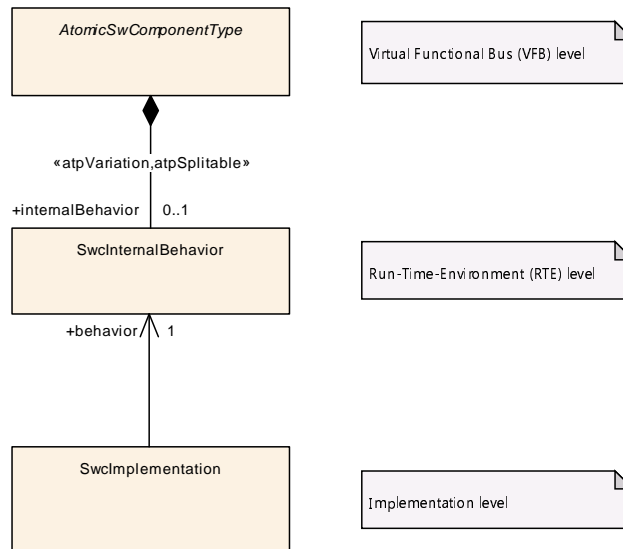

Figure 1.3: The description of a software component is done on three levels

1.4.1 Description of Software Components on VFB Level

The highest (most abstract) description level is the Virtual Functional Bus [3]. In this document `SwComponentTypes` are described with the means of `DataTypes`, `PortInterfaces`, `PortPrototypes`, and connections between them. At this level, the fundamental communication properties of components and their communication relationships among each other are expressed.

In the diagram depicted in Figure 1.3, this aspect is expressed by means of the description of `AtomicSwComponentType`¹.

1.4.2 Description of Software Components on RTE Level

The middle level allows for behavior description of a given `AtomicSwComponentType`. This so-called `SwcInternalBehavior` is expressed according to AUTOSAR RTE concepts, e.g. `RTEEvents` and in terms of schedulable units, so-called `RunnableEntities`.

¹To avoid clutter and require additional up-front information about the meta model, `CompositionSwComponentTypes` have not been added to the diagram.

For instance, for a `ClientServerOperation` defined in the scope of a particular `ClientServerInterface` on the VFB, the behavior specifies which `RunnableEntity` is activated as a consequence of the invocation of the specific `ClientServerOperation`.

As sketched by Figure 1.3, there may be zero or one `SwcInternalBehaviors` aggregated by a given `AtomicSwComponentType`. In response to the existence of the stereotype `<<atpSplittable>>` at the aggregation it is possible to distribute the aggregation over several physical files.

1.4.3 Descriptions of Software Components on Implementation Level

The lowest level of description specifies the implementation (i.e. in terms of the AUTOSAR meta-model: the `SwcImplementation`) of a given `SwcInternalBehavior` description. More precisely, the `RunnableEntity`s of such a behavior are mapped to code (source code or object code).

There may be different `SwcImplementations` that reference a specific `SwcInternalBehavior` description, e.g. in different programming languages, or with differently optimized code.

Please note that `Implementation` has been described in previous versions of this document. In response to the evolution of the AUTOSAR concept the description of the `Implementation` aspect has been moved to the “CommonStructure” (see Figure 1.2) because it is also used for creating the Basic Software Module Description Template [6].

However, the `SwcImplementation` still remains in the scope of this document as it exclusively covers aspects of software-components rather than basic software modules.

1.5 Abbreviations

The following table contains a list of abbreviations used in the scope of this document along with the spelled-out meaning of each of the abbreviations.

Abbreviation	Meaning
API	Application Programming Interface
BOM	Byte Order Mark
CAN	Controller Area Network
CSE	Codes for Scaling Units
DCM	Diagnostics Communication Manager





<i>Abbreviation</i>	<i>Meaning</i>
DCY	Driving Cycle
DEM	Diagnostics Event Manager
DID	Diagnostic Identifier
DTC	Diagnostic Trouble Code
DoIp	Diagnostics over IP
ECU	Electrical Control Unit
EPROM	Erasable Programmable Read-Only Memory
EEPROM	Electrically Erasable Programmable Read-Only Memory
FID	Function Identifier
GID	Group Identifier
ID	Identifier
IO	Input/Output
IP	Internet Protocol
IUMPR	In-Use Monitor Performance Ratio
ISO	International Standardization Organization
MAC	Message Authentication Code
MCAL	Micro-Controller Abstraction
LIN	Local Interconnect Network
MCD	Measurement, Calibration, Diagnostics
NM	Network Management
NV	Non-Volatile
OBD	On-Board Diagnostic
OEM	Original Equipment Manufacturer
OS	Operating System
PDU	Protocol Data Unit
PID	Parameter Identifier
PTO	Power Take Off
RA	Routing Activation
RAM	Random Access Memory
ROM	Read-Only Memory
RPT	Rapid Prototyping
RTE	Runtime Environment
SWC	Software Component
TID	Test Identifier
UDS	Unified Diagnostic Services
UML	Unified Modeling Language
VFB	Virtual Functional Bus
WWH-OBD	World-Wide Harmonized On-Board Diagnostics
XML	Extensible Markup Language
XSD	XML Schema Definition

Table 1.1: Abbreviations used in the scope of this Document

1.6 Document Conventions

Technical terms are typeset in mono spaced font, e.g. `PortPrototype`. As a general rule, plural forms of technical terms are created by adding "s" to the singular form, e.g. `PortPrototypes`. By this means the document resembles terminology used in the AUTOSAR XML Schema.

This document contains constraints in textual form that are distinguished from the rest of the text by a unique numerical constraint ID, a headline, and the actual constraint text starting after the `[` character and terminated by the `]` character.

The purpose of these constraints is to literally constrain the interpretation of the AUTOSAR meta-model such that it is possible to detect violations of the standardized behavior implemented in an instance of the meta-model (i.e. on M1 level).

Makers of AUTOSAR tools are encouraged to add the numerical ID of a constraint that corresponds to an M1 modeling issue as part of the diagnostic message issued by the tool.

The attributes of the classes introduced in this document are listed in form of class tables. They have the form shown in the example of the top-level element AUTOSAR:

Class	AUTOSAR			
Package	M2::AUTOSARTemplates::AutosarTopLevelStructure			
Note	Root element of an AUTOSAR description, also the root element in corresponding XML documents. Tags: xml.globalElement=true			
Base	ARObject			
Attribute	Type	Mult.	Kind	Note
adminData	AdminData	0..1	aggr	This represents the administrative data of an Autosar file. Tags: xml.sequenceOffset=10
arPackage	ARPackage	*	aggr	This is the top level package in an AUTOSAR model. Stereotypes: atpSplitable; atpVariation Tags: atp.Splitkey=shortName, variationPoint.shortLabel vh.latestBindingTime=blueprintDerivationTime xml.sequenceOffset=30
fileInfo Comment	FileInfoComment	0..1	aggr	This represents a possibility to provide a structured comment in an AUTOSAR file. Stereotypes: atpStructuredComment Tags: xml.roleElement=true xml.sequenceOffset=-10 xml.typeElement=false
introduction	DocumentationBlock	0..1	aggr	This represents an introduction on the Autosar file. It is intended for example to rpresent disclaimers and legal notes. Tags: xml.sequenceOffset=20

Table 1.2: AUTOSAR

The first rows in the table have the following meaning:

Class: The name of the class as defined in the UML model.

Package: The UML package the class is defined in. This is only listed to help locating the class in the overall meta model.

Note: The comment the modeler gave for the class (class note). Stereotypes and UML tags of the class are also denoted here.

Base Classes: If applicable, the list of direct base classes.

The headers in the table have the following meaning:

Attribute: The name of an attribute of the class. Note that AUTOSAR does not distinguish between class attributes and owned association ends.

Type: The type of an attribute of the class.

Mul.: The assigned multiplicity of the attribute, i.e. how many instances of the given data type are associated with the attribute.

Kind: Specifies, whether the attribute is aggregated in the class (*aggr* aggregation), an UML attribute in the class (*attr* primitive attribute), or just referenced by it (*ref* reference). Instance references are also indicated (*iref* instance reference) in this field.

Note: The comment the modeler gave for the class attribute (role note). Stereotypes and UML tags of the class are also denoted here.

Please note that the chapters that start with a letter instead of a numerical value represent the appendix of the document. The purpose of the appendix is to support the explanation of certain aspects of the document and does not represent binding conventions of the standard. The verbal forms for the expression of obligation specified in [TPS_STDT_00053] shall be used to indicate requirements, see Standardization Template, chapter Support for Traceability ([1]).

The representation of requirements in AUTOSAR documents follows the table specified in [TPS_STDT_00078], see Standardization Template, chapter Support for Traceability ([1]).

1.7 Requirements Tracing

Requirements against this document are exclusively stated in the corresponding requirements document [12].

The following table references the requirements specified in [12] and provides information about individual specification items that fulfill a given requirement.

Requirement	Description	Satisfied by
[RS_SWCT_00010]	AUTOSAR shall support inter- and intra-ECU-communication mechanisms with high reliability	[TPS_SWCT_01025] [TPS_SWCT_01026] [TPS_SWCT_01027] [TPS_SWCT_01069] [TPS_SWCT_01070] [TPS_SWCT_01111] [TPS_SWCT_01516] [TPS_SWCT_01573]
[RS_SWCT_00020]	AUTOSAR shall provide open and standardized software interfaces for intra-ECU and inter-ECU communication	[TPS_SWCT_01002]
[RS_SWCT_00030]	AUTOSAR shall provide complete interfaces to application software and basic software modules	[TPS_SWCT_01002]
[RS_SWCT_00070]	AUTOSAR shall provide an abstraction of the application software from hardware	[TPS_SWCT_01030] [TPS_SWCT_01097] [TPS_SWCT_01098]
[RS_SWCT_00080]	AUTOSAR shall provide an independence of application software from in-vehicle communication technologies	[TPS_SWCT_01025] [TPS_SWCT_01026] [TPS_SWCT_01027] [TPS_SWCT_01069] [TPS_SWCT_01070] [TPS_SWCT_01516]
[RS_SWCT_00090]	AUTOSAR should provide an independence of application software from operating systems	[TPS_SWCT_01030] [TPS_SWCT_01097] [TPS_SWCT_01098]
[RS_SWCT_00110]	AUTOSAR shall provide a functional interface view of the entire system	[TPS_SWCT_01025] [TPS_SWCT_01026] [TPS_SWCT_01027] [TPS_SWCT_01069] [TPS_SWCT_01070] [TPS_SWCT_01516]
[RS_SWCT_00120]	AUTOSAR shall provide protection/unlock mechanisms for software through appropriate services in the infrastructure	[TPS_SWCT_01031] [TPS_SWCT_01049] [TPS_SWCT_01050] [TPS_SWCT_01051] [TPS_SWCT_01052] [TPS_SWCT_01053] [TPS_SWCT_01054] [TPS_SWCT_01055] [TPS_SWCT_01321] [TPS_SWCT_01592] [TPS_SWCT_01713] [TPS_SWCT_01714]
[RS_SWCT_00150]	AUTOSAR shall provide means to protect SW-Components from malicious SW-Components	[TPS_SWCT_01002]
[RS_SWCT_00160]	AUTOSAR shall provide means to achieve compositionality	[TPS_SWCT_01002]
[RS_SWCT_00170]	AUTOSAR shall provide diagnostics means during runtime, for production and services purposes	[TPS_SWCT_01028] [TPS_SWCT_01029] [TPS_SWCT_01129] [TPS_SWCT_01132] [TPS_SWCT_01134] [TPS_SWCT_01135] [TPS_SWCT_01136] [TPS_SWCT_01137] [TPS_SWCT_01138] [TPS_SWCT_01139] [TPS_SWCT_01140] [TPS_SWCT_01425] [TPS_SWCT_01426] [TPS_SWCT_01427] [TPS_SWCT_01453] [TPS_SWCT_01582] [TPS_SWCT_01591] [TPS_SWCT_01627] [TPS_SWCT_01628] [TPS_SWCT_01629] [TPS_SWCT_01630] [TPS_SWCT_01631] [TPS_SWCT_01632] [TPS_SWCT_01633] [TPS_SWCT_01634] [TPS_SWCT_01639] [TPS_SWCT_01640] [TPS_SWCT_01654] [TPS_SWCT_01655] [TPS_SWCT_01656] [TPS_SWCT_01657] [TPS_SWCT_01690] [TPS_SWCT_01691] [TPS_SWCT_01697] [TPS_SWCT_01698] [TPS_SWCT_01706] [TPS_SWCT_01707] [TPS_SWCT_01708] [TPS_SWCT_01709] [TPS_SWCT_01711] [TPS_SWCT_01712] [TPS_SWCT_01715] [TPS_SWCT_01739] [TPS_SWCT_01765] [TPS_SWCT_01766] [TPS_SWCT_01767] [TPS_SWCT_01789] [TPS_SWCT_01790] [TPS_SWCT_01791] [TPS_SWCT_02002] [TPS_SWCT_02003] [TPS_SWCT_02004] [TPS_SWCT_02005] [TPS_SWCT_02007] [TPS_SWCT_02008] [TPS_SWCT_02009] [TPS_SWCT_02010] [TPS_SWCT_02011] [TPS_SWCT_02012] [TPS_SWCT_02013] [TPS_SWCT_02014] [TPS_SWCT_02015] [TPS_SWCT_02016] [TPS_SWCT_02505]
[RS_SWCT_00190]	AUTOSAR shall support hierarchical design methods	[TPS_SWCT_01032] [TPS_SWCT_01033] [TPS_SWCT_01034] [TPS_SWCT_01035] [TPS_SWCT_01036] [TPS_SWCT_01037] [TPS_SWCT_01697] [TPS_SWCT_01698]





Requirement	Description	Satisfied by
[RS_SWCT_00200]	Definitions of relations between SW components are exhaustive and formal	[TPS_SWCT_01002] [TPS_SWCT_01322] [TPS_SWCT_01323] [TPS_SWCT_01325] [TPS_SWCT_01326] [TPS_SWCT_01328] [TPS_SWCT_01329] [TPS_SWCT_01330] [TPS_SWCT_01331] [TPS_SWCT_01333] [TPS_SWCT_01334] [TPS_SWCT_01335] [TPS_SWCT_01336] [TPS_SWCT_01337] [TPS_SWCT_01338] [TPS_SWCT_01339] [TPS_SWCT_01340] [TPS_SWCT_01341] [TPS_SWCT_01342] [TPS_SWCT_01343] [TPS_SWCT_01345] [TPS_SWCT_01346] [TPS_SWCT_01347] [TPS_SWCT_01348] [TPS_SWCT_01349] [TPS_SWCT_01350] [TPS_SWCT_01351] [TPS_SWCT_01352] [TPS_SWCT_01353] [TPS_SWCT_01557] [TPS_SWCT_01558] [TPS_SWCT_01567] [TPS_SWCT_01663]
[RS_SWCT_00210]	SW components are protected from illegal access	[TPS_SWCT_01002]
[RS_SWCT_00220]	Management of vehicle diversity is supported by AUTOSAR	[TPS_SWCT_01038] [TPS_SWCT_01039] [TPS_SWCT_01040] [TPS_SWCT_01041] [TPS_SWCT_01042] [TPS_SWCT_01447]
[RS_SWCT_00230]	The Software Component Template shall provide the ability to define naming conventions for public symbols	[TPS_SWCT_01635]
[RS_SWCT_02000]	AUTOSAR shall support a top-down hierarchical design	[TPS_SWCT_01032] [TPS_SWCT_01033] [TPS_SWCT_01034] [TPS_SWCT_01035] [TPS_SWCT_01036] [TPS_SWCT_01037]
[RS_SWCT_02010]	Interfaces of atomic software-components shall be supported	[TPS_SWCT_01002]
[RS_SWCT_02020]	Bottom-up design of Composition Types shall be supported	[TPS_SWCT_01032] [TPS_SWCT_01033] [TPS_SWCT_01034] [TPS_SWCT_01035] [TPS_SWCT_01036] [TPS_SWCT_01037]
[RS_SWCT_02030]	Specification of Communications shall be supported	[TPS_SWCT_01002] [TPS_SWCT_01025] [TPS_SWCT_01026] [TPS_SWCT_01027] [TPS_SWCT_01516]
[RS_SWCT_02060]	Interaction with basic software shall be considered	[TPS_SWCT_01043] [TPS_SWCT_01044] [TPS_SWCT_01045] [TPS_SWCT_01046] [TPS_SWCT_01693]
[RS_SWCT_02080]	Designing a Sensor Actuator Component shall be supported	[TPS_SWCT_01047] [TPS_SWCT_01048]
[RS_SWCT_02090]	Data-consistency for communication among Runnable Entities shall be supported	[TPS_SWCT_01031] [TPS_SWCT_01049] [TPS_SWCT_01050] [TPS_SWCT_01051] [TPS_SWCT_01052] [TPS_SWCT_01053] [TPS_SWCT_01054] [TPS_SWCT_01055] [TPS_SWCT_01637] [TPS_SWCT_01713] [TPS_SWCT_01714]
[RS_SWCT_02100]	Definition of physical units shall be supported	[TPS_SWCT_01056] [TPS_SWCT_01057] [TPS_SWCT_01058] [TPS_SWCT_01059] [TPS_SWCT_01060] [TPS_SWCT_01061] [TPS_SWCT_01068] [TPS_SWCT_01736] [TPS_SWCT_01737]
[RS_SWCT_02110]	Definition of comments shall be supported	[TPS_SWCT_01062]
[RS_SWCT_03000]	The SW-Component template shall support compositions	[TPS_SWCT_01032] [TPS_SWCT_01033] [TPS_SWCT_01034] [TPS_SWCT_01035] [TPS_SWCT_01036] [TPS_SWCT_01037]
[RS_SWCT_03010]	The SW-Component template shall support interfaces	[TPS_SWCT_01025] [TPS_SWCT_01026] [TPS_SWCT_01069] [TPS_SWCT_01070] [TPS_SWCT_01516]
[RS_SWCT_03040]	The SW-Component template shall support description of the behavior	[TPS_SWCT_01075] [TPS_SWCT_01108]
[RS_SWCT_03045]	The SW-Component template shall allow enabling of RTE-Feature to get the activating RTE-Event of Runnable Entity	[TPS_SWCT_01469]
[RS_SWCT_03046]	The SW-Component template shall support instance specific RTE-Events	[TPS_SWCT_02507]





Requirement	Description	Satisfied by
[RS_SWCT_03050]	The SW-Component template shall support the definition of schedulability	[TPS_SWCT_01030] [TPS_SWCT_01097] [TPS_SWCT_01098]
[RS_SWCT_03055]	The SW-Component template shall support optional configuration of ExclusiveArea usage within RunnableEntities	[TPS_SWCT_01457] [TPS_SWCT_01458] [TPS_SWCT_01459] [TPS_SWCT_01460]
[RS_SWCT_03065]	The SW-Component template shall support the definition of implicit communication behavior	[TPS_SWCT_01466] [TPS_SWCT_01470] [TPS_SWCT_01471] [TPS_SWCT_01472] [TPS_SWCT_01473] [TPS_SWCT_01475] [TPS_SWCT_01476] [TPS_SWCT_01479] [TPS_SWCT_01481] [TPS_SWCT_01482] [TPS_SWCT_01509] [TPS_SWCT_01625]
[RS_SWCT_03090]	The SW-Component template shall support the definition of needed and usable sensors and actuators	[TPS_SWCT_01047] [TPS_SWCT_01048]
[RS_SWCT_03100]	The SW-Component template shall support variant handling	[TPS_SWCT_01038] [TPS_SWCT_01040] [TPS_SWCT_01041] [TPS_SWCT_01042] [TPS_SWCT_01370] [TPS_SWCT_01371] [TPS_SWCT_01372] [TPS_SWCT_01373] [TPS_SWCT_01448]
[RS_SWCT_03110]	The SW-Component template shall support modes	[TPS_SWCT_01071] [TPS_SWCT_01190] [TPS_SWCT_01376] [TPS_SWCT_01377] [TPS_SWCT_01378] [TPS_SWCT_01379] [TPS_SWCT_01380] [TPS_SWCT_01381] [TPS_SWCT_01382] [TPS_SWCT_01383] [TPS_SWCT_01384] [TPS_SWCT_01385] [TPS_SWCT_01388] [TPS_SWCT_01511] [TPS_SWCT_01512] [TPS_SWCT_01513] [TPS_SWCT_01530] [TPS_SWCT_01531] [TPS_SWCT_01532] [TPS_SWCT_01533] [TPS_SWCT_01534] [TPS_SWCT_01535] [TPS_SWCT_01536] [TPS_SWCT_01541] [TPS_SWCT_01542] [TPS_SWCT_01552] [TPS_SWCT_01553] [TPS_SWCT_01554] [TPS_SWCT_01555] [TPS_SWCT_01581] [TPS_SWCT_01664]
[RS_SWCT_03115]	The SW-Component template shall support mapping of mode declarations	[TPS_SWCT_01464] [TPS_SWCT_01465] [TPS_SWCT_01545]
[RS_SWCT_03120]	The SW-Component template shall support dependency on modes	[TPS_SWCT_01077]
[RS_SWCT_03130]	The SW-Component template shall support connections between PortInterfaces	[TPS_SWCT_01079] [TPS_SWCT_01080] [TPS_SWCT_01081] [TPS_SWCT_01082] [TPS_SWCT_01083] [TPS_SWCT_01084] [TPS_SWCT_01113] [TPS_SWCT_01573]
[RS_SWCT_03135]	The SW-Component template shall support record type subsetting	[TPS_SWCT_01023] [TPS_SWCT_01024] [TPS_SWCT_01551]
[RS_SWCT_03136]	The SW-Component template shall support record type subsetting with primitive types	[TPS_SWCT_01195]
[RS_SWCT_03140]	The SW-Component template shall support conditional existence of PortPrototypes	[TPS_SWCT_01038]
[RS_SWCT_03141]	The SW-Component template shall support the conditional existence of data element prototypes, operation prototypes, parameter prototypes in an interface	[TPS_SWCT_01106]
[RS_SWCT_03142]	The SW-Component template shall support the conditional existence of Component Prototypes	[TPS_SWCT_01038]





Requirement	Description	Satisfied by
[RS_SWCT_03143]	The SW-Component template shall support the conditional existence of Connector Prototypes	[TPS_SWCT_01040]
[RS_SWCT_03144]	The SW-Component template shall support a configurable size of arrays	[TPS_SWCT_01076] [TPS_SWCT_01078]
[RS_SWCT_03148]	Attributes swMinAxisPoints and swMaxAxisPoints shall be adjustable by an System Constant Definition	[TPS_SWCT_01107] [TPS_SWCT_01181]
[RS_SWCT_03149]	The SW-Component template shall support the conditional existence of RunnableEntitys	[TPS_SWCT_01085]
[RS_SWCT_03150]	The SW-Component template shall support the conditional existence of RTEEvents	[TPS_SWCT_01085]
[RS_SWCT_03151]	The SW-Component template shall support the conditional existence of InterRunnable Variables	[TPS_SWCT_01085]
[RS_SWCT_03152]	The SW-Component template shall support the conditional accessibility for measurement	[TPS_SWCT_01130]
[RS_SWCT_03153]	The SW-Component template shall support the conditional existence of parameter prototypes	[TPS_SWCT_01085]
[RS_SWCT_03154]	The SW-Component template shall support conditional ports for software components	[TPS_SWCT_01038]
[RS_SWCT_03155]	The SW-Component template shall support interfaces with different resolutions	[TPS_SWCT_01099] [TPS_SWCT_01100] [TPS_SWCT_01101] [TPS_SWCT_01102] [TPS_SWCT_01103] [TPS_SWCT_01104] [TPS_SWCT_01105]
[RS_SWCT_03170]	The SW-Component template shall support fixed data exchange	[TPS_SWCT_01102] [TPS_SWCT_01103] [TPS_SWCT_01104]
[RS_SWCT_03175]	The SW-Component template shall support the definition of calibration datasets	[TPS_SWCT_01177] [TPS_SWCT_01178] [TPS_SWCT_01188] [TPS_SWCT_01793] [TPS_SWCT_01794]
[RS_SWCT_03180]	The SW-Component template shall support SAE J1939 Protocol Features	[TPS_SWCT_01076] [TPS_SWCT_01673] [TPS_SWCT_01674]
[RS_SWCT_03181]	The SW-Component template shall support arrays of variable number of elements within the maximum size	[TPS_SWCT_01076] [TPS_SWCT_01127] [TPS_SWCT_01495] [TPS_SWCT_01601] [TPS_SWCT_01602] [TPS_SWCT_01604] [TPS_SWCT_01605] [TPS_SWCT_01606] [TPS_SWCT_01607] [TPS_SWCT_01608] [TPS_SWCT_01610] [TPS_SWCT_01612] [TPS_SWCT_01613] [TPS_SWCT_01614] [TPS_SWCT_01615] [TPS_SWCT_01617] [TPS_SWCT_01618] [TPS_SWCT_01619] [TPS_SWCT_01620] [TPS_SWCT_01621] [TPS_SWCT_01622] [TPS_SWCT_01623] [TPS_SWCT_01636] [TPS_SWCT_01641] [TPS_SWCT_01642] [TPS_SWCT_01644] [TPS_SWCT_01645] [TPS_SWCT_01647] [TPS_SWCT_01648] [TPS_SWCT_01649] [TPS_SWCT_01650] [TPS_SWCT_01793] [TPS_SWCT_01794]
[RS_SWCT_03182]	The SW-Component template shall support byte arrays of variable number of elements	[TPS_SWCT_01127]





Requirement	Description	Satisfied by
[RS_SWCT_03190]	The SW-Component template shall support the ability to publish/ specify the diagnostic capabilities and its resources of an SWC	[TPS_SWCT_01028] [TPS_SWCT_01029] [TPS_SWCT_01129] [TPS_SWCT_01132] [TPS_SWCT_01134] [TPS_SWCT_01135] [TPS_SWCT_01136] [TPS_SWCT_01137] [TPS_SWCT_01138] [TPS_SWCT_01139] [TPS_SWCT_01140] [TPS_SWCT_01425] [TPS_SWCT_01426] [TPS_SWCT_01427] [TPS_SWCT_01453] [TPS_SWCT_01537] [TPS_SWCT_01538] [TPS_SWCT_01539] [TPS_SWCT_01540] [TPS_SWCT_01544] [TPS_SWCT_01546] [TPS_SWCT_01547] [TPS_SWCT_01577] [TPS_SWCT_01578] [TPS_SWCT_01582] [TPS_SWCT_01591] [TPS_SWCT_01627] [TPS_SWCT_01628] [TPS_SWCT_01629] [TPS_SWCT_01630] [TPS_SWCT_01631] [TPS_SWCT_01632] [TPS_SWCT_01633] [TPS_SWCT_01634] [TPS_SWCT_01639] [TPS_SWCT_01640] [TPS_SWCT_01654] [TPS_SWCT_01655] [TPS_SWCT_01656] [TPS_SWCT_01657] [TPS_SWCT_01680] [TPS_SWCT_01690] [TPS_SWCT_01691] [TPS_SWCT_01706] [TPS_SWCT_01707] [TPS_SWCT_01708] [TPS_SWCT_01709] [TPS_SWCT_01711] [TPS_SWCT_01712] [TPS_SWCT_01715] [TPS_SWCT_01739] [TPS_SWCT_01746] [TPS_SWCT_01765] [TPS_SWCT_01766] [TPS_SWCT_01767] [TPS_SWCT_01769] [TPS_SWCT_01789] [TPS_SWCT_01790] [TPS_SWCT_01791] [TPS_SWCT_02002] [TPS_SWCT_02003] [TPS_SWCT_02004] [TPS_SWCT_02005] [TPS_SWCT_02007] [TPS_SWCT_02008] [TPS_SWCT_02009] [TPS_SWCT_02010] [TPS_SWCT_02011] [TPS_SWCT_02012] [TPS_SWCT_02013] [TPS_SWCT_02014] [TPS_SWCT_02015] [TPS_SWCT_02016] [TPS_SWCT_02505]
[RS_SWCT_03200]	The SW-Component template shall support vehicle and application mode management	[TPS_SWCT_01008] [TPS_SWCT_01009] [TPS_SWCT_01010] [TPS_SWCT_01011] [TPS_SWCT_01016] [TPS_SWCT_01017] [TPS_SWCT_01018] [TPS_SWCT_01019] [TPS_SWCT_01020] [TPS_SWCT_01021] [TPS_SWCT_01063] [TPS_SWCT_01064] [TPS_SWCT_01065] [TPS_SWCT_01066] [TPS_SWCT_01067] [TPS_SWCT_01071] [TPS_SWCT_01126] [TPS_SWCT_01450] [TPS_SWCT_01451] [TPS_SWCT_01552] [TPS_SWCT_01553] [TPS_SWCT_01554] [TPS_SWCT_01572] [TPS_SWCT_01581] [TPS_SWCT_01664]
[RS_SWCT_03201]	The SW-Component template shall support Portgroups	[TPS_SWCT_01063] [TPS_SWCT_01064] [TPS_SWCT_01065] [TPS_SWCT_01066] [TPS_SWCT_01096] [TPS_SWCT_01126] [TPS_SWCT_01169] [TPS_SWCT_01173] [TPS_SWCT_01174]
[RS_SWCT_03202]	The SW-Component template shall support enabling SWCs to request dedicated modes	[TPS_SWCT_01086] [TPS_SWCT_01201] [TPS_SWCT_01353] [TPS_SWCT_01554] [TPS_SWCT_01572]
[RS_SWCT_03203]	The SW-Component template shall support propagation of mode information	[TPS_SWCT_01086] [TPS_SWCT_01087] [TPS_SWCT_01200] [TPS_SWCT_01201] [TPS_SWCT_01202] [TPS_SWCT_01552] [TPS_SWCT_01553] [TPS_SWCT_01566] [TPS_SWCT_01664]
[RS_SWCT_03210]	The SW-Component template shall support integrity and scaling at ports	[TPS_SWCT_01023] [TPS_SWCT_01024] [TPS_SWCT_01099] [TPS_SWCT_01100] [TPS_SWCT_01101] [TPS_SWCT_01102] [TPS_SWCT_01103] [TPS_SWCT_01104] [TPS_SWCT_01105] [TPS_SWCT_01158] [TPS_SWCT_01159] [TPS_SWCT_01160] [TPS_SWCT_01161] [TPS_SWCT_01162] [TPS_SWCT_01163] [TPS_SWCT_01164] [TPS_SWCT_01165] [TPS_SWCT_01166] [TPS_SWCT_01167] [TPS_SWCT_01168] [TPS_SWCT_01449] [TPS_SWCT_01543] [TPS_SWCT_01549] [TPS_SWCT_01550] [TPS_SWCT_01551] [TPS_SWCT_01560] [TPS_SWCT_01561] [TPS_SWCT_01583] [TPS_SWCT_01768]
[RS_SWCT_03215]	The SW-Component template shall define the need to add application data type on top of implementation data type	[TPS_SWCT_01072] [TPS_SWCT_01073] [TPS_SWCT_01074] [TPS_SWCT_01189] [TPS_SWCT_01229] [TPS_SWCT_01231] [TPS_SWCT_01235] [TPS_SWCT_01236]





Requirement	Description	Satisfied by
[RS_SWCT_03216]	The SW-Component template shall support application data type	[TPS_SWCT_01072] [TPS_SWCT_01073] [TPS_SWCT_01179] [TPS_SWCT_01180] [TPS_SWCT_01181] [TPS_SWCT_01183] [TPS_SWCT_01184] [TPS_SWCT_01185] [TPS_SWCT_01189] [TPS_SWCT_01191] [TPS_SWCT_01229] [TPS_SWCT_01230] [TPS_SWCT_01231] [TPS_SWCT_01235] [TPS_SWCT_01236] [TPS_SWCT_01237] [TPS_SWCT_01240] [TPS_SWCT_01241] [TPS_SWCT_01242] [TPS_SWCT_01243] [TPS_SWCT_01249] [TPS_SWCT_01256] [TPS_SWCT_01486]
[RS_SWCT_03217]	The SW-Component template shall support implementation data type	[TPS_SWCT_01072] [TPS_SWCT_01074] [TPS_SWCT_01183] [TPS_SWCT_01184] [TPS_SWCT_01189] [TPS_SWCT_01191] [TPS_SWCT_01229] [TPS_SWCT_01231] [TPS_SWCT_01232] [TPS_SWCT_01233] [TPS_SWCT_01235] [TPS_SWCT_01236] [TPS_SWCT_01237] [TPS_SWCT_01248] [TPS_SWCT_01250] [TPS_SWCT_01251] [TPS_SWCT_01252] [TPS_SWCT_01253] [TPS_SWCT_01254] [TPS_SWCT_01255] [TPS_SWCT_01257] [TPS_SWCT_01258] [TPS_SWCT_01259] [TPS_SWCT_01700] [TPS_SWCT_01701] [TPS_SWCT_01702]
[RS_SWCT_03218]	The SW-Component template shall support data types for primitive data mapping	[TPS_SWCT_01477]
[RS_SWCT_03220]	The SW-Component template shall allow communication attributes on compositions	[TPS_SWCT_01088] [TPS_SWCT_01568]
[RS_SWCT_03221]	The SW-Component template shall allow port specific configuration of data transformation properties	[TPS_SWCT_01222] [TPS_SWCT_01594] [TPS_SWCT_01595] [TPS_SWCT_01596] [TPS_SWCT_01597] [TPS_SWCT_01598] [TPS_SWCT_01599] [TPS_SWCT_01600]
[RS_SWCT_03222]	The SW-Component template shall support error notification for transformed data communication	[TPS_SWCT_01616] [TPS_SWCT_01624] [TPS_SWCT_01626]
[RS_SWCT_03225]	The SW-Component template shall support an enhanced non-volatile (NV) memory interface	[TPS_SWCT_01141] [TPS_SWCT_01142] [TPS_SWCT_01143] [TPS_SWCT_01227] [TPS_SWCT_01228] [TPS_SWCT_01584] [TPS_SWCT_01585] [TPS_SWCT_01586] [TPS_SWCT_01587] [TPS_SWCT_01588] [TPS_SWCT_01589] [TPS_SWCT_01590] [TPS_SWCT_01662] [TPS_SWCT_01665] [TPS_SWCT_01666] [TPS_SWCT_01675] [TPS_SWCT_01754] [TPS_SWCT_01755] [TPS_SWCT_01795] [TPS_SWCT_02501] [TPS_SWCT_02502] [TPS_SWCT_02503] [TPS_SWCT_02504]
[RS_SWCT_03230]	The SW-Component template shall support documentation of M1 artifacts	[TPS_SWCT_01062] [TPS_SWCT_01699]
[RS_SWCT_03240]	The SW-Component template shall support end-to-end communication protection	[TPS_SWCT_01089] [TPS_SWCT_01090] [TPS_SWCT_01091] [TPS_SWCT_01092] [TPS_SWCT_01093] [TPS_SWCT_01094] [TPS_SWCT_01095] [TPS_SWCT_01508] [TPS_SWCT_01529]
[RS_SWCT_03241]	The SW-Component template shall support partial networking	[TPS_SWCT_01169] [TPS_SWCT_01170] [TPS_SWCT_01171] [TPS_SWCT_01172] [TPS_SWCT_01173] [TPS_SWCT_01174] [TPS_SWCT_01175]
[RS_SWCT_03250]	The SW-Component template shall support bidirectional communication	[TPS_SWCT_01112] [TPS_SWCT_01113] [TPS_SWCT_01454] [TPS_SWCT_01455] [TPS_SWCT_01514] [TPS_SWCT_01573]
[RS_SWCT_03260]	The SW-Component template shall support rule-based initialization of arrays	[TPS_SWCT_01484] [TPS_SWCT_01485] [TPS_SWCT_01493] [TPS_SWCT_01494] [TPS_SWCT_01495] [TPS_SWCT_01528] [TPS_SWCT_01609] [TPS_SWCT_01692]
[RS_SWCT_03270]	The SW-Component template shall support overriding the activation period time on instance level	[TPS_SWCT_02507]



△

Requirement	Description	Satisfied by
[RS_SWCT_03280]	The SW-Component template shall support the description of bypass points and bypass scenarios	[TPS_SWCT_01719] [TPS_SWCT_01720] [TPS_SWCT_01721] [TPS_SWCT_01722] [TPS_SWCT_01723] [TPS_SWCT_01724] [TPS_SWCT_02046] [TPS_SWCT_02047] [TPS_SWCT_02048] [TPS_SWCT_02049] [TPS_SWCT_02050] [TPS_SWCT_02051] [TPS_SWCT_02052]
[RS_SWCT_03281]	The SW-Component template shall support post-build hooking tools for rapid prototyping	[TPS_SWCT_02047]
[RS_SWCT_03282]	The SW-Component template shall support the description of service points and rapid prototyping scenarios	[TPS_SWCT_02046] [TPS_SWCT_02047]
[RS_SWCT_03290]	The SW-Component template shall support the initialization of runnables without usage of mode management	[TPS_SWCT_01525]
[RS_SWCT_03310]	The SW-Component template shall support Diagnostics over IP	[TPS_SWCT_01537] [TPS_SWCT_01538] [TPS_SWCT_01539] [TPS_SWCT_01544] [TPS_SWCT_01546] [TPS_SWCT_01547] [TPS_SWCT_01746]
[RS_SWCT_03320]	The SW-Component template shall support the definition of optional elements for communication	[TPS_SWCT_01771] [TPS_SWCT_01772] [TPS_SWCT_01773] [TPS_SWCT_01774] [TPS_SWCT_01775] [TPS_SWCT_01785] [TPS_SWCT_01786]

Table 1.3: RequirementsTracing

2 Conceptual Aspects

2.1 Introduction

For the sake of a compact description of relevant meta-model elements the discussion and explanation of conceptual aspects has been concentrated in this chapter.

Reading this chapter is not a pre-requisite for understanding the subsequent chapters. It just provides a central place for the detailed description of conceptual aspects used in various other chapters of this document.

The actual explanation of the concept of a software-component starts in chapter [3](#).

2.2 Measurement and Calibration

2.2.1 Basic Approach of Measurement and Calibration

While performing the calibration process using an MCD tool (Measurement, Calibration, and Diagnostic) the calibration engineer needs to have a specific insight to the data within the CPU at runtime.

This insight is provided by access to ECU internal variables (also called measurements) as well as calibration parameters (sometimes also called characteristic value). For more details, please refer to [\[TPS_SWCT_01418\]](#)

The description of measurement variables and calibration parameters is basically the same. In AUTOSAR both appear finally as [DataPrototypes](#).

2.2.2 Calibration Parameters Overview

A Calibration Parameter is a parameter which characterizes the dynamics of a control algorithm. From a software implementation point of view, it is a variable with only read-access during the normal operation of an ECU. Characteristics are specialized [DataPrototype](#) entities in terms of its associated type but are used similarly.

[TPS_SWCT_01418] Ways to define a calibration parameter [This means that Calibration Parameters can be defined

- individually for a [SwComponentPrototype](#) in the [SwcInternalBehavior](#) of a [SwComponentType](#) via an aggregation of an [ParameterDataPrototype](#) in the role of [perInstanceParameter](#) (similar to [PerInstanceMemory](#)).
- sharing between all [SwComponentPrototypes](#) of the same [SwComponentType](#) in its [SwcInternalBehavior](#) via an aggregation of an [ParameterDataPrototype](#) in the role of [sharedParameter](#) or [constantMemory](#).

- for several `SwComponentPrototypes` (using the port-/interface-concept with `ParameterInterfaceS`).

]()

Please note:

- The definition of `perInstanceParameter` is further described in chapter 2.2.3.3.
- Chapter 2.2.3.2 provides more information about the definition of `sharedParameter` or `constantMemory`.
- For more information regarding the definition of `ParameterInterface`, please refer to chapter 2.2.3.1.

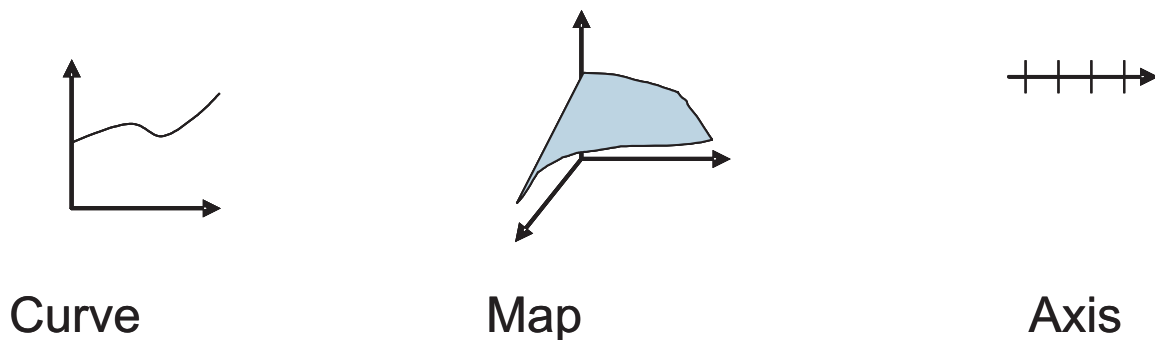

Figure 2.1: Some Categories of calibration parameters

Note: the structure of various calibration objects is visualized in [13].

2.2.3 Using Calibration Parameters

As mentioned above, a `ParameterDataPrototype` can be used in the context of `SwcInternalBehavior` as well as in the context of `PortPrototypes`.

2.2.3.1 Sharing Calibration Parameters within Compositions

To provide calibration parameters for being visible in other `SwComponentTypes`, a dedicated `ParameterSwComponentType` (see Figure 3.4) that inherits from `SwComponentType` has to be used as a `SwComponentPrototype` within a `CompositionSwComponentType`.

Class	ParameterSwComponentType			
Package	M2::AUTOSARTemplates::SWComponentTemplate::Components			
Note	The ParameterSwComponentType defines parameters and characteristic values accessible via provided Ports. The provided values are the same for all connected SwComponentPrototypes Tags: atp.recommendedPackage=SwComponentTypes			
Base	ARElement , ARObject , AtpBlueprint , AtpBlueprintable , AtpClassifier , AtpType , CollectableElement , Identifiable , MultilanguageReferrable , PackageableElement , Referrable , SwComponentType			
Attribute	Type	Mult.	Kind	Note
constant Mapping	ConstantSpecificationMappingSet	*	ref	Reference to the ConstanSpecificationMapping to be applied for the particular ParameterSwComponentType Stereotypes: atpSplitable Tags: atp.Splitkey=constantMapping
dataType Mapping	DataTypeMappingSet	*	ref	Reference to the DataTypeMapping to be applied for the particular ParameterSwComponentType Stereotypes: atpSplitable Tags: atp.Splitkey=dataTypeMapping
instantiation DataDefProps	InstantiationDataDefProps	*	aggr	The purpose of this is that within the context of a given SwComponentType some data def properties of individual instantiations can be modified. The aggregation of InstantiationDataDefProps is subject to variability with the purpose to support the conditional existence of PortPrototypes Stereotypes: atpVariation Tags: vh.latestBindingTime=preCompileTime

Table 2.1: ParameterSwComponentType

[TPS_SWCT_01420] SwComponentType requiring access to shared calibration parameters needs RPortPrototype typed by a ParameterInterface [Every SwComponentType requiring access to shared calibration parameters will have an RPortPrototype typed by a ParameterInterface. The definition of this shared calibration access in the context of a CompositionSwComponentType will be defined by creating a SwConnector between the relevant SwComponentPrototypes.]()

Class	ParameterInterface			
Package	M2::AUTOSARTemplates::SWComponentTemplate::PortInterface			
Note	A parameter interface declares a number of parameter and characteristic values to be exchanged between parameter components and software components. Tags: atp.recommendedPackage=PortInterfaces			
Base	ARElement , ARObject , AtpBlueprint , AtpBlueprintable , AtpClassifier , AtpType , CollectableElement , DataInterface , Identifiable , MultilanguageReferrable , PackageableElement , PortInterface , Referrable			
Attribute	Type	Mult.	Kind	Note
parameter	ParameterDataPrototype	1..*	aggr	The ParameterDataPrototype of this ParameterInterface.

Table 2.2: ParameterInterface

[TPS_SWCT_01421] ParameterInterface is not restricted to parameters which can actually can be calibrated [Note that a ParameterInterface is not restricted to parameters which can actually can be calibrated. It can be used whenever there shall be no write access to the data during normal operation of the software, i.e. only constant data are visible over the interface.]()

The compatibility rules for `ParameterInterfaces` are described in chapter 6.4; the compatibility rules for `ParameterDataPrototypes` are described in chapter 6.4.4.

[TPS_SWCT_01422] Delegation of `PortPrototypes` typed by a `ParameterInterface` [Access to shared calibration parameters can be provided and required even over `CompositionSwComponentTypes` using `DelegationSwConnectors` and `AssemblySwConnectors`.

This means that each access to calibration parameters between `SwComponentPrototypes` is explicitly visible. If a `SwConnector` spans after the mapping of `SwComponentPrototypes` over two different ECUs the system generation process has to ensure the proper allocation of the `ParameterDataPrototype` while the calibration system has to cope with setting the parameter synchronously on the affected ECUs.]()

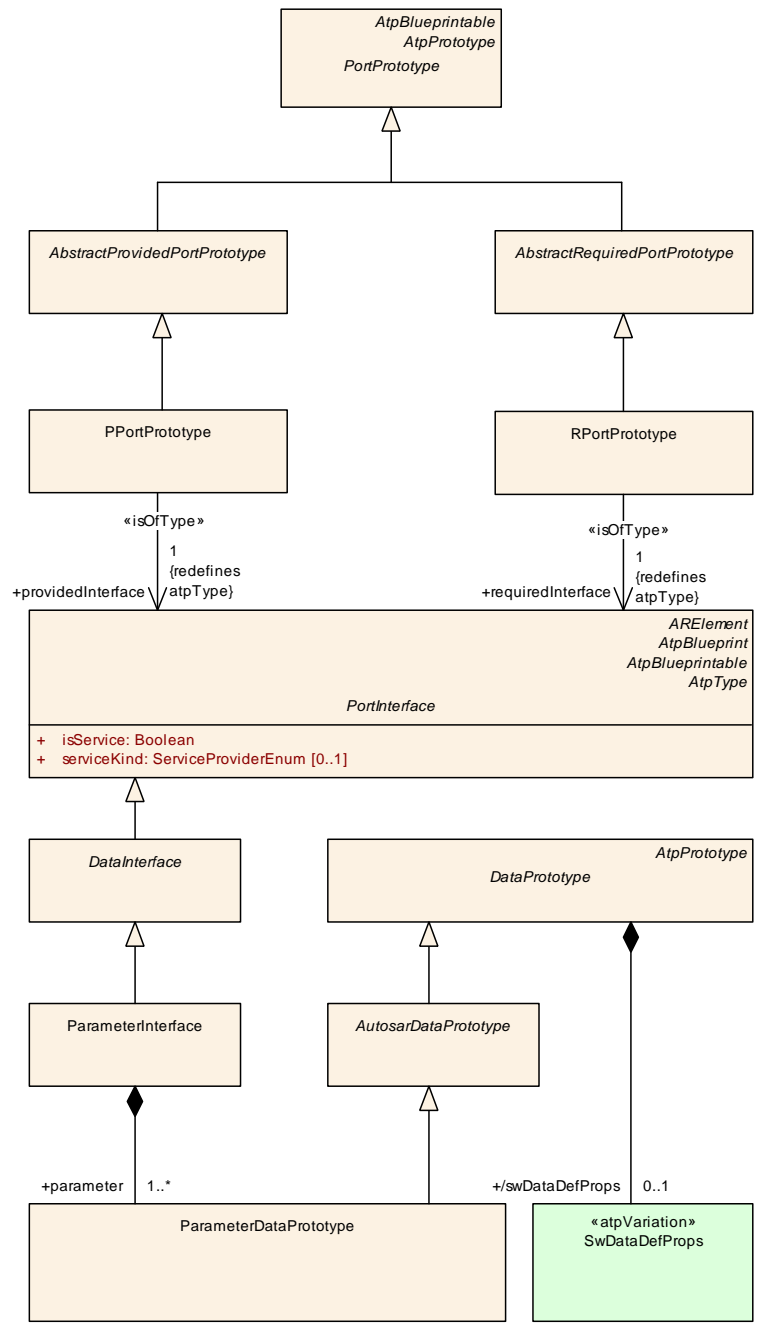

Figure 2.2: ParameterInterface

2.2.3.2 Sharing Calibration Parameters between SwComponentPrototypes of the Same SwComponentType

To share calibration parameters between several *SwComponentPrototypes* of the same *SwComponentType*, a *ParameterDataPrototype* is attached to an *SwcInternalBehavior* in *sharedParameter* role (see [TPS_SWCT_01418]).

When the `SwcInternalBehavior` is aggregated by an `AtomicSwComponentType` the actual calibration parameters of the `ParameterDataPrototype` is the same for all `SwComponentPrototypes`.

[TPS_SWCT_01423] `ParameterDataPrototype` aggregated in the role `constantMemory` [Additionally, it is possible to describe the implementation of shared characteristic values via a `ParameterDataPrototype` which is attached to an `SwcInternalBehavior` in the role `constantMemory`.

In contrast to the `ParameterDataPrototype` in `sharedParameter` role this kind of memory is not instantiated by the RTE. This supports more efficient implementations (especially for software components provided as object code) by avoidance of the additional indirection caused by the RTE's component data structure.]()

Further on this kind of memory reduces the dependencies of the software-component's implementation to generated RTE code which is appreciated for safety related functionalities.

Nevertheless, the information about these characteristic values has to be taken into account for the A2L file generation.

A typical example for this kind of sharing code between instances is dealing with two lambda sensors in multiple cylinder-bank engines, where (at least) two `SwComponentPrototypes` for each lambda sensor will use the very same Calibration Parameters.

2.2.3.3 Providing Instance Individual Characteristic Data

[TPS_SWCT_01424] `ParameterDataPrototype` aggregated in the role `perInstanceParameter` [To provide instance individual calibration parameters a `ParameterDataPrototype` is owned by a `SwcInternalBehavior` in `perInstanceParameter` role.

When the `SwcInternalBehavior` is attached to an `AtomicSwComponentType`, the actual calibration values are specific for each `SwComponentPrototype`.]()

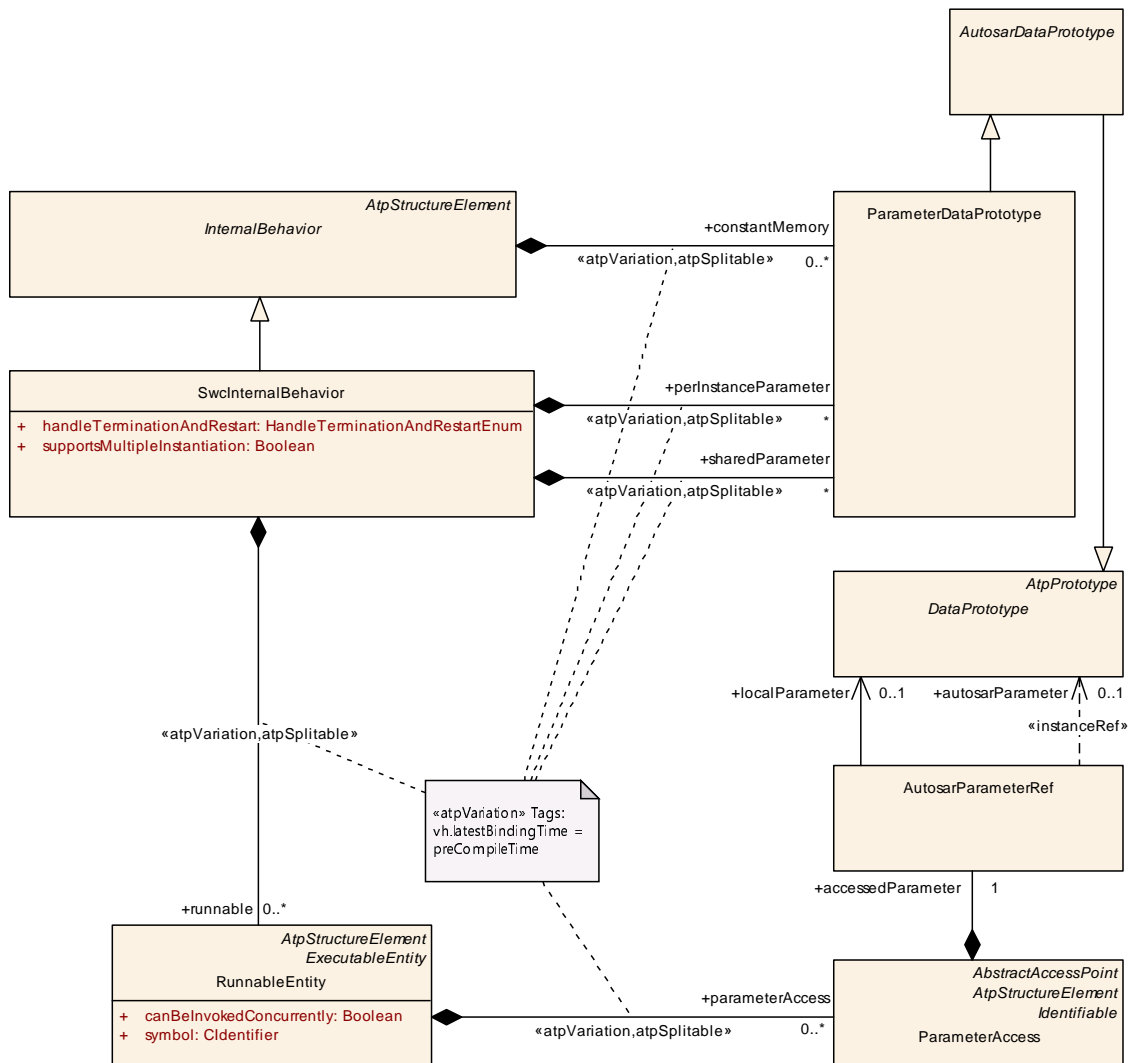

Figure 2.3: ParameterDataPrototypes in internal behavior

2.3 Runtime and Data Consistency Aspects

2.3.1 Background: the Issues

This section gives some background information and lists possible strategies concerning the implementation of the `RunnableEntity`s and the RTE with respect to efficient communication between the `RunnableEntity`s.

The communication among `RunnableEntity`s can very efficiently be implemented by means of “sharing memory”¹.

¹Please note that the term “sharing memory” can be interpreted on different levels. It is e.g. in the C language possible to use variables with external linkage (a.k.a. “global variables”, although this term is not officially defined by the C language) for the purpose of inter-Runnable communication.

This is technically feasible because it is always guaranteed that the `RunnableEntities` within an `AtomicSwComponentType` are always gathered at a specific processing unit (in other words: distribution is not an option).

Note that the purpose of communication among the `RunnableEntities` is to establish a data flow scheme. The latter is a very popular pattern in the application of control theory to automotive embedded systems. So if “global variables” are used for establishing internal communication among `RunnableEntities` they acquire the semantics of so called state-messages.

Nevertheless, directly sharing memory between `RunnableEntities` requires a serious problem to be solved: the guarantee of data consistency among communicating `RunnableEntities`. The `RunnableEntities` will indeed be mapped to tasks so that one `RunnableEntity` of an `AtomicSwComponentType` may be preempted by a different `RunnableEntity` of the same `AtomicSwComponentType`.

Please note that a purist approach to achieving data consistency not only applies to single accesses of concurrently accessed variables. Rather, it would not be permitted that the value of a concurrently accessed variable (with state-message semantics) is unintentionally changed during the run-time of a `RunnableEntity`.

The following paragraphs describe some common strategies that can be used to ensure the required data-consistency. We do not attempt to describe the pros or cons of these approaches.

2.3.1.1 Mutual Exclusion with Semaphores

Multi-threaded operating systems provide mutexes (mutual exclusion semaphores) that protect access to an exclusive resource that is used from within several tasks.

The RTE could use these OS-provided mutexes to make sure that the `RunnableEntities` sharing a memory-space would never run concurrently. The RTE would make sure the task running the `RunnableEntity` has taken an appropriate mutex before accessing the memory shared between the `RunnableEntities`.

2.3.1.2 Interrupt Disabling

Another alternative would be the disabling of interrupts during the run-time of `RunnableEntities` or at least for a period in time identical to the interval from the first to the last usage of a concurrently accessed variable in a `RunnableEntity`. This approach could lead to seriously non-deterministic execution timing.

2.3.1.3 Priority Ceiling

Priority ceiling allows for a non-blocking protection of shared resources. Provided that the priority scheme is static, the AUTOSAR OS is capable of temporarily raising the priority of a task that attempts to access a shared resource to the highest priority of all tasks that would ever attempt to access the resource.

By this means is technically impossible that a task in temporary possession of a resource is ever preempted by a task that attempts to access the resource as well.

2.3.1.4 Implicit Communication by Means of Variable Copies

Another alternative is the usage of copies of concurrently accessed variables with state message semantics. Note that this approach directly corresponds to the semantics of “implicit” sender-receiver communication (see 7.5.1.2).

This means in particular that for a concurrently used variable a copy is created on which a `RunnableEntity` entity can work without any danger of data inconsistency.

This concept requires additional code to write the value of the concurrently accessed variable to the copy before the `RunnableEntity` that accesses the variable is executed. The value of the copy shall be written back to the concurrently accessed variable after the `RunnableEntity` has been terminated.

This concept is sketched in Figure 2.4. Since it would be too expensive and error-prone to manually care about the copy routines it would be a good idea to leave the creation of the additional code to a suitable code generator.

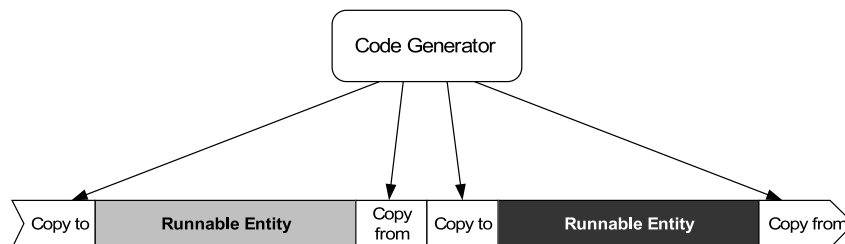

Figure 2.4: Generation of copy routines around `RunnableEntity`s

The additional copy routines as sketched in Figure 2.4 already protect the particular `RunnableEntity`s from unintended changes of concurrently accessed variables. It would, however, be possible to further optimize the process by reducing the additional code at the beginning and end of each task (see Figure 2.5).

2.3.2 Data Consistency at Runtime

In addition, copy routines will only be inserted where appropriate, e.g. a copy routine for writing the value of a copy back to the concurrently accessed variable will only be inserted if the `RunnableEntity` has write-access to the concurrently used variable.

Please note that the copy routines have to temporarily make sure that the copy process is not interrupted in order to be capable of consistently copying the values from and to the concurrently accessed variable.

These periods, however, are supposed to be very short compared with the overall run-time consumption of the `RunnableEntity` and thus would not have a significant impact on the runtime behavior.

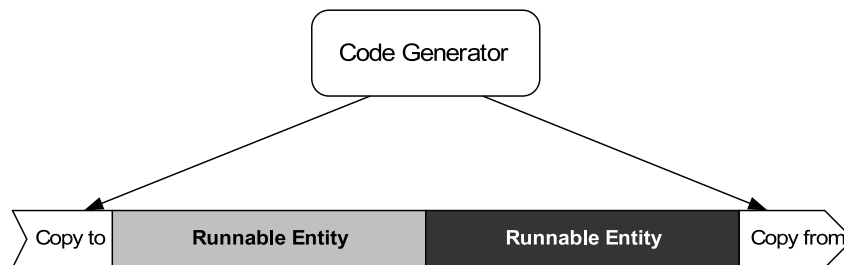

Figure 2.5: Optimized insertion of copy routines

Further optimization criteria can be applied, for example: it would be perfectly safe to avoid the creation of copies for `RunnableEntity`s that are scheduled in the task with the highest priority of all tasks that (via contained `RunnableEntity`s) access a certain concurrently accessed variable.

In order to keep the application code free of any dependencies from the code generation, access to concurrently accessed variables will be guarded by macros that are later resolved by the code generator.

The presence of the guard macros directly supports reuse on the level of source code. Reuse on the level of object code is only possible if the scheduling scenario (in terms of the assignment of `RunnableEntity`s to priority levels) does not change.

This concept can only be implemented properly with the aid of a code generator if the variables in question can be identified. In other words: the description of an `AtomicSwComponentType` has to expose all concurrently accessed variables to the outside world.

2.3.3 Modeling Aspects of Data Consistency

The intrinsic meaning of the terms “explicit communication” and “implicit communication” is explained in section 7.5.1.1. It would be fair to say that the distinction between

implicit and explicit communication establishes a usage pattern in the application domain, i.e. in the world of the developer of AUTOSAR software-components and their implementation.

There is another facet to this subject, however, namely the question of how this pattern is implemented in the meta-model. With respect to the application of the pattern for port-based communication the details can be found in section 7.5.1.2, more specifically in section 7.5.1.3. The consideration of the internal communication based on so-called “inter-runnable variables” is described in section 7.4.2.

By reading the respective text sections it becomes apparent that the two applications of the pattern are modeled differently. The port-based communication uses the `VariableAccess` to formalize different roles of accessing communication elements. Some roles used for this purpose imply explicit communication (e.g. `dataSendPoint`) and some represent implicit communication (e.g. `dataWriteAccess`).

The important thing about using the `VariableAccess`, however, is that the modeling of communication roles is abstracted from the actual communication elements and represents a uniform (meaning: it can refer to the target directly or by a so-called `InstanceRef`) modeling approach that is applied for all use cases².

Admittedly, this is handled differently for the internal communication. Here, the additional layer of abstraction is not used (although it would have been technically feasible to do so) with respect to the clear separation of “inter-runnable variables with implicit behavior” and “inter-runnable variables with explicit behavior” in the RTE. The implementation of different communication roles (i.e. implicit vs. explicit) is done by directly aggregating `VariableDataPrototype` in the roles `explicitInterRunnableVariable` and `implicitInterRunnableVariable`.

On the other hand, access to internal communication **never** requires the usage of an `InstanceRef` and therefore the abstraction might be considered unnecessary overhead that blows up the M1 model.

2.4 Variant Handling in the Software Component Template

The Software Component Template supports the creation of *Variants* in a subset of its model elements. The full list of model elements that support variation can be found in the appendix.

[TPS_SWCT_01038] Support for Variant Handling in the in Software Component Template [The Variant Handling support in the in Software Component Template is mainly driven by the purpose to describe a variable system on Virtual Functional Bus[3] level by varying

- the existence of `SwComponentPrototypes`

²On a related note, even for non-communication related data access the same pattern applies implemented by `ParameterAccess`

- the existence of `SwConnectors`
- the existence of `Chapters` of `SwComponentDocumentation`
- the existence of `PortPrototypes`

]([RS_SWCT_00220](#), [RS_SWCT_03100](#), [RS_SWCT_03140](#), [RS_SWCT_03142](#), [RS_SWCT_03154](#))

[TPS_SWCT_01039] Purpose of variant handling [This supports adjusting the number and kind of software-component instances as well as their interconnection in a particular system variant.]([RS_SWCT_00220](#))

[TPS_SWCT_01447] Applicable binding times for model elements in the scope of the Software Component Template [The first three cases are supporting *PostBuild* binding. For the existence of `PortPrototypes` only `preCompileTime` is supported as latest `Binding Time`.]([RS_SWCT_00220](#))

[TPS_SWCT_01040] `SwConnector` exists depending on a *PostBuild* condition [A `SwConnector` which exists depending on a *PostBuild* condition has an impact on the behavior of API function calls that apply on a `PortPrototype` to which the `SwConnector` is attached. If the `SwConnector` does not exist, the behavior of the RTE API functions need to take this into account. This means that the RTE implementation of this `PortPrototype` resembles the behavior of an unconnected `PortPrototype`.]([RS_SWCT_00220](#), [RS_SWCT_03100](#), [RS_SWCT_03143](#))

Please find more details in the specification of the RTE [2].

[TPS_SWCT_01041] API functions of not existing `SwConnector` are still part of the software-component's implementation [If `SwConnectors` do not exist, the corresponding API functions are still part of the software-component's implementation. It is not possible to remove the API functions in a *PostBuild* step. Therefore, the latest reasonable `Binding Time` for the conditional existence of a `PortPrototype` is `preCompileTime`.]([RS_SWCT_00220](#), [RS_SWCT_03100](#))

[TPS_SWCT_01085] Variation on the behavior level [In addition to variation of the VFB-related model elements, the description of variant software-component implementations is supported. Please note that this requires a broad support of variability in the *Internal Behavior*.

The identified main use case are

- the existence of `RunnableEntitys`
- the existence of `RTEEvents`
- the existence of `VariableDataPrototypes` in the roles `implicitInterRunnableVariable` and `explicitInterRunnableVariable`
- the existence of `ParameterDataPrototypes` in the roles `perInstanceParameter`, `sharedParameter`, and `constantMemory`

]([RS_SWCT_03149](#), [RS_SWCT_03150](#), [RS_SWCT_03151](#), [RS_SWCT_03153](#))

For the same reason that applies on the existence of `PortPrototype` the latest Binding Time of these kinds of variability is `preCompileTime`.

In the meta-model, all locations that may exhibit variability are marked with the stereotype `<<atpVariation>>`. This allows the definition of possible variation points. Tagged Values are used to specify additional information, for example the latest binding time.

[TPS_SWCT_01042] Four types of locations in the meta-model which may exhibit variability [There are four types of locations in the meta-model which may exhibit variability:

- Aggregations
- Associations
- Attribute Values
- Classes providing property sets

]([RS_SWCT_00220](#), [RS_SWCT_03100](#))

The reasons for the attachment of the stereotype `<<atpVariation>>` to certain model elements and the consequences for other model elements are explained in class tables in the following chapters. More details about the AUTOSAR Variant Handling Concept can be found in the AUTOSAR Generic Structure Template [11].

2.5 Communication Specification of Composition Component Types

[TPS_SWCT_01088] ComSpecs defined by `CompositionSwComponentTypes` [It shall be possible to attach `ComSpecs` to `PortPrototypes` owned by `CompositionSwComponentTypes`.]([RS_SWCT_03220](#))

2.5.1 Rationale

`ComSpecs` attached to a `PortPrototype` owned by an `AtomicSwComponentType` have a direct impact on the generation of the RTE. The RTE Generator, on the other hand, does not consider the existence of `CompositionSwComponentTypes`.

Nevertheless, there are some cases where the definition of a `ComSpec` attached to a `PortPrototype` owned by a `CompositionSwComponentType` does make sense.

That is, in case an OEM wants to submit the definition of a `CompositionSwComponentType` to a supplier for adding more details and implementing the behavior the OEM might want to point out that from the OEM's point of view sender `initValues` and receiver `initValues` apply for the elements of `PortInterfaces` used to type the delegation `PortPrototypes`.

The idea is that the supplier takes over the `initValues` attached to the delegation `PortPrototypes` and *copies* them to the `PortPrototypes` owned by `SwComponentPrototypes` of the `CompositionSwComponentType`.

[TPS_SWCT_01568] Consideration of `RPortComSpec` or `PPortComSpec` depending on the ownership [The RTE Generator shall take the attributes of the `RPortComSpec` or `PPortComSpec` of the `PortPrototypes` owned by `AtomicSwComponentTypes` or `ParameterSwComponentType` and ignore the attributes of the `RPortComSpec` or `PPortComSpec` attached to `PortPrototypes` owned by `CompositionSwComponentType`.] (*RS_SWCT_03220*)

Therefore, the `initValues` of the delegation `PortPrototype` would be taken as *mere templates* for the detailing of `PortPrototypes` connected to the delegation `PortPrototypes`.

It is not required that the `initValues` of delegated `PortPrototype` and a `PortPrototype` connected by means of a `DelegationSwConnector` match.

Although this would certainly make sense in many cases, it is eventually still left to the supplier to decide on the specific `initValues` applicable inside the `CompositionSwComponentType`.

On the other hand, a requirement that the `initValues` defined on the surface of `CompositionSwComponentType` and the inside of the `CompositionSwComponentType` shall be consistent in any case might effectively prevent reuse of existing `AtomicSwComponentTypes`.

Please note that the ability to define a `ComSpec` in the context of a `CompositionSwComponentType` implies that it shall be possible to define mappings of `ApplicationDataTypes` used in a `PortInterface` to their corresponding `ImplementationDataTypes`.

For this purpose the `CompositionSwComponentType` owns a `DataTypeMappingSet` in the role `dataTypeMapping` and a `ConstantSpecificationMappingSet` in the role `constantValueMapping`.

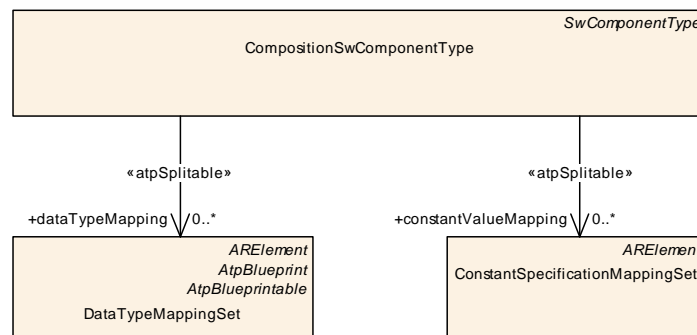

Figure 2.6: Specification of data type mapping for `CompositionSwComponentType`

2.6 PRPortPrototype

In some cases `SwComponentTypes` need to read and write the same piece of data. One of the most prominent examples for this use case is the `NvBlockSwComponentType` that factually reads and writes blocks of NvRAM.

Without the ability to combine read and write semantics in a kind of `PortPrototype` that supports both read and write semantics work-arounds have to be implemented that come with a certain footprint on memory and processing time.

2.6.1 Use Case 1

Without the ability to define a combined read and write semantics the definition of an `RPortPrototype` and a `PPortPrototype` is required for reading and writing the applicable data.

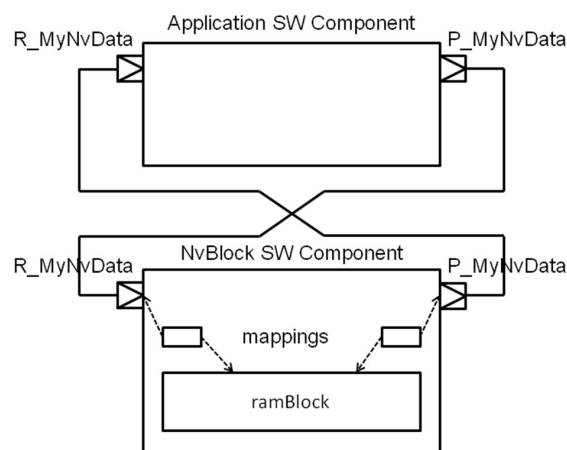

Figure 2.7: Use Case 1 for the existence of `PRPortPrototype`

Technically, this read and write access is related to the same data item in an NVRAM Block. This requires a consistent connection of the `PortPrototypes` between an `NvBlockSwComponentType` and `ApplicationSwComponentType` as well as a consistent mapping of the corresponding `RPortPrototype` and a `PPortPrototype` of the `NvBlockSwComponentType` and the related element of the `ramBlock`.

2.6.2 Use Case 2

It may happen that a `SwComponentType` need to consume the same data that it produces. If the only way to achieve this was the connection of a `PPortPrototype` to an `RPortPrototype` of the same `SwComponentType` then the creator of the `SwComponentType` cannot enforce this connection as it is created on a higher level of abstraction in the context of a `CompositionSwComponentType`.

In other words, it is impossible to fully specify the semantics of the otherwise self-contained `SwComponentType`.

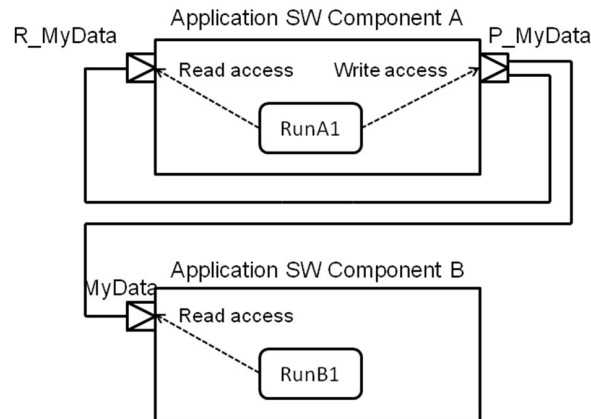

Figure 2.8: Use Case 2 for the existence of `PRPortPrototype`

This means that only in the in best case one buffer for the data is needed. But depending on the mapping `RunnableEntity` to OS tasks additional buffers may need to be allocated by the RTE to fully implement the implicit communication pattern.

As an alternative, the `ApplicationSwComponentType` could utilize inter-runnable variables but unfortunately this inhibits any optimization in the RTE and will consume additional RAM. In contrast to the previous approach at least two buffers are needed.

2.6.3 Use Case 3

In this scenario, several `ApplicationSwComponentTypes` are iterating over the same large set of data. This means each `ApplicationSwComponentType` implements one out of many steps of a complex data processing algorithm applied to the same piece of data.

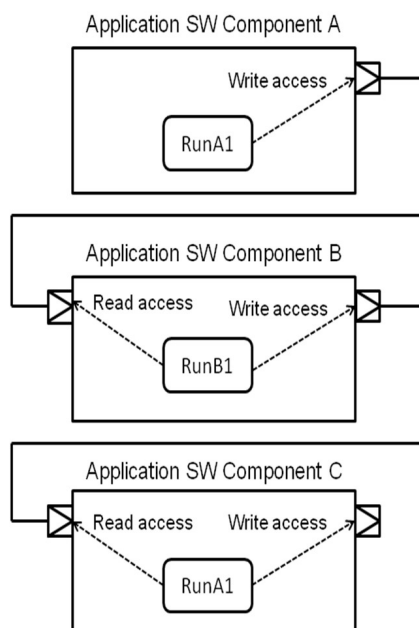

Figure 2.9: Use Case 3 for the existence of [PRPortPrototype](#)

For example, this scenario may apply for video signal processing in camera applications. Typically, such applications will **not** be distributed over several ECUs.

It is clear that in this case the allocation of several buffers in the RTE is required to implement the individual connections between the [ApplicationSwComponentTypes](#). In most cases, the processing has to be executed at a certain point in time in a dedicated order.

2.6.4 Solution

The solution to the above-mentioned use cases is the ability to define a [PortPrototype](#) that can read and write the same piece of data. This solves both the described problem of resource consumption and the problem of having to define multiple [PortPrototypes](#) as outlets for same piece of data item.

The technical details of the definition of [PRPortPrototype](#) are explained in chapters [3.2.2](#) and [4.2.1](#).

2.7 Pretended Networking

[TPS_SWCT_01510] The role of pretended networking [Pretended networking is a feature to reduce energy consumption of an ECU by switching the ECU in a mode called `Pretended Networking`. In this mode the communication on communication networks is reduced and the ECU can go into power saving modes.

When communication via communication networks is required, the mode `Pretended Networking` shall be left by request of a mode change to `Normal Mode`.]()

[TPS_SWCT_01511] Configuration option is encoded into ModeDeclaration [The identification of different configuration options for `Pretended Networking` shall be encoded into the definition of dedicated `ModeDeclarations` inside a `ModeDeclarationGroup`.] (*RS_SWCT_03110*)

For example, assume that an implementation of pretended networking supports three configuration options:

- `PRETENDED_NW_MODE_OFF`
- `PRETENDED_NW_MODE_ONE`
- `PRETENDED_NW_MODE_TWO`

In this example case, a `ModeDeclarationGroup` consisting of three `ModeDeclarations` shall be defined where each `ModeDeclaration` shall represent one of the above-mentioned configuration options. The `shortNames` of the `ModeDeclaration` shall be taken from the above-mentioned list.

[TPS_SWCT_01512] Request change of Pretended Networking mode [A `SwComponentType` that needs to be able to request a change in the operating mode of `Pretended Networking` shall provide a `PPortPrototype` typed by a `SenderReceiverInterface` (see [TPS_SWCT_01086]) for requesting a change (towards the `BswM` [14]) of the `Pretended Networking` mode.

It is out of the scope of this document to define the particular properties of the applicable `SenderReceiverInterface`. The details of this specific `SenderReceiverInterface` can be found in the specification of the `BswM` [14].] (*RS_SWCT_03110*)

More details about how a mode change is requested can be found in section 9.

[TPS_SWCT_01513] React on the change of Pretended Networking mode [A `SwComponentType` that needs to be able to react on a change in the operating mode of `Pretended Networking` shall provide an `RPortPrototype` typed by a `ModeSwitchInterface` (see [TPS_SWCT_01087]) for reacting on a change (initiated by the `BswM` [14]) of the `Pretended Networking` mode.

It is out of the scope of this document to define the particular properties of the applicable `ModeSwitchInterface`. The details of this specific `ModeSwitchInterface` can be found in the specification of the `BswM` [14].] (*RS_SWCT_03110*)

2.8 Variable-size Array Data Types

2.8.1 Overview and Use cases

AUTOSAR supports the definition of array data types where the size of the actual payload varies at run-time. As far as the configuration is concerned, it is possible to specify a maximum number of array elements that shall not be exceeded at run-time.

In order to properly understand the approach, it is necessary to understand that the support for `Variable-Size Array Data Types` has been introduced in two waves that each had a different motivation.

2.8.1.1 “Old-world” dynamic-size Arrays

In the first wave, the support for `Variable-Size Array Data Types` was limited to data types that basically boil down to an array where the base type is an unsigned integer data type with a length of exactly one byte.

The main use cases for this scenario are derived from diagnostics requirements as well as support for the J1939 communication protocol.

In both cases the actual length of a `Variable-Size Array Data Type` could be determined from the context, i.e. either by the diagnostic basic-software module or by the implementation of the J1939 TP.

For the lack of a better terminology, this specification distinguishes between “old-world” dynamic-size arrays and “new-world” `Variable-Size Array Data Types`. It will be necessary to clearly define the characteristics that allow for a disambiguation between the “old-world” dynamic-size arrays and “new-world” `Variable-Size Array Data Types`.

[TPS_SWCT_01641] Definition of an “old-world” dynamic-size array data type by means of an `ApplicationArrayDataType` [An `ApplicationArrayDataType` that **doesn't define** attribute `dynamicArraySizeProfile` **and** that aggregates an `ApplicationArrayElement` where attribute `arraySizeSemantics` exists and is set to the value `variableSize` shall be considered an “old-world” dynamic-size array data type.] ([RS_SWCT_03181](#))

Please note that [TPS_SWCT_01641] can't go any deeper into the specifics of the given data type because it is intentionally focused on `ApplicationDataTypes`. There are use cases where the distinction between “old-world” dynamic-size arrays and “new-world” `Variable-Size Array Data Types` shall be done in the absence of a corresponding `ImplementationDataType`.

In general, the disambiguation becomes multi-faceted (but not necessarily easier) if the definition of a corresponding `ImplementationDataType` is available (see [TPS_SWCT_01642]).

[TPS_SWCT_01642] Definition of an “old-world” dynamic-size array data type by means of an `ImplementationDataType` [An `ImplementationDataType` that (after all type references are resolved) fulfills all the following conditions shall be considered an “old-world” dynamic-size array data type:

- The value of attribute `category` is set to `ARRAY`
- The `ImplementationDataType` doesn't define the attribute `dynamicArraySizeProfile`
- The `ImplementationDataType` aggregates a `subElement` where
 - attribute `arraySizeSemantics` exists and is set to the value `variableSize`
 - attribute `arraySizeHandling` does not exist
- The `ImplementationDataType.swDataDefProps.baseType` exists and the attribute
 - `baseTypeEncoding` exists and is set to the value `NONE`
 - `baseTypeSize` exists and is set to the value `8`

](*RS_SWCT_03181*)

By and large, the defining characteristics for “old-world” dynamic-size arrays is the **absence** of a definition of the attribute `ApplicationArrayDataType.dynamicArraySizeProfile` or `ImplementationDataType.dynamicArraySizeProfile`.

By regulation of [constr_1387], “old-world” dynamic-size arrays are not supported for transmission by means of a data transformer. The only supported kind of `Variable-Size Array Data Type` that can be transmitted using a data transformer is the “new-world” variable-size arrays.

2.8.1.2 “New-world” variable-size Arrays

In contrast to this, the second wave of support for `Variable-Size Array Data Types` was motivated by the application software layer itself.

Here, the situation is entirely different because the actual size cannot be determined by any context software module. The application itself is responsible for maintaining the proper length of a `Variable-Size Array Data Type` at run-time.

As a consequence, the specification of the actual array size at run-time needs to be reflected by the structure of the data types used for hosting the `Variable-Size Array Data Type`.

[TPS_SWCT_01644] Definition of a “new-world” variable-size array data type by means of an `ApplicationArrayDataType` [An `ApplicationArrayDataType`

that fulfills all the following conditions shall be considered an “new-world” dynamic-size array data type.

- The `ApplicationArrayType` **defines** attribute `ApplicationArrayType.dynamicArraySizeProfile`.
- `ApplicationArrayType` aggregates an `ApplicationArrayElement` that **defines** attribute `ApplicationArrayElement.arraySizeHandling`.

](RS_SWCT_03181)

[TPS_SWCT_01645] Definition of a “new-world” variable-size array data type by means of an `ImplementationDataType` [An `ImplementationDataType` that fulfills all the following conditions shall be considered an “new-world” dynamic-size array data type.

- The `ImplementationDataType` **defines** attribute `ImplementationDataType.dynamicArraySizeProfile`.
- `ImplementationDataType` aggregates an `ImplementationDataTypeElement` that **defines** attribute `ImplementationDataTypeElement.arraySizeHandling`.

](RS_SWCT_03181)

In contrast to the first use case described above, the application-motivated `Variable-Size Array Data Type` cannot be limited in terms of the base type of the array data type, i.e. limiting the underlying data type to an unsigned integer data type with a length of exactly one byte is not an option.

On top of that, several possible structures of `Variable-Size Array Data Types` have been required. This aspect is depicted in Figure 2.10.

[TPS_SWCT_01636] Definition of profiles for the definition of `Variable-Size Array Data Types` [The possible variants for `Variable-Size Array Data Types` are:

Linear The data type of the elements of the `Variable-Size Array Data Type` itself does not consist of a `Variable-Size Array Data Type`.

This case corresponds to the possible value `VSA_LINEAR` of attribute `dynamicArraySizeProfile`.

Square The data type of the elements of the `Variable-Size Array Data Type` itself consists of `Variable-Size Array Data Types` where the maximum number of elements in all “second order” arrays is **identical** to the maximum number of elements in the “first order” array.

This case corresponds to the possible value `VSA_SQUARE` of attribute `dynamicArraySizeProfile`.

Rectangular The data type of the elements of the [Variable-Size Array Data Type](#) itself consists of [Variable-Size Array Data Types](#) where the maximum number of elements in “second order” arrays is **identical** but this value is typically **not identical**³ to the maximum number of elements in the “first order” array.

This case corresponds to the possible value **VSA_RECTANGULAR** of attribute [dynamicArraySizeProfile](#).

Fully Flexible The data type of the elements of the [Variable-Size Array Data Type](#) itself consists of [Variable-Size Array Data Types](#) where the maximum number of elements in “second order” arrays is **not necessarily identical** with each other and (obviously) **not necessarily identical** to the maximum number of elements in the “first order” array.

This case corresponds to the possible value **VSA_FULLY_FLEXIBLE** of attribute [dynamicArraySizeProfile](#).

|(RS_SWCT_03181)

The described cases directly correspond to the portrayal of different kinds of variable-size arrays in Figure 2.10:

- The value [VSA_LINEAR](#) corresponds to the tag (a).
- The value [VSA_SQUARE](#) corresponds to the tag (b).
- The value [VSA_RECTANGULAR](#) corresponds to the tag (c).
- The value [VSA_FULLY_FLEXIBLE](#) corresponds to the tag (d).

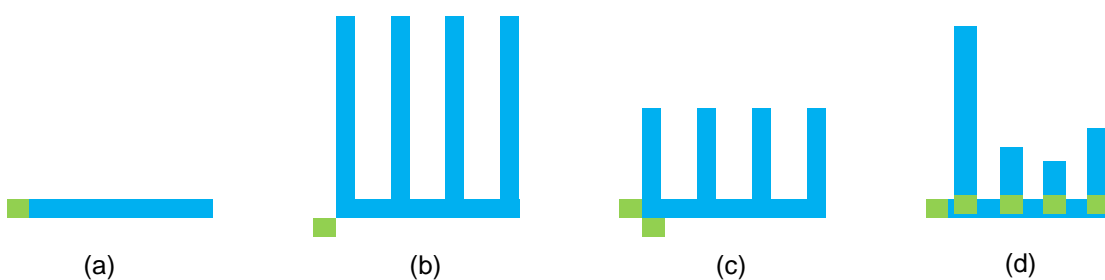

Figure 2.10: Structural variety of array data types with variable size

Please note that the leaf elements in a [Variable-Size Array Data Type](#) doesn't have to be primitive data types. As mentioned before, it is possible to define multiple-dimension [Variable-Size Array Data Types](#).

The “terminal” elements can be recognized as such in that they don't establish further [Variable-Size Array Data Types](#).

³If it was, the case boils down to the rectangular scenario tagged (b).

Please note further that the modeling of [Variable-Size Array Data Types](#) is a complex step governed by a collection of rules and constraints.

It is the expressed intent of this specification to keep the complexity of the rule set as low as possible while still providing the user with a powerful modeling framework.

The major consequence of this conclusion is to keep the modeling as straightforward as possible; in other words: intentionally cut away certain modeling variants for which acceptable workarounds within the modeling framework itself exist.

One concrete example for such a restriction is that for [ImplementationDataTypes](#), [Variable-Size Array Data Types](#) can only be defined on the level of an [AutosarDataType](#).

It is intentionally not supported to define a [Variable-Size Array Data Type](#) on the level of an [ImplementationDataTypeElement](#) because the intended semantics can be realized by assigning the value `TYPE_REFERENCE` to the [ImplementationDataTypeElement.category](#) and then let it reference to another [ImplementationDataType](#) that in turn implements the [Variable-Size Array Data Type](#).

2.8.2 Modeling Aspects regarding Application Data Types

In the context of the AUTOSAR layered data type concept, the level of [ApplicationDataTypes](#) is not concerned about the structure of how the [Variable-Size Array Data Types](#).

In other words, aspects of the implementation of this kind of data type is intentionally abstracted as much as possible in order to support the idea behind the definition of [ApplicationDataTypes](#) as a concept that is independent of an implementation to the applicable degree.

Consequently, the support for [Variable-Size Array Data Types](#) on the level of [ApplicationDataTypes](#) requires the addition of a couple of additional attributes. Details can be found in chapter [5.2.4.2](#).

If a [Variable-Size Array Data Type](#) is modeled on the level of [ApplicationDataType](#) it is necessary to also provide a companion [ImplementationDataType](#) as well as a [DataTypeMap](#) that refers to both the [ApplicationDataType](#) and the [ImplementationDataType](#).

The contrary is **not applicable**, i.e. it is possible to define a [Variable-Size Array Data Type](#) with only an [ImplementationDataType](#), see [\[TPS_SWCT_01622\]](#).

2.8.3 Modeling Aspects regarding Implementation Data Types

On the other hand, the data type used for the actual hosting of the `Variable-Size Array Data Type` corresponds directly to the level of the `Implementation-DataType`.

Here, it is possible to define how an `ImplementationDataType` can be used to define a `Variable-Size Array Data Type`.

The definition of `ImplementationDataType` in the AUTOSAR meta-model comes with a certain level of generic nature the support for `Variable-Size Array Data Types` on this level comes as a mixture of dedicated attributes in the meta-model and a set of recipes how to support different use cases of `Variable-Size Array Data Types`.

This means that the definition of `ImplementationDataTypes` for the purpose of creating `Variable-Size Array Data Types` only has a chance to take off if the structure of these data types is replicated in different implementations of AUTOSAR software.

Therefore, AUTOSAR defines a common way of how `ImplementationDataTypes` for the purpose of creating `Variable-Size Array Data Types` shall be defined such that the `ImplementationDataType` shall be of `category` STRUCTURE with the following sub-elements:

1. A numerical value that determines the actual size. This element shall be called the `Size Indicator` throughout this document.
2. An array of the base-type of the `Variable-Size Array Data Type` that implements the payload of the `Variable-Size Array Data Type`. The dimension of the array shall be defined such that the intended maximum number of elements fits in.

A `Size Indicator` of a `Variable-Size Array Data Type` holds the number of valid elements of the array. This information is necessary for the RTE to handle the array efficiently.

On the sender-side this indicator is actively updated by the software-component, which is the only instance that knows how many elements of the array are valid.

So the number of valid elements and the `Size Indicator` have to be kept consistent by the application. When the software-component sends the data over to the RTE, the RTE hands the data over to the transformer.

The transformer may evaluate the `Size Indicator` (depends on the transformer) and only work on the valid array elements. The output of the transformer can vary in length and only contain necessary data. Therefore, it can be more resource saving.

On the receiver side, the last transformer in the execution order restores the data elements of the array and the value of the `Size Indicator`. This output is handed over

by the RTE to the software-component. The application is now aware of the number of valid elements in the array.

The details of how `ImplementationDataTypes` need to be modeled for the implementation of `Variable-Size Array Data Types` can be found in chapter 5.2.5 and a couple of examples is available in the appendix E.1.

2.9 Optional Elements in Structures

2.9.1 Background

The *AUTOSAR classic platform* supports the usage of a TLV⁴ data encoding on the SOME/IP transport layer. TLV is typically used where at least a part of the transmitted data is only *optionally* existing and filled with meaningful values.

In other words: an optional part of a data structure may exist and carry meaningful values in one instance of data transmission and be completely missing in another instance of the data transmission.

The receiving software needs to be able to identify whether the optional part exists and read its value accordingly.

The receiving software also needs to be able to still execute meaningfully if the optional part of such a data structure does not exist in the specific communication instance.

Consequently, it is necessary to be able to precisely identify the parts of a data structure that may become optional for specific instances of data transmission.

In terms of the AUTOSAR meta-model, the identification could - in principle - be attached at various levels of abstraction:

AutosarDataType In this case the optionality that is only needed for communication purposes would still be existing in all other usages of data types. This seems unbalanced.

Admittedly, the definition of different optionality configurations for the same data type may lead to the existence of a bunch of structurally identical data types that only vary in terms of optionality. The existence of variation points may help to mitigate this effect, though.

PortInterface In this case the optionality is defined where it is actually required. However, different optionality could - in principle - be defined for `DataPrototypes` typed by the same `AutosarDataType`.

This would lead to an increased effort for the definition of C data types in the context of the same `PortInterface`.

⁴This abbreviation stands for tag-length-value

Additional constraints have been identified in the context of the definition of RTE APIs of the AUTOSAR classic platform that finally render this option as not viable.

ComSpec In this case (for more information please refer to section 4.5) the definition of optionality would even be more specific in comparison to the definition of optionality on the level of `PortInterfaces`.

On top of that, the task to define optionality in the vast majority of cases is done by an OEM, whereas the model definition on the level of `ComSpec` requires the existence of `SwComponentTypes` and this definition is in many cases in the domain of a supplier.

As a result of this consideration, AUTOSAR has opted for implementation of the concept of defining the optionality on the level of the `AutosarDataType`.

3 Overview: Software Components, Ports, and Interfaces

3.1 Introduction

The detailed introduction of all aspects of the `Software Component Template` in one move is considered too complex. This chapter therefore provides an overview of the main conceptual aspects of software components, ports and interfaces. The overview will then be broken down into further details in chapter 4.

One of the goals of the AUTOSAR concept is the support of re-usability on the level of application software. In other words: it should be possible to re-use existing artifacts to create further model elements instead of being forced to create every single modeling detail from scratch. One of the consequences of this approach is the application of the so-called type-prototype pattern [11].

Among other things, this concept allows for creating hierarchical structures of software-components with arbitrary complexity. However, the creation of hierarchical structures itself does not have an impact on the run-time behavior of the overall system. The actual behavior is completely defined within the individual software-components.

This conclusion is backed by the understanding that software-components are developed against the so-called *Virtual Functional Bus* (VFB), an abstract communication channel without direct dependency on ECUs and communication buses. The VFB does not provide any means for expressing a hierarchy of software-components.

Of course, the usage of the VFB has further consequences on the design of software-components which shall not directly call the operating system or the communication hardware. As a result, software-components can be deployed to actual ECUs at a rather late stage in the development process.

In order to make the description more precise, the following text preferably uses accurate meta-model terms instead of the rather vague terminology of “composition” and “software-component”.

3.2 Software Component

3.2.1 Overview

Application software within AUTOSAR is organized in self-contained units called `AtomicSwComponentTypes`. Such `AtomicSwComponentTypes` encapsulate the implementation of their functionality and behavior and merely expose well-defined connection points, called `PortPrototypes`, to the outside world.

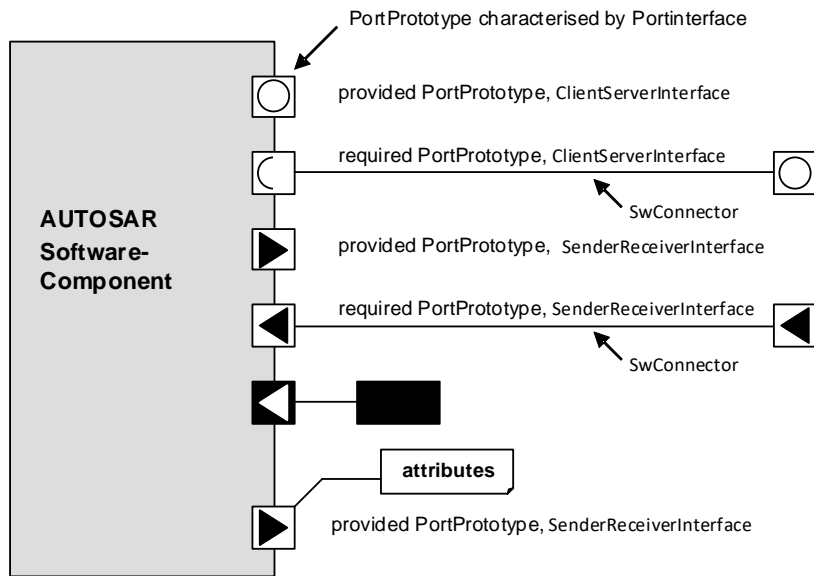

Figure 3.1: Graphical representation of software-components in AUTOSAR

The graphical appearance of AUTOSAR software-components according to [3] is depicted in Figure 3.1.

Class	<i>SwComponentType</i> (abstract)			
Package	M2::AUTOSARTemplates::SWComponentTemplate::Components			
Note	Base class for AUTOSAR software components.			
Base	ARElement , ARObject , AtpBlueprint , AtpBlueprintable , AtpClassifier , AtpType , CollectableElement , Identifiable , MultilanguageReferrable , PackageableElement , Referrable			
Subclasses	AtomicSwComponentType , CompositionSwComponentType , ParameterSwComponentType			
Attribute	Type	Mult.	Kind	Note
consistency Needs	ConsistencyNeeds	*	aggr	This represents the collection of ConsistencyNeeds owned by the enclosing SwComponentType. Stereotypes: atpSplitable; atpVariation Tags: atp.Splitkey=shortName, variationPoint.shortLabel vh.latestBindingTime=preCompileTime
port	PortPrototype	*	aggr	The PortPrototypes through which this SwComponent Type can communicate. The aggregation of PortPrototype is subject to variability with the purpose to support the conditional existence of PortPrototypes. Stereotypes: atpSplitable; atpVariation Tags: atp.Splitkey=shortName, variationPoint.shortLabel vh.latestBindingTime=preCompileTime
portGroup	PortGroup	*	aggr	A port group being part of this component. Stereotypes: atpVariation Tags: vh.latestBindingTime=preCompileTime





Class	SwComponentType (abstract)			
swComponentDocumentation	SwComponentDocumentation	0..1	aggr	This adds a documentation to the SwComponentType. Stereotypes: atpSplittable; atpVariation Tags: atp.Splitkey=swComponentDocumentation, variation Point.shortLabel vh.latestBindingTime=preCompileTime xml.sequenceOffset=-10
unitGroup	UnitGroup	*	ref	This allows for the specification of which UnitGroups are relevant in the context of referencing SwComponentType.

Table 3.1: SwComponentType

3.2.2 PortPrototype

Please note that [PortPrototypes](#) of a [SwComponentType](#) are supposed to be used for attaching [SwConnectors](#) that establish an actual connection between [SwComponentPrototypes](#) (see chapter 3.3).

[TPS_SWCT_01002] SwComponentTypes may only interact by means of their PortPrototypes [[AtomicSwComponentTypes](#) (and also the more general [SwComponentTypes](#) may only interact by means of their [PortPrototypes](#)). Hidden communication dependencies that are *not* expressed by means of [PortPrototypes](#) are strictly forbidden.]([RS_SWCT_00020](#), [RS_SWCT_00030](#), [RS_SWCT_00150](#), [RS_SWCT_00160](#), [RS_SWCT_00200](#), [RS_SWCT_00210](#), [RS_SWCT_02010](#), [RS_SWCT_02030](#))

Therefore, software-components are in theory exchangeable as long as they implement the same functionality and provide the same public communication interface to the remaining system.

Class	PortPrototype (abstract)			
Package	M2::AUTOSARTemplates::SWComponentTemplate::Components			
Note	Base class for the ports of an AUTOSAR software component. The aggregation of PortPrototypes is subject to variability with the purpose to support the conditional existence of ports.			
Base	ARObject , AtpBlueprintable , AtpFeature , AtpPrototype , Identifiable , MultilanguageReferrable , Referrable			
Subclasses	AbstractProvidedPortPrototype , AbstractRequiredPortPrototype			
Attribute	Type	Mult.	Kind	Note
clientServerAnnotation	ClientServerAnnotation	*	aggr	Annotation of this PortPrototype with respect to client/server communication.
delegatedPortAnnotation	DelegatedPortAnnotation	0..1	aggr	Annotations on this delegated port.
ioHwAbstractionServerAnnotation	IoHwAbstractionServerAnnotation	*	aggr	Annotations on this IO Hardware Abstraction port.





Class	PortPrototype (abstract)			
modePort Annotation	ModePortAnnotation	*	aggr	Annotations on this mode port.
nvDataPort Annotation	NvDataPortAnnotation	*	aggr	Annotations on this non volatile data port.
parameterPort Annotation	ParameterPortAnnotation	*	aggr	Annotations on this parameter port.
senderReceiver Annotation	SenderReceiverAnnotation	*	aggr	Collection of annotations of this ports sender/receiver communication.
triggerPort Annotation	TriggerPortAnnotation	*	aggr	Annotations on this trigger port.

Table 3.2: PortPrototype

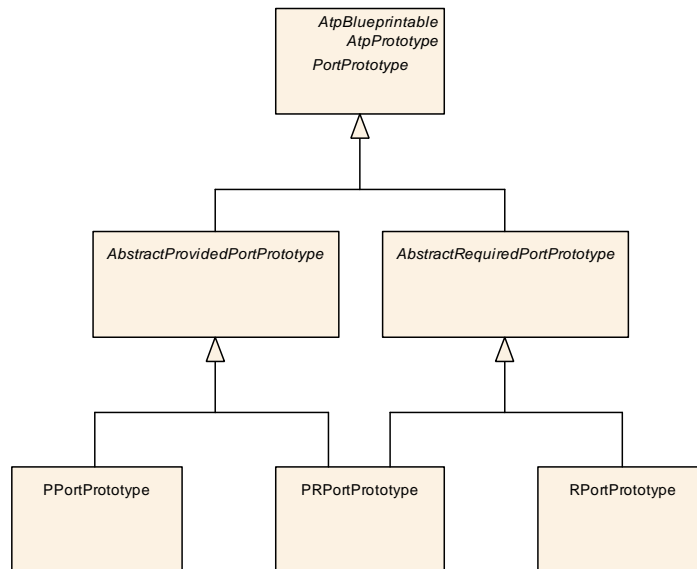

Figure 3.2: Overview of PortPrototype

[TPS_SWCT_01111] **PortPrototypes** need an additional model artifact, the **PortInterface** [Please note that **PortPrototypes** actually need an additional model artifact, the **PortInterface**, for fully describing the details of the **PortPrototype**.] (RS_SWCT_00010)

The concept of the **PortInterface** as another means for establishing a high degree of re-usability is described in chapter 3.4.

[TPS_SWCT_01112] **Semantics of PortPrototypes** [PortPrototypes can have the following semantics:

- A require-port (in technical terms: **RPortPrototype**) requires certain services or data.
- A provide-port (or **PPortPrototype**) on the other hand provides services or data.
- A provide-require-port (or **PRPortPrototype**) combines the ability to provide and require services or data in one entity.

](RS_SWCT_03250)

The semantics of `PortPrototype` is also depicted in Figure 3.2,

[TPS_SWCT_01573] A `PRPortPrototype` is never considered unconnected [A `PRPortPrototype` is never considered unconnected, even if there are no `SwConnectors` actually referring to it.](RS_SWCT_00010, RS_SWCT_03250, RS_SWCT_03130)

Please note that [TPS_SWCT_01573] represents the immediate consequence of the semantics defined in [TPS_SWCT_01112].

[TPS_SWCT_01113] Connecting two `PortPrototypes` [Two `SwComponentPrototypes` are eventually connected by hooking up a `PortPrototype` or `PRPortPrototype` of one `SwComponentPrototype` to a compatible `RPortPrototype` or `PRPortPrototype` of the other `SwComponentPrototypes`.](RS_SWCT_03130, RS_SWCT_03250)

Please find more information concerning the definition of “compatibility” in section 6.

Class	AbstractRequiredPortPrototype (abstract)			
Package	M2::AUTOSARTemplates::SWComponentTemplate::Components			
Note	This abstract class provides the ability to become a required PortPrototype.			
Base	ARObject, AtpBlueprintable, AtpFeature, AtpPrototype, Identifiable, MultilanguageReferrable, PortPrototype, Referrable			
Subclasses	RPortPrototype, PRPortPrototype			
Attribute	Type	Mult.	Kind	Note
requiredComSpec	RPortComSpec	*	aggr	Required communication attributes, one for each interface element.

Table 3.3: AbstractRequiredPortPrototype

Class	AbstractProvidedPortPrototype (abstract)			
Package	M2::AUTOSARTemplates::SWComponentTemplate::Components			
Note	This abstract class provides the ability to become a provided PortPrototype.			
Base	ARObject, AtpBlueprintable, AtpFeature, AtpPrototype, Identifiable, MultilanguageReferrable, PortPrototype, Referrable			
Subclasses	PPortPrototype, PRPortPrototype			
Attribute	Type	Mult.	Kind	Note
providedComSpec	PPortComSpec	*	aggr	Provided communication attributes per interface element (data element or operation).

Table 3.4: AbstractProvidedPortPrototype

Class	RPortPrototype			
Package	M2::AUTOSARTemplates::SWComponentTemplate::Components			
Note	Component port requiring a certain port interface.			
Base	<i>ARObject, AbstractRequiredPortPrototype, AtpBlueprintable, AtpFeature, AtpPrototype, Identifiable, MultilanguageReferrable, PortPrototype, Referrable</i>			
Attribute	Type	Mult.	Kind	Note
required Interface	PortInterface	1	tref	The interface that this port requires. Stereotypes: isOfType

Table 3.5: RPortPrototype

Class	PPortPrototype			
Package	M2::AUTOSARTemplates::SWComponentTemplate::Components			
Note	Component port providing a certain port interface.			
Base	<i>ARObject, AbstractProvidedPortPrototype, AtpBlueprintable, AtpFeature, AtpPrototype, Identifiable, MultilanguageReferrable, PortPrototype, Referrable</i>			
Attribute	Type	Mult.	Kind	Note
provided Interface	PortInterface	1	tref	The interface that this port provides. Stereotypes: isOfType

Table 3.6: PPortPrototype

Class	PRPortPrototype			
Package	M2::AUTOSARTemplates::SWComponentTemplate::Components			
Note	This kind of PortPrototype can take the role of both a required and a provided PortPrototype.			
Base	<i>ARObject, AbstractProvidedPortPrototype, AbstractRequiredPortPrototype, AtpBlueprintable, AtpFeature, AtpPrototype, Identifiable, MultilanguageReferrable, PortPrototype, Referrable</i>			
Attribute	Type	Mult.	Kind	Note
provided Required Interface	PortInterface	1	tref	This represents the PortInterface used to type the PRPort Prototype Stereotypes: isOfType

Table 3.7: PRPortPrototype

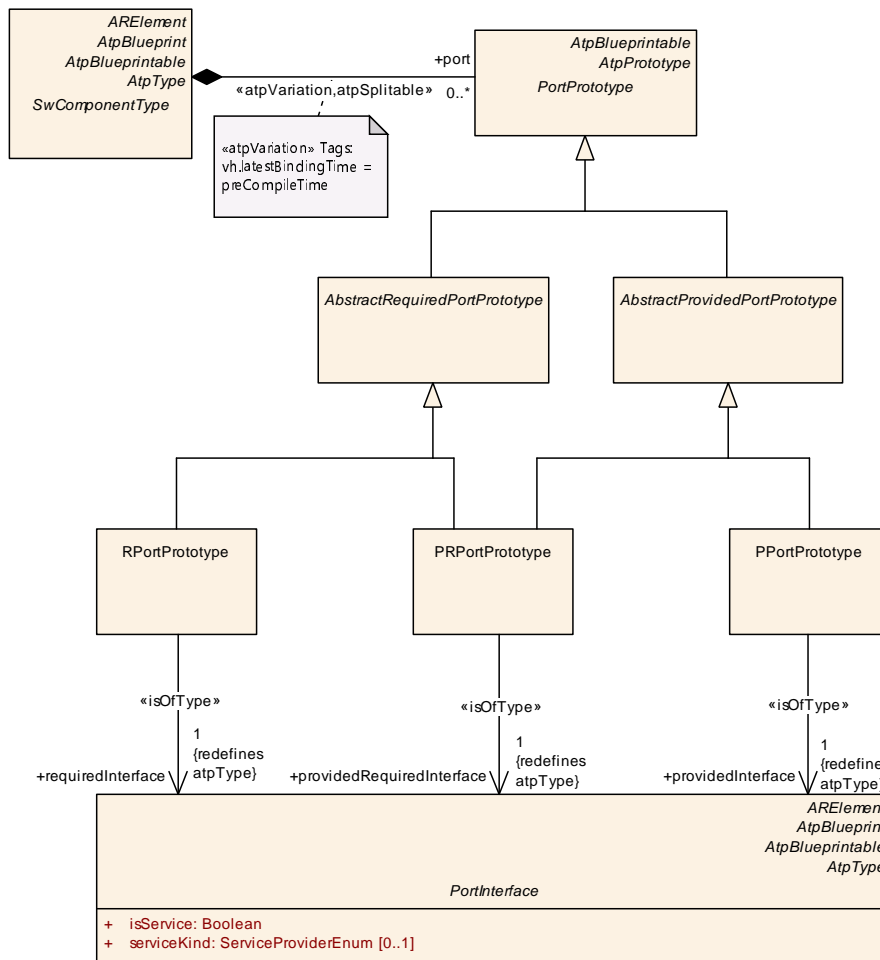

Figure 3.3: Components and Ports

[TPS_SWCT_01096] **PortGroup** [PortPrototypes can be logically grouped into PortGroups. This mechanism is used for implementing mode management features.] (RS_SWCT_03201)

Further explanations about the semantics of meta-class PortGroup can be found in chapter 4.6.

3.2.3 AtomicSwComponentType

[TPS_SWCT_01108] **Added value of an AtomicSwComponentType** [As mentioned before, the term AtomicSwComponentType is a specific form of the general concept of the SwComponentType. The added value of an AtomicSwComponentType is that it can aggregate an InternalBehavior] (RS_SWCT_03040)

More information regarding the semantics of InternalBehavior can be found in chapter 7.

[TPS_SWCT_01109] **Adding the SwcInternalBehavior in a later process step** [The aggregation of SwcInternalBehavior is stereotyped «atpSplittable» to

allow for adding the `SwcInternalBehavior` in a later process step. In other words, it is possible to completely develop the VFB view of a software-component and later add more details like `InternalBehavior`.|()

Class	AtomicSwComponentType (abstract)			
Package	M2::AUTOSARTemplates::SWComponentTemplate::Components			
Note	An atomic software component is atomic in the sense that it cannot be further decomposed and distributed across multiple ECUs.			
Base	ARElement , ARObject , AtpBlueprint , AtpBlueprintable , AtpClassifier , AtpType , CollectableElement , Identifiable , MultilanguageReferrable , PackageableElement , Referrable , SwComponentType			
Subclasses	ApplicationSwComponentType , ComplexDeviceDriverSwComponentType , EcuAbstractionSwComponentType , NvBlockSwComponentType , SensorActuatorSwComponentType , ServiceProxySwComponentType , ServiceSwComponentType			
Attribute	Type	Mult.	Kind	Note
internalBehavior	SwcInternalBehavior	0..1	aggr	The <code>SwcInternalBehaviors</code> owned by an <code>AtomicSwComponentType</code> can be located in a different physical file. Therefore the aggregation is <code><<atpSplitable>></code> . Stereotypes: <code>atpSplitable</code> ; <code>atpVariation</code> Tags: <code>atp.Splitkey=internalBehavior</code> , <code>variationPoint.shortLabel</code> <code>vh.latestBindingTime=preCompileTime</code>
symbolProps	SymbolProps	0..1	aggr	This represents the <code>SymbolProps</code> for the <code>AtomicSwComponentType</code> . Stereotypes: <code>atpSplitable</code> Tags: <code>atp.Splitkey=shortName</code>

Table 3.8: AtomicSwComponentType

There are several specialized `SwComponentTypes` to describe specific software-components used in the different parts of the AUTOSAR Layered Architecture [5]. Further details are mentioned in chapter 10 and 11.

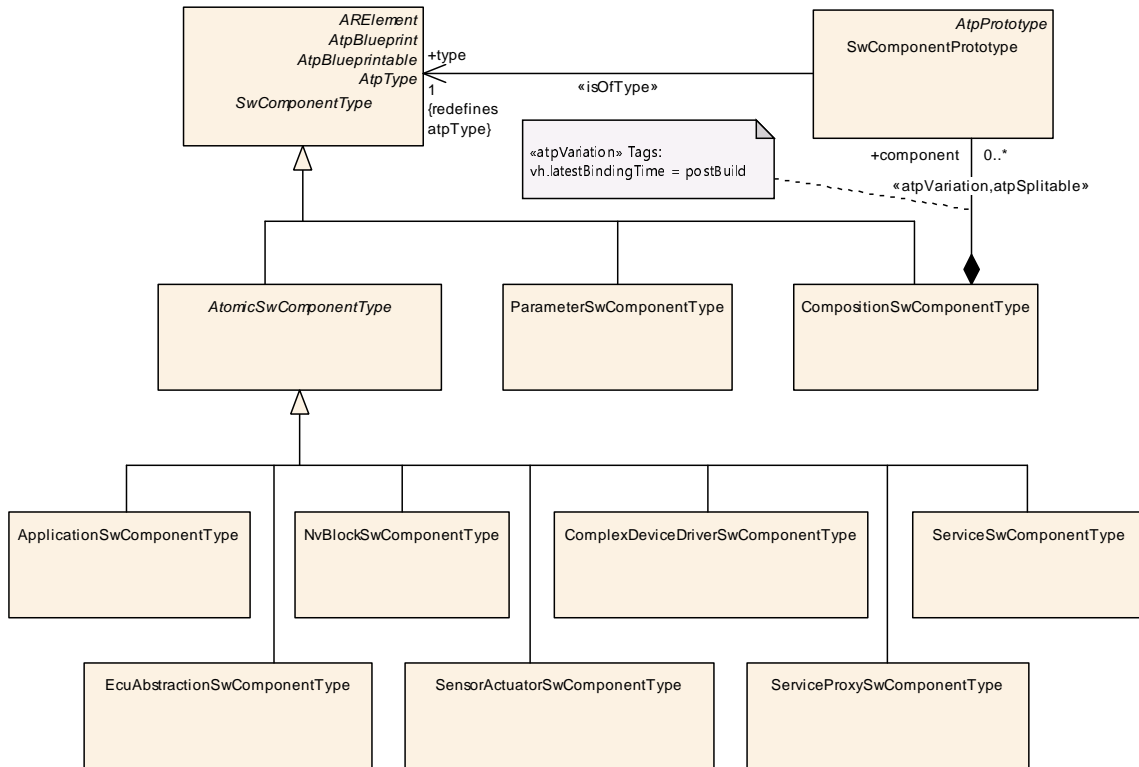

Figure 3.4: Overview of Component Types

The [ApplicationSwComponentType](#) is a specialization of [AtomicSwComponentType](#) for representing hardware-independent application software. The [ParameterSwComponentType](#) is a specialization of [SwComponentType](#) that can - in contrast to [AtomicSwComponentType](#) - not aggregate [SwcInternalBehavior](#).

The purpose of the [NvBlockSwComponentType](#) is described in detail in section [11.5.2](#). The [ServiceSwComponentType](#) is described in section [11.3](#). Further on, the [EcuAbstractionSwComponentType](#) and the [ComplexDeviceDriverSwComponentType](#) are discussed in detail in section [10](#).

A description of the [ServiceProxySwComponentType](#) can be found in section [11.4](#) while the [SensorActuatorSwComponentType](#) is described in section [10.4](#).

Class	ApplicationSwComponentType			
Package	M2::AUTOSARTemplates::SWComponentTemplate::Components			
Note	The ApplicationSwComponentType is used to represent the application software. Tags: atp.recommendedPackage=SwComponentTypes			
Base	ARElement , ARObject , AtomicSwComponentType , AtpBlueprint , AtpBlueprintable , AtpClassifier , AtpType , CollectableElement , Identifiable , MultilanguageReferrable , PackageableElement , Referrable , SwComponentType			
Attribute	Type	Mult.	Kind	Note
-	-	-	-	-

Table 3.9: ApplicationSwComponentType

3.2.4 ParameterSwComponentType

[constr_1092] ParameterSwComponentType [A `ParameterSwComponentType` shall never aggregate a `SwcInternalBehavior` and also owns exclusively `PPort-Prototypes` of type `ParameterInterface`.]()

However, a `ParameterSwComponentType` shall have the ability to aggregate `InstantiationDataDefProps`. By this means it is possible to define role-specific data properties of elements of composite data types used for the definition of calibration parameters in the scope of a `ParameterSwComponentType`.

For more information about this aspect please refer to section 7.5.4.

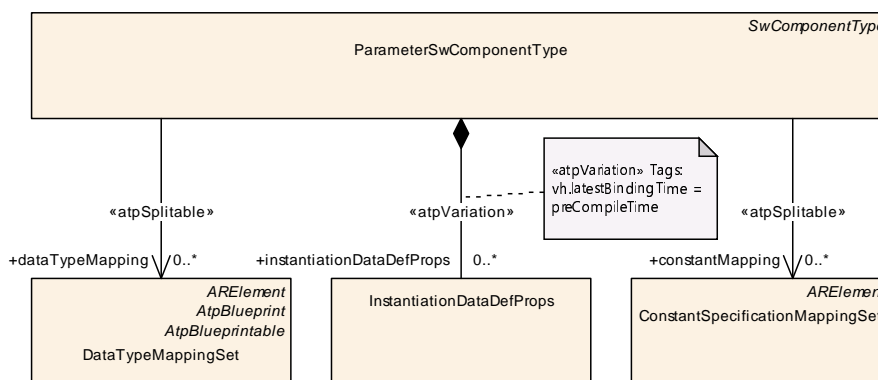

Figure 3.5: Details of `ParameterSwComponentType`

3.2.5 Symbolic Name of a Software-Component

Please note that an `AtomicSwComponentType` manifests itself in the source code of an RTE into which an instance of the `AtomicSwComponentType` is deployed. This implies potential naming conflicts if instances of `AtomicSwComponentType` that have identical `shortNames` are deployed into a specific RTE.

[TPS_SWCT_01110] Symbolic name of a software-component [To mitigate this potential hazard it is possible to provide the `AtomicSwComponentType` along with an accompanying symbolic name that can be used for resolving the name clash. The symbolic name is provided by means of the attribute `symbol` of the meta-class `SymbolProps` owned by `AtomicSwComponentType` in the role `symbolProps`.]()

Please note that more information about the symbolic name provided by means of the attribute `symbol` of the meta-class `SymbolProps` owned by `AtomicSwComponentType` in the role `symbolProps` can be found in Figure 3.6.

For more detailed information about how `SymbolProps` can be used to mitigate name clashes occurring during the integration of software-components on an AUTOSAR ECU, please refer to [4].

[TPS_SWCT_01000] Usage of attribute `symbol` of the `symbolProps` [In particular, the RTE generator shall take over the value of the attribute `symbol` of the `symbolProps` owned by a given `AtomicSwComponentType`. If and only if `symbolProps` is not defined the RTE generator shall take the `shortName` of the `AtomicSwComponentType`. For the generation of `symbols` for `RunnableEntity`s [TPS_SWCT_01001] shall be observed.]()

[TPS_SWCT_01001] Prefix symbols generated for the `RunnableEntity` [If and only if the attribute `symbol` of a `symbolProps` owned by an `AtomicSwComponentType` exists, its value shall also be taken for prefixing the symbols generated for the `RunnableEntity`s owned by the `AtomicSwComponentType`.]()

Note: if `symbolProps` is not defined the behavior of the RTE generator is fully backwards compatible, i.e. existing implementations of `RunnableEntity`s do not have to be touched in order to conform with this version of the AUTOSAR standard.

This is a further measure to mitigate the risk of potential name clashes in the RTE code.

[TPS_SWCT_01635] Naming conventions may support the effectiveness of `SymbolProps` [Of course, there is a residual risk that even in the presence of `SymbolProps` name clashes may occur.

Therefore, the definition of naming conventions may facilitate the avoidance of name clashes to the further degree.]([RS_SWCT_00230](#))

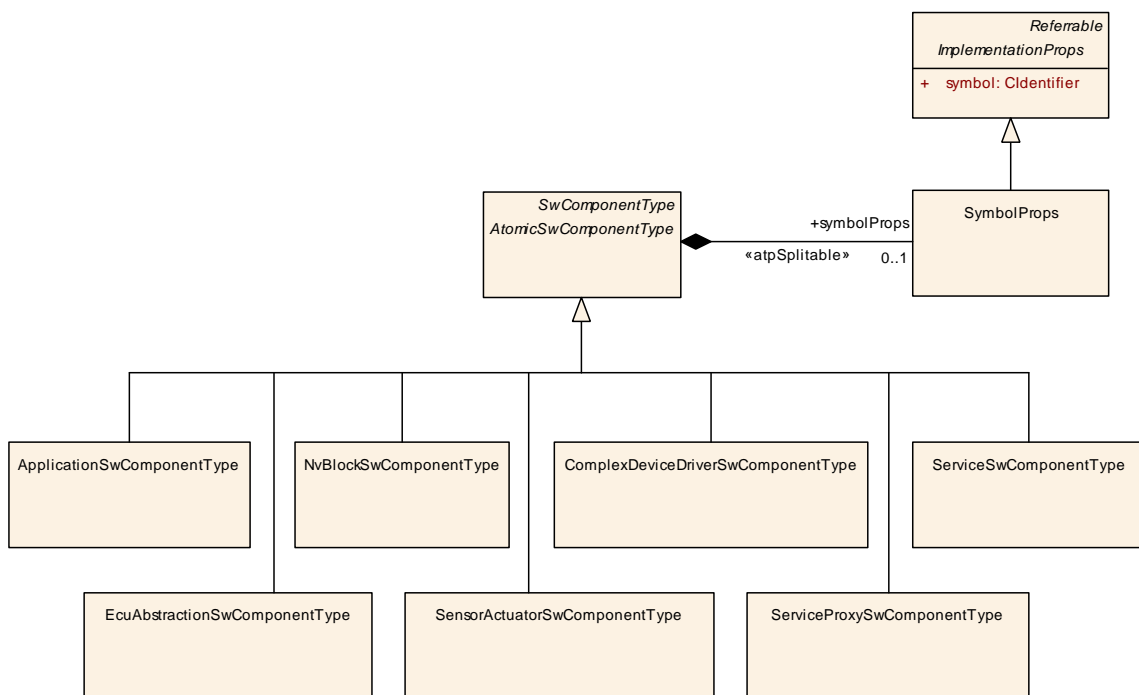

Figure 3.6: Overview of `AtomicSwComponentType`

3.3 Composition

3.3.1 Overview

[TPS_SWCT_01032] CompositionSwComponentType [The purpose of an AUTOSAR `CompositionSwComponentType` is to allow the encapsulation of specific functionality by aggregating existing software-components.]([RS_SWCT_00190](#), [RS_SWCT_02000](#), [RS_SWCT_02020](#), [RS_SWCT_03000](#))

[TPS_SWCT_01033] Nested definition of CompositionSwComponentTypes [Since a `CompositionSwComponentType` is also a `SwComponentType`, it again may be aggregated in further `CompositionSwComponentTypes`.]([RS_SWCT_00190](#), [RS_SWCT_02000](#), [RS_SWCT_02020](#), [RS_SWCT_03000](#))

This recursive relation is formally expressed in Figure 3.7.

It is important to understand that while compositions allow for (sub-) system abstraction, they are solely an *architectural element for the implementation of model scalability*. They simply group existing software-components and thereby take away complexity when viewing or designing logical software architecture.

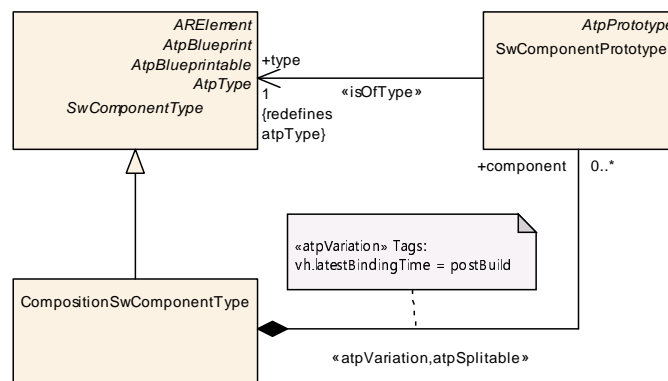

Figure 3.7: The recursive relation of software-components and compositions

Therefore, the definition of `CompositionSwComponentTypes` has no effect on how software-components interact with the Virtual Functional Bus (VFB). `CompositionSwComponentTypes` do not add any new functionality to what is already provided by the software-components they aggregate.

[TPS_SWCT_01034] CompositionSwComponentTypes do not have any binary footprint [As the main consequence, `CompositionSwComponentTypes` do not have any binary footprint in the ECU software.]([RS_SWCT_00190](#), [RS_SWCT_02000](#), [RS_SWCT_02020](#), [RS_SWCT_03000](#))

3.3.2 SwComponentPrototype

[TPS_SWCT_01035] **CompositionSwComponentType** aggregates **SwComponentPrototypes** [In terms of the AUTOSAR meta-model, a composition of software-components realized by the meta-class **CompositionSwComponentType** aggregates **SwComponentPrototypes** which in turn are typed by a **SwComponentType**.] (*RS_SWCT_00190, RS_SWCT_02000, RS_SWCT_02020, RS_SWCT_03000*)

Please note that a **CompositionSwComponentType** is also a **SwComponentType**.

Class	CompositionSwComponentType			
Package	M2::AUTOSARTemplates::SWComponentTemplate::Composition			
Note	<p>A CompositionSwComponentType aggregates SwComponentPrototypes (that in turn are typed by SwComponentTypes) as well as SwConnectors for primarily connecting SwComponentPrototypes among each others and towards the surface of the CompositionSwComponentType. By this means hierarchical structures of software-components can be created.</p> <p>Tags:atp.recommendedPackage=SwComponentTypes</p>			
Base	<p><i>ARElement, ARObject, AtpBlueprint, AtpBlueprintable, AtpClassifier, AtpType, CollectableElement, Identifiable, MultilanguageReferrable, PackageableElement, Referrable, SwComponentType</i></p>			
Attribute	Type	Mult.	Kind	Note
component	SwComponentPrototype	*	aggr	<p>The instantiated components that are part of this composition. The aggregation of SwComponentPrototype is subject to variability with the purpose to support the conditional existence of a SwComponentPrototype. Please be aware: if the conditional existence of SwComponentPrototypes is resolved post-build the deselected SwComponentPrototypes are still contained in the ECUs build but the instances are inactive in in that they are not scheduled by the RTE.</p> <p>The aggregation is marked as atpSplitable in order to allow the addition of service components to the ECU extract during the ECU integration.</p> <p>The use case for having 0 components owned by the CompositionSwComponentType could be to deliver an empty CompositionSwComponentType to e.g. a supplier for filling the internal structure.</p> <p>Stereotypes: atpSplitable; atpVariation Tags: atp.Splitkey=shortName, variationPoint.shortLabel vh.latestBindingTime=postBuild</p>
connector	SwConnector	*	aggr	<p>SwConnectors have the principal ability to establish a connection among PortPrototypes. They can have many roles in the context of a CompositionSwComponentType. Details are refined by subclasses.</p> <p>The aggregation of SwConnectors is subject to variability with the purpose to support variant data flow.</p> <p>The aggregation is marked as atpSplitable in order to allow the extension of the ECU extract with AssemblySwConnectors between ApplicationSwComponentTypes and ServiceSwComponentTypes during the ECU integration.</p> <p>Stereotypes: atpSplitable; atpVariation Tags: atp.Splitkey=shortName, variationPoint.shortLabel vh.latestBindingTime=postBuild</p>





Class	CompositionSwComponentType			
constantValue Mapping	ConstantSpecification MappingSet	*	ref	Reference to the ConstantSpecificationMapping to be applied for initValues of PPortComSpecs and RPortCom Spec. Stereotypes: atpSplitable Tags: atp.Splitkey=constantValueMapping
dataType Mapping	DataTypeMappingSet	*	ref	Reference to the DataTypeMapping to be applied for the used ApplicationDataTypes in PortInterfaces. Background: when developing subsystems it may happen that ApplicationDataTypes are used on the surface of CompositionSwComponentTypes. In this case it would be reasonable to be able to also provide the intended mapping to the ImplementationDataTypes. However, this mapping shall be informal and not technically binding for the implementors mainly because the RTE generator is not concerned about the CompositionSwComponent Types. Rationale: if the mapping of ApplicationDataTypes on the delegated and inner PortPrototype matches then the mapping to ImplementationDataTypes is not impacting compatibility. Stereotypes: atpSplitable Tags: atp.Splitkey=dataTypeMapping
instantiation RTEEventProps	InstantiationRTEEvent Props	*	aggr	This allows to define instantiation specific properties for RTE Events, in particular for instance specific scheduling. Stereotypes: atpSplitable; atpVariation Tags: atp.Splitkey=shortLabel, variationPoint.shortLabel vh.latestBindingTime=codeGenerationTime

Table 3.10: CompositionSwComponentType

Class	SwComponentPrototype			
Package	M2::AUTOSARTemplates::SWComponentTemplate::Composition			
Note	Role of a software component within a composition.			
Base	<i>ARObject, AtpFeature, AtpPrototype, Identifiable, MultilanguageReferrable, Referrable</i>			
Attribute	Type	Mult.	Kind	Note
type	SwComponentType	1	tref	Type of the instance. Stereotypes: isOfType

Table 3.11: SwComponentPrototype

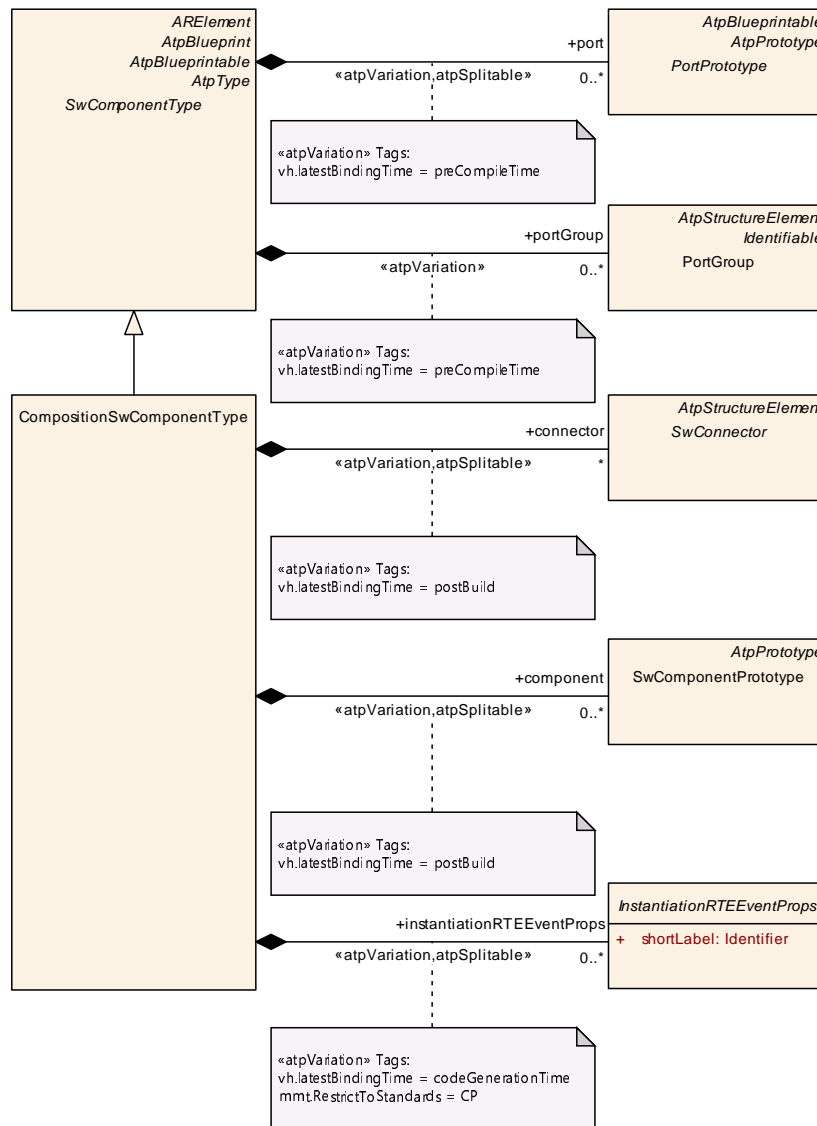

Figure 3.8: Composition and the meta-classes aggregated

[TPS_SWCT_01036] **SwComponentPrototype** implements a specific role [Therefore, a *SwComponentPrototype* implements the usage of a *SwComponentType* in a specific role.] (*RS_SWCT_00190, RS_SWCT_02000, RS_SWCT_02020, RS_SWCT_03000*)

[TPS_SWCT_01037] **arbitrary numbers of SwComponentPrototypes can be created** [In general, arbitrary numbers of *SwComponentPrototypes* that refer to specific *SwComponentTypes* can be created.] (*RS_SWCT_00190, RS_SWCT_02000, RS_SWCT_02020, RS_SWCT_03000*)

Example: a *SwComponentPrototype* “LeftDoorControl” fulfills the role of implementing the *SwComponentType* “DoorControl” for the left door of a vehicle while the *SwComponentPrototype* “RightDoorControl” fulfills the role of the *SwComponentType* “DoorControl” for the right door.

[TPS_SWCT_01080] Delegation ports [Note that being a `SwComponentType`, a `CompositionSwComponentType` also exposes `PortPrototypes` to the outside world. However, the `PortPrototypes` are only delegated and do not play the same role as `PortPrototypes` attached to `AtomicSwComponentTypes`.] (*RS_SWCT_03130*)

[TPS_SWCT_01081] Implications of being a delegation port [Being a `PortPrototype` attached to a `CompositionSwComponentType` has the following implications:

- The delegation has to follow the rules for basic compatibility.
- By creating `PortPrototypes` on the surface of a specific `CompositionSwComponentType` it is explicitly decided whether the contents of an “inner” port contained in the `CompositionSwComponentType` is exposed to the outside world.

] (*RS_SWCT_03130*)

Please note that the rules for compatibility are described in chapter 6.

Please note further that the semantics of the delegation of `PortPrototypes` are similar to encapsulation mechanisms like public and private members in object-oriented programming languages.

One implication of the concept of `CompositionSwComponentType` is that the application software of an entire vehicle eventually is represented by one `CompositionSwComponentType`. This so-called top-level composition has a special role in the context of the AUTOSAR System Template [10].

However, please note that a top-level composition might have (unconnected) `PortPrototypes` in order to allow for reuse as part of another system.

[constr_1035] Recursive definition of `CompositionSwComponentType` [The recursive definition of a `CompositionSwComponentType` that eventually contains a `SwComponentPrototype` typed by the same `CompositionSwComponentType` shall not be feasible.] ()

3.3.3 Connectors

[TPS_SWCT_01079] `SwConnector` [Note that `CompositionSwComponentType` also aggregates the abstract meta-class `SwConnector` for connecting the contained `SwComponentPrototypes` among each other.] (*RS_SWCT_03130*)

More information can be found in Figure 3.8.

`CompositionSwComponentTypes` contain two kinds of `SwConnectors`:

- **[TPS_SWCT_01082] `AssemblySwConnector`** [`AssemblySwConnectors` interconnect `PortPrototypes` of `SwComponentPrototypes` that are part of the `CompositionSwComponentType`.] (*RS_SWCT_03130*)

- **[TPS_SWCT_01083] DelegationSwConnector** [DelegationSwConnectors connect from “inner” PortPrototypes to delegated “outer” PortPrototypes.] (RS_SWCT_03130)

[TPS_SWCT_01084] Outer PortPrototype is referenced by multiple DelegationSwConnectors [In the case that an outer PortPrototype is referenced by multiple DelegationSwConnectors the semantic is the multiplication of the AssemblySwConnectors referencing the outer PortPrototypes.] (RS_SWCT_03130)

[constr_1086] SwConnector between two specific PortPrototypes [Each pair of PortPrototypes can only be connected by one and only one SwConnector.] ()

In other words, it is not supported to create two different SwConnectors that connect the same pair of PortPrototypes.

[TPS_SWCT_01638] Existence of SwConnector between two PRPortPrototypes [[constr_1086] applies also in the case that two PRPortPrototypes are connected with each other. In particular, the roles

- AssemblySwConnector.requester
- AssemblySwConnector.provider
- PassThroughSwConnector.providedOuterPort
- PassThroughSwConnector.requiredOuterPort

do **not** establish a direction in this case.] ()

For clarification, [TPS_SWCT_01638] means that the SwConnector represents the ability for bi-directional communication between the two PRPortPrototypes.

[constr_1087] AssemblySwConnector inside CompositionSwComponentType [An AssemblySwConnector can only connect PortPrototypes of SwComponentPrototypes that are owned by the same CompositionSwComponentType] ()

[constr_1088] DelegationSwConnector inside CompositionSwComponentType [A DelegationSwConnector can only connect a PortPrototype of a SwComponentPrototype that is owned by the same CompositionSwComponentType that also owns the connected delegation PortPrototype.] ()

In the context of attaching a DelegationSwConnector to an inner PRPortPrototype there is some ambiguity to be considered. In particular, from the formal point of view it would be feasible to use **either** a PPortInCompositionInstanceRef **or** a RPortInCompositionInstanceRef.

The ability to use one or the other meta-class arbitrarily is considered confusing. Therefore, [TPS_SWCT_01515] has been defined to remove the unnecessary degree of freedom.

[TPS_SWCT_01515] **PPortInCompositionInstanceRef** shall be used for attaching **DelegationSwConnector** to an inner **PRPortPrototype** [For the implementation of the attachment of a **DelegationSwConnector** to an inner **PRPortPrototype** the meta-class **PPortInCompositionInstanceRef** shall be used.]()

[constr_1100] **Unconnected RPortPrototype** typed by a **DataInterface** [For any element in an unconnected **RPortPrototype** typed by a **DataInterface** there shall be a **requiredComSpec** that defines an **initValue**.]()

Class	SwConnector (abstract)			
Package	M2::AUTOSARTemplates::SWComponentTemplate::Composition			
Note	The base class for connectors between ports. Connectors have to be identifiable to allow references from the system constraint template.			
Base	<i>ARObject, AtpClassifier, AtpFeature, AtpStructureElement, Identifiable, MultilanguageReferrable, Referrable</i>			
Subclasses	<i>AssemblySwConnector, DelegationSwConnector, PassThroughSwConnector</i>			
Attribute	Type	Mult.	Kind	Note
mapping	PortInterfaceMapping	0..1	ref	Reference to a PortInterfaceMapping specifying the mapping of unequal named PortInterface elements of the two different PortInterfaces typing the two PortPrototypes which are referenced by the ConnectorPrototype .

Table 3.12: SwConnector

Class	AssemblySwConnector			
Package	M2::AUTOSARTemplates::SWComponentTemplate::Composition			
Note	AssemblySwConnectors are exclusively used to connect SwComponentPrototypes in the context of a CompositionSwComponentType .			
Base	<i>ARObject, AtpClassifier, AtpFeature, AtpStructureElement, Identifiable, MultilanguageReferrable, Referrable, SwConnector</i>			
Attribute	Type	Mult.	Kind	Note
provider	AbstractProvidedPortPrototype	0..1	iref	Instance of providing port.
requester	AbstractRequiredPortPrototype	0..1	iref	Instance of requiring port.

Table 3.13: AssemblySwConnector

Class	DelegationSwConnector			
Package	M2::AUTOSARTemplates::SWComponentTemplate::Composition			
Note	A delegation connector delegates one inner PortPrototype (a port of a component that is used inside the composition) to a outer PortPrototype of compatible type that belongs directly to the composition (a port that is owned by the composition).			
Base	<i>ARObject, AtpClassifier, AtpFeature, AtpStructureElement, Identifiable, MultilanguageReferrable, Referrable, SwConnector</i>			
Attribute	Type	Mult.	Kind	Note





Class	DelegationSwConnector			
innerPort	PortPrototype	1	iref	The port that belongs to the ComponentPrototype in the composition Tags: xml.typeElement=true
outerPort	PortPrototype	1	ref	The port that is located on the outside of the Composition Type

Table 3.14: DelegationSwConnector

One specific use case for the application of *SwConnectors* is exemplified by the figures 3.9 and 3.11. A specific *CompositionSwComponentType* exists in two variants where one (more complex) variant foresees the existence of a *SwComponentPrototype* inside the *CompositionSwComponentType* (depicted by 3.9) and the other (because it is implementing a simpler semantics) does not need the *SwComponentPrototype*.

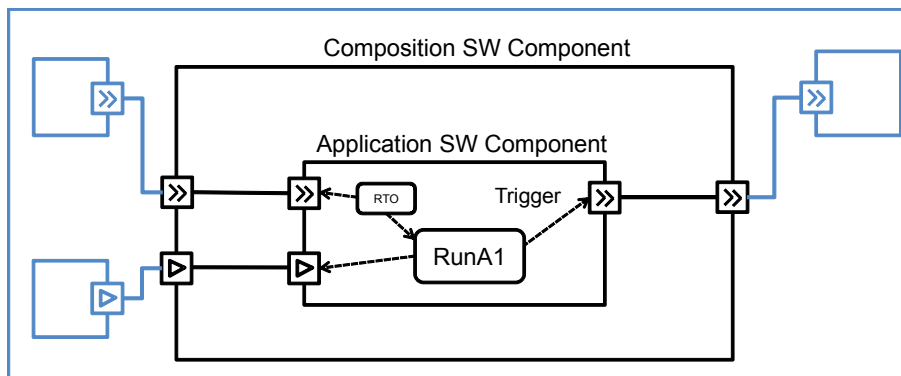

Figure 3.9: Use case for *PassThroughSwConnector* (I)

Class	PassThroughSwConnector			
Package	M2::AUTOSARTemplates::SWComponentTemplate::Composition			
Note	This kind of SwConnector can be used inside a CompositionSwComponentType to connect two delegation PortPrototypes.			
Base	ARObject, AtpClassifier, AtpFeature, AtpStructureElement, Identifiable, MultilanguageReferrable, Referrable, SwConnector			
Attribute	Type	Mult.	Kind	Note
providedOuterPort	AbstractProvidedPortPrototype	1	ref	This represents the provided outer delegation Port Prototype of the PassThroughSwConnector.
requiredOuterPort	AbstractRequiredPortPrototype	1	ref	This represents the required outer delegation Port Prototype of the PassThroughSwConnector.

Table 3.15: PassThroughSwConnector

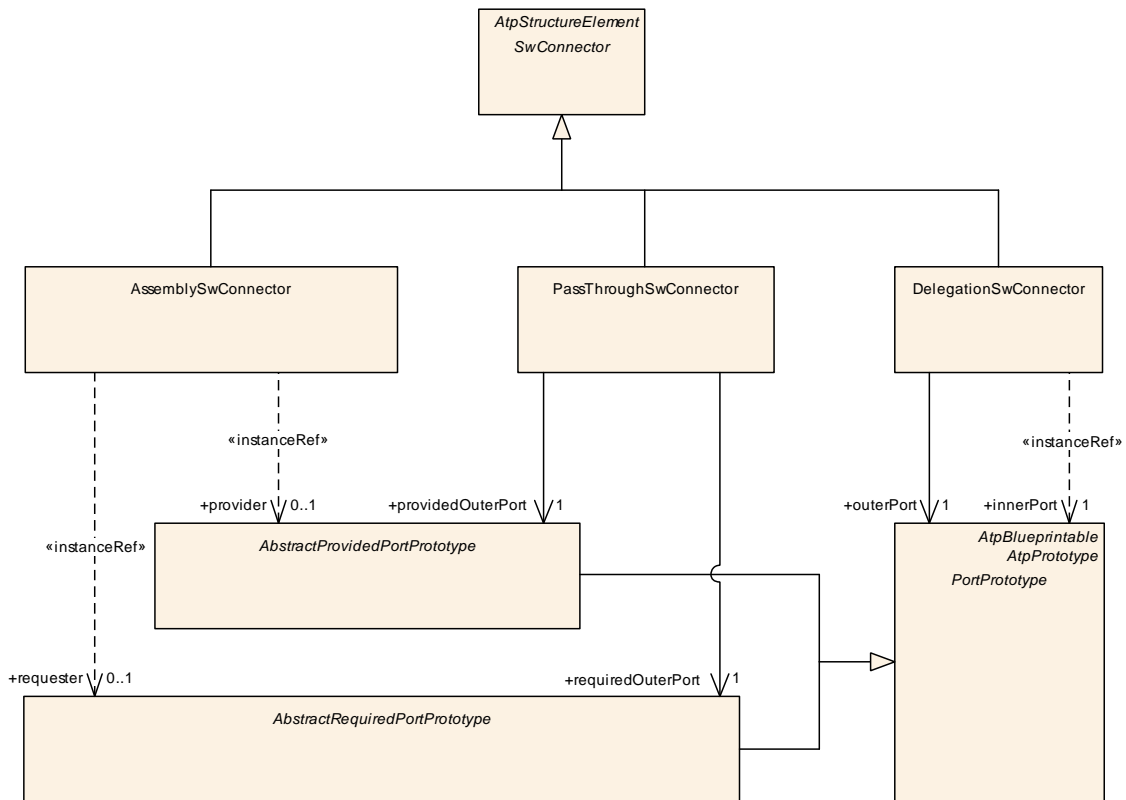

Figure 3.10: Connectors

Without the ability to define a `PassThroughSwConnector` the second variant could only be implemented by defining a dummy `SwComponentPrototype` inside the `CompositionSwComponentType`. However, the dummy `SwComponentPrototype` would need to define `RunnableEntity`s that are created for the sole purpose of being able to shovel the data from (e.g. for sender-receiver communication) `RPortPrototypes` to `PPortPrototypes`.

This would not only be cumbersome it would also obviously require additional resources (memory and code) at run-time. Plus, the existence of addition `RunnableEntity`s also unnecessarily increases the propagation delay of information flowing around inside the ECU.

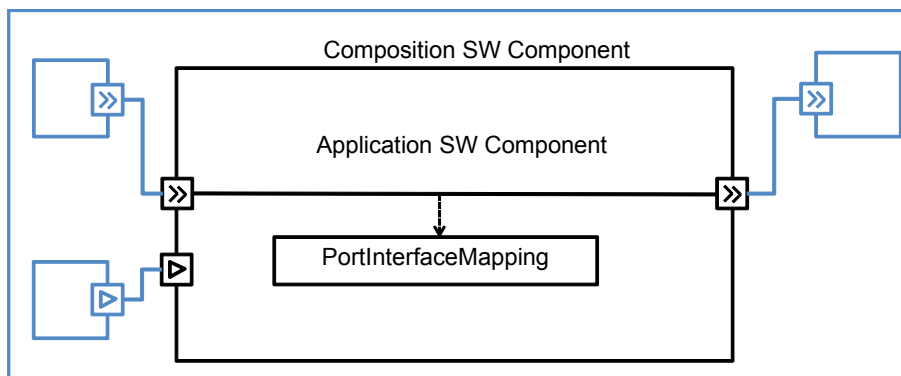

Figure 3.11: Use case for `PassThroughSwConnector` (II)

[TPS_SWCT_01507] The role of **PassThroughSwConnector** [PassThroughSwConnector can be taken to connect PortPrototypes owned by the same CompositionSwComponentType. In other words, PassThroughSwConnector creates a bypass inside a CompositionSwComponentType from the requiredOuterPort to the providedOuterPort (or vice versa) without involving SwComponentPrototypes.]()

[constr_1252] Creation of a loop involving a **PassThroughSwConnector** is not allowed [A PassThroughSwConnector is not allowed if the required outer PortPrototype is directly or indirectly connected to the provided outer PortPrototype without the placement of a SwComponentPrototype typed by an AtomicSwComponentType in the chain of SwConnectors.]()

In other words, according to [constr_1252] it is not allowed to create a “infinite loop” by means of a PassThroughSwConnector and at least one AssemblySwConnector that connects the requiredOuterPort to the providedOuterPort.

3.3.4 Instantiation-specific RTEEvents

[TPS_SWCT_02507] Instantiation-specific **RTEEvents** [It is possible to specify instantiation specific properties of an RTEEvent by applying InstantiationRTEEventProps in the role instantiationRTEEventProps.

This allows to use the same ApplicationSwComponentType in different timing scenarios. Even if the scheduling is an issue of the SwcInternalBehavior, the instance specific definition of timing needs to be specified on the level of a CompositionSwComponentType.](RS_SWCT_03046, RS_SWCT_03270)

As an example for [TPS_SWCT_02507], please consider a software-component that implements a closed-loop control algorithm.

This software-component can potentially be deployed to “slow” and “fast” control scenarios. As the actual time-base of the control algorithm is derived from the scheduling implemented in the RTE it obviously facilitates the overall design if the timing can be defined on “instance” level.

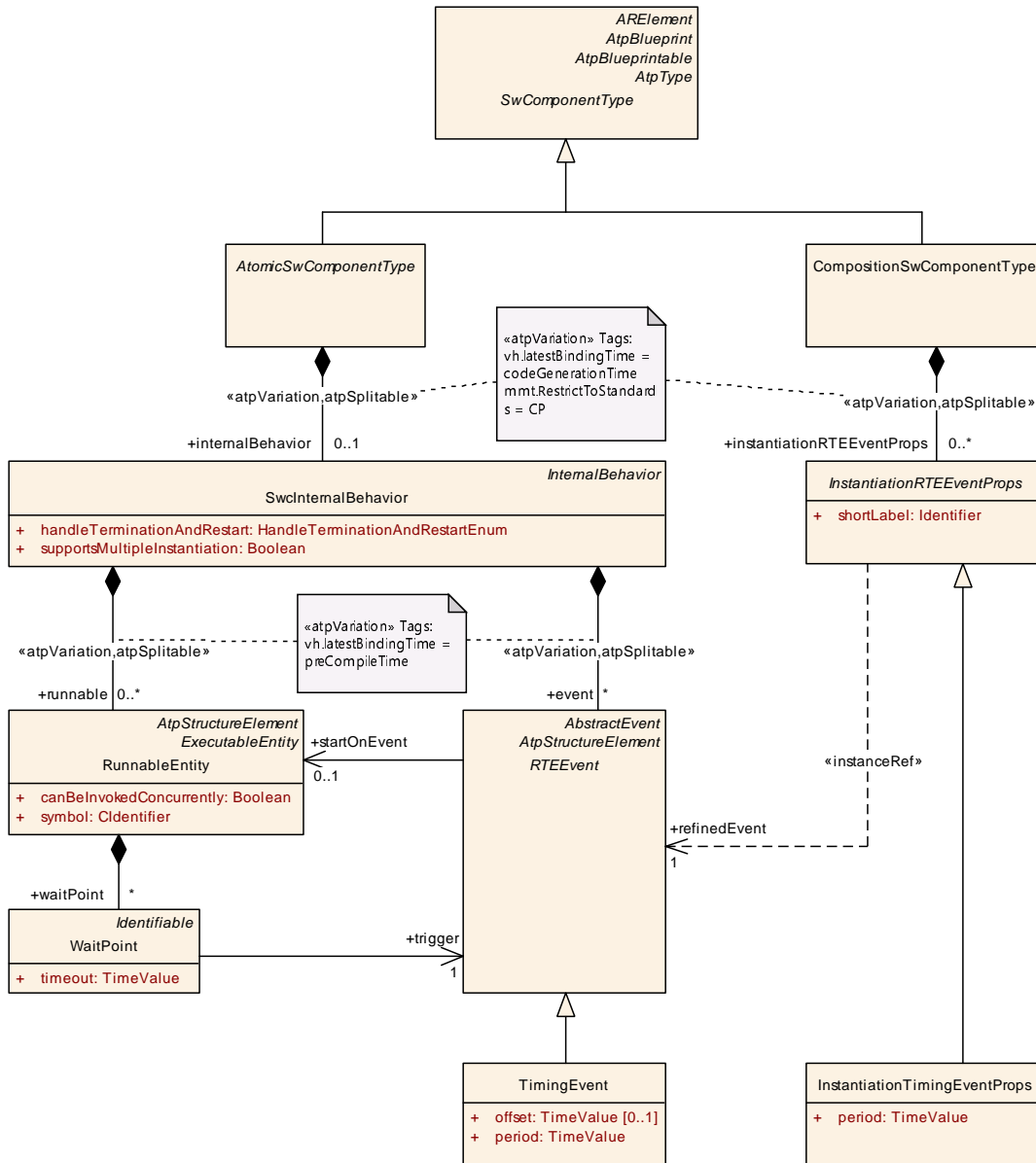

Figure 3.12: Instantiation specific Properties of RTEEvents

Class	<i>InstantiationRTEEventProps</i> (abstract)			
Package	M2::AUTOSARTemplates::SWComponentTemplate::Composition			
Note	This meta class represents the ability to refine the properties of RTEEvents for particular instances of a software component.			
Base	<i>ARObject</i>			
Subclasses	InstantiationTimingEventProps			
Attribute	Type	Mult.	Kind	Note
refinedEvent	RTEEvent	1	iref	This instance ref denotes the Timing Event for which the period shall be refined on an instance level.





Class	InstantiationRTEEventProps (abstract)			
shortLabel	Identifier	1	attr	The main purpose of the shortLabel is to contribute to the splitkey of aggregations that are <<atpSplitable>>.

Table 3.16: InstantiationRTEEventProps

[constr_1233] InstantiationTimingEventProps shall only reference TimingEvent [An `InstantiationTimingEventProps` shall only reference `TimingEvent` in the role `refinedEvent`. A reference to other kinds of `RTEEvents` is not supported.]()

3.4 Port Interface

[TPS_SWCT_01025] The role of PortPrototypes in the AUTOSAR architecture [A `PortPrototype` mainly contributes the functionality of being a *connection point* to the AUTOSAR concept.

The details, i.e. with respect to what kind of information is actually transported between two `PortPrototypes` is defined by the `PortInterface`.] ([RS_SWCT_00010](#), [RS_SWCT_00080](#), [RS_SWCT_00110](#), [RS_SWCT_02030](#), [RS_SWCT_03010](#))

[TPS_SWCT_01026] The role of PortInterfaces in the AUTOSAR architecture [`PortInterfaces` are used to support a design-by-contract work-flow, i.e. a `PortInterface` provides means to formally verify structural and dynamic compatibility between software-components.] ([RS_SWCT_00010](#), [RS_SWCT_00080](#), [RS_SWCT_00110](#), [RS_SWCT_02030](#), [RS_SWCT_03010](#))

In other words: `PortInterfaces` (see Figure 3.14) represent a pivotal point in the AUTOSAR concept.

Please note that a `PortInterface` creates a name space for the information contained. This allows for defining the details of a specific `PortInterface` without having to care for possible side effects on other `PortInterfaces`. Again, this property of the AUTOSAR concept directly supports re-usability.

[TPS_SWCT_01027] Different flavors of PortInterfaces [Within the AUTOSAR concept, different flavors of `PortInterfaces` are defined:

- `SenderReceiverInterface`
- `NvDataInterface`
- `ParameterInterface`
- `ModeSwitchInterface`
- `ClientServerInterface`
- `TriggerInterface`

|(RS_SWCT_00010, RS_SWCT_00080, RS_SWCT_00110, RS_SWCT_02030)

[TPS_SWCT_01069] **DataInterface** is defined as abstract base class [Please note that the conceptual relationship of *SenderReceiverInterface*, *NvDataInterface*, and *ParameterInterface* is expressed by the definition of the abstract base class *DataInterface*.](RS_SWCT_00010, RS_SWCT_00080, RS_SWCT_00110, RS_SWCT_03010)

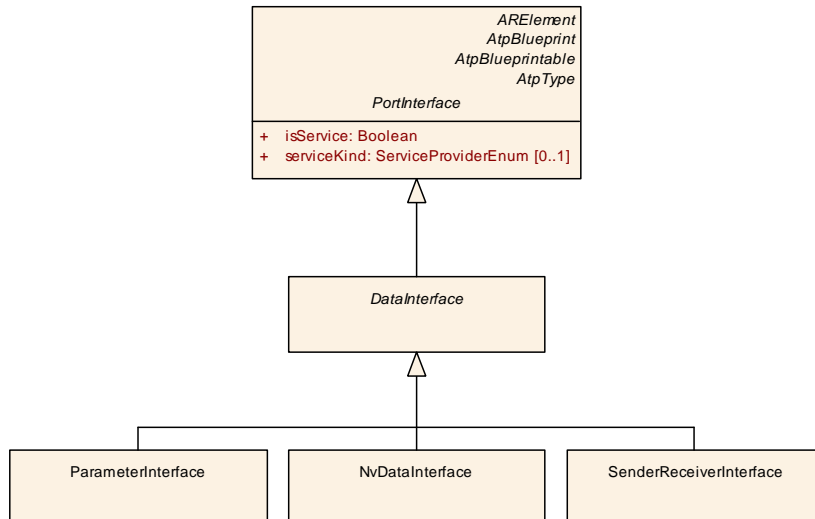

Figure 3.13: DataInterface as an abstract base class

Please find more details about the specialization of the *PortInterface* concept in chapter 4.2.3 and 4.2.2.

Class	<i>PortInterface</i> (abstract)			
Package	M2::AUTOSARTemplates::SWComponentTemplate::PortInterface			
Note	Abstract base class for an interface that is either provided or required by a port of a software component.			
Base	<i>ARElement</i> , <i>ARObject</i> , <i>AtpBlueprint</i> , <i>AtpBlueprintable</i> , <i>AtpClassifier</i> , <i>AtpType</i> , <i>CollectableElement</i> , <i>Identifiable</i> , <i>MultilanguageReferrable</i> , <i>PackageableElement</i> , <i>Referrable</i>			
Subclasses	<i>ClientServerInterface</i> , <i>DataInterface</i> , <i>ModeSwitchInterface</i> , <i>TriggerInterface</i>			
Attribute	Type	Mult.	Kind	Note
isService	Boolean	1	attr	This flag is set if the <i>PortInterface</i> is to be used for communication between an <ul style="list-style-type: none"> • <i>ApplicationSwComponentType</i> or • <i>ServiceProxySwComponentType</i> or • <i>SensorActuatorSwComponentType</i> or • <i>ComplexDeviceDriverSwComponentType</i> • <i>ServiceSwComponentType</i> • <i>EcuAbstractionSwComponentType</i> and a <i>ServiceSwComponentType</i> (namely an AUTOSAR Service) located on the same ECU. Otherwise the flag is not set.





Class	PortInterface (abstract)			
serviceKind	ServiceProviderEnum	0..1	attr	This attribute provides further details about the nature of the applied service.

Table 3.17: PortInterface

Class	DataInterface (abstract)			
Package	M2::AUTOSARTemplates::SWComponentTemplate::PortInterface			
Note	The purpose of this meta-class is to act as an abstract base class for subclasses that share the semantics of being concerned about data (as opposed to e.g. operations).			
Base	ARElement , ARObject , AtpBlueprint , AtpBlueprintable , AtpClassifier , AtpType , CollectableElement , Identifiable , MultilanguageReferrable , PackageableElement , PortInterface , Referrable			
Subclasses	NvDataInterface , ParameterInterface , SenderReceiverInterface			
Attribute	Type	Mult.	Kind	Note
–	–	–	–	–

Table 3.18: DataInterface

[TPS_SWCT_01070] [PortInterface](#) acts as a *type* for a [PortPrototype](#) [From an abstract point of view, a [PortInterface](#) acts as a *type* for a [PortPrototype](#). This means in particular that several [PortPrototypes](#) can be typed by the same [PortInterface](#).] ([RS_SWCT_00010](#), [RS_SWCT_00080](#), [RS_SWCT_00110](#), [RS_SWCT_03010](#))

Of course, this aspect facilitates the creation of valid connections between software-components dramatically. By using a specific [PortInterface](#) for typing particular [PortPrototypes](#) the latter are eligible for being connected to each other by definition.

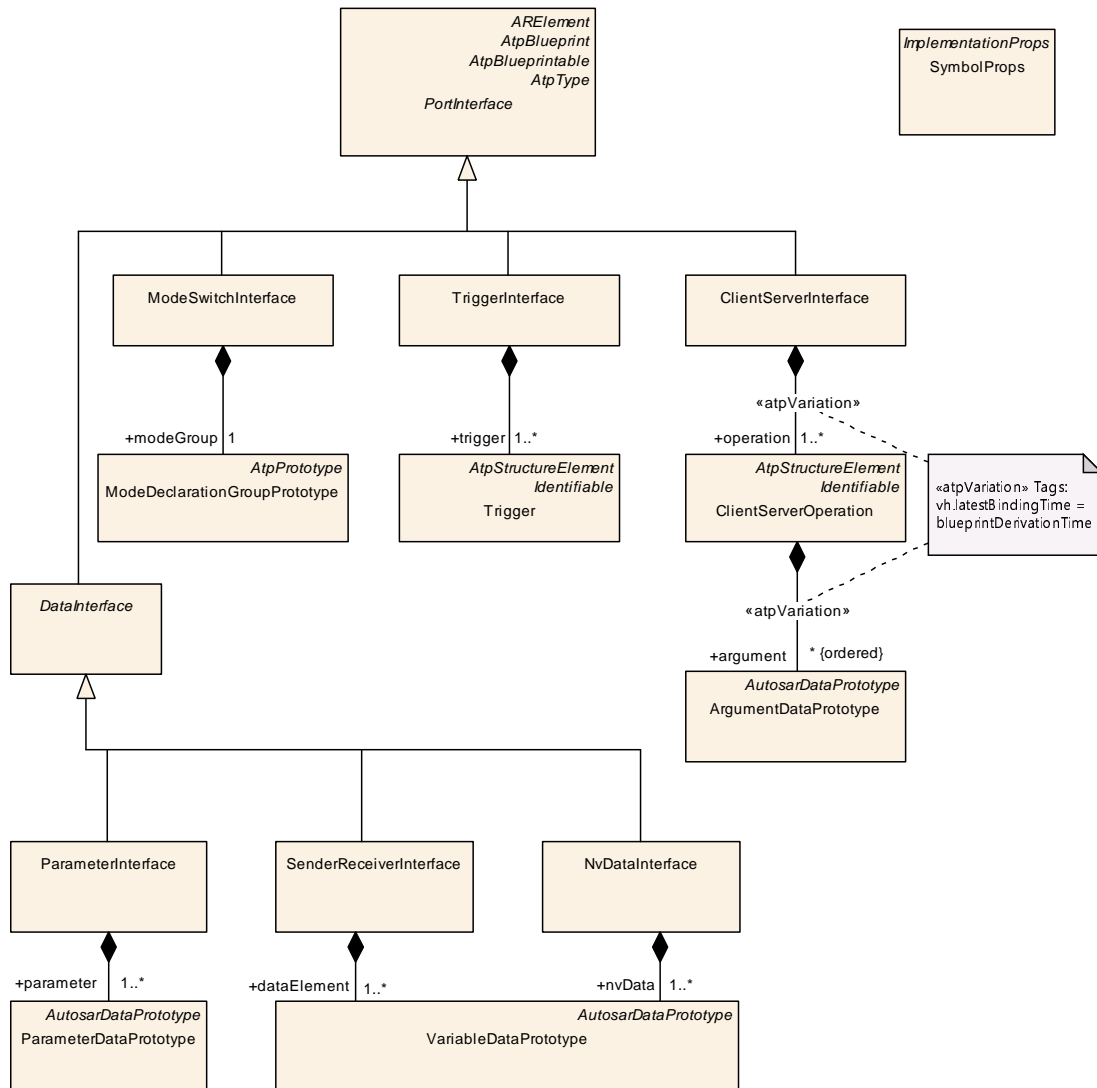

Figure 3.14: PortInterfaces in the AUTOSAR meta-model

However, the creation of a valid connection does not need to be based on the usage of identical [PortInterfaces](#). It is also possible to use different, but *compatible* [PortInterfaces](#). The details about compatibility of [PortInterfaces](#) are described in chapter 6.

[constr_1036] Connect kinds of [PortInterfaces](#) [It shall not be possible to connect [PortPrototypes](#) typed by [PortInterfaces](#) of different kinds. Subclasses of [DataInterface](#) make an exception to this rule and can be used for creating connections to each other.]()

For clarification, a connection between a [PortPrototype](#) typed by a [SenderReceiverInterface](#) and a [PortPrototype](#) typed by a [ClientServerInterface](#) shall not be possible. However, the creation of a connection between a [PortPrototype](#) typed by a [SenderReceiverInterface](#) and a [PortPrototype](#) typed by a [ParameterInterface](#) is supported.

[constr_1137] Applicability of `ParameterInterface` [A `PPortPrototype` typed by a `ParameterInterface` can **only** be owned by a `ParameterSwComponentType` or a `CompositionSwComponentType`.]()

Please note that `PortInterfaces` also play an important role in the context of defining so-called AUTOSAR services. In particular, by means of the attribute `isService` a `PortInterface` can define whether it is supposed to be used in the context of an AUTOSAR service and in addition to this it may define (by means of the attribute `serviceKind`) what kind of service is intended.

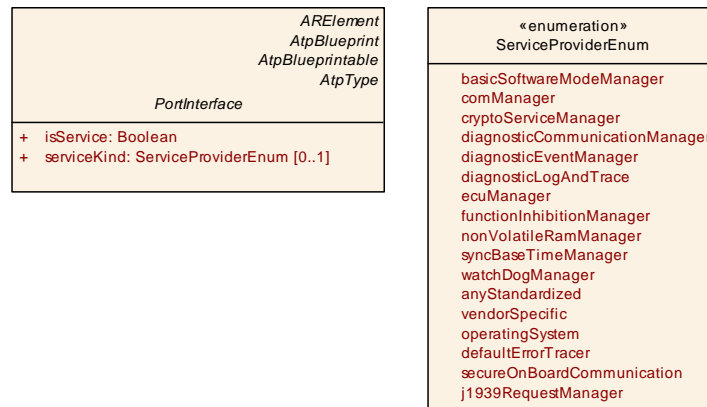

Figure 3.15: `PortInterfaces` and AUTOSAR services

The information contained in `serviceKind` can be used in various ways. The primary intent is to distinguish between the usage of standardized AUTOSAR services from the usage of a vendor-specific service. This information may have an impact on the development- and build process of software-components that use the `PortInterface`.

In addition, it is also possible to use the information contained in `serviceKind` for filtering the presentation of an AUTOSAR model in an AUTOSAR authoring tool and e.g. display the nature of the service `PortPrototypes` independently of the content of the corresponding `PortInterface`.

[TPS_SWCT_01003] Inconsistencies regarding the value of `serviceKind` and the actual implementation of the `PortInterface` [In case of inconsistencies between the value of `serviceKind` and the actual implementation of the `PortInterface` the implementation of the `PortInterface` wins over the value of attribute `PortInterface.serviceKind` (which, for the intended purpose shall be considered an annotation rather than a semantically binding information).]()

[TPS_SWCT_01004] Default value if `serviceKind` is not defined [if the attribute `serviceKind` is not defined in the context of a specific `PortInterface` the default value `anyStandardized` shall be assumed.]()

[constr_1174] `PortInterfaces` used in the context of `CompositionSwComponentTypes` cannot refer to AUTOSAR services [`CompositionSwComponentTypes` shall not own `PortPrototypes` typed by `PortInterfaces` where the attribute `isService` is set to `true`.]()

Enumeration	ServiceProviderEnum
Package	M2::AUTOSARTemplates::CommonStructure::ServiceNeeds
Note	This represents a list of possible service providers
Literal	Description
anyStandardized	This value means that the specific nature is either unknown or it is not important for the given purpose. This is also the default value for any attribute of type ServiceProviderEnum Tags: atp.EnumerationLiteralIndex=0
basicSoftwareModeManager	The service relates to the Basic Software Mode Manager (BswM) Tags: atp.EnumerationLiteralIndex=1
comManager	The service relates to the COM Manager (ComM). Tags: atp.EnumerationLiteralIndex=2
cryptoServiceManager	The service relates to the Crypto Service Manager (CsM). Tags: atp.EnumerationLiteralIndex=3
defaultErrorTracer	The service relates to the Default Error Tracer (DET) Tags: atp.EnumerationLiteralIndex=4
diagnosticCommunicationManager	The service relates to the Diagnostic Communication Manager (DCM). Tags: atp.EnumerationLiteralIndex=6
diagnosticEventManager	The service relates to the Diagnostic Event Manager (DEM). Tags: atp.EnumerationLiteralIndex=7
diagnosticLogAndTrace	The service relates to the Diagnostic Log and Trace (DLT). Tags: atp.EnumerationLiteralIndex=8
ecuManager	The service relates to the ECU Manager (EcuM). Tags: atp.EnumerationLiteralIndex=9
functionInhibitionManager	The service relates to the Function Inhibition Manager (FIM). Tags: atp.EnumerationLiteralIndex=10
j1939RequestManager	The service relates to the J1939Rm. Tags: atp.EnumerationLiteralIndex=11
nonVolatileRamManager	The service relates to the Non-Volatile RAM Manager (NvM). Tags: atp.EnumerationLiteralIndex=12
operatingSystem	The service relates to the Operating System (OS). Tags: atp.EnumerationLiteralIndex=13
secureOnBoardCommunication	The service relates to the SecOc module. Tags: atp.EnumerationLiteralIndex=14
syncBaseTimeManager	The service relates to the Sync Time Base Manager (StbM). Tags: atp.EnumerationLiteralIndex=15
vendorSpecific	This value denotes a vendor-specific service. Tags: atp.EnumerationLiteralIndex=16
watchDogManager	The service relates to the Watchdog Manager (WdgM). Tags: atp.EnumerationLiteralIndex=17

Table 3.19: ServiceProviderEnum

Please find more details about the relation of [PortInterfaces](#) to AUTOSAR services in chapter 11.

4 Details: Software Components, Ports, and Interfaces

4.1 Introduction

The specification of the Virtual Functional Bus (VFB) [3] explains the main communication paradigms for communication among software-components: *client/server* for operation-based communication, and *sender/receiver* for data-based communication.

The nature of the two communication paradigms is quite different, and so is the modeling of [SenderReceiverInterfaces](#) and [ClientServerInterfaces](#) and their related meta-classes.

[TPS_SWCT_01516] PortInterface describes the static structure of information interchange [[PortInterfaces](#) are limited to the description of the static structure of the exchanged information; the dynamic attributes relevant for communication are attached to [PortPrototypes](#).] ([RS_SWCT_00010](#), [RS_SWCT_00080](#), [RS_SWCT_00110](#), [RS_SWCT_02030](#), [RS_SWCT_03010](#))

Please note that the dynamic attributes relevant for communication are described in chapter [4.5](#).

4.2 Port Interface Details

4.2.1 Introduction

The usage of value encodings (for more information please refer to section [5.2.6](#)) is limited within the context of [PortInterfaces](#).

[constr_1045] Supported value encodings for SwBaseType in the context of PortInterfaces [The supported value encodings for the usage within a [PortInterface](#) are:

- 2C: Two's complement
- IEEE754: floating-point numbers
- ISO-8859-1: single-byte coded character
- ISO-8859-2: single-byte coded character
- WINDOWS-1252: single-byte coded character
- UTF-8: UCS Transformation Format 8
- UTF-16: Character encoding for Unicode *code points* based on 16 bit *code units* [15]
- UCS-2: Universal Character Set 2

- NONE: Unsigned Integer
- BOOLEAN: This represents an integer to be interpreted as boolean.

]()

[constr_1046] Applicability of [constr_1045] [[constr_1045] applies **only** if the value of the attribute `isService` is set to `false`.]()

[constr_1295] PortInterfaces and category DATA_REFERENCE [A `DataPrototype` defined in the context of a `PortInterface` used by an `ApplicationSwComponentType` or `SensorActuatorSwComponentType` that is (after potential indirections via `TYPE_REFERENCE` are resolved) either typed by or mapped to an `ImplementationDataType` of category `DATA_REFERENCE` shall only be used if either the provider or the requester of the information represents a `ServiceSwComponentType`, a `ComplexDeviceDriverSwComponentType`, a `ParameterSwComponentType`, or an `NvBlockSwComponentType`, or the `EcuAbstractionSwComponentType`.]()

Note: [constr_1295] corresponds to [SWS_RTE_07670].

4.2.2 Sender Receiver Communication

4.2.2.1 Sender Receiver Interface

[TPS_SWCT_01114] SenderReceiverInterface [`SenderReceiverInterfaces` allow for the specification of the typically asynchronous communication pattern where a sender provides data that is required by one or more receivers.

While the actual communication takes place via the respective `PortPrototypes`, a `SenderReceiverInterface` allows for formally describing what kind of information is sent and received.]()

Class	SenderReceiverInterface			
Package	M2::AUTOSARTemplates::SWComponentTemplate::PortInterface			
Note	A sender/receiver interface declares a number of data elements to be sent and received. Tags: atp.recommendedPackage=PortInterfaces			
Base	ARElement , ARObject , AtpBlueprint , AtpBlueprintable , AtpClassifier , AtpType , CollectableElement , DataInterface , Identifiable , MultilanguageReferrable , PackageableElement , PortInterface , Referrable			
Attribute	Type	Mult.	Kind	Note
dataElement	VariableDataPrototype	1..*	aggr	The data elements of this SenderReceiverInterface.
invalidationPolicy	InvalidationPolicy	*	aggr	InvalidationPolicy for a particular dataElement
metaDataItemSet	MetaDataItemSet	*	aggr	This aggregation defines fixed sets of meta-data items associated with dataElements of the enclosing SenderReceiverInterface

Table 4.1: SenderReceiverInterface

Class	InvalidationPolicy			
Package	M2::AUTOSARTemplates::SWComponentTemplate::PortInterface			
Note	Specifies whether the component can actively invalidate a particular dataElement. If no invalidationPolicy points to a dataElement this is considered to yield the identical result as if the handleInvalid attribute was set to dontInvalidate.			
Base	ARObject			
Attribute	Type	Mult.	Kind	Note
dataElement	VariableDataPrototype	1	ref	Reference to the dataElement for which the Invalidation Policy applies.
handleInvalid	HandleInvalidEnum	0..1	attr	This attribute controls how invalidation is applied to the dataElement.

Table 4.2: InvalidationPolicy

Enumeration	HandleInvalidEnum
Package	M2::AUTOSARTemplates::SWComponentTemplate::Communication
Note	Strategies of handling the reception of invalidValue.
Literal	Description
dontInvalidate	Invalidation is switched off. Tags: atp.EnumerationLiteralIndex=0
external Replacement	Replace a received invalidValue. The replacement value is sourced from the externalReplacement. Tags: atp.EnumerationLiteralIndex=1
keep	The application software is supposed to handle signal invalidation on RTE API level either by Data ReceiveErrorEvent or check of error code on read access. Tags: atp.EnumerationLiteralIndex=2
replace	Replace a received invalidValue. The replacement value is specified by the initValue. Tags: atp.EnumerationLiteralIndex=3

Table 4.3: HandleInvalidEnum

A [SenderReceiverInterface](#) focuses on the description of information items represented by [VariableDataPrototypes](#) (see section 5.3).

A [VariableDataPrototype](#) aggregated in the role of [dataElement](#) represents an atomic¹ piece of information transmitted among [PortPrototypes](#) typed by a [SenderReceiverInterface](#).

[TPS_SWCT_01115] [invalidationPolicy](#) [An [invalidationPolicy](#) specifies whether the sending component can actively invalidate a particular [dataElement](#) and which strategy of handling the reception of [invalidValue](#) on the receiver side shall be implemented.]()

Further information about the related concept of an [invalidValue](#) is provided in chapter 5.4.2

¹Note that the term “atomic” does not have any implication on the implementation on a concrete computing platform

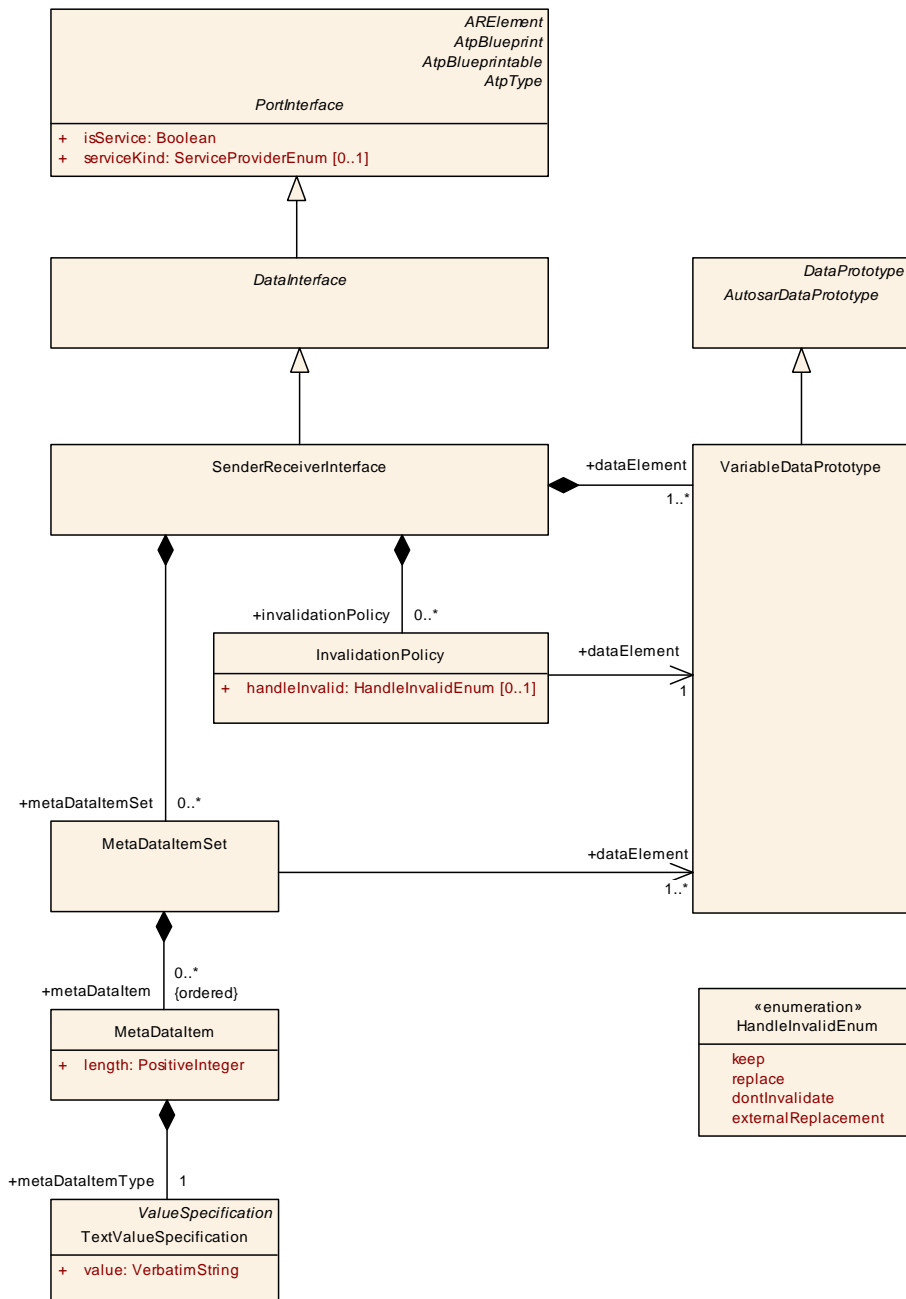

Figure 4.1: dataElements of a SenderReceiverInterface

Note that a `SenderReceiverInterface` provides a name space for the definition of `VariableDataPrototypes`. In terms of the AUTOSAR meta-model this aspect is indicated by the inheritance relation to `DataPrototype` (which in turn inherits from `Identifiable`). Please find more information on the creation of name spaces in [11].

[TPS_SWCT_01116] swImplPolicy [The `swImplPolicy` indicates the way how a `VariableDataPrototype` shall be processed at the receiver’s side. If set to `queued` the semantics is that the corresponding `VariableDataPrototype` needs to be added to a `queue` (or in other words: a FIFO data structure) from which it is later consumed by the actual receiver software-component.] ()

Please note that the `swImplPolicy` is described in section 5.4.

[constr_1200] Queued communication is not applicable for `dataElements` owned by `PRPortPrototype` [The `swImplPolicy` shall not be set to `queued` for any `dataElement` owned by a `PRPortPrototype`.]()

[TPS_SWCT_01176] last-is-best semantics for sender-receiver communication [If `swImplPolicy` is set to any other valid value of `SwImplPolicyEnum` then *last is best* semantics applies.]()

Please note that the definition of `VariableDataPrototype` may come very close to the reader's idea of a *signal*. However, different kinds of signals have a specific meaning in the AUTOSAR concept, especially in the context of the AUTOSAR System Template [10].

[TPS_SWCT_01117] Communication patterns for sender-receiver communication [`PortPrototypes` typed by a `SenderReceiverInterface` may be connected to establish a 1:n (i.e. one sender, multiple receivers) communication relationship. It is also possible to establish an n:1 (i.e. many senders, one receiver) communication pattern.]()

[constr_1033] Communication scenarios for sender/receiver communication [For sender/receiver communication, it is not allowed to create a communication scenario where n sender are connected to m receivers where m and n are **both** greater than 1.]()

Factually, `[constr_1033]` is not applicable to a scenario where several `PRPortPrototypes` are connected by a chain of `AssemblySwConnectors` or `PassThroughSwConnectors`.

[constr_1202] Supported connections by `AssemblySwConnector` for `PortPrototypes` typed by a `SenderReceiverInterface` or `NvDataInterface` [For the modeling of `AssemblySwConnectors` between `PortPrototypes` typed by a `SenderReceiverInterface` or `NvDataInterface`, **only** the connections documented in Table 4.4 are supported by AUTOSAR.]()

	<code>RPortPrototype</code>	<code>PPortPrototype</code>	<code>PRPortPrototype</code>
<code>RPortPrototype</code>	No	Yes	Yes
<code>PPortPrototype</code>	Yes	No	Yes
<code>PRPortPrototype</code>	Yes	Yes	Yes

Table 4.4: Supported connections for `PortPrototypes` typed by a `SenderReceiverInterface` or `NvDataInterface`

[constr_1203] Supported connections by `DelegationSwConnector` for `PortPrototypes` typed by a `SenderReceiverInterface` or `NvDataInterface` [For the modeling of `DelegationSwConnectors` between `PortPrototypes` typed by a `SenderReceiverInterface` or `NvDataInterface`, **only** the connections documented in Table 4.5 are supported by AUTOSAR.]()

innerPort	outerPort		
	RPortPrototype	PPortPrototype	PRPortPrototype
RPortPrototype	Yes	No	Yes
PPortPrototype	No	Yes	Yes
PRPortPrototype	Yes	Yes	Yes

Table 4.5: Supported connections for PortPrototypes typed by a Sender-ReceiverInterface or NvDataInterface

4.2.2.2 Meta-data on the Application Software Level

There are cases where information available on different levels in the AUTOSAR basic software stack need to be made available as meta-data on the application layer in order to make the overall software function properly.

One example could be a software-component that is involved with communication using the J1939 protocol.

In such a case, the semantics of the information transmitted is strongly bound to the source address and the sender needs to be able to set the source address individually.

[TPS_SWCT_01801] Support for Meta-Data [Meta-data on the application software level can only be made available in the context of a `SenderReceiverInterface`. No other kind of `PortInterface` supports the definition of meta-data.]()

[TPS_SWCT_01802] Definition of meta-data in the context of a Sender-ReceiverInterface [The definition of meta-data in the context of a `Sender-ReceiverInterface` involves two aspects:

- The available meta-data are defined by means of an ordered aggregation of meta-class `MetaDatum` at `MetaDatumSet` that in turn is aggregated in the role `SenderReceiverInterface.metaDatumSet`.
- The involvement of `dataElements` with meta-data is specified by means of the reference `MetaDatumSet.dataElement`. In other words, the `dataElements` that are referenced by a `MetaDatumSet` in the role `dataElement` are involved with meta-data handling.

]()

Class	MetaDatum			
Package	M2::AUTOSARTemplates::SWComponentTemplate::PortInterface			
Note	This meta-class represents a single meta-data item.			
Base	<code>ARObject</code>			
Attribute	Type	Mult.	Kind	Note





Class	MetaDatum			
length	PositiveInteger	1	attr	This attribute determines the length of the MetaDatum at run-time.
metaDatumType	TextValueSpecification	1	aggr	This aggregation contributes the specification of the concrete meta-data item type.

Table 4.6: MetaDatum

Class	MetaDatumSet			
Package	M2::AUTOSARTemplates::SWComponentTemplate::PortInterface			
Note	This meta-class represents the ability to define a set of meta-data items to be used in SenderReceiver Interfaces.			
Base	ARObject			
Attribute	Type	Mult.	Kind	Note
dataElement	VariableDataPrototype	1..*	ref	This reference identifies the dataElement for which the ordered list of meta-data items is defined.
metaDatum (ordered)	MetaDatum	*	aggr	This aggregation represents the ordered definition of meta-data items.

Table 4.7: MetaDatumSet

[constr_1726] Ordering of [MetaDatumSet.metaDatum](#) [The ordering of the elements of [MetaDatumSet.metaDatum](#) shall be done such that the [MetaDatum](#) with the **largest value** of attribute [length](#) is **located in the first position** and the [MetaDatum](#) with the **smallest value** of attribute [length](#) is **located in the last position.**]()

[TPS_SWCT_01803] MetaDataItems define the same value of attribute [length](#) [For the case that [MetaDatumSet](#) define the same value of attribute [length](#) the ordering of these [MetaDatumSet](#) among each other is not significant.]()

[TPS_SWCT_01804] Standardized values of attribute [MetaDatumSet.metaDatumType.value](#) [The following values of attribute [MetaDatumSet.metaDatumType.value](#) are standardized by AUTOSAR:

- PRIORITY_8
- SOURCE_ADDRESS_16
- TARGET_ADDRESS_16
- ADDRESS_EXTENSION_8
- SOCKET_CONNECTION_ID_16
- LIN_NAD_8
- CAN_ID_32
- ETHERNET_MAC_32

]()

4.2.3 Client Server Communication

The underlying semantics of a client/server communication is that a client may initiate the execution of an operation by a server that supports the operation.

The server executes the operation and, when completed, it provides the client with the result (synchronous operation call) or else the client checks for the completion of the operation by itself (asynchronous operation call).

[constr_1037] Client shall not be connected to multiple servers [A client shall not be connected to multiple servers such that an operation call would be handled by more than one server.]()

4.2.3.1 Client Server Interface

A `ClientServerInterface`, to some extent, is a counterpart to the `SenderReceiverInterface`².

Instead of defining pieces of information to be transferred among software-components, a `ClientServerInterface` defines a collection of `ClientServerOperations`.

Class	<code>ClientServerInterface</code>			
Package	M2::AUTOSARTemplates::SWComponentTemplate::PortInterface			
Note	A client/server interface declares a number of operations that can be invoked on a server by a client. Tags: atp.recommendedPackage=PortInterfaces			
Base	ARElement , ARObject , AtpBlueprint , AtpBlueprintable , AtpClassifier , AtpType , CollectableElement , Identifiable , MultilanguageReferrable , PackageableElement , PortInterface , Referrable			
Attribute	Type	Mult.	Kind	Note
operation	ClientServerOperation	1..*	aggr	ClientServerOperation(s) of this ClientServerInterface. Stereotypes: atpVariation Tags: vh.latestBindingTime=blueprintDerivationTime
possibleError	ApplicationError	*	aggr	Application errors that are defined as part of this interface.

Table 4.8: ClientServerInterface

²However, different connection patterns apply, see [\[constr_1037\]](#)

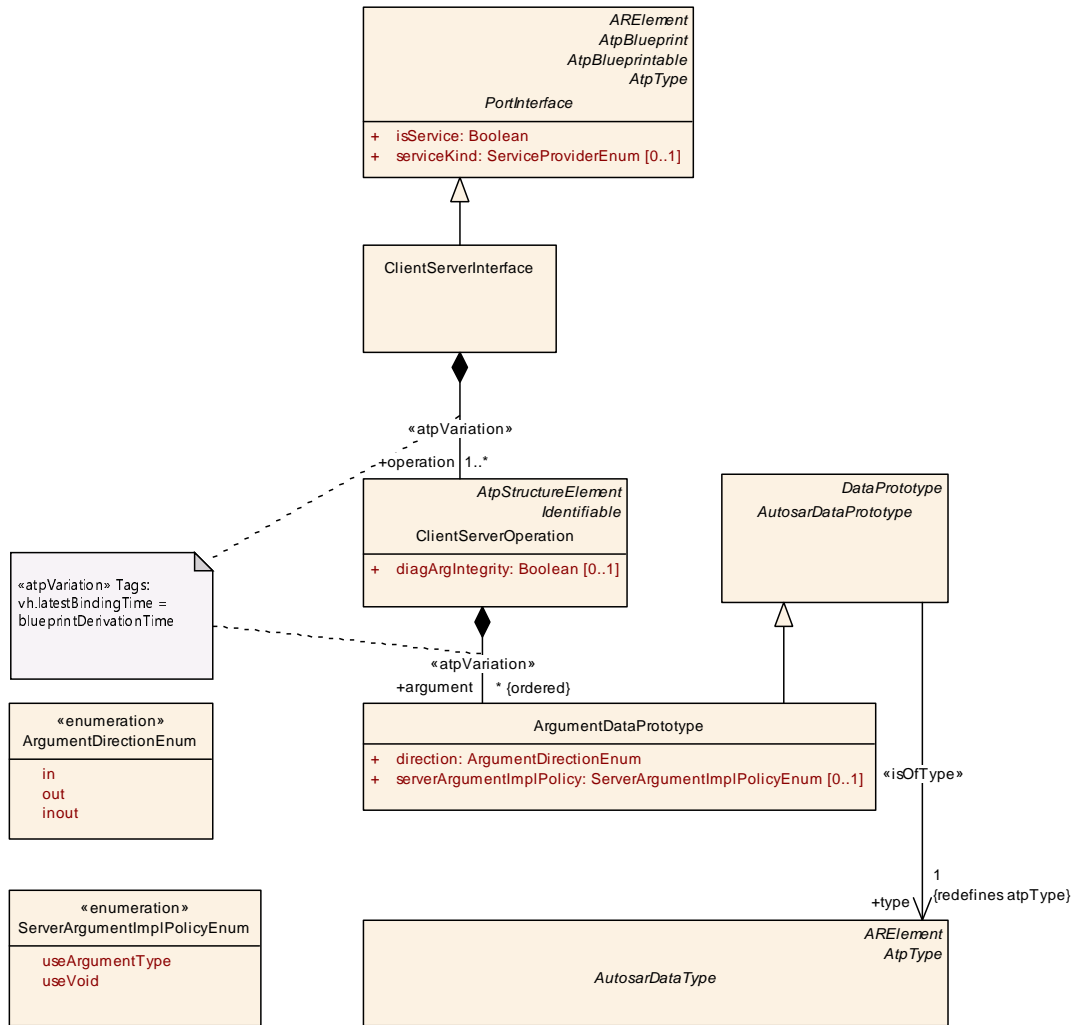

Figure 4.2: ClientServerOperations of a ClientServerInterface

[TPS_SWCT_01118] **ClientServerInterface** [A ClientServerInterface is composed of ClientServerOperations, i.e. a ClientServerOperation cannot be reused in the context of a different ClientServerInterface.]()

[TPS_SWCT_01106] **ClientServerOperation** [A ClientServerOperation consists of 0..* ArgumentDataPrototypes. The latter may be

- passed to the operation (i.e. the direction is “in”)
- passed to and returned from the operation (i.e. the direction is “inout”)
- returned from the operation (i.e. the direction is “out”)

The aggregation represents a variation point.] (RS_SWCT_03141)

Class	ClientServerOperation			
Package	M2::AUTOSARTemplates::SWComponentTemplate::PortInterface			
Note	An operation declared within the scope of a client/server interface.			
Base	<i>ARObject, AtpClassifier, AtpFeature, AtpStructureElement, Identifiable, MultilanguageReferrable, Referrable</i>			
Attribute	Type	Mult.	Kind	Note
argument (ordered)	ArgumentDataPrototype	*	aggr	An argument of this ClientServerOperation Stereotypes: atpVariation Tags: vh.latestBindingTime=blueprintDerivationTime
diagArgIntegrity	Boolean	0..1	attr	This attribute shall only be used in the implementation of diagnostic routines to support the case where input and output arguments are allocated in a shared buffer and might unintentionally overwrite input arguments by tentative write operations to output arguments. This situation can happen during sliced execution or while output parameters are arrays (call by reference). The value true means that the ClientServerOperation is aware of the usage of a shared buffer and takes precautions to avoid unintentional overwrite of input arguments. If the attribute does not exist or is set to false the Client ServerOperation does not have to consider the usage of a shared buffer.
possibleError	ApplicationError	*	ref	Possible errors that may be raised by the referring operation.

Table 4.9: ClientServerOperation

Class	ArgumentDataPrototype			
Package	M2::AUTOSARTemplates::SWComponentTemplate::PortInterface			
Note	An argument of an operation, much like a data element, but also carries direction information and is owned by a particular ClientServerOperation.			
Base	<i>ARObject, AtpFeature, AtpPrototype, AutosarDataPrototype, DataPrototype, Identifiable, MultilanguageReferrable, Referrable</i>			
Attribute	Type	Mult.	Kind	Note
direction	ArgumentDirectionEnum	1	attr	This attribute specifies the direction of the argument prototype.
serverArgumentImplPolicy	ServerArgumentImplPolicyEnum	0..1	attr	This defines how the argument type of the servers RunnableEntity is implemented. If the attribute is not defined this has the same semantics as if the attribute is set to the value useArgumentType for primitive arguments and structures.

Table 4.10: ArgumentDataPrototype

[TPS_SWCT_01119] Direction of [ArgumentDataPrototypes](#) [To cover these cases, [ArgumentDataPrototype](#) defines an attribute `direction`, possible values are `in` (pass to operation), `out` (return from operation), and `inout` (pass to and return from operation).]()

In many common programming languages (like C), an operation is yet another data type. This makes it for example possible to pass a reference to an operation as an argument to another operation.

This is *not* allowed in the AUTOSAR concept.

[TPS_SWCT_01517] ClientServerOperation cannot be passed as a reference [It is not possible to pass a reference to a `ClientServerOperation` as an `ArgumentDataPrototype` in another `ClientServerOperation`.]()

Essentially, all `ArgumentDataPrototypes` in a `ClientServerOperation` can be passed (conceptually) by value (from the client to the server and/or from the server to the client depending on the `direction` of the `ArgumentDataPrototype`).

[TPS_SWCT_01120] Client needs to provide ArgumentDataPrototypes [When the client invokes an operation, it needs to provide a value for each `ArgumentDataPrototype` that is of direction `in` or `inout`.]()

[TPS_SWCT_01121] Pass correct data type [The value passed to an `ArgumentDataPrototype` of direction `in` or `inout` needs to be of the corresponding `Datatype`.]()

[TPS_SWCT_01122] Synchronous call of ClientServerOperation [In the case of synchronous operation call, the client expects to receive a response to the invocation of the operation.

As part of the response, it receives a value (of the correct `AutosarDataType`) for each `ArgumentDataPrototype` that is of direction `out` or `inout`.]()

Enumeration	ArgumentDirectionEnum
Package	M2::AUTOSARTemplates::GenericStructure::GeneralTemplateClasses::PrimitiveTypes
Note	Use cases: <ul style="list-style-type: none"> Arguments in <code>ClientServerOperation</code> can have different directions that need to be formally indicated because they have an impact on how the function signature looks like eventually. Arguments in <code>BswModuleEntry</code> already determine a function signature, but the direction is used to specify the semantics, especially of pointer arguments.
Literal	Description
in	The argument value is passed to the callee. Tags: atp.EnumerationLiteralIndex=0
inout	The argument value is passed to the callee but also passed back from the callee to the caller. Tags: atp.EnumerationLiteralIndex=1
out	The argument value is passed from the callee to the caller. Tags: atp.EnumerationLiteralIndex=2

Table 4.11: ArgumentDirectionEnum

Each `ClientServerOperation` provides a name space for its `ArgumentDataPrototypes` and therefore has a unique identifier which identifies the operation within the corresponding `ClientServerInterface`.

The `ClientServerOperations` have no ordering within a `ClientServerInterface` (there is no such thing as the “first” operation)³.

³In different parts of the definition of a `ClientServerInterface`, a “calling-order” of the `ClientServerOperations` might be prescribed: the client might be required to use the `ClientServerOperations` in a certain logical ordering. However, this ordering has nothing to do with the order in which the `ClientServerOperations` are listed in the definition of a `ClientServerInterface`

[TPS_SWCT_01123] No default values for `ArgumentDataPrototypes` [It is not possible to define default values for `ArgumentDataPrototypes` defined in the context of a `ClientServerOperation`. Default values might lead to complicated mappings to programming languages.]()

[TPS_SWCT_01124] Definition of `ArgumentDataPrototypes` within the context of a `ClientServerOperation` is ordered [In contrast to the unordered relationship of `ClientServerInterface` to `ClientServerOperation`, the definition of `ArgumentDataPrototypes` within the context of a `ClientServerOperation` is ordered, i.e. a `ClientServerOperation` may have a *first* argument⁴.]()

Please note that `ArgumentDataPrototype` inherits from `AutosarDataPrototype` and therefore has a reference to a concrete `AutosarDataType`.

The RTE Generator uses the referred `AutosarDataTypes` to determine the data types of the arguments depending on the value of the attribute `ArgumentDataPrototype.serverArgumentImplPolicy`.

Enumeration	<code>ServerArgumentImplPolicyEnum</code>
Package	<code>M2::AUTOSARTemplates::SWComponentTemplate::PortInterface</code>
Note	This defines how the argument type of the servers <code>RunnableEntity</code> is implemented.
Literal	Description
<code>useArgumentType</code>	The argument type of the <code>RunnableEntity</code> is derived from the <code>AutosarDataType</code> of the <code>ArgumentPrototype</code> . Tags: <code>atp.EnumerationLiteralIndex=0</code>
<code>useVoid</code>	The argument type of the <code>RunnableEntity</code> is void. Tags: <code>atp.EnumerationLiteralIndex=2</code>

Table 4.12: `ServerArgumentImplPolicyEnum`

[constr_1286] `serverArgumentImplPolicy` and `ArgumentDataPrototype` typed by primitive data types [The value of the attribute `ArgumentDataPrototype.serverArgumentImplPolicy` shall **not** be set to `useVoid` for an `ArgumentDataPrototype` of `direction in` that is typed by an `AutosarDataType` that boils down to a primitive C data type (see [TPS_SWCT_01565]).]()

Please note that the server `RunnableEntity` needs information about the currently used array length respectively structure size by usage of additionally arguments passed by the Client or via `PortDefinedArgumentValue`.

Note further that a `ClientServerInterface` does not define any timing information (how quickly the client expects a response of the server). It does not define how the

⁴ Giving the `ArgumentDataPrototypes` of a `ClientServerOperation` both an ordering and a unique identifier might seem redundant.

For example, in the operation “foo(a, b, c)”, we can refer to the “second argument” or to “the argument named b”. In many common programming languages (like C or Java), only the *ordering* is actually used by the client during the invocation of the server (the client invokes the operation as “foo(1,2,3)” not as “foo(a=1,c=3,b=2)”).

In addition, the names of the arguments represent an arbitrary choice made when implementing of the invocation. In C, only the data types and ordering of the arguments constitute the signature, *not* the names of the arguments.

threading works (if the client for example blocks until the response comes back from the server).

It also does not define explicitly how information is passed between an implementation of the client and the server and the underlying RTE (for example: through “pointers” or “by value”).

[constr_1204] Supported connections by `AssemblySwConnector` for `PortPrototypes` typed by a `ClientServerInterface`, `ModeSwitchInterface`, or `TriggerInterface` [For the modeling of `AssemblySwConnectors` between `PortPrototypes` typed by a `ClientServerInterface`, `ModeSwitchInterface`, or `TriggerInterface`, **only** the connections documented in Table 4.13 are supported by AUTOSAR.]()

	<code>RPortPrototype</code>	<code>PPortPrototype</code>	<code>PRPortPrototype</code>
<code>RPortPrototype</code>	No	Yes	Yes
<code>PPortPrototype</code>	Yes	No	No
<code>PRPortPrototype</code>	Yes	No	No

Table 4.13: Supported connections for `PortPrototypes` typed by a `ClientServerInterface`, `ModeSwitchInterface`, or `TriggerInterface`

[constr_1205] Supported connections by `DelegationSwConnector` for `PortPrototypes` typed by a `ClientServerInterface`, `ModeSwitchInterface`, or `TriggerInterface` [For the modeling of `DelegationSwConnectors` between `PortPrototypes` typed by a `ClientServerInterface`, `ModeSwitchInterface`, or `TriggerInterface`, **only** the connections documented in Table 4.14 are supported by AUTOSAR.]()

<code>innerPort</code>	<code>outerPort</code>		
	<code>RPortPrototype</code>	<code>PPortPrototype</code>	<code>PRPortPrototype</code>
<code>RPortPrototype</code>	Yes	No	No
<code>PPortPrototype</code>	No	Yes	No
<code>PRPortPrototype</code>	No	Yes	No

Table 4.14: Supported connections for `PortPrototypes` typed by a `ClientServerInterface`, `ModeSwitchInterface`, or `TriggerInterface`

Please note that a restriction concerning the usage of attribute `ClientServerOperation.diagArgIntegrity` is described in section 13.8.4.4.

4.2.3.2 Error Handling in Client/Server Communication

This section describes the handling of errors occurring either within an application software-component or during the communication across the VFB [3]. Errors that are created and consumed by basic software modules are not in the scope of this document and therefore will not be discussed.

Therefore, errors in the scope of this document are divided into two simple classes:

- infrastructure errors and
- application errors.

A software-component implementation uses RTE API methods to communicate with other software-components. During this communication certain errors can occur as a result of infrastructure faults, like a bus is not working, or an expected data value was not arriving in time.

These errors are listed in the RTE specification [2], as they are an inherent feature of the infrastructure provided by the VFB. Software-components will therefore typically not raise infrastructure errors on their own.

Instead, the AUTOSAR basic software and the RTE will determine infrastructure faults and communicate the corresponding error codes to the relevant software-components.

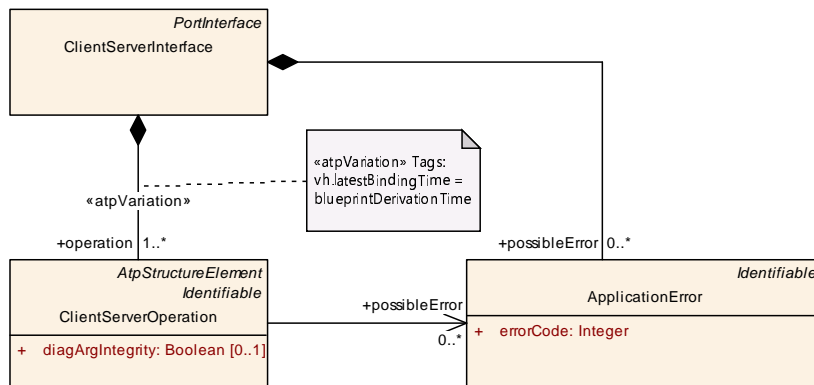

Figure 4.3: Application error meta-model

[TPS_SWCT_01491] AUTOSAR system does not need to explicitly describe infrastructure errors [As the fixed set of infrastructure errors is defined as an implicit part of the VFB, a developer of an AUTOSAR system does not need to explicitly describe these.

It is assumed that these might occur at run-time and application developers should take measures to handle them.]()

Application errors, on the other hand, are specific to the functionality or information that is described in form of a [PortInterface](#). It is not possible to define such errors up front, instead they are defined at design time of a certain [PortInterface](#).

In principle, such [ApplicationErrors](#) could be part of all kinds of [PortInterfaces](#).

[constr_1102] ApplicationError in the scope of one SwComponentType [If a [SwComponentType](#) has [PortPrototypes](#) typed by different [ClientServerInterfaces](#) with equal [shortName](#) and [ApplicationErrors](#) defined then the following condition applies: [ApplicationErrors](#) with the same [shortName](#) shall have **identical values** of [errorCodes](#).]()

Rationale for the existence of [constr_1102]: the RTE generator creates symbols for the error codes in which the `shortName` of the `ClientServerInterface` and the `shortName` of the `ApplicationError` occur.

[constr_1108] Value of `ApplicationError.errorCode` [The value of `ApplicationError.errorCode` shall not exceed the closed interval 1 .. 63. The following exception applies: **only** in case `possibleError` is supposed to represent `E_OK` the value 0 shall be allowed.]()

By [constr_1108] it is possible to ensure that only the six least significant bits of a return value shall be used for indicating an application error.

Class	ApplicationError			
Package	M2::AUTOSARTemplates::SWComponentTemplate::PortInterface			
Note	This is a user-defined error that is associated with an element of an AUTOSAR interface. It is specific for the particular functionality or service provided by the AUTOSAR software component.			
Base	<i>ARObject</i> , <i>Identifiable</i> , <i>MultilanguageReferrable</i> , <i>Referrable</i>			
Attribute	Type	Mult.	Kind	Note
errorCode	Integer	1	attr	The RTE generator is forced to assign this value to the corresponding error symbol. Note that for error codes certain ranges are predefined (see RTE specification).

Table 4.15: ApplicationError

Consequently, `ClientServerOperations` may be associated with a number of `ApplicationErrors` they possibly raise. These errors are defined as part of the `ClientServerInterface`.

[constr_1038] Reference to `ApplicationError` [A `possibleError` referenced by a `ClientServerOperation` shall be owned by the `PortInterface` that also owns the `ClientServerOperation`.]()

Please note that the meta-class `ApplicationError` is also used on the *AUTOSAR adaptive platform* (see [16]) and therefore [constr_1038] cannot be more specific about the nature of the enclosing `PortInterface`.

4.2.4 External Trigger Event Communication

[TPS_SWCT_01196] Semantics of an external trigger event communication [The underlying semantics of an external trigger event communication is that a trigger source may initiate the execution of `RunnableEntity`s in the connected trigger sinks. Typically, (but not necessarily) these `RunnableEntity`s are executed in a sequential order.]()

[TPS_SWCT_01197] `TriggerInterface` [The `TriggerInterface` defines a set of `Trigger` to be communicated between software-components. The `Trigger` represents a special kind of events at which occurrence the trigger sinks shall react in a particular manner.]()

Class	TriggerInterface			
Package	M2::AUTOSARTemplates::SWComponentTemplate::PortInterface			
Note	A trigger interface declares a number of triggers that can be sent by an trigger source. Tags: atp.recommendedPackage=PortInterfaces			
Base	ARElement , ARObject , AtpBlueprint , AtpBlueprintable , AtpClassifier , AtpType , CollectableElement , Identifiable , MultilanguageReferrable , PackageableElement , PortInterface , Referrable			
Attribute	Type	Mult.	Kind	Note
trigger	Trigger	1..*	aggr	The Trigger of this trigger interface.

Table 4.16: TriggerInterface

Class	Trigger			
Package	M2::AUTOSARTemplates::CommonStructure::TriggerDeclaration			
Note	A trigger which is provided (i.e. released) or required (i.e. used to activate something) in the given context.			
Base	ARObject , AtpClassifier , AtpFeature , AtpStructureElement , Identifiable , MultilanguageReferrable , Referrable			
Attribute	Type	Mult.	Kind	Note
swImplPolicy	SwImplPolicyEnum	0..1	attr	This attribute, when set to value queued, allows for a queued processing of Triggers.
triggerPeriod	MultidimensionalTime	0..1	aggr	Optional definition of a period in case of a periodically (time or angle) driven external trigger.

Table 4.17: Trigger

Class	MultidimensionalTime			
Package	M2::AUTOSARTemplates::GenericStructure::GeneralTemplateClasses::MultidimensionalTime			
Note	This is used to specify a multidimensional time value based on ASAM CSE codes. It is specified by a code which defined the basis of the time and a scaling factor which finally determines the time value. If for example the cseCode is 100 and the cseCodeFactor is 360, it represents 360 angular degrees. If the cseCode is 0 and the cseCodeFactor is 50 it represents 50 microseconds.			
Base	ARObject			
Attribute	Type	Mult.	Kind	Note
cseCode	CseCodeType	1	attr	Specifies the time base by means of CSE codes.
cseCodeFactor	Integer	1	attr	The scaling factor for the time value based on the specified CSE code.

Table 4.18: MultidimensionalTime

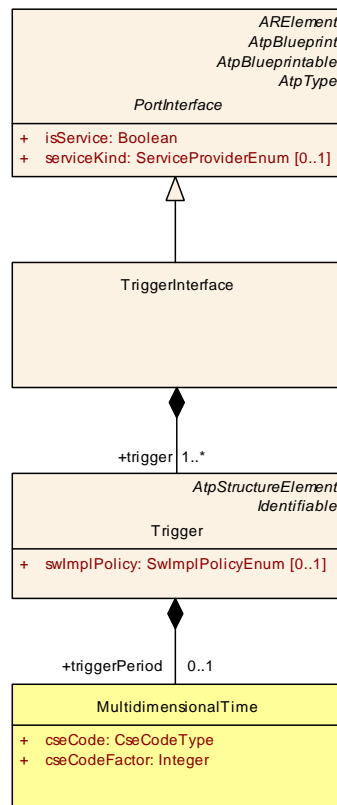

Figure 4.4: Trigger of a TriggerInterface

As illustrated in Figure 4.4, a `TriggerInterface` is composed of `Trigger`.

[TPS_SWCT_01198] Period for periodic triggering [A `Trigger` can optionally define a period for periodic triggering. It is expressed via the meta-class `MultidimensionalTime` in terms of time or angle. Note that the main use case for this is to specify the properties if the trigger is coming from the Basic Software e.g. from a Complex Driver, it is not used as an input for the RTE generator.]()

Apart from this, a `TriggerInterface` does not define any timing information (e.g. how quickly the source expects a reaction of the sinks). This is property of the timing information in the templates.

[constr_1104] Trigger sink and trigger source [An `RPortPrototype` typed by a `TriggerInterface` shall not be referenced by more than one `SwConnectors` that are in turn referencing `PPortPrototypes` typed by `TriggerInterfaces` that contain `Triggers` with the same `shortName`.]()

[`constr_1104`] boils down to the requirement that trigger communication shall not be implemented in an n:1 scenario.

To be clear, the n:1 scenario is not supported for trigger communication because there is no active use case for it. Support would require the implementation of queue management for Trigger communication.

[TPS_SWCT_01199] Queued processing of Triggers [It may happen that at least tentatively a `Trigger` source fires `Triggers` faster than they can be processed on

the side of the `Trigger` sink. To support this use case it is possible to process trigger event communication in a queued manner.

In this case the `Triggers` are added to a queue from where the foremost trigger is dequeued and processed when the processing of the current `Trigger` is done. Please note that the queue size is **not** subject to definition in the scope of this document. The actual queue size is defined during the process of RTE configuration.

The specification of whether a `Trigger` is subject to queued processing is controlled by the attribute `Trigger.swImplPolicy.()`

[constr_1169] Allowed values for `Trigger.swImplPolicy` [The **only** allowed values for the attribute `Trigger.swImplPolicy` are either `STANDARD` (in which case the `Trigger` processing does not use a queue) or `QUEUED` (in which case the processing of `Triggers` positively uses a queue).]

Please note that the value of `Trigger.swImplPolicy` is not the final word on the implementation of a queue for the specific `Trigger`. The integrator still has the power to overrule the application software developer's verdict if applicable.

For more information regarding the ability to connect different kinds of `PortPrototypes` typed by a `TriggerInterface` to each other please refer to [\[constr_1204\]](#) and [\[constr_1205\]](#).

4.2.5 Communication of Modes

There are two distinctive use cases for the communication of modes via ports:

1. An actual mode transition can be communicated from a mode manager component to its client components to enforce a mode switch.
2. A request for a mode transition can be communicated from any component to a mode manager.

[TPS_SWCT_01087] Propagation of mode information [For communicating a mode switch (i.e. the first use case), the Software-Component Template describes the concept of the communication of `ModeDeclarationGroupPrototypes` similar to the communication of `VariableDataPrototypes` but it uses a special type of `PortInterface`: the collections of `ModeDeclarations` that are required or provided by a `SwComponentType` are defined by means of `ModeSwitchInterfaces` used to type the `PortPrototypes` owned by the `SwComponentType`.] ([RS_SWCT_03203](#))

This aspect is depicted in Figure [4.5](#).

Due to the strong interaction with the RTE for handling the mode switches, this first use case does not allow communication across ECU boundaries:

[constr_4000] Local communication of mode switches [Ports with `ModeSwitchInterfaces` cannot be connected across ECU boundaries.] ()

[constr_2049] Different ModeDeclarationGroups shall have different shortNames. [A software component is not allowed to type multiple PortPrototypes with ModeSwitchInterfaces where the contained ModeDeclarationGroupPrototypes are referencing ModeDeclarationGroups with identical shortNames but different ModeDeclarations.]()

Obviously, the rationale for [constr_2049] is to avoid conflicts in generated RTE files.

For instance:

Two ModeDeclarationGroups with identical shortName “Foo” are defined.

ModeDeclarationGroup “Foo”
contains the ModeDeclarations “X”, “Y”, “Z”

ModeDeclarationGroup “Foo*”
contains the ModeDeclarations “W”, “X”, “Y”, “Z”

In this case a software component is only allowed to use either “Foo” or “Foo*”

Class	ModeSwitchInterface			
Package	M2::AUTOSARTemplates::SWComponentTemplate::PortInterface			
Note	A mode switch interface declares a ModeDeclarationGroupPrototype to be sent and received. Tags: atp.recommendedPackage=PortInterfaces			
Base	ARElement , ARObject , AtpBlueprint , AtpBlueprintable , AtpClassifier , AtpType , CollectableElement , Identifiable , MultilanguageReferrable , PackageableElement , PortInterface , Referrable			
Attribute	Type	Mult.	Kind	Note
modeGroup	ModeDeclarationGroupPrototype	1	aggr	The ModeDeclarationGroupPrototype of this mode interface.

Table 4.19: ModeSwitchInterface

Class	ModeDeclarationGroupPrototype			
Package	M2::AUTOSARTemplates::CommonStructure::ModeDeclaration			
Note	The ModeDeclarationGroupPrototype specifies a set of Modes (ModeDeclarationGroup) which is provided or required in the given context. Tags: atp.ManifestKind=ExecutionManifest,MachineManifest			
Base	ARObject , AtpFeature , AtpPrototype , Identifiable , MultilanguageReferrable , Referrable			
Attribute	Type	Mult.	Kind	Note
swCalibrationAccess	SwCalibrationAccessEnum	0..1	attr	This allows for specifying whether or not the enclosing ModeDeclarationGroupPrototype can be measured at run-time.
type	ModeDeclarationGroup	1	tref	The "collection of ModeDeclarations" (= ModeDeclarationGroup) supported by a component Stereotypes: isOfType

Table 4.20: ModeDeclarationGroupPrototype

Please note that by aggregating [SwCalibrationAccessEnum](#) in the role [swCalibrationAccess](#) a [ModeDeclarationGroupPrototype](#) gains the ability to become measurable. This implies the following constraint:

[constr_1172] Allowed values of `SwCalibrationAccessEnum` for `ModeDeclarationGroupPrototype` [The only allowed values of `swCalibrationAccess` aggregated by `ModeDeclarationGroupPrototype` are `notAccessible` and `readOnly`.]()

[TPS_SWCT_01566] Define literals for an MCD system in the context of a `FlatInstanceDescriptor` [If `ModeDeclarationGroupPrototype.swCalibrationAccess` is set to `readOnly` a referenced `FlatInstanceDescriptor.swDataDefProps` may in turn refer to a `CompuMethod` that defines the particular literals used in the MCD system for displaying values of the measured `ModeDeclarationGroupPrototypes`.](*RS_SWCT_03203*)

The existence of this use case is the reason for putting “AI” at the intersection of `compuMethod` and `FlatInstanceDescriptor`.

Another possible scenario (that does not necessarily have to be related to `ModeDeclarationGroupPrototypes` but to the definition of literals for MCD systems in general) is that a `FlatInstanceDescriptor` does not exist (e.g. because the affected piece of data exists in the basic software) but still it would be good to have the ability to define particular literals for displaying values in an MCD system.

This case can be supported by the AUTOSAR standard as well by putting “AI” at the intersection of `compuMethod` and `McDataInstance` in table 5.41.

[TPS_SWCT_01200] `ModeDeclarationGroupPrototype` per `ModeSwitchInterface` [The multiplicity of the aggregation of `ModeDeclarationGroupPrototype` to `ModeSwitchInterface` is pragmatically limited to 1.](*RS_SWCT_03203*)

Admittedly, there would be no technical restriction to support a 0..* multiplicity but on the other hand it does not seem as if any reasonable use case for such a scenario exists.

If somehow a `SwComponentType` would have to consider two or even more `ModeDeclarationGroupPrototypes` it is very likely that these would be part of different `ModeSwitchInterfaces`.

The containment of a `ModeDeclarationGroupPrototype` in a `ModeSwitchInterface` allows for explicitly defining `SwConnectors` which communicate between `SwComponentPrototypes` and to define service interfaces for communication with `ServiceSwComponentTypes`. Due to the compatibility rules of `PortInterfaces` (see chapter 6) each `SwComponentType` can rely on the availability of required mode activations.

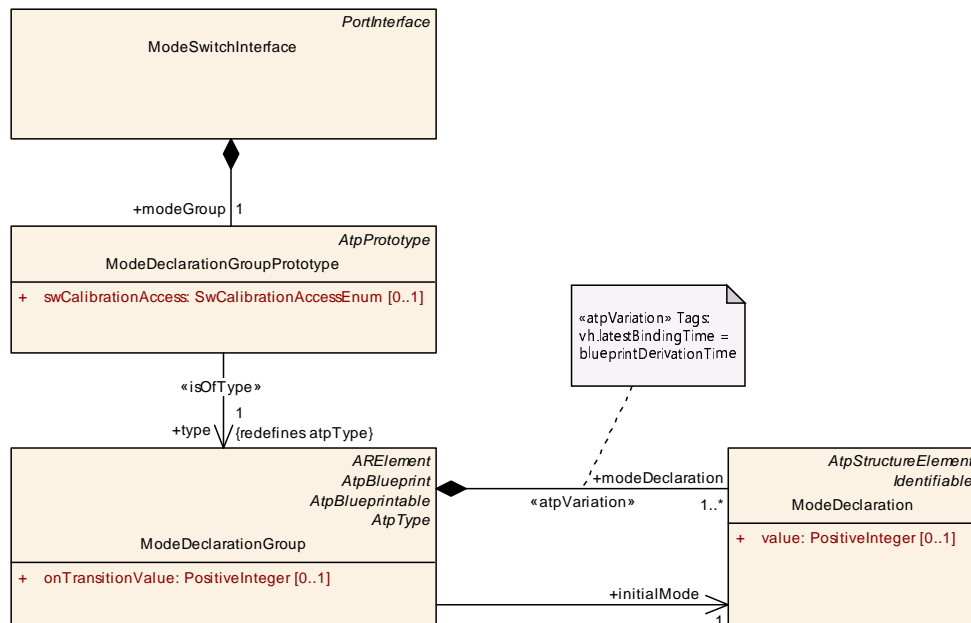

Figure 4.5: Mode Switch Interface

Please note that each `SwComponentType` can define (via their `PortPrototypes` and `ModeSwitchInterfaces`) a list of required and provided `ModeDeclarationGroupPrototypes`.

[TPS_SWCT_01201] CompositionSwComponentType requires and provides the modes that are required or provided by its contained `SwComponentPrototypes` [Eventually, a `CompositionSwComponentType` requires and provides the modes that are required or provided by its contained `SwComponentPrototypes`. The delegation of these modes from `SwComponentPrototypes` to the enclosing `CompositionSwComponentType` is explicitly described by `DelegationSwConnectors`.] (*RS_SWCT_03202, RS_SWCT_03203*)

The formal description of a software-component does not make any assumptions about the semantics of the required and provided `ModeDeclarationGroupPrototypes`. It just requires and provides the `ModeDeclarationGroupPrototypes` by name. For more information about mode declaration refer to section 9.1.

[TPS_SWCT_01086] Request mode change [The ability to request a mode (i.e. the second use case) is modeled on the VFB via a `SenderReceiverInterface` and for the RTE it is like a usual communication, that means the connector can also cross ECU boundaries and the communicated `dataElements` have to be based on `AutosarDataTypes`.] (*RS_SWCT_03202, RS_SWCT_03203*)

However, for semantic consistency with the first use case, a communicated mode request shall also be mapped to a corresponding `ModeDeclarationGroup`. This can be defined by a mapping class as shown in figure 4.6.

The `ImplementationDataType` mapped to a certain `ModeDeclarationGroup` can then be used in a `PortInterface` to represent a `ModeDeclaration` of the associated `ModeDeclarationGroup` as a numerical value:

[constr_4002] Unambiguous mapping of modes to data types [Within one `DataTypeMappingSet`, a `ModeDeclarationGroup` shall not be mapped to different `ImplementationDataTypes`.] ()

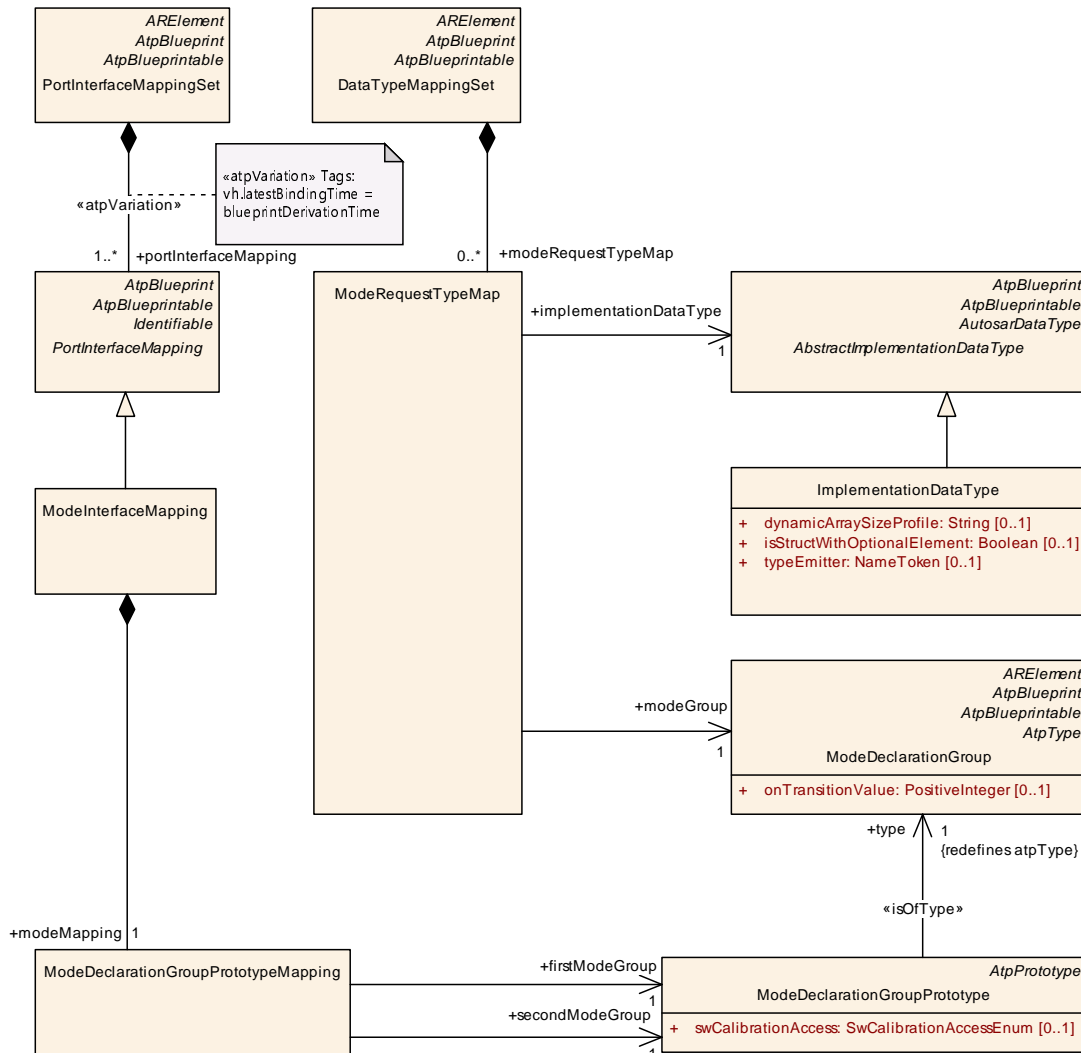

Figure 4.6: Mapping of modes to data types

Class	ModeRequestTypeMap			
Package	M2::AUTOSARTemplates::CommonStructure::ModeDeclaration			
Note	Specifies a mapping between a <code>ModeDeclarationGroup</code> and an <code>ImplementationDataType</code> . This <code>ImplementationDataType</code> shall be used to implement the <code>ModeDeclarationGroup</code> .			
Base	<i>ARObject</i>			
Attribute	Type	Mult.	Kind	Note
implementation DataType	AbstractImplementation DataType	1	ref	This is the corresponding <code>AbstractImplementationData Type</code> . It shall be modeled along the idea of an "unsigned integer-like" data type.





Class	ModeRequestTypeMap			
modeGroup	ModeDeclarationGroup	1	ref	This is the corresponding ModeDeclarationGroup.

Table 4.21: ModeRequestTypeMap

[constr_1166] Restrictions of ModeRequestTypeMap [For every ModeDeclarationGroup referenced by a ModeDeclarationGroupPrototype used in a PortPrototype typed by a ModeSwitchInterface a ModeRequestTypeMap shall exist that points to the ModeDeclarationGroup and also to an eligible ImplementationDataType.

The ModeRequestTypeMap shall be aggregated by a DataTypeMappingSet which is referenced from the SwcInternalBehavior that is owned by the ApplicationSwComponentType that also owns the PortPrototype.]()

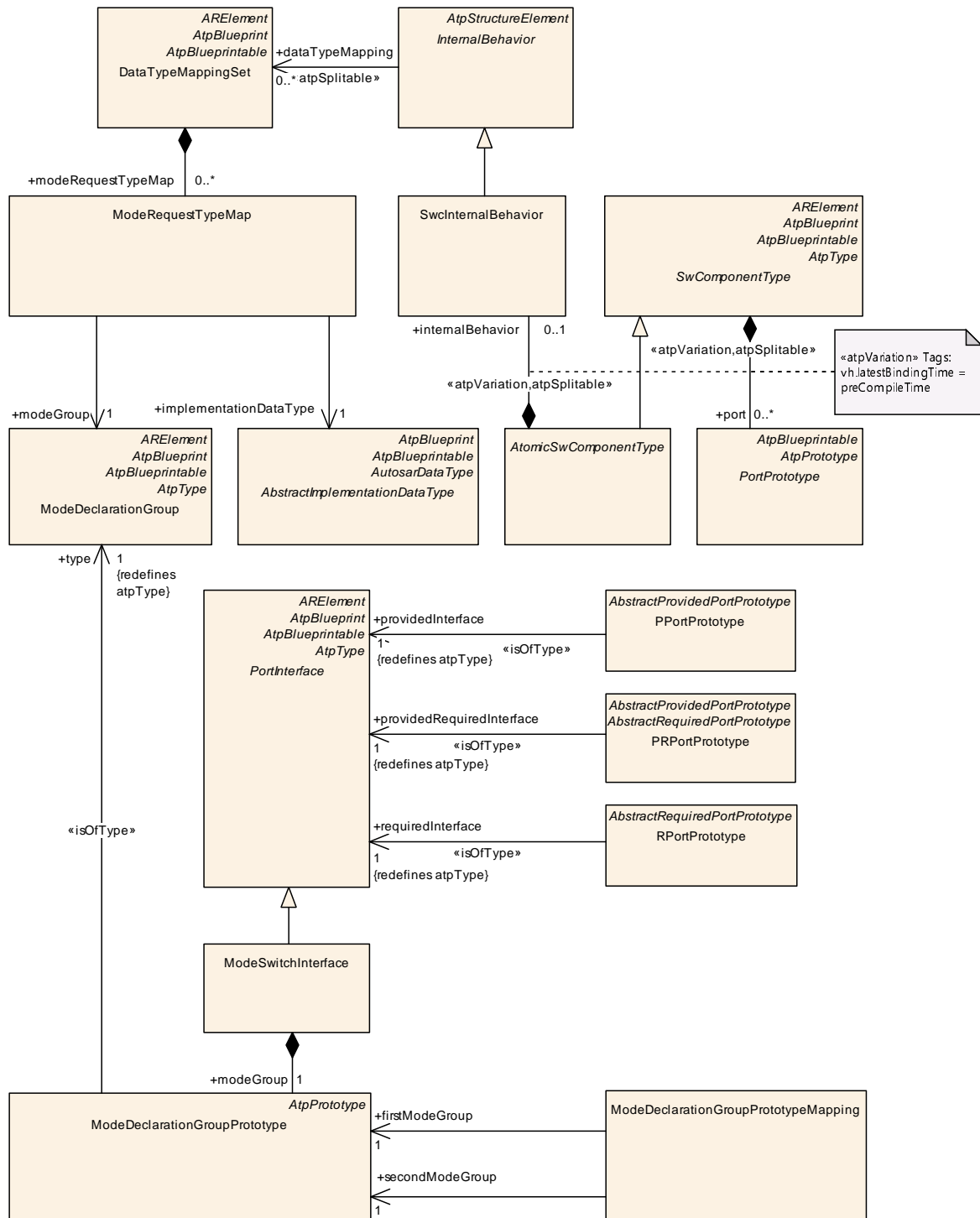

Figure 4.7: Big picture of mode declaration mapping

[constr_1167] **ImplementationDataTypes** used as **ModeRequestTypeMap.implementationDataType** [The **ImplementationDataType** referenced by a **ModeRequestTypeMap** shall **either** be of category **VALUE** or of category **TYPE_REFERENCE** that in turn references an **ImplementationDataType** of category **VALUE**.

The `baseType` referenced by the `ImplementationDataType` shall have set the value of the attribute `BaseTypeDirectDefinition.baseTypeEncoding` to `NONE`.
()

[TPS_SWCT_01202] `ApplicationDataType` defines a subset of the values used in the `ModeDeclarationGroup` [Please note that the corresponding `ApplicationDataType` is defining a subset of the values used in the `ModeDeclarationGroup` and the used labels may differ from the names used for the `ModeDeclarations`.

It is in the responsibility of a system designer to maintain the data types and `ModeDeclarationGroups` according to the functional needs.

For example, a `ModeRequester` may only request a subset of the available `Modes` (via `SenderReceiverInterface` or `ClientServerInterface`). The `ModeManager` may additionally decide to indicate failure.] (*RS_SWCT_03203*)

For more information regarding the ability to connect different kinds of `PortPrototypes` typed by a `ModeSwitchInterface` to each other please refer to [*constr_1204*] and [*constr_1205*].

4.2.6 Parameter Communication

Of course, the “communication” of `ParameterDataPrototypes` as part of a `ParameterInterface` does not establish an actual transmission of data.

The term is used in a conceptual meaning; and the existence of something like a `ParameterInterface` is justified by the mere idea of unifying the exposure of calibration parameters at the surface of a software-component on the same formal level as the exposure of other pieces of data, i.e. by means of a `PortPrototype` typed by a `PortInterface`.

[constr_1312] `PortPrototypes` typed by a `ParameterInterface` [`PortPrototypes` typed by a `ParameterInterface` can either be `PPortPrototypes` or `RPortPrototypes`. The usage of `PRPortPrototypes` that are typed by a `ParameterInterface` is not supported.] ()

4.3 PortInterface Mapping and Data Scaling

In former versions of this specification, the requirements on `PortInterfaces` to match each other could lead to situations where `PortInterfaces` that were “practically” compatible would nevertheless be rejected because of formal reasons (e.g. `shortNames` of `dataElements` do not match).

In order to also support scenarios where the developer of a `CompositionSwComponentType` needs to connect `PortPrototypes` that would match to each other but

don't fulfill formal requirements the concept of "port interface mapping" has been introduced.

[TPS_SWCT_01158] Cases for `PortInterfaceMapping` [In general, the existence of a `PortInterfaceMapping` is suitable in the following cases:

1. Two `PortPrototypes` shall be connected and the `PortInterface` elements are compatible except the unequal `shortNames`. This requires a pure logical mapping of the `PortInterface` elements.
2. `PortInterface` elements are logically equivalent but the range and resolution is differently. This requires a data conversion respectively a re-scaling of the provided data and arguments to the required data and arguments range and resolution.
3. `invalidationPolicy` of `PortInterface` elements is different. This might require the implementation of different invalidation handling strategies for the same `dataElement` in parallel on the same ECU.
4. Two `PortPrototypes` shall be connected and the `PortInterface` elements shall be converted using the AUTOSAR data transformer approach.

]([RS_SWCT_03210](#))

More information about the AUTOSAR data transformer approach can be found in section [4.3.3](#).

Typically, the mapping of such `PortInterface` is agreed once between the different component vendors and system designer in the early phase of a project.

[TPS_SWCT_01159] Mapping is described separately from the `SwConnector` as reusable `ARElement` [The mapping is described separately from the `SwConnector` as reusable `ARElement`. A set of `PortInterfaceMappings` is grouped in a `PortInterfaceMappingSet`.]([RS_SWCT_03210](#))

[TPS_SWCT_01543] `PortInterfaceMapping` overrides all other compatibility rules [The existence of a `PortInterfaceMapping` overrides all other compatibility rules given that the following statements are fulfilled:

- [[constr_1071](#)] applies also for the application of a `PortInterfaceMapping`.
- [[constr_1268](#)] applies also for the application of a `PortInterfaceMapping`.
- [[constr_1269](#)] applies also for the application of a `PortInterfaceMapping`.
- [[constr_1270](#)] applies also for the application of a `PortInterfaceMapping`.
- A structural difference between mapped `DataPrototypes` can be mitigated by means of a `SubElementMapping`. This includes the case that a "structure" data type is mapped to an "array" data type and vice versa. [[TPS_SWCT_01195](#)] is also applicable.

When using a [PortInterfaceMapping](#), the developer of a software-component needs to properly understand the consequences in terms of model semantics. ([RS_SWCT_03210](#))

Please note that [[TPS_SWCT_01543](#)] does not require a tool implementation to ignore and let go unreported deviations of all other compatibility rules in the presence of a [PortInterfaceMapping](#).

If this is considered helpful, the tool **may** still issue warnings with respect to compatibility rules defined in section 6 but this is not mandated by the AUTOSAR standard. The tool, however, **shall not** report errors in this case.

Class	PortInterfaceMappingSet			
Package	M2::AUTOSARTemplates::SWComponentTemplate::PortInterface			
Note	Specifies a set of (one or more) PortInterfaceMappings . Tags: atp.recommendedPackage=PortInterfaceMappingSets			
Base	ARElement , ARObject , AtpBlueprint , AtpBlueprintable , CollectableElement , Identifiable , MultilanguageReferrable , PackageableElement , Referrable			
Attribute	Type	Mult.	Kind	Note
portInterfaceMapping	PortInterfaceMapping	1..*	aggr	Specifies one PortInterfaceMapping to support the connection of Ports typed by two different PortInterfaces with PortInterface elements having unequal names and/or unequal semantic (resolution or range). Stereotypes: atpVariation Tags: vh.latestBindingTime=blueprintDerivationTime

Table 4.22: PortInterfaceMappingSet

Class	PortInterfaceMapping (abstract)			
Package	M2::AUTOSARTemplates::SWComponentTemplate::PortInterface			
Note	Specifies one PortInterfaceMapping to support the connection of Ports typed by two different PortInterfaces with PortInterface elements having unequal names and/or unequal semantic (resolution or range).			
Base	ARObject , AtpBlueprint , AtpBlueprintable , Identifiable , MultilanguageReferrable , Referrable			
Subclasses	ClientServerInterfaceMapping , ModelInterfaceMapping , TriggerInterfaceMapping , VariableAndParameterInterfaceMapping			
Attribute	Type	Mult.	Kind	Note
–	–	–	–	–

Table 4.23: PortInterfaceMapping

4.3.1 PortInterface Mapping

By default, the [shortNames](#) of [PortInterface](#) elements are used to identify the matching element pairs of connected [PortPrototypes](#). In case of non-matching [shortNames](#) (this might be due to distributed development, off-the-shelves development, or reuse of software-components) it is required to explicitly specify which elements of [PortInterfaces](#) shall correlate to each other.

This definition is provided with [PortInterfaceMappings](#).

[TPS_SWCT_01099] **PortInterfaceMapping** [Each `PortInterfaceMapping` describes the mapping of the `PortInterface` elements of exactly two `PortInterfaces`.] (*RS_SWCT_03155, RS_SWCT_03210*)

To apply the `PortInterfaceMapping` a `SwConnector` has to reference a `PortInterfaceMapping`.

[constr_1151] **Applicability of PortInterfaceMapping** [A `PortInterfaceMapping` is only applicable and valid for a `SwConnector` if the two `PortPrototypes` which are referenced by the `SwConnector` are typed by the same two `PortInterfaces` which are mapped by the `PortInterfaceMapping`.] ()

[TPS_SWCT_01100] **Precedence of PortInterfaceMapping** [The mapping via `PortInterfaceMapping` has a higher precedence than the mapping by equal `shortNames` as defined in compatibility rules.

If a connector references an associated `PortInterfaceMapping`, this mapping shall be strictly binding with respect to the number of mapped data elements.] (*RS_SWCT_03155, RS_SWCT_03210*)

Please note that the compatibility rules are described in chapter 6.

[TPS_SWCT_01101] **Unmapped elements of PortInterfaces** [Unmapped `PortInterface` elements will not be connected by the referencing `SwConnector`.] (*RS_SWCT_03155, RS_SWCT_03210*)

[constr_1583] **PortInterfaceMapping for DataPrototype typed by Compound Primitive Data Type** [There is one very limited use case to apply `PortInterfaceMapping` for a `DataPrototype` typed by a `Compound Primitive Data Type`: adjustment of the `shortName` of the `DataPrototype`. Everything else is **not supported**.] ()

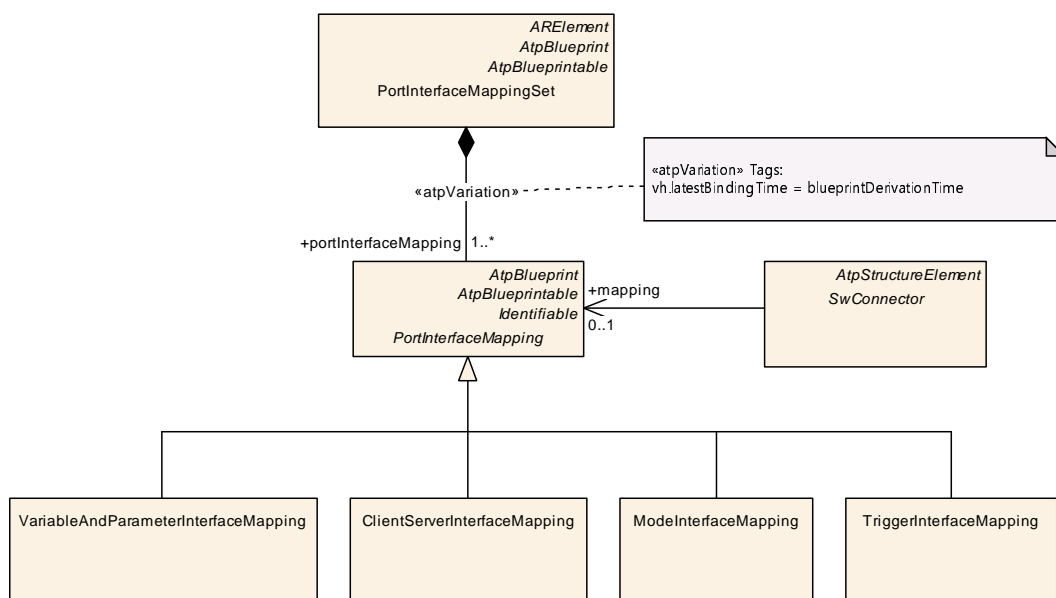

Figure 4.8: Relevant meta-classes for PortInterface element mapping

4.3.1.1 Mapping of Sender Receiver Interface, Parameter Interface and Non Volatile Data Interface Elements

[TPS_SWCT_01102] **VariableAndParameterInterfaceMapping** [The `VariableAndParameterInterfaceMapping` defines the correlation of `VariableDataPrototypes` and `ParameterDataPrototypes` defined in the context of `DataInterfaces`, i.e. `SenderReceiverInterface`, `NvDataInterface`, or `ParameterInterface`.] (*RS_SWCT_03155, RS_SWCT_03210, RS_SWCT_03170*)

[constr_1159] **Consistency of VariableAndParameterInterfaceMapping with respect to the referenced DataInterfaces** [Within one `VariableAndParameterInterfaceMapping` all `firstDataPrototypes` shall belong to one and only one `DataInterface` and all `secondDataPrototypes` shall belong to one other and only one other `DataInterface`.] ()

[TPS_SWCT_01103] **Mapping between different kinds of PortInterfaces** [Thereby it is possible to describe the mapping between different kinds of `PortInterfaces` for instance a `ParameterInterface` and `SenderReceiverInterface`.] (*RS_SWCT_03155, RS_SWCT_03210, RS_SWCT_03170*)

[TPS_SWCT_01104] **Possible mappings are restricted by the swImplPolicy** [Nevertheless, the possible mappings of `VariableDataPrototypes` and `ParameterDataPrototypes` are restricted by the `swImplPolicy` attribute.] (*RS_SWCT_03155, RS_SWCT_03210, RS_SWCT_03170*)

For more explanation of [TPS_SWCT_01104], please refer to [constr_1071].

[constr_1039] **Relevance of swImplPolicy** [It is not possible to define a mapping between an element where the `swImplPolicy` is set to `queued` and another element where the `swImplPolicy` is set differently.] ()

This is required to fulfill the compatibility rules defined in table 6.1.

[constr_1635] **Relevance of attribute isOptional** [If a `SubElementMapping` is defined for the elements of a structured data type then the attribute `isOptional`⁵ shall either not exist for the `firstElement` and `secondElement` or it shall have the identical value for the `firstElement` and `secondElement`.] ()

[constr_1040] **Conversion of SenderReceiverInterfaces** [The conversion of elements of `SenderReceiverInterfaces` is possible if one of the following conditions applies:

- The `AutosarDataTypes` of the referred `DataPrototypes` are compatible.
- A conversion of the data is available.
- A `DataPrototypeMapping.firstToSecondDataTransformation` is defined.

] ()

⁵this is valid for both `ApplicationRecordElement` and `ImplementationDataTypeElement`

The compatibility of AutosarDataTypes is described in section 6.2. A description of the conversion of data can be found in section 4.3.2.

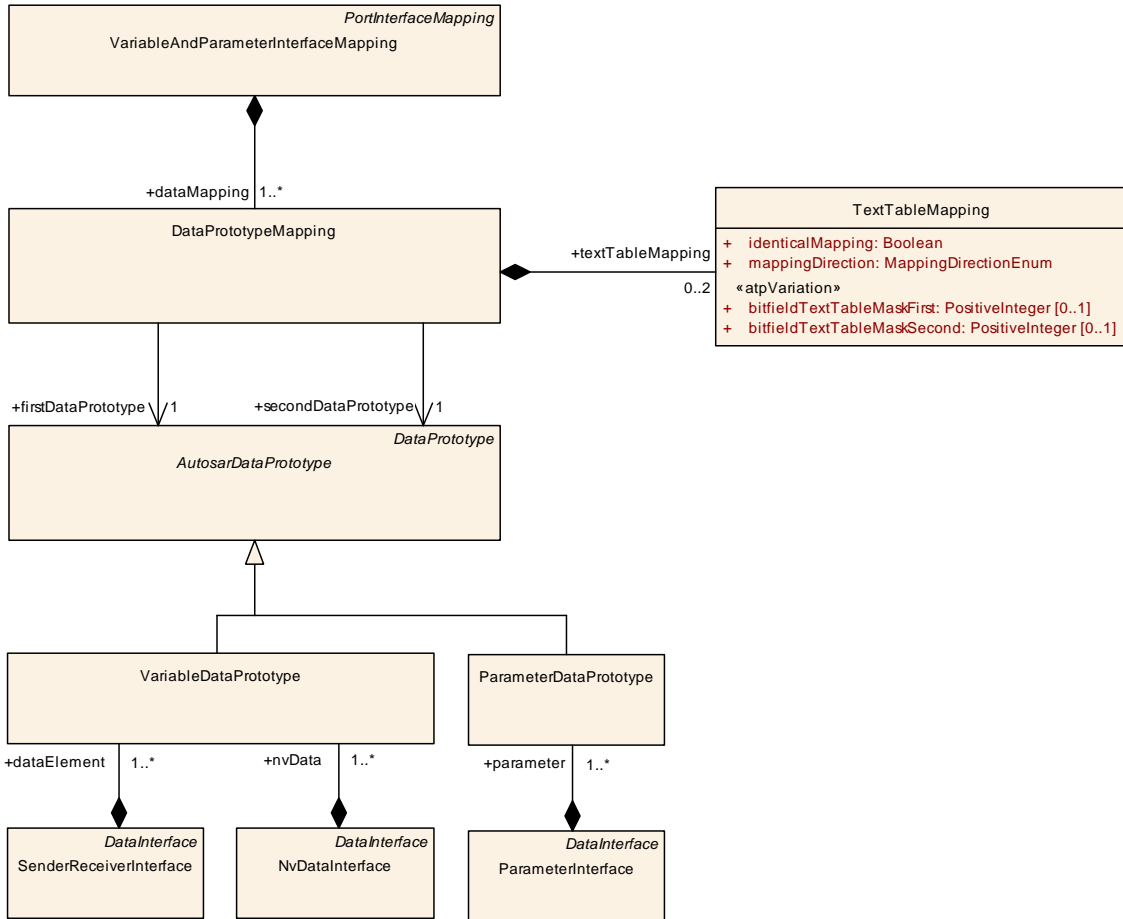

Figure 4.9: Mapping of Sender Receiver Interface, Parameter Interface and Non Volatile Data Interface elements

Class	VariableAndParameterInterfaceMapping			
Package	M2::AUTOSARTemplates::SWComponentTemplate::PortInterface			
Note	Defines the mapping of VariableDataPrototypes or ParameterDataPrototypes in context of two different SenderReceiverInterfaces, NvDataInterfaces or ParameterInterfaces.			
Base	ARObject, AtpBlueprint, AtpBlueprintable, Identifiable, MultilanguageReferrable, PortInterfaceMapping, Referrable			
Attribute	Type	Mult.	Kind	Note
dataMapping	DataPrototypeMapping	1..*	aggr	Defines the mapping of two particular VariableData Prototypes or ParameterDataPrototypes with unequal names and/or unequal semantic (resolution or range) in context of two different SenderReceiverInterfaces, Nv DataInterfaces or ParameterInterfaces

Table 4.24: VariableAndParameterInterfaceMapping

Class	DataPrototypeMapping			
Package	M2::AUTOSARTemplates::SWComponentTemplate::PortInterface			
Note	<p>Defines the mapping of two particular VariableDataPrototypes, ParameterDataPrototypes or ArgumentDataPrototypes with unequal names and/or unequal semantic (resolution or range) in context of two different SenderReceiverInterface, NvDataInterface or ParameterInterface or Operations.</p> <p>If the semantic is unequal following rules apply: The textTableMapping is only applicable if the referred DataPrototypes are typed by AutosarDataType referring to CompuMethods of category TEXTTABLE, SCALE_LINEAR_AND_TEXTTABLE or BITFIELD_TEXTTABLE.</p> <p>In the case that the DataPrototypes are typed by AutosarDataType either referring to CompuMethods of category LINEAR, IDENTICAL or referring to no CompuMethod (which is similar as IDENTICAL) the linear conversion factor is calculated out of the factorSiToUnit and offsetSiToUnit attributes of the referred Units and the CompuRationalCoeffs of a compuInternalToPhys of the referred CompuMethods.</p>			
Base	ARObject			
Attribute	Type	Mult.	Kind	Note
firstDataPrototype	AutosarDataPrototype	1	ref	First to be mapped DataPrototype in context of a SenderReceiverInterface, NvDataInterface, ParameterInterface or Operation.
firstToSecondDataTransformation	DataTransformation	0..1	ref	<p>This reference defines the need to execute the Data Transformation <Mip>_<transformerId> functions of the transformation chain when communicating from the DataPrototypeMapping.firstDataPrototype to the DataPrototypeMapping.secondDataPrototype.</p> <p>This reference also specifies the reverse Data Transformation <Mip>_Inv_<transformerId> functions of the transformation chain (i.e. from the DataPrototypeMapping.secondDataPrototype to the DataPrototypeMapping.firstDataPrototype) if the referenced DataTransformation is symmetric, i.e. attribute DataTransformation.dataTransformationKind is set to symmetric.</p>
secondDataPrototype	AutosarDataPrototype	1	ref	Second to be mapped DataPrototype in context of a SenderReceiverInterface, NvDataInterface, ParameterInterface or Operation.
secondToFirstDataTransformation	DataTransformation	0..1	ref	This defines the need to execute the reverse Data Transformation <Mip>_Inv_<transformerId> functions of the transformation chain when communicating from the DataPrototypeMapping.secondDataPrototype to the DataPrototypeMapping.firstDataPrototype.
subElementMapping	SubElementMapping	*	aggr	This represents the owned SubelementMapping.
textTableMapping	TextTableMapping	0..2	aggr	Applied TextTableMapping(s)

Table 4.25: DataPrototypeMapping

4.3.1.2 Mapping of Client Server Interface Elements

[TPS_SWCT_01105] [ClientServerInterfaceMapping](#) [The [ClientServerInterfaceMapping](#) defines the correlation of [ClientServerOperations](#) defined in the context of two [ClientServerInterfaces](#).] ([RS_SWCT_03155](#), [RS_SWCT_03210](#))

[constr_1237] Scope of mapped [ClientServerOperations](#) in the context of a [ClientServerOperationMapping](#) [All [ClientServerOperations](#) referenced

by a `ClientServerOperationMapping` in the role `firstOperation` shall belong to exactly one `ClientServerInterface`.

All `ClientServerOperations` referenced by a `ClientServerOperationMapping` in the role `secondOperation` shall belong to exactly one other `ClientServerInterface`.]()

[constr_1238] Scope of mapped `ApplicationErrors` in the context of a `ClientServerOperationMapping` [All `ApplicationErrors` referenced by a `ClientServerApplicationErrorMapping` in the role `firstApplicationError` shall belong to exactly one `ClientServerInterface`.

All `ApplicationErrors` referenced by a `ClientServerApplicationErrorMapping` in the role `secondApplicationError` shall belong to exactly one other `ClientServerInterface`.]()

[constr_1041] Conversion of `ClientServerInterfaces` [Either the `AutosarDataTypes` of the referred `ArgumentDataPrototypes` are compatible or a conversion of the data is available.]()

The compatibility of `AutosarDataTypes` is described in section 6.2. A description of the conversion of data can be found in section 4.3.2.

[constr_1240] Consistency of `ArgumentDataPrototypes` within the context of a `ClientServerOperationMapping` [Unless a `ClientServerOperationMapping.firstToSecondDataTransformation` exists, for each `argument` owned by a `ClientServerOperationMapping.firstOperation` and `ClientServerOperationMapping.secondOperation` a reference in the role `ClientServerOperationMapping.argumentMapping.firstDataPrototype` or `ClientServerOperationMapping.argumentMapping.secondDataPrototype` shall exist originated by one of the `ClientServerOperationMapping.argumentMappings` owned by the mentioned `ClientServerOperationMapping`.]()

[constr_1268] `ArgumentDataPrototype.direction` shall be preserved in a `ClientServerOperationMapping` [Within the context of a `ClientServerOperationMapping`, the value of the argument `ArgumentDataPrototype.direction` of two mapped `ArgumentDataPrototype` shall be identical.]()

[constr_1269] Number of `arguments` shall be preserved in a `ClientServerOperationMapping` [Within the context of a `ClientServerOperationMapping`, the number of `arguments` of `firstOperation` and `secondOperation` shall be identical.]()

[constr_1270] `ArgumentDataPrototype` shall be mapped only once in a `ClientServerOperationMapping` [Within the context of a `ClientServerOperationMapping`, each `argument` shall only be referenced **once** in the role `firstDataPrototype` or `secondDataPrototype`.]()

[constr_1469] Applicability of constraints depending on the existence of a data transformation [[constr_1269], [constr_1270], [constr_1268], and [constr_1240] shall **not** apply under the following conditions:

- A reference from the respective `ClientServerOperationMapping` to a `DataTransformation` in the role `firstToSecondDataTransformation` exists.
- The value of the attribute `dataTransformationKind` of the referenced `DataTransformation` is set to `DataTransformationKindEnum.asymmetricFromByteArray` or `DataTransformationKindEnum.asymmetricToByteArray`.

]0

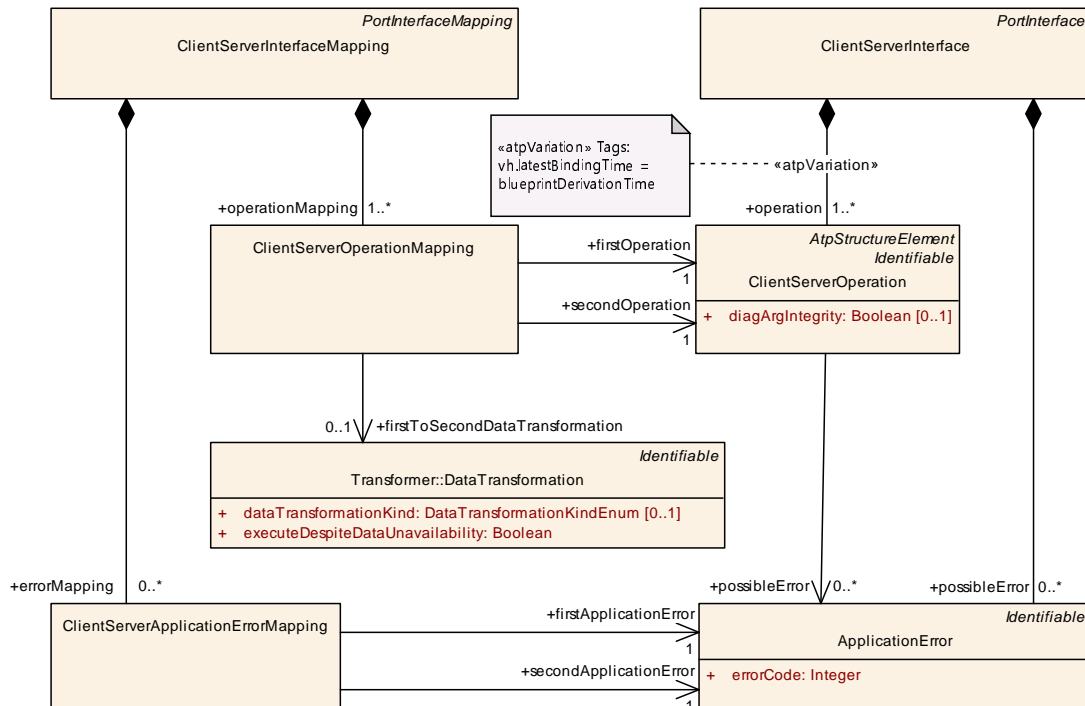

Figure 4.10: Mapping of `ClientServerInterface` elements and mapping of arguments

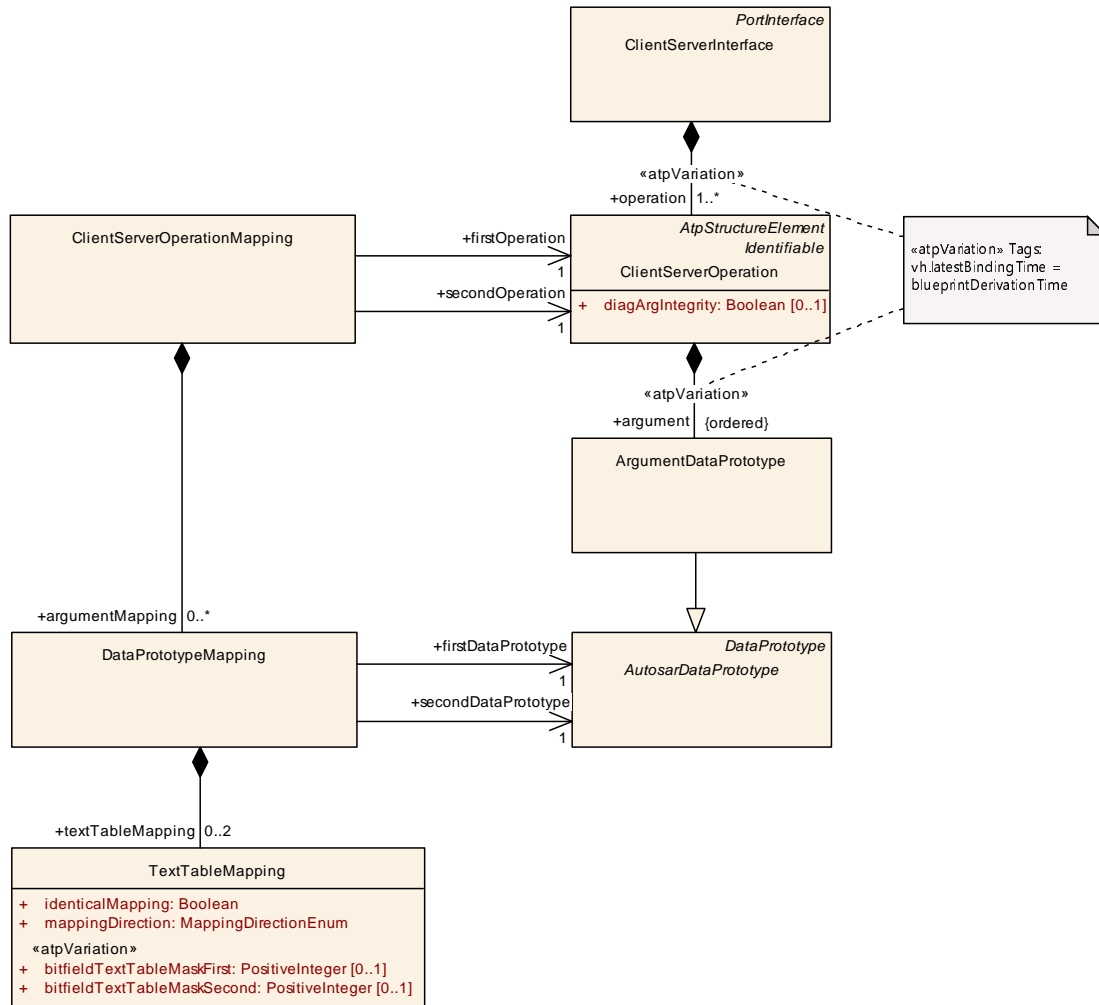

Figure 4.11: Mapping of **ArgumentDataPrototypes**

Class	ClientServerInterfaceMapping			
Package	M2::AUTOSARTemplates::SWComponentTemplate::PortInterface			
Note	Defines the mapping of ClientServerOperations in context of two different ClientServerInterfaces.			
Base	ARObject, AtpBlueprint, AtpBlueprintable, Identifiable, MultilanguageReferrable, PortInterfaceMapping, Referrable			
Attribute	Type	Mult.	Kind	Note
errorMapping	ClientServerApplicationErrorMapping	*	aggr	Map two different ApplicationErrors defined in the context of two different ClientServerInterfaces.
operationMapping	ClientServerOperationMapping	1..*	aggr	Mapping of two ClientServerOperations in two different ClientServerInterfaces

Table 4.26: ClientServerInterfaceMapping

Class	ClientServerOperationMapping			
Package	M2::AUTOSARTemplates::SWComponentTemplate::PortInterface			
Note	Defines the mapping of two particular ClientServerOperations in context of two different ClientServer Interfaces.			
Base	ARObject			
Attribute	Type	Mult.	Kind	Note
argument Mapping	DataPrototypeMapping	*	aggr	Defines the mapping of two particular ArgumentData Prototypes with unequal names or unequal semantic (resolution or range) in context of Operations.
firstOperation	ClientServerOperation	1	ref	First to-be-mapped ClientServerOperation of a Client ServerInterface.
firstToSecond Data Transformation	DataTransformation	0..1	ref	This reference indicates that a DataTransformation is intended in the context of the ClientServerOperation Mapping.
second Operation	ClientServerOperation	1	ref	Second to-be-mapped ClientServerOperation of a Client ServerInterface.

Table 4.27: ClientServerOperationMapping

Class	ClientServerApplicationErrorMapping			
Package	M2::AUTOSARTemplates::SWComponentTemplate::PortInterface			
Note	This meta-class represents the ability to map ApplicationErrors onto each other.			
Base	ARObject			
Attribute	Type	Mult.	Kind	Note
firstApplication Error	ApplicationError	1	ref	This represents the first ApplicationError in the context of the ClientServerApplicationErrorMapping.
second ApplicationError	ApplicationError	1	ref	This represents the second ApplicationError in the context of the ClientServerApplicationErrorMapping.

Table 4.28: ClientServerApplicationErrorMapping

4.3.1.3 Mapping of Mode Interface Elements

[TPS_SWCT_01160] [ModeInterfaceMapping](#) [The [ModeInterfaceMapping](#) defines the correlation of [ModeDeclarationGroupPrototypes](#) defined in the context of [ModeSwitchInterfaces](#).] ([RS_SWCT_03210](#))

[TPS_SWCT_01167] **Validity of [ModeInterfaceMapping](#)** [The mapping of [ModeDeclarationGroupPrototypes](#) is only valid if these are typed by (read “refer to”) compatible [ModeDeclarationGroups](#).] ([RS_SWCT_03210](#))

The compatibility of [ModeDeclarationGroups](#) is described in chapter 6.7.

Class	ModelInterfaceMapping			
Package	M2::AUTOSARTemplates::SWComponentTemplate::PortInterface			
Note	Defines the mapping of ModeDeclarationGroupPrototypes in context of two different ModelInterfaces.			
Base	<i>ARObject, AtpBlueprint, AtpBlueprintable, Identifiable, MultilanguageReferrable, PortInterfaceMapping, Referrable</i>			
Attribute	Type	Mult.	Kind	Note
modeMapping	ModeDeclarationGroupPrototypeMapping	1	aggr	Mapping of two ModeDeclarationGroupPrototypes in two different ModelInterfaces

Table 4.29: ModelInterfaceMapping

Class	ModeDeclarationGroupPrototypeMapping			
Package	M2::AUTOSARTemplates::CommonStructure::ModeDeclaration			
Note	Defines the mapping of two particular ModeDeclarationGroupPrototypes (in the given context) that are unequally named and/or require a reference to a ModeDeclarationMappingSet in order to become compatible by definition of ModeDeclarationMappings.			
Base	<i>ARObject</i>			
Attribute	Type	Mult.	Kind	Note
firstModeGroup	ModeDeclarationGroupPrototype	1	ref	ModeDeclarationGroupPrototype to be mapped.
mode Declaration MappingSet	ModeDeclarationMappingSet	0..1	ref	This represents the available mappings of Mode Declarations in the context of this ModeDeclarationGroup Prototype.
secondMode Group	ModeDeclarationGroupPrototype	1	ref	ModeDeclarationGroupPrototype to be mapped.

Table 4.30: ModeDeclarationGroupPrototypeMapping

[TPS_SWCT_01449] **Semantics of a [ModeDeclarationGroupPrototypeMapping](#)** [A [ModeDeclarationGroupPrototypeMapping](#) shall be used to identify two [ModeDeclarationGroups](#) that afterwards shall be considered compatible. This also applies if the two [ModeDeclarationGroups](#) deviate with respect to the contained [modeTransitions](#).] ([RS_SWCT_03210](#))

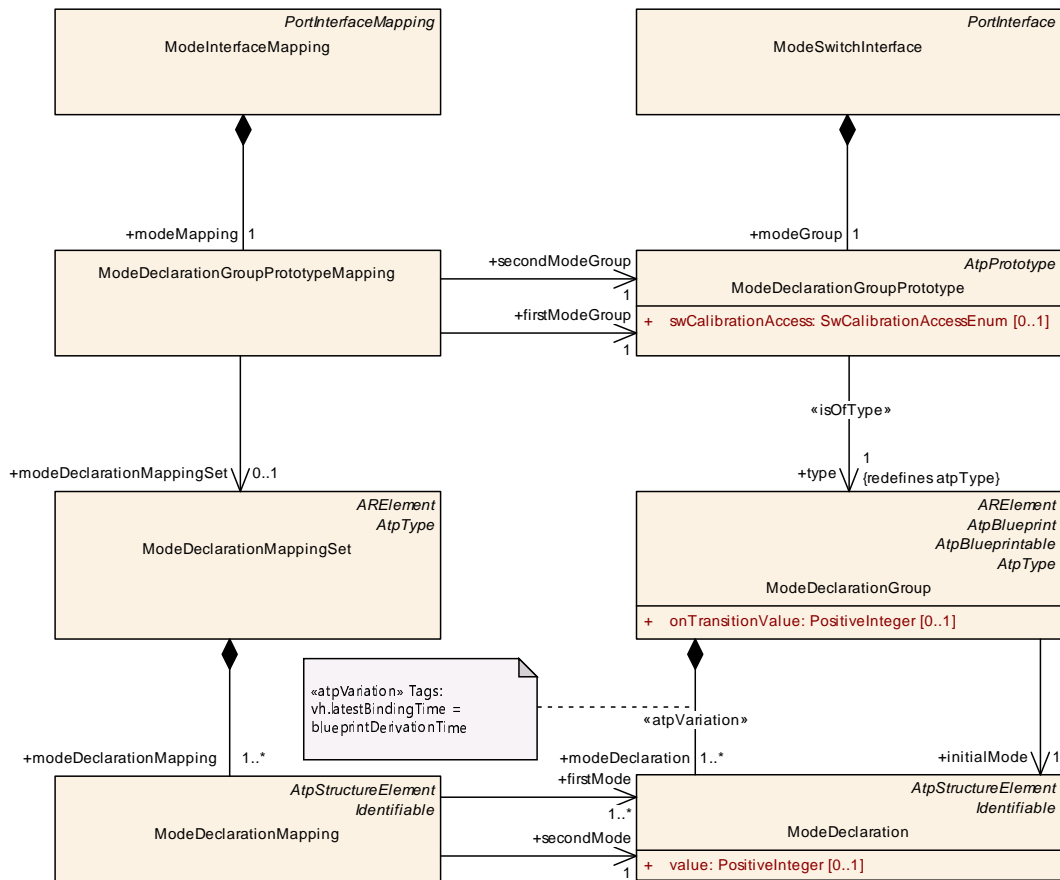

Figure 4.12: Mapping of **ModeSwitchInterface** elements

[constr_1246] Consistency of **firstMode** and **secondMode** in the scope of one **ModeDeclarationMappingSet** [Within the scope of one **ModeDeclarationMappingSet**, all **firstModes** shall belong to one and only one **ModeDeclarationGroup** and all **secondModes** shall belong to one and only one **other ModeDeclarationGroup**.]()

[constr_1247] Consistency of **ModeDeclarationMappingSet** with respect to the referenced **firstModeGroup** and **secondModeGroup** [If a **ModeDeclarationGroupPrototypeMapping.modeDeclarationMappingSet** exists, the **ModeDeclarationGroup** owning the **modeDeclarations** referenced in the role **firstMode** shall be the **type** of the **ModeDeclarationGroupPrototypeMapping.firstModeGroup** and the **ModeDeclarationGroup** owning the **modeDeclarations** referenced in the role **secondMode** shall be the **type** of the **ModeDeclarationGroupPrototypeMapping.secondModeGroup**.]()

[TPS_SWCT_01462] **ModeDeclarationMapping** defines the explicit correlation of **ModeDeclarations** [The meta-class **ModeDeclarationMapping** defines the explicit correlation of **ModeDeclarations** defined in the context of two **ModeDeclarationGroups**.]()

[TPS_SWCT_01463] **ModeDeclarationGroupPrototypeMapping.modeDeclarationMappingSet** defines the applicable set of **ModeDeclarationMappings**

[The attribute `ModeDeclarationGroupPrototypeMapping.modeDeclarationMappingSet` defines the applicable set of `ModeDeclarationMappings` for the connection of `ModeDeclarationGroupPrototypes` typed by `ModeDeclarationGroups` with differently named `ModeDeclarations` and/or with a different number of `ModeDeclarations`.]()

Class	ModeDeclarationMappingSet			
Package	M2::AUTOSARTemplates::SWComponentTemplate::PortInterface			
Note	This meta-class implements a container for ModeDeclarationGroupMappings Tags: atp.recommendedPackage=PortInterfaceMappingSets			
Base	ARElement , ARObject , AtpClassifier , AtpType , CollectableElement , Identifiable , MultilanguageReferrable , PackageableElement , Referrable			
Attribute	Type	Mult.	Kind	Note
mode Declaration Mapping	ModeDeclarationMapping	1..*	aggr	This represents the collection of ModeDeclaration Mappings owned by the enclosing ModeDeclaration MappingSet.

Table 4.31: ModeDeclarationMappingSet

Class	ModeDeclarationMapping			
Package	M2::AUTOSARTemplates::SWComponentTemplate::PortInterface			
Note	This meta-class implements a concrete mapping of two ModeDeclarations.			
Base	ARObject , AtpClassifier , AtpFeature , AtpStructureElement , Identifiable , MultilanguageReferrable , Referrable			
Attribute	Type	Mult.	Kind	Note
firstMode	ModeDeclaration	1..*	ref	This represents the first ModeDeclaration of the Mode DeclarationMapping. This reference has the multiplicity 1 .. * to support use cases where e.g. one mode of the mode user is mapped to several modes of the mode manager.
secondMode	ModeDeclaration	1	ref	This represents the second ModeDeclaration of the Mode DeclarationMapping.

Table 4.32: ModeDeclarationMapping

[TPS_SWCT_01464] ModeDeclaration of a mode user is mapped to exactly one ModeDeclaration of a mode manager [The mode that corresponds to the `ModeDeclaration` of the Mode User is entered or exited when the mode of the mode manager that corresponds to the mapped (i.e. referenced by the same `ModeDeclarationMapping`) `ModeDeclaration` of the mode manager is entered or exited.] ([RS_SWCT_03115](#))

[TPS_SWCT_01465] ModeDeclaration of a mode user is mapped to several ModeDeclarations of a mode manager [The mode that corresponds to the mapped `ModeDeclaration` of the mode user is entered when any of the modes of the Mode Manager that correspond to `ModeDeclarations` referenced by the applicable `ModeDeclarationMapping` is entered.]

The mode that corresponds to the mapped `ModeDeclaration` of the mode user is exited when any of the modes of the Mode Manager that correspond to `ModeDeclarations` referenced by the applicable `ModeDeclarationMapping` is exited if the new mode is not mapped to related mode of the mode user. *(RS_SWCT_03115)*

Please note if one `ModeDeclaration` of a mode user is mapped to **several** `ModeDeclarations` of a mode manager by means of several `ModeDeclarationMappings` the intended semantics is defined in a way that the individual mode transitions of the mode manager are representing “exit” and “enter” events for the Mode User. In other words, the individual transitions are recognizable by the mode user.

If one `ModeDeclaration` of a mode user is (by utilizing the multiplicity of the role `firstMode`) mapped to several `ModeDeclarations` of a mode manager in the context of a single `ModeDeclarationMapping`, the semantics is defined in a way that the individual mode transitions of the Mode Manager are not recognizable to the Mode User.

[constr_1209] Mapping of `ModeDeclarations` of mode user to `ModeDeclaration` of mode manager [A configuration that maps **several** `ModeDeclarations` representing modes of a mode user to **one** `ModeDeclaration` representing a mode of a mode manager shall be rejected.]()

[constr_1210] Mapping of `ModeDeclarations` of mode user to all `ModeDeclarations` of mode manager [If a `ModeDeclarationMapping` exists that references a `ModeDeclaration` representing a mode of the mode manager then `ModeDeclarationMappings` shall exist that map all modes of the mode manager to modes of the mode user.]()

Please note that [\[constr_1210\]](#) prevents the existence of configurations where the mode user is not in a defined mode when no transition is ongoing.

[TPS_SWCT_01545] `ModeDeclaration` of a *mode user* that is not mapped to a `ModeDeclaration` of a *mode manager* [A `ModeDeclaration` of a *mode user* that is not mapped to a `ModeDeclaration` of a *mode manager* represents a valid model. In this case the related mode is never entered nor exit during runtime of the ECU.] *(RS_SWCT_03115)*

4.3.1.4 Mapping of Trigger Interface Elements

[TPS_SWCT_01161] `TriggerInterfaceMapping` [The `TriggerInterfaceMapping` defines the correlation of `Triggers` defined in the context `TriggerInterfaces`.] *(RS_SWCT_03210)*

Class	TriggerInterfaceMapping			
Package	M2::AUTOSARTemplates::SWComponentTemplate::PortInterface			
Note	Defines the mapping of unequal named Triggers in context of two different TriggerInterfaces.			
Base	<i>ARObject</i> , <i>AtpBlueprint</i> , <i>AtpBlueprintable</i> , <i>Identifiable</i> , <i>MultilanguageReferrable</i> , <i>PortInterfaceMapping</i> , <i>Referrable</i>			
Attribute	Type	Mult.	Kind	Note
triggerMapping	TriggerMapping	1..*	aggr	Mapping of two Trigger in two different TriggerInterface

Table 4.33: TriggerInterfaceMapping

Class	TriggerMapping			
Package	M2::AUTOSARTemplates::CommonStructure::TriggerDeclaration			
Note	Defines the mapping of two particular unequally named Triggers in the given context.			
Base	<i>ARObject</i>			
Attribute	Type	Mult.	Kind	Note
firstTrigger	Trigger	1	ref	A Trigger to be mapped.
secondTrigger	Trigger	1	ref	A Trigger to be mapped.

Table 4.34: TriggerMapping

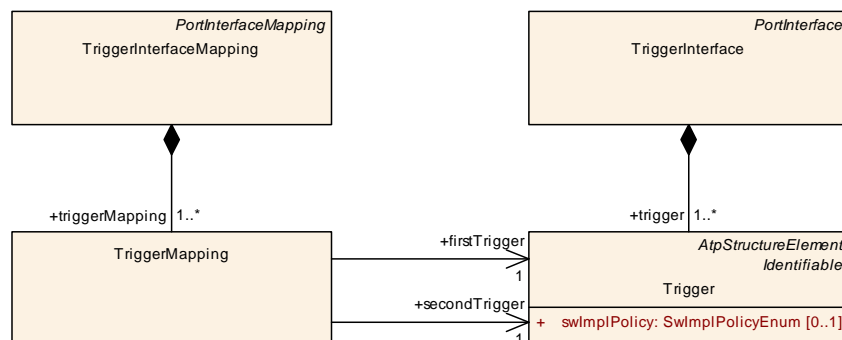

Figure 4.13: Mapping of [TriggerInterface](#) elements

4.3.1.5 Mapping of Elements of a composite Data Type

The mapping of elements of [PortInterfaces](#) is not limited to mapping entire [DataPrototypes](#) onto each other.

[TPS_SWCT_01023] Mapping of elements of composite data types [For applications of [DataInterfaces](#) it is also possible to formally describe the mapping of elements of [ApplicationCompositeDataTypes](#) or [ImplementationDataTypes](#) of category [STRUCTURE](#) or [ARRAY](#) onto each other.] ([RS_SWCT_03210](#), [RS_SWCT_03135](#))

This ability can be used if e.g. [dataElements](#) on the sender and receiver side are typed by different [ApplicationRecordDataTypes](#).

In this case the mapping of elements of `ApplicationCompositeDataTypes` or `ImplementationDataTypes` of category `STRUCTURE` or `ARRAY` onto each other allows for the definition of specific pairs of elements that fulfill the compatibility rules.

[TPS_SWCT_01551] Mapping of elements on the sender side to elements on the receiver side [Unless the attribute `swImplPolicy` is set to `queued`, it is not required that all elements on the sender side need to be mapped to elements on the receiver side to achieve compatibility.] (*RS_SWCT_03210, RS_SWCT_03135*)

The details regarding the compatibility rules are explained in chapter 6.3.

[constr_1279] Unmapped elements of `ApplicationCompositeDataTypes` or `ImplementationDataTypes` and the attribute `swImplPolicy` [If the attribute `swImplPolicy` is set to `queued` it is not allowed to have unmapped elements of `ApplicationCompositeDataTypes` or `ImplementationDataTypes` of category `STRUCTURE` or `ARRAY` on the receiver side.]()

[constr_1280] Unmapped `dataElement` on the receiver side shall have an `initValue` [If elements of `ApplicationCompositeDataTypes` or `ImplementationDataTypes` of category `STRUCTURE` or `ARRAY` are not considered in a `SubElementMapping` then the enclosing `dataElement` shall have an `initValue` if the `NonqueuedReceiverComSpec` is aggregated by an `AbstractRequiredPortPrototype`.]()

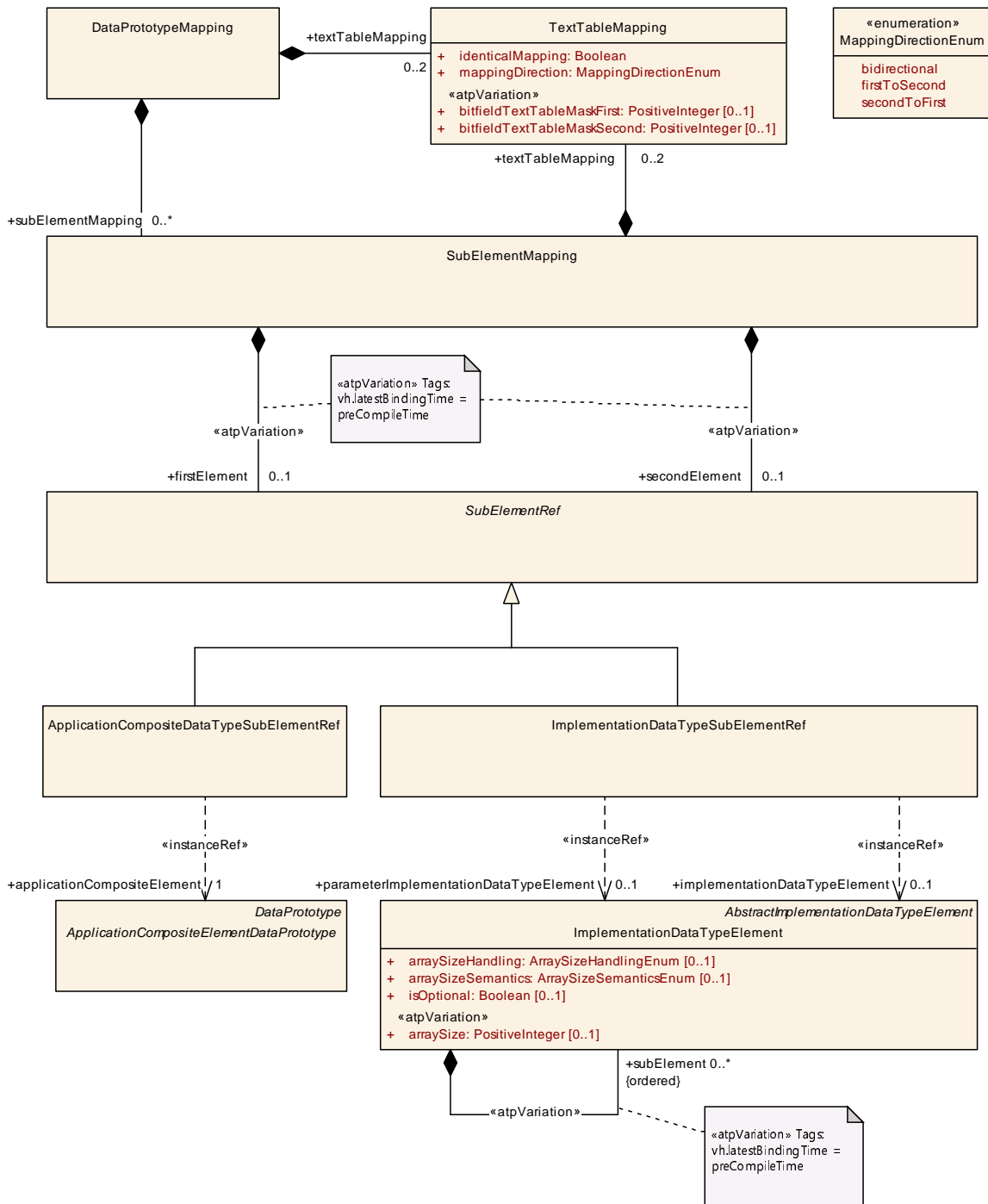

Figure 4.14: Mapping of elements of composite data types

[TPS_SWCT_01024] **Combination of `ApplicationCompositeDataType` and nested `ImplementationDataType`** [The mapping of elements of `ApplicationCompositeDataTypes` or `ImplementationDataTypes` of category `STRUCTURE` or `ARRAY` works for both `ApplicationCompositeDataType` and nested `ImplementationDataTypes` and even for combinations of them, i.e. one `PortInterface` may use an `ApplicationCompositeDataType` while the other `PortInterface` uses a nested `ImplementationDataType`.] ([RS_SWCT_03210](#), [RS_SWCT_03135](#))

[TPS_SWCT_01195] Mapping of composite element to primitive `DataPrototype`

[It is also possible to map an element of a composite data type on the provided side to a primitive `DataPrototype` on the required side. For this purpose the multiplicity of the `firstElement` shall be set to 1 and the multiplicity of the `secondElement` shall be set to 0.](*RS_SWCT_03136*)

In general, the multiplicity of the `firstElement` can technically also be set to 0 but this case is reserved for future use.

[constr_1190] Only one mapping for composite to primitive use case [In the case described by [TPS_SWCT_01195] only one `subElementMapping` shall exist at the enclosing `DataPrototypeMapping`.]()

[constr_1300] Primitive `DataPrototype` on the provider side shall not be mapped to element of a composite data type on the requester side [The usage of `DataPrototypeMapping` or `SubElementMapping` does not support the following configuration:

- The `AutosarDataPrototype` referenced on the provider/client side is typed by an `ApplicationPrimitiveDataType` of category `VALUE` or `ImplementationDataType` of category `VALUE` or category `TYPE_REFERENCE` that eventually resolves to category `VALUE`.
- The `DataPrototypeMapping` aggregates a `subElementMapping` that refers to a `ImplementationDataTypeElement` or `ApplicationCompositeElementDataPrototype` on the requester/server side.

]()

[constr_1611] Existence of `ImplementationDataTypeSubElementRef.implementationDataTypeElement` as opposed to `ImplementationDataTypeSubElementRef.parameterImplementationDataTypeElement` [For any given `ImplementationDataTypeSubElementRef`, either the aggregation

- `ImplementationDataTypeSubElementRef.implementationDataTypeElement` or
- `ImplementationDataTypeSubElementRef.parameterImplementationDataTypeElement`

shall exist.]()

In other words, the `ImplementationDataTypeSubElementRef` shall **either** refer to the nested hierarchy inside a `VariableDataPrototype` **or** a `ParameterDataPrototype`.

Class	SubElementMapping			
Package	M2::AUTOSARTemplates::SWComponentTemplate::PortInterface			
Note	This meta-class allows for the definition of mappings of elements of a composite data type.			
Base	<i>ARObject</i>			
Attribute	Type	Mult.	Kind	Note
firstElement	SubElementRef	0..1	aggr	This represents the first element referenced in the scope of the mapping. Stereotypes: atpVariation Tags: vh.latestBindingTime=preCompileTime
secondElement	SubElementRef	0..1	aggr	This represents the second element referenced in the scope of the mapping. Stereotypes: atpVariation Tags: vh.latestBindingTime=preCompileTime
textTable Mapping	TextTableMapping	0..2	aggr	This allows for the text-table translation of individual elements of a composite data type.

Table 4.35: SubElementMapping

Class	SubElementRef (abstract)			
Package	M2::AUTOSARTemplates::SWComponentTemplate::PortInterface			
Note	This meta-class provides the ability to reference elements of composite data type.			
Base	<i>ARObject</i>			
Subclasses	ApplicationCompositeDataTypeSubElementRef , ImplementationDataTypeSubElementRef			
Attribute	Type	Mult.	Kind	Note
–	–	–	–	–

Table 4.36: SubElementRef

Class	ImplementationDataTypeSubElementRef			
Package	M2::AUTOSARTemplates::SWComponentTemplate::PortInterface			
Note	This meta-class represents the specialization of SubElementMapping with respect to Implementation Data Types.			
Base	<i>ARObject</i> , SubElementRef			
Attribute	Type	Mult.	Kind	Note
implementation DataType Element	ArVariableInImplementationDataInstanceRef	0..1	aggr	This represents the referenced implementationDataType Element.
parameter Implementation DataType Element	ArParameterInImplementationDataInstanceRef	0..1	aggr	This represents the referenced ImplementationDataType Element.

Table 4.37: ImplementationDataTypeSubElementRef

This implies that the `rootDataPrototype` shall be a `ParameterDataPrototype` if the `base` is a `ParameterInterface`. Otherwise, the `rootDataPrototype` shall be a `VariableDataPrototype`.]()

[constr_1185] Consistency of data types in the context of `ApplicationCompositeElementInPortInterfaceInstanceRef` [The definition of attributes `contextDataPrototype` and `targetDataPrototype` shall (via the type-prototype pattern) be enclosed in the context of the definition of the data type used to type `rootDataPrototype`.]()

In other words, it shall be possible to reach `contextDataPrototype` and `targetDataPrototype` by means of the type-prototype chain created by the definition of the data type used to type `rootDataPrototype`. And, as implied by the definition of the `InstanceRef`, the `contextDataPrototypes` shall enclose each other and, eventually, the `targetDataPrototype`.

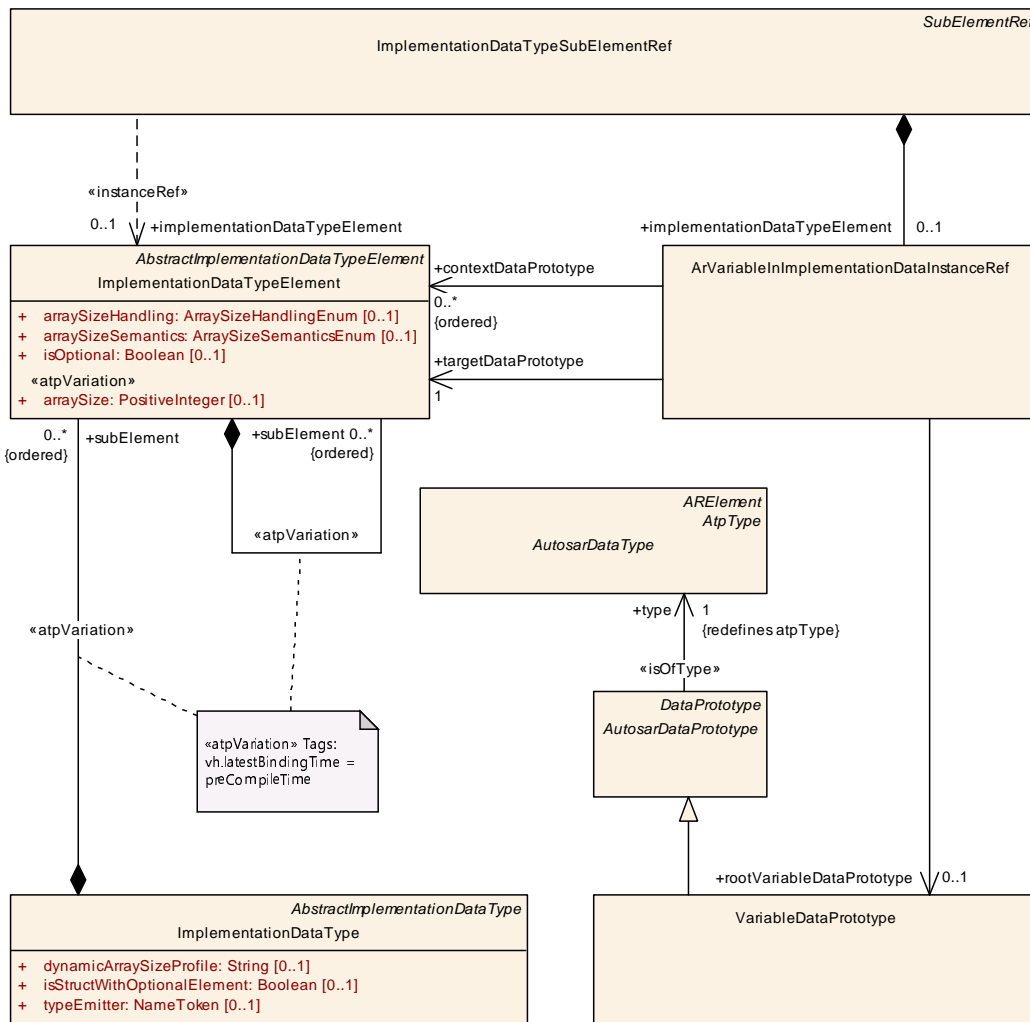

Figure 4.16: Implementation of the InstanceRef for the mapping of elements of a `VariableDataPrototype` typed by a composite implementation data type

[constr_1186] Consistency of data types in the context of **ArVariableInImplementationDataInstanceRef** [The definition of attributes `contextDataPrototype` and `targetDataPrototype` shall be enclosed in the context of the definition of the data type used to type `rootVariableDataPrototype`.]()

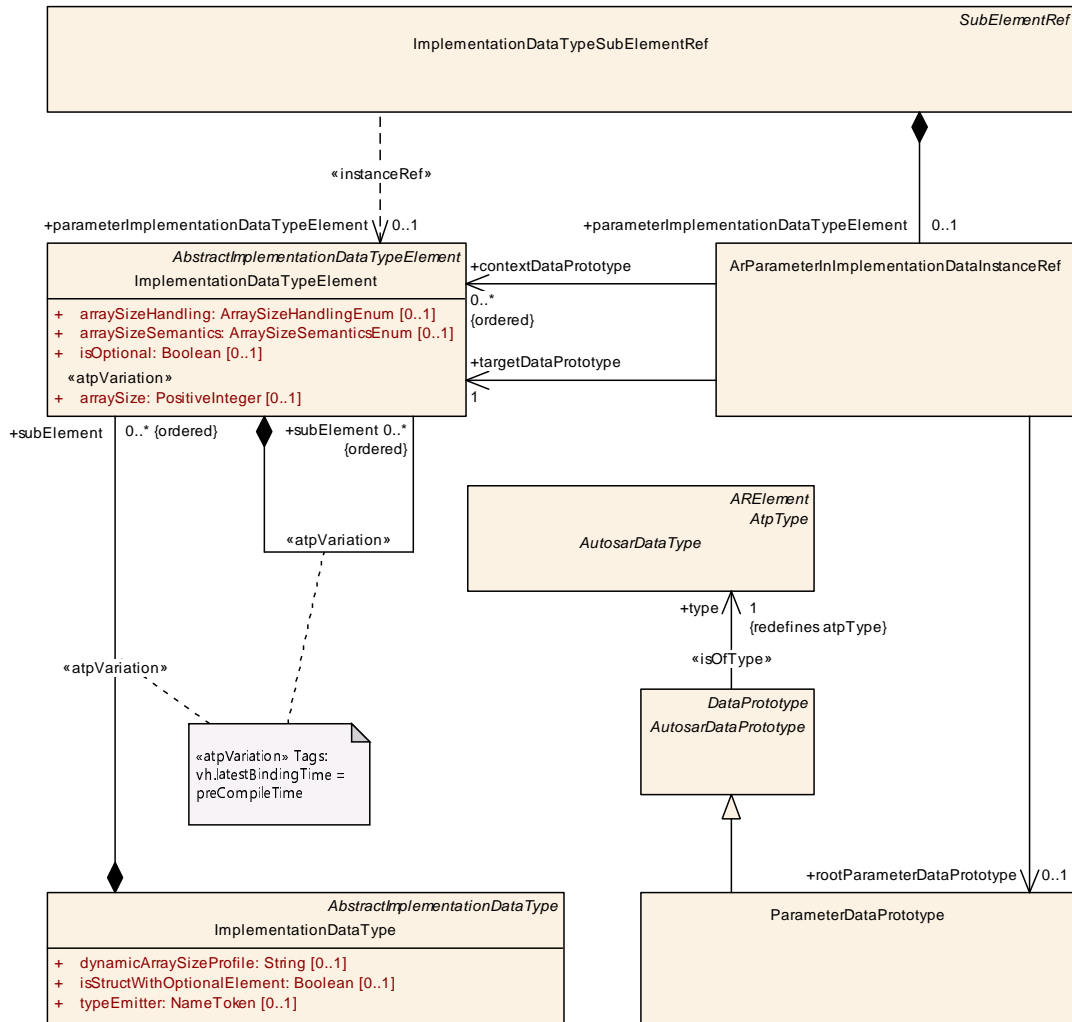

Figure 4.17: Implementation of the InstanceRef for the mapping of elements of a **ParameterDataPrototype** typed by a composite implementation data type

[constr_1518] Consistency of data types in the context of **ArParameterInImplementationDataInstanceRef** [The definition of attributes `contextDataPrototype` and `targetDataPrototype` shall be enclosed in the context of the definition of the data type used to type `rootParameterDataPrototype`.]()

4.3.2 Data Conversion

[TPS_SWCT_01560] Supported **categories** of **CompuMethods** for data conversion [Data conversion shall be supported for `AutosarDataTypes` that refer to `CompuMethods` of `category`

- [LINEAR](#),
- [IDENTICAL](#),
- [SCALE_LINEAR_AND_TEXTTABLE](#),
- [TEXTTABLE](#),
- [BITFIELD_TEXTTABLE](#), and
- [RAT_FUNC](#) - as long as the semantics of the latter comes down to a reciprocal linear data scaling.

]([RS_SWCT_03210](#))

[TPS_SWCT_01561] Application of data conversion to composite [Autosar-DataTypes](#) [Data conversion is also applicable for composite [AutosarDataTypes](#). The actual conversion, however, shall be individually applied to each leaf element of a given composite [AutosarDataType](#).]([RS_SWCT_03210](#))

4.3.2.1 Linear Data Scaling

A *Linear Data Scaling* can be defined under following preconditions:

[TPS_SWCT_01549] Definition of linear data scaling [The term `Linear Scaling` is defined as follows:

1. Regarding the existence of `CompuMethods` one of the following cases shall apply:
 - (a) The involved `AutosarDataTypes` refer to `CompuMethods` of category `IDENTICAL`, `LINEAR`, or `RAT_FUNC`.
 - (b) If one side (sender or receiver) does not refer to a `CompuMethod` then a “default” `CompuMethod` of category `IDENTICAL` shall be assumed.
2. Regarding the existence of `Units` one of the following cases shall apply:
 - (a) The `CompuMethods` refer either to compatible `Units` or to `Units` that in turn refer to compatible definitions of `PhysicalDimension`.
 - (b) `Units` and `PhysicalDimensions` do partially not exist on one side:
 - If one side (sender or receiver) does not refer to a `Unit`, then an “imaginary” `Unit` with the properties defined in [\[TPS_SWCT_01492\]](#) shall be assumed.
 - if the `PhysicalDimension` is only defined on one side (sender or receiver) then it shall be considered as default for the other side.

3. Both `CompuMethods` fulfill the following condition:

$$Int = \frac{N_0 * phys^0 + N_1 * phys^1 + N_2 * phys^2 + \dots + N_i * phys^i}{D_0 * phys^0 + D_1 * phys^1 + D_2 * phys^2 + \dots + D_i * phys^i}$$

with

- $N_2=N_3=\dots=N_i=0$
- $D_1=D_2=\dots=D_i=0$
- $N_1 \neq 0$
- $D_0 \neq 0$

The coefficient N_0 represents the offset and can take any value.

]([RS_SWCT_03210](#))

[TPS_SWCT_01550] Definition of reciprocal linear data scaling [The term Reciprocal Linear Scaling is defined as follows:

1. The involved `AutosarDataTypes` refer to `CompuMethods` of category `RAT_FUNC`.
2. The `CompuMethods` refer either to compatible `Units` or to `Units` that in turn refer to compatible definitions of `PhysicalDimension`.
3. Both `CompuMethods` fulfill the following condition:

$$Int = \frac{N_0 * phys^0 + N_1 * phys^1 + N_2 * phys^2 + \dots + N_i * phys^i}{D_0 * phys^0 + D_1 * phys^1 + D_2 * phys^2 + \dots + D_i * phys^i}$$

with

- $N_1=N_2=\dots=N_i=0$
- $D_2=D_3=\dots=D_i=0$
- $N_0 \neq 0$
- $D_1 \neq 0$

The coefficient D_0 represents the (reciprocal) offset and can take any value.

]([RS_SWCT_03210](#))

[TPS_SWCT_01168] Linear conversion factor can be calculated [In such cases a linear conversion factor can be calculated out of the `factorSiToUnit` and `offsetSiToUnit` attributes of the referred `Units` and the `CompuRationalCoeffs` of a `compuInternalToPhys/compuPhysToInternal` of the referred `CompuMethods`.]

([RS_SWCT_03210](#))

4.3.2.2 Table Conversion

[TPS_SWCT_01162] Existence of `TextTableMapping` [A `TextTableMapping` can be defined if the `AutosarDataTypes` refer to `CompuMethods` of `category` `TEXTTABLE`, `SCALE_LINEAR_AND_TEXTTABLE`, and `BITFIELD_TEXTTABLE`.] (*RS_SWCT_03210*)

Please note that the use case behind the appearance of `BITFIELD_TEXTTABLE` in [TPS_SWCT_01162] is the fact that BSW modules such as the `Dem` need to put data into the `NVRAM` that has the nature of single bits embedded into a composite data type.

The `TextTableMapping` is defined as a table based conversion.

[TPS_SWCT_01163] Conversion from `firstValue` to `secondValue` [A `firstValue` of a `valuePair` is converted into the `secondValue` in case of a data flow from the `firstDataPrototype` to the `secondDataPrototype`.] (*RS_SWCT_03210*)

[TPS_SWCT_01164] Conversion from `secondValue` to `firstValue` [In case of a data flow from the `secondDataPrototype` to `firstDataPrototype` the `secondValue` is substituted by the `firstValue`.] (*RS_SWCT_03210*)

[TPS_SWCT_01165] Invertible mapping [If the `mappingDirection` attribute is set to `bidirectional` then the `TextTableMapping` has to be invertible. This requires that the list of all `firstValues` and the list of all `secondValues` do not contain identical values inside a list.] (*RS_SWCT_03210*)

[TPS_SWCT_01166] Non-invertible mapping [For non-invertible `TextTableMapping`, a dedicated `TextTableMapping` for each direction can be defined.] (*RS_SWCT_03210*)

[constr_1303] Applicability of `TextTableMapping` depending on the value of `CompuMethod.category` [If a `DataPrototypeMapping` aggregates a `TextTableMapping` then only certain combinations of the value of the applicable `CompuMethod.category` are supported:

- `category` of `firstDataPrototype`: `TEXTTABLE`,
`category` of `secondDataPrototype`: `TEXTTABLE`
- `category` of `firstDataPrototype`: `SCALE_LINEAR_AND_TEXTTABLE`,
`category` of `secondDataPrototype`: `TEXTTABLE`
- `category` of `firstDataPrototype`: `TEXTTABLE`,
`category` of `secondDataPrototype`: `SCALE_LINEAR_AND_TEXTTABLE`
- `category` of `firstDataPrototype`: `BITFIELD_TEXTTABLE`,
`category` of `secondDataPrototype`: `TEXTTABLE`
- `category` of `firstDataPrototype`: `TEXTTABLE`,
`category` of `secondDataPrototype`: `BITFIELD_TEXTTABLE`
- `category` of `firstDataPrototype`: `BITFIELD_TEXTTABLE`,
`category` of `secondDataPrototype`: `BITFIELD_TEXTTABLE`

]()

To some extent, *bitfields* can be regarded as a hybrid between a primitive and a structured data type:

- On the one hand, a *bitfield* is defined in the context of a primitive `ImplementationDataType`.
- On the other hand, by means of the definition of a *mask*, it is possible to define **isolated parts** within the primitive `ImplementationDataType` that potentially can be totally independent of each other with respect to the semantics of the data that match the *mask*.

In other words, the existence of semantically independent and potentially isolated parts within the primitive `ImplementationDataType` creates a **similar characteristic** as if the definitions of the isolated parts were created by means of defining primitive `ImplementationDataTypeElements` within the context of a composite `ImplementationDataType`.

And because it is possible to regard the “mission statement” of a `DataPrototype` that refers to a `CompuMethod` of category `BITFIELD_TEXTTABLE` as to mimic the semantics of a structured data type it is also possible to apply some rules that are already in place for structured data types in this specific case as well.

This conclusion, in combination with the existence of [TPS_SWCT_01551], sets the stage for [TPS_SWCT_01583].

[TPS_SWCT_01583] Completeness of `TextTableMapping` is not a requirement [If a `DataPrototypeMapping` contains one or more `TextTableMapping`(s) where the `DataPrototype` on the **sender side** refers to a `CompuMethod` of category `BITFIELD_TEXTTABLE` it is **not** required that for each possible value and each possible bit mask on the sender side corresponding values on the receiver side are specified.] (*RS_SWCT_03210*)

With respect to [TPS_SWCT_01583] it is still important to observe that within a single mask **all values on the sender side shall have a mapping** to the receiver side.

Otherwise, the RTE generator would not be able to create mapping code that unambiguously takes care of mapping the correct values onto each other.

[constr_1313] Completeness of `TextTableMapping` for the values of a given bit mask on the sender side [If a `DataPrototypeMapping` contains one or more `TextTableMapping`(s) where the `DataPrototype` on the **sender side** refers to a `CompuMethod` of category `BITFIELD_TEXTTABLE` then all `DataPrototypeMapping.textTableMapping` shall aggregate a collection of `TextTableMapping.valuePair` where each possible value of the **sender bit mask**⁶ is represented by exactly one `TextTableValuePair.firstValue` ([TPS_SWCT_01163]) or `TextTableValuePair.secondValue` ([TPS_SWCT_01164]).] ()

⁶Depending on the applicable case this means either `bitfieldTextTableMaskFirst` (applies if [TPS_SWCT_01163] is in place) or `bitfieldTextTableMaskSecond` for the case of [TPS_SWCT_01164].

[constr_1304] Existence of attribute `bitfieldTextTableMaskFirst` [The attribute `bitfieldTextTableMaskFirst` shall be defined **only if** the `firstDataPrototype` of a `DataPrototypeMapping` refers to a `CompuMethod` that has the value of `category` set to `BITFIELD_TEXTTABLE`.]()

[constr_1305] Existence of attribute `bitfieldTextTableMaskSecond` [The attribute `bitfieldTextTableMaskSecond` shall be defined **only if** the `secondDataPrototype` of a `DataPrototypeMapping` refers to a `CompuMethod` that has the value of `category` set to `BITFIELD_TEXTTABLE`.]()

[constr_1306] Limitation of `TextTableMapping` for `CompuMethods` that have the value of `category` set to `BITFIELD_TEXTTABLE` [For any `TextTableMapping` where both `firstDataPrototype` and `secondDataPrototype` refer to `CompuMethods` that have the value of `category` set to `BITFIELD_TEXTTABLE` and where the attribute `TextTableMapping.valuePair` exists the value of attribute `TextTableMapping.identicalMapping` shall be set to `false`.]()

[constr_1307] Consistency of values and masks in `TextTableMapping` [If a `TextTableMapping` element defines bit masks as `bitfieldTextTableMaskFirst` or `bitfieldTextTableMaskSecond` then all contained `TextTableMapping.valuePair.firstValues` as well as all `TextTableMapping.valuePair.secondValues` shall **not** specify a value that would be ruled out when - depending on the given value of `TextTableMapping.mappingDirection` - the relevant bit mask is applied.]()

Example for [constr_1307]: For a bit mask `0b00001000` only the corresponding values 8 and 0 are allowed.

Class	TextTableMapping			
Package	M2::AUTOSARTemplates::SWComponentTemplate::PortInterface			
Note	Defines the mapping of two <code>DataPrototypes</code> typed by <code>AutosarDataTypes</code> that refer to <code>CompuMethods</code> of category <code>TEXTTABLE</code> , <code>SCALE_LINEAR_AND_TEXTTABLE</code> or <code>BITFIELD_TEXTTABLE</code> .			
Base	<i>ARObject</i>			
Attribute	Type	Mult.	Kind	Note
<code>bitfieldTextTableMaskFirst</code>	PositiveInteger	0..1	attr	This attribute can be used to support the mapping of bit field to bit field, boolean values to bit fields, and vice versa. The attribute defines the bit mask for the first element of the <code>TextTableMapping</code> . Stereotypes: <code>atpVariation</code> Tags: <code>vh.latestBindingTime=preCompileTime</code>
<code>bitfieldTextTableMaskSecond</code>	PositiveInteger	0..1	attr	This attribute can be used to support the mapping of bit field to bit field, boolean values to bit fields, and vice versa. The attribute defines the bit mask for the second element of the <code>TextTableMapping</code> . Stereotypes: <code>atpVariation</code> Tags: <code>vh.latestBindingTime=preCompileTime</code>
<code>identicalMapping</code>	Boolean	1	attr	If <code>identicalMapping</code> is set == <code>true</code> the values of the two referenced <code>DataPrototypes</code> do not need any conversion of the values.





Class	TextTableMapping			
mapping Direction	MappingDirectionEnum	1	attr	Specifies the conversion direction for which the TextTable Mapping is applicable.
valuePair	TextTableValuePair	*	aggr	Defines a pair of values which are translated into each other.

Table 4.39: TextTableMapping

Enumeration	MappingDirectionEnum
Package	M2::AUTOSARTemplates::SWComponentTemplate::PortInterface
Note	Specifies the conversion direction for which the mapping is applicable.
Literal	Description
bidirectional	The TextTableMapping is applicable in both directions. Tags: atp.EnumerationLiteralIndex=0
firstToSecond	The TextTableMapping is applicable in the direction from firstDataPrototype / firstOperationArgument referring into the PortInterface of the PPortPrototype to secondDataPrototype / secondOperationArgument referring into the PortInterface of the RPortPrototype. Tags: atp.EnumerationLiteralIndex=1
secondToFirst	The TextTableMapping is applicable in the direction from secondDataPrototype / secondOperationArgument referring into the PortInterface of the PPortPrototype to firstDataPrototype / firstOperationArgument referring into the PortInterface of the RPortPrototype. Tags: atp.EnumerationLiteralIndex=2

Table 4.40: MappingDirectionEnum

Class	TextTableValuePair			
Package	M2::AUTOSARTemplates::SWComponentTemplate::PortInterface			
Note	Defines a pair of text values which are translated into each other.			
Base	ARObject			
Attribute	Type	Mult.	Kind	Note
firstValue	Numerical	1	attr	Value of first DataPrototype provided similar to a numerical ValueSpecification which is intended to be assigned to a Primitive data element. Note that the numerical value is a variant, it can be computed by a formula. Stereotypes: atpVariation Tags: vh.latestBindingTime=preCompileTime
secondValue	Numerical	1	attr	Value of second DataPrototype provided similar to a numerical ValueSpecification which is intended to be assigned to a Primitive data element. Note that the numerical value is a variant, it can be computed by a formula. Stereotypes: atpVariation Tags: vh.latestBindingTime=preCompileTime

Table 4.41: TextTableValuePair

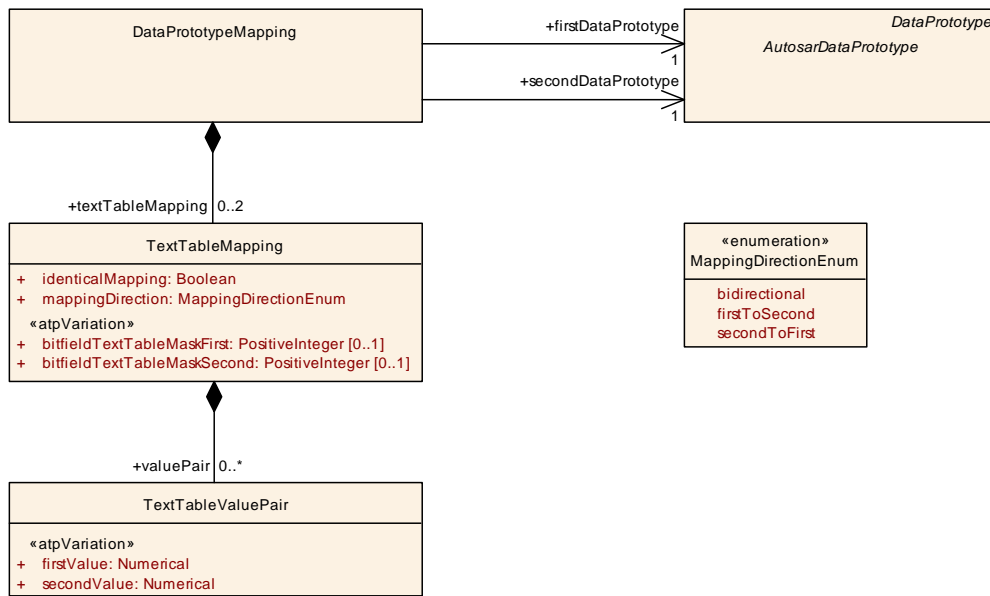

Figure 4.18: Mapping of **DataPrototypes** that eventually refer to **CompuMethods** of category **TEXTTABLE**, **SCALE_LINEAR_AND_TEXTTABLE**, and **BITFIELD_TEXTTABLE**

4.3.3 Relevance for Data Transformation

One (prominent) use-case for item 4 in [TPS_SWCT_01158] is the interaction between the **NvBlockSwComponentType** and the AUTOSAR Dcm.

Specifically, the RTE will call a data transformer to convert the *uint8*-array representation of the diagnostic data available from a **PortPrototype** owned by the Dcm **ServiceSwComponentType** to a **VariableDataPrototype** owned by a **PortPrototype** of **NvBlockSwComponentType**.

For the configuration of this purpose, the applicable **DataPrototypeMapping** refers to a **DataTransformation** in the role **firstToSecondDataTransformation** and - for the case of two connected **PortPrototypes** that use asymmetric data transformation - **secondToFirstDataTransformation** (see Figure 4.19).

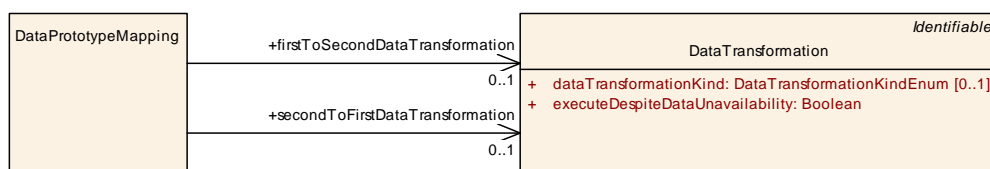

Figure 4.19: Configuration of Ecu-internal data transformation

Note that for this specific interaction between an **ApplicationSwComponentType** and a **ServiceSwComponentType** [TPS_SWCT_01579] applies which defines that attribute **isService** shall be set to **false** for the **dataElements** in **PortPrototypes** typed by a **SenderReceiverInterface**.

[TPS_SWCT_01768] **Semantics of DataPrototypeMapping.secondToFirstDataTransformation** [For symmetric data transformations (i.e. the value of attribute `DataTransformation.dataTransformationKind` is set to `DataTransformationKindEnum.symmetric`) it is sufficient to specify the reference `firstToSecondDataTransformation`.

There are, however, use cases for asymmetric data transformations between two connected `PRPortPrototype`s and in this case it is necessary to specify each direction separately.

For this purpose, the reference `secondToFirstDataTransformation` exists in addition to `firstToSecondDataTransformation`.] (RS_SWCT_03210)

Figure 4.20 describes the most prominent use case for the necessity to specify both `firstToSecondDataTransformation` and `secondToFirstDataTransformation`.

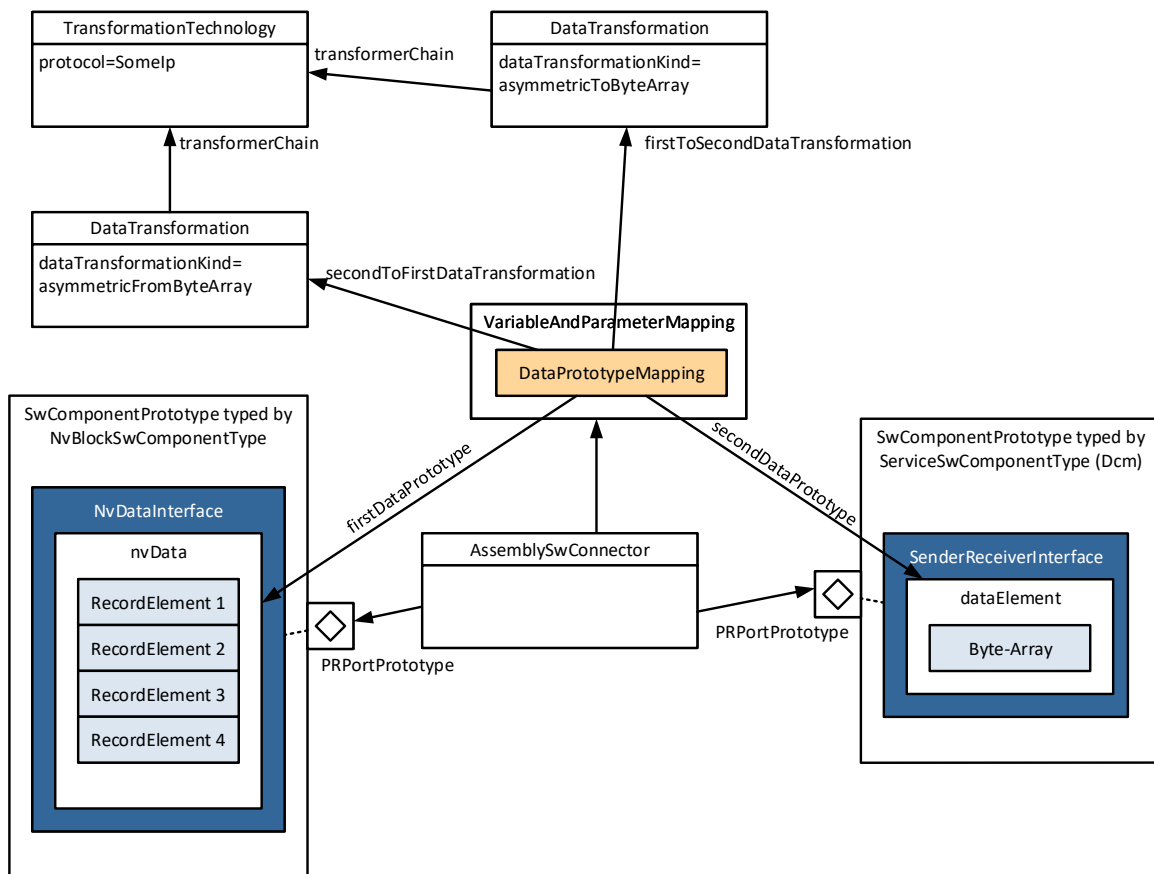

Figure 4.20: Use case for the existence of asymmetric data transformation in both directions

An `SwComponentPrototype` typed by `NvBlockSwComponentType` exposes a `PRPortPrototype` that is connected to another `PRPortPrototype` attached to an `SwComponentPrototype` that represents the Dcm service software-component.

The `PRPortPrototype` on the side of the `NvBlockSwComponentType` is typed by an `NvDataInterface` that in turn aggregates a single `nvData`. The data type used to define the `nvData` is a structured data type.

The service software-component representing the Dcm, however, is not capable of dealing with structured data types. It can only handle primitive types and arrays of primitive types, e.g. bytes.

Therefore, the existence of (asymmetric) data transformers is conveniently utilized to serialize the content of the structured data type into a linear array and vice versa.

To expressly define this intended semantics, the `DataPrototypeMapping` defines two references:

- `firstToSecondDataTransformation` that refers to a `DataTransformation` where attribute `dataTransformationKind` is set to the value `asymmetricToByteArray`. This reference represents the direction from the `NvBlockSwComponentType` to the Dcm.
- `secondToFirstDataTransformation` that refers to a `DataTransformation` where attribute `dataTransformationKind` is set to the value `asymmetricFromByteArray`. This reference represents the direction from the Dcm to the `NvBlockSwComponentType`.

This approach to modeling is formalized in [constr_1631] and [constr_1632].

[constr_1631] Applicability of `DataPrototypeMapping.secondToFirstDataTransformation` [The reference to `DataTransformation` in the role `DataPrototypeMapping.secondToFirstDataTransformation` shall only exist if reference `DataPrototypeMapping.firstToSecondDataTransformation` exists and refers to a `DataTransformation` where attribute `dataTransformationKind` exists and is **not** set to the value `symmetric`.]()

[constr_1632] Restriction for `firstToSecondDataTransformation` and `secondToFirstDataTransformation` [If both the reference `firstToSecondDataTransformation` and the reference `secondToFirstDataTransformation` exist in the context of the same `DataPrototypeMapping` then

- the `firstToSecondDataTransformation` shall refer to a `DataTransformation` with attribute `dataTransformationKind` set to `asymmetricToByteArray` and
- the `secondToFirstDataTransformation` shall refer to a `DataTransformation` with attribute `dataTransformationKind` set to `asymmetricFromByteArray`.

]()

Class	DataTransformation			
Package	M2::AUTOSARTemplates::SystemTemplate::Transformer			
Note	A DataTransformation represents a transformer chain. It is an ordered list of transformers.			
Base	ARObject, Identifiable , MultilanguageReferrable , Referrable			
Attribute	Type	Mult.	Kind	Note
data Transformation Kind	DataTransformationKind Enum	0..1	attr	This attribute controls the kind of DataTransformation to be applied.
executeDespite Data Unavailability	Boolean	1	attr	Specifies whether the transformer chain is executed even if no input data are available.
transformer Chain (ordered)	Transformation Technology	1..*	ref	This attribute represents the definition of a chain of transformers that are supposed to be executed according to the order of being referenced from DataTransformation.

Table 4.42: DataTransformation

Enumeration	DataTransformationKindEnum
Package	M2::AUTOSARTemplates::SystemTemplate::Transformer
Note	This enumeration contributes to the definition of the scope of the DataTransformation.
Literal	Description
asymmetricFrom ByteArray	The DataTransformation shall only be applied to the receiving end only, i.e. transform from byte array to data type. Tags: atp.EnumerationLiteralIndex=0
asymmetricToByteArray	The DataTransformation shall be applied to the sending end only, i.e. from data type to byte array. Tags: atp.EnumerationLiteralIndex=1
symmetric	The DataTransformation shall be applied at both the sending and the receiving end of the communication. Tags: atp.EnumerationLiteralIndex=2

Table 4.43: DataTransformationKindEnum

4.4 Port Annotation

4.4.1 Introduction

[TPS_SWCT_01203] PortPrototype may own port annotations [In addition to the formal specification required to implement the communication via ports, a [PortPrototype](#) may own so-called port annotations.

They do not directly influence the signature of calls via this [PortPrototype](#), but contain further information that may be useful for the application developers of the components on both sides of the connection.]()

A summary of port-level annotations can be found in Figure 4.21.

[TPS_SWCT_01204] GeneralAnnotation [Beside formally specified attributes it is also possible to place textual information as provided in [GeneralAnnotation](#).]()

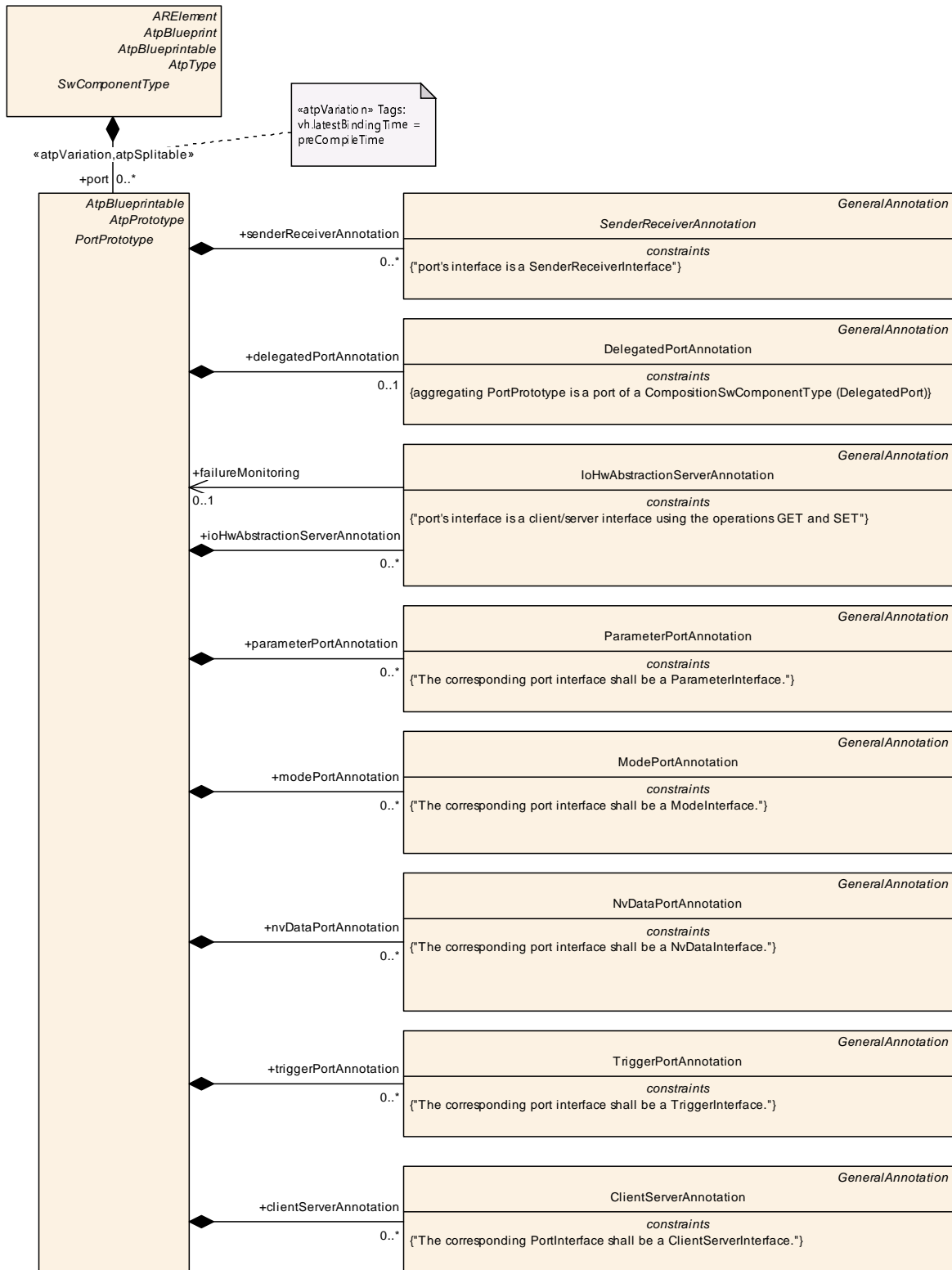

Figure 4.21: Application Level Port Annotations Overview

4.4.2 SenderReceiverAnnotation

Embedded automotive software is used to implement open-loop and closed-loop control-algorithms. Therefore, a software-component description has to accommodate typical control engineering description means which have only indirect influence of the embedded software itself.

These annotations provide the (function-) developer with a direct indication whether a certain software-component is appropriate for the control-algorithm to be designed. A typical annotation is the signal quality which is characterized by several properties. Each of the property is an annotation in its own.

[TPS_SWCT_01205] Typical annotations for sender/receiver communication
[Typical annotations for sender/receiver communication are:

- **Signal Age:** this attribute expresses that the associated software-component will only work correctly given that the propagation of the signal from a sensor to a consumer can be finished within a particular time-limit. Of course, this cannot be identified on component or role level, but has to take into account the instance view as well as the actual ECU- and bus-scheduling.
- **Raw:** a raw signal is typically taken directly from the basic software modules of the ECU abstraction layer. In particular, no sensor software-component has filtered its original value. A `dataElement` in an `RPortPrototype` of a `SwComponentType` using this annotation indicates to the control engineer (who develops a control-algorithm for this component) that the signal has to be filtered (This relationship applies for `SenderReceiverInterfaces`).
- **Filtered:** this attribute indicates that a raw signal has been manipulated by some application software-components by using a certain filter.
- **Computed:** this attribute indicates that this signal is not measured directly but calculated from tentatively several other measured or calculated signals. In a vehicle, there might be alternative signals to be used from other components having a better quality, e.g. a raw signal.
- **Min:** this annotation indicates that the signal carries a minimum value. If, for example, a reference value computed in the software-component is below that value some dedicated actions (e.g. failure-mode) might have to be taken.
- **Max:** this annotation indicates that the signal carries a maximum value. If, for example, a reference value computed in the software-component is above that value some dedicated actions (e.g. failure-mode) might have to be taken.

In the meta-model this aspect is implemented by the abstract meta-class `SenderReceiverAnnotation` which represents the base class of both `SenderAnnotation` and `ReceiverAnnotation`.]

The relationship of abstract meta-class `SenderReceiverAnnotation` to `SenderAnnotation` and `ReceiverAnnotation` is depicted in Figure 4.22.

Class	SenderReceiverAnnotation (abstract)			
Package	M2::AUTOSARTemplates::SWComponentTemplate::ApplicationAttributes			
Note	Annotation of the data elements in a port that realizes a sender/receiver interface.			
Base	<i>ARObject</i> , <i>GeneralAnnotation</i>			
Subclasses	<i>ReceiverAnnotation</i> , <i>SenderAnnotation</i>			
Attribute	Type	Mult.	Kind	Note
computed	Boolean	1	attr	Flag whether this data element was not measured directly but instead was calculated from possibly several other measured or calculated values.
dataElement	VariableDataPrototype	1	ref	The instance of VariableDataPrototype annotated.
limitKind	DataLimitKindEnum	1	attr	This min or max has not to be mismatched with the min- and max for data-value in a compu-method. For example, this annotation shows when the result of the calculation performed in a RunnableEntity owned by one AtomicSw ComponentType is transmitted to another AtomicSw ComponentType whose RunnableEntity will use this value as a limit, e.g. the max.power which can be used by that software-component, or the current min. slip.
processingKind	ProcessingKindEnum	1	attr	This attribute controls how data is processed according to the possible values of ProcessingKindEnum.

Table 4.44: SenderReceiverAnnotation

Class	SenderAnnotation			
Package	M2::AUTOSARTemplates::SWComponentTemplate::ApplicationAttributes			
Note	Annotation of a sender port, specifying properties of data elements that don't affect communication or generation of the RTE.			
Base	<i>ARObject</i> , <i>GeneralAnnotation</i> , <i>SenderReceiverAnnotation</i>			
Attribute	Type	Mult.	Kind	Note
–	–	–	–	–

Table 4.45: SenderAnnotation

Class	ReceiverAnnotation			
Package	M2::AUTOSARTemplates::SWComponentTemplate::ApplicationAttributes			
Note	Annotation of a receiver port, specifying properties of data elements that don't affect communication or generation of the RTE. The given attributes are requirements on the required data.			
Base	<i>ARObject</i> , <i>GeneralAnnotation</i> , <i>SenderReceiverAnnotation</i>			
Attribute	Type	Mult.	Kind	Note
signalAge	MultidimensionalTime	1	aggr	The maximum allowed age of the signal since it was originally read by a sensor. This is a requirement specified on the receiver side.

Table 4.46: ReceiverAnnotation

<i>Enumeration</i>	ProcessingKindEnum
Package	M2::AUTOSARTemplates::SWComponentTemplate::ApplicationAttributes
Note	Kind of processing which has been applied to a data element.
Literal	Description
filtered	Indicates that a raw signal has been manipulated by some application software components by using filters. Tags: atp.EnumerationLiteralIndex=0
none	Indicates that none of the other option apply. Tags: atp.EnumerationLiteralIndex=1
raw	Specifies that a signal is taken directly from the basic software modules, i.e. from the ECU abstraction layer. It indicates to a developer that the control algorithm in the software has to provide filters. Tags: atp.EnumerationLiteralIndex=2

Table 4.47: ProcessingKindEnum

<i>Enumeration</i>	DataLimitKindEnum
Package	M2::AUTOSARTemplates::SWComponentTemplate::ApplicationAttributes
Note	Indicates whether the data element carries a minimum or maximum value, thereby limiting the current range of another value.
Literal	Description
max	Limitation to maximum value Tags: atp.EnumerationLiteralIndex=0
min	Limitation to minimum value Tags: atp.EnumerationLiteralIndex=1
none	No limitation applicable Tags: atp.EnumerationLiteralIndex=2

Table 4.48: DataLimitKindEnum

[TPS_SWCT_01206] Min and Max annotations are valid for a certain amount of time [The Min and Max annotations are valid for a certain amount of time. The value is likely to change to another valid value while the ECU is running. E.g. the maximal torque which can be requested from an engine is a typical use-case.]()

This value might vary depending on e.g. the status of the climate control system. Therefore, these annotations shall not be mismatched with the min and max attributes of [CompuMethods](#).

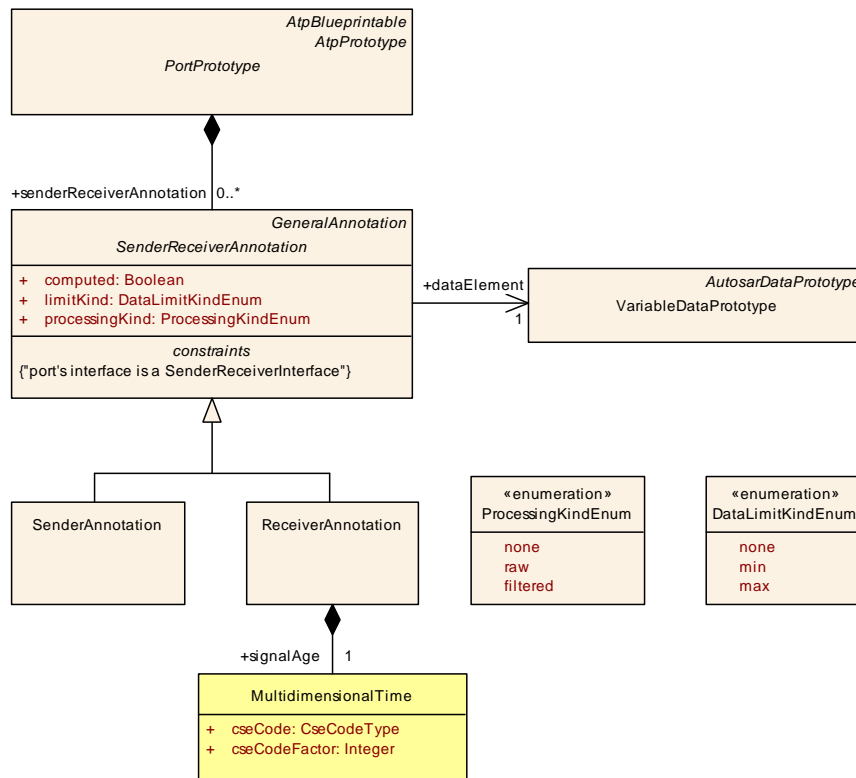

Figure 4.22: **SenderReceiverAnnotation**

The application level port annotations for sender/receiver communication have to be associated to each `dataElement` in a `PortPrototype`, e.g. there might be a “raw” `dataElement` and a “filtered” `dataElement` in the same `PortPrototype`!

[TPS_SWCT_01207] VariableDataPrototypes use the same application-level SenderReceiverAnnotation [Furthermore, if two `VariableDataPrototypes` use the same application-level `SenderReceiverAnnotation`, a reference from the annotation to the `VariableDataPrototypes` will be established by an appropriate tool.]()

[TPS_SWCT_01208] Grouping for SenderReceiverAnnotation [The `SenderReceiverAnnotation` for sender/receiver communication are grouped into

- processing type, indicating to some extent the direct quality of the signal,
- computed, which is just a flag or,
- limit type, showing the component expects an actual limit.

In the case of an `RPortPrototype`, the signal age of the value, carried by the associated `SwConnector`, can be specified. Each of these groups can be interpreted as a property of the signal-quality.]()

For more information about meta-class `SenderReceiverAnnotation` please refer to Figure 4.22.

[constr_4004] Context of `SenderReceiverAnnotation` [A `SenderReceiverAnnotation` shall only be aggregated by a `PortPrototype` typed by a `SenderReceiverInterface`.]()

4.4.3 ClientServerAnnotation

[TPS_SWCT_01209] `ClientServerAnnotation` [The `ClientServerAnnotation` can be used to provide more information with respect to the `ClientServerOperation` of the `PortPrototype`.]()

Class	<code>ClientServerAnnotation</code>			
Package	M2::AUTOSARTemplates::SWComponentTemplate::ApplicationAttributes			
Note	Annotation to a port regarding a certain Operation.			
Base	<code>ARObject</code> , <code>GeneralAnnotation</code>			
Attribute	Type	Mult.	Kind	Note
operation	<code>ClientServerOperation</code>	1	ref	This represents the <code>ClientServerOperation</code> that the <code>ClientServerAnnotation</code> corresponds to.

Table 4.49: ClientServerAnnotation

The main use-case is to define additional information related to the `ClientServerOperation`.

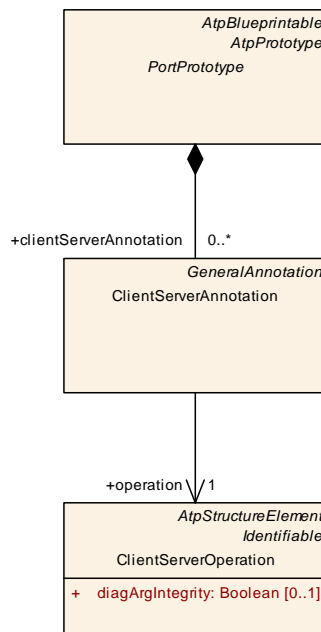

Figure 4.23: ClientServerAnnotation

[constr_4005] Context of `ClientServerAnnotation` [A `ClientServerAnnotation` shall only be aggregated by a `PortPrototype` typed by a `ClientServerInterface`.]()

4.4.4 Annotation for the I/O Hardware Abstraction Layer

Within the ECU-Abstraction Layer there are ECU-signals defined. These signals represent the electrical signals as they arrive in the micro-controller peripheral and are fetched from the registers via the MCAL.

Access to the I/O Hardware Abstraction Layer is done via service interfaces, i.e. the I/O Hardware Abstraction Layer provides GET- and SET-operations at the specified service ports of a *SensorActuatorSwComponentType*.

[TPS_SWCT_01524] Usage of *IoHwAbstractionServerAnnotation* [*IoHwAbstractionServerAnnotation* can be used for all kinds of *PortInterfaces* except *NvDataInterface*.]()

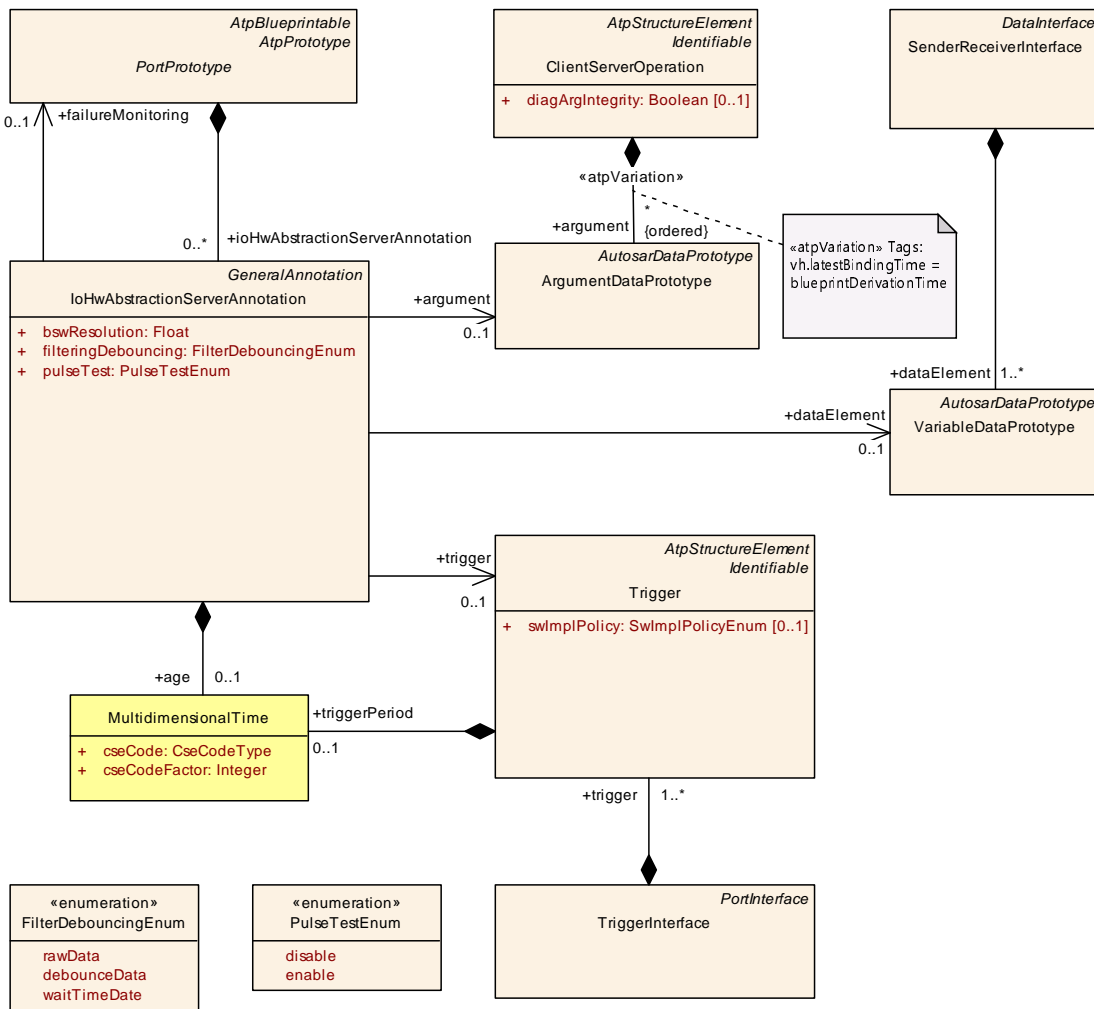

Figure 4.24: *IoHwAbstractionServerAnnotation*

Class	IoHwAbstractionServerAnnotation			
Package	M2::AUTOSARTemplates::SWComponentTemplate::ApplicationAttributes			
Note	<p>The IoHwAbstractionServerAnnotation will only be used from a sensor- or an actuator component while interacting with the IoHwAbstraction layer.</p> <p>Note that the "server" in the name of this meta-class is not meant to restrict the usage to ClientServer Interfaces.</p>			
Base	<i>ARObject, GeneralAnnotation</i>			
Attribute	Type	Mult.	Kind	Note
age	MultidimensionalTime	0..1	aggr	<p>In case of a SET operation, the age will be interpreted as Delay while in a GET operation (input) it specifies the Lifetime of the signal within the IoHwAbstraction Layer</p> <p>Tags:xml.sequenceOffset=10</p>
argument	ArgumentDataPrototype	0..1	ref	<p>Reference to the corresponding ArgumentDataPrototype.</p> <p>Tags:xml.sequenceOffset=20</p>
bswResolution	Float	1	attr	<p>This value is determined by an appropriate combination of the range, the unit as well as the data-elements type, i.e. $(\text{ecuSignalRange.upperLimit} - \text{ecuSignalRange.lowerLimit}) / (2^{\text{datatypeLength}} - 1)$</p> <p>Tags:xml.sequenceOffset=30</p>
dataElement	VariableDataPrototype	0..1	ref	<p>Reference to the corresponding VariableDataPrototype.</p> <p>Tags:xml.sequenceOffset=40</p>
failure Monitoring	PortPrototype	0..1	ref	<p>This is only applicable in SET operations. If it is enabled, the IoHwAbstraction layer will monitor the result of the operation and issue an diagnostic signal. This means especially, that an additional client-server port has to be created. Tools can use this information to cross-check whether for each data-element in a SET operation with FailureMonitoring enabled an additional port is created</p> <p>The referenced port monitors a failure in the to be monitored VariableDataPrototype of the IoHwAbstraction layer. The referenced port has to be another port of the same Actuator or Sensor Component.</p> <p>Tags:xml.sequenceOffset=50</p>
filtering Debouncing	FilterDebouncingEnum	1	attr	<p>This attribute is used to indicate what kind of filtering/ debouncing has been put to the signal in the IoHw Abstraction layer.</p> <p>rawData means that no modification of the signal has been applied. This is the default value debounceData means that the signal is a mean value waitTimeData means that the signal is delivered by a GET operation after a certain amount of time</p> <p>Tags:xml.sequenceOffset=60</p>
pulseTest	PulseTestEnum	1	attr	<p>This attribute indicates to the connected SensorActuator SwComponentType whether the VariableDataPrototype can be used to generate pulse test sequences using the IoHwAbstraction layer</p> <p>Tags:xml.sequenceOffset=70</p>
trigger	Trigger	0..1	ref	<p>Reference to the corresponding Trigger.</p> <p>Tags:xml.sequenceOffset=80</p>

Table 4.50: IoHwAbstractionServerAnnotation

Enumeration	FilterDebouncingEnum
Package	M2::AUTOSARTemplates::SWComponentTemplate::ApplicationAttributes
Note	This enumeration defines possible values for the filter debouncing strategy.
Literal	Description
debounceData	The signal is a mean value Tags: atp.EnumerationLiteralIndex=0
rawData	Means that no modification of the signal has been applied. This is the default value Tags: atp.EnumerationLiteralIndex=1
waitTimeDate	The signal is delivered by a GET operation after a certain amount of time Tags: atp.EnumerationLiteralIndex=2

Table 4.51: FilterDebouncingEnum

Enumeration	PulseTestEnum
Package	M2::AUTOSARTemplates::SWComponentTemplate::ApplicationAttributes
Note	This element indicates to the connected Actuator Software component whether the data-element can be used to generate pulse test sequences using the IoHwAbstraction layer
Literal	Description
disable	Disables the pulse test Tags: atp.EnumerationLiteralIndex=0
enable	Enables the pulse test Tags: atp.EnumerationLiteralIndex=1

Table 4.52: PulseTestEnum

[TPS_SWCT_01211] Assign several annotations to [ArgumentDataPrototype](#) [The [ClientServerOperations](#) provide an [ArgumentDataPrototype](#) where several annotations can be assigned to.]()

They are depicted in the [IoHwAbstractionServerAnnotation](#) meta-class in Figure 4.24.

A detailed description of the attributes can be found in the IoHwAbstraction Layer software specification document [17].

For example, the signal age has a very dedicated meaning in this particular interface with respect to a register whereas the signal age in the [SenderReceiverAnnotation](#) is more generic. Especially, there is no relationship with the micro-controller peripherals.

4.4.5 Parameter Port Annotation

[TPS_SWCT_01212] [ParameterPortAnnotation](#) [The [ParameterPortAnnotation](#) can be used to provide more information with respect to calibration parameter prototypes of the [PortPrototype](#).

The data provided at the `PortPrototype` is calibration parameters. The `ParameterPortAnnotation` provides a reference to a particular `ParameterDataPrototype`.
.]()

Class	ParameterPortAnnotation			
Package	M2::AUTOSARTemplates::SWComponentTemplate::ApplicationAttributes			
Note	Annotation to a port used for calibration regarding a certain <code>ParameterDataPrototype</code> .			
Base	<code>ARObject</code> , <code>GeneralAnnotation</code>			
Attribute	Type	Mult.	Kind	Note
parameter	<code>ParameterDataPrototype</code>	1	ref	The instance of annotated <code>ParameterDataPrototype</code> .

Table 4.53: ParameterPortAnnotation

The main use-case is to allow easy access to the information which calibration parameters influence the data on the `PortPrototype`.

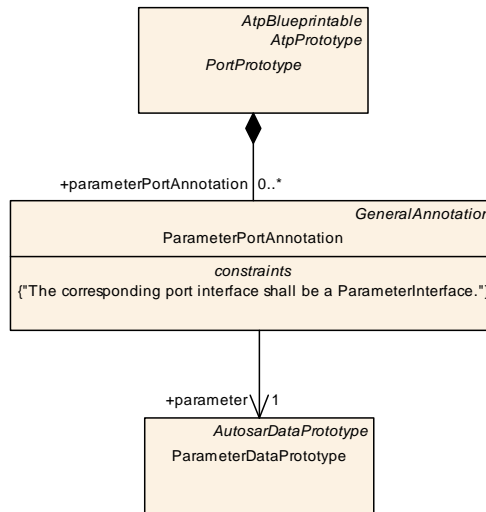

Figure 4.25: ParameterPortAnnotation

[constr_4006] Context of `ParameterPortAnnotation` [A `ParameterPortAnnotation` shall only be aggregated by a `PortPrototype` owned by a `ParameterSwComponentType`.]()

4.4.6 Mode Port Annotation

[TPS_SWCT_01213] `ModePortAnnotation` [The `ModePortAnnotation` can be used to provide more information with respect to the mode declaration group prototype of the `PortPrototype`.]()

Class	ModePortAnnotation			
Package	M2::AUTOSARTemplates::SWComponentTemplate::ApplicationAttributes			
Note	Annotation to a port used for calibration regarding a certain ModeDeclarationGroupPrototype.			
Base	ARObject, GeneralAnnotation			
Attribute	Type	Mult.	Kind	Note
modeGroup	ModeDeclarationGroup Prototype	1	ref	The instance of annotated ModeDeclarationGroup Prototype.

Table 4.54: ModePortAnnotation

The main use-case is to allow for the definition of additional information related to the mode declaration group prototype.

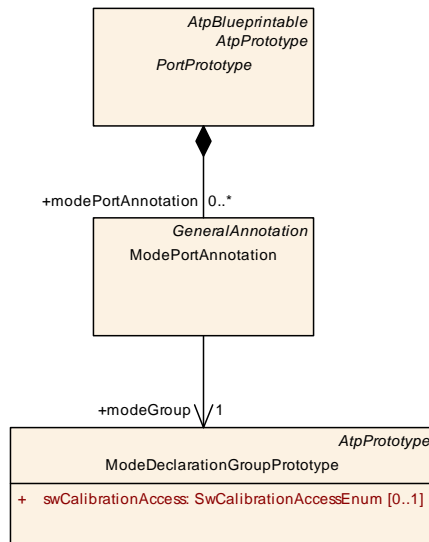

Figure 4.26: ModePortAnnotation

[constr_4007] Context of ModePortAnnotation [A ModePortAnnotation shall only be aggregated by a PortPrototype typed by a ModeSwitchInterface.]()

4.4.7 Trigger Port Annotation

[TPS_SWCT_01214] TriggerPortAnnotation [The TriggerPortAnnotation can be used to provide more information with respect to the Trigger of the Port-Prototype.]()

Class	TriggerPortAnnotation			
Package	M2::AUTOSARTemplates::SWComponentTemplate::ApplicationAttributes			
Note	Annotation to a port used for calibration regarding a certain Trigger.			
Base	ARObject, GeneralAnnotation			





Class	TriggerPortAnnotation			
Attribute	Type	Mult.	Kind	Note
trigger	Trigger	1	ref	The instance of annotated trigger.

Table 4.55: TriggerPortAnnotation

The main use-case is to define additional information related to the trigger.

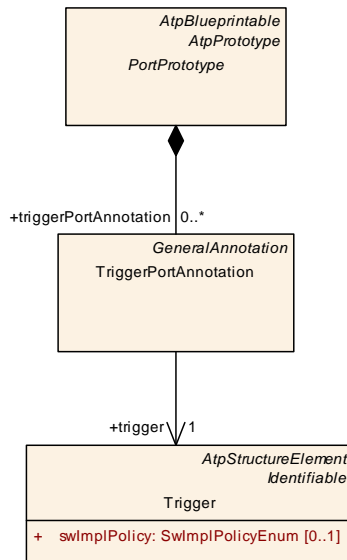

Figure 4.27: TriggerPortAnnotation

[constr_4008] Context of TriggerPortAnnotation [A TriggerPortAnnotation shall only be aggregated by a PortPrototype typed by a TriggerInterface.]()

4.4.8 Non Volatile Data Port Annotation

[TPS_SWCT_01215] NvDataPortAnnotation [The NvDataPortAnnotation can be used to provide more information with respect to the non-volatile data of the PortPrototype.]()

Class	NvDataPortAnnotation			
Package	M2::AUTOSARTemplates::SWComponentTemplate::ApplicationAttributes			
Note	Annotation to a port regarding a certain VariableDataPrototype.			
Base	ARObject, GeneralAnnotation			
Attribute	Type	Mult.	Kind	Note
variable	VariableDataPrototype	1	ref	The instance of nv data annotated.

Table 4.56: NvDataPortAnnotation

The main use-case is to define additional information related to the non-volatile data elements.

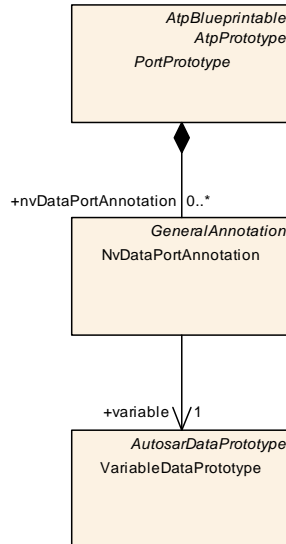

Figure 4.28: NvDataPortAnnotation

[constr_4009] Context of NvDataPortAnnotation [An NvDataPortAnnotation shall only be aggregated by a PortPrototype typed by an NvDataInterface.]()

4.4.9 Delegated Port Annotations

[TPS_SWCT_01216] DelegatedPortAnnotation [The DelegatedPortAnnotation is used to define the Signal Fan In or Signal Fan Out inside the CompositionSwComponentType.]

This information is used to pre-define and pre-check resulting communication patterns in the VFB (1:n, n:1, 1:1) if empty CompositionSwComponentTypes are used as interface definition for sub-systems.

The DelegatedPortAnnotation guides either the system designer in connecting the empty CompositionSwComponentType or the sub-system designer in applying communication pattern (1:n, n:1, 1:1) inside the CompositionSwComponentType.]()

Class	DelegatedPortAnnotation
Package	M2::AUTOSARTemplates::SWComponentTemplate::ApplicationAttributes
Note	Annotation to a "delegated port" to specify the Signal Fan In or Signal Fan Out inside the CompositionSwComponentType.
Base	ARObject, GeneralAnnotation





Class	DelegatedPortAnnotation			
Attribute	Type	Mult.	Kind	Note
signalFan	SignalFanEnum	0..1	attr	Specifies the Signal Fan In or Signal Fan Out inside the Composition Type.

Table 4.57: DelegatedPortAnnotation

Enumeration	SignalFanEnum
Package	M2::AUTOSARTemplates::SWComponentTemplate::ApplicationAttributes
Note	Signal Fan inside the Composition Component Type.
Literal	Description
ifold	The connections internally in the CompositionSwComponentType via DelegationSwConnectors and AssemblySwConnectors are defined in a way that at least one data element present in the S/R interface or one ClientServerOperation in the C/S interface of the outer PortPrototype is involved in a 1:n or n:1 communication pattern. Tags: atp.EnumerationLiteralIndex=0
single	The connections internally in the CompositionSwComponentType via DelegationSwConnectors and AssemblySwConnectors are defined in a way that each VariableDataPrototype present in the S/R interface or ClientServerOperation in the C/S interface of the outer PortPrototype is involved in a 1:1 communication pattern only. Tags: atp.EnumerationLiteralIndex=1

Table 4.58: SignalFanEnum

[TPS_SWCT_01217] Semantics of [DelegatedPortAnnotation.signalFan](#) [The attribute values have following definition:

- **single:** the internal connections in the [CompositionSwComponentType](#) via [DelegationSwConnectors](#) and [AssemblySwConnectors](#) are defined in a way that each [dataElement](#) present in the [SenderReceiverInterfaces](#) or [operation](#) in the [ClientServerInterfaces](#) of the outer [PortPrototype](#) is involved in a 1:1 communication pattern only.
- **ifold:** The internal connections in the [CompositionSwComponentType](#) via [DelegationSwConnectors](#) and [AssemblySwConnectors](#) are defined in a way that at least one [dataElement](#) present in the [SenderReceiverInterfaces](#) or one [operation](#) in the [ClientServerInterfaces](#) of the outer [PortPrototype](#) is involved in a 1:n or n:1 communication pattern.

]()

[constr_4010] Context of [DelegatedPortAnnotation](#) [A [DelegatedPortAnnotation](#) shall only be aggregated by a [PortPrototype](#) aggregated by a [CompositionSwComponentType](#).]()

4.4.10 General Annotation

Besides, formally specified attributes it is also possible to place textual information as provided in the abstract [GeneralAnnotation](#) (see Figure 4.29 for an overview).

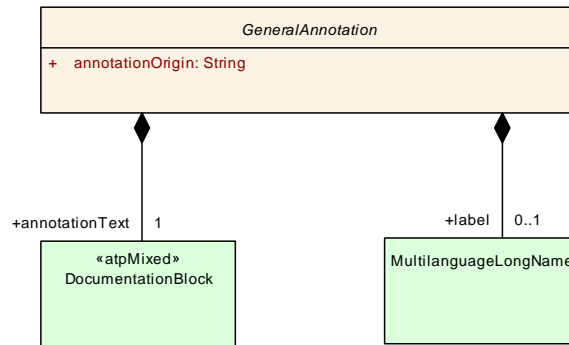

Figure 4.29: textual information in annotations

Class	GeneralAnnotation (abstract)			
Package	M2::AUTOSARTemplates::GenericStructure::GeneralTemplateClasses::GeneralAnnotation			
Note	<p>This class represents textual comments (called annotations) which relate to the object in which it is aggregated. These annotations are intended for use during the development process for transferring information from one step of the development process to the next one.</p> <p>The approach is similar to the "yellow pads" ...</p> <p>This abstract class can be specialized in order to add some further formal properties.</p>			
Base	ARObject			
Subclasses	Annotation , ClientServerAnnotation , DelegatedPortAnnotation , IoHwAbstractionServerAnnotation , ModePortAnnotation , NvDataPortAnnotation , ParameterPortAnnotation , SenderReceiverAnnotation , TriggerPortAnnotation			
Attribute	Type	Mult.	Kind	Note
annotation Origin	String	1	attr	<p>This attribute identifies the origin of the annotation. It is an arbitrary string since it can be an individual's name as well as the name of a tool or even the name of a process step.</p> <p>Tags:xml.sequenceOffset=30</p>
annotationText	DocumentationBlock	1	aggr	<p>This is the text of the annotation.</p> <p>Tags:xml.sequenceOffset=40</p>
label	MultilanguageLong Name	0..1	aggr	<p>This is the headline for the annotation.</p> <p>Tags:xml.sequenceOffset=20</p>

Table 4.59: GeneralAnnotation

4.5 Communication Specification

[TPS_SWCT_01218] Big picture of ComSpec [The highest level of description of information exchanged between components in an AUTOSAR system is the [PortInterfaces](#), as shown in earlier sections.

Such [PortInterface](#) however, only describes structure and does not include information about whether communication needs to be done reliably, or whether an initial value exists in case the real data is not yet available.

This information is role-specific, i.e. it shall be applied on the level of [PortPrototypes](#) rather than [PortInterfaces](#). Therefore, most communication-relevant attributes are related to the [PortPrototypes](#) of an [SwComponentType](#).

The communication attributes are organized in a so-called **communication specification** (in terms of the meta-model: `ComSpec`) classes.] ()

Note that the communication specification is optional, i.e. its existence is not required in any case. Figures 4.30 and 4.31 provide an overview of communication specifications. The derived meta-classes are explained in the following sub-chapters.

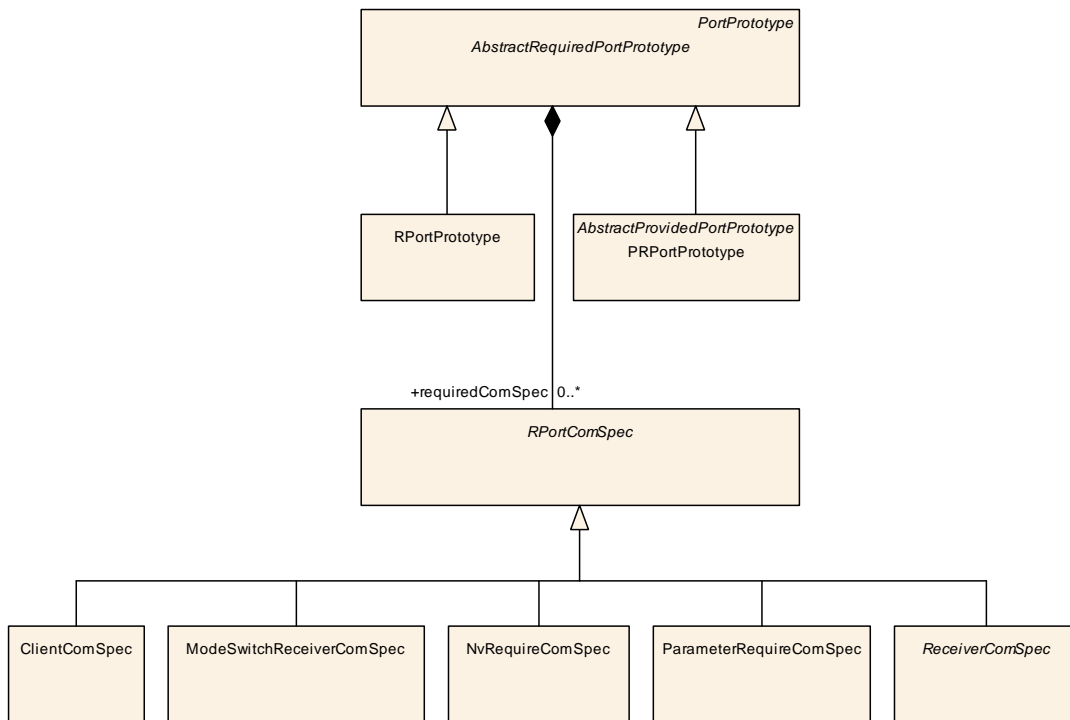

Figure 4.30: Overview of communication attributes of `RPortPrototype`

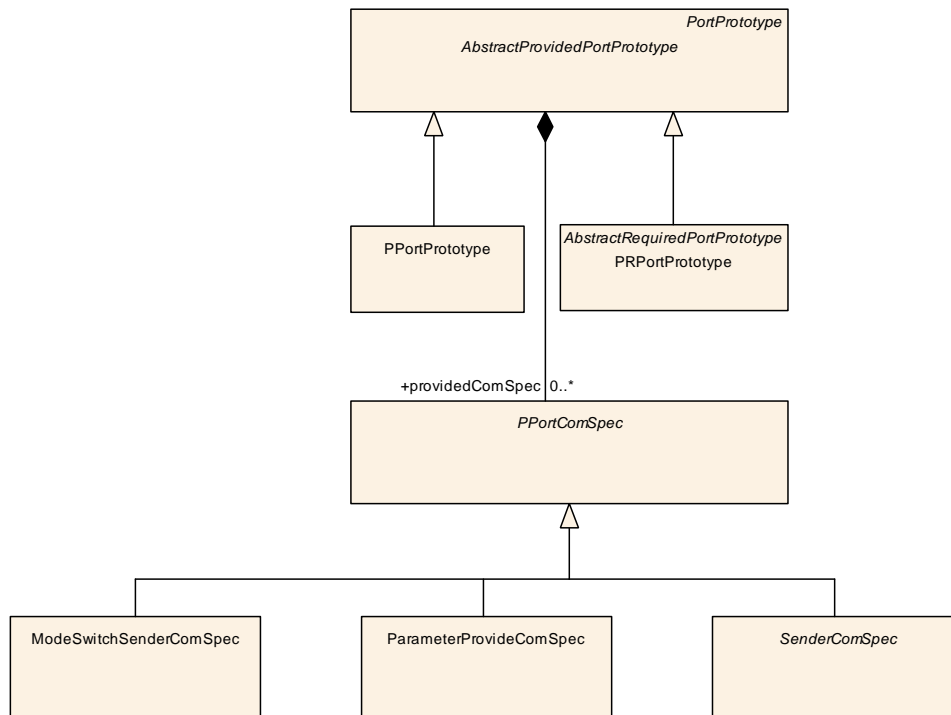

Figure 4.31: Overview of communication attributes of `PPortPrototype`

As explained before, `ComSpec` meta-classes which are required on the level of a `SwComponentType` are attached to the `PortPrototype` declarations which in turn are part of the definition of a `SwComponentType`.

Nevertheless, the usage of `ComSpecs` is **not** restricted to the `PortPrototypes` of `AtomicSwComponentTypes` (for more details please refer to section 2.5).

Sections 7.5.1 and 7.5.2 then explain the sender-receiver and client-server communication patterns with respect to the RTE, the RTE events and the corresponding communication attributes.

Several `ComSpecs` allow defining `initValues` in relation to the associated `DataPrototype`. For further details about the representation of `initValues` please refer to section 5.7.2.

Furthermore, semantic constraints apply such that specific subclasses of `ComSpec` can only be owned by `PortPrototypes` typed by the corresponding kind of `PortInterface`.

[constr_1290] Limitation on the number of `PPortComSpecs` in the context of one `PPortPrototype` [Within the context of one `PPortPrototype` there can only be one `PPortComSpec` that references a given `dataElement` or `operation`.]()

In other words, it is not allowed that two or more `PPortComSpec` exist in the context of a one `PPortPrototype` that refer to the same `dataElement` or `operation`.

[constr_1291] Limitation on the number of RPortComSpecs in the context of one PPortPrototype [Within the context of one RPortPrototype, there can only be one RPortComSpec that references a given dataElement or operation.]()

In other words, it is not allowed that two or more RPortComSpec exist in the context of a one RPortPrototype that refer to the same dataElement or operation.

[TPS_SWCT_01454] PRPortPrototype can own both RPortComSpecs and PPortComSpecs [In contrast to PPortPrototype and RPortPrototype, PRPortPrototype can own both RPortComSpecs and PPortComSpecs at the same time.] (RS_SWCT_03250)

Nevertheless, the following restriction applies:

[constr_1292] Limitation on the number of RPortComSpecs/PPortComSpecs in the context of one PRPortPrototype [Within the context of one PRPortPrototype, there can only be one RPortComSpec and one PPortComSpec that references a given dataElement or operation.]()

In other words, it is not allowed that two or more PPortComSpec exist in the context of a one PRPortPrototype that refer to the same dataElement or operation.

In the same manner, it is not allowed that two or more RPortComSpec exist in the context of one PRPortPrototype that refer to the same dataElement or operation.

The rationale for the existence of [constr_1290], [constr_1291], and [constr_1292] is that the AUTOSAR communication layer needs an unambiguous specification of the communication behavior.

The existence of redundant RPortComSpecs/PPortComSpecs may easily be contradicting each other and this would inhibit the creation of a valid configuration for the AUTOSAR Com.

Class	<i>PPortComSpec</i> (abstract)			
Package	M2::AUTOSARTemplates::SWComponentTemplate::Communication			
Note	Communication attributes of a provided PortPrototype. This class will contain attributes that are valid for all kinds of provide ports, independent of client-server or sender-receiver communication patterns.			
Base	<i>ARObject</i>			
Subclasses	<i>ModeSwitchSenderComSpec</i> , <i>NvProvideComSpec</i> , <i>ParameterProvideComSpec</i> , <i>SenderComSpec</i> , <i>ServerComSpec</i>			
Attribute	Type	Mult.	Kind	Note
–	–	–	–	–

Table 4.60: PPortComSpec

Class	<i>RPortComSpec</i> (abstract)			
Package	M2::AUTOSARTemplates::SWComponentTemplate::Communication			
Note	Communication attributes of a required PortPrototype. This class will contain attributes that are valid for all kinds of require-ports, independent of client-server or sender-receiver communication patterns.			
Base	<i>ARObject</i>			
Subclasses	ClientComSpec , ModeSwitchReceiverComSpec , NvRequireComSpec , ParameterRequireComSpec , ReceiverComSpec			
Attribute	Type	Mult.	Kind	Note
–	–	–	–	–

Table 4.61: RPortComSpec

[constr_1043] PortInterface vs. ComSpec [The allowed combinations of a specific kind of [PortInterface](#) and a kind of [ComSpec](#) are documented in Table 4.62.]
()

PortInterface	ComSpec
SenderReceiverInterface	SenderComSpec , ReceiverComSpec
ClientServerInterface	ClientComSpec , ServerComSpec
ModeSwitchInterface	ModeSwitchSenderComSpec , ModeSwitchReceiverComSpec
ParameterInterface	ParameterProvideComSpec , ParameterRequireComSpec
NvDataInterface	NvRequireComSpec , NvProvideComSpec

Table 4.62: PortInterface vs. ComSpec

As explained in section 2.5, there are cases where [PortPrototypes](#) owned by a [CompositionSwComponentType](#) could have `initValues`.

Therefore, it is possible that [PortPrototypes](#) owned by [CompositionSwComponentTypes](#) can have [ComSpecs](#). It is *not* required that the [ComSpecs](#) defined on the composition level match the [ComSpecs](#) defined inside the [CompositionSwComponentType](#).

If consistency would be required this constraint might be a major obstacle for integrating existing [AtomicSwComponentTypes](#) into a [CompositionSwComponentType](#) that has [PortPrototypes](#) with [ComSpecs](#).

4.5.1 Communication Specification for Sender-Receiver Communication

Communication specification applies in different ways to specific kinds of communication. Figure 4.32 shows the meta-model of the communication attributes relevant sender-receiver communication at an [RPortPrototype](#).

[TPS_SWCT_01455] Duplicate existence of `initValue` in the context of a [PR-PortPrototype](#) [If an `initValue` is defined in a [NonqueuedReceiverComSpec](#) owned by a [PRPortPrototype](#), its value shall be ignored.] ([RS_SWCT_03250](#))

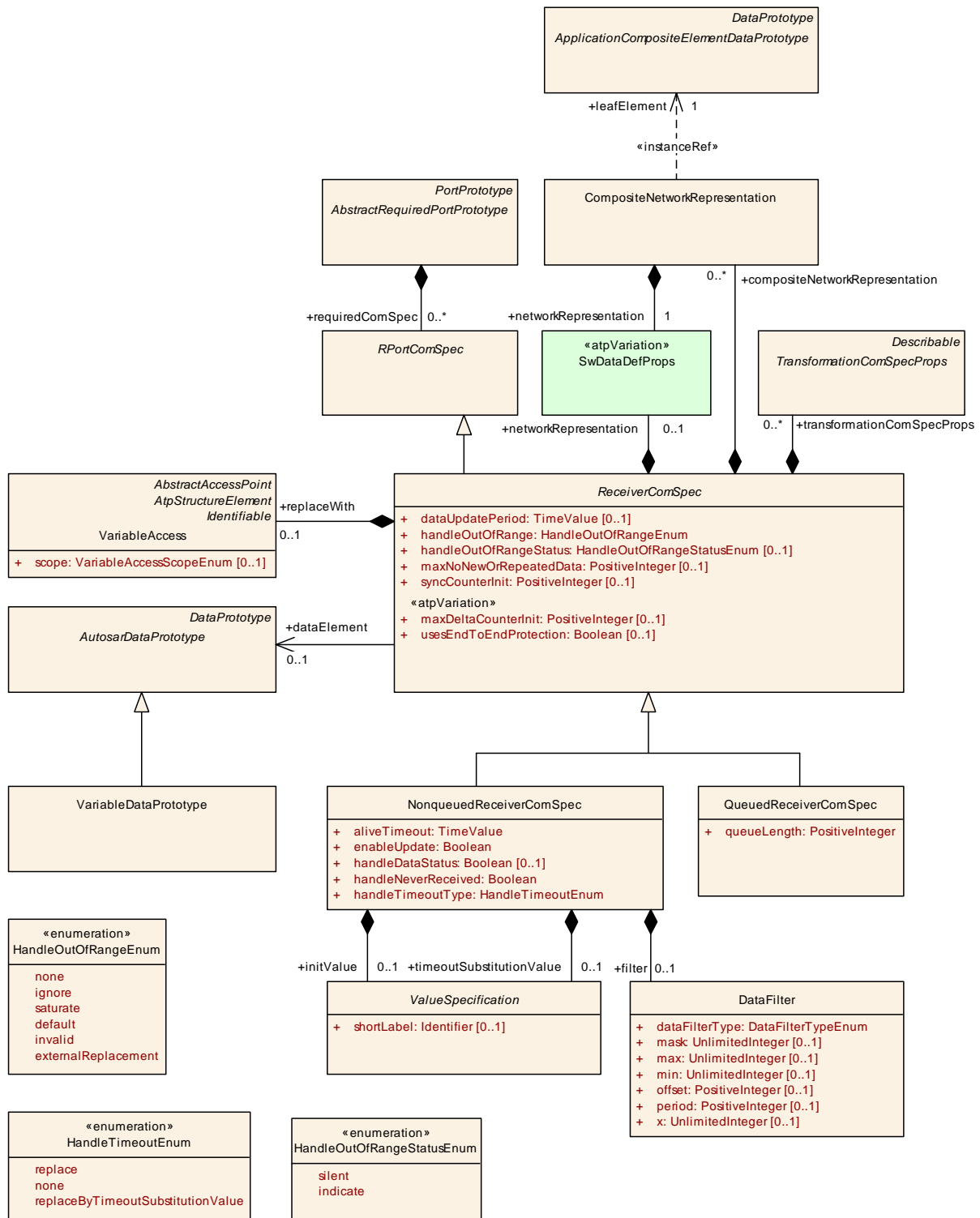

Figure 4.32: Communication attributes of **RPortPrototype** with respect to sender-receiver communication.

[TPS_SWCT_01219] **ComSpec for queued and non-queued sender-receiver communication** [Sender-receiver communication might be queued or non-queued. This aspect is primarily reflected in the value of `dataElement.swDataDefProps.swImplPolicy`.

If the value of this attribute is set to `queued` then `QueuedSenderComSpec` and/or `QueuedReceiverComSpec` shall be defined. In all other applicable cases `Non-queuedSenderComSpec` or `NonqueuedReceiverComSpec` shall be used.

Thus, the constraints [constr_1129], [constr_1130], [constr_1131], and [constr_1132] shall apply.

While in the case of queued communication the `queueLength` attribute remains the only information item the non-queued case foresees several attributes for controlling communication behavior.] ()

Class	ReceiverComSpec (abstract)			
Package	M2::AUTOSARTemplates::SWComponentTemplate::Communication			
Note	Receiver-specific communication attributes (RPortPrototype typed by SenderReceiverInterface).			
Base	ARObject, RPortComSpec			
Subclasses	NonqueuedReceiverComSpec, QueuedReceiverComSpec			
Attribute	Type	Mult.	Kind	Note
composite Network Representation	CompositeNetworkRepresentation	*	aggr	This represents a CompositeNetworkRepresentation defined in the context of a ReceiverComSpec. The purpose of this aggregation is to be able to specify the network representation of leaf elements of Application CompositeDataTypes.
dataElement	AutosarDataPrototype	0..1	ref	Data element these attributes belong to.
dataUpdate Period	TimeValue	0..1	attr	This attribute defines the period in which the application shall check for updated data. This attribute is used for the configuration of the E2E protection. Tags: atp.Status=draft
handleOutOf Range	HandleOutOfRangeEnum	1	attr	This attribute controls how values that are out of the specified range are handled according to the values of HandleOutOfRangeEnum.
handleOutOf RangeStatus	HandleOutOfRangeStatusEnum	0..1	attr	Control the way how return values are created in case of an out-of-range situation.
maxDelta CounterInit	PositiveInteger	0..1	attr	Initial maximum allowed gap between two counter values of two consecutively received valid Data, i.e. how many subsequent lost data is accepted. For example, if the receiver gets Data with counter 1 and MaxDeltaCounter Init is 1, then at the next reception the receiver can accept Counters with values 2 and 3, but not 4. Note that if the receiver does not receive new Data at a consecutive read, then the receiver increments the tolerance by 1. Stereotypes: atpVariation Tags: vh.latestBindingTime=preCompileTime
maxNoNewOr RepeatedData	PositiveInteger	0..1	attr	The maximum amount of missing or repeated Data which the receiver does not expect to exceed under normal communication conditions.
network Representation	SwDataDefProps	0..1	aggr	A networkRepresentation is used to define how the data Element is mapped to a communication bus.
replaceWith	VariableAccess	0..1	aggr	This aggregation is used to identify the AutosarData Prototype to be taken for sourcing an external replacement in the out-of-range handling.





Class	ReceiverComSpec (abstract)			
syncCounterInit	PositiveInteger	0..1	attr	Number of Data required for validating the consistency of the counter that shall be received with a valid counter (i.e. counter within the allowed lock-in range) after the detection of an unexpected behavior of a received counter.
transformationComSpecProps	TransformationComSpecProps	*	aggr	This references the TransformationComSpecProps which define port-specific configuration for data transformation.
usesEndToEndProtection	Boolean	0..1	attr	This indicates whether the corresponding dataElement shall be transmitted using end-to-end protection. Stereotypes: atpVariation Tags: vh.latestBindingTime=preCompileTime

Table 4.63: ReceiverComSpec

Class	NonqueuedReceiverComSpec			
Package	M2::AUTOSARTemplates::SWComponentTemplate::Communication			
Note	Communication attributes specific to non-queued receiving.			
Base	ARObject , RPortComSpec , ReceiverComSpec			
Attribute	Type	Mult.	Kind	Note
aliveTimeout	TimeValue	1	attr	Specify the amount of time (in seconds) after which the software component (via the RTE) needs to be notified if the corresponding data item have not been received according to the specified timing description. If the aliveTimeout attribute is 0 no timeout monitoring shall be performed.
enableUpdate	Boolean	1	attr	This attribute controls whether application code is entitled to check whether the value of the corresponding VariableDataPrototype has been updated.
filter	DataFilter	0..1	aggr	The applicable filter algorithm for filtering the value of the corresponding dataElement.
handleDataStatus	Boolean	0..1	attr	If this attribute is set to true than the Rte_IStatus API shall exist. If the attribute does not exist or is set to false then the Rte_IStatus API may still exist in response to the existence of further conditions.
handleNeverReceived	Boolean	1	attr	This attribute specifies whether for the corresponding VariableDataPrototype the "never received" flag is available. If yes, the RTE is supposed to assume that initially the VariableDataPrototype has not been received before. After the first reception of the corresponding VariableDataPrototype the flag is cleared. <ul style="list-style-type: none"> • If the value of this attribute is set to "true" the flag is required. • If set to "false", the RTE shall not support the "never received" functionality for the corresponding VariableDataPrototype.
handleTimeoutType	HandleTimeoutEnum	1	attr	This attribute controls the behavior with respect to the handling of timeouts.
initValue	ValueSpecification	0..1	aggr	Initial value to be used in case the sending component is not yet initialized. If the sender also specifies an initial value the receiver's value will be used.





Class	NonqueuedReceiverComSpec			
timeout Substitution Value	ValueSpecification	0..1	aggr	This attribute represents the substitution value applicable in the case of a timeout.

Table 4.64: NonqueuedReceiverComSpec

Class	QueuedReceiverComSpec			
Package	M2::AUTOSARTemplates::SWComponentTemplate::Communication			
Note	Communication attributes specific to queued receiving.			
Base	ARObject , RPortComSpec , ReceiverComSpec			
Attribute	Type	Mult.	Kind	Note
queueLength	PositiveInteger	1	attr	Length of queue for received events.

Table 4.65: QueuedReceiverComSpec

Enumeration	HandleTimeoutEnum			
Package	M2::AUTOSARTemplates::SWComponentTemplate::Communication			
Note	Strategies of handling a reception timeout violation.			
Literal	Description			
none	If set to none no replacement shall take place. Tags: atp.EnumerationLiteralIndex=0			
replace	If set to replace, the replacement value shall be the ComInitValue. Tags: atp.EnumerationLiteralIndex=1			
replaceByTimeout SubstitutionValue	If set to replace, the replacement value shall be the timeout substitution value. Tags: atp.EnumerationLiteralIndex=2			

Table 4.66: HandleTimeoutEnum

Primitive	TimeValue			
Package	M2::AUTOSARTemplates::GenericStructure::GeneralTemplateClasses::PrimitiveTypes			
Note	This primitive type is taken for expressing time values. The numerical value is supposed to be interpreted in the physical unit second. Tags: xml.xsd.customType=TIME-VALUE xml.xsd.type=double			

Table 4.67: TimeValue

[constr_1538] Restriction for [ReceiverComSpec.dataElement](#) [The reference [ReceiverComSpec.dataElement](#) shall not refer to an [ArgumentDataPrototype](#) or [ParameterDataPrototype](#).]()

[constr_1103] [NonqueuedReceiverComSpec](#) and [enableUpdate](#) [A [NonqueuedReceiverComSpec](#) that has the value of attribute [enableUpdate](#) set to true may not reference a [dataElement](#) that in turn is referenced by a [VariableAccess](#) in the role [dataReadAccess](#).]()

In general, it is considered beneficial for software-components to define `initValues` for all the `dataElements` received by `RPortPrototypes`.

These `initValues` are required by the RTE for several functionalities, e.g.:

- Providing a default value for not yet received `dataElements` (see [TPS_SWCT_01220]).
- Providing default values in case of unconnected `RPortPrototypes` (see [constr_1100]).
- Partial mapping of composite data (see [constr_1280])

Therefore, the availability of `initValue` increases the flexibility of the usage of the software-component in different scenarios.

On the other hand, there are also use cases where `initValues` are not mandatory, i.e. the `DataPrototype` remains intentionally uninitialized. This is expressed by applying a `SwAddrMethod` where the `sectionInitializationPolicy` is set to `NO-INIT`, or when the software component is intentionally only prepared for intra-partition communication.

In response to these conflicting objectives [TPS_SWCT_01688] is written as a recommendation as opposed to a binding constraint.

[TPS_SWCT_01688] `initValue` should exist in an `RPortPrototype` [The optional attribute `initValue` should exist if the enclosing `NonqueuedReceiverComSpec` is owned by an `RPortPrototype`.]()

[constr_1129] `swImplPolicy` and `NonqueuedReceiverComSpec` [The attribute `swImplPolicy` of a `dataElement` referenced by a `NonqueuedReceiverComSpec` shall not be set to the value `queued`.]()

[constr_1130] `swImplPolicy` and `QueuedReceiverComSpec` [The attribute `swImplPolicy` of a `dataElement` referenced by a `QueuedReceiverComSpec` shall be set to the value `queued`.]()

[constr_1188] Existence of `ReceiverComSpec.replaceWith` [The aggregation of `VariableAccess` in the role `ReceiverComSpec.replaceWith` shall exist **if and only if at least one of the following conditions is fulfilled**:

- Attribute `ReceiverComSpec.handleOutOfRange` is set to the value `externalReplacement`.
- Attribute `SenderReceiverInterface.invalidationPolicy.handleInvalid` is set to the value `externalReplacement`.

]()

[TPS_SWCT_01753] Application of compatibility rules for `ReceiverComSpec.replaceWith` [Compatibility rules as formulated by [constr_1068] and [constr_1187] shall be applicable for the reference `ReceiverComSpec.replaceWith`.]()

[constr_1131] `swImplPolicy` and `NonqueuedSenderComSpec` [The attribute `swImplPolicy` of a `dataElement` referenced by a `NonqueuedSenderComSpec` shall not be set to the value `queued`.]()

[constr_1132] `swImplPolicy` and `QueuedSenderComSpec` [The attribute `swImplPolicy` of a `dataElement` referenced by a `QueuedSenderComSpec` shall be set to the value `queued`.]()

[TPS_SWCT_01220] `initValue` defines an initial value that shall be taken if the corresponding `dataElement` has not yet been received [The aggregation of `ValueSpecification` in the role `initValue` defines an initial value that shall be taken if the corresponding `dataElement` has not yet been received but the application software is attempting to access its value.]()

The communication attributes on the sender side are sketched in Figure 4.34.

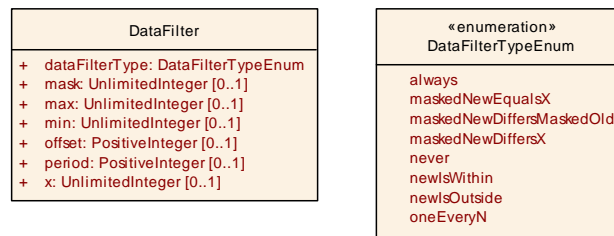

Figure 4.33: `DataFilter` and its communication attributes.

Figure 4.33 shows the model of the communication attributes relevant for defining data filters.

[TPS_SWCT_01221] `DataFilter` [For every `RPortPrototype` typed by a `SenderReceiverInterface` a `DataFilter` can be defined given that non-queued communication is foreseen.]()

Fifteen filter algorithms formally described by the enumeration type `DataFilterTypeEnum` in the meta-model are taken from the ISO 17356-4 specification [18] that is referenced by the RTE specification [2].

[TPS_SWCT_01222] Applicability of `DataFilter` [This ISO 17356-4 specification states that “filtering is only used for messages that can be interpreted as C language unsigned integer types (characters, unsigned integers and enumerations).”] (*RS_SWCT_03221*)

[constr_1044] Applicability of `DataFilter` [According to the origin of `DataFilter`, i.e. ISO 17356-4 specification [18], `DataFilters` can only be applied to values with an integer base type.]()

Class	DataFilter			
Package	M2::AUTOSARTemplates::CommonStructure::Filter			
Note	Base class for data filters. The type of the filter is specified in attribute dataFilterType. Some of the filter types require additional arguments which are specified as attributes of this class.			
Base	ARObject			
Attribute	Type	Mult.	Kind	Note
dataFilterType	DataFilterTypeEnum	1	attr	This attribute specifies the type of the filter.
mask	UnlimitedInteger	0..1	attr	Mask for old and new value.
max	UnlimitedInteger	0..1	attr	Value to specify the upper boundary
min	UnlimitedInteger	0..1	attr	Value to specify the lower boundary
offset	PositiveInteger	0..1	attr	Specifies the initial number of messages to occur before the first message is passed
period	PositiveInteger	0..1	attr	Specifies number of messages to occur before the message is passed again
x	UnlimitedInteger	0..1	attr	Value to compare with

Table 4.68: DataFilter

Enumeration	DataFilterTypeEnum
Package	M2::AUTOSARTemplates::CommonStructure::Filter
Note	This enum specifies the supported DataFilterTypes.
Literal	Description
always	No filtering is performed so that the message always passes. Tags: atp.EnumerationLiteralIndex=0
maskedNewDiffers MaskedOld	Pass messages where the masked value has changed. (new_value&mask) !=(old_value&mask) new_value: current value of the message old_value: last value of the message (initialized with the initial value of the message, updated with new_value if the new message value is not filtered out) Tags: atp.EnumerationLiteralIndex=1
maskedNewDiffers X	Pass messages whose masked value is not equal to a specific value x (new_value&mask) != x new_value: current value of the message Tags: atp.EnumerationLiteralIndex=2
maskedNewEquals X	Pass messages whose masked value is equal to a specific value x (new_value&mask) == x new_value: current value of the message Tags: atp.EnumerationLiteralIndex=3
never	The filter removes all messages. Tags: atp.EnumerationLiteralIndex=4
newIsOutside	Pass a message if its value is outside a predefined boundary. (min > new_value) OR (new_value > max) Tags: atp.EnumerationLiteralIndex=5





Enumeration	DataFilterTypeEnum
newsWithin	<p>Pass a message if its value is within a predefined boundary.</p> <p>$\text{min} \leq \text{new_value} \leq \text{max}$</p> <p>Tags:atp.EnumerationLiteralIndex=6</p>
oneEveryN	<p>Pass a message once every N message occurrences.</p> <p>Algorithm: $\text{occurrence} \% \text{period} == \text{offset}$</p> <p>Start: $\text{occurrence} = 0$.</p> <p>Each time the message is received or transmitted, occurrence is incremented by 1 after filtering.</p> <p>Length of occurrence is 8 bit (minimum).</p> <p>Tags:atp.EnumerationLiteralIndex=7</p>

Table 4.69: DataFilterTypeEnum

[TPS_SWCT_01593] Semantics of attribute `ReceiverComSpec.transformationComSpecProps` [The `ReceiverComSpec.transformationComSpecProps` is used to configure `PortPrototype`-specific properties for data transformation in case of receiving inter-ECU communication.]()

[TPS_SWCT_01682] The meaning of E2E-related attributes in a `ReceiverComSpec` if a `TransformationComSpecProps` of type `EndToEndTransformationComSpecProps` is defined. [The attributes `usesEndToEndProtection`, `syncCounterInit`, `maxDeltaCounterInit`, and `maxNoNewOrRepeatedData` in `ReceiverComSpec` have no meaning if a `TransformationComSpecProps` of type `EndToEndTransformationComSpecProps` is defined in the same `ReceiverComSpec`.]()

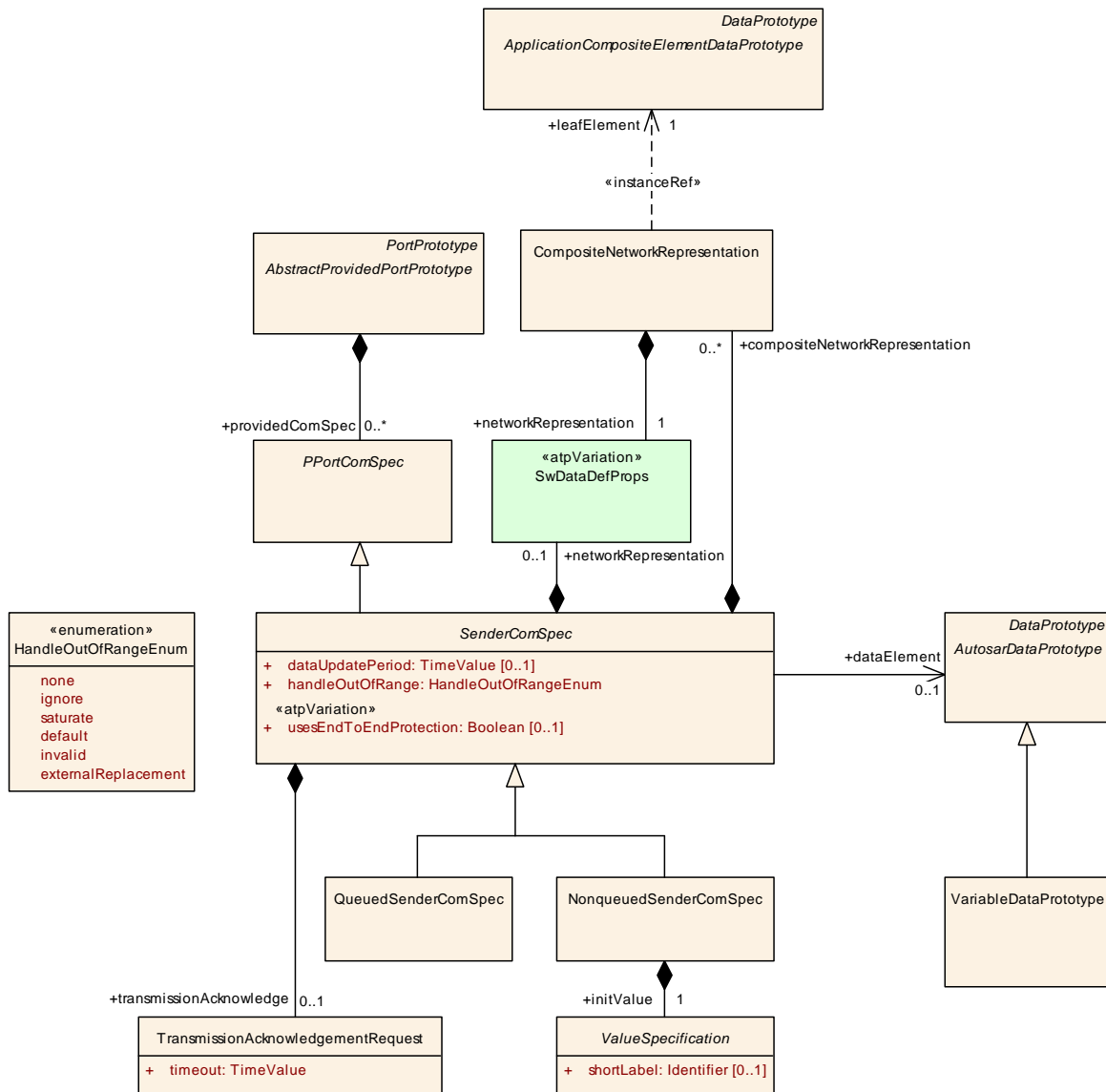

Figure 4.34: Communication attributes of PPortPrototype with respect to sender-receiver communication.

[TPS_SWCT_01751] The meaning of E2E-related attributes in a SenderComSpec if a TransformationComSpecProps of type EndToEndTransformationComSpecProps is defined [The attribute usesEndToEndProtection has no meaning if a TransformationComSpecProps of type EndToEndTransformationComSpecProps is defined in the same SenderComSpec.]()

Please note:

- SenderComSpec.usesEndToEndProtection does not have any influence on code generation.

It could be used, for example, by a validation framework to make sure that, if set to True the dataElement meets a transformer configuration for all respective SwConnectors connecting to the PortPrototype that owns the SenderComSpec.

- `SenderComSpec.usesEndToEndProtection` could be used as a statement from the application developer that the given `dataElement` shall be end-to-end protected.

However, it seems far-fetched for an application developer to expressly state that a `dataElement` shall **not** be end-to-end protected. This goes beyond the responsibility of an application developer.

Therefore, two relevant states for `SenderComSpec.usesEndToEndProtection` can be expected:

- attribute exists and is set to `True` (application developer asserts the necessity to end-to-end protect the `dataElement`)
- attribute does not exist (application developer doesn't care)
- The application developer may not have enough oversight to envision how the `dataElement` is communicated, i.e. local vs. network communication. Setting `usesEndToEndProtection` to `True` and then deploy the enclosing software-component such that it communicates only locally on the respective `PortPrototype` also seems unusual for the current situation regarding transformer-based communication.

[constr_1539] Restriction for `SenderComSpec.dataElement` [The reference `SenderComSpec.dataElement` shall not refer to an `ArgumentDataPrototype` or `ParameterDataPrototype`.]()

Class	<code>SenderComSpec</code> (abstract)			
Package	M2::AUTOSARTemplates::SWComponentTemplate::Communication			
Note	Communication attributes for a sender port (PPortPrototype typed by SenderReceiverInterface).			
Base	<code>ARObject</code> , <code>PPortComSpec</code>			
Subclasses	<code>NonqueuedSenderComSpec</code> , <code>QueuedSenderComSpec</code>			
Attribute	Type	Mult.	Kind	Note
composite Network Representation	<code>CompositeNetworkRepresentation</code>	*	aggr	This represents a <code>CompositeNetworkRepresentation</code> defined in the context of a <code>SenderComSpec</code> .
<code>dataElement</code>	<code>AutosarDataPrototype</code>	0..1	ref	Data element these quality of service attributes apply to.
<code>dataUpdatePeriod</code>	<code>TimeValue</code>	0..1	attr	This attribute describes the period in which the applications are assumed to transmit E2E-protected messages. Tags: atp.Status=draft
<code>handleOutOfRange</code>	<code>HandleOutOfRangeEnum</code>	1	attr	This attribute controls how out-of-range values shall be dealt with.
network Representation	<code>SwDataDefProps</code>	0..1	aggr	A <code>networkRepresentation</code> is used to define how the data Element is mapped to a communication bus.
<code>transmissionAcknowledge</code>	<code>TransmissionAcknowledgementRequest</code>	0..1	aggr	Requested transmission acknowledgement for data element.





Class	SenderComSpec (abstract)			
usesEndToEndProtection	Boolean	0..1	attr	This indicates whether the corresponding dataElement shall be transmitted using end-to-end protection. Stereotypes: atpVariation Tags: vh.latestBindingTime=preCompileTime

Table 4.70: SenderComSpec

Class	QueuedSenderComSpec			
Package	M2::AUTOSARTemplates::SWComponentTemplate::Communication			
Note	Communication attributes specific to distribution of events (PPortPrototype, SenderReceiverInterface and dataElement carries an "event").			
Base	ARObject, PPortComSpec, SenderComSpec			
Attribute	Type	Mult.	Kind	Note
–	–	–	–	–

Table 4.71: QueuedSenderComSpec

Class	NonqueuedSenderComSpec			
Package	M2::AUTOSARTemplates::SWComponentTemplate::Communication			
Note	Communication attributes for non-queued sender/receiver communication (sender side)			
Base	ARObject, PPortComSpec, SenderComSpec			
Attribute	Type	Mult.	Kind	Note
initValue	ValueSpecification	1	aggr	Initial value to be sent if sender component is not yet fully initialized, but receiver needs data already.

Table 4.72: NonqueuedSenderComSpec

Class	TransmissionAcknowledgementRequest			
Package	M2::AUTOSARTemplates::SWComponentTemplate::Communication			
Note	Requests transmission acknowledgement that data has been sent successfully. Success/failure is reported via a SendPoint of a RunnableEntity.			
Base	ARObject			
Attribute	Type	Mult.	Kind	Note
timeout	TimeValue	1	attr	Number of seconds before an error is reported or in case of allowed redundancy, the value is sent again.

Table 4.73: TransmissionAcknowledgementRequest

Enumeration	HandleOutOfRangeEnum			
Package	M2::AUTOSARTemplates::SWComponentTemplate::Communication			
Note	A value of this type is taken for controlling the range checking behavior of the AUTOSAR RTE.			
Literal	Description			
default	The RTE will use the initValue if the actual value is out of the specified bounds. Tags: atp.EnumerationLiteralIndex=0			





Enumeration	HandleOutOfRangeEnum
external Replacement	This indicates that the value replacement is sourced from the attribute replaceWith. Tags: atp.EnumerationLiteralIndex=1
ignore	The RTE will ignore any attempt to send or receive the corresponding dataElement if the value is out of the specified range. Tags: atp.EnumerationLiteralIndex=2
invalid	The RTE will use the invalidValue if the value is out of the specified bounds. Tags: atp.EnumerationLiteralIndex=3
none	A range check is not required. Tags: atp.EnumerationLiteralIndex=4
saturate	The RTE will saturate the value of the dataElement such that it is limited to the applicable upper bound if it is greater than the upper bound. Consequently, it is limited to the applicable lower bound if the value is less than the lower bound. Tags: atp.EnumerationLiteralIndex=5

Table 4.74: HandleOutOfRangeEnum

[TPS_SWCT_01223] networkRepresentation defines how a specific dataElement is represented on a communication bus [For sender-receiver communication, it is possible to specify how dataElements are represented given that the communication requires the usage of a dedicated communication bus.

That is, by means of the networkRepresentation it is possible to define how a specific dataElement is represented on a communication bus. For this purpose the networkRepresentation is implemented as an aggregation of SwDataDefProps.]
()

[TPS_SWCT_01224] CompuMethods of dataElement and the networkRepresentation are used for conversion purposes [The attached CompuMethods of both the dataElement and the networkRepresentation can be used to identify the conversion between the two.

The advantage of this approach is that this can also be used without any modifications in combination with a general remapping and rescaling of dataElements between different SwComponentTypes, regardless whether they are located on the same or on different ECUs.]()

Please note that the decision whether to take the networkRepresentation for data mapping is done in the context of the AUTOSAR System Template [10]. Please find more detailed information about this aspect in the applicable specification.

[TPS_SWCT_01452] Applicability of networkRepresentation for ApplicationCompositeDataType [The aggregation of networkRepresentation at the ReceiverComSpec or SenderComSpec only applies for dataElements typed by ApplicationPrimitiveDataTypes.

For the case of using an ApplicationCompositeDataType an additional mechanism shall be used.

In particular, `compositeNetworkRepresentation` shall be used to define the `networkRepresentation` of leaf elements of `ApplicationCompositeDataTypes`.
()

[constr_1196] Existence of `networkRepresentation` vs. `compositeNetworkRepresentation` [If a `ReceiverComSpec` or `SenderComSpec` aggregates `networkRepresentation` it shall **not** aggregate `compositeNetworkRepresentation` at the same time (and vice versa).]()

[constr_1197] Existence of `compositeNetworkRepresentation` shall be comprehensive [If at least one `compositeNetworkRepresentation` exists then for each leaf `ApplicationCompositeElementDataPrototype` of the affected `ApplicationCompositeDataType` exactly one `compositeNetworkRepresentation` shall be defined.]()

Granted, the definition of `[constr_1197]` to some extent has a recursive character. The meaning is that if it is actually intended to define a `compositeNetworkRepresentation` then the definition shall be completely covering the entire set of leaf elements of the corresponding `ApplicationCompositeDataType`. In other words, it's all or nothing.

Class	CompositeNetworkRepresentation			
Package	M2::AUTOSARTemplates::SWComponentTemplate::Communication			
Note	This meta-class is used to define the network representation of leaf elements of composite application data types.			
Base	<i>ARObject</i>			
Attribute	Type	Mult.	Kind	Note
leafElement	ApplicationCompositeElementDataPrototype	1	iref	This represents that leaf element of an application composite data type.
networkRepresentation	SwDataDefProps	1	aggr	The <code>SwDataDefProps</code> owned by the <code>CompositeNetworkRepresentation</code> are used to define the network representation of the leaf element of an <code>ApplicationCompositeDataType</code> .

Table 4.75: CompositeNetworkRepresentation

4.5.2 Communication Specification for Client-Server Communication

The communication aspects relevant for client communication are sketched in Figure 4.35.

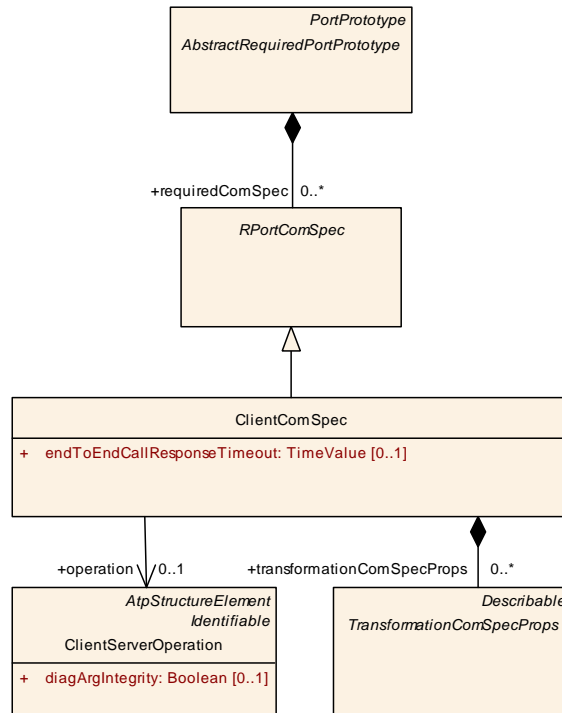

Figure 4.35: Communication attributes of `RPortPrototype` with respect to client-server communication.

Class	<code>ClientComSpec</code>			
Package	M2::AUTOSARTemplates::SWComponentTemplate::Communication			
Note	Client-specific communication attributes (<code>RPortPrototype</code> typed by <code>ClientServerInterface</code>).			
Base	<code>ARObject</code> , <code>RPortComSpec</code>			
Attribute	Type	Mult.	Kind	Note
endToEndCallResponseTimeout	<code>TimeValue</code>	0..1	attr	This attribute defines the maximum time interval in which the application shall expect the servers's response (time between the sending of the call invocation until the arrival of the server's response).
operation	<code>ClientServerOperation</code>	0..1	ref	This represents the corresponding <code>ClientServerOperation</code> .
transformationComSpecProps	<code>TransformationComSpecProps</code>	*	aggr	This references the <code>TransformationComSpecProps</code> which define port-specific configuration for data transformation.

Table 4.76: ClientComSpec

[constr_1540] Existence of `ClientComSpec.operation` [The reference `ClientComSpec.operation` shall exist if the `AbstractRequiredPortPrototype` that owns the `ClientComSpec` is typed by a `ClientServerInterface`.]()

Note: on the *AUTOSAR adaptive platform* the `ClientComSpec` can also be used in the context of `RPortPrototypes` typed by `PortInterfaces` that are not available on the *AUTOSAR classic platform*. This is the motivation for the existence of [constr_1540].

The server side looks very similar but provides an attribute for specifying the queue length.

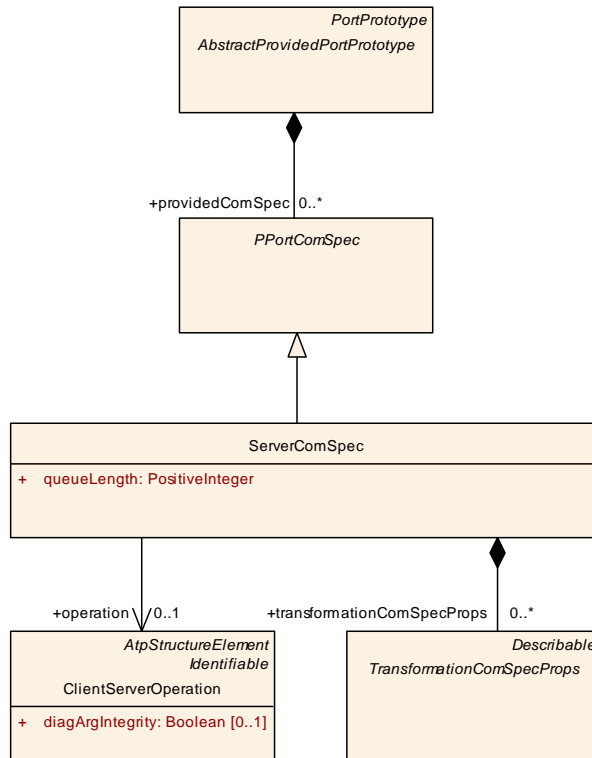

Figure 4.36: Communication attributes of PPortPrototype with respect to client-server communication.

Class	ServerComSpec			
Package	M2::AUTOSARTemplates::SWComponentTemplate::Communication			
Note	Communication attributes for a server port (PPortPrototype and ClientServerInterface).			
Base	ARObject, PPortComSpec			
Attribute	Type	Mult.	Kind	Note
operation	ClientServerOperation	0..1	ref	Operation these communication attributes apply to.
queueLength	PositiveInteger	1	attr	Length of call queue on the server side. The queue is implemented by the RTE. The value shall be greater or equal to 1. Setting the value of queueLength to 1 implies that incoming requests are rejected while another request that arrived earlier is being processed.
transformationComSpecProps	TransformationComSpecProps	*	aggr	This references the TransformationComSpecProps which define port-specific configuration for data transformation.

Table 4.77: ServerComSpec

[constr_1541] Existence of ServerComSpec.operation [The reference `ServerComSpec.operation` shall exist if the `AbstractProvidedPortPrototype` that owns the `ServerComSpec` is typed by a `ClientServerInterface`.]()

Note: on the *AUTOSAR adaptive platform* the `ServerComSpec` can also be used in the context of `RPortPrototypes` typed by `PortInterfaces` that are not available on the *AUTOSAR classic platform*. This is the motivation for the existence of `[constr_1541]`.

[TPS_SWCT_01225] **RunnableEntity** implements the functionality of more than one **ClientServerOperations** [A single **RunnableEntity** can implement the functionality of more than one **ClientServerOperations**.

For this purpose, one **OperationInvokedEvent** for each affected **ClientServerOperation** shall reference the respective **RunnableEntity**.

The attribute **ServerComSpec.queueLength** shall be taken for the determination of the resulting queue length, [constr_1128] applies.>()

For more information about requirements towards **ClientServerOperations** triggering the same **RunnableEntity** can be found in section 7.2.4.3, specifically [constr_2000].

[constr_1128] **Queue length of ClientServerOperations associated with the same RunnableEntity** [If two or more **OperationInvokedEvents** reference a single **RunnableEntity** the value of the **ServerComSpec** attribute **queueLength** shall be **identical** for all **ServerComSpecs** owned by **PPortPrototypes** of the enclosing **SwComponentType** that reference one of the **ClientServerOperations** that are also referenced by the **OperationInvokedEvents**.]()

[TPS_SWCT_01595] **Semantics of attribute ClientComSpec.transformationComSpecProps** [The attribute **ClientComSpec.transformationComSpecProps** shall be used to configure **PortPrototype**-specific properties for data transformation in case of Client/Server inter-ECU communication for the reception of the server's response.](RS_SWCT_03221)

[TPS_SWCT_01596] **Semantics of attribute ServerComSpec.transformationComSpecProps** [The attribute **ServerComSpec.transformationComSpecProps** shall be used to configure **PortPrototype**-specific properties for data transformation in case of Client/Server inter-ECU communication for the reception of the client's request.](RS_SWCT_03221)

See chapter 4.5.6 for details.

4.5.3 Communication Specification for Mode Switch Communication

In analogy to the previous section, Figure 4.37 shows the meta-model elements relevant for a mode switch communication. On the sender side it is possible to specify that an acknowledgement is supposed to be returned that indicates the successful processing of the mode switch request.

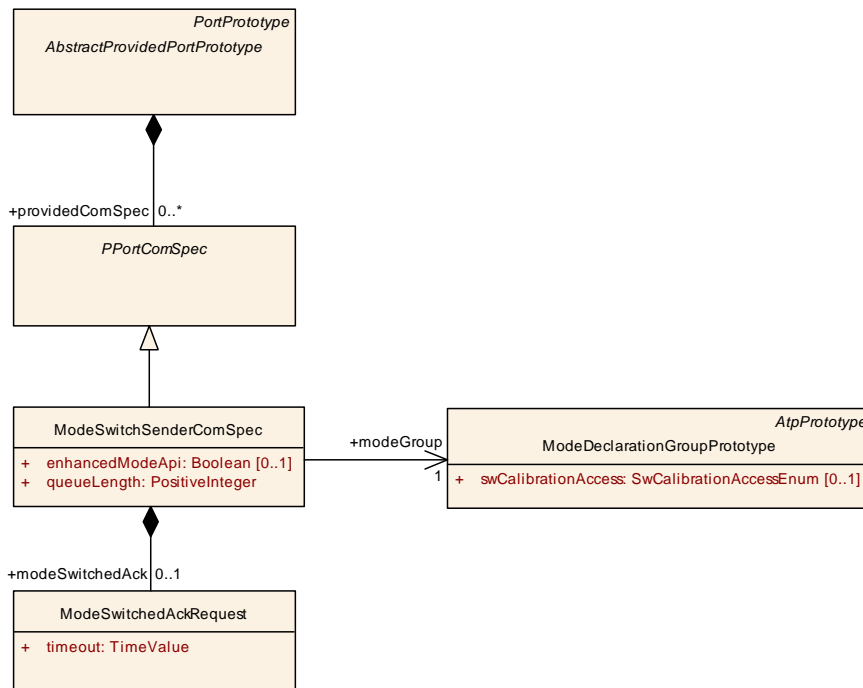

Figure 4.37: Communication attributes of PPortPrototype with respect to mode switch communication.

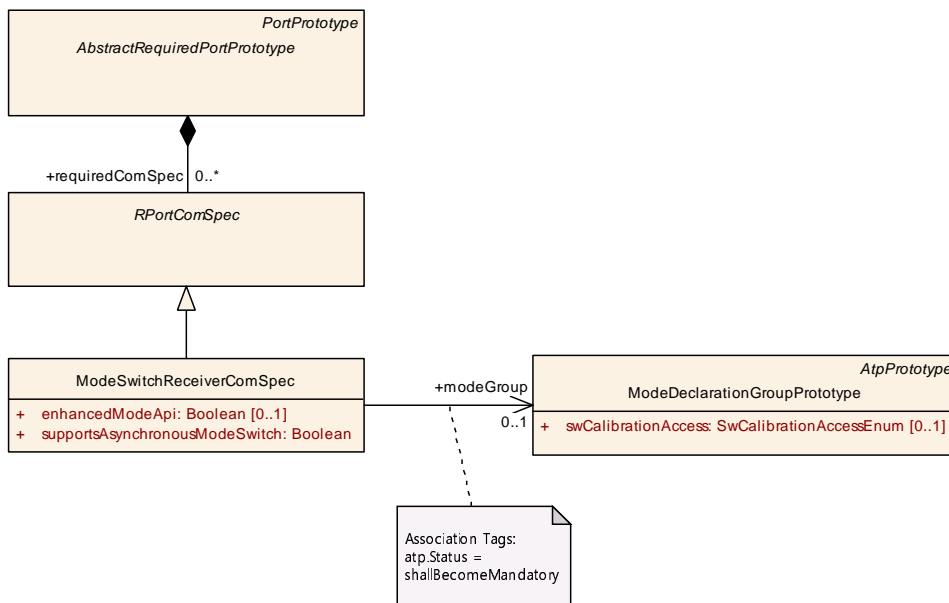

Figure 4.38: Communication attributes of PPortPrototype with respect to mode switch communication.

[TPS_SWCT_01514] Duplicate existence of enhancedModeApi in the context of a PPortPrototype [If the attribute enhancedModeApi is defined in a ModeSwitchReceiverComSpec owned by a PPortPrototype, its value shall be ignored.](RS_SWCT_03250)

Class	ModeSwitchSenderComSpec			
Package	M2::AUTOSARTemplates::SWComponentTemplate::Communication			
Note	Communication attributes of PPortPrototypes with respect to mode communication			
Base	ARObject, PPortComSpec			
Attribute	Type	Mult.	Kind	Note
enhancedMode Api	Boolean	0..1	attr	This controls the creation of the enhanced mode API that returns information about the previous mode and the next mode. If set to "true" the enhanced mode API is supposed to be generated. For more details please refer to the SWS_RTE.
modeGroup	ModeDeclarationGroup Prototype	1	ref	ModeDeclarationGroupPrototype (of the same Port Interface) to which these communication attributes apply.
modeSwitched Ack	ModeSwitchedAck Request	0..1	aggr	If this aggregation exists an acknowledgement for the successful processing of the mode switch request is required.
queueLength	PositiveInteger	1	attr	Length of call queue on the mode user side. The queue is implemented by the RTE. The value shall be greater or equal to 1. Setting the value of queueLength to 1 implies that incoming requests are rejected while another request that arrived earlier is being processed.

Table 4.78: ModeSwitchSenderComSpec

Class	ModeSwitchedAckRequest			
Package	M2::AUTOSARTemplates::SWComponentTemplate::Communication			
Note	Requests acknowledgements that a mode switch has been proceeded successfully			
Base	ARObject			
Attribute	Type	Mult.	Kind	Note
timeout	TimeValue	1	attr	Number of seconds before an error is reported or in case of allowed redundancy, the value is sent again.

Table 4.79: ModeSwitchedAckRequest

Class	ModeSwitchReceiverComSpec			
Package	M2::AUTOSARTemplates::SWComponentTemplate::Communication			
Note	Communication attributes of RPortPrototypes with respect to mode communication			
Base	ARObject, RPortComSpec			
Attribute	Type	Mult.	Kind	Note
enhancedMode Api	Boolean	0..1	attr	This controls the creation of the enhanced mode API that returns information about the previous mode and the next mode. If set to "true" the enhanced mode API is supposed to be generated. For more details please refer to the SWS_RTE.
modeGroup	ModeDeclarationGroup Prototype	0..1	ref	ModeDeclarationGroupPrototype (of the same Port Interface) to which these communication attributes apply. Tags: atp.Status=shallBecomeMandatory





Class	ModeSwitchReceiverComSpec			
supports Asynchronous ModeSwitch	Boolean	1	attr	This attribute controls the behavior of the corresponding RPortPrototype with respect to the question whether it can deal with asynchronous mode switch requests, i.e. if set to true, the RPortPrototype is able to deal with an asynchronous mode switch request.

Table 4.80: ModeSwitchReceiverComSpec

4.5.4 Communication Specification for Parameters

Granted, the definition of a ComSpec for [ParameterDataPrototypes](#) looks strange on first sight. A [ParameterDataPrototype](#) owned by a [PPortPrototype](#) typed by a [ParameterInterface](#) is not actually transmitted over any communication medium. Therefore, the term *communication* should in this case be taken with a grain of salt.

However, it is generally necessary to be able to define role-specific initial values for [ParameterDataPrototypes](#) aggregated in a [ParameterInterface](#). In other words, the actual problem closely resembles the definition of initial values in the case of sender-receiver communication.

[TPS_SWCT_01226] `initValue` on the level of a ComSpec is relevant for connections to the corresponding [PortPrototype](#) [Please note that (along the example of sender-receiver communication) only the `initValue` defined in the context of a [ParameterProvideComSpec](#) or [ParameterRequireComSpec](#) is relevant for connections to the corresponding [PortPrototype](#). An `initValue` defined in the scope of a [ParameterDataPrototype](#) is ignored.]()

Therefore, it is only reasonable to apply the existing and well-known pattern to the definition of initial values for [ParameterDataPrototypes](#) aggregated in a [ParameterInterface](#). The actual modeling is sketched in Figure 4.39 for provided [ParameterDataPrototypes](#) and in Figure 4.40 for required [ParameterDataPrototypes](#).

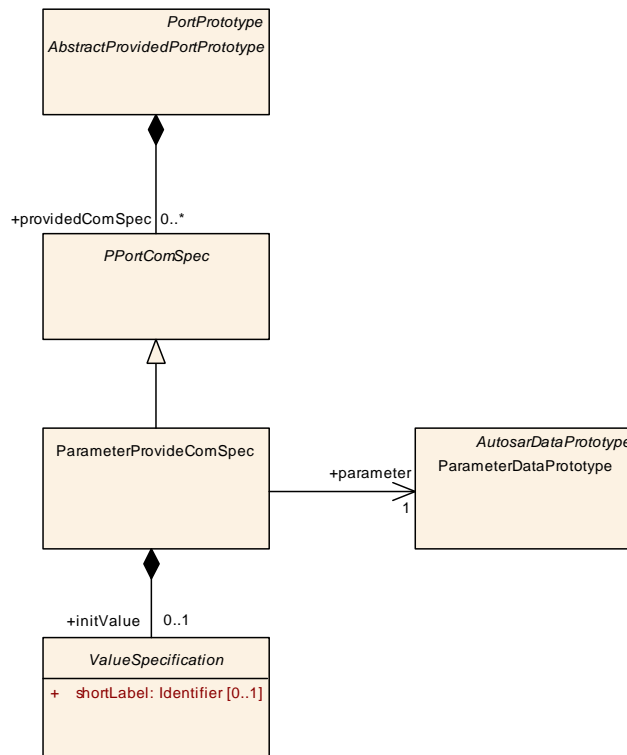

Figure 4.39: Communication attributes of [ParameterDataPrototypes](#) with respect to [PPortPrototype](#)

Class	ParameterProvideComSpec			
Package	M2::AUTOSARTemplates::SWComponentTemplate::Communication			
Note	"Communication" specification that applies to parameters on the provided side of a connection.			
Base	ARObject, PPortComSpec			
Attribute	Type	Mult.	Kind	Note
initValue	ValueSpecification	0..1	aggr	The initial value applicable for the corresponding ParameterDataPrototype.
parameter	ParameterDataPrototype	1	ref	The ParameterDataPrototype to which the Parameter ComSpec applies.

Table 4.81: ParameterProvideComSpec

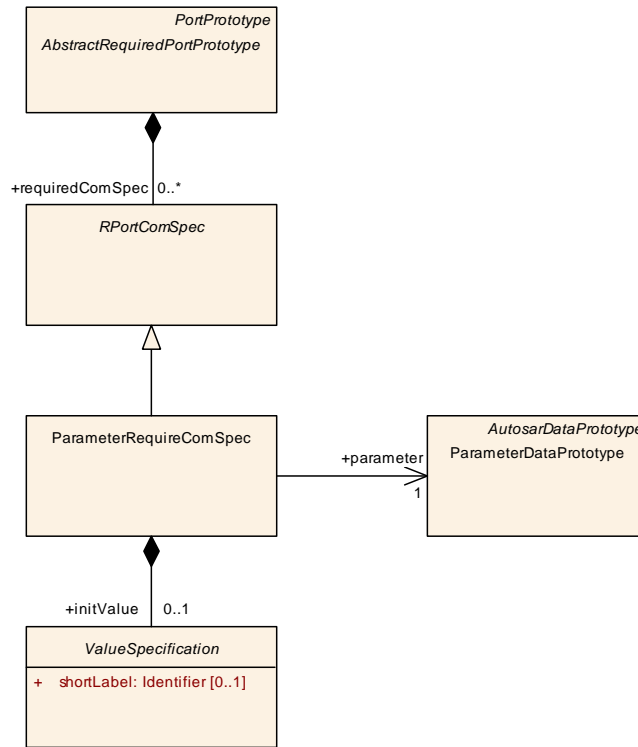

Figure 4.40: Communication attributes of [ParameterDataPrototypes](#) with respect to [RPortPrototype](#)

Class	ParameterRequireComSpec			
Package	M2::AUTOSARTemplates::SWComponentTemplate::Communication			
Note	"Communication" specification that applies to parameters on the required side of a connection.			
Base	<i>ARObject</i> , <i>RPortComSpec</i>			
Attribute	Type	Mult.	Kind	Note
initValue	ValueSpecification	0..1	aggr	The initial value applicable for the corresponding ParameterDataPrototype .
parameter	ParameterDataPrototype	1	ref	The ParameterDataPrototype to which the ParameterRequireComSpec applies.

Table 4.82: ParameterRequireComSpec

4.5.5 Communication Specification for NV Data

[TPS_SWCT_01141] [AtomicSwComponentType](#) may have [AbstractRequiredPortPrototypes](#) typed by an [NvDataInterface](#) [An [AtomicSwComponentType](#) may have [AbstractRequiredPortPrototypes](#) typed by an [NvDataInterface](#).

If such an `AbstractRequiredPortPrototype` remains unconnected the `nvData` still need to have reasonable value⁷.] (*RS_SWCT_03225*)

[TPS_SWCT_01227] Unconnected `AbstractRequiredPortPrototype` typed by `NvDataInterface` [For this purpose it is possible to let the `AbstractRequiredPortPrototype` own an `NvRequireComSpec` that in turn owns a `ValueSpecification` in the role of `initValue`.

It is therefore possible to provide an `nvData` with a reasonable value even if the corresponding `AbstractRequiredPortPrototype` remains unconnected.] (*RS_SWCT_03225*)

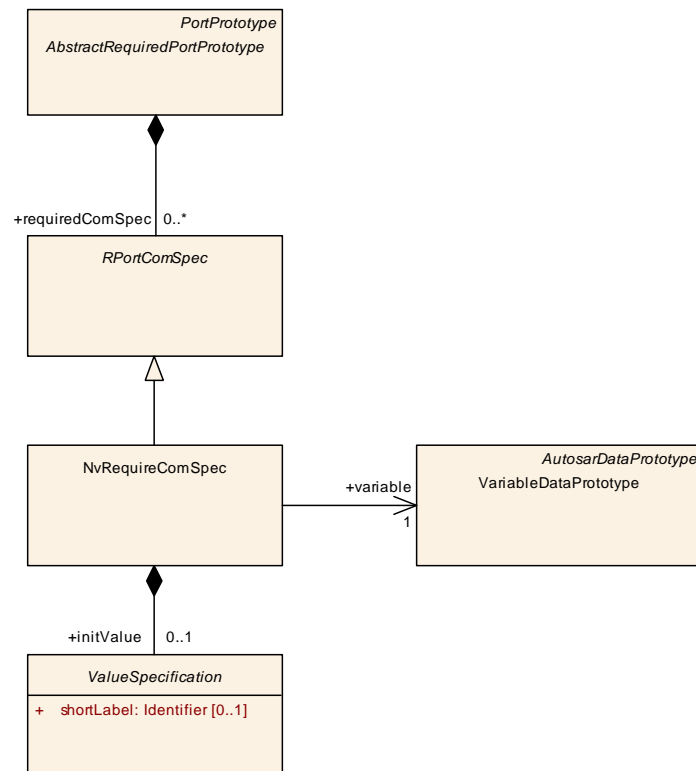

Figure 4.41: Communication attributes of a required `VariableDataPrototypes` used in the context of an `NvDataInterface`

[TPS_SWCT_01754] `initValue` defined in the context of a `ComSpec` [Unless *[TPS_SWCT_01755]* applies, only the `initValue` defined in the context of a `NvRequireComSpec` is relevant for connections to the corresponding `PortPrototype`.

An `initValue` defined in the scope of a `VariableDataPrototype` shall be ignored anyway.] (*RS_SWCT_03225*)

⁷Note that it is assumed that only a subset of meta-classes that inherit from `AtomicSwComponentType` will actually apply for the definition of initial values for `nvData`. Most likely the `ApplicationSwComponentType` and the `SensorActuatorSwComponentType` will be candidates for using this feature but it will obviously not be reasonable for e.g. `NvBlockSwComponentType`.

[TPS_SWCT_01755] Duplicate existence of `initValue` in the context of a `PRPortPrototype` typed by an `NvDataInterface` [If an `initValue` is defined in a `NvRequireComSpec` owned by a `PRPortPrototype`, its value shall be ignored.

Instead, the `initValue` shall be taken from the `NvProvideComSpec.ramBlockInitValue`.] ([RS_SWCT_03225](#))

Class	NvRequireComSpec			
Package	M2::AUTOSARTemplates::SWComponentTemplate::Communication			
Note	Communication attributes of RPortPrototypes with respect to Nv data communication on the required side.			
Base	<i>ARObject</i> , <i>RPortComSpec</i>			
Attribute	Type	Mult.	Kind	Note
initValue	ValueSpecification	0..1	aggr	The initial value owned by the NvComSpec
variable	VariableDataPrototype	1	ref	The VariableDataPrototype the ComSpec applies for.

Table 4.83: NvRequireComSpec

[TPS_SWCT_01228] `NvProvideComSpec` [As communication with an `NvBlockSwComponentType` is in most cases bi-directional it is also necessary to consider role-specific communication attributes for `AbstractProvidedPortPrototypes` typed by an `NvDataInterface`. For this purpose the `NvProvideComSpec` is defined.

The main purpose of this kind of `ComSpec` is the definition of initial values for the `RAM Block` and the `ROM Block` that corresponds to an `nvData` defined in the context of the `NvDataInterface` used to type the given `AbstractProvidedPortPrototype`.] ([RS_SWCT_03225](#))

More information about `NvProvideComSpec` please refer to [Figure 4.42](#).

Note that these initial values can be taken as an input for designing an `NvBlockSwComponentType`, in particular the `ramBlocks` and `romBlocks` of `NvBlockDescriptors` owned by the `NvBlockSwComponentType`. Further details are explained in [Figure 11.9](#).

Also, note that the `romBlockInitValue` provided in the `NvProvideComSpec` does not necessarily have to be identical to the respective section within `romBlock` in the `NvBlockDescriptor`.

This could happen if an `NvBlockSwComponentType` is already existing and an `ApplicationSwComponentType` is connected to it. Finally, the `romBlock` inside the `NvBlockDescriptor` is the only relevant information for the RTE generation.

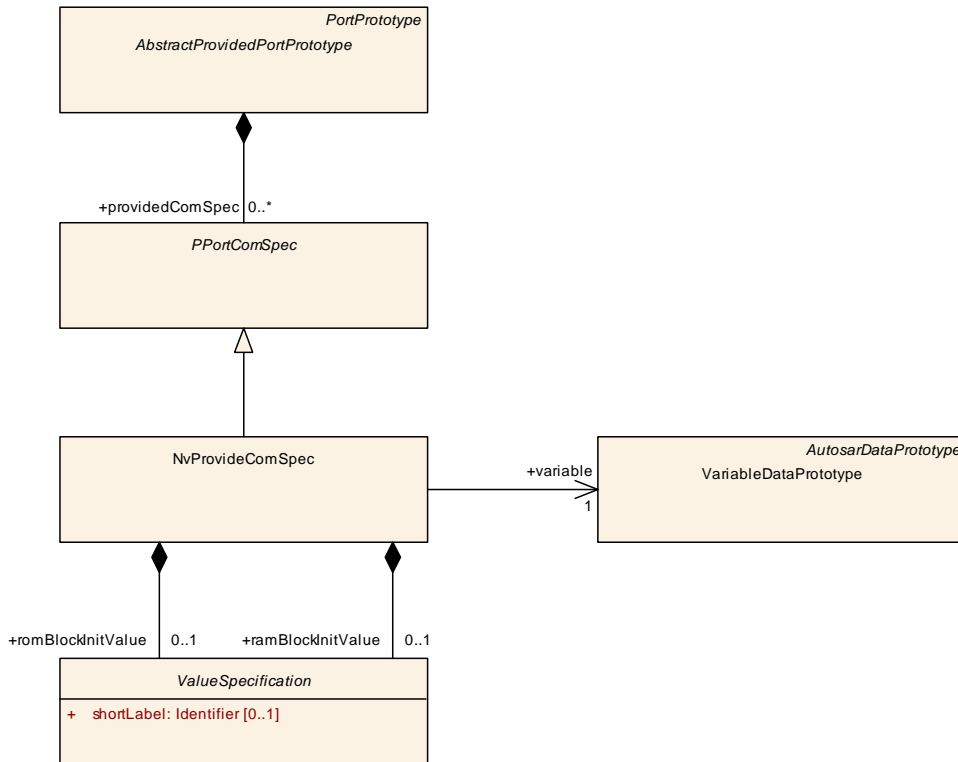

Figure 4.42: Communication attributes of a provided VariableDataPrototypes used in the context of an NvDataInterface

In other words, by means of the NvProvideComSpec the author of an ApplicationSwComponentType can express detailed requirements on the later design of a corresponding NvBlockSwComponentType.

Class	NvProvideComSpec			
Package	M2::AUTOSARTemplates::SWComponentTemplate::Communication			
Note	Communication attributes of PPortPrototypes with respect to Nv data communication on the provided side.			
Base	ARObject, PPortComSpec			
Attribute	Type	Mult.	Kind	Note
ramBlockInit Value	ValueSpecification	0..1	aggr	This represents the initial value of the RAM Block that corresponds to the referenced variable.
romBlockInit Value	ValueSpecification	0..1	aggr	This represents the initial value of the ROM block that corresponds to the referenced variable.
variable	VariableDataPrototype	1	ref	This represents the variable for which the ComSpec is specified.

Table 4.84: NvProvideComSpec

4.5.6 Configuration of Data Transformation

Using the TransformationComSpecProps it is possible to define configuration options for specific transformers of inter-ecu communication which is subject to data transformation.

[TPS_SWCT_01594] **Semantics of TransformationComSpecProps** [The definition of a TransformationComSpecProps can always be provided in the SWC description but the configuration shall **only** have an effect if

1. the actual communication involves at least two EcuInstances
2. the respective data transformer (given by the used TransformationComSpecProps) is used during data transformation (see DataTransformation)

](RS_SWCT_03221)

For clarification, the configuration given in TransformationComSpecProps will simply be ignored if the conditions defined by [TPS_SWCT_01594] do not apply.

[TPS_SWCT_01597] **PortPrototype-specific data transformation configuration** [Meta-class TransformationComSpecProps shall be used for the specification of PortPrototype-specific configuration options for data transformation of inter-ECU communication.](RS_SWCT_03221)

Please note that only some transformers offer PortPrototype-specific configuration (e.g. SOME/IP transformer doesn't have TransformationComSpecProps).

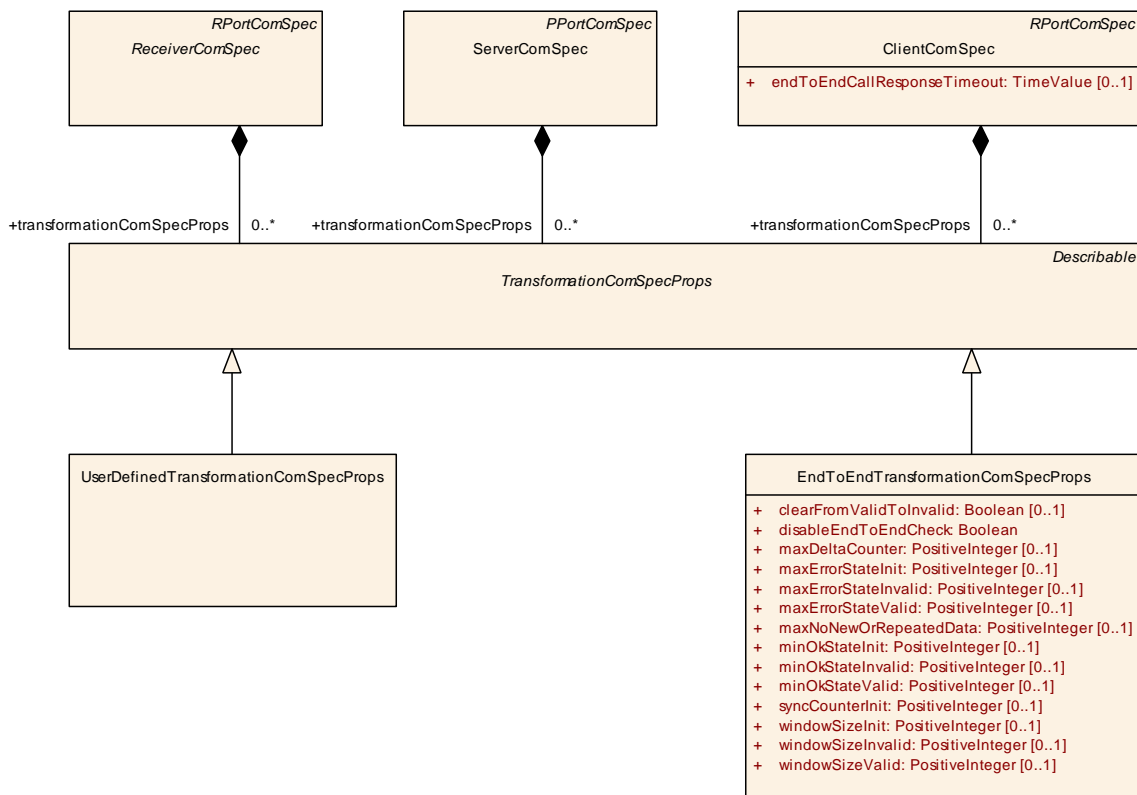

Figure 4.43: Specification of data transformation properties within ReceiverComSpec, ServerComSpec, and ClientComSpec

Class	<i>TransformationComSpecProps</i> (abstract)			
Package	M2::AUTOSARTemplates::SWComponentTemplate::Communication			
Note	TransformationComSpecProps holds all the attributes for transformers that are port specific.			
Base	<i>ARObject</i> , <i>Describable</i>			
Subclasses	EndToEndTransformationComSpecProps , UserDefinedTransformationComSpecProps			
Attribute	Type	Mult.	Kind	Note
–	–	–	–	–

Table 4.85: TransformationComSpecProps

It can be determined by the specific [TransformationComSpecProps](#) to which transformer this configuration is applicable:

- The configuration in [EndToEndTransformationComSpecProps](#) is applicable to E2E transformer ([protocol](#) of [TransformationTechnology](#) is set to End-ToEnd).
- The configuration in [UserDefinedTransformationComSpecProps](#) is applicable to a user-defined transformer.

[TPS_SWCT_01598] More than one user-defined transformer is used within one transformer chain [If more than one user-defined transformer is used within one transformer chain (defined by meta-class [TransformationTechnology](#)), the [UserDefinedTransformationComSpecProps](#) shall be assigned to the correct user-defined custom transformer in [TransformationTechnology](#).] ([RS_SWCT_03221](#))

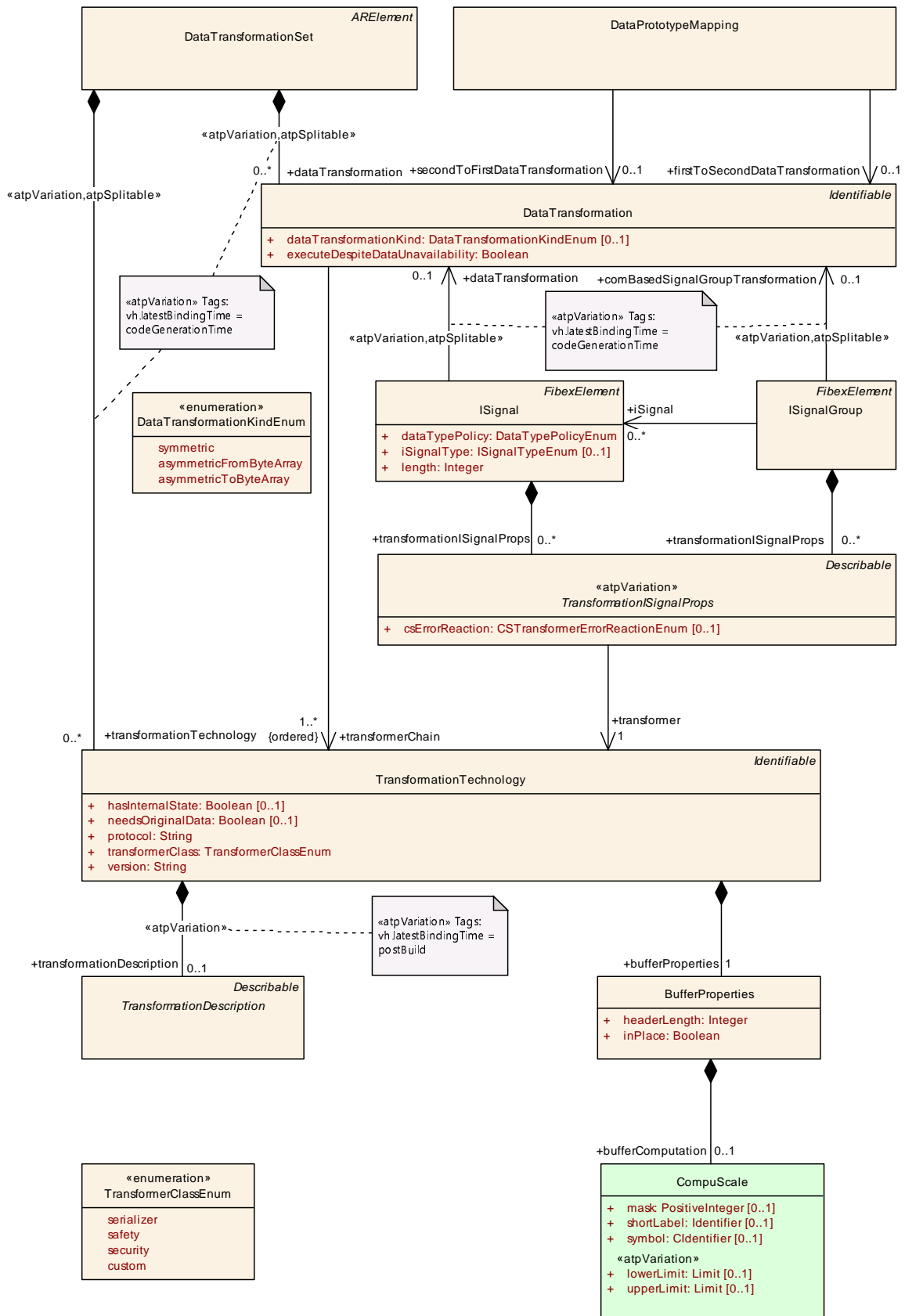

Figure 4.44: Big picture of data transformation in the AUTOSAR meta-model

[constr_1400] Reference to a specific [DataTransformation](#) [A specific [DataTransformation](#) shall only be referenced by either

- a [DataPrototypeMapping](#) in the role [firstToSecondDataTransformation](#) (and potentially [secondToFirstDataTransformation](#)) **or**
- an [ISignal](#) in the role [dataTransformation](#) **or**
- an [ISignalGroup](#) in the role [comBasedSignalGroupTransformation](#) **or**
- a [ClientServerOperationMapping](#) in the role [firstToSecondDataTransformation](#)

]()

[constr_1401] Restrictions on the relation between [DataPrototypeMapping](#) and [DataTransformation](#) [A [VariableDataPrototype](#) in the context of a [PortPrototype](#) shall **not** be referenced by a [DataPrototypeMapping](#) that references a [DataTransformation](#) while a [DataMapping](#) exists that points to this [VariableDataPrototype](#) (via the [SystemSignal](#)) that also refers to an [ISignal](#) that in turn references a [DataTransformation](#).]()

In other words: a [VariableDataPrototype](#) can either become a part of a [DataPrototypeMapping](#)-based data transformation or of an [ISignal](#)-based data transformation.

Please note that in a composite software structure the [VariableDataPrototype](#) can be delegated throughout the [CompositionSwComponentType](#) and **[constr_1401]** still applies.

Class	TransformationTechnology			
Package	M2::AUTOSARTemplates::SystemTemplate::Transformer			
Note	A TransformationTechnology is a transformer inside a transformer chain. Tags: xml.namePlural=TRANSFORMATION-TECHNOLOGIES			
Base	ARObject , Identifiable , MultilanguageReferrable , Referrable			
Attribute	Type	Mult.	Kind	Note
bufferProperties	BufferProperties	1	aggr	Aggregation of the mandatory BufferProperties.
hasInternalState	Boolean	0..1	attr	This attribute defines whether the Transformer has an internal state or not.
needsOriginalData	Boolean	0..1	attr	Specifies whether this transformer gets access to the SWC's original data.
protocol	String	1	attr	Specifies the protocol that is implemented by this transformer.
transformationDescription	TransformationDescription	0..1	aggr	A transformer can be configured with transformer specific parameters which are represented by the Transformer Description. Stereotypes: atpVariation Tags: vh.latestBindingTime=postBuild





Class	TransformationTechnology			
transformer Class	TransformerClassEnum	1	attr	Specifies to which transformer class this transformer belongs.
version	String	1	attr	Version of the implemented protocol.

Table 4.86: TransformationTechnology

Based on the user defined attributes inside [UserDefinedTransformationComSpecProps](#) (which are, of course, not standardized), the generator of the user-defined transformer shall determine to which user-defined transformer a [UserDefinedTransformationComSpecProps](#) belongs to.

Class	UserDefinedTransformationComSpecProps			
Package	M2::AUTOSARTemplates::SWComponentTemplate::Communication			
Note	The UserDefinedTransformationComSpecProps is used to specify port specific configuration properties for custom transformers.			
Base	ARObject , Describable , TransformationComSpecProps			
Attribute	Type	Mult.	Kind	Note
–	–	–	–	–

Table 4.87: UserDefinedTransformationComSpecProps

[TPS_SWCT_01599] PortPrototype-specific configuration for custom transformers [Meta-class [UserDefinedTransformationComSpecProps](#) shall be used for the specification of [PortPrototype](#)-specific configuration options for custom transformers.] ([RS_SWCT_03221](#))

Please note that it is possible to add custom configuration items in [UserDefinedTransformationComSpecProps](#) by means of the attribute [adminData.sdg](#).

Class	EndToEndTransformationComSpecProps			
Package	M2::AUTOSARTemplates::SystemTemplate::Transformer			
Note	The class EndToEndTransformationComSpecProps specifies port specific configuration properties for EndToEnd transformer attributes.			
Base	ARObject , Describable , TransformationComSpecProps			
Attribute	Type	Mult.	Kind	Note
clearFromValidToInvalid	Boolean	0..1	attr	Clear monitoring window on transition from state Valid to state Invalid.
disableEndToEndCheck	Boolean	1	attr	Disables/Enables the E2E check. The E2Eheader is removed from the payload independent from the setting of this attribute.
maxDeltaCounter	PositiveInteger	0..1	attr	Maximum allowed difference between two counter values of two consecutively received valid messages. For example, if the receiver gets data with counter 1 and MaxDeltaCounter is 3, then at the next reception the receiver can accept Counters with values 2, 3 or 4.





Class	EndToEndTransformationComSpecProps			
maxErrorState Init	PositiveInteger	0..1	attr	Maximal number of checks in which ProfileStatus equal to E2E_P_ERROR was determined, within the last Window Size checks, for the state E2E_SM_INIT. The minimum value is 0.
maxErrorState Invalid	PositiveInteger	0..1	attr	Maximal number of checks in which ProfileStatus equal to E2E_P_ERROR was determined, within the last Window Size checks, for the state E2E_SM_INVALID. The minimum value is 0.
maxErrorState Valid	PositiveInteger	0..1	attr	Maximal number of checks in which ProfileStatus equal to E2E_P_ERROR was determined, within the last Window Size checks, for the state E2E_SM_VALID. The minimum value is 0.
maxNoNewOr RepeatedData	PositiveInteger	0..1	attr	EndToEndTransformationDescription holds these attributes which are profile specific and have the same value for all E2E transformers.
minOkStateInit	PositiveInteger	0..1	attr	Minimal number of checks in which ProfileStatus equal to E2E_P_OK was determined, within the last WindowSize checks, for the state E2E_SM_INIT. The minimum value is 1.
minOkState Invalid	PositiveInteger	0..1	attr	Minimal number of checks in which ProfileStatus equal to E2E_P_OK was determined, within the last WindowSize checks, for the state E2E_SM_INVALID. The minimum value is 1.
minOkState Valid	PositiveInteger	0..1	attr	Minimal number of checks in which ProfileStatus equal to E2E_P_OK was determined, within the last WindowSize checks, for the state E2E_SM_VALID. The minimum value is 1.
syncCounterInit	PositiveInteger	0..1	attr	EndToEndTransformationDescription holds these attributes which are profile specific and have the same value for all E2E transformers.
windowSizeInit	PositiveInteger	0..1	attr	Size of the monitoring window of state Init for the E2E state machine.
windowSize Invalid	PositiveInteger	0..1	attr	Size of the monitoring window of state Invalid for the E2E state machine.
windowSize Valid	PositiveInteger	0..1	attr	Size of the monitoring window of state Valid for the E2E state machine.

Table 4.88: EndToEndTransformationComSpecProps

[TPS_SWCT_01600] **PortPrototype**-specific configuration for data transformers related to end-to-end protection [Meta-class [EndToEndTransformationComSpecProps](#) shall be used for the specification of [PortPrototype](#)-specific configuration options for data transformers related to end-to-end protection.] ([RS_SWCT_03221](#))

4.6 Port Groups within Component Types

[TPS_SWCT_01063] **PortGroup** [A [SwComponentType](#) can declare that some of its [PortPrototypes](#) belong to a [PortGroup](#).

Such a port group defines a logical grouping of [PortPrototypes](#) which is used as input to configure the implementation of mode managers in the basic software, for

example the communication of bus signals associated with the grouped ports maybe suppressed in a certain mode.] ([RS_SWCT_03200](#), [RS_SWCT_03201](#))

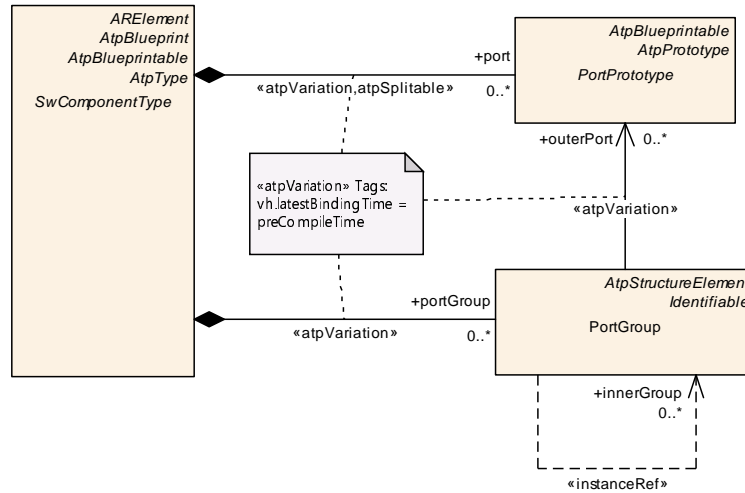

Figure 4.45: Declaration of **PortGroups**

Class	PortGroup			
Package	M2::AUTOSARTemplates::SWComponentTemplate::Components			
Note	Group of ports which share a common functionality, e.g. need specific network resources. This information shall be available on the VFB level in order to delegate it properly via compositions. When propagated into the ECU extract, this information is used as input for the configuration of Services like the Communication Manager. A PortGroup is defined locally in a component (which can be a composition) and refers to the "outer" ports belonging to the group as well as to the "inner" groups which propagate this group into the components which are part of a composition. A PortGroup within an atomic SWC cannot be linked to inner groups.			
Base	ARObject, AtpClassifier, AtpFeature, AtpStructureElement, Identifiable , MultilanguageReferrable , Referrable			
Attribute	Type	Mult.	Kind	Note
innerGroup	PortGroup	*	iref	Links a PortGroup in a composition to another PortGroup, that is defined in a component which is part of this CompositionSwComponentType.
outerPort	PortPrototype	*	ref	Outer PortPrototype of this AtomicSwComponentType which belongs to the group. A port can belong to several groups or to no group at all. Stereotypes: atpVariation Tags: vh.latestBindingTime=preCompileTime

Table 4.89: **PortGroup**

[[TPS_SWCT_01064](#)] **PortGroups** have to be defined on the VFB level [Though the declaration [PortGroups](#) is not relevant for the RTE, they have to be defined on the VFB level, because they represent design decisions taken on this level.

Accordingly, [PortGroups](#) can be defined for [CompositionSwComponentTypes](#) as well as for [AtomicSwComponentTypes](#).] ([RS_SWCT_03200](#), [RS_SWCT_03201](#))

[[TPS_SWCT_01065](#)] **PortPrototype** may belong to more than one **PortGroups** [A [PortPrototype](#) may belong to more than one [PortGroups](#) and [PortGroups](#) can be associated with the "inner" [PortGroups](#) of [SwComponentPrototypes](#) which are aggregated by the same [SwComponentType](#) as the [PortGroup](#).

By this, `PortGroups` can be locally defined but still traced down the component hierarchy.]([RS_SWCT_03200](#), [RS_SWCT_03201](#))

[TPS_SWCT_01066] `PortGroups` can be associated with certain `ServiceNeeds`
[`PortGroups` can be associated with certain `ServiceNeeds` in order to trace the information down to the configuration of the basic software.]([RS_SWCT_03200](#), [RS_SWCT_03201](#))

For more details, see chapter [7.11.2](#).

[constr_1147] Standardized values for the attribute `category` of meta-class `PortGroup` [

The following values of the attribute `category` of meta-class `PortGroup` are reserved by the AUTOSAR standard:

- `MODE_MANAGEMENT`: This represents the usage of the `PortGroup` for the purpose of mode management
- `PARTIAL_NETWORKING`: This represents the usage of the `PortGroup` for the purpose of partial networking

]()

4.7 End to End Protection

The aspect of end-to-end protection has seen different support by the AUTOSAR meta-model.

On the one hand, there is the definition of dedicated meta-classes, e.g. `EndToEndDescription`, which aim at an implementation that uses a so-called E2E wrapper (an approach with a software component above RTE invoking the E2E library) or AUTOSAR Com module callout mechanism (with Com callouts used to invoke E2E library).

This approach is documented in chapter [4.7](#) of this document.

As an alternative approach, it is possible to implement end-to-end protection using so-called data transformers.

The detailed description of how this approach can be configured is beyond the scope of this document. Please refer to the TPS System Template [10] where the details of the alternative approach are explained.

In contrast to the approach based on the `EndToEndProtection` and `EndToEndDescription` (which partly involves technologies that are not subjected to the AUTOSAR standard), the second approach is fully standardized by AUTOSAR.

As described in [19], there are cases where safety-related software-components protect the data exchanged between each other. For this purpose modeling support is provided by the software-component template.

Note that several end-to-end profiles are selectable for a specific application. The specific end-to-end profile is represented by the attribute `category` of meta-class `EndToEndDescription`.

Semantically, the `category` value represents an identification of the specific end-to-end profile applicable for the communication of the corresponding data element. According to [19] there are two pre-defined profiles that can be used.

[TPS_SWCT_01089] end-to-end communication protection [The information specific to each profile is expressed by the set of attributes of `EndToEndDescription` owned by `EndToEndProtection` in the role `endToEndProfile`.] (*RS_SWCT_03240*)

Class	EndToEndDescription			
Package	M2::AUTOSARTemplates::SWComponentTemplate::EndToEndProtection			
Note	This meta-class contains information about end-to-end protection. The set of applicable attributes depends on the actual value of the category attribute of EndToEndProtection.			
Base	ARObject			
Attribute	Type	Mult.	Kind	Note
category	NameToken	1	attr	The category represents the identification of the concrete E2E profile. The applicable values are specified in a semantic constraint and determine the applicable attributes of EndToEndDescription. Tags: xml.sequenceOffset=-100
counterOffset	PositiveInteger	0..1	attr	Bit offset of Counter from the beginning of the Array representation of the Signal Group/VariableDataPrototype (MSB order, bit numbering: bit 0 is the least important). The offset shall be a multiplicity of 4 and it should be 8 whenever possible. For example, offset 8 means that the counter will take the low nibble of the byte 1, i.e. bits 8 .. 11. If counterOffset is not present the value is defined by the selected profile. Tags: xml.sequenceOffset=-50
crcOffset	PositiveInteger	0..1	attr	Bit offset of CRC from the beginning of the Array representation of the Signal Group/VariableDataPrototype (MSB order, bit numbering: bit 0 is the least important). The offset shall be a multiplicity of 8 and it should be 0 whenever possible. For example, offset 8 means that the CRC will take the byte 1, i.e. bits 8..15. If crcOffset is not present the value is defined by the selected profile. Tags: xml.sequenceOffset=-60
dataId (ordered)	PositiveInteger	*	attr	This represents a unique numerical identifier. Note: ID is used for protection against masquerading. The details concerning the maximum number of values (this information is specific for each E2E profile) applicable for this attribute are controlled by a semantic constraint that depends on the category of the EndToEnd Protection. Tags: xml.sequenceOffset=-90





Class	EndToEndDescription			
dataIdMode	PositiveInteger	0..1	attr	<p>There are three inclusion modes how the implicit two-byte Data ID is included in the one-byte CRC:</p> <ul style="list-style-type: none"> • dataIdMode = 0: Two bytes are included in the CRC (double ID configuration) This is used in variant 1A. • dataIdMode = 1: One of the two bytes byte is included, alternating high and low byte, depending on parity of the counter (alternating ID configuration). For even counter low byte is included; For odd counters the high byte is included. This is used in variant 1B. • dataIdMode = 2: Only low byte is included, high byte is never used. This is applicable if the IDs in a particular system are 8 bits. • dataIdMode = 3: The low byte is included in the implicit CRC calculation, the low nibble of the high byte is transmitted along with the data (i.e. it is explicitly included), the high nibble of the high byte is not used. This is applicable for the IDs up to 12 bits. <p>Tags:xml.sequenceOffset=-85</p>
dataIdNibbleOffset	PositiveInteger	0..1	attr	<p>Bit offset of the low nibble of the high byte of Data ID. The applicability of this attribute is controlled by [constr_1261].</p> <p>Tags:xml.sequenceOffset=-25</p>
dataLength	PositiveInteger	0..1	attr	<p>This attribute represents the length of the Array representation of the Signal Group/VariableDataPrototype including CRC and Counter in bits.</p> <p>Tags:xml.sequenceOffset=-80</p>
maxDeltaCounterInit	PositiveInteger	0..1	attr	<p>Initial maximum allowed gap between two counter values of two consecutively received valid Data, i.e. how many subsequent lost data is accepted. For example, if the receiver gets Data with counter 1 and MaxDeltaCounter Init is 1, then at the next reception the receiver can accept Counters with values 2 and 3, but not 4.</p> <p>Note that if the receiver does not receive new Data at a consecutive read, then the receiver increments the tolerance by 1.</p> <p>Tags:xml.sequenceOffset=-70</p>
maxNoNewOrRepeatedData	PositiveInteger	0..1	attr	<p>The maximum amount of missing or repeated Data which the receiver does not expect to exceed under normal communication conditions.</p> <p>Tags:xml.sequenceOffset=-40</p>
syncCounterInit	PositiveInteger	0..1	attr	<p>Number of Data required for validating the consistency of the counter that shall be received with a valid counter (i.e. counter within the allowed lock-in range) after the detection of an unexpected behavior of a received counter.</p> <p>Tags:xml.sequenceOffset=-30</p>

Table 4.90: EndToEndDescription

[TPS_SWCT_01090] **EndToEndProtection** [EndToEndProtection is the Identifiable class that owns specific elements for referencing the to-be-protected data elements and signals

- `EndToEndProtectionVariablePrototype`: a specific `dataElement` owned by a specific `PortPrototype`
- `EndToEndProtectionISignalIPdu`: a specific `ISignalGroup` in the context of an `ISignalIPdu`. For more details please refer to [10]

]([RS_SWCT_03240](#))

[TPS_SWCT_01091] Two cases for end-to-end protection [In order to protect a `VariableDataPrototype` the `EndToEndProtectionVariablePrototype` shall be defined. If communication is defined between ECUs using AUTOSAR COM the `EndToEndProtectionISignalIPdu` shall be defined as well.]([RS_SWCT_03240](#))

The following features apply:

- **[constr_1000] End-to-end protection is limited to sender/receive communication** [end-to-end protection applies for sender/receiver communication only] ()
- The value of the `dataId` is assigned by a central authority rather than by the developer of the software-component.
- The information about the `dataId` shall be available at both the sender and the receiver(s).
- **[constr_1001] Value of `dataId` shall be unique** [The value of the `dataId` shall be unique within the scope of the `System`.] ()
- **[TPS_SWCT_01508] Scope of end-to-end protection** [End-to-end protection applies to local (i.e. within the ECU) as well as remote (i.e. ECU to ECU) communication.]([RS_SWCT_03240](#))

[TPS_SWCT_01092] `EndToEndProtectionSet` [The meta-class `EndToEndProtectionSet` provides a container for `EndToEndProtection`. The aggregation is stereotyped `<<atpSplitable>>` because the information about end-to-end protection is added at a later step in the development workflow.]([RS_SWCT_03240](#))

It also has the stereotype `<<atpVariation>>` because this allows for implementing the software-component in two variants, one that uses end-to-end protection and one that does not use it. It also might happen that the communication ends themselves are variant.

`EndToEndProtection` maintains `InstanceRefs` to one `dataElement` in the role of `sender` and to one or many `dataElements` in the role of `receiver`. By this means it is possible to support a 1:n communication scenario.

[TPS_SWCT_01093] Definition of end-to-end protection is splitable [`EndToEndProtection` aggregates `EndToEndDescription` using stereotype `<<atpSplitable>>`].

By this means it is for the integrator of an ECU possible to generally specify the nature of a specific end-to-end protection but leave the actual assignment of values (e.g. for `dataId`) to a later process step.] ([RS_SWCT_03240](#))

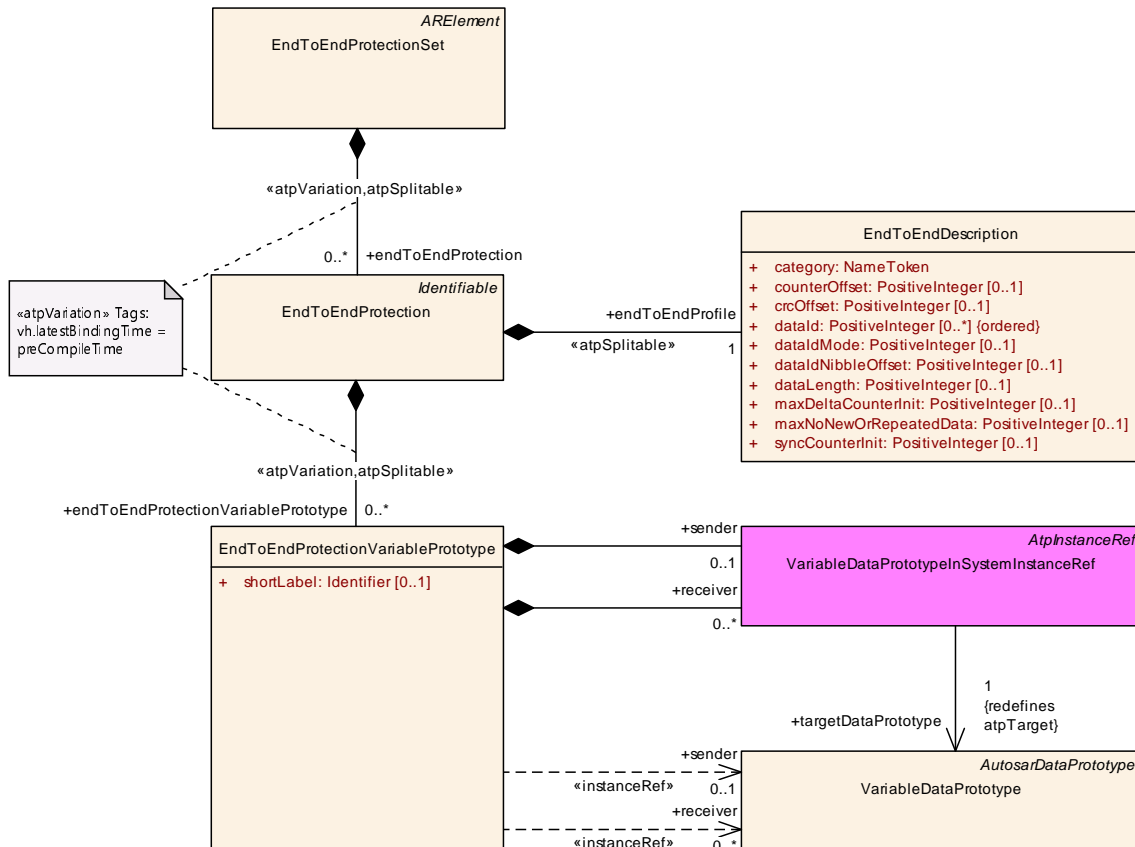

Figure 4.46: Details of the modeling of end-to-end protection

According to [19] the following constraints apply on the attributes of `EndToEndProtection` (note that additional M1 constraints apply as described in [19]):

[constr_1110] Value of `category` in `EndToEndDescription` [The attribute `category` of `EndToEndDescription` can have the following values:

- NONE
- PROFILE_01
- PROFILE_02

]()

[TPS_SWCT_01094] `category` of `EndToEndDescription` [The values for the `category` of `EndToEndDescription` mentioned in [constr_1110] are standardized and reserved for being used in the way the AUTOSAR standard foresees.

In addition, it is positively possible to use other than the standardized values for the `category`.] ([RS_SWCT_03240](#))

This aspect will be clarified in more detail in later revisions of the AUTOSAR standard. For the time being, it shall be noted that the usage of other than the standardized values shall not create name clashes with future standardized values.

This can be achieved by using e.g. a company-specific prefix or suffix to the value of `category`.

The semantics of the `category`s is:

NONE this indicates that the E2E framework shall be enabled for the given `sender/receiver` respectively the given `iSignalIPdu`. The wrapper code shall be generated but it shall not invoke E2E library protection routines. E2E wrapper works as pass-through.

This may be used when a profile selection or profile options are not yet selected in a given system but it is required that the system can be built successfully under consideration of the E2E library. This would also be applicable for migrating from/to a system with/without E2E protection.

[TPS_SWCT_01095] category set to NONE [If attributes exist in the presence of the `category` being set to `NONE`, the attributes shall be ignored.] (*RS_SWCT_03240*)

PROFILE_01 This indicates that the settings of E2E profile 1 (that uses a SAE CRC8, implicit 16-bit data ID, and a 4 bit alive counter) apply.

[constr_1113] Existence of attributes in PROFILE_01 [In `PROFILE_01`, the following attributes shall exist:

- `dataLength`
- `dataId`

]()

Please note that the attribute `maxDeltaCounterInit` is also part of `PROFILE_01` but it does not necessarily have to exist provided that `ReceiverComSpec.maxDeltaCounterInit` exists.

[constr_1170] Interpretation of attribute maxDeltaCounterInit owned by EndToEndDescription [If `EndToEndProtection.endToEndProtectionVariablePrototype.receiver` is identical to the `RPortPrototype.requiredComSpec.dataElement` and `RPortPrototype.requiredComSpec.maxDeltaCounterInit` is defined then the value of `RPortPrototype.requiredComSpec.maxDeltaCounterInit` shall be preferred over the value of `EndToEndProtection.endToEndProfile.maxDeltaCounterInit`.

If the value of `category` of `EndToEndDescription` is set to `PROFILE_01` and either the described correspondence rule concerning the referenced `VariableDataPrototype` is not fulfilled or `RPortPrototype.requiredComSpec.maxDeltaCounterInit` is not defined then `EndToEndProtection.endToEndProfile.maxDeltaCounterInit` shall exist.]()

[constr_1111] Constraints of dataId in PROFILE_01 [In PROFILE_01, there shall be only one element in the set and the applicable range of values is [0 .. 65535].]()

[constr_1112] Constraints of dataIdMode in PROFILE_01 [In PROFILE_01, the applicable range of values for dataIdMode is [0 .. 3].]()

[constr_1114] Constraints of crcOffset in PROFILE_01 [In PROFILE_01, the applicable range of values for crcOffset is [0 .. 65535]. For the value of this attribute the constraint $value \bmod 4 = 0$ applies.]()

[constr_1115] Constraints of counterOffset in PROFILE_01 [In PROFILE_01, the applicable range of values for counterOffset is [0 .. 65535]. For the value of this attribute the constraint $value \bmod 4 = 0$ applies.]()

[constr_1116] Constraints of dataLength in PROFILE_01 [In PROFILE_01, the applicable range of values for dataLength is [0 .. 240]. For the value of this attribute the constraint $value \bmod 8 = 0$ applies.]()

[constr_1117] Constraints of maxDeltaCounterInit in PROFILE_01 [In PROFILE_01, the applicable range of values for EndToEndDescription.maxDeltaCounterInit and ReceiverComSpec.maxDeltaCounterInit is [0 .. 14].]()

[constr_1211] Constraints of maxNoNewOrRepeatedData in PROFILE_01 [In PROFILE_01, the applicable range of values for EndToEndDescription.maxNoNewOrRepeatedData and ReceiverComSpec.maxNoNewOrRepeatedData is [0 .. 14].]()

[constr_1212] Constraints of syncCounterInit in PROFILE_01 [In PROFILE_01, the applicable range of values for EndToEndDescription.syncCounterInit and ReceiverComSpec.syncCounterInit is [0 .. 14].]()

[constr_1215] Interpretation of attribute maxNoNewOrRepeatedData owned by EndToEndDescription in PROFILE_01 [If EndToEndProtection.endToEndProtectionVariablePrototype.receiver is identical to the RPortPrototype.requiredComSpec.dataElement **and** RPortPrototype.requiredComSpec.maxNoNewOrRepeatedData is defined **then** the value of RPortPrototype.requiredComSpec.maxNoNewOrRepeatedData **shall be preferred** over the value of EndToEndProtection.endToEndProfile.maxNoNewOrRepeatedData.

If the value of category of EndToEndDescription is set to PROFILE_01 **and either** the described correspondence rule concerning the referenced VariableDataPrototype is not fulfilled **or** RPortPrototype.requiredComSpec.maxNoNewOrRepeatedData is not defined **then** EndToEndProtection.endToEndProfile.maxNoNewOrRepeatedData **shall exist**.]()

[constr_1216] Interpretation of attribute `syncCounterInit` owned by `EndToEndDescription` in `PROFILE_01` [If `EndToEndProtection.endToEndProtectionVariablePrototype.receiver` is identical to the `RPortPrototype.requiredComSpec.dataElement` and `RPortPrototype.requiredComSpec.syncCounterInit` is defined then the value of `RPortPrototype.requiredComSpec.syncCounterInit` shall be preferred over the value of `EndToEndProtection.endToEndProfile.syncCounterInit`.

If the value of `category` of `EndToEndDescription` is set to `PROFILE_01` and either the described correspondence rule concerning the referenced `VariableDataPrototype` is not fulfilled or `RPortPrototype.requiredComSpec.syncCounterInit` is not defined then `EndToEndProtection.endToEndProfile.syncCounterInit` shall exist.]()

[constr_1261] Applicability for `EndToEndDescription.dataIdNibbleOffset` [`EndToEndDescription.dataIdNibbleOffset` shall be used only if `EndToEndDescription.dataIdMode` is set to the value 3 and at the same time `EndToEndDescription.category` is set to `PROFILE_01`.]()

[TPS_SWCT_01529] Default value for `EndToEndDescription.dataIdNibbleOffset` [If `EndToEndDescription.dataIdMode` is set to the value 3 and at the same time `EndToEndDescription.category` is set to the value `PROFILE_01` and `EndToEndDescription.dataIdNibbleOffset` is not specified, then the default value of 12 (bits) shall be assumed for the attribute `EndToEndDescription.dataIdNibbleOffset`.] (*RS_SWCT_03240*)

PROFILE_02 this indicates that the settings of E2E profile 2 apply.

[constr_1118] Existence of attributes in `PROFILE_02` [In `PROFILE_02`, only the following attributes shall exist:

- `dataLength`
- `dataId`

]()

Please note that the attribute `maxDeltaCounterInit` is also part of `PROFILE_01` but it does not necessarily have to exist provided that `ReceiverComSpec.maxDeltaCounterInit` exists.

[constr_1171] Interpretation of attribute `maxDeltaCounterInit` of `EndToEndDescription` [If `EndToEndProtection.endToEndProtectionVariablePrototype.receiver` is identical to the `RPortPrototype.requiredComSpec.dataElement` and `RPortPrototype.requiredComSpec.maxDeltaCounterInit` is defined then the value of `RPortPrototype.requiredComSpec.maxDeltaCounterInit` shall be preferred over the value of `EndToEndProtection.endToEndProfile.maxDeltaCounterInit`.

If the value of `category` of `EndToEndDescription` is set to `PROFILE_02` **and either** the described correspondence rule concerning the referenced `VariableDataPrototype` is not fulfilled **or** `RPortPrototype.requiredComSpec.maxDeltaCounterInit` is not defined **then** `EndToEndProtection.endToEndProfile.maxDeltaCounterInit` **shall exist.**]()

[constr_1119] Constraints of `dataLength` in `PROFILE_02` [In `PROFILE_02`, the applicable range of values for `dataLength` is [0 .. 65535]. For the value of this attribute the constraint *value mod 8 = 0* applies.]()

[constr_1120] Constraints of `dataId` in `PROFILE_02` [In `PROFILE_02`, there shall be exactly ordered 16 elements in the set and the applicable range of values is [0 .. 255].]()

[constr_1121] Constraints of `maxDeltaCounterInit` in `PROFILE_02` [In `PROFILE_02`, the applicable range of values for `EndToEndDescription.maxDeltaCounterInit` and `ReceiverComSpec.maxDeltaCounterInit` is [0 .. 15].]()

[constr_1213] Constraints of `maxNoNewOrRepeatedData` in `PROFILE_02` [In `PROFILE_02`, the applicable range of values for `EndToEndDescription.maxNoNewOrRepeatedData` and `ReceiverComSpec.maxNoNewOrRepeatedData` is [0 .. 15].]()

[constr_1214] Constraints of `syncCounterInit` in `PROFILE_02` [In `PROFILE_02`, the applicable range of values for `EndToEndDescription.syncCounterInit` and `ReceiverComSpec.syncCounterInit` is [0 .. 15].]()

[constr_1217] Interpretation of attribute `maxNoNewOrRepeatedData` owned by `EndToEndDescription` in `PROFILE_02` [If `EndToEndProtection.endToEndProtectionVariablePrototype.receiver` is identical to the `RPortPrototype.requiredComSpec.dataElement` **and** `RPortPrototype.requiredComSpec.maxNoNewOrRepeatedData` is defined **then** the value of `RPortPrototype.requiredComSpec.maxNoNewOrRepeatedData` **shall be preferred** over the value of `EndToEndProtection.endToEndProfile.maxNoNewOrRepeatedData`.

If the value of `category` of `EndToEndDescription` is set to `PROFILE_02` **and either** the described correspondence rule concerning the referenced `VariableDataPrototype` is not fulfilled **or** `RPortPrototype.requiredComSpec.maxNoNewOrRepeatedData` is not defined **then** `EndToEndProtection.endToEndProfile.maxNoNewOrRepeatedData` **shall exist.**]()

[constr_1218] Interpretation of attribute `syncCounterInit` owned by `EndToEndDescription` in `PROFILE_02` [If `EndToEndProtection.endToEndProtectionVariablePrototype.receiver` is identical to the `RPortPrototype.requiredComSpec.dataElement` **and** `RPortPrototype.requiredComSpec.syncCounterInit` is defined **then** the value of `RPortPrototype.requiredComSpec.syncCounterInit` **shall be preferred** over the value of `EndToEndProtection.endToEndProfile.syncCounterInit`.

If the value of `category` of `EndToEndDescription` is set to `PROFILE_02` and either the described correspondence rule concerning the referenced `VariableDataPrototype` is not fulfilled or `RPortPrototype.requiredComSpec.syncCounterInit` is not defined then `EndToEndProtection.endToEndProfile.syncCounterInit` shall exist. |()

Class	EndToEndProtectionSet			
Package	M2::AUTOSARTemplates::SWComponentTemplate::EndToEndProtection			
Note	This represents a container for collection EndToEndProtectionInformation. Tags: atp.recommendedPackage=EndToEndProtectionSets			
Base	ARElement , ARObject , CollectableElement , Identifiable , MultilanguageReferrable , PackageableElement , Referrable			
Attribute	Type	Mult.	Kind	Note
endToEndProtection	EndToEndProtection	*	aggr	This is one particular EndToEndProtection. Stereotypes: atpSplitable; atpVariation Tags: atp.Splitkey=shortName, variationPoint.shortLabel vh.latestBindingTime=preCompileTime

Table 4.91: EndToEndProtectionSet

Class	EndToEndProtection			
Package	M2::AUTOSARTemplates::SWComponentTemplate::EndToEndProtection			
Note	This meta-class represents the ability to describe a particular end to end protection.			
Base	ARObject , Identifiable , MultilanguageReferrable , Referrable			
Attribute	Type	Mult.	Kind	Note
endToEndProfile	EndToEndDescription	1	aggr	This represents the particular EndToEndDescription. Stereotypes: atpSplitable Tags: atp.Splitkey=endToEndProfile
endToEndProtectionISignalPdu	EndToEndProtectionISignalPdu	*	aggr	Defines to which ISignalIPdu - ISignalGroup pair this EndToEndProtection shall apply. In case several ISignalGroups are used to transport the data (e.g. fan-out in the RTE) there may exist several EndToEndProtectionISignalIPdu definitions. Stereotypes: atpSplitable; atpVariation Tags: atp.Splitkey=variationPoint.shortLabel vh.latestBindingTime=preCompileTime
endToEndProtectionVariablePrototype	EndToEndProtectionVariablePrototype	*	aggr	Defines to which VariableDataPrototypes in the roles of one sender and one or more receivers this EndToEndProtection applies. It shall be possible to aggregate several EndToEndProtectionVariablePrototype in case additional hierarchical decompositions are introduced subsequently. In this case one particular PortPrototype is split into multiple PortPrototypes and connectors, all representing the same data entity.





Class	EndToEndProtection			
				△ Stereotypes: atpSplittable; atpVariation Tags: atp.Splitkey=shortLabel, variationPoint.shortLabel vh.latestBindingTime=preCompileTime

Table 4.92: EndToEndProtection

Class	EndToEndProtectionVariablePrototype			
Package	M2::AUTOSARTemplates::SWComponentTemplate::EndToEndProtection			
Note	It is possible to protect the data exchanged between software components. For this purpose, for each communication to be protected, the user defines a separate EndToEndProtection (specifying a set of protection settings) and refers to a variableDataPrototype in the role of sender and to one or many variableDataPrototypes in the role of receiver. For details, see EndToEnd Library.			
Base	ARObject			
Attribute	Type	Mult.	Kind	Note
receiver	VariableDataPrototype	*	iref	This represents the receiver. Note that 1:n communication is supported for this use case.
sender	VariableDataPrototype	0..1	iref	This represents the sender. Can be optional if an ecu extract is provided and the sender is part of the extract.
shortLabel	Identifier	0..1	attr	This serves as part of the split key in case of more than one EndToEndProtectionVariablePrototype is aggregated in the bound model.

Table 4.93: EndToEndProtectionVariablePrototype

Please note that using end-to-end protection it is explicitly supported that one sender may correspond to one or more receivers.

[constr_1183] EndToEndProtectionVariablePrototypes aggregated by EndToEndProtection [All EndToEndProtectionVariablePrototypes aggregated by the same EndToEndProtection shall refer to the identical sender.]()

4.8 Partial Networking

[TPS_SWCT_01169] Support for partial networking [On the level of the Software Component Template, partial networking is supported by means of the concept of a “Virtual Function Cluster” (VFC).

The latter groups all communication on the VFB with respect to a given function. However, the conceptual idea of a Virtual Function Cluster is not represented in the meta-model as such.

Instead, PortGroups are used to specify the grouping of PortPrototypes to the higher conceptual level of a Virtual Function Cluster.] (RS_SWCT_03241, RS_SWCT_03201)

Please note that more information regarding the semantics of `PortGroups` can be found in chapter 4.6.

There are no restrictions regarding the structure of `PortGroup` definitions on M1. One `PortPrototype` may become a member of several `PortGroups`, thereby creating overlapping `PortGroups`.

[TPS_SWCT_01170] Purpose of Virtual Function Cluster [The purpose of Virtual Function Cluster within the Software Component Template mainly has three aspects:

1. assign `PortPrototypes` (non service related) of Sender Receiver or Client Server communication to Virtual Function Clusters.
2. control the behavior of the corresponding function in terms of whether it is required at a given point in time. This aspect is implemented by the concept of a **control port**. Software-components that implement control ports of a Virtual Function Cluster conceptually become **VFC Controllers**.
3. allow for the application software to retrieve the status of a given Virtual Function Cluster. This aspect is implemented by the concept of a **status port**.

]([RS_SWCT_03241](#))

The usage of the generic concept of `PortGroups` for the purpose of partial networks shall be indicated by setting the value of the attribute `category` of `PortGroup` to `PARTIAL_NETWORKING`, see [[constr_1147](#)].

4.8.1 VFC Control Ports

[TPS_SWCT_01171] Purpose of a control port [The purpose of a control port is to request or release a VFC. Requesting means that the VFC is actively using communication resources while *release* boils down to the VFC being inactive, i.e. the corresponding partial network may be shut down until further notice.

As the requesting and releasing semantics is implemented by means of interfacing the BSW the corresponding control ports need to be typed by a `PortInterface` that has the attribute `isService` set to `true`.]([RS_SWCT_03241](#))

[TPS_SWCT_01172] Requesting and releasing partial networks [For requesting and releasing partial networks, the BSW can be interfaced in two alternative (i.e. either one or the other) ways:

- **ComM:** `ClientServerInterface` using the standardized `ComM_UserRequest.RequestComMode` [20]
- **BswM:** `SenderReceiverInterface` using the standardized `AppModeRequestInterface.requestedMode` [14]

]([RS_SWCT_03241](#))

[TPS_SWCT_01173] **Control port shall not become a part of the `PortGroup`**
[Please note that the control port shall **not** become a part of the `PortGroup` that defines the particular VFC the control port is going to service.

The relationship is implemented by means of a specific `SwcServiceDependency` that owns a `RoleBasedPortAssignment` to the intended control port **and** refers to a `PortGroup` (that comprises the VFC) in the role `representedPortGroup`.] ([RS_SWCT_03241](#), [RS_SWCT_03201](#))

For further information, please refer to [TPS_SWCT_01126].

4.8.2 VFC Status Ports

[TPS_SWCT_01175] **Actively query the status of a partial network** [Very much like mode management, the concept of partial networking supports the ability to actively query the status of a partial network.

This can be done by means of interfacing the BSW in three alternative (as in “one of”) ways:

- **ComM:** `ClientServerInterface` using the standardized `ComM_UserRequest.GetCurrentComMode` [20]
- **ComM:** `ModeSwitchInterface` using the standardized `ComM_CurrentMode.currentMode` [20]
- **BswM:** `ModeSwitchInterface` using the standardized `AppModeInterface.currentMode` [14]

] ([RS_SWCT_03241](#))

As mentioned above, the status of the ComM can be retrieved by either a `ClientServerInterface` or a `SenderReceiverInterface`. Which of the two alternatives applies in a specific case is up to the author of a software-component⁸.

When using one of the possible `SenderReceiverInterfaces`, the correspondence of the status port concept with mode management extends to the point that the status of the partial network is returned as an actual `ModeDeclaration`.

This implies that all mechanisms foreseen by the Software Component Template to react on mode changes are in place and can be used within the application software.

To assure that the communication via `PortPrototypes` that belong to a partial network is valid the software component shall consider the status of the partial network before communicating in order to assert its activity.

⁸The usage of the `ClientServerInterface` effectively implements a “pull” approach for the mode information while the usage of the `SenderReceiverInterface` resembles a “push” approach if it is used in combination with a `SwcModeSwitchEvent`.

[TPS_SWCT_01174] **Status port shall not become a member of the `PortGroup`**
[A status port shall **not** become a member of the `PortGroup` that corresponds to the partial network subject to the status port.

The relationship is implemented by means of a specific `SwcServiceDependency` that owns a `RoleBasedPortAssignment` to the intended status port **and** refers to a `PortGroup` (that comprises the VFC) in the role `representedPortGroup`.] ([RS_SWCT_03241](#), [RS_SWCT_03201](#))

For further information, please refer to [[TPS_SWCT_01126](#)].

4.9 Formal Definition of implicit Communication Behavior

[TPS_SWCT_01509] **Implicit communication behavior** [The purpose of the formal definition of the behavior of a `SwComponentType` with respect to the *implicit* communication can conceptually condense to two basic aspects:

- **Stable** data during the execution of a group of `RunnableEntity`s. This means that all data values read by different `RunnableEntity`s are from the same age. Therefore, the value is not changing during the execution of the chain of `RunnableEntity`s.
- **Coherent** data consumption and propagation for a group of `DataPrototypes`. This means that a set of interdependent data values are from the same calculation iteration. Therefore, the set of values has to be propagated at once to `RunnableEntity`s requiring the complete result of the calculation. `RunnableEntity`s which are part of the calculation chain may still consume partly updated values.

] ([RS_SWCT_03065](#))

[TPS_SWCT_01481] **The meaning of the term *stability* with respect to `ConsistencyNeeds`** [The meaning of the term *stability* is that the values of a group of `VariableDataPrototypes` shall not change values during the execution of a group of `RunnableEntity`s.] ([RS_SWCT_03065](#))

[TPS_SWCT_01482] **The meaning of the term *coherence* with respect to `ConsistencyNeeds`** [The meaning of the term *coherence* means that the values of a group of `VariableDataPrototypes` shall not be read by receiving `RunnableEntity`s until all the producing `RunnableEntity`s are terminated.] ([RS_SWCT_03065](#))

In response to these goals the meta-model provides means to express the correlation between a group of `RunnableEntity`s and a group of `DataPrototypes`. These groups might be defined **hierarchically**.

The information (in terms of `ConsistencyNeeds`) can be defined primarily during the design of an `AtomicSwComponentType` but it is just as well possible to specify this `ConsistencyNeeds` during the definition of `CompositionSwComponentTypes`.

For example, the existence of stable data is typically expected for the execution of `RunnableEntities` of several `AtomicSwComponentTypes`.

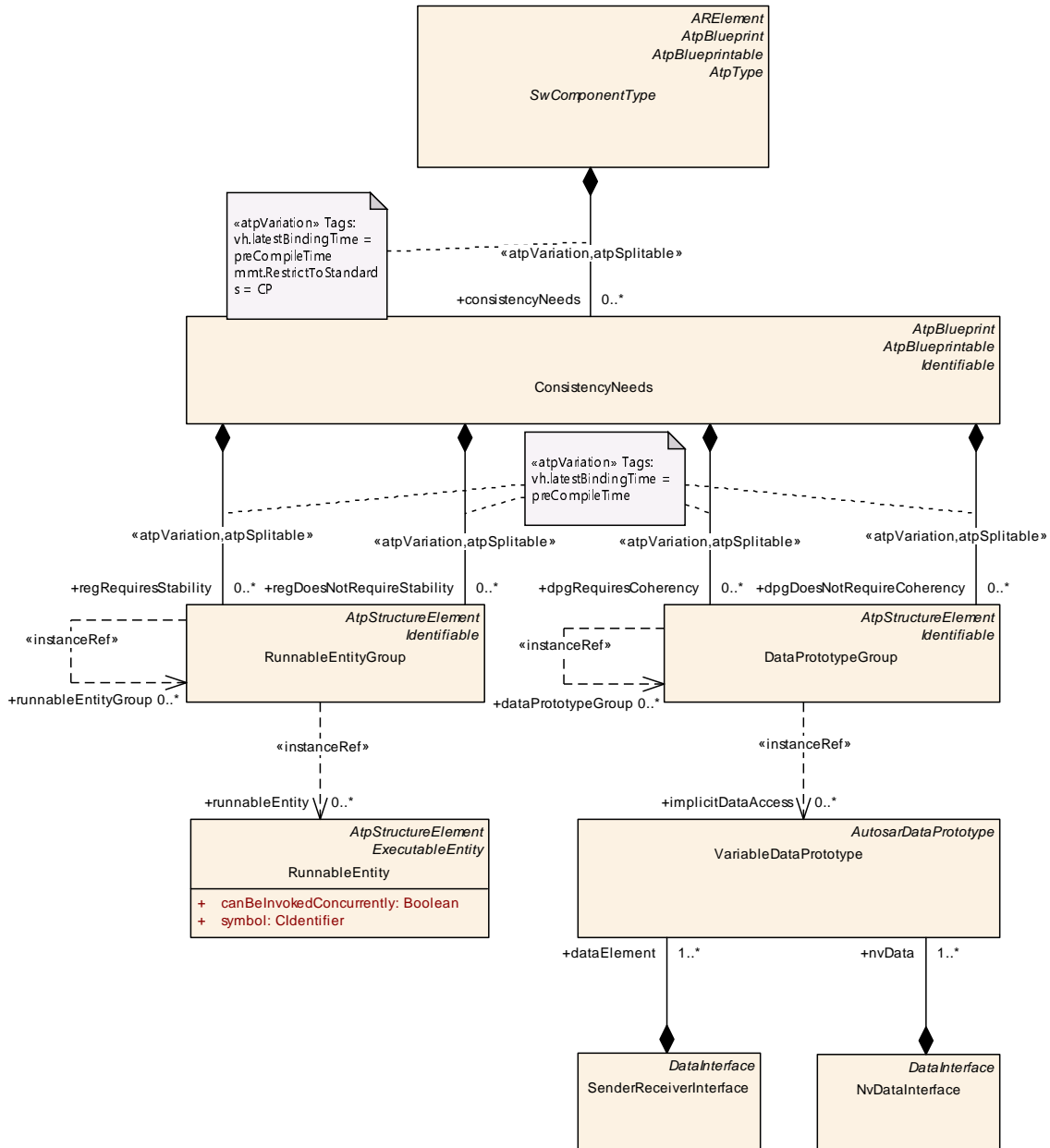

Figure 4.47: Formal definition of implicit communication behavior

Please note that the two aspects *stability* and *coherence* are not necessarily connected to each other. It is possible to require *stability* without *coherence* and vice versa. For this purpose the roles `dpgDoesNotRequireCoherency` and `regDoesNotRequireStability` are needed.

[TPS_SWCT_01480] Stability and/or coherence is not required [In order to be able to clearly separate the aspect of *stability* from *coherence* it is possible to use the roles `dpgDoesNotRequireCoherency` to express that a group of `VariableDataPrototypes` explicitly does not require *consistency*.

Likewise, `regDoesNotRequireStability` can be used to express that for a group of `RunnableEntity`s *stability* with respect to data access is not required.>()

[TPS_SWCT_01479] Applicability of `ConsistencyNeeds` [`ConsistencyNeeds` can only be applied to `RunnableEntity`s that make use of “implicit” communication.](*RS_SWCT_03065*)

[TPS_SWCT_01466] `ConsistencyNeeds` applied on `RunnableEntity`s that do not use implicit communication [If a `ConsistencyNeeds` is applied on `RunnableEntity`s that do not use implicit communication, it shall be ignored.](*RS_SWCT_03065*)

The formal definition of the implicit communication behavior foresees the grouping of model elements in order to indicate their relevance for consistent implicit communication.

[TPS_SWCT_01470] `RunnableEntityGroup` [A `RunnableEntity`s belongs to a specific `RunnableEntityGroup` if it is associated either directly with the given `RunnableEntityGroup` or if the `RunnableEntityGroup` the `RunnableEntity` belongs to is eventually (there can be more than one nesting level) referenced by the given `RunnableEntityGroup`.](*RS_SWCT_03065*)

[TPS_SWCT_01471] `DataPrototypeGroup` [A `VariableDataPrototypes` belongs to a specific `DataPrototypeGroup` if it is associated either directly with the given `DataPrototypeGroup` or if the `DataPrototypeGroup` the `VariableDataPrototype` belongs to is eventually (there can be more than one nesting level) referenced by the given `DataPrototypeGroup`.](*RS_SWCT_03065*)

[constr_1231] `ConsistencyNeeds` aggregated by `CompositionSwComponentType` [If `ConsistencyNeeds` are aggregated by a `CompositionSwComponentType` the associations stereotyped `<<instanceRef>>` may only refer to context and target elements within the context of this `CompositionSwComponentType`.]()

For clarification, [constr_1231] includes `VariableDataPrototypes` owned by delegation `PortPrototypes` of the owning `CompositionSwComponentType`, `VariableDataPrototypes` in delegation `PortPrototypes` of `CompositionSwComponentType` instantiated in the enclosing `CompositionSwComponentType`, or `VariableDataPrototypes` in `PortPrototypes` owned by `AtomicSwComponentTypes` instantiated inside the context of the enclosing `CompositionSwComponentType`.

[constr_1232] `ConsistencyNeeds` aggregated by `AtomicSwComponentType` [If `ConsistencyNeeds` are aggregated by a `AtomicSwComponentType` the associations stereotyped `<<instanceRef>>` may only refer to context and target elements within the context of this `AtomicSwComponentType`.]()

Strictly speaking, these are the `RunnableEntity`s and `PortPrototypes` of this particular `AtomicSwComponentType` or `RunnableEntityGroups` and `DataPrototypeGroups` which are owned by the same `AtomicSwComponentType`.

Please note that pre-defined values for the [category](#) of [RunnableEntityGroup](#) and [DataPrototypeGroup](#) are described in [1].

Class	ConsistencyNeeds			
Package	M2::AUTOSARTemplates::SWComponentTemplate::ImplicitCommunicationBehavior			
Note	This meta-class represents the ability to define requirements on the implicit communication behavior.			
Base	<i>ARObject, AtpBlueprint, AtpBlueprintable, Identifiable, MultilanguageReferrable, Referrable</i>			
Attribute	Type	Mult.	Kind	Note
dpgDoesNotRequireCoherency	DataPrototypeGroup	*	aggr	This group of VariableDataPrototypes does not require coherency with respect to the implicit communication behavior. Stereotypes: atpSplittable; atpVariation Tags: atp.Splitkey=shortName, variationPoint.shortLabel vh.latestBindingTime=preCompileTime
dpgRequiresCoherency	DataPrototypeGroup	*	aggr	This group of VariableDataPrototypes requires coherency with respect to the implicit communication behavior, i.e. all read and write access to VariableDataPrototypes in the DataPrototypeGroup by the RunnableEntities of the RunnableEntityGroup need to be handled in a coherent manner. Stereotypes: atpSplittable; atpVariation Tags: atp.Splitkey=shortName, variationPoint.shortLabel vh.latestBindingTime=preCompileTime
regDoesNotRequireStability	RunnableEntityGroup	*	aggr	This group of RunnableEntities does not require stability with respect to the implicit communication behavior. Stereotypes: atpSplittable; atpVariation Tags: atp.Splitkey=shortName, variationPoint.shortLabel vh.latestBindingTime=preCompileTime
regRequiresStability	RunnableEntityGroup	*	aggr	This group of RunnableEntities requires stability with respect to the implicit communication behavior, i.e. all read and write access to VariableDataPrototypes in the DataPrototypeGroup by the RunnableEntities of the RunnableEntityGroup need to be handled in a stable manner. Stereotypes: atpSplittable; atpVariation Tags: atp.Splitkey=shortName, variationPoint.shortLabel vh.latestBindingTime=preCompileTime

Table 4.94: ConsistencyNeeds

Class	RunnableEntityGroup			
Package	M2::AUTOSARTemplates::SWComponentTemplate::ImplicitCommunicationBehavior			
Note	This meta-class represents the ability to define a collection of RunnableEntities. The collection can be nested.			
Base	<i>ARObject, AtpClassifier, AtpFeature, AtpStructureElement, Identifiable, MultilanguageReferrable, Referrable</i>			
Attribute	Type	Mult.	Kind	Note





Class	RunnableEntityGroup			
runnableEntity	RunnableEntity	*	iref	This represents a collection of RunnableEntitys that belong to the enclosing RunnableEntityGroup. Stereotypes: atpVariation Tags: vh.latestBindingTime=preCompileTime
runnableEntity Group	RunnableEntityGroup	*	iref	This represents the ability to define nested groups of RunnableEntitys. Stereotypes: atpVariation Tags: vh.latestBindingTime=preCompileTime

Table 4.95: RunnableEntityGroup

Class	DataPrototypeGroup			
Package	M2::AUTOSARTemplates::SWComponentTemplate::ImplicitCommunicationBehavior			
Note	This meta-class represents the ability to define a collection of DataPrototypes that are subject to the formal definition of implicit communication behavior. The definition of the collection can be nested.			
Base	<i>ARObject, AtpClassifier, AtpFeature, AtpStructureElement, Identifiable, MultilanguageReferrable, Referrable</i>			
Attribute	Type	Mult.	Kind	Note
dataPrototype Group	DataPrototypeGroup	*	iref	This represents the ability to define nested groups of VariableDataPrototypes. Stereotypes: atpVariation Tags: vh.latestBindingTime=preCompileTime
implicitData Access	VariableDataPrototype	*	iref	This represents a collection of VariableDataPrototypes that belong to the enclosing DataPrototypeGroup Stereotypes: atpVariation Tags: vh.latestBindingTime=preCompileTime

Table 4.96: DataPrototypeGroup

4.9.1 Consistency Needs on Receiver Side

[TPS_SWCT_01472] Receiving [SwComponentType](#) owns a [DataPrototypeGroup](#) in the role [dpgRequiresCoherency](#) [If a receiving [SwComponentType](#) owns a [DataPrototypeGroup](#) in the role [dpgRequiresCoherency](#) for one or several of its [RunnableEntitys](#) it is required that [VariableDataPrototypes](#) belonging to the same [DataPrototypeGroup](#) are produced coherently. This means that the values of the [VariableDataPrototypes](#) shall be of the same age.]([RS_SWCT_03065](#))

[TPS_SWCT_01473] Receiving [SwComponentType](#) owns a [RunnableEntityGroup](#) in the role [regRequiresStability](#) [If a receiving [SwComponentType](#) owns a [RunnableEntityGroup](#) in the role [regRequiresStability](#) for one or several of its [RunnableEntitys](#) it is required that the values of implicitly communicated [VariableDataPrototypes](#) are kept stable over the execution of all [RunnableEntitys](#) belonging to the given [RunnableEntityGroup](#).]([RS_SWCT_03065](#))

[TPS_SWCT_01474] Receiving **SwComponentType** owns a **RunnableEntityGroup** in the role **regRequiresStability** and also owns one or several **DataPrototypeGroups** in the role **dpgRequiresCoherency** [If a receiving **SwComponentType** owns a **RunnableEntityGroup** in the role **regRequiresStability** and also owns one or several **DataPrototypeGroups** in the role **dpgRequiresCoherency** it is required that values of **VariableDataPrototypes** belonging to the same **DataPrototypeGroup** are produced coherently.

This means that the values of the **VariableDataPrototypes** shall be of the same age **and** are kept stable over the execution of all **RunnableEntities** belonging to the given **RunnableEntityGroup**.]()

4.9.2 Consistency Needs on Sender Side

[TPS_SWCT_01475] Sending **SwComponentType** owns a **DataPrototypeGroup** in the role **dpgRequiresCoherency** [If a sending **SwComponentType** owns a **DataPrototypeGroup** in the role **dpgRequiresCoherency** for one or several of its **RunnableEntities** it is required that **VariableDataPrototypes** belonging to the same **DataPrototypeGroup** are propagated at the same point of time to **RunnableEntities** which do not belong to the group of **producing RunnableEntities** (which may, but don't have to be formally described as a **RunnableEntityGroup**).](*RS_SWCT_03065*)

The coherence is created at the point in time when the **RunnableEntities** of the producing group of **RunnableEntities** terminate (and the implicit data get updated).

If those **RunnableEntities** are reading the data also, those read accesses will not read the coherent values but the intermediary values written by **RunnableEntities** of the same group.

For all other **RunnableEntities** that are not member of the producing group of **RunnableEntities** it appears as if the data have been updated at this very point coherently.

In order to avoid incorrect configurations its possible to explicitly define the group of **RunnableEntities** for which the coherency does not apply.

[TPS_SWCT_01625] Sending **SwComponentType** owns a **DataPrototypeGroup** in the role **dpgRequiresCoherency** and also **RunnableEntityGroups** [If a sending **SwComponentType** owns a **DataPrototypeGroup** in the role **dpgRequiresCoherency**, **RunnableEntityGroups** in the role **regDoesNotRequireStability** may exist.

Read accesses from **RunnableEntities** in those **RunnableEntityGroups** will not read the coherent values but the intermediary values written by **RunnableEntities** of the same group.](*RS_SWCT_03065*)

4.9.3 Consistency Needs for Senders and receivers of the same Data inside on RunnableEntityGroup

[TPS_SWCT_01476] **Sender and receiver of the same implicitly communicated VariableDataPrototypes are associated with the same RunnableEntityGroup** [For the case of sender and receiver of the same implicitly communicated VariableDataPrototypes are associated with the same RunnableEntityGroup [TPS_SWCT_01472], [TPS_SWCT_01473], [TPS_SWCT_01475] as well as [TPS_SWCT_01475] apply with the exception that updates of the values of implicitly communicated VariableDataPrototypes inside the given RunnableEntityGroup become visible **immediately** after the producing RunnableEntity was terminated.] (RS_SWCT_03065)

5 Data Description

5.1 Introduction

[TPS_SWCT_01229] **Three different levels of abstraction regarding the definition of data types** [In the context of defining data types and prototypes, the AUTOSAR concept distinguishes between three different levels of abstraction as depicted in Table 5.1.] ([RS_SWCT_03215](#), [RS_SWCT_03216](#), [RS_SWCT_03217](#))

Application Data Level
Implementation Data Level
Base Type Level

Table 5.1: Abstraction Levels for Describing Data

[TPS_SWCT_01230] **Application Data Level** [The *Application Data Level* is the common level at which [ApplicationSwComponentTypes](#) specify a data type or prototype.

This level allows to define all the data attributes which are needed from the application point of view, in order to exchange data between software components or between a software component and a measurement and calibration tool. It is possible to specify data communication of a complete `Virtual Function Bus` based on this level only.

This level includes among other things the numerical range of values, the data structure as well as the physical semantics.

Data semantics (e.g. physical units) is not in the focus¹ for the RTE in order to make communication technically possible.

However, it is important for a unique interpretation of data in the application software and in measurement and calibration systems.] ([RS_SWCT_03216](#))

Please note that [ApplicationDataTypes](#) – by virtue of being platform-independent by definition – do not become visible as data types in the code implementation of software-components.

In former version of this specification, this level was not clearly separated from the implementation level. These had the following drawbacks which are now solved:

- The model of primitive types (like integer, boolean, real, opaque) was anticipating implementation aspects already on a very high level of design.
- The data type model used within ports, focusing on communication via the RTE, was not sufficient to model all type-aspects of variables and parameters which are

¹There are some aspects that affect the RTE, e.g. scaling of [dataElements](#)

visible within an AUTOSAR system for other purposes than RTE-communication, namely NvM-data access, calibration, measurement, diagnostics, BSW-module interfaces. Using a uniform type system covering all these aspects is now favored.

- Calibration parameters were not completely incorporated into the data type concept. Some of their attributes (especially for curves and maps) could be specified only on the level of prototypes or were not completely formalized within AUTOSAR (like [SwRecordLayout](#)).
- The data type system was not compatible with the usage in calibration standards like ASAM-MCD (namely the usage of [categorys](#)).
- Adding implementation specific elements like a base type, was not possible without formally changing the data type used in a VFB design. A mapping mechanism that could be used in later project phases and is common in other parts of AUTOSAR (e.g. for mapping components to ECUs) was missing.
- The RTE Specification contained many default rules and assumptions on how to implement certain data types or prototypes in C. With a more formal description of all relevant implementation aspects, the generation of C-interfaces is better determined. But these aspects should be separated from the application level design.
- Since there could be many data types on the application level in a big system, the probability of name clashes in the interfaces to the RTE was rather high. Using a separate set of types to implement the RTE interfaces solves this issue.

[TPS_SWCT_01231] Application level may impose strong requirements on the design of the corresponding implementation level [It should be pointed out, that with the specification of computation methods and record layouts, the application level imposes strong requirements on the design of the corresponding implementation level. It might even be the case, that when anticipating different implementations, these elements might be chosen differently.

This is due to the nature of these elements which form a bridge from the physical world to the numerical representation (and vice versa). Nonetheless, we consider the specification of these elements as belonging to the application level.

On the one hand, this information is required by MCD-tools and thus shall be part of a rather high-level design. On the other hand, this approach will allow to use a limited set of implementation data types.] ([RS_SWCT_03215](#), [RS_SWCT_03216](#), [RS_SWCT_03217](#))

Further information about the compatibility requirements between application level and implementation level can be found in section [6.2.5](#).

[TPS_SWCT_01232] Implementation Data Level [The *Implementation Data Level* is closer to the actual code implementation in a programming language like C, though it is still an abstraction of the code.

Its values correspond to the actual binary numbers handled by the programming language on the CPU. It contains concepts like pointers and unions which relate to the organization of data in memory and are not relevant for the application level.

This level also defines structure, but it can be more granular. For example, the application level may define a text to be transferred to an instrument cluster as a primitive type (if the structure is not relevant for the application), whereas on the implementation level it could be modeled as an array of bytes.]([RS_SWCT_03217](#))

[TPS_SWCT_01233] Use case for the Implementation Data Level [There are several use cases for this level in AUTOSAR:

- First, the *Implementation Data* level can be used in the description of interfaces, and data (e.g. debug data) within the basic software, see [6] for more details on these use cases.
- `ImplementationDataTypes` should also be used to describe the interfaces of libraries which operate on a purely numerical level.
- *Implementation Data* is also used for the description of interfaces between software-components and the basic software (namely AUTOSAR Services), because these typically cover implementation aspects only.
- It is possible to define communication in a VFB system directly on this level if the physical and semantical abstraction is not of interest.
- Last not least the input for the RTE generator is defined by data descriptions on this level. This means that in case a SWC defines its data only on application level a corresponding set of implementation data types shall be created (or generated) as part of the ECU extract before the RTE can be generated.

]([RS_SWCT_03217](#))

[TPS_SWCT_01234] Base Level [The ***Base Type Level*** is used to describe the primitive elements in terms of bits and bytes from which the implementation data is built up. It is considered as a separate level in order to allow for reuse of the basic types defined on this level.

These base types still do not completely determine the actual implementation on a programming language, but they impose strong restrictions for this as they define for example the number of bits and bytes to be used.

Depending on the use case, the base types can be defined as platform independent or can also contain platform specific attributes (namely endianness and alignment).]()

[TPS_SWCT_01235] Mapping of data defined on the *Application* level to the *Implementation* and *Base Type* level [It is important to understand, that the mapping of data defined on the *Application* level to the *Implementation* and *Base Type* level depends on the medium on which the data is transported.

For example, if a physical value can be expressed with sufficient accuracy and range by a 16-bit unsigned integer, it still might look very different when sent over CAN, when

seen by a software-component on a *big-endian* 32-bit machine or when seen by a software-component on a *little-endian* 16-bit processor.

Conversion between several data implementations of the same application data type might be necessary in case of communication between components on different ECUs. AUTOSAR COM [21] is responsible for this.

It implies that the configuration depends on the definition of the data that are transmitted between components².] ([RS_SWCT_03215](#), [RS_SWCT_03216](#), [RS_SWCT_03217](#))

AUTOSAR COM might need to convert a 16-bit integer between *little-endian* and *big-endian* representations; whereas an array of 16 bytes does not need to be swapped even if the endianness changes. In case of intra-ECU communication byte order conversion is not necessary, since the software-components reside on the same machine.

[TPS_SWCT_01236] Big picture of data types [Another way of approaching the concept of data types in AUTOSAR (especially with respect to the question of what “kind” of data type is related to which modeling meta-level) is to sketch the following “big picture” of data types:

ApplicationDataType Defined on **M2** - provides the meta model for data types on application level. It covers the application-relevant aspects of a data type.

An [ApplicationDataType](#) shall finally be mapped to an [ImplementationDataType](#).

ImplementationDataType Defined on **M2** - provides the meta-model for data types on implementation level. With respect to C source code, an [ImplementationDataType](#) finally boils down to a `typedef`.

BaseType Defined on **M2** - provides the platform-dependent part of an [ImplementationDataType](#). the dependency on the platform covers the following aspects:

- Definition on the level of the C language - using [nativeDeclaration](#)
- Technical representation on the target platform (byte order, alignment, encoding) as required for the support of MCD systems.

Platform Data Type Defined on **M1** - provided by AUTOSAR. Platform types shall be available on each platform on which an AUTOSAR-System can run.

The name of the [Platform Data Type](#) and the properties with respect to the interface between modules / components is the same on every platform.

The particular representation varies from platform to platform.

[Platform Data Types](#) shall be **modeled** using [ImplementationDataTypes](#).

²More exactly speaking, the data shall be converted to and from a so-called [SystemSignal](#).

Note that in AUTOSAR R3.x the platform types are implemented manually and could even not be expressed on ARXML model (see [SRS_Rte_00150]). In AUTOSAR R4.1 the [Platform Data Types](#) can be represented in the ARXML model. Subsequent releases of AUTOSAR may generate the [Platform Data Types](#) directly from the ARXML Model.

Standard Type Defined on **M1** - provided by AUTOSAR. Standard types are defined by referring to platform types.

]([RS_SWCT_03215](#), [RS_SWCT_03216](#), [RS_SWCT_03217](#))

[**TPS_SWCT_01237**] [SwDataDefProps](#) [The properties of data are summarized in the meta-class [SwDataDefProps](#). This meta-class itself is the superset of all applicable properties.]([RS_SWCT_03216](#), [RS_SWCT_03217](#))

Subsets of [SwDataDefProps](#) are applicable in specific case, for a summary please refer to the following tables:

- The data [categorys](#) are summarized in table [5.6](#).
- Properties for [ApplicationDataTypes](#) are summarized in table [5.7](#).
- Properties for [ImplementationDataTypes](#) are summarized in table [5.17](#).
- Properties for [DataPrototypes](#) typed by [ApplicationDataTypes](#) are summarized in table [5.33](#).
- Properties for [DataPrototypes](#) typed by [ImplementationDataTypes](#) are summarized in table [5.34](#).
- Applicability of [SwDataDefProps](#) is summarized in table [5.41](#).

5.2 Data Types

5.2.1 Overview

As explained in section [5.1](#) it is possible to describe data provided by a software-component from the application as well as from the implementation point of view.

[**TPS_SWCT_01072**] [ApplicationDataType](#) and [ImplementationDataType](#) [The common concept behind this is expressed by the abstract meta-class [AutosarDataType](#), from which an [ApplicationDataType](#) and an [ImplementationDataType](#) is derived.]([RS_SWCT_03215](#), [RS_SWCT_03216](#), [RS_SWCT_03217](#))

Figure [5.1](#) shows a summary of the basic meta-classes used for the definition of [AutosarDataTypes](#).



Class	ApplicationDataType (abstract)			
Subclasses	ApplicationCompositeDataType , ApplicationPrimitiveDataType			
Attribute	Type	Mult.	Kind	Note
-	-	-	-	-

Table 5.3: ApplicationDataType

[TPS_SWCT_01073] Composite [ApplicationDataType](#) [An [ApplicationDataType](#) can be composed (in form of a record or an array) of elements which themselves are typed by another [ApplicationDataType](#).] ([RS_SWCT_03215](#), [RS_SWCT_03216](#))

[TPS_SWCT_01074] Composite [ImplementationDataType](#) [An [ImplementationDataType](#) can also be composed of elements but in this case no type/prototype concept (see [11]) has been applied. Both concepts will be explained in the following chapters in more detail.] ([RS_SWCT_03215](#), [RS_SWCT_03217](#))

5.2.2 Data Type Mapping

As explained above, the concept of application data types as well as that of implementation data types can be used to instantiate a data prototype in an M1 model. However, there are use cases, especially in order to generate the RTE contract for [ApplicationSwComponentTypes](#), where it is required to consider both levels for one given data prototype.

[TPS_SWCT_01189] [DataTypeMap](#) [This is supported by the meta-class [DataTypeMap](#) by which an [ApplicationDataType](#) and an [ImplementationDataType](#) can be mapped to each other in order to describe both aspects of one [dataElement](#).] ([RS_SWCT_03216](#), [RS_SWCT_03217](#), [RS_SWCT_03215](#))

Class	DataTypeMap			
Package	M2::AUTOSARTemplates::SWComponentTemplate::Datatype::Datatypes			
Note	This class represents the relationship between ApplicationDataType and its implementing AbstractImplementationDataType .			
Base	ARObject			
Attribute	Type	Mult.	Kind	Note
applicationData Type	ApplicationDataType	1	ref	This is the corresponding ApplicationDataType
implementation DataType	AbstractImplementation DataType	1	ref	This is the corresponding AbstractImplementationData Type .

Table 5.4: DataTypeMap

If, for example, a [dataElement](#) in a [SenderReceiverInterface](#) is typed by an [ApplicationDataType](#) it shall additionally be associated to an [ImplementationDataType](#) in order to be able to generate the RTE.

[TPS_SWCT_01190] **ModeRequestTypeMap** [Another mapping class, [ModeRequestTypeMap](#), has been introduced in order to allow the transport of mode related information via “normal” sender-receiver communication. Apart from this, mode information is not handled by the usual type system but needs special meta-classes.] ([RS_SWCT_03110](#))

This aspect is explained in more detail in chapter [4.2.5](#).

Note that the mapping classes instead of direct associations have been introduced for process reasons: It allows maintaining application and implementation types in separate M1 artifacts without direct links.

For example, if a software component is moved to another hardware platform the mapping between application and implementation types might be changed in the scope of the specific component without changing the overall VFB model.

[TPS_SWCT_01191] **mapped ApplicationDataType and ImplementationDataType shall be compatible** [In order to set up a valid [DataTypeMap](#) between an [ApplicationDataType](#) and an [ImplementationDataType](#) the two types shall be compatible.

Of course, if [ImplementationDataTypes](#) are generated from existing [ApplicationDataTypes](#) it is expected that they will be automatically compatible.] ([RS_SWCT_03216](#), [RS_SWCT_03217](#))

Please note that the compatibility between an [ApplicationDataType](#) and an [ImplementationDataType](#) mapped onto each other is clarified in chapter [6.2.5](#).

Furthermore, the various mappings are aggregated in a container [DataTypeMappingSet](#) for easier maintenance in artifacts.

Class	DataTypeMappingSet			
Package	M2::AUTOSARTemplates::SWComponentTemplate::Datatype::Datatypes			
Note	This class represents a list of mappings between ApplicationDataTypes and ImplementationDataTypes . In addition, it can contain mappings between ImplementationDataTypes and ModeDeclarationGroups . Tags: atp.recommendedPackage=DataTypeMappingSets			
Base	ARElement , ARObject , AtpBlueprint , AtpBlueprintable , CollectableElement , Identifiable , Multilanguage , Referrable , PackageableElement , Referrable			
Attribute	Type	Mult.	Kind	Note
dataTypeMap	DataTypeMap	*	aggr	This is one particular association between an ApplicationDataType and its AbstractImplementationDataType .
modeRequestTypeMap	ModeRequestTypeMap	*	aggr	This is one particular association between an ModeDeclarationGroup and its AbstractImplementationDataType .

Table 5.5: DataTypeMappingSet

Note that the meta-classes [AutosarDataType](#), [ModeDeclarationGroup](#) and [DataTypeMappingSet](#) are derived from [ARElement](#). This means that these and the meta-classes derived from them can be declared on the M1 level as part of an [ARPackage](#) and thus can be used in some Software Component or Basic Software Module Descriptions.

How to organize `DataTypeMappingSets` for a software system, for example whether there is a separate mapping set for each ECU or even for each software component, is considered as project specific. However, the RTE generator needs a well-defined `DataTypeMappingSet` as input in relation those artifacts which might define data typed as `ApplicationDataTypes`.

[TPS_SWCT_01192] Meta-classes that have an association to a `DataTypeMappingSet` [Therefore, the following meta-classes in the scope of this document have an association to a `DataTypeMappingSet`:

- `InternalBehavior`, because it represents the interface between the software component's code and the RTE and all data types belonging to the particular component type have to be uniquely provided on implementation level.
- `ParameterSwComponentType`, for the same reason (this component type doesn't have an `InternalBehavior`).
- `NvBlockDescriptor`, because this meta-class also leads to generation of code from data types and is not associated to an `InternalBehavior`.
- `CompositionSwComponentType`, to support the definition of `ComSpecs` in the context of a `CompositionSwComponentType`. Please note that this definition of a data type mapping is informal (i.e. it shall be taken as a hint for delegation `PortPrototypes` that are not yet referenced by a `DelegationSwConnector` or `PassThroughSwConnector`) and shall **not** be regarded as a binding contract towards the inner elements of the `CompositionSwComponentType`.

]()

For more details about this aspect please refer to figure 5.79.

[TPS_SWCT_01193] Mappings between application and implementation types do not necessarily have to form a 1:1 relation [In general, it is not required that the sum of all mappings between `ApplicationDataType` and `ImplementationDataType` in a given system form a 1:1 relation. Depending on the use case and on the scope, 1:n as well as n:1 mappings are possible :

- Several `ApplicationDataTypes` may be mapped to the same `ImplementationDataType` in the scope of a system, an ECU, or even a single `InternalBehavior` of an atomic software component.

Of course, this requires that the different `ApplicationDataTypes` are used for different `DataPrototypes` and thus that the `DataPrototypes` are typed by them (and not by the `ImplementationDataTypes`). This allows to establish a more simple type system on the implementation level, than on the application model level.

- The same `ApplicationDataTypes` may be mapped to different `ImplementationDataTypes` for different ECUs. This scenario allows to choose the implementation data types according to the needs of specific ECUs.

- The same `ApplicationDataTypes` may be mapped to different `ImplementationDataTypes` even in the scope of a single ECU (more exactly speaking, a single RTE), but only for different `AtomicSwComponentTypes` (see [constr_1004]).

This improves the portability of software components which were developed independently or are ported between ECUs.

]()

[constr_1004] Mapping of `ApplicationDataTypes` in the scope of single `AtomicSwComponentTypes` [In the scope of `AtomicSwComponentType.internalBehavior.dataTypeMapping`, each `ApplicationDataType` shall be mapped to exactly one `ImplementationDataType`.]()

[constr_1005] Compatibility of `ImplementationDataTypes` mapped to the same `ApplicationDataType` [It is required that `ImplementationDataTypes` which are taken for connecting corresponding elements of `PortInterfaces` and thus refer to compatible `ApplicationDataTypes` are also compatible among each other (so that RTE is able to cope with possible connections by converting the data accordingly).]()

This constraint is visualized in figure 5.2.

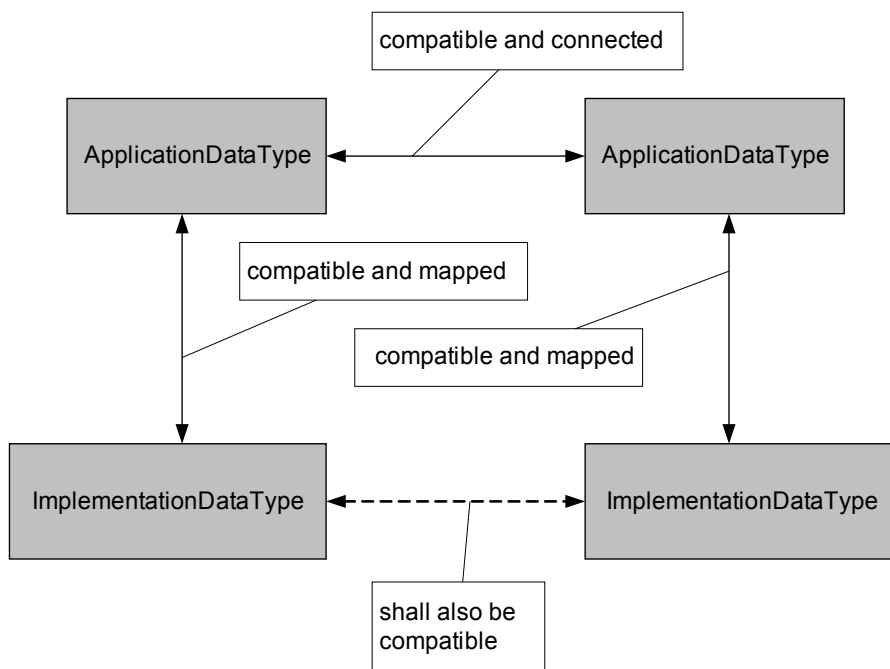

Figure 5.2: Compatibility of Data Types

[constr_1636] Mapping of data types that represent an Optional Element Structure [An `ApplicationRecordDataType` with at least one `element` where attribute `isOptional` is set to `True` shall only be mapped to an `ImplementationDataType` that fulfills the structural requirements to represent an `Optional Element Structure` (see [TPS_SWCT_01774]).]()

5.2.3 Data Categories

An `AutosarDataType` is derived from `Identifiable`, thus having a `longName`, a `shortName`, a `category`, and several further attributes for administrative and documentation purposes (for details see [11]).

[TPS_SWCT_01238] Attribute `category` used in the context of `Autosar-DataType` [The `category` attribute is used to set constraints for the various properties which can be specified for an `AutosarDataType`. These properties are defined by aggregating the meta-class `SwDataDefProps` which contains several attributes and references.]()

Detailed explanations about the semantics of meta-class `SwDataDefProps` can be found in chapter 5.4.

[constr_1143] `category` of `AutosarDataType` shall not be extended [In contrast to the general rule that `category` can be extended by user-specific values it is **not allowed** to extend the meaning of the attribute `category` of meta-class `Autosar-DataType`.]()

This approach avoids a very deep and complicated inheritance tree which otherwise would be needed on the M2 level for `AutosarDataType`. There is to some extent a redundancy between setting the `category` and defining the attributes of `Autosar-DataType.swDataDefProps`. This redundancy is intended and allows to for a tool to rule out senseless configurations via simple rules.

In former version of this specification the categories were only used for calibration parameters. Due to several extensions the categories are now applicable for all use cases of the `AutosarDataType`.

An overview on all valid `category`s defined for `AutosarDataType` is shown in table 5.6. Some `category`s are also applied to sub-elements of the type system (column “Applicable to ...” in table 5.6). This is explained in more detail in the following sections.

Please note that the column “RTE + BSW” of table 5.6 is only applicable for `category`s that are relevant either for `ImplementationDataTypes` and/or the aspect of measurement and calibration in `McDataInstance`.

[constr_1006] applicable data categories [Table 5.6 defines the applicable `category`s depending on specific model elements related to data definition properties.]()

Category	Applicable to ...											Use Case				Description	
	ApplicationArrayType	ApplicationRecordDataType	ApplicationPrimitiveDataType	ApplicationRecordElement	ApplicationArrayElement	ApplicationValueSpecification	ImplementationDataType	ImplementationDataElement	SwServiceArg	SwSystemconst	McDataInstance	Calibration	Measurement	Communication Port Interfaces	RTE + BSW		
VALUE			x	x	x	x	x	x	x	x		x	x	x	x	Contains a single value.	
VAL_BLK			x	x	x	x				x		x		x		A value block defines values stored together within one calibration parameter object. It is similar to an value array but it stores the values by means of an axis instead (only important for calibration data handling).	
DATA_REFERENCE							x	x	x					x ³	x	Contains an address of another <i>DataPrototype</i> (whose type is given via <i>SwDataDefProps.swPointerTargetProps</i>).	
FUNCTION_REFERENCE							x	x	x						x	Contains an address of a function prototype (whose signature is given via <i>SwDataDefProps.swPointerTargetProps.functionPointerSignature</i>).	
TYPE_REFERENCE							x	x	x						x	x	The element is defined via reference to another data type (via <i>SwDataDefProps.implementationDataType</i>).
STRUCTURE	x			x	x		x	x		x		x	x	x	x	x	Holds one or several further elements which can have different <i>AutosarDataTypes</i> . The underlying elements are defined in the same manner as normal data except for the association to <i>SwAddrMethod</i> : This has to be the same for all underlying elements. Corresponds to a Record if used in the application domain.
UNION							x	x		x		x	x	x	x	x	Can hold values of different data types. It is similar to <i>STRUCTURE</i> except that all of its members start at the same location in memory. A <i>UNION</i> data prototype can contain only one of its elements at a time. The size of the <i>UNION</i> is at least the size of the largest member. Please find more information in [TPS_SWCT_01700].
ARRAY	x			x	x		x	x		x		x	x	x	x	x	An array of sub-elements which are of the same type.
BIT										x		x	x			x	One or several bits within a host variable, which are treated as an own data object.
HOST										x		x	x			x	A <i>HOST</i> data type is like a simple <i>VALUE</i> , but it is used for packed bit definition. That means it can host several <i>BIT</i> variables which have their own description and measurement access.
STRING			x	x	x	x				x		x	x	x			Contains a single value interpreted as a text string (note that it appears as a single value for the application domain; the internal representation can be an array).



³[constr_1295] applies!



Category	Applicable to ...											Use Case				Description
	ApplicationArrayDataType	ApplicationRecordDataType	ApplicationPrimitiveDataType	ApplicationRecordElement	ApplicationArrayElement	ApplicationValueSpecification	ImplementationDataType	ImplementationDataTypeElement	SwServiceArg	SwSystemConst	McDataInstance	Calibration	Measurement	Communication Port Interfaces	RTE + BSW	
BOOLEAN			x	x	x	x					x	x	x	x		Contains one boolean state. Depending on the CPU direct addressing of single bits may not be available. So a byte or a word can be used to store only one logical state.
COM_AXIS			x	x	x	x					x	x		x		An axis definition as separate calibration parameter which can be referenced by any CURVE , MAP , CUBOID , CUBE_4 , and CUBE_5 . The benefits by using a common axis is that it saves memory space; because it is stored only one time and can be used in multiple CURVES , MAPS , CUBOIDS , CUBE_4s , and CUBE_5s .
RES_AXIS			x	x	x	x					x	x		x		A RES_AXIS (rescale axis) is also a shared axis like COM_AXIS , the difference is that this kind of axis can be used for rescaling. Note that the RES_AXIS is by nature a CURVE which is used to implement a non linear scaling (rescale) of the axis. In addition to saving memory space via the shared usage like a COM_AXIS , it can compress a huge range to a non-linear distributed axis points thus retaining the required accuracy.
CURVE			x	x	x	x					x	x		x		Calibration parameter with one input value and one output value. That means output values can be defined depending on the input value. The granularity of implemented functionality can be changed by using different number of axis points. A CURVE has always one input axis and one output axis. The output axis is a characteristic of the curve and every time present but the input axis can be defined within the curve definition or separately.
MAP			x	x	x	x					x	x		x		Calibration parameter with two input values and one output value. That means output values can be defined depending on the input values. The granularity of implemented functionality can be changed by using different number of axis points for y- and x-axis. A MAP has always two input axes and one output axis. The output axis is a characteristic of the MAP and every time present but the input axes can be defined within the MAP definition or separately.





Category	Applicable to ...											Use Case				Description
	ApplicationArrayType	ApplicationRecordDataType	ApplicationPrimitiveDataType	ApplicationRecordElement	ApplicationArrayElement	ApplicationValueSpecification	ImplementationDataType	ImplementationDataTypeElement	SwServiceArg	SwSystemconst	McDataInstance	Calibration	Measurement	Communication Port Interfaces	RTE + BSW	
CUBOID			x	x	x	x					x	x		x		<p>Calibration parameter with three input values and one output value. That means output values can be defined depending on the input values.</p> <p>The granularity of implemented functionality can be changed by using different number of axis points for the input axes. A CUBOID has always three input axes and one output axis.</p> <p>The output axis is a characteristic of the CUBOID and every time present but the input axes can be defined within the CUBOID definition or separately.</p>
CUBE_4			x	x	x	x					x	x		x		<p>Calibration parameter with four input values and one output value. That means output values can be defined depending on the input values.</p> <p>The granularity of implemented functionality can be changed by using different number of axis points for the input axes. A CUBE_4 has always four input axes and one output axis.</p> <p>The output axis is a characteristic of the CUBE_4 and every time present but the input axes can be defined within the CUBE_4 definition or separately.</p>
CUBE_5			x	x	x	x					x	x		x		<p>Calibration parameter with five input values and one output value. That means output values can be defined depending on the input values.</p> <p>The granularity of implemented functionality can be changed by using different number of axis points for the input axes. A CUBE_5 has always five input axes and one output axis.</p> <p>The output axis is a characteristic of the CUBE_5 and every time present but the input axes can be defined within the CUBE_5 definition or separately.</p>
MACRO									x						x	This represents an argument to a C macro.

Table 5.6: Usage of **category** for Data Types

[TPS_SWCT_01239] default value for attribute **category** used in the context of **SwSystemconst** [The default value for the **category** of a **SwSystemconst** shall be **VALUE**. This has to be applied if no explicit definition of the **category** can be found.]
 ()

5.2.4 Application Data Type

[TPS_SWCT_01240] Subclasses of **ApplicationDataType** [The abstract meta-class **ApplicationDataType** is further derived into an **ApplicationPrimitiveDataType** and an **ApplicationCompositeDataType** which are further explained in the following sub-chapters.] ([RS_SWCT_03216](#))

This aspect is further explained in Figure 5.3.

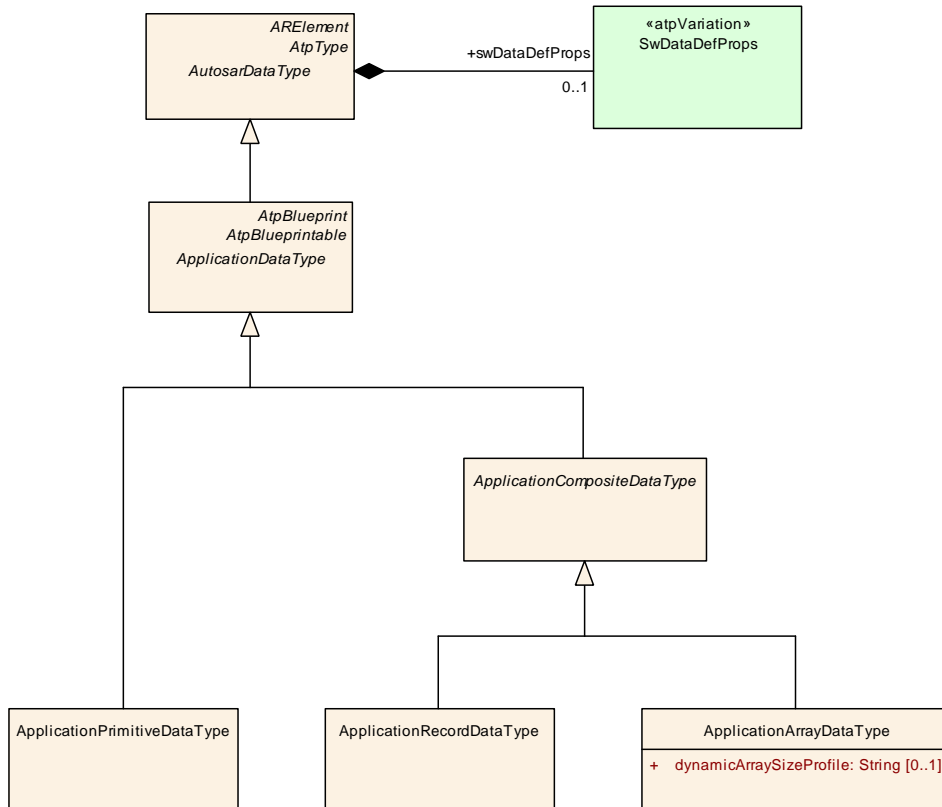

Figure 5.3: Basic Meta-Model for ApplicationDataType

Attributes of SwDataDefProps	Root Elem.			Attribute Existence per Category												
	ApplicationDataType	ApplicationRecordElement	ApplicationArrayElement	VALUE	VAL_BLK	STRUCTURE	ARRAY	STRING	BOOLEAN	COM_AXIS	RES_AXIS	CURVE	MAP	CUBOID	CUBE_4	CUBE_5
additionalNativeTypeQualifier																
annotation	x	x	x	*	*	*	*	*	*	*	*	*	*	*	*	*
baseType																
compuMethod	x			0..1	0..1				0..1			0..1	0..1	0..1	0..1	0..1
dataConstr.dataConstrRule.physConstrs	x	x	x	0..1	0..1		0..1		0..1			0..1	0..1	0..1	0..1	0..1
dataConstr.dataConstrRule.internalConstrs	x	x	x	d/c ⁴	d/c		d/c		d/c			d/c	d/c	d/c	d/c	d/c
displayFormat	x	x	x	0..1	0..1		0..1	0..1	0..1			0..1	0..1	0..1	0..1	0..1
displayPresentation	x	x	x	0..1	0..1		0..1			0..1	0..1	0..1	0..1	0..1	0..1	0..1
implementationDataType																
invalidValue	x			0..1				0..1	0..1							
stepSize	x	x	x	0..1	0..1		0..1			0..1	0..1	0..1	0..1	0..1	0..1	0..1
swAddrMethod	x			0..1	0..1	0..1	0..1	0..1	0..1	0..1	0..1	0..1	0..1	0..1	0..1	0..1
swAlignment																
swBitRepresentation																
swCalibrationAccess	x	x		0..1	0..1	0..1	0..1	0..1	0..1	1	1	1	1	1	1	1
swCalprmAxisSet	x									1	1	1	1	1	1	1
swComparisonVariable																
swDataDependency																
swHostVariable																
swImplPolicy	x			0..1	0..1	0..1	0..1	0..1	0..1	0..1	0..1	0..1	0..1	0..1	0..1	0..1
swIntendedResolution	x	x	x	0..1												
swInterpolationMethod	x			0..1						0..1	0..1	0..1	0..1	0..1	0..1	0..1
swIsVirtual																
swPointerTargetProps																
swRecordLayout	x			0..1	0..1 ⁵			0..1		1	1	1	1	1	1	1
swRefreshTiming	x			0..1	0..1			0..1	0..1							
swTextProps	x							1								
swValueBlockSize	x				1											
swValueBlockSizeMult	x				1											
unit	x			0..1	0..1			0..1	0..1			0..1	0..1	0..1	0..1	0..1
valueAxisDataType	x				0..1					0..1	0..1	0..1	0..1	0..1	0..1	0..1
Other Attributes below the Root Element																
element: ApplicationRecordElement	x	x	x			1..*										
element: ApplicationArrayElement	x	x	x				1									



⁴don't care

⁵This is required by [TPS_SWCT_01179].



ApplicationArrayElement.array-SizeSemantics	x						0..1												
ApplicationArrayElement.maxNumberOfElements	x						1												

Table 5.7: Allowed Attributes vs. category for ApplicationDataTypes

Class	ApplicationPrimitiveDataType			
Package	M2::AUTOSARTemplates::SWComponentTemplate::Datatype::Datatypes			
Note	A primitive data type defines a set of allowed values. Tags: atp.recommendedPackage=ApplicationDataTypes			
Base	ARElement , ARObject , ApplicationDataType , AtpBlueprint , AtpBlueprintable , AtpClassifier , AtpType , AutosarDataType , CollectableElement , Identifiable , MultilanguageReferrable , PackageableElement , Referrable			
Attribute	Type	Mult.	Kind	Note
–	–	–	–	–

Table 5.8: ApplicationPrimitiveDataType

Class	ApplicationCompositeDataType (abstract)			
Package	M2::AUTOSARTemplates::SWComponentTemplate::Datatype::Datatypes			
Note	Abstract base class for all application data types composed of other data types.			
Base	ARElement , ARObject , ApplicationDataType , AtpBlueprint , AtpBlueprintable , AtpClassifier , AtpType , AutosarDataType , CollectableElement , Identifiable , MultilanguageReferrable , PackageableElement , Referrable			
Subclasses	ApplicationArrayDataType , ApplicationRecordDataType			
Attribute	Type	Mult.	Kind	Note
–	–	–	–	–

Table 5.9: ApplicationCompositeDataType

[TPS_SWCT_01241] Applicable **categorys** for subclasses of **Application-DataType** [Like any [AutosarDataType](#), also the primitive and composite types on application level are characterized by their **category** and their [SwDataDefProps](#). For a given **category**, only a limited set of attributes of the [SwDataDefProps](#) makes sense.]([RS_SWCT_03216](#))

[constr_1007] Allowed attributes of [SwDataDefProps](#) for **Application-DataTypes** [The allowed attributes of [SwDataDefProps](#) for [Application-DataTypes](#) and their allowed multiplicities are listed as an overview in table 5.7.]([\(\)](#))

This list makes use of the [SwDataDefProps](#) and other meta-model elements which are explained in detail in the further sections of this chapter.

[constr_1008] Applicability of **categorys** **STRUCTURE** and **ARRAY** [The categories **STRUCTURE** and **ARRAY** correspond to [ApplicationCompositeDataTypes](#) whereas all other **categorys** can be applied only for [ApplicationPrimitive-DataTypes](#).]([\(\)](#))

5.2.4.1 Application Primitive Data Types

5.2.4.1.1 Data Types for Single Values

In contrast to prior versions (R3.x) of the AUTOSAR standard, the primitive application data types on M2 level are no longer specified. Instead of this, the meta-class `ApplicationPrimitiveDataType` in combination with the attached `swDataDefProps` is used on the level of the M2 (meta-) model to specify the details on M1 modeling level.

[TPS_SWCT_01242] `category` characterizes the nature of a data type on application level [The `category` is used in addition to characterize the nature of a data type on application level.] (*RS_SWCT_03216*)

For example, the `IntegerType` as of AUTOSAR R3.x allows for specifying lower and upper ranges that constrain the applicable value interval. That aspect is still supported by this version of AUTOSAR, but the meta-model is different from the former approach. Especially it is no more considered of importance to specify that an `ApplicationPrimitiveDataType` is actually represented by “integer” numbers.

Figure 5.4 provides a sketch of how limits are defined now. The key feature is the aggregation of `SwDataDefProps` at `AutosarDataType`. The meta-class `SwDataDefProps` allows for creating a reference to a `DataConstr` that in turn aggregates a `DataConstrRule`.

The latter aggregates `PhysConstrs` and this meta-class finally owns two `Limits` in the roles `lowerLimit` and `upperLimit`.

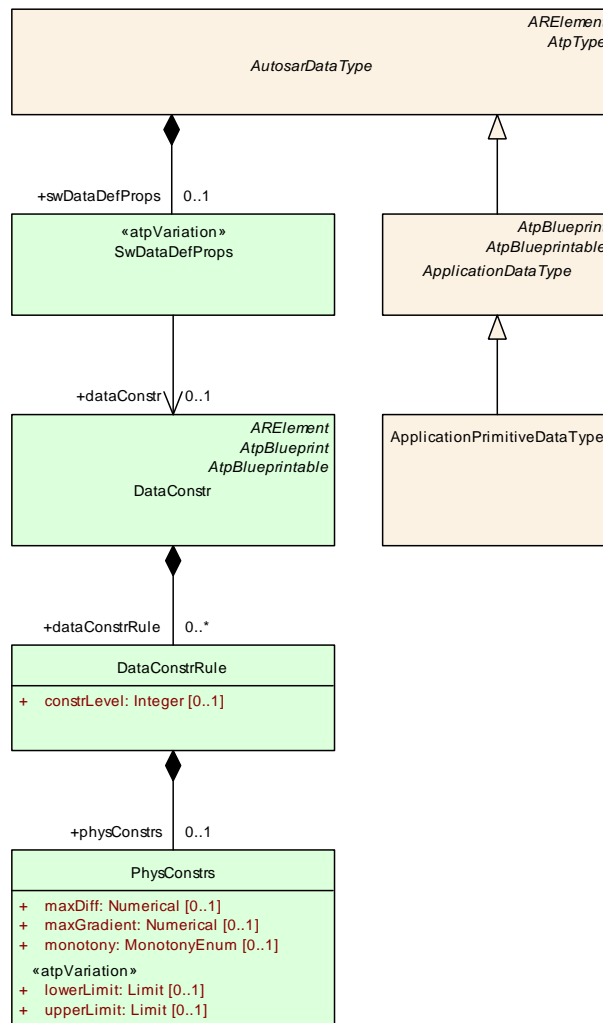

Figure 5.4: Specification of Physical Limits

Another example is shown in Figure 5.5. By making again use of `SwDataDefProps`, this figure shows how semantics in form of a `CompuMethod` and a `Unit` can be attached.

Also, an `initValue` can be defined which is used by the RTE in order to initialize values of `VariableDataPrototypes/ParameterDataPrototypes` defined locally in a software-component.

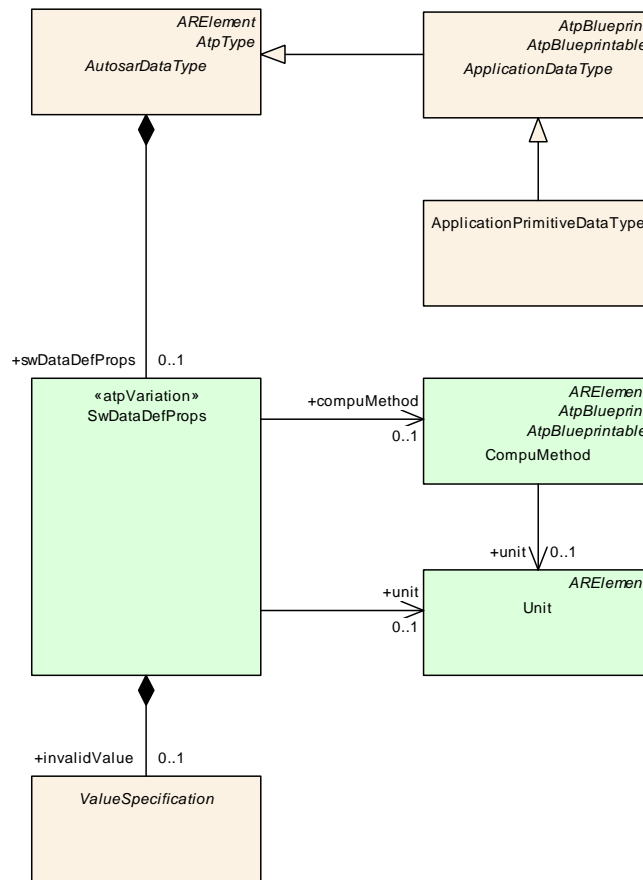

Figure 5.5: Some Properties of `ApplicationPrimitiveDataTypes`

Figure 5.6 illustrates the relationship between the data constraints for `ApplicationDataType`, `CompuMethod`, `ImplementationDataType`, `BaseType` and also the `invalidValue` for the case of an entirely linear or rational conversion.

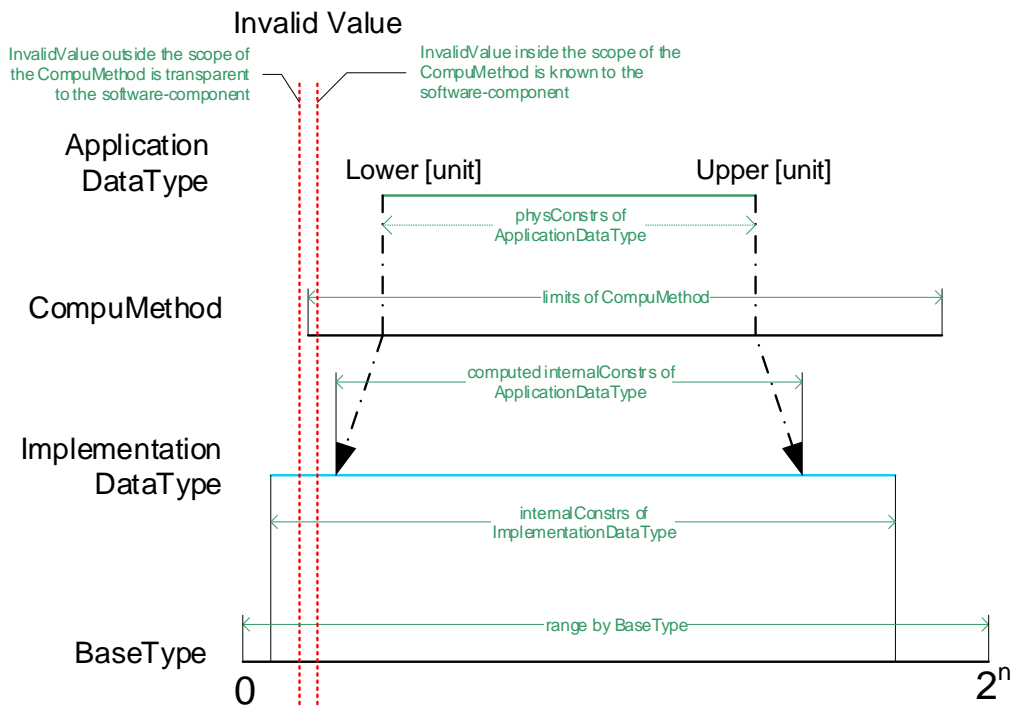

Figure 5.6: Value ranges and invalid values for linear and rational `CompuMethod`

Please note that Figure 5.6 is only applicable for linear and rational `CompuMethods`.

Figure 5.7 and Figure 5.8 depict a similar situation for the case of mixed `CompuMethods` where the `invalidValue` is defined in the discrete part of a `CompuMethod`.

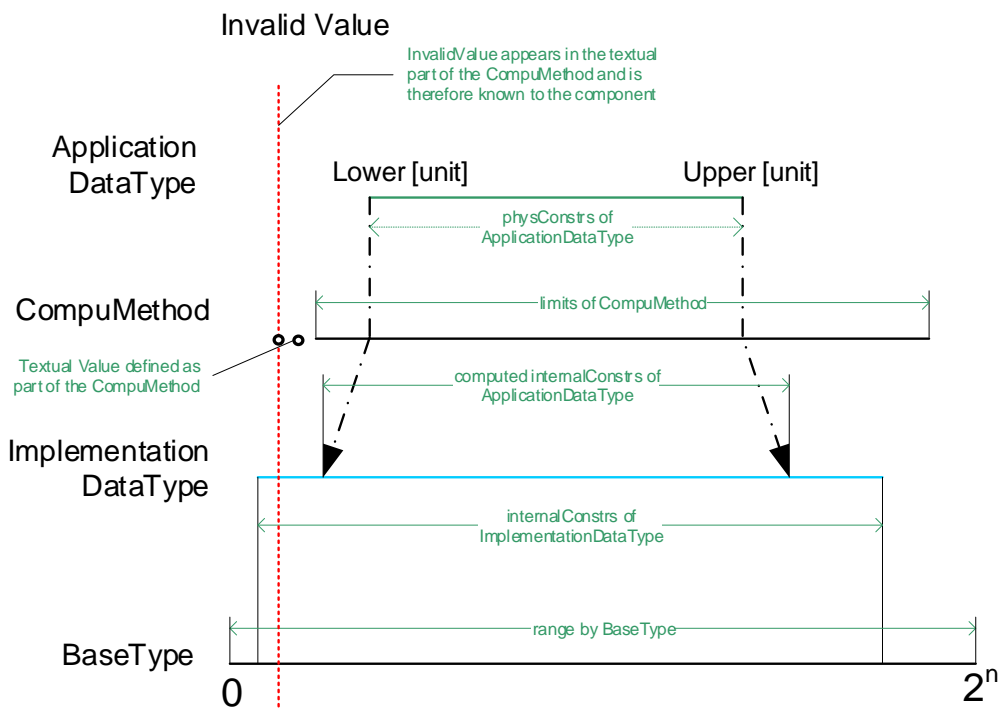

Figure 5.7: Value ranges and invalid values with discrete `invalidValue` defined inside the scope of the `CompuMethod`

Figure 5.7 sketches a case where a `CompuMethod` has a linear and a discrete part and the `invalidValue` is defined by means of one value that is defined in the discrete part of the `CompuMethod`.

As mentioned by [constr_1281], the `invalidValue` shall be defined in the physical domain in this case. In other words, the `invalidValue` shall be defined by a symbol according to [TPS_SWCT_01432].

As a consequence of the definition of an `invalidValue` **inside**, the scope of a mixed `CompuMethod` the `invalidValue` is visible to the software-component.

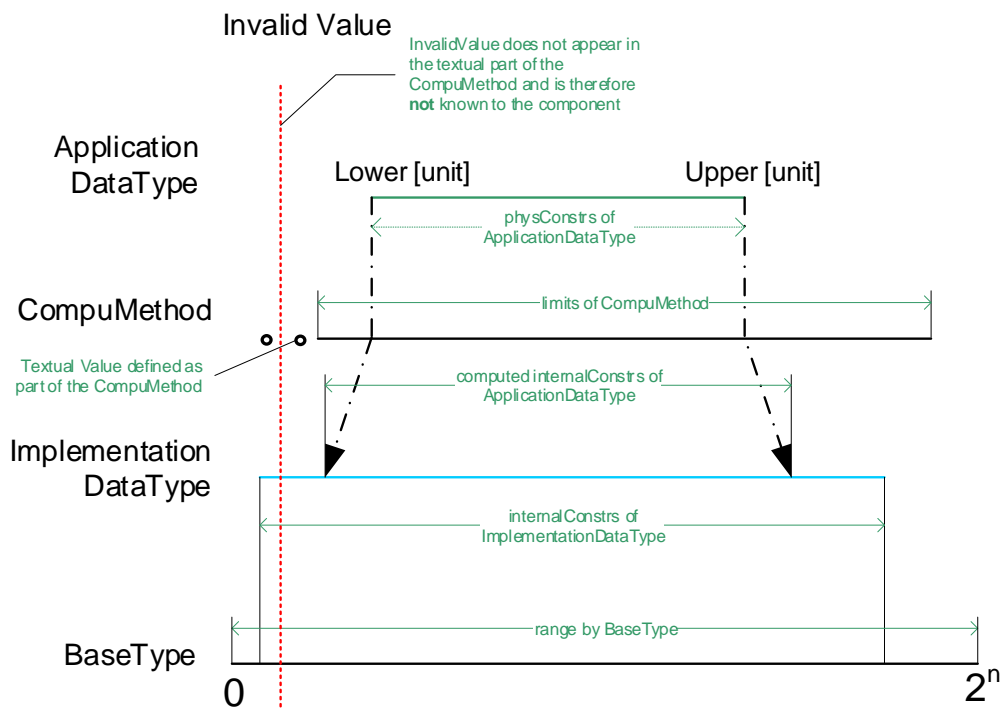

Figure 5.8: Value ranges and invalid values with discrete `invalidValue` defined outside the scope of the `CompuMethod`

Figure 5.8, on the other hand, sketches a case where a `CompuMethod` has a linear and a discrete part and the `invalidValue` is not within the defined linear interval and not defined by means of one value out of the discrete part of the `CompuMethod`.

As mentioned by [constr_1283], the `invalidValue` shall be defined in the internal domain in this case. In other words, the `invalidValue` shall be defined by a `NumericalValueSpecification`.

As a consequence of the definition of an `invalidValue` **outside**, the scope of a mixed `CompuMethod` the `invalidValue` is visible to the software-component.

If an `ApplicationPrimitiveDataType` does not define `dataConstr` then implicit constraints can be derived from physical meaning of the `ApplicationDataType`.

For example, if the data type represents a temperature the lower bound will not be able to exceed 0K.

For other physical meanings, it could be possible that the implicitly assumed limits go from $-\text{INF}$ to $+\text{INF}$.

In order to avoid ambiguity regarding the values of limits it is **strongly recommended** defining a reasonable limit for `ApplicationPrimitiveDataTypes`.

[constr_2544] Limits need to be consistent [

- The limits of `ApplicationDataType` shall be inside the definition range of the `CompuMethod`

The `CompuMethod` needs to be applicable for limits of an `ApplicationDataType`. The reason is that the internal representation of the limits for the `ApplicationDataType` are calculated by applying the `CompuMethod`.

- The such defined internal limits of the `ApplicationDataType` shall be within or equal the `internalConstrs` of the mapped `ImplementationDataType`.
- The limits of the `ImplementationDataType` shall be within or equal to the limits defined by the size of the `BaseType`.

]()

[constr_1281] `invalidValue` is inside the scope of the `compuMethod` [If the value of the `invalidValue` of an `ApplicationPrimitiveDataType` of category `VALUE` is supposed to be **inside** the scope of the applicable `CompuMethod`, an `ApplicationValueSpecification` is used to describe the `invalidValue` of the `ApplicationPrimitiveDataType`.]()

[constr_1281] means that the value of the `ApplicationValueSpecification` shall be within the bounds defined by `swDataDefProps.compuMethod.compuPhysToInternal.compuContent.compuScale.lowerLimit` or `upperLimit` or the inverse case that is based on the bounds defined by `swDataDefProps.compuMethod.compuInternalToPhys.compuContent.compuScale.lowerLimit` or `upperLimit`.

[constr_1283] `invalidValue` is outside the scope of the `compuMethod` [If the value of the `invalidValue` of an `ApplicationPrimitiveDataType` of category `VALUE` is supposed to be **outside** the scope of the applicable `CompuMethod`, a `NumericalValueSpecification` shall be used to describe the `invalidValue` of the `ApplicationPrimitiveDataType`.]()

The handling of `invalidValue` for `ApplicationPrimitiveDataType` of category `STRING` is defined by **[constr_1242]**.

For a more detailed description of the properties that can be defined for data types (and data prototypes as well) see sections 5.4 and 5.4.2.

[TPS_SWCT_01760] Defining the dimension of an `ApplicationPrimitiveDataType` of category `VAL_BLK` [An `ApplicationPrimitiveDataType` of category `VAL_BLK` that has only one dimension shall be described using the attribute `SwDataDefProps.swValueBlockSize`.

An `ApplicationPrimitiveDataType` of category `VAL_BLK` that has more than one dimension shall be described using the attribute `SwDataDefProps.swValueBlockSizeMult`.]()

[constr_1610] Existence of `SwDataDefProps.swValueBlockSize` and `SwDataDefProps.swValueBlockSizeMult` [Attributes `SwDataDefProps.swValueBlockSize` and `SwDataDefProps.swValueBlockSizeMult` shall not exist at the same time in the context of a given `SwDataDefProps`.]()

5.2.4.1.2 About Enumerations

[TPS_SWCT_01243] Definition of enumeration types [In the AUTOSAR meta-model, an enumeration is not implemented by means of an `ApplicationCompositeDataType`.

Instead, a discrete set of integer numbers can be used as a structural description for a single `ApplicationPrimitiveDataType` or an `ImplementationDataType` of category `VALUE` or `TYPE_REFERENCE` that boils down to an `ImplementationDataType` of category `VALUE`.

The mapping of the integer numbers to *labels* in the scope of the definition of an enumeration is considered part of the semantical definition via an attached `CompuMethod` rather than part of the structural description.] (*RS_SWCT_03216*)

[TPS_SWCT_01562] Specification of values of an enumeration [For the specification of values of an enumeration on the basis of the labels defined in the applicable `CompuMethod` it is necessary to distinguish two approaches based on the used `AutosarDataType`:

- `ImplementationDataType`: as mentioned by [*constr_1225*], the definition of the labels of an enumeration shall only be done by using `TextValueSpecification`.
- `ApplicationPrimitiveDataType`: use the `ApplicationValueSpecification.swValueCont.swValuesPhys.vt` or `ApplicationRuleBasedValueSpecification.swValueCont.ruleBasedValues.arguments.vt`.

]()

The relevant meta-classes in the context of `SwDataDefProps` are sketched in Figure 5.9. This includes all meta-classes that may contribute to the definition of the symbol of a `CompuScale` in C code, see [*TPS_SWCT_01431*].

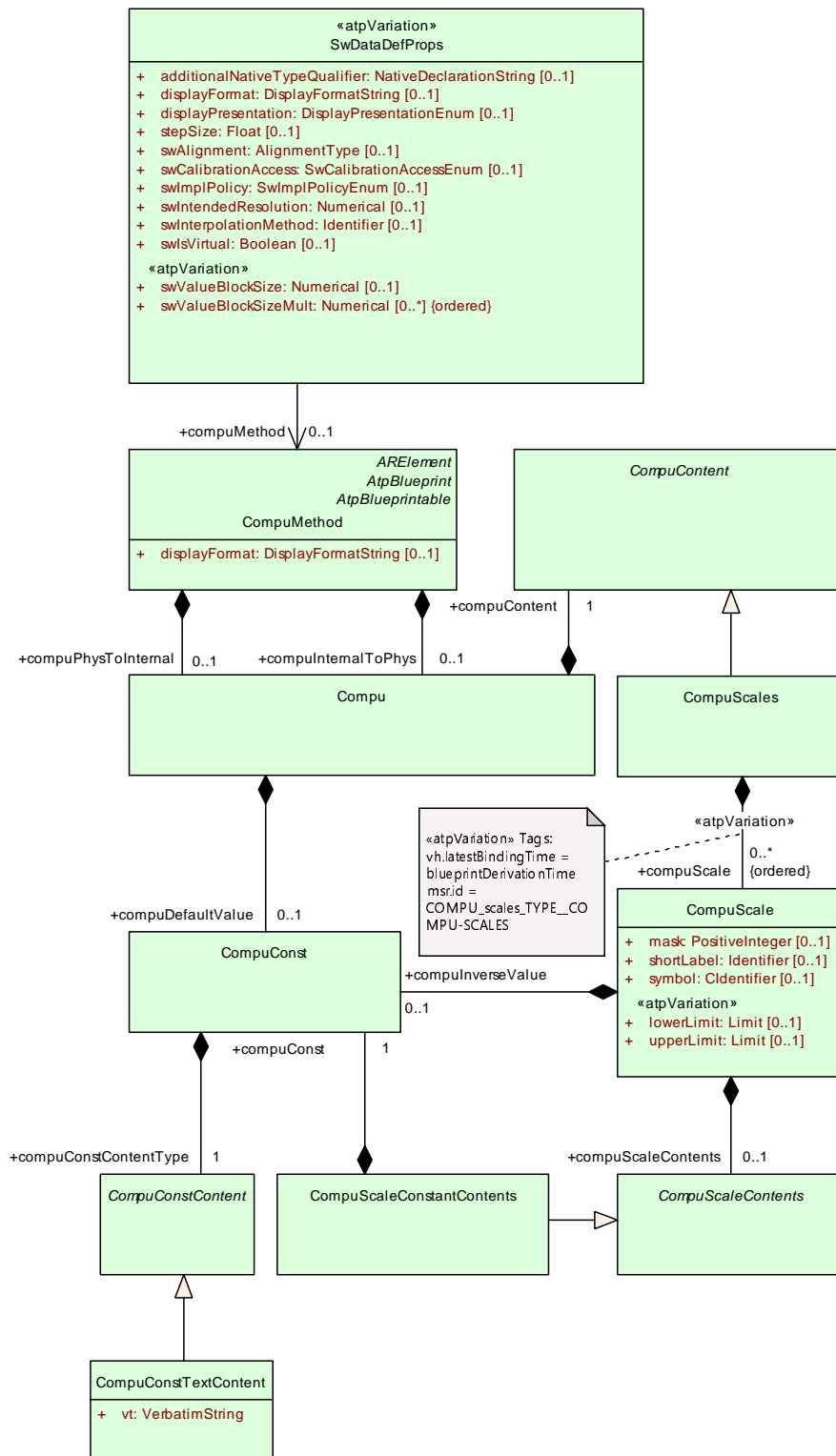

Figure 5.9: Relevant meta-classes for the specification of enumerations

An example of how an enumeration looks like in ARXML is contained in section [5.5.1.4](#).

5.2.4.1.3 Data Types for Calibration Parameters

[TPS_SWCT_01244] Data types for calibration parameters are also described as primitive types [Data types for calibration parameters are from the application perspective also described as primitive types. This is obvious, if they are simple values (`category VALUE`). Also, the `category STRING` is treated as a primitive type on application level.

Less obvious is the fact that `ApplicationDataTypes` of the categories `VAL_BLK`, `COM_AXIS`, `RES_AXIS`, `CURVE`, `MAP`, `CUBOID`, `CUBE_4`, and `CUBE_5` are not described as composite data types (as far as the application level is concerned) although they admittedly possess some kind of internal structure.

In contrast to `ApplicationCompositeDataTypes`, they are **not** composed similarly of other `AutosarDataTypes`. Their substructure needs a special description in order to be compatible with existing calibration techniques.]()

[TPS_SWCT_01245] SwDataDefProps control the structure of calibration parameters [The substructure of these types is attached to the `SwDataDefProps`. By this means it is possible to define on the level of `DataPrototypes` or other artifacts, where the `SwDataDefProps` come into play.]()

For details on these part of the `SwDataDefProps` see chapters 5.4.4 and 5.5.5.

5.2.4.1.4 Data Types for Textual Strings

[constr_1093] Definition of textual strings [An `ApplicationPrimitiveDataType` of `category STRING` shall have a `swTextProps` which determines the `arraySizeSemantics` and `swMaxTextSize`.]()

[TPS_SWCT_01488] ApplicationPrimitiveDataType shall be interpreted as a string of a particular encoding [To indicate that an `ApplicationPrimitiveDataType` shall be interpreted as a string of a particular encoding it shall reference `swDataDefProps.swTextProps.baseType` and the only attribute of the referenced `SwBaseType` relevant for this purpose is the `BaseTypeDirectDefinition.baseTypeEncoding`.]()

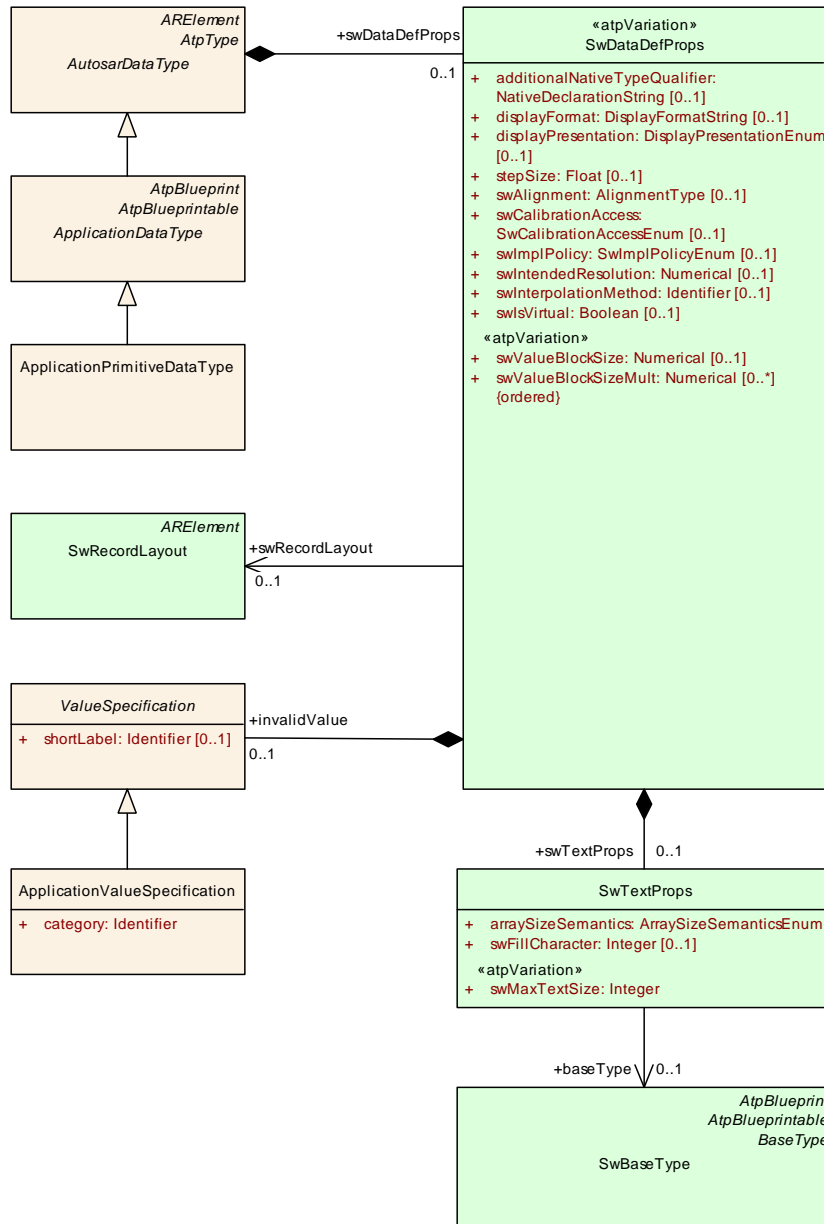

Figure 5.10: Specification of textual strings

Class	SwTextProps			
Package	M2::MSR::DataDictionary::DataDefProperties			
Note	This meta-class expresses particular properties applicable to strings in variables or calibration parameters.			
Base	ARObject			
Attribute	Type	Mult.	Kind	Note





Class	SwTextProps			
arraySize Semantics	ArraySizeSemantics Enum	1	attr	This attribute controls the semantics of the arraysize for the array representing the string in an Implementation DataType. It is there to support a safe conversion between ApplicationDatatype and ImplementationDatatype, even for variable length strings as required e.g. for Support of SAE J1939.
baseType	SwBaseType	0..1	ref	This is the base type of one character in the string. In particular this baseType denotes the intended encoding of the characters in the string on level of ApplicationData Type. Tags: xml.sequenceOffset=30
swFillCharacter	Integer	0..1	attr	Filler character for text parameter to pad up to the maximum length swMaxTextSize. The value will be interpreted according to the encoding specified in the associated base type of the data object, e.g. 0x30 (hex) represents the ASCII character zero as filler character and 0 (dec) represents an end of string as filler character. The usage of the fill character depends on the arraySize Semantics. Tags: xml.sequenceOffset=40
swMaxTextSize	Integer	1	attr	Specifies the maximum text size in characters. Note the size in bytes depends on the encoding in the corresponding baseType. Stereotypes: atpVariation Tags: vh.latestBindingTime=preCompileTime xml.sequenceOffset=20

Table 5.10: SwTextProps

[TPS_SWCT_01127] **Byte array with variable size** [[SwTextProps](#) can be used to define byte arrays of variable size.]([RS_SWCT_03182](#), [RS_SWCT_03181](#))

[TPS_SWCT_01246] [SwRecordLayout](#) may also be required for A2L generation [A [SwRecordLayout](#) may also be required for the generation of A2L if the string is part of calibration data.](/)

As stated by [TPS_SWCT_01128], the definition of [SwDataDefProps.swRecordLayout](#) is considered mandatory anyway for [ApplicationPrimitiveDataTypes](#) of category `STRING`.

The following series of XML fragments exemplifies the definition of a data type for the representation of a textual string. First, the applicable [ApplicationPrimitiveDataType](#) is defined (see Figure 5.10).

Note that the `category` is set to the value `STRING`. Also, the [ApplicationPrimitiveDataType.swDataDefProps.swTextProps](#) indicate the width of the string and also define (by means of the reference to [baseType](#)) the encoding this string data type is supposed to utilize.

Note further that the fact that an [ApplicationDataType](#) directly references (across the implementation level) to a [SwBaseType](#) **represents an exception to the rule that**

ApplicationDataType should not be concerned about the lowest level of data type definition in AUTOSAR.

Listing 5.1: Example for the definition of a string [ApplicationPrimitiveDataType](#)

```

<APPLICATION-PRIMITIVE-DATA-TYPE>
  <SHORT-NAME>MyApplicationStringType</SHORT-NAME>
  <CATEGORY>STRING</CATEGORY>
  <SW-DATA-DEF-PROPS>
    <SW-DATA-DEF-PROPS-VARIANTS>
      <SW-DATA-DEF-PROPS-CONDITIONAL>
        <SW-TEXT-PROPS>
          <ARRAY-SIZE-SEMANTICS>VARIABLE-SIZE</ARRAY-SIZE-SEMANTICS>
          <SW-MAX-TEXT-SIZE>50</SW-MAX-TEXT-SIZE>
          <BASE-TYPE-REF BASE="default" DEST="SW-BASE-TYPE">BaseTypes/
            MyTextBaseType</BASE-TYPE-REF>
        </SW-TEXT-PROPS>
        <INVALID-VALUE>
          <APPLICATION-VALUE-SPECIFICATION>
            <CATEGORY>STRING</CATEGORY>
            <SW-VALUE-CONT>
              <SW-VALUES-PHYS>
                <VT>inv</VT>
              </SW-VALUES-PHYS>
            </SW-VALUE-CONT>
          </APPLICATION-VALUE-SPECIFICATION>
        </INVALID-VALUE>
        <SW-RECORD-LAYOUT-REF BASE="default" DEST="SW-RECORD-LAYOUT">
          RecordLayouts/StringDescriptor</SW-RECORD-LAYOUT-REF>
        </SW-DATA-DEF-PROPS-CONDITIONAL>
      </SW-DATA-DEF-PROPS-VARIANTS>
    </SW-DATA-DEF-PROPS>
  </APPLICATION-PRIMITIVE-DATA-TYPE>

```

If the bridging of the implementation level were accepted as a general pattern for the modeling of [ApplicationDataType](#) it would easily be possible to bypass the implementation level to some extent and this would render [ApplicationDataTypes](#) less versatile.

[TPS_SWCT_01128] [SwRecordLayout](#) needed for [ApplicationPrimitiveDataType](#) of category `STRING` [As mentioned in [TPS_SWCT_01179], an [ApplicationPrimitiveDataType](#) of category `STRING` is considered a [Compound Primitive Data Type](#).

Therefore, it needs a reference to the definition of a [SwRecordLayout](#) that presets the approach for creating a matching [ImplementationDataType](#).]()

In this specific example the definition of the [SwRecordLayout](#) foresees the [ApplicationPrimitiveDataType](#) of category `STRING` to be implemented as a structured data type that consists of:

1. the **size** of an instance of the string data type in terms of the number of characters plus

2. an **array** that can be used to store the individual characters contained in an instance of the string data type.

Depending on the used encoding the **array** may need to be bigger (in terms of the number of elements) than the corresponding value of the **size**.

Furthermore, the definition of the `SwRecordLayout` already takes into account that the implementation of an array data type by means of an `ImplementationDataType` requires the definition of an `ImplementationDataTypeElement`.

Listing 5.2: Example for the definition of a `SwRecordLayout` for an `ApplicationPrimitiveDataType` of category `STRING`

```

<AR-PACKAGE>
  <SHORT-NAME>RecordLayouts</SHORT-NAME>
  <ELEMENTS>
    <SW-RECORD-LAYOUT>
      <SHORT-NAME>StringDescriptor</SHORT-NAME>
      <LONG-NAME>
        <L-4 L="EN">String by descriptor</L-4>
      </LONG-NAME>
      <INTRODUCTION>
        <VERBATIM>
          <L-5 L="EN" xml:space="default">
            struct{
              size,
              char[]
            }
          </L-5>
        </VERBATIM>
      </INTRODUCTION>
      <SW-RECORD-LAYOUT-GROUP>
        <SW-RECORD-LAYOUT-V>
          <SHORT-LABEL>size</SHORT-LABEL>
          <SW-RECORD-LAYOUT-V-AXIS>STRING</SW-RECORD-LAYOUT-V-AXIS>
          <SW-RECORD-LAYOUT-V-PROP>COUNT</SW-RECORD-LAYOUT-V-PROP>
        </SW-RECORD-LAYOUT-V>
        <SW-RECORD-LAYOUT-GROUP>
          <SHORT-LABEL>chars</SHORT-LABEL>
          <SW-RECORD-LAYOUT-GROUP-AXIS>STRING</SW-RECORD-LAYOUT-GROUP-AXIS>
          <SW-RECORD-LAYOUT-GROUP-FROM>0</SW-RECORD-LAYOUT-GROUP-FROM>
          <SW-RECORD-LAYOUT-GROUP-TO>-1</SW-RECORD-LAYOUT-GROUP-TO>
          <SW-RECORD-LAYOUT-V>
            <SHORT-LABEL>char</SHORT-LABEL>
            <SW-RECORD-LAYOUT-V-PROP>VALUE</SW-RECORD-LAYOUT-V-PROP>
          </SW-RECORD-LAYOUT-V>
        </SW-RECORD-LAYOUT-GROUP>
      </SW-RECORD-LAYOUT-GROUP>
    </SW-RECORD-LAYOUT>
  </ELEMENTS>
</AR-PACKAGE>

```

The meaning of the standardized values of `SwRecordLayoutV.swRecordLayoutVProp` are documented in [TPS_SWCT_01489]. In the scope of this example the values `COUNT` and `VALUE` are used.

The fact that the `swRecordLayoutGroupTo` contains the value `-1` means that the iteration ends at the last element of the array.

Please note further that the discussed example of an `ApplicationPrimitiveDataType` of category `STRING` also contains the definition of an `invalidValue` for the string data type.

The next step is the definition of an `ImplementationDataType` that represents the string type on the implementation level. The definition of the `ImplementationDataType` can be derived from the definition of the applicable `SwRecordLayout`.

Please note that the `ImplementationDataType` **also** defines an `invalidValue`. As mentioned in [TPS_SWCT_01487], the consistency of the `invalidValue` defined in the scope of the `ApplicationPrimitiveDataType` of category `STRING` and the `invalidValue` defined in the scope of the corresponding `ImplementationDataType` cannot formally be checked.

Listing 5.3: Example for the definition of a string `ImplementationDataType`

```

<AR-PACKAGE>
  <SHORT-NAME>ImplementationDataTypes</SHORT-NAME>
  <ELEMENTS>
    <IMPLEMENTATION-DATA-TYPE>
      <SHORT-NAME>uint8</SHORT-NAME>
      <CATEGORY>VALUE</CATEGORY>
      <SW-DATA-DEF-PROPS>
        <SW-DATA-DEF-PROPS-VARIANTS>
          <SW-DATA-DEF-PROPS-CONDITIONAL>
            <BASE-TYPE-REF DEST="SW-BASE-TYPE">BaseTypes/uint8BaseType</
              BASE-TYPE-REF>
          </SW-DATA-DEF-PROPS-CONDITIONAL>
        </SW-DATA-DEF-PROPS-VARIANTS>
      </SW-DATA-DEF-PROPS>
    </IMPLEMENTATION-DATA-TYPE>
    <IMPLEMENTATION-DATA-TYPE>
      <SHORT-NAME>MyImplementationStringType</SHORT-NAME>
      <CATEGORY>STRUCTURE</CATEGORY>
      <SUB-ELEMENTS>
        <IMPLEMENTATION-DATA-TYPE-ELEMENT>
          <SHORT-NAME>size</SHORT-NAME>
          <CATEGORY>TYPE_REFERENCE</CATEGORY>
          <SW-DATA-DEF-PROPS>
            <SW-DATA-DEF-PROPS-VARIANTS>
              <SW-DATA-DEF-PROPS-CONDITIONAL>
                <IMPLEMENTATION-DATA-TYPE-REF DEST="IMPLEMENTATION-DATA-
                  TYPE">ImplementationDataTypes/uint8</IMPLEMENTATION-DATA-
                  TYPE-REF>
              <INVALID-VALUE>
                <NUMERICAL-VALUE-SPECIFICATION>
                  <VALUE>3</VALUE>
                </NUMERICAL-VALUE-SPECIFICATION>
              </INVALID-VALUE>
            </SW-DATA-DEF-PROPS-CONDITIONAL>
          </SW-DATA-DEF-PROPS-VARIANTS>
        </SW-DATA-DEF-PROPS>
      </SUB-ELEMENTS>
    </IMPLEMENTATION-DATA-TYPE>
  </ELEMENTS>

```

```

</IMPLEMENTATION-DATA-TYPE-ELEMENT>
<IMPLEMENTATION-DATA-TYPE-ELEMENT>
  <SHORT-NAME>string</SHORT-NAME>
  <CATEGORY>ARRAY</CATEGORY>
  <SUB-ELEMENTS>
    <IMPLEMENTATION-DATA-TYPE-ELEMENT>
      <SHORT-NAME>character</SHORT-NAME>
      <CATEGORY>TYPE_REFERENCE</CATEGORY>
      <ARRAY-SIZE>200</ARRAY-SIZE>
      <ARRAY-SIZE-SEMANTICS>FIXED-SIZE</ARRAY-SIZE-SEMANTICS>
      <SW-DATA-DEF-PROPS>
        <SW-DATA-DEF-PROPS-VARIANTS>
          <SW-DATA-DEF-PROPS-CONDITIONAL>
            <IMPLEMENTATION-DATA-TYPE-REF DEST="IMPLEMENTATION-DATA
              -TYPE">ImplementationDataTypes/uint8</IMPLEMENTATION
              -DATA-TYPE-REF>
            <INVALID-VALUE>
              <ARRAY-VALUE-SPECIFICATION>
                <ELEMENTS>
                  <NUMERICAL-VALUE-SPECIFICATION>
                    <VALUE>105</VALUE>
                  </NUMERICAL-VALUE-SPECIFICATION>
                  <NUMERICAL-VALUE-SPECIFICATION>
                    <VALUE>110</VALUE>
                  </NUMERICAL-VALUE-SPECIFICATION>
                  <NUMERICAL-VALUE-SPECIFICATION>
                    <VALUE>118</VALUE>
                  </NUMERICAL-VALUE-SPECIFICATION>
                </ELEMENTS>
              </ARRAY-VALUE-SPECIFICATION>
            </INVALID-VALUE>
          </SW-DATA-DEF-PROPS-CONDITIONAL>
        </SW-DATA-DEF-PROPS-VARIANTS>
      </SW-DATA-DEF-PROPS>
    </IMPLEMENTATION-DATA-TYPE-ELEMENT>
  </SUB-ELEMENTS>
</IMPLEMENTATION-DATA-TYPE-ELEMENT>
</SUB-ELEMENTS>
</IMPLEMENTATION-DATA-TYPE>
</ELEMENTS>
</AR-PACKAGE>

```

Please note that the size of the payload array in the definition of the `ImplementationDataType` in Listing 5.3 has been set to the value 200 in order to accommodate for the definition of `swMaxTextSize` in the definition of the corresponding `ApplicationDataType` in combination with the fact that the value of `baseTypeEncoding` has been set to `UTF-8`.

For background, the value of attribute `SwTextProps.swMaxTextSize` shall be specified as the number of *code points* in the string.

Each *code point* will be encoded by a sequence of bytes, depending on the applicable encoding. In the case of `UTF-8`, for example, each *code point* will be encoded by up to four bytes.

On the level of `ImplementationDataType`, an array designed to hold a string consisting of *code points* encoded using UTF-8 needs to be big enough to carry the number of *code points* (which may have been described by `SwTextProps.swMaxTextSize`) times 4 bytes.

The interesting part about this definition is the fact that on the implementation level, it was (driven by the definition of the `SwRecordLayout`) decided to implement the string as a structure of a size element (that goes by the `shortName` “size”) and a value element (that goes by the `shortName` “string”).

The value element is defined as an array data type and therefore has a sub-element that goes by the `shortName` “character”.

The latter references (in the role `swDataDefProps.implementationDataType`) the Platform Data Type “uint8” (that, according to the rules of Platform Data Types, is realized by an `ImplementationDataType` “uint8”).

Please note that the `ApplicationPrimitiveDataType` named “MyApplication-StringType” references the `SwBaseType` named “MyTextBaseType” which is defined in the following XML fragment:

Listing 5.4: Example for the definition of a string `SwBaseType`

```
<AR-PACKAGE>
  <SHORT-NAME>BaseTypes</SHORT-NAME>
  <ELEMENTS>
    <SW-BASE-TYPE>
      <SHORT-NAME>MyTextBaseType</SHORT-NAME>
      <CATEGORY>FIXED_LENGTH</CATEGORY>
      <BASE-TYPE-SIZE>8</BASE-TYPE-SIZE>
      <BASE-TYPE-ENCODING>UTF-8</BASE-TYPE-ENCODING>
    </SW-BASE-TYPE>
    <SW-BASE-TYPE>
      <SHORT-NAME>uint8BaseType</SHORT-NAME>
      <CATEGORY>FIXED_LENGTH</CATEGORY>
      <BASE-TYPE-SIZE>8</BASE-TYPE-SIZE>
    </SW-BASE-TYPE>
  </ELEMENTS>
</AR-PACKAGE>
```

The contribution of this definition of `SwBaseType` to the overall definition of a string data type is represented by the definition of the character encoding (which is set to UTF-8).

However, there is still one important part missing, i.e. the definition of the mapping of `ApplicationPrimitiveDataType` to `ImplementationDataType` (and vice versa, see Listing 5.5).

As mentioned before, the definition of an `ImplementationDataType` that corresponds to an `ApplicationPrimitiveDataType` of category `STRING` can be to some extent derived from the `ApplicationPrimitiveDataType.swDataDefProps.swRecordLayout`.

[TPS_SWCT_01570] `DataTypeMap` is mandatory in the presence of `ApplicationPrimitiveDataType.swDataDefProps.swRecordLayout` [The definition of a `DataTypeMap` is mandatory even if an `ImplementationDataType` has been derived from an `ApplicationPrimitiveDataType` that defines a `SwRecordLayout`.]()

Listing 5.5: Example for the definition of the applicable `DataTypeMappingSet`

```
<AR-PACKAGE>
  <SHORT-NAME>DataTypeMappingSets</SHORT-NAME>
  <ELEMENTS>
    <DATA-TYPE-MAPPING-SET>
      <SHORT-NAME>theExample</SHORT-NAME>
      <DATA-TYPE-MAPS>
        <DATA-TYPE-MAP>
          <APPLICATION-DATA-TYPE-REF BASE="default" DEST="APPLICATION-
            PRIMITIVE-DATA-TYPE">ApplicationDataTypes/
            MyApplicationStringType</APPLICATION-DATA-TYPE-REF>
          <IMPLEMENTATION-DATA-TYPE-REF BASE="default" DEST="IMPLEMENTATION-
            -DATA-TYPE">ImplementationDataTypes/MyImplementationStringType
          </IMPLEMENTATION-DATA-TYPE-REF>
        </DATA-TYPE-MAP>
      </DATA-TYPE-MAPS>
    </DATA-TYPE-MAPPING-SET>
  </ELEMENTS>
</AR-PACKAGE>
```

One motivation for the existence of [TPS_SWCT_01570] is that the integrator of an AUTOSAR ECU may rightfully decide to take a different `ImplementationDataType` other than the one that has been generated on the basis of the `SwRecordLayout`.

5.2.4.2 Application Composite Data Types

[TPS_SWCT_01247] `ApplicationArrayDataType` and `ApplicationRecordDataType` [The meta-classes `ApplicationArrayDataType` and `ApplicationRecordDataType` provide the means to define composite data types.

Such a composite data type is required if the application software wants to have access to the individual elements of the composite as well as to do operations with the whole composite, e.g. wants to communicate the complete record or array in a single transaction.

It is possible to use a combination of `ApplicationArrayDataType` and `ApplicationRecordDataType`, so that an `ApplicationArrayDataType` could be defined as `ApplicationRecordElement` of a `ApplicationRecordDataType` and in the same manner a `ApplicationRecordDataType` could be used as the base-type of an `ApplicationArrayDataType`. The creation of nested `ApplicationCompositeDataTypes` is also possible.]()

Details about meta-class `ApplicationRecordDataType` are depicted in Figure 5.11.

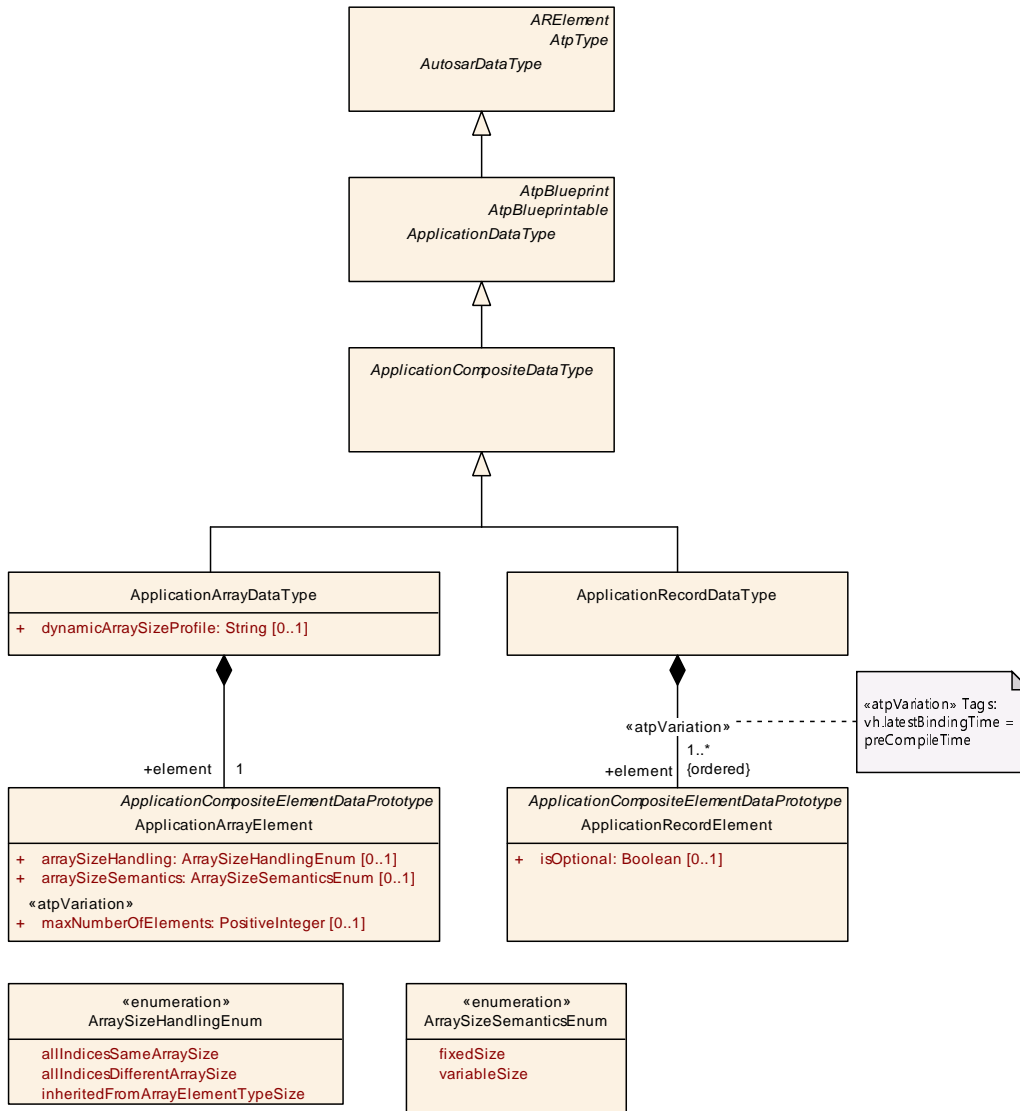

Figure 5.11: Summary of **ApplicationCompositeDataType**

5.2.4.2.1 ApplicationArrayDataType

[TPS_SWCT_01078] Configurable array size [An **ApplicationArrayDataType** may⁶ contain `numberOfElements` **ApplicationArrayElements**.

Each of these **ApplicationArrayElements** has the same data type.

When referring to an element of an **ApplicationArrayDataType** within a software-component description, the element-index runs from 0 to the value of `numberOfElements-1`.] (*RS_SWCT_03144*)

⁶This applies although the multiplicity in the meta-model is 1. In fact, it would be possible to model **ApplicationArrayDataType** without **ApplicationArrayElement**. The latter exists only so that it can be the target of a reference within an AUTOSAR XML file

Class	ApplicationArrayDataType			
Package	M2::AUTOSARTemplates::SWComponentTemplate::Datatype::Datatypes			
Note	An application data type which is an array, each element is of the same application data type. Tags: atp.recommendedPackage=ApplicationDataTypes			
Base	ARElement , ARObject , ApplicationCompositeDataType , ApplicationDataType , AtpBlueprint , AtpBlueprintable , AtpClassifier , AtpType , AutosarDataType , CollectableElement , Identifiable , MultilanguageReferrable , PackageableElement , Referrable			
Attribute	Type	Mult.	Kind	Note
dynamicArraySizeProfile	String	0..1	attr	Specifies the profile which the array will follow if it is a variable size array.
element	ApplicationArrayElement	1	aggr	This association implements the concept of an array element. That is, in some cases it is necessary to be able to identify single array elements, e.g. as input values for an interpolation routine.

Table 5.11: ApplicationArrayDataType

Class	ApplicationArrayElement			
Package	M2::AUTOSARTemplates::SWComponentTemplate::Datatype::DataPrototypes			
Note	Describes the properties of the elements of an application array data type.			
Base	ARObject , ApplicationCompositeElementDataPrototype , AtpFeature , AtpPrototype , DataPrototype , Identifiable , MultilanguageReferrable , Referrable			
Attribute	Type	Mult.	Kind	Note
arraySizeHandling	ArraySizeHandlingEnum	0..1	attr	The way how the size of the array is handled.
arraySizeSemantics	ArraySizeSemanticsEnum	0..1	attr	This attribute controls how the information about the array size shall be interpreted.
indexDataType	ApplicationPrimitiveDataType	0..1	ref	This reference can be taken to assign a CompuMethod of category TEXTTABLE to the array. The texttable entries associate a textual value to an index number such that the element with that index number is represented by a symbolic name.
maxNumberOfElements	PositiveInteger	0..1	attr	The maximum number of elements that the array can contain. Stereotypes: atpVariation Tags: vh.latestBindingTime=preCompileTime

Table 5.12: ApplicationArrayElement

Please note that the information about the number of elements of a specific [ApplicationArrayDataType](#) is not absolute but allows for further interpretation.

[TPS_SWCT_01076] Number of elements of a specific [ApplicationArray-DataType](#) might vary at run-time [That is, there are cases where the number of elements of a specific [ApplicationArrayDataType](#) might vary at run-time.

To be precise, the number of elements might vary between 0 and the value denoted by [maxNumberOfElements](#).

For this purpose an additional attribute [arraySizeSemantics](#) is available that can be used to clarify the meaning of [maxNumberOfElements](#).

For clarification, it might indeed happen that the actual number of elements in a specific `ApplicationArrayDataType` yields 0 simply because the respective `DataPrototype` is part of a higher-level protocol where under certain circumstances the `DataPrototype` of `ApplicationArrayDataType` is simply not required for expressing a given semantics. ([RS_SWCT_03180](#), [RS_SWCT_03181](#), [RS_SWCT_03144](#))

Enumeration	ArraySizeSemanticsEnum
Package	M2::AUTOSARTemplates::CommonStructure::ImplementationDataTypes
Note	This type controls how the information about the number of elements in an <code>ApplicationArrayDataType</code> is to be interpreted.
Literal	Description
fixedSize	This means that the <code>ApplicationArrayDataType</code> will always have a fixed number of elements. Tags: atp.EnumerationLiteralIndex=0
variableSize	This implies that the actual number of elements in the <code>ApplicationArrayDataType</code> might vary at run-time. The value of <code>arraySize</code> represents the maximum number of elements in the array. Tags: atp.EnumerationLiteralIndex=1

Table 5.13: ArraySizeSemanticsEnum

Please note that the ability to define the semantic meaning of `maxNumberOfElements` is not only limited to the application data type level. The same approach also applies for `ImplementationDataType`.

[constr_1152] category of `ApplicationArrayElement` and `AutosarDataType` referenced in the role `type` shall be kept in sync [The value of `category` of an `ApplicationArrayElement` shall always be identical to the value of `category` of the `AutosarDataType` referenced by the `ApplicationArrayElement`.]()

[TPS_SWCT_01601] Size Indicator shall be updated by software-component [If a software-component changes the number of valid elements in a variable size array, it shall also update the `Size Indicator` in the `ImplementationDataType`.] ([RS_SWCT_03181](#))

[TPS_SWCT_01602] Size Indicator shall be read by the software-component [If a software-component receives a variable size array, it shall use the `Size Indicator` in the `ImplementationDataType` to determine the number of valid elements in the array.] ([RS_SWCT_03181](#))

Enumeration	ArraySizeHandlingEnum
Package	M2::AUTOSARTemplates::SWComponentTemplate::Datatype::Datatypes
Note	This enumeration defines different ways to handle the sizes of variable size arrays.
Literal	Description
allIndicesDifferent ArraySize	All elements of the variable size array may have different sizes. Tags: atp.EnumerationLiteralIndex=0
allIndicesSame ArraySize	All elements of the variable size array have the same size. Tags: atp.EnumerationLiteralIndex=1





Enumeration	ArraySizeHandlingEnum
inheritedFromArray ElementTypeSize	The size of all dimensions of the variable size array is determined by the size of the contained array element. Tags: atp.EnumerationLiteralIndex=2

Table 5.14: ArraySizeHandlingEnum

5.2.4.2.1.1 Variable Size Array

[TPS_SWCT_01604] Enable [Size Indicator](#) [To enable the RTE's ability to consider the number of valid elements inside a [Variable-Size Array Data Type](#) the [ApplicationArrayType.dynamicArraySizeProfile](#) of [ApplicationArrayType](#) and [ApplicationArrayElement.arraySizeHandling](#) shall be set.]([RS_SWCT_03181](#))

[TPS_SWCT_01605] Semantics of [ApplicationArrayElement.arraySizeHandling](#) [The attribute [ApplicationArrayElement.arraySizeHandling](#) specifies how the size is determined in case of multi-dimensional variable size array.]([RS_SWCT_03181](#))

This allows to specify coherent relations between the sizes of the nested variable size arrays in case of multiple dimensions.

With a suitable [ImplementationDataType](#), it is possible to enable other software-components, RTE, and other BSW modules to make use of the [Size Indicator](#) and only transfer the valid data elements from the sender to the receiver.

[TPS_SWCT_01606] Internal structure of mapped [ImplementationDataType](#) [The attribute [dynamicArraySizeProfile](#) specifies which internal structure the [ImplementationDataType](#) that is mapped to the [ApplicationDataType](#) shall follow.]([RS_SWCT_03181](#))

[TPS_SWCT_01607] Profiles for internal structure of mapped [ImplementationDataType](#) [For the structure of the [ImplementationDataType](#) that is mapped to the [ApplicationDataType](#) the following profiles are defined for [dynamicArraySizeProfile](#): [VSA_LINEAR](#), [VSA_SQUARE](#), [VSA_RECTANGULAR](#), and [VSA_FULLY_FLEXIBLE](#).]([RS_SWCT_03181](#))

[TPS_SWCT_01608] Custom profiles for internal structure of mapped [ImplementationDataType](#) [Custom profiles can be added to [dynamicArraySizeProfile](#). They shall have a company-specific prefix.]([RS_SWCT_03181](#))

As it is a general rule for the definition of custom profiles or values of [category](#), the custom value should start with a company-specific prefix in order to avoid clashes with later extensions of the AUTOSAR standard.

`dynamicArraySizeProfile` is used to specify how the number of elements of the multiple dimensions of a variable size array correlate. They could be totally independent (`VSA_FULLY_FLEXIBLE`) on the one hand or each dimension has the same number of valid elements (`VSA_SQUARE`).

[TPS_SWCT_01623] Justification for the existence of attributes `ApplicationArrayDataType.dynamicArraySizeProfile` and `ApplicationArrayElement.arraySizeHandling` [At the first glance, the two attributes `ApplicationArrayDataType.dynamicArraySizeProfile` and `ApplicationArrayElement.arraySizeHandling` seem equivalent.

However, both are needed because they have to be used if multi dimensional variable size arrays have to be described. In this case, multiple combinations of sizes could occur which cannot be specified beforehand.] (*RS_SWCT_03181*)

The `ImplementationDataType` has to follow certain rules depending on the chosen profile. See chapter 5.2.5 for details.

[constr_1314] Profile `VSA_LINEAR` for `ApplicationArrayDataType` [If the `dynamicArraySizeProfile` of `ApplicationArrayDataType` is set to `VSA_LINEAR`, the contained `ApplicationArrayElement` shall fulfill **all** the following conditions:

- The attribute `ApplicationArrayElement.arraySizeSemantics` shall set to the value `variableSize`.
- The attribute `ApplicationArrayElement.maxNumberOfElements` shall be defined.
- The attribute `ApplicationArrayElement.arraySizeHandling` shall be set to the value `allIndicesSameArraySize`.
- The `ApplicationArrayElement` shall be typed by an `ApplicationDataType` that is not an `ApplicationArrayDataType` where the attribute `dynamicArraySizeProfile` exists.

]()

The part of **[constr_1314]** that demands that *the `ApplicationArrayElement` shall be typed by an `ApplicationDataType` that is not an `ApplicationArrayDataType` where the attribute `dynamicArraySizeProfile` exists* basically boils down to the simple explanation that the “leaf” data type of the `Variable-Size Array Data Type` can be anything but a `Variable-Size Array Data Type`.

[constr_1315] Profile `VSA_SQUARE` for `ApplicationArrayDataType` [If the `dynamicArraySizeProfile` of `ApplicationArrayDataType` is set to `VSA_SQUARE`, the contained `ApplicationArrayElement` shall fulfill **all** the following conditions:

- The attribute `ApplicationArrayElement.arraySizeSemantics` shall be set to the value `variableSize`.

- The attribute `ApplicationArrayElement.maxNumberOfElements` shall not be defined.
- The attribute `ApplicationArrayElement.arraySizeHandling` shall be set to the value `inheritedFromArrayElementTypeSize`.
- The `ApplicationArrayElement` shall be typed by an `ApplicationArrayDataType`.

The referred `ApplicationArrayDataType` shall refer over a chain (under consideration of the number of dimensions of the “root” `ApplicationArrayDataType`) of nested `ApplicationArrayDataTypes` with `ApplicationArrayElements` to an `ApplicationDataType` that is **not** an `ApplicationArrayDataType` where the attribute `dynamicArraySizeProfile` exists.

The last `ApplicationArrayDataType` in that chain shall have an `ApplicationArrayElement` that fulfills **all** the following conditions:

- The attribute `ApplicationArrayElement.arraySizeSemantics` shall be set to the value `variableSize`.
- The attribute `ApplicationArrayElement.maxNumberOfElements` shall be defined.
- The attribute `ApplicationArrayElement.arraySizeHandling` set to the value `allIndicesSameArraySize`.

All `ApplicationArrayDataTypes` before shall have an `ApplicationArrayElement` that fulfills **all** the following conditions:

- The attribute `ApplicationArrayElement.arraySizeSemantics` shall be set to the value `variableSize`.
- The attribute `ApplicationArrayElement.maxNumberOfElements` shall not be defined.
- The attribute `ApplicationArrayElement.arraySizeHandling` shall be set to the value `inheritedFromArrayElementTypeSize`.
- The `ApplicationArrayElement` shall be typed by an `ApplicationArrayDataType`.

]()

The part of [constr_1315], [constr_1316], and [constr_1317] that demands that *the referred `ApplicationArrayDataType` shall refer over a chain (under consideration of the number of dimensions of the “root” `ApplicationArrayDataType`) of nested `ApplicationArrayDataTypes` with `ApplicationArrayElements` to an `ApplicationDataType` that is **not** an `ApplicationArrayDataType` where the attribute `dynamicArraySizeProfile` exists* basically boils down to the simple explanation that the “leaf” data type of the `Variable-Size Array Data Type` can be anything but a `Variable-Size Array Data Type`.

[constr_1316] Profile **VSA_RECTANGULAR** for **ApplicationArrayDataType** [If the `dynamicArraySizeProfile` of `ApplicationArrayDataType` is set to `VSA_RECTANGULAR` the contained `ApplicationArrayElement` shall fulfill **all** the following conditions:

- The attribute `ApplicationArrayElement.arraySizeSemantics` shall be set to the value `variableSize`.
- The attribute `ApplicationArrayElement.maxNumberOfElements` shall be defined.
- The attribute `ApplicationArrayElement.arraySizeHandling` shall be set to the value `allIndicesSameArraySize`.
- The `ApplicationArrayElement` shall be typed by an `ApplicationArrayDataType`.

The referred `ApplicationArrayDataType` shall refer over a chain (under consideration of the number of dimensions of the “root” `ApplicationArrayDataType`) of nested `ApplicationArrayDataTypes` with `ApplicationArrayElements` to an `ApplicationDataType` that is **not** an `ApplicationArrayDataType` where the attribute `dynamicArraySizeProfile` exists.

The last `ApplicationArrayDataType` in that chain shall have an `ApplicationArrayElement` that fulfills **all** the following conditions:

- The attribute `ApplicationArrayElement.arraySizeSemantics` shall be set to the value `variableSize`.
- The attribute `ApplicationArrayElement.maxNumberOfElements` shall be defined.
- The attribute `ApplicationArrayElement.arraySizeHandling` shall be set to the value `allIndicesSameArraySize`.

All `ApplicationArrayDataTypes` before shall have an `ApplicationArrayElement` that fulfills **all** the following conditions:

- The attribute `ApplicationArrayElement.arraySizeSemantics` shall set to the value `variableSize`
- The attribute `ApplicationArrayElement.maxNumberOfElements` shall be defined.
- The attribute `ApplicationArrayElement.arraySizeHandling` shall be set to the value `allIndicesSameArraySize`.
- The `ApplicationArrayElement` shall be typed by an `ApplicationArrayDataType`.

]0

[constr_1317] Profile VSA_FULLY_FLEXIBLE for ApplicationArrayDataType

[If the `dynamicArraySizeProfile` of `ApplicationArrayDataType` is set to `VSA_FULLY_FLEXIBLE`, the contained `ApplicationArrayElement` shall fulfill **all** the following conditions:

- The attribute `ApplicationArrayElement.arraySizeSemantics` shall be set to the value `variableSize`.
- The attribute `ApplicationArrayElement.maxNumberOfElements` shall be defined.
- The attribute `ApplicationArrayElement.arraySizeHandling` shall be set to the value `allIndicesDifferentArraySize`.
- The `ApplicationArrayElement` shall be typed by an `ApplicationArrayDataType`.

The referred `ApplicationArrayDataType` shall refer over a chain (under consideration of the number of dimensions of the “root” `ApplicationArrayDataType`) of nested `ApplicationArrayDataTypes` with `ApplicationArrayElements` to an `ApplicationDataType` that is **not** an `ApplicationArrayDataType` where the attribute `dynamicArraySizeProfile` exist.

The last `ApplicationArrayDataType` in that chain shall have an `ApplicationArrayElement` that fulfills **all** the following conditions:

- The attribute `ApplicationArrayElement.arraySizeSemantics` shall be set to the value `variableSize`.
- The attribute `ApplicationArrayElement.maxNumberOfElements` shall be defined.
- The attribute `ApplicationArrayElement.arraySizeHandling` shall be set to the value `allIndicesSameArraySize`.

All `ApplicationArrayDataTypes` before shall have an `ApplicationArrayElement` that fulfills **all** the following conditions:

- The attribute `ApplicationArrayElement.arraySizeSemantics` shall be set to the value `variableSize`.
- The attribute `ApplicationArrayElement.maxNumberOfElements` shall be defined.
- The attribute `ApplicationArrayElement.arraySizeHandling` shall be set to the value `allIndicesDifferentArraySize`.
- The `ApplicationArrayElement` shall be typed by an `ApplicationArrayDataType`.

]()

For examples see Appendix E.1.

5.2.4.2.1.2 Multi-Dimensional Arrays

[TPS_SWCT_01256] Definition of multi-dimensional array data types [In order to describe multi dimensional arrays an `ApplicationArrayElement` references again another `ApplicationArrayDataType`. Hereby, one `ApplicationArray-DataType` per dimension is required.

This multiple dimensions do have a well-defined correlation to the individual dimensions of an `ImplementationDataType` of category `ARRAY` when the `ApplicationArrayDataType` is mapped to an `ImplementationDataType`.

The `ApplicationArrayElements` are mapping in the order of the `ApplicationArrayElement` to `ApplicationArrayDataType` references to `ImplementationDataTypeElements` in the order of first `ImplementationDataTypeElement` of the `ImplementationDataType` to leaf `ImplementationDataTypeElement`.

In other words the `ApplicationArrayElement` of the top-level `ApplicationArrayDataType` relates to the first `ImplementationDataTypeElement` of the `ImplementationDataType`.

The `ApplicationArrayElement` of the referenced `ApplicationArray-DataTypes` relates to the sub `ImplementationDataTypeElements` in the order of the `ApplicationArrayElement` to `ApplicationArrayDataType` references.] *(RS_SWCT_03216)*

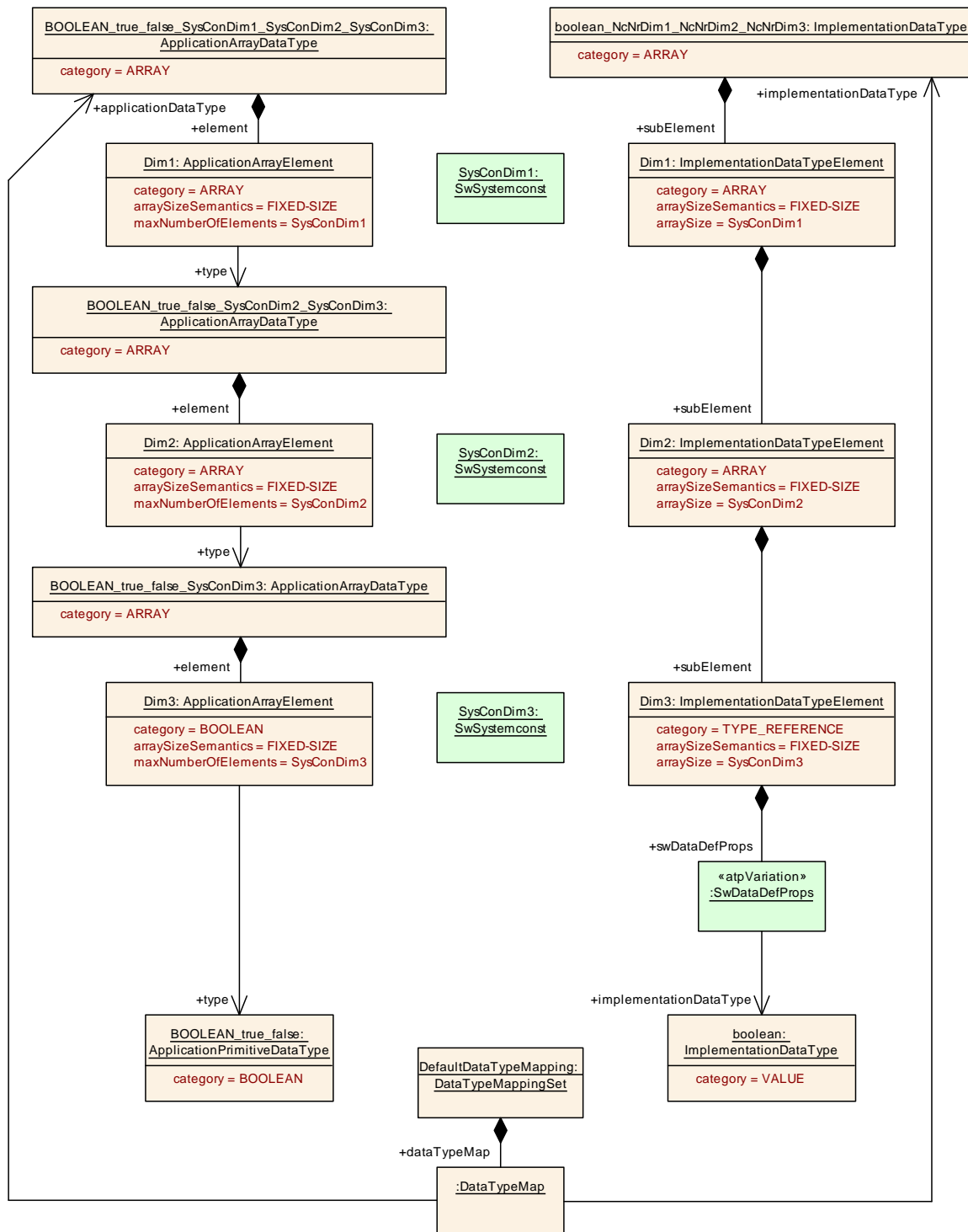

Figure 5.12: Example of a three-dimensional array type

Figure 5.12 shows a three-dimensional array described with a set of `ApplicationArrayDataTypes` on the left-hand side. The array element is typed by an `ApplicationPrimitiveDataType` of category `BOOLEAN`. On the right-hand side the implementation of the three-dimensional array is described with an `ImplementationDataType` which contains three nested `ImplementationDataTypeElements`.

Matching `ApplicationArrayElements` and `ImplementationDataTypeElements` are shown on the same layer. For the sake of clarity correlating `maxNumberOfElements` and `arraySize` attributes are described with the identical instance of a `SwSystemconst` instead of a value. Further details of variant rich M1 models are not in the scope of this example.

The data type of the array element is described by the `ApplicationArrayDataType` with the means of a `ApplicationPrimitiveDataType` of category `BOOLEAN`. In order to fulfill [\[constr_1152\]](#) the category of `ApplicationArrayElement` “Dim3” is set to `BOOLEAN`.

This `ApplicationPrimitiveDataType` “BOOLEAN” correlates to the `ImplementationDataType` “boolean” of category `VALUE` which is typically the boolean type of the AUTOSAR Platform Types. Please note here [\[constr_1063\]](#).

5.2.4.2.1.3 Index Data Type

The usage of an array represents an elegant way to group data with identical properties. This allows for an easy processing of the same functionality by iterating over the array elements.

From a functional point of view, however, each array element may have a distinct meaning that could be visible to the application software. To create this visibility, it is possible to take advantage of an existing mechanism: `CompuMethods` of category `TEXT-TABLE`.

[TPS_SWCT_01699] Usage of `ApplicationArrayElement.indexDataType`
[The primary use case of the attribute `ApplicationArrayElement.indexDataType` is the creation of composite data type mappings or the description of measurement and calibration. Furthermore, the information could be used for documentation purposes.] ([RS_SWCT_03230](#))

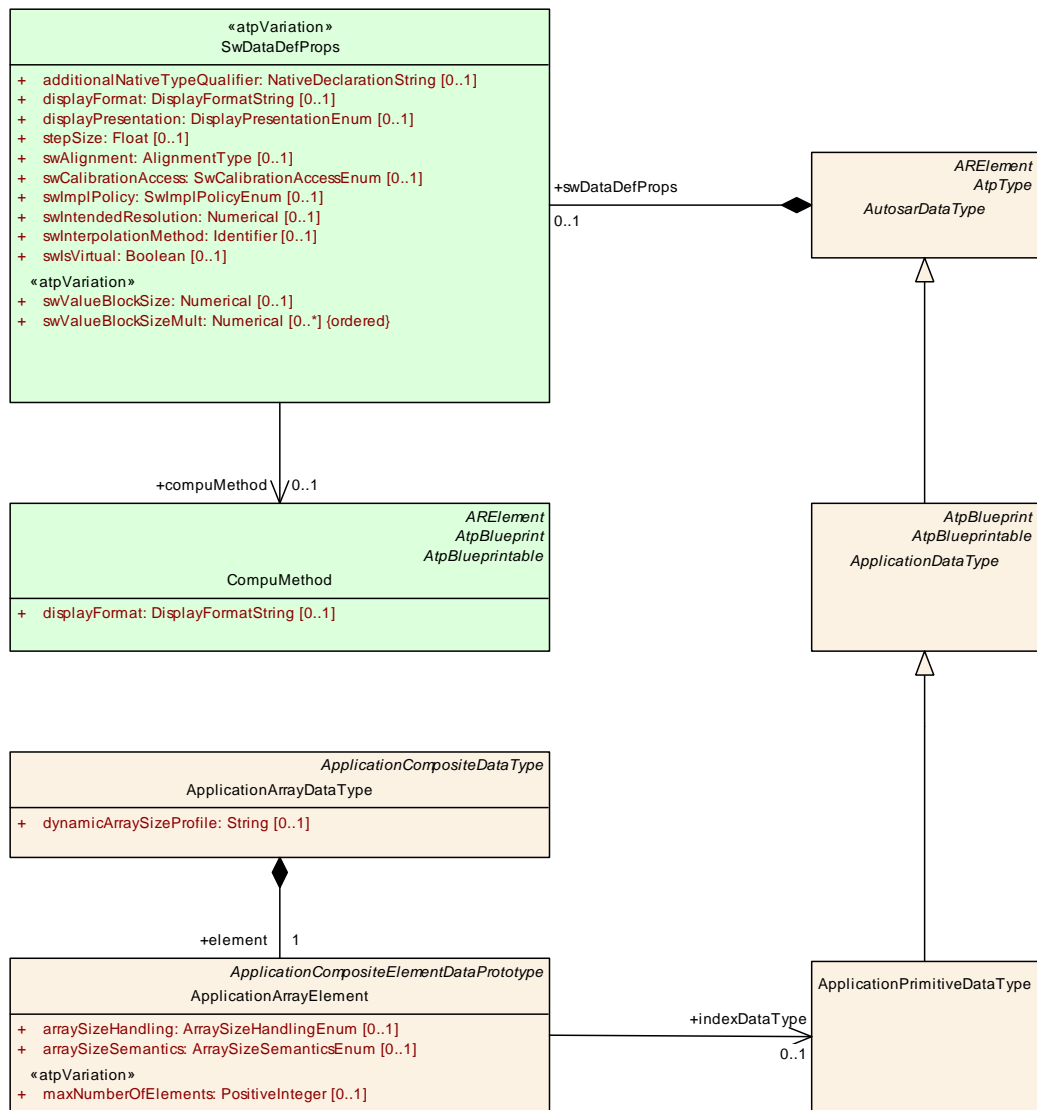

Figure 5.13: Modeling of the `ApplicationArrayElement.indexDataType`

[constr_1438] `ApplicationArrayElement.indexDataType` needs to refer to a `CompuMethod` of category `TEXTTABLE` [The reference `ApplicationArrayElement.indexDataType` shall only point to an `ApplicationPrimitiveDataType` that in turn refers to a `CompuMethod` of category `TEXTTABLE`.]()

[constr_1440] Size of the `CompuMethod` of category `TEXTTABLE` referenced by `ApplicationArrayElement.indexDataType` [The interval defined by the `CompuScales` contained in the `CompuMethod` referenced by `ApplicationArrayElement.indexDataType` shall start at 0 and include all integer values until `ApplicationArrayElement.maxNumberOfElements - 1`.]()

[constr_1439] Requirements on `ApplicationArrayElement` if attribute `indexDataType` exists [If `ApplicationArrayElement.indexDataType` exists then the attribute `ApplicationArrayElement.arraySizeSemantics` shall be set to the value `fixedSize` and attribute `arraySizeHandling` shall not exist.]()

Listing 5.6 exemplifies the definition of an `indexDataType`.

Listing 5.6: Example for array index data type

```

<APPLICATION-ARRAY-DATA-TYPE>
  <SHORT-NAME>CylinderArray</SHORT-NAME>
  <ELEMENT>
    <SHORT-NAME>CylinderArrayElement</SHORT-NAME>
    <ARRAY-SIZE-SEMANTICS>FIXED-SIZE</ARRAY-SIZE-SEMANTICS>
    <INDEX-DATA-TYPE-REF DEST="APPLICATION-PRIMITIVE-DATA-TYPE">
      myIndexDataType</INDEX-DATA-TYPE-REF>
    </ELEMENT>
  </APPLICATION-ARRAY-DATA-TYPE>
<APPLICATION-PRIMITIVE-DATA-TYPE>
  <SHORT-NAME>myIndexDataType</SHORT-NAME>
  <SW-DATA-DEF-PROPS>
    <SW-DATA-DEF-PROPS-VARIANTS>
      <SW-DATA-DEF-PROPS-CONDITIONAL>
        <COMPU-METHOD-REF DEST="COMPU-METHOD">cylinders</COMPU-METHOD-REF>
      </SW-DATA-DEF-PROPS-CONDITIONAL>
    </SW-DATA-DEF-PROPS-VARIANTS>
  </SW-DATA-DEF-PROPS>
</APPLICATION-PRIMITIVE-DATA-TYPE>

```

Listing 5.7 contains an example of a `CompuMethod` eligible for an `indexDataType`.

Listing 5.7: Example for a compu method used by an array index data type

```

<COMPU-METHOD>
  <SHORT-NAME>cylinders</SHORT-NAME>
  <CATEGORY>TEXTTABLE</CATEGORY>
  <COMPU-INTERNAL-TO-PHYS>
    <COMPU-SCALES>
      <COMPU-SCALE>
        <LOWER-LIMIT INTERVAL-TYPE="CLOSED">0</LOWER-LIMIT>
        <UPPER-LIMIT INTERVAL-TYPE="CLOSED">0</UPPER-LIMIT>
        <COMPU-CONST>
          <VT>Cylinder1</VT>
        </COMPU-CONST>
      </COMPU-SCALE>
      <COMPU-SCALE>
        <LOWER-LIMIT INTERVAL-TYPE="CLOSED">1</LOWER-LIMIT>
        <UPPER-LIMIT INTERVAL-TYPE="CLOSED">1</UPPER-LIMIT>
        <COMPU-CONST>
          <VT>Cylinder2</VT>
        </COMPU-CONST>
      </COMPU-SCALE>
      <COMPU-SCALE>
        <LOWER-LIMIT INTERVAL-TYPE="CLOSED">2</LOWER-LIMIT>
        <UPPER-LIMIT INTERVAL-TYPE="CLOSED">2</UPPER-LIMIT>
        <COMPU-CONST>
          <VT>Cylinder3</VT>
        </COMPU-CONST>
      </COMPU-SCALE>
      <COMPU-SCALE>
        <LOWER-LIMIT INTERVAL-TYPE="CLOSED">3</LOWER-LIMIT>
        <UPPER-LIMIT INTERVAL-TYPE="CLOSED">3</UPPER-LIMIT>

```

```

    <COMPU-CONST>
      <VT>Cylinder4</VT>
    </COMPU-CONST>
  </COMPU-SCALE>
</COMPU-SCALES>
</COMPU-INTERNAL-TO-PHYS>
</COMPU-METHOD>

```

5.2.4.2.2 ApplicationRecordDataType

[TPS_SWCT_01249] **ApplicationRecordDataType** [A declaration of [ApplicationRecordDataType](#) describes a non-empty set of objects, each of which has a unique identifier with respect to the [ApplicationRecordDataType](#) and each has an own [ApplicationDataType](#).

The [shortName](#) of each [ApplicationRecordElement](#) within the scope of an [ApplicationRecordDataType](#) shall be unique.] ([RS_SWCT_03216](#))

Class	ApplicationRecordDataType			
Package	M2::AUTOSARTemplates::SWComponentTemplate::Datatype::Datatypes			
Note	An application data type which can be decomposed into prototypes of other application data types. Tags: atp.recommendedPackage=ApplicationDataTypes			
Base	ARElement , ARObject , ApplicationCompositeDataType , ApplicationDataType , AtpBlueprint , AtpBlueprintable , AtpClassifier , AtpType , AutosarDataType , CollectableElement , Identifiable , MultilanguageReferrable , PackageableElement , Referrable			
Attribute	Type	Mult.	Kind	Note
element (ordered)	ApplicationRecordElement	1..*	aggr	Specifies an element of a record. The aggregation of ApplicationRecordElement is subject to variability with the purpose to support the conditional existence of elements inside a ApplicationrecordData Type. Stereotypes: atpVariation Tags: vh.latestBindingTime=preCompileTime

Table 5.15: ApplicationRecordDataType

Class	ApplicationRecordElement			
Package	M2::AUTOSARTemplates::SWComponentTemplate::Datatype::DataPrototypes			
Note	Describes the properties of one particular element of an application record data type.			
Base	ARObject , ApplicationCompositeElementDataPrototype , AtpFeature , AtpPrototype , DataPrototype , Identifiable , MultilanguageReferrable , Referrable			
Attribute	Type	Mult.	Kind	Note





Class	ApplicationRecordElement			
isOptional	Boolean	0..1	attr	<p>This attribute represents the ability to declare the enclosing ApplicationRecordElement as optional. This means the that, at runtime, the ApplicationRecord Element may or may not have a valid value and shall therefore be ignored.</p> <p>The underlying runtime software provides means to set the ApplicationRecordElement as not valid at the sending end of a communication and determine its validity at the receiving end.</p>

Table 5.16: ApplicationRecordElement

[TPS_SWCT_01771] Definition of optional elements on the level of [ApplicationDataType](#) [The modeling approach for the definition of optional elements on the level of [ApplicationDataType](#) is to set the attribute [ApplicationRecordElement.isOptional](#) to the value `True`.

If the attribute is not set or set to the value `False` then the respective [ApplicationRecordElement](#) **shall be considered mandatory.**] ([RS_SWCT_03320](#))

5.2.5 Implementation Data Type

[TPS_SWCT_01250] [ImplementationDataType](#) has been introduced to optimize the formal support for data type handling on the implementation level [The concept of an [ImplementationDataType](#) has been introduced to optimize the formal support for data type handling on the implementation level.

That is, an [ImplementationDataType](#) conceptually corresponds to the level of (C) source code. For example, [ImplementationDataTypes](#) have a direct impact on the contract (please find an explanation of this term in [2]) of a software-component and the RTE.]([RS_SWCT_03217](#))

Attributes of SwDataDefProps	Root Element				Attribute Existence per Category						
	ImplementationDataType	ImplementationDataTypeElement	SwPointerTargetProps	SwServiceArg	VALUE	DATA_REFERENCE	FUNCTION_REFERENCE	TYPE_REFERENCE	STRUCTURE	UNION	ARRAY
<code>additionalNativeTypeQualifier</code>	x	x	x	x	0..1	0..1	0..1	0..1	0..1	0..1	0..1
<code>annotation</code>	x	x	x	x	*	*	*	*	*	*	*
<code>baseType</code>	x	x	x	x	1						
<code>compuMethod</code>	x	x	x	x	0..1			0..1			
<code>dataConstr.dataConstrRule.physConstrs</code>	x	x	x	x	d/c ⁷			d/c			d/c
<code>dataConstr.dataConstrRule.internalConstrs</code>	x	x	x	x	0..1			0..1			0..1
<code>displayFormat</code>	x	x			0..1				0..1	0..1	0..1
<code>displayPresentation</code>	x	x			0..1						0..1
<code>implementationDataType</code>	x	x	x	x				1			
<code>invalidValue</code>	x	x	x		0..1			0..1	0..1 ⁸		0..1 ⁹
<code>stepSize</code>	x	x			0..1						
<code>swAddrMethod</code>	x	x	x		0..1	0..1	0..1	0..1	0..1	0..1	0..1
<code>swAlignment</code>	x				0..1	0..1	0..1		0..1	0..1	0..1
<code>swBitRepresentation</code>											
<code>swCalibrationAccess</code>	x	x			0..1			0..1	0..1	0..1	0..1
<code>swCalprmAxisSet</code>											
<code>swComparisonVariable</code>											
<code>swDataDependency</code>											
<code>swHostVariable</code>											
<code>swImplPolicy</code>	x		x	x	0..1	0..1	0..1	0..1	0..1	0..1	0..1
<code>swIntendedResolution</code>											
<code>swInterpolationMethod</code>											
<code>swIsVirtual</code>											
<code>swPointerTargetProps</code>	x	x	x	x		1	1				
<code>swPointerTargetProps .swDataDefProps</code>	x	x	x	x		1					
<code>swPointerTargetProps .functionPointerSignature</code>	x	x	x	x			1				
<code>swRecordLayout</code>											



⁷don't care

⁸There is a use case for the definition of an `invalidValue` for category `ARRAY` and therefore category `STRUCTURE` is also supported for the sake of symmetry.

⁹This represents an exception such that it would make sense to use an entire `ArrayValueSpecification` as the `invalidValue` because a string semantically is more than just a bunch of characters in a row.



Attributes of SwDataDefProps	Root Element				Attribute Existence per Category						
	ImplementationDataType	ImplementationDataTypeElement	SwPointerTargetProps	SwServiceArg	VALUE	DATA_REFERENCE	FUNCTION_REFERENCE	TYPE_REFERENCE	STRUCTURE	UNION	ARRAY
swRefreshTiming	x	x	x	x	0..1				0..1	0..1	0..1
swTextProps											
swValueBlockSize											
swValueBlockSizeMult											
unit											
valueAxisDataType											
Other Attributes											
subElement: ImplementationDataTypeElement	x	x							1..*	1..*	1
subElement.arraySizeSemantics	x	x									0..1
subElement.arraySize	x	x									1

Table 5.17: Allowed Attributes vs. `category` for `ImplementationDataType`

[constr_1694] Allowed target of `SwDataDefProps.implementationDataType`
 [The reference `SwDataDefProps.implementationDataType` shall only refer to an `ImplementationDataType`. Any other subclass of `AbstractImplementationDataType` is not supported as a reference target.]()

[TPS_SWCT_01251] Limited set of values for `category` are applicable for `ImplementationDataType`
 [Like any `AutosarDataType`, also the data types on implementation level are characterized by its `category` and its `SwDataDefProps`. For a given `category`, only a limited set of attributes of the `SwDataDefProps` makes sense.]([RS_SWCT_03217](#))

[constr_1009] `SwDataDefProps` applicable to `ImplementationDataTypes`
 [A complete list of the `SwDataDefProps` and other attributes and their multiplicities which are allowed for a given `category` is shown in table 5.17.]()

This list makes use of the `SwDataDefProps` and other meta-model elements which are explained in detail in the further sections of this chapter.

Regulations regarding the applicable `category`s for attribute `ImplementationDataType.swDataDefProps.compuMethod` can be found in [\[constr_1158\]](#) inside section 5.5.1.3.2.

[constr_1383] Existence of CompuMethod and DataConstr for ImplementationDataTypes of category TYPE_REFERENCE [The existence of `ImplementationDataType.swDataDefProps.compuMethod` and `ImplementationDataType.swDataDefProps.dataConstr` for `ImplementationDataTypes` of category `TYPE_REFERENCE` is only allowed if the respective `ImplementationDataType`, after all type references are resolved, ends up in an `ImplementationDataType` of category `VALUE`.]()

Please note that, as a consequence of the existence of [\[constr_1383\]](#), it is possible that the elements of a composite `ImplementationDataType` define individual `CompuMethods`. However, the definition of **one** `CompuMethod` that applies to the **entire** composite `ImplementationDataType` is not supported.

[TPS_SWCT_01252] ImplementationDataType can express concepts not available on application level [As a consequence of the specific focus, it is possible to express concepts with an `ImplementationDataType` that are not supported on the application level, i.e. by `ApplicationDataType`:

- `ImplementationDataType` supports the definition of pointers
- It is possible to define “alias” names just as in a `typedef`
- It is possible to define nested `ImplementationDataTypes` but in contrast to the concept implemented for `ApplicationDataType` these implement a direct aggregation of sub-elements rather than applying the type-prototype pattern.

]([RS_SWCT_03217](#))

The general structure of `ImplementationDataType` is sketched in [Figure 5.14](#). If a specific `ImplementationDataType` is supposed to define a composite data type, the `ImplementationDataType` aggregates `ImplementationDataTypeElements`.

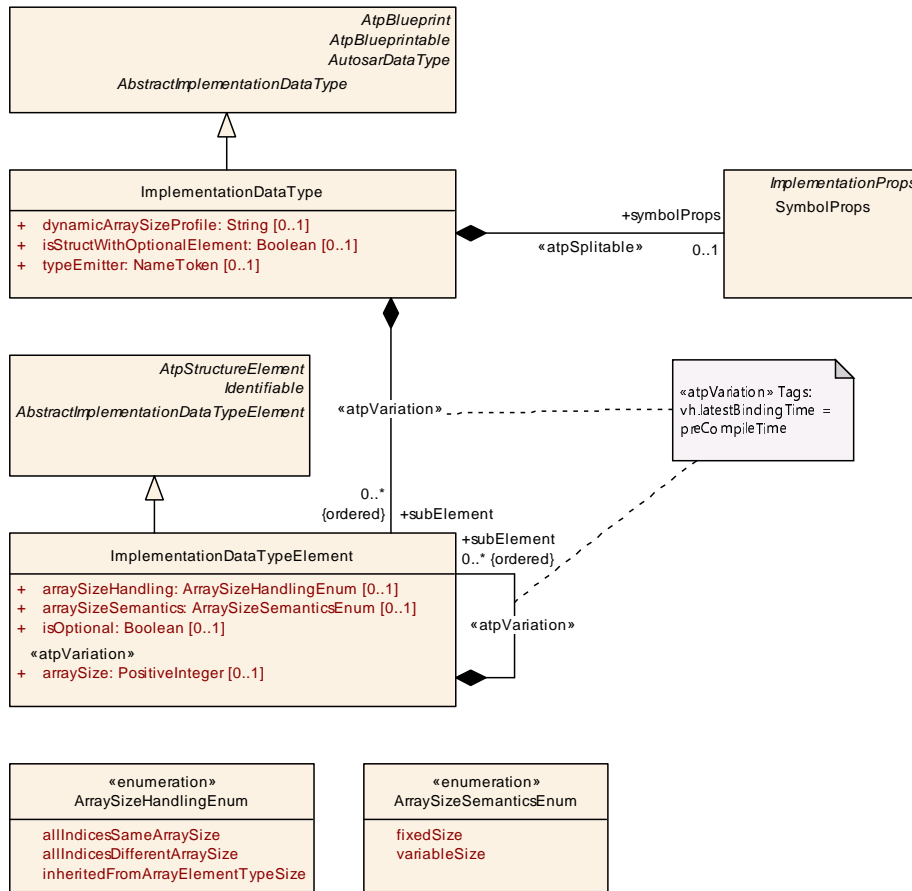

Figure 5.14: ImplementationDataType overview

Class	AbstractImplementationDataType (abstract)			
Package	M2::AUTOSARTemplates::CommonStructure::ImplementationDataTypes			
Note	This meta-class represents an abstract base class for different flavors of ImplementationDataType.			
Base	ARElement , ARObject , AtpBlueprint , AtpBlueprintable , AtpClassifier , AtpType , AutosarDataType , CollectableElement , Identifiable , MultilanguageReferrable , PackageableElement , Referrable			
Subclasses	ImplementationDataType			
Attribute	Type	Mult.	Kind	Note
-	-	-	-	-

Table 5.18: AbstractImplementationDataType

Class	ImplementationDataType			
Package	M2::AUTOSARTemplates::CommonStructure::ImplementationDataTypes			
Note	Describes a reusable data type on the implementation level. This will typically correspond to a typedef in C-code. Tags: atp.recommendedPackage=ImplementationDataTypes			
Base	ARElement , ARObject , AbstractImplementationDataType , AtpBlueprint , AtpBlueprintable , AtpClassifier , AtpType , AutosarDataType , CollectableElement , Identifiable , MultilanguageReferrable , PackageableElement , Referrable			





Class	ImplementationDataType			
Attribute	Type	Mult.	Kind	Note
dynamicArray SizeProfile	String	0..1	attr	Specifies the profile which the array will follow in case this data type is a variable size array.
isStructWith Optional Element	Boolean	0..1	attr	This attribute is only valid if the attribute category is set to STRUCTURE. If set to True, this attribute indicates that the ImplementationDataType has been created with the intention to define at least one element of the structure as optional.
subElement (ordered)	ImplementationData TypeElement	*	aggr	Specifies an element of an array, struct, or union data type. The aggregation of ImplementationDataTypeElement is subject to variability with the purpose to support the conditional existence of elements inside a ImplementationDataType representing a structure. Stereotypes: atpVariation Tags: vh.latestBindingTime=preCompileTime
symbolProps	SymbolProps	0..1	aggr	This represents the SymbolProps for the ImplementationDataType. Stereotypes: atpSplittable Tags: atp.Splitkey=shortName
typeEmitter	NameToken	0..1	attr	This attribute is used to control which part of the AUTOSAR toolchain is supposed to trigger data type definitions.

Table 5.19: ImplementationDataType

[TPS_SWCT_01253] Rules apply for the usage of the attribute **ImplementationDataType.typeEmitter** [The following set of rules applies for the usage of the attribute **ImplementationDataType.typeEmitter**:

- If the value of attribute **typeEmitter** is NOT defined **and** a **nativeDeclaration** is provided the RTE generator shall generate the corresponding data type definition¹⁰.
- If the value of attribute **typeEmitter** is set to “RTE” **and** a **nativeDeclaration** is provided the RTE generator shall generate the corresponding data type definition.
- If the value of the attribute **typeEmitter** is set to “RTE” **and** no **nativeDeclaration** is provided the RTE generator shall issue an error message.
- If the value of attribute **typeEmitter** is set to anything else but “RTE” the RTE generator shall silently **not** generate the corresponding data type definition regardless of the existence of **nativeDeclaration** attribute.

](RS_SWCT_03217)

¹⁰This rule represents the behavior before the attribute **typeEmitter** was introduced. The rule has specifically been added in order to support a backwards-compatible behavior.

Note that the rules listed above imply that the allowed values of the attribute `typeEmitter` are not constrained with the singular exception that the definition of the behavior in case of “RTE” is claimed by AUTOSAR.

Other values can be provided; the consequences of this provision are implementation-dependent and outside the scope of the definition of the AUTOSAR standard.

The usage of `ImplementationDataTypes` within an `AnyInstanceRef` is described in detail in [11].

[TPS_SWCT_01248] Nested definition of `ImplementationDataType` [If an `ImplementationDataTypeElement` also represents a composite data type, it can aggregate `ImplementationDataTypeElements` in the role of `subElement`. Again, the type-prototype pattern does not apply in this case.]([RS_SWCT_03217](#))

[constr_1106] Structure shall have at least one element [An `ImplementationDataType` or `ImplementationDataTypeElement` of category `STRUCTURE` shall own at least one `ImplementationDataTypeElement`.]()

[constr_1107] Union shall have at least one element [An `ImplementationDataType` or `ImplementationDataTypeElement` of category `UNION` shall own at least one `ImplementationDataTypeElement`.]()

Class	AbstractImplementationDataTypeElement (abstract)			
Package	M2::AUTOSARTemplates::CommonStructure::ImplementationDataTypes			
Note	This meta-class represents the ability to act as an abstract base class for specific derived meta-classes that support the modeling of <code>ImplementationDataTypes</code> for a particular language binding.			
Base	<code>ARObject</code> , <code>AtpClassifier</code> , <code>AtpFeature</code> , <code>AtpStructureElement</code> , Identifiable , MultilanguageReferrable , Referrable			
Subclasses	ImplementationDataTypeElement			
Attribute	Type	Mult.	Kind	Note
–	–	–	–	–

Table 5.20: AbstractImplementationDataTypeElement

Class	ImplementationDataTypeElement
Package	M2::AUTOSARTemplates::CommonStructure::ImplementationDataTypes
Note	<p>Declares a data object which is locally aggregated. Such an element can only be used within the scope where it is aggregated.</p> <p>This element either consists of further subElements or it is further defined via its <code>swDataDefProps</code>.</p> <p>There are several use cases within the system of <code>ImplementationDataTypes</code> for such a local declaration:</p> <ul style="list-style-type: none"> • It can represent the elements of an array, defining the element type and array size • It can represent an element of a struct, defining its type • It can be the local declaration of a debug element.
Base	<code>ARObject</code> , AbstractImplementationDataTypeElement , <code>AtpClassifier</code> , <code>AtpFeature</code> , <code>AtpStructureElement</code> , Identifiable , MultilanguageReferrable , Referrable





Class		ImplementationDataTypeElement		
Attribute	Type	Mult.	Kind	Note
arraySize	PositiveInteger	0..1	attr	The existence of this attributes (if bigger than 0) defines the size of an array and declares that this ImplementationDataTypeElement represents the type of each single array element. Stereotypes: atpVariation Tags: vh.latestBindingTime=preCompileTime
arraySize Handling	ArraySizeHandling Enum	0..1	attr	The way how the size of the array is handled in case of a variable size array.
arraySize Semantics	ArraySizeSemantics Enum	0..1	attr	This attribute controls the meaning of the value of the array size.
isOptional	Boolean	0..1	attr	This attribute represents the ability to declare the enclosing ImplementationDataTypeElement as optional. This means that, at runtime, the ImplementationDataTypeElement may or may not have a valid value and shall therefore be ignored. The underlying runtime software provides means to set the CppImplementationDataTypeElement as not valid at the sending end of a communication and determine its validity at the receiving end.
subElement (ordered)	ImplementationDataTypeElement	*	aggr	Element of an array, struct, or union in case of a nested declaration (i.e. without using "typedefs"). The aggregation of ImplementationDataTypeElement is subject to variability with the purpose to support the conditional existence of elements inside a ImplementationDataTypeElement representing a structure. Stereotypes: atpVariation Tags: vh.latestBindingTime=preCompileTime
swDataDef Props	SwDataDefProps	0..1	aggr	The properties of this ImplementationDataTypeElement.

Table 5.21: ImplementationDataTypeElement

[TPS_SWCT_01254] [ImplementationDataType](#) with array semantics [Of course, it is also possible to define an [ImplementationDataType](#) that provides array semantics.] ([RS_SWCT_03217](#))

[TPS_SWCT_01006] [ImplementationDataType.subElement.arraySize](#) shall be used to define the size of the array [The primitive attribute [ImplementationDataType.subElement.arraySize](#) shall be used to define the size of the array.]
()

[TPS_SWCT_01007] **Semantics of array index** [For an [ImplementationDataType](#) that implements an array data type, the semantics of the array index is such that

- it shall start with the value 0
- it shall run to the value of [arraySize](#) -1

]()

[constr_1105] **Value of [arraySize](#)** [The value of the attribute [arraySize](#) of an [ImplementationDataTypeElement](#) owned by an [ImplementationDataType](#) or

`ImplementationDataTypeElement` of category `ARRAY` shall be greater than 0 unless attribute `ImplementationDataTypeElement.arraySizeHandling` exists and is set to the value `inheritedFromArrayElementTypeSize.`()

[TPS_SWCT_01478] Array size is defined as an attribute of the `ImplementationDataTypeElement` [Please note that the array size is **not** defined as an attribute of the `ImplementationDataType` which stands for the whole array.

It is actually defined as an attribute of the `ImplementationDataTypeElement` which is describing the array element (note that the same pattern is used in `ApplicationArrayDataType`).]()

Consequently, if a “struct” element represents an array this specific struct-element is given by an `ImplementationDataTypeElement` of category `ARRAY` which in turn aggregates another `ImplementationDataTypeElement` of e.g. category `VALUE` representing the array element and containing the size.

[TPS_SWCT_01255] Indicate whether the array is supposed to have a fixed size or whether the actual size might change during run-time [It is also possible to indicate whether the array is supposed to have a fixed size or whether the actual size might change during run-time.]([RS_SWCT_03217](#))

In the same way as for `ApplicationDataTypes`, it is also possible to specify a `Size Indicator` of a variable size array which holds the number of valid elements of the array in the `ImplementationDataType`.

Please find more information about this topic in section [5.2.4.2](#).

[TPS_SWCT_01622] Modeling of a Variable-Size Array Data Type only with `ImplementationDataType` [The modeling of a `Variable-Size Array Data Type` does not require the existence of an `ApplicationComposite-DataType` and a `DataTypeMap`. A `Variable-Size Array Data Type` can be created by just setting up an `ImplementationDataType`.]([RS_SWCT_03181](#))

[TPS_SWCT_01610] Modeling of a Variable-Size Array Data Type with `Size Indicator` enabled [An `ImplementationDataType` with category `STRUCTURE` where the attribute `ImplementationDataType.dynamicArray-SizeProfile` exists represents a `Variable-Size Array Data Type` with `Size Indicator` enabled.

For the sake of a proper definition of terminology, this `ImplementationDataType` shall be called the `VSA ImplementationDataType`.]([RS_SWCT_03181](#))

[TPS_SWCT_01650] Structure of the `VSA ImplementationDataType` [The `VSA ImplementationDataType` shall consist of

- an `ImplementationDataTypeElement` representing the `Size Indicator` and
- an `ImplementationDataTypeElement` representing the `Payload` of the `Variable-Size Array Data Type`.

For the sake of a proper definition of terminology, these `ImplementationDataTypeElements` shall be called the VSA Size Indicator `ImplementationDataTypeElement` and the VSA Payload `ImplementationDataTypeElement` respectively. *(RS_SWCT_03181)*

[TPS_SWCT_01612] `arraySizeHandling` specifies how the size is determined [`arraySizeHandling` specifies how the size is determined in case of multi-dimensional variable size array.] *(RS_SWCT_03181)*

The statement made by `[TPS_SWCT_01612]` allows the specification of coherency between the sizes of the nested variable size arrays in case of multiple dimensions.

[TPS_SWCT_01613] Internal structure of mapped `ImplementationDataType` [The attribute `dynamicArraySizeProfile` specifies which internal structure the `ImplementationDataType` shall follow.] *(RS_SWCT_03181)*

[TPS_SWCT_01614] Profiles for internal structure of mapped `ImplementationDataType` [For the structure of the `ImplementationDataType` the following profiles are defined for `dynamicArraySizeProfile`: `VSA_LINEAR`, `VSA_SQUARE`, `VSA_RECTANGULAR` and `VSA_FULLY_FLEXIBLE`.] *(RS_SWCT_03181)*

[TPS_SWCT_01615] Custom profiles for internal structure of mapped `ImplementationDataType` [Custom profiles can be added to `dynamicArraySizeProfile`. They shall have a company-specific prefix.] *(RS_SWCT_03181)*

For reasons of readability and comprehensibility the following constraints focus on the payload of the `Variable-Size Array Data Type` only. For the `Size Indicator` additional individual constraints do apply.

[constr_1318] Profile `VSA_LINEAR` for `ImplementationDataType` [If the value of attribute `ImplementationDataType.dynamicArraySizeProfile` is set to `VSA_LINEAR`, the `ImplementationDataType` shall aggregate a `VSA Payload ImplementationDataTypeElement` that fulfills all the following conditions:

- The attribute `ImplementationDataTypeElement.arraySizeSemantics` shall not be defined.
- The attribute `ImplementationDataTypeElement.category` shall be set to `ARRAY`.
- The attribute `ImplementationDataTypeElement.arraySize` shall not be defined.
- The attribute `ImplementationDataTypeElement.arraySizeHandling` shall not be defined.

The `VSA Payload ImplementationDataTypeElement` shall immediately aggregate another `ImplementationDataTypeElement` that shall fulfill all the following conditions:

- The attribute `ImplementationDataTypeElement.arraySizeSemantics` shall be set to the value `variableSize`.

- The attribute `ImplementationDataTypeElement.arraySize` shall be defined.
- The attribute `ImplementationDataTypeElement.arraySizeHandling` shall be set to the value `allIndicesSameArraySize`.

]()

Please note that the `ImplementationDataTypeElement` aggregated by the `VSA Payload ImplementationDataTypeElement` can basically have any possible value of the attribute `category`.

[constr_1319] Profile VSA_SQUARE for ImplementationDataType [If the value of attribute `ImplementationDataType.dynamicArraySizeProfile` is set to `VSA_SQUARE`, the `ImplementationDataType` shall aggregate a `VSA Payload ImplementationDataTypeElement` that fulfills all the following conditions:

- The attribute `ImplementationDataTypeElement.arraySizeSemantics` shall not be defined.
- The attribute `ImplementationDataTypeElement.category` shall be set to the value `ARRAY`.
- The attribute `ImplementationDataTypeElement.arraySize` shall not be defined.
- The attribute `ImplementationDataTypeElement.arraySizeHandling` shall not be defined.

The `VSA Payload ImplementationDataTypeElement` shall immediately aggregate another `ImplementationDataTypeElement` (representing the first dimension) that shall fulfill all the following conditions:

- The attribute `ImplementationDataTypeElement.arraySizeSemantics` shall be set to the value `variableSize`.
- The attribute `ImplementationDataTypeElement.category` shall be set to the value `ARRAY`.
- The attribute `ImplementationDataTypeElement.arraySize` shall not be defined.
- The attribute `ImplementationDataTypeElement.arraySizeHandling` shall be set to the value `inheritedFromArrayElementTypeSize`.

All **intermediate** `ImplementationDataTypeElements` in the aggregation chain that do not terminate the chain shall fulfill all the following conditions:

- The attribute `ImplementationDataTypeElement.arraySizeSemantics` shall be set to the value `variableSize`.
- The attribute `ImplementationDataTypeElement.category` shall be set to the value `ARRAY`.

- The attribute `ImplementationDataTypeElement.arraySize` shall not be defined.
- The attribute `ImplementationDataTypeElement.arraySizeHandling` shall be set to the value `inheritedFromArrayElementTypeSize`.

The **terminating** `ImplementationDataTypeElement` in the aggregation chain shall fulfill all the following conditions:

- The attribute `ImplementationDataTypeElement.arraySizeSemantics` shall be set to the value `variableSize`.
- The attribute `ImplementationDataTypeElement.arraySize` shall be defined.
- The attribute `ImplementationDataTypeElement.arraySizeHandling` shall be set to the value `allIndicesSameArraySize`.

]()

[constr_1320] Profile `VSA_RECTANGULAR` for `ImplementationDataType` [If the value of attribute `ImplementationDataType.dynamicArraySizeProfile` is set to `VSA_RECTANGULAR`, the `ImplementationDataType` shall aggregate a `VSA Payload ImplementationDataTypeElement` that fulfills all the following conditions:

- The attribute `ImplementationDataTypeElement.arraySizeSemantics` shall not be defined.
- The attribute `ImplementationDataTypeElement.category` shall be set to the value `ARRAY`.
- The attribute `ImplementationDataTypeElement.arraySize` shall not be defined.
- The attribute `ImplementationDataTypeElement.arraySizeHandling` shall not be defined.

The `VSA Payload ImplementationDataTypeElement` shall immediately aggregate another `ImplementationDataTypeElement` (representing the first dimension) that shall fulfill all the following conditions:

- The attribute `ImplementationDataTypeElement.category` shall be set to the value `ARRAY`.
- The attribute `ImplementationDataTypeElement.arraySizeSemantics` shall be set to the value `variableSize`.
- The attribute `ImplementationDataTypeElement.arraySize` shall be defined.
- The attribute `ImplementationDataTypeElement.arraySizeHandling` shall be set to the value `allIndicesSameArraySize`.

All **intermediate** `ImplementationDataTypeElements` in the aggregation chain that do not terminate the chain shall fulfill all the following conditions:

- The attribute `ImplementationDataTypeElement.category` shall be set to the value `ARRAY`.
- The attribute `ImplementationDataTypeElement.arraySizeSemantics` shall be set to the value `variableSize`.
- The attribute `ImplementationDataTypeElement.arraySize` shall be defined.
- The attribute `ImplementationDataTypeElement.arraySizeHandling` shall be set to the value `allIndicesSameArraySize`.

The **terminating** `ImplementationDataTypeElement` in the aggregation chain shall fulfill all the following conditions:

- The attribute `ImplementationDataTypeElement.arraySizeSemantics` shall be set to the value `variableSize`.
- The attribute `ImplementationDataTypeElement.arraySize` shall be defined.
- The attribute `ImplementationDataTypeElement.arraySizeHandling` shall be set to the value `allIndicesSameArraySize`.

]()

[constr_1321] Profile `VSA_FULLY_FLEXIBLE` for `ImplementationDataType` [If the value of attribute `ImplementationDataType.dynamicArraySizeProfile` is set to the value `VSA_FULLY_FLEXIBLE`, the `ImplementationDataType` shall aggregate a `VSA Payload ImplementationDataTypeElement` that fulfills all the following conditions:

- The attribute `ImplementationDataTypeElement.arraySizeSemantics` shall not be defined.
- The attribute `ImplementationDataTypeElement.category` shall be set to the value `ARRAY`.
- The attribute `ImplementationDataTypeElement.arraySize` shall not be defined
- The attribute `ImplementationDataTypeElement.arraySizeHandling` shall not be defined.

The `VSA Payload ImplementationDataTypeElement` shall immediately aggregate another `ImplementationDataTypeElement` (representing the first dimension) that shall fulfill all the following conditions:

- The attribute `ImplementationDataTypeElement.category` shall be set to `STRUCTURE`

- The attribute `ImplementationDataTypeElement.arraySizeSemantics` shall be set to the value `variableSize`.
- The attribute `ImplementationDataTypeElement.arraySize` shall be defined.
- The attribute `ImplementationDataTypeElement.arraySizeHandling` shall be set to the value `allIndicesDifferentArraySize`.

The `ImplementationDataTypeElement` shall aggregate another `ImplementationDataTypeElement` that fulfills the following conditions:

- The attribute `ImplementationDataTypeElement.arraySizeSemantics` shall not be defined.
- The attribute `ImplementationDataTypeElement.category` shall be set to the value `ARRAY`.
- The attribute `ImplementationDataTypeElement.arraySize` shall not be defined.
- The attribute `ImplementationDataTypeElement.arraySizeHandling` shall not be defined.

The **aggregation chain is continued** by a (possible empty) sequence of a pair of `ImplementationDataTypeElements` with the following characteristics:

- The first `ImplementationDataTypeElement` in the pair shall fulfill all the following conditions:
 - The attribute `ImplementationDataTypeElement.category` shall be set to `STRUCTURE`.
 - The attribute `ImplementationDataTypeElement.arraySizeSemantics` shall be set to the value `variableSize`.
 - The attribute `ImplementationDataTypeElement.arraySize` shall be defined.
 - The attribute `ImplementationDataTypeElement.arraySizeHandling` shall be set to the value `allIndicesDifferentArraySize`.
- The second `ImplementationDataTypeElement` in the pair shall fulfill all the following conditions:
 - The attribute `ImplementationDataTypeElement.arraySizeSemantics` shall not be defined.
 - The attribute `ImplementationDataTypeElement.category` shall be set to the value `ARRAY`.
 - The attribute `ImplementationDataTypeElement.arraySize` shall not be defined.

- The attribute `ImplementationDataTypeElement.arraySizeHandling` shall not be defined.

The **terminating** `ImplementationDataTypeElement` in the aggregation chain shall fulfill all the following conditions:

- The attribute `ImplementationDataTypeElement.arraySizeSemantics` shall be set to the value `variableSize`.
- The attribute `ImplementationDataTypeElement.arraySize` shall be defined.
- The attribute `ImplementationDataTypeElement.arraySizeHandling` shall be set to the value `allIndicesSameArraySize`.

]()

[constr_1396] Restriction for the value of attribute `category` for non-terminating `ImplementationDataTypeElements` taken to model a `Variable-Size Array Data Type` [The value of attribute `category` for non-terminating `ImplementationDataTypeElements` taken to model a `Variable-Size Array Data Type` shall **not** be set to `TYPE_REFERENCE`.]()

[constr_1322] Size Indicator for undefined `dynamicArraySizeProfile` [If the `ImplementationDataType.dynamicArraySizeProfile` does not exist but the `ImplementationDataType` is mapped to an `ApplicationArrayDataType` where the attribute `ApplicationArrayDataType.dynamicArraySizeProfile` exists, then the `ImplementationDataType` shall have the `category` `STRUCTURE`, representing a `Variable-Size Array Data Type` with `Size Indicator` enabled.]()

[TPS_SWCT_01617] Structure of an `ImplementationDataType` that represents a variable-sized array data type [The `ImplementationDataType` that represents a `Variable-Size Array Data Type` shall have the `category` `STRUCTURE` that has two `subElements`.

The role of the `subElements` with the definition of a `Variable-Size Array Data Type` is defined by [TPS_SWCT_01618], [TPS_SWCT_01619], [TPS_SWCT_01620], and [TPS_SWCT_01621].] (*RS_SWCT_03181*)

[TPS_SWCT_01618] Size Indicator for `dynamicArraySizeProfile` set to `VSA_LINEAR`, `VSA_SQUARE`, or `VSA_FULLY_FLEXIBLE` [If an `ImplementationDataType` is mapped to an `ApplicationArrayDataType` which has the attribute `dynamicArraySizeProfile` set to the value `VSA_LINEAR`, `VSA_SQUARE` or `VSA_FULLY_FLEXIBLE`, the **first** `ImplementationDataType.subElement` shall be an integer large enough to hold the maximum number of valid elements of the variable size array (according to `maxNumberOfElements`).

This is the `Size Indicator` which holds the current number of valid elements of the variable size array.] (*RS_SWCT_03181*)

[TPS_SWCT_01647] Size Indicator for dynamicArraySizeProfile set to VSA_LINEAR, VSA_SQUARE, or VSA_FULLY_FLEXIBLE if only ImplementationDataType is present [For each ImplementationDataType which has the attribute dynamicArraySizeProfile set to the value VSA_LINEAR, VSA_SQUARE, or VSA_FULLY_FLEXIBLE, the first ImplementationDataType.subElement shall be an integer large enough to hold the maximum number of valid elements of the variable size array (according to arraySize).

This is the Size Indicator which holds the current number of valid elements of the Variable-Size Array Data Type.](RS_SWCT_03181)

[TPS_SWCT_01619] Size Indicator for dynamicArraySizeProfile set to VSA_RECTANGULAR [If an ImplementationDataType is mapped to an ApplicationArrayDataType where the attribute ApplicationArrayDataType.dynamicArraySizeProfile exists and is set to the value VSA_RECTANGULAR, the first ImplementationDataType.subElement shall be a ImplementationDataTypeElement with the category set to ARRAY and the attribute arraySize set to a value equal to the number of the according dimension of the corresponding ApplicationDataType.](RS_SWCT_03181)

[TPS_SWCT_01648] Size Indicator for dynamicArraySizeProfile set to VSA_RECTANGULAR if only ImplementationDataType is present [For each ImplementationDataType where the attribute ImplementationDataType.dynamicArraySizeProfile exists and is set to the value VSA_RECTANGULAR, the first ImplementationDataType.subElement shall be a ImplementationDataTypeElement with the category set to ARRAY and the attribute arraySize set to a value equal to the size of the according dimension of the rectangular array.](RS_SWCT_03181)

[TPS_SWCT_01620] Size Indicator for dynamicArraySizeProfile set to VSA_RECTANGULAR [The elements of this Size Indicator array shall consist of integers large enough to hold the maximum number of valid elements (according to maxNumberOfElements).](RS_SWCT_03181)

This array holds the Size Indicators of all dimensions.

[TPS_SWCT_01621] Payload for dynamicArraySizeProfile [If an ImplementationDataType is mapped to an ApplicationArrayDataType where the attribute dynamicArraySizeProfile exists, the second ImplementationDataType.subElement shall be an array which can hold the data of the variable size array with all dimensions defined for the ApplicationDataType.

The category shall be set to ARRAY and arraySize shall be set to maxNumberOfElements of the corresponding ApplicationArrayDataType.](RS_SWCT_03181)

[TPS_SWCT_01649] Payload for dynamicArraySizeProfile if only ImplementationDataType is present [Each ImplementationDataType where the attribute dynamicArraySizeProfile exists shall aggregate a second ImplementationDataType.subElement with the category set to ARRAY.](RS_SWCT_03181)

For examples, see Appendix E.1.

An `ImplementationDataType` is also allowed to have `SwDataDefProps` (this feature is inherited from `AutosarDataType`), i.e. it can define various specific structural and semantical attributes. Table 5.41 shows which `SwDataDefProps` will be typically used here.

[TPS_SWCT_01257] `ImplementationDataType` or the aggregated `ImplementationDataTypeElements` do not form closed sets [An `ImplementationDataType` or the aggregated `ImplementationDataTypeElements` do not form closed sets but refer to further type definitions in one of four distinctive ways, depending on whether the type is implemented via a base type, a data or function pointer, or a reference to another implementation data type:

1. Reference to an underlying `SwBaseType` corresponds to `category VALUE`.
2. Reference to `BswModuleEntry` in `SwPointerTargetProps` corresponds to `category FUNCTION_REFERENCE`.
3. `SwDataDefProps` in `SwPointerTargetProps` corresponds to `category DATA_REFERENCE`.
4. Reference to another `ImplementationDataType` corresponds to `category TYPE_REFERENCE`.

](*RS_SWCT_03217*)

At the end, all the “leaves” of the complete tree formed by these references shall end up in `SwBaseTypes`. Figures 5.15, 5.16, and Figure 5.17 illustrate more examples about Typedefs and references.

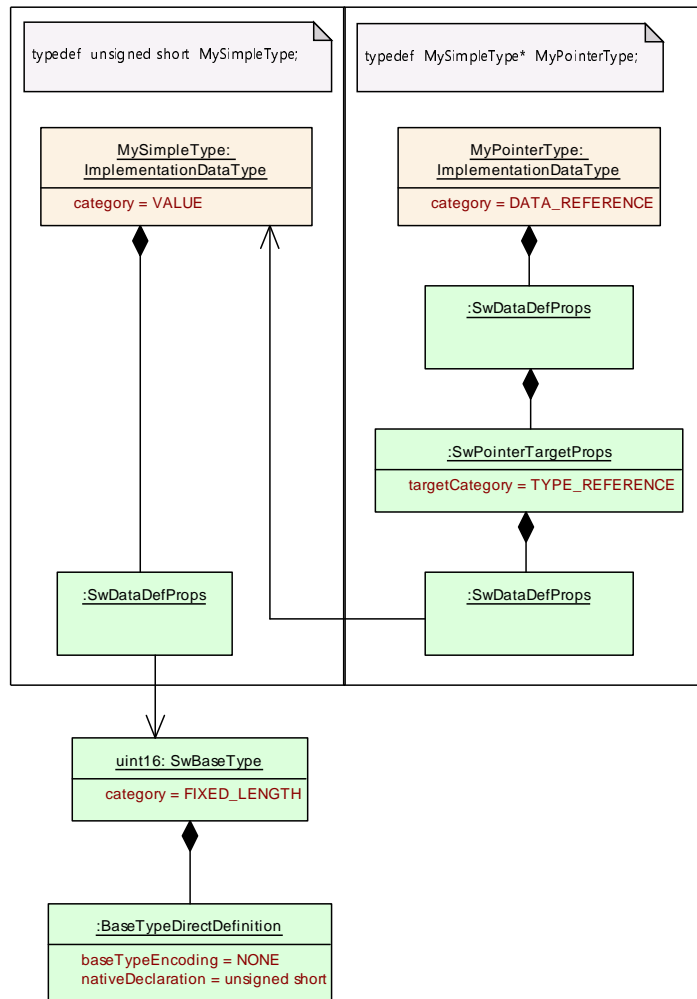

Figure 5.15: Example (1) for TypeDefs

[TPS_SWCT_01258] Definition of a pointer to data [The definition of a data pointer requires a special meta-class `SwPointerTargetProps` which aggregates another `SwDataDefProps`. This mechanism allows to describe the `category` and properties of the pointer object itself as well as the `category` and properties of its target data type.] (*RS_SWCT_03217*)

[constr_1177] Allowed `targetCategory` for `SwPointerTargetProps` [The value of `targetCategory` for `SwPointerTargetProps` can only be one of `TYPE_REFERENCE` or `FUNCTION_REFERENCE`.]

The only exception to this rule applies if the `swDataDefProps` owned by the `SwPointerTargetProps` refers to a `SwBaseType` with native type declaration `void`, in this case `VALUE` is also permitted.] ()

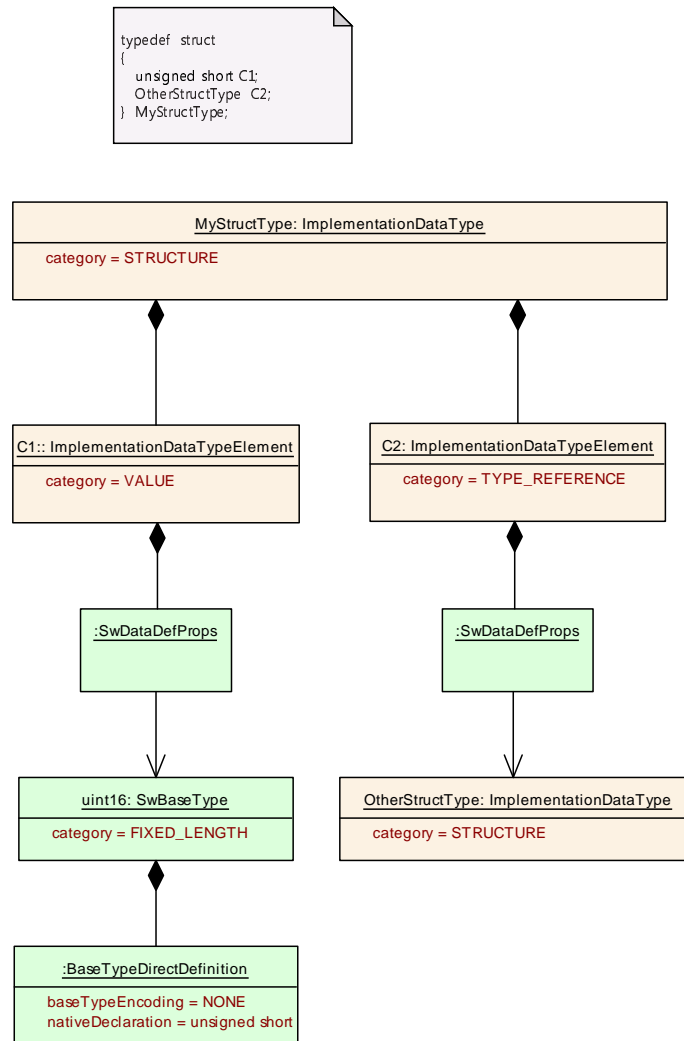

Figure 5.16: Example (2) for TypeDefs

As far as the AUTOSAR meta-model is concerned, a pointer to a pointer **could** in principle be implemented in two ways:

1. by defining an `ImplementationDataType` of category `DATA_REFERENCE` that aggregates `SwDataDefProps` in the role `swDataDefProps` that in turn aggregate `SwPointerTargetProps` in the role `swPointerTargetProps` with attribute `targetCategory` set to `TYPE_REFERENCE` that aggregates `SwDataDefProps` in the role `swDataDefProps` that references an `ImplementationDataType` of category `DATA_REFERENCE`.
2. by defining an `ImplementationDataType` of category `DATA_REFERENCE` that aggregates `SwDataDefProps` in the role `swDataDefProps` that in turn aggregate `SwPointerTargetProps` in the role `swPointerTargetProps` with attribute `targetCategory` set to `DATA_REFERENCE` (which is not allowed according to [constr_1177]) that in turn aggregates `SwDataDefProps` in the role `swDataDefProps` that aggregates `SwPointerTargetProps` in the role `swPointerTargetProps` that references an `ImplementationDataType` of category e.g. `VALUE`.

[constr_1254] Definition of a pointer to a pointer [AUTOSAR does not support the definition of a pointer to a pointer by defining an `ImplementationDataType` of category `DATA_REFERENCE` that aggregates `SwDataDefProps` in the role `swDataDefProps` that in turn aggregate `SwPointerTargetProps` in the role `swPointerTargetProps` with attribute `targetCategory` set to `DATA_REFERENCE` that in turn aggregates `SwDataDefProps` in the role `swDataDefProps` that aggregates `SwPointerTargetProps` in the role `swPointerTargetProps` that references an `ImplementationDataType` of category e.g. `VALUE`.]()

For clarification, The AUTOSAR RTE does not support a definition of a pointer to a pointer by way of option 2 anyway. For all intents and purposes, [constr_1254] merely reflects this restriction on the level of AUTOSAR models.

Option 1 (which is also featured in Figure 5.17) is the only viable way that is positively supported by the AUTOSAR RTE [2].

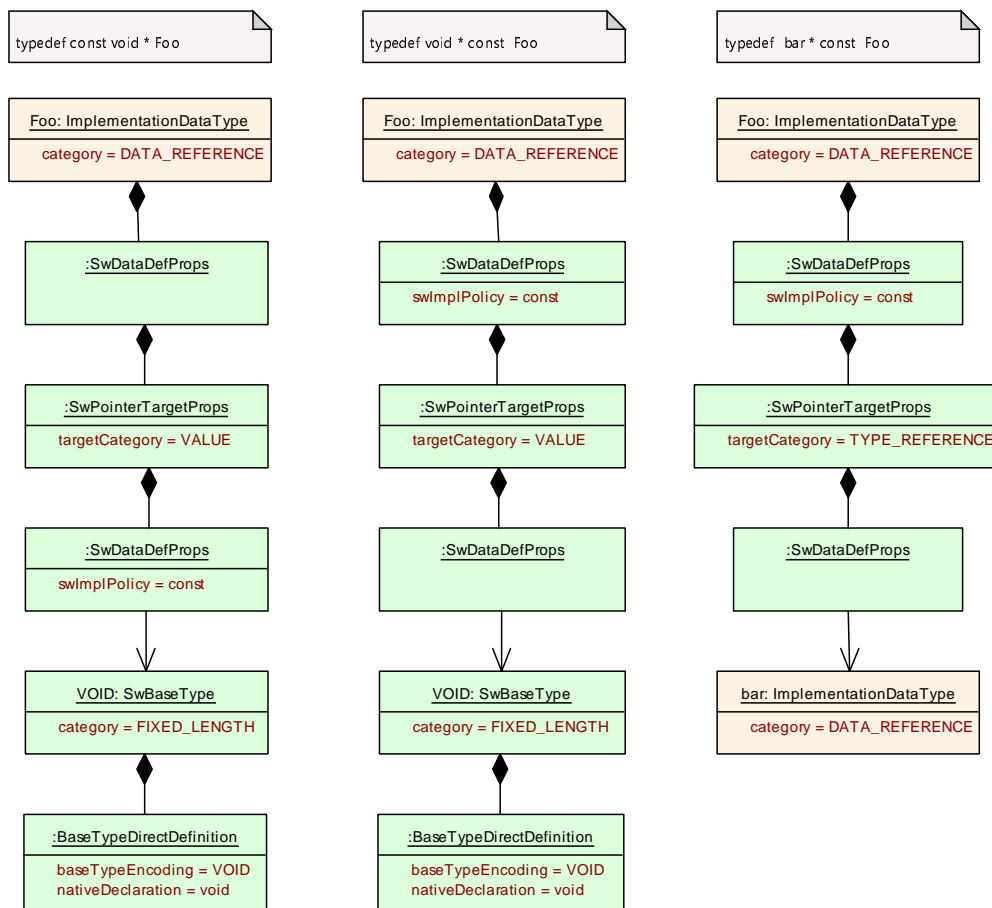

Figure 5.17: Example (3) for TypeDefs

[TPS_SWCT_01259] Definition of a pointer to a function [An `ImplementationDataType` or one of its sub-elements can also describe a function pointer. This completes its ability to declare all kinds of local data and of possible arguments used in library calls.

A function pointer is defined by the [category](#) `FUNCTION_REFERENCE` and the association `SwPointerTargetProps.functionPointerSignature` that refers to a `BswModuleEntry`. The latter essentially describes the signature of a function as explained in [6].] ([RS_SWCT_03217](#))

Class	SwPointerTargetProps			
Package	M2::MSR::DataDictionary::DataDefProperties			
Note	<p>This element defines, that the data object (which is specified by the aggregating element) contains a reference to another data object or to a function in the CPU code. This corresponds to a pointer in the C-language.</p> <p>The attributes of this element describe the category and the detailed properties of the target which is either a data description or a function signature.</p>			
Base	<i>ARObject</i>			
Attribute	Type	Mult.	Kind	Note
functionPointerSignature	BswModuleEntry	0..1	ref	<p>The referenced <code>BswModuleEntry</code> serves as the signature of a function pointer definition. Primary use case: function pointer passed as argument to other function.</p> <p>Tags:xml.sequenceOffset=40</p>
swDataDefProps	SwDataDefProps	0..1	aggr	<p>The properties of the target data type.</p> <p>Tags:xml.sequenceOffset=30</p>
targetCategory	Identifier	0..1	attr	<p>This specifies the category of the target:</p> <ul style="list-style-type: none"> • In case of a data pointer, it shall specify the category of the referenced data. • In case of a function pointer, it could be used to denote the category of the referenced <code>BswModuleEntry</code>. Since currently no categories for <code>BswModuleEntry</code> are defined it will be empty. <p>Tags:xml.sequenceOffset=5</p>

Table 5.22: SwPointerTargetProps

The allowed existence and multiplicity of all the attributes of `SwDataDefProps` and other properties depend on the [category](#) of the `ImplementationDataType`.

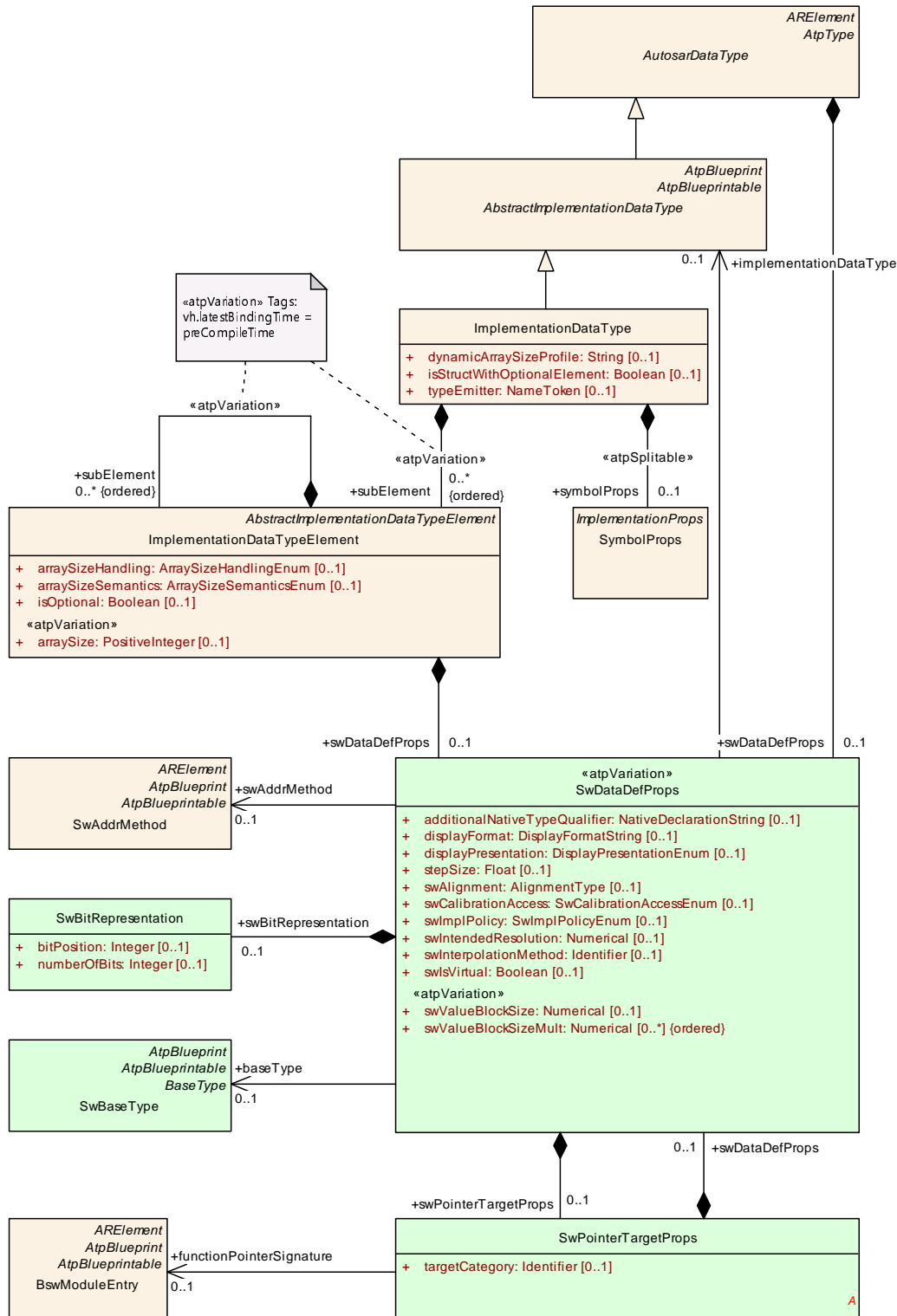

Figure 5.18: `SwDataDefProps` used in the context of `ImplementationDataType`

[constr_1178] Existence of attributes of `SwDataDefProps` in the context of `ImplementationDataType` [For the sake of removing possible sources of ambiguity, `SwDataDefProps` used in the context of `ImplementationDataType` can **only have one of**

- `baseType`
- `swPointerTargetProps`
- `implementationDataType`

}]()

Please note that an `ImplementationDataType` manifests itself in the source code of an RTE into which a `DataPrototype` typed by the `ImplementationDataType` is deployed. This implies potential naming conflicts if `ImplementationDataTypes` that have identical `shortNames` are deployed into a specific RTE.

[TPS_SWCT_01194] Symbolic name of an `ImplementationDataType` [To mitigate this potential hazard it is possible to provide the `ImplementationDataType` along with an accompanying symbolic name that can be used for resolving the name clash.

The symbolic name is provided by means of the attribute `symbol` of the meta-class `SymbolProps` owned by `ImplementationDataType` in the role `symbolProps.`}]()

For more information about `symbolProps`, please refer to Figure 5.14.

[TPS_SWCT_01441] Nature of a `TYPE_REFERENCE` [A type reference (formally represented by an `ImplementationDataType` of category `TYPE_REFERENCE`) implements a redirection to common `ImplementationDataTypes.`}]()

[TPS_SWCT_01442] `ImplementationDataType` of category `TYPE_REFERENCE` does not define own properties [As long as an `ImplementationDataType` of category `TYPE_REFERENCE` does not define own properties, the properties of the refined `ImplementationDataType` apply.]()

[TPS_SWCT_01443] `ImplementationDataType` of category `TYPE_REFERENCE` overwrites properties of refined `ImplementationDataType` [If an implementation data types of category `TYPE_REFERENCE` defines own properties (e.g. `CompuMethod`), these properties overwrite the properties of the refined `ImplementationDataType.`}]()

As explained by [constr_1050], Compatibility checks of `ImplementationDataType` require a prior resolution of possible type references, i.e. the compatibility shall be checked on the resolved `ImplementationDataType`.

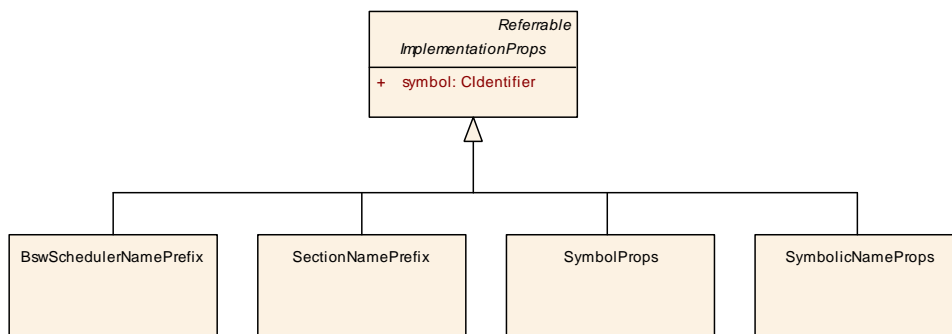

Figure 5.19: `ImplementationProps` and its subclasses

Class	<i>ImplementationProps</i> (abstract)			
Package	M2::AUTOSARTemplates::CommonStructure::Implementation			
Note	Defines a symbol to be used as (depending on the concrete case) either a complete replacement or a prefix when generating code artifacts.			
Base	<i>ARObject</i> , <i>Referrable</i>			
Subclasses	BswSchedulerNamePrefix, <i>ExecutableEntityActivationReason</i> , SectionNamePrefix, <i>SymbolProps</i> , <i>SymbolicNameProps</i>			
Attribute	Type	Mult.	Kind	Note
symbol	CIdentifier	1	attr	The symbol to be used as (depending on the concrete case) either a complete replacement or a prefix.

Table 5.23: ImplementationProps

Class	<i>SymbolProps</i>			
Package	M2::AUTOSARTemplates::SWComponentTemplate::Components			
Note	This meta-class represents the ability to attach with the symbol attribute a symbolic name that is conform to C language requirements to another meta-class, e.g. AtomicSwComponentType, that is a potential subject to a name clash on the level of RTE source code.			
Base	<i>ARObject</i> , <i>ImplementationProps</i> , <i>Referrable</i>			
Attribute	Type	Mult.	Kind	Note
–	–	–	–	–

Table 5.24: SymbolProps

[TPS_SWCT_01759] Use cases for unions [There are different use cases for the definition of a union data type:

1. The *DataPrototypes* derived from the union data type shall be transported over a communication network. For this purpose, it is necessary to apply a special modeling in the form of a wrapped union data type, as explained by [TPS_SWCT_01700].
2. The *DataPrototypes* created from the union data type are used internally within the same ECU, e.g. as a *PerInstanceMemory*, *romBlock*, or *ramBlock*. In this case the modeling of the union data type does not depend on specific constraints.

]()

In summary, there are cases where unions can be used in *PortInterfaces*, but these are restricted to the fulfillment of certain conditions that are explained in [constr_1607].

[constr_1607] Only Wrapped Union Data Types in PortInterface [Within the scope of a *PortInterface* the usage of a Union data type is only supported

- for *Wrapped Union Data Types*.

- for a `PortInterface` that is used to type a `PortPrototype` that does not appear as a context in an `instanceRef` owned by a `DataMapping`. See also [constr_1441].

]()

5.2.5.1 Modeling of Optional Element Structure with `ImplementationDataType`

Please note that the content of this chapter has draft character

The definition of an `ImplementationDataType` that represents an `Optional Element Structure` shall not only rely on the existence of optional elements.

Also, the definition of the enclosing `ImplementationDataType` shall clearly signal the intention by means of the dedicated attribute `ImplementationDataType.isStructWithOptionalElement`.

[TPS_SWCT_01772] Semantics of attribute `ImplementationDataType.isStructWithOptionalElement` [If attribute `ImplementationDataType.isStructWithOptionalElement` is set to `True` then the `ImplementationDataType` advertises the intention to represent an `Optional Element Structure` such that the fulfillment of structural requirements for the existence of optional elements can be formally checked.

Again, this attribute represents a formal specification that optionality is intended as opposed to an `ImplementationDataType` that fulfills the structural requirements out of different motivations.] (*RS_SWCT_03320*)

[TPS_SWCT_01773] Definition of `Optional Element Structure` on the level of `ImplementationDataType` [The modeling approach for the definition of an `Optional Element Structure` on the level of `ImplementationDataType` is to set the attribute `ImplementationDataTypeElement.isOptional` to the value `True`.

If the attribute is not set or set to the value `False` then the respective `ImplementationDataTypeElement` shall be considered mandatory.] (*RS_SWCT_03320*)

[constr_1637] Existence of `ImplementationDataTypeElement.isOptional` vs. `ImplementationDataType.isStructWithOptionalElement` [If one `ImplementationDataType.subElement` sets attribute `isOptional` to the value `True` then the enclosing `ImplementationDataType` shall also set attribute `isStructWithOptionalElement` to `True`.]()

In order to be able to generate a proper RTE API for the access to optional elements of data types in general it is necessary to impose structural requirements on the definition of `ImplementationDataType`.

In particular, it is necessary at runtime to store the information about the availability of a specific `ImplementationDataTypeElement` where attribute `isOptional` has

been set to the value `True` in the context of an `ImplementationDataType` of category `STRUCTURE`.

An `ImplementationDataType` that represents an `Optional Element Structure` shall contain a special element which represents an *availability bitfield*.

This bitfield is implemented as an array of `uint8` and shall hold one bit for each optional element contained in the structured data type.

In particular, the applicable structural requirements for an `ImplementationDataType` that represents an `Optional Element Structure` are described in the following specification items.

[TPS_SWCT_01774] Modeling of `ImplementationDataType` with optional elements [

The following approach shall be taken to model an `ImplementationDataType` that represents an `Optional Element Structure`:

- The first `ImplementationDataTypeElement` of `ImplementationDataType` where attribute `isStructWithOptionalElement` is set to `True` shall have the `shortName` `availabilityBitfield`. [constr_1638] applies.
- This `ImplementationDataTypeElement` shall be of category `ARRAY`
- The `ImplementationDataTypeElement` shall set attribute `arraySizeSemantics` to the value `fixedSize`.
- The `ImplementationDataTypeElement` shall aggregate a further `ImplementationDataTypeElement` in the role `subElement` for which the following requirements apply:
 - The `ImplementationDataTypeElement` shall be of category `TYPE_REFERENCE` that eventually refers to an `ImplementationDataType` that - one way or the other - implements an array of unsigned bytes, e.g. take the `Platform Data Type` named `uint8` as the element type¹¹.
 - The `ImplementationDataTypeElement` shall set the value of attribute `arraySize` to `max(1,ceil(numberOfOptionalElements / 8))`.

](RS_SWCT_03320)

[constr_1638] First `ImplementationDataTypeElement` of `ImplementationDataType` that represents an `Optional Element Structure` [The first `ImplementationDataTypeElement` of `ImplementationDataType` that represents an `Optional Element Structure`, i.e. the `availabilityBitfield` according to [TPS_SWCT_01774], shall not set attribute `isOptional` to `True`.]()

A further structural requirement applies.

¹¹this relation could be expressed in a more formal way. But it would be a very expansive formal way in an already complicated specification item. It is assumed that it is sufficient to convey the general idea.

[constr_1639] ImplementationDataTypeElement with attribute isOptional set to True [ImplementationDataTypeElement with attribute isOptional set to True shall **not** be of category STRUCTURE.]()

Instead, nested structures shall be created by modeling ImplementationDataTypeElements of category TYPE_REFERENCE that in turn refer to ImplementationDataTypes of category STRUCTURE.

Rationale: the existence of [constr_1639] simplifies the concept of the availability bit-field.

The bitfield shall **only** contain information of the availability of the direct child elements and **not** of elements of sub-structures.

By using the category TYPE_REFERENCE it is assured that a separate ImplementationDataType of category STRUCTURE is generated for the sub-structure.

Since the AUTOSAR RTE provides the APIs to access the availability information on the basis of an ImplementationDataType of category STRUCTURE, the usage of anonymous structures with optional elements is not possible.

5.2.6 Base Type

[TPS_SWCT_01260] SwBaseType [BaseType is used to specify the basic data type level. AUTOSAR uses the meta-class SwBaseType which is derived from the abstract class BaseType due to other use cases for BaseType in ASAM HDO.]()

[TPS_SWCT_01261] Use case for SwBaseType [One use case for SwBaseType is to serve as input for the RTE generator. It will always appear at the “leaves” of data the types definitions which are relevant for RTE generation. It is used to generate the corresponding C-code typedefs in case the attribute BaseTypeDirectDefinition.nativeDeclaration exists.]()

[constr_1010] If nativeDeclaration does not exist [If nativeDeclaration does not exist in the SwBaseType it is required that the shortName (e.g. “uint8”) of the corresponding ImplementationDataType is equal to a name of one of the Platform or Standard Types predefined in AUTOSAR code.]()

The consequence of [constr_1010] is that if the nativeDeclaration does not exist the RTE generator will **not** consider the ImplementationDataType for the generation of data type definitions.

Still, the compiler will positively be able to resolve the data type because it can fall back to the data type definitions contained in the header file for platform and standard data types that has to be included by regulation of the AUTOSAR standard.

Please note that `nativeDeclaration` shall yield a valid C data type symbol, whether this is done by a `typedef` or a by using the symbol¹² of an integral data type is principally all the same.

Of course, using the symbol of an integral data type as the value of `nativeDeclaration` increases the odds that the enclosing `SwBaseType` can be used independently of the availability of the definition of a `typedef` that may or may not be available in a given context.

[TPS_SWCT_01563] Applicable values for `nativeDeclaration` [For the purpose of avoiding portability issues the value `nativeDeclaration` should only consist of the symbol of an integral C data type.] ()

For more information on this refer to [22].

[TPS_SWCT_01263] Further use cases for `SwBaseType` [Within the basic software description, `SwBaseType` can be used (together with `ImplementationDataTypes`) for documentation or to specify variables for debugging. Furthermore, `SwBaseTypes` are required in the generation of support data for measurement and calibration tools. Please refer to [6] for details on these use cases.] ()

A more detailed description of `BaseTypes` can also be found in *ASAM MCD 2 Harmonized Data Objects*.¹³

Class	BaseType (abstract)			
Package	M2::MSR::AsamHdo::BaseTypes			
Note	This abstract meta-class represents the ability to specify a platform dependant base type.			
Base	ARElement , ARObject , CollectableElement , Identifiable , MultilanguageReferrable , PackageableElement , Referrable			
Subclasses	SwBaseType			
Attribute	Type	Mult.	Kind	Note
baseType Definition	BaseTypeDefinition	1	aggr	This is the actual definition of the base type. Tags: xml.roleElement=false xml.roleWrapperElement=false xml.sequenceOffset=20 xml.typeElement=false xml.typeWrapperElement=false

Table 5.25: BaseType

¹²Note that the symbol does not necessarily have to consist of a single token, i.e. for all intents and purposes (for example) `unsigned char` is also considered the symbol of an integral C data type.

¹³The definition of *Harmonized Data Objects* can be retrieved from ASAM at www.asam.net. Access is limited to ASAM members.

Class	SwBaseType			
Package	M2::MSR::AsamHdo::BaseTypes			
Note	This meta-class represents a base type used within ECU software. Tags: atp.recommendedPackage=BaseTypes			
Base	ARElement , ARObject , AtpBlueprint , AtpBlueprintable , BaseType , CollectableElement , Identifiable , MultilanguageReferrable , PackageableElement , Referrable			
Attribute	Type	Mult.	Kind	Note
–	–	–	–	–

Table 5.26: SwBaseType

Class	BaseTypeDefinition (abstract)			
Package	M2::MSR::AsamHdo::BaseTypes			
Note	This meta-class represents the ability to define a basetype.			
Base	ARObject			
Subclasses	BaseTypeDirectDefinition			
Attribute	Type	Mult.	Kind	Note
–	–	–	–	–

Table 5.27: BaseTypeDefinition

Class	BaseTypeDirectDefinition			
Package	M2::MSR::AsamHdo::BaseTypes			
Note	This BaseType is defined directly (as opposite to a derived BaseType)			
Base	ARObject , BaseTypeDefinition			
Attribute	Type	Mult.	Kind	Note
baseTypeEncoding	BaseTypeEncodingString	1	attr	This specifies, how an object of the current BaseType is encoded, e.g. in an ECU within a message sequence. Tags: xml.sequenceOffset=90
baseTypeSize	PositiveInteger	0..1	attr	Describes the length of the data type specified in the container in bits. Tags: xml.sequenceOffset=70
byteOrder	ByteOrderEnum	0..1	attr	This attribute specifies the byte order of the base type. Tags: xml.sequenceOffset=110
memAlignment	PositiveInteger	0..1	attr	This attribute describes the alignment of the memory object in bits. E.g. "8" specifies, that the object in question is aligned to a byte while "32" specifies that it is aligned four byte. If the value is set to "0" the meaning shall be interpreted as "unspecified". Tags: xml.sequenceOffset=100
nativeDeclaration	NativeDeclarationString	0..1	attr	This attribute describes the declaration of such a base type in the native programming language, primarily in the Programming language C. This can then be used by a code generator to include the necessary declarations into a header file. For example BaseType with shortName: "MyUnsignedInt" native Declaration: "unsigned short"





Class	BaseTypeDirectDefinition		
			<p>Results in typedef unsigned short MyUnsignedInt; If the attribute is not defined the referring Implementation DataTypes will not be generated as a typedef by RTE. If a nativeDeclaration type is given it shall fulfill the characteristic given by baseTypeEncoding and baseType Size. This is required to ensure the consistent handling and interpretation by software components, RTE, COM and MCM systems. Tags:xml.sequenceOffset=120</p>

Table 5.28: BaseTypeDirectDefinition

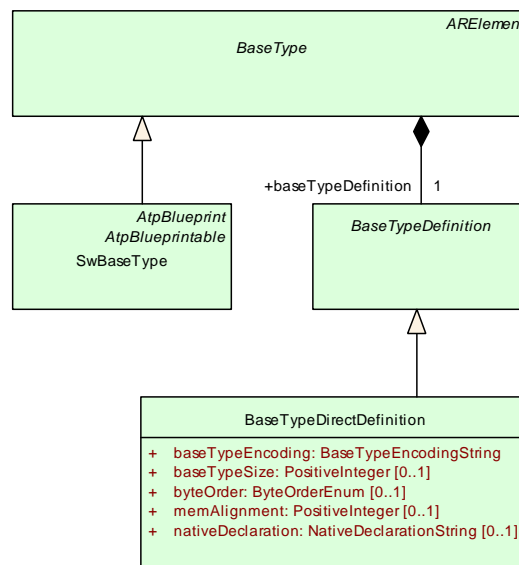

Figure 5.20: BaseType

Some additional hints to the properties of `SwBaseType`:

- **[constr_1011] category of SwBaseType** [For the attribute `SwBaseType.category` only the values `FIXED_LENGTH` and `VOID` are supported.] ()
- **[constr_1422] Value of category is VOID** [If the value of the attribute `SwBaseType.category` is set to `VOID` then the attribute `baseTypeSize` shall not exist.] ()
- **[constr_1012] Value of category is FIXED_LENGTH** [If the value of the attribute `SwBaseType.category` is set to `FIXED_LENGTH` then the attribute `baseTypeSize` shall be filled with content.] ()
- **[TPS_SWCT_01444] Size of SwBaseType is specified in bits** [In both cases (mentioned in [constr_1012]) the size of `SwBaseType` is specified in bits.] ()
- The attribute `baseTypeEncoding` specifies how the values of the base type are encoded.

[constr_1014] Supported value encodings for `SwBaseType` [The supported values for attribute `BaseTypeDirectDefinition.baseTypeEncoding` are:

- 1C: One's complement
- 2C: Two's complement
- BCD-P: Packed Binary Coded Decimals
- BCD-UP: Unpacked Binary Coded Decimals
- DSP-FRACTIONAL: Digital Signal Processor
- SM: Sign Magnitude
- IEEE754: floating-point numbers
- ISO-8859-1: single-byte coded character
- ISO-8859-2: single-byte coded character
- WINDOWS-1252: single-byte coded character
- UTF-8: UCS Transformation Format 8
- UTF-16: Character encoding for Unicode *code points* based on 16 bit *code units* [15]
- UCS-2: Universal Character Set 2
- NONE: Unsigned Integer
- VOID: corresponds to a void in C. The encoding is not formally specified here.
- BOOLEAN: This represents an unsigned integer to be interpreted as boolean. The value shall be interpreted as `true` if the value of the unsigned integer is 1 and it shall be interpreted as `false` if the value of the unsigned integer is 0.

A `CompuMethod` shall be referenced by the corresponding `Autosar-DataType` that implements the common sense behind the boolean concept, i.e. define a `TEXTTABLE` with two `CompuScales`: e.g. `true` → 1, `false` → 0.

]()

- **[TPS_SWCT_01262] `memAlignment` and `byteOrder` are platform-specific** [The value of attributes `BaseTypeDirectDefinition.memAlignment` and `BaseTypeDirectDefinition.byteOrder` is platform-specific and therefore should be set only in use cases where this is really needed.

These attributes shall be considered as optional.

If a `SwBaseType` is platform-specific then also the `ImplementationDataType` and software-component descriptions build on top of it become platform-specific.]
()

However, there are use cases for `SwBaseType` where this does not matter: especially the calibration support format which is generated in ECU-specific scope (and also contains `SwBaseType`, see [6]) could well be platform-specific.

Further regulations apply for the case that the value `UTF-16` is used for setting the attribute `BaseTypeDirectDefinition.baseTypeEncoding`:

[constr_1398] Existence of attributes of `BaseTypeDirectDefinition` [If the value of attribute `BaseTypeDirectDefinition.baseTypeEncoding` is set to `UTF-16` then the attribute `BaseTypeDirectDefinition.byteOrder` shall exist.

The only allowed values of `BaseTypeDirectDefinition.byteOrder` in this case are `mostSignificantByteFirst` and `mostSignificantByteLast`] ()

There is already predefined terminology (see [15]) existing that describes the two possible cases of byte orientation in a `UTF-16`-encoded string. The connection to this terminology is defined by [TPS_SWCT_01651] and [TPS_SWCT_01652].

<i>Enumeration</i>	ByteOrderEnum
Package	M2::AUTOSARTemplates::GenericStructure::GeneralTemplateClasses::PrimitiveTypes
Note	When more than one byte is stored in the memory the order of those bytes may differ depending on the architecture of the processing unit. If the least significant byte is stored at the lowest address, this architecture is called little endian and otherwise it is called big endian. ByteOrder is very important in case of communication between different PUs or ECUs.
Literal	Description
mostSignificantByteFirst	Most significant byte shall come at the lowest address (also known as BigEndian or as Motorola-Format) Tags: atp.EnumerationLiteralIndex=0
mostSignificantByteLast	Most significant byte shall come highest address (also known as LittleEndian or as Intel-Format) Tags: atp.EnumerationLiteralIndex=1
opaque	For opaque data endianness conversion has to be configured to Opaque. See AUTOSAR COM Specification for more details. Tags: atp.EnumerationLiteralIndex=2

Table 5.29: ByteOrderEnum

[TPS_SWCT_01651] UTF-16BE [If the value of attribute `BaseTypeDirectDefinition.baseTypeEncoding` is set to `UTF-16` and the attribute `BaseTypeDirectDefinition.byteOrder` in this case are `mostSignificantByteFirst` then the `SwBaseType` corresponds to the definition of `UTF-16BE` according to the Unicode standard [15].] ()

[TPS_SWCT_01652] UTF-16LE [If the value of attribute `BaseTypeDirectDefinition.baseTypeEncoding` is set to `UTF-16` and the attribute `BaseTypeDirectDefinition.byteOrder` in this case are `mostSignificantByteLast` then the `SwBaseType` corresponds to the definition of `UTF-16LE` according to the Unicode standard [15].] ()

A further question that needs clarification is the usage of the so-called `Byte Order Mark` which allows (at run-time) for determining the actual byte order directly from the payload of a unicode string.

As AUTOSAR has means to formally and comprehensively define the byte-order of any given `DataPrototype` that can hold a string at run time, it is **not** necessary to support a further instrument that takes care of the same purpose.

[TPS_SWCT_01653] UTF-16-encoded strings are not allowed to start with a BOM
[If the value of attribute `BaseTypeDirectDefinition.baseTypeEncoding` is set to `UTF-16` then the value of a `DataPrototype` (which is effectively representing a string) is not allowed to start with a `Byte Order Mark` (BOM).]()

Please note that [\[TPS_SWCT_01653\]](#) removes a possible redundancy in the definition and execution of `UTF-16`-encoded strings.

The redundancy is not only regarded unnecessary but also **potentially dangerous** because it is not possible to check whether the definition is consistent with the execution at configuration time.

From the formal point of view, [\[TPS_SWCT_01653\]](#) does not represent an actual constraint although it is formulated as such.

However, an AUTOSAR tool would not be able to properly check the condition at configuration time and therefore this rule is published as a specification item.

5.2.7 Data Type Terminology

There are uses of data types that on the one hand need a handy term (because this kind of data type is used a lot) but on the other hand cannot easily be expressed in simple terms of meta-model elements (like `ApplicationDataType`).

Therefore, it is not an option to fully describe the characteristics of these kinds of data types precisely every time one of these is used. A definition of terminology is supposed to associate the mentioned kinds of data types with the term under which their use shall be paraphrased.

5.2.7.1 Primitive Type

In some cases it is necessary to constrain that applicability of data types to primitive C data types. It would be possible to describe the characteristics of eligible `Autosar-DataTypes` at every single place in an AUTOSAR specification where this specific limitation applies.

However, this may end up in lengthy and potentially inconsistent descriptions at different places within AUTOSAR specifications. Therefore, this chapter provides a canonical definition of a primitive data type that can be referred to from other places.

[TPS_SWCT_01564] Non-recursive definition of a primitive data type [An [AutosarDataType](#) is considered a primitive data type if the following conditions apply:

- it is an [ApplicationPrimitiveDataType](#) of category VALUE or BOOLEAN
- it is an [ImplementationDataType](#) of category VALUE

]()

[TPS_SWCT_01565] Recursive definition of a primitive data type [An [Autosar-DataType](#) is considered a primitive data type if the following conditions apply:

- it is an [AutosarDataType](#) according to [\[TPS_SWCT_01564\]](#)
- it is an [AutosarDataType](#) of category TYPE_REFERENCE that, after all type-references have been resolved, boils down an [AutosarDataType](#) according to [\[TPS_SWCT_01564\]](#).

]()

5.2.7.2 Compound Primitive Data Type

[TPS_SWCT_01179] Compound Primitive Data Type [For clarification, a “compound primitive data type” is an [ApplicationPrimitiveDataType](#) of category STRING, CURVE, MAP, CUBOID, CUBE_4, CUBE_5, COM_AXIS, RES_AXIS, and VAL_BLK.

This implies the existence of a [swRecordLayout](#) owned by the [swDataDefProps](#) of the [ApplicationPrimitiveDataType](#) that defines the mapping to a corresponding [ImplementationDataType](#).

The main characteristic of the “compound primitive data type” is that with respect to the application data type layer its data type is considered a primitive data type but when it comes to the implementation data type layer the type is implemented as a composite data type according to the applicable [SwRecordLayout](#).] ([RS_SWCT_03216](#))

[TPS_SWCT_01486] ApplicationPrimitiveDataType of category STRING may have invalidValue [The only kind of Compound Primitive Data Type that is allowed to define an [invalidValue](#) is an [ApplicationPrimitive-DataType](#) of category STRING.] ([RS_SWCT_03216](#))

[constr_1241] Compound Primitive Data Types and invalidValue [Compound Primitive Data Types that have set the value of category other than STRING shall not define [invalidValue](#).]()

5.2.7.3 Integral Primitive Type

The [SenderReceiverToSignalMapping](#) (see [10]) allows for the integral mapping of a piece of data to a single [SystemSignal](#). The specification of AUTOSAR COM

[21] imposes certain requirements on the characteristics of data that apply for the integral mapping.

[TPS_SWCT_01477] Integral Primitive Types [Data types that qualify for being used in the context of a [SenderReceiverToSignalMapping](#) shall be called Integral Primitive Types.] ([RS_SWCT_03218](#))

[constr_1229] category of ImplementationDataType boils down to VALUE [An [ImplementationDataType](#) qualifies as an [Integral Primitive Type](#) if and only if either

- its [category](#) is [VALUE](#) or [TYPE_REFERENCE](#) that eventually boils down to [VALUE](#) or
- its [category](#) is [ARRAY](#) and it has only one [subElement](#) and one of the following conditions applies:
 - [subElement.category](#) is set to [VALUE](#) or [TYPE_REFERENCE](#) that eventually boils down to [VALUE](#) and the [subElement](#) refers to a [SwBaseType](#) where [baseTypeSize](#) is set to the value 8 and the [baseTypeEncoding](#) is set to [NONE](#).
 - [subElement.category](#) is set to [TYPE_REFERENCE](#) and the [swDataDefProps.implementationDataType](#) literally represents the [Platform Data Type](#) named “uint8”.
 - [subElement.category](#) is set to [TYPE_REFERENCE](#) and the attribute [swDataDefProps.implementationDataType.shortName](#) is set to “uint8” and [swDataDefProps.baseType.baseTypeDefinition.nativeDeclaration](#) does not exist.

]()

[constr_1230] ApplicationDataType that qualifies for Integral Primitive Type [An [ApplicationDataType](#) qualifies as an [Integral Primitive Type](#) if and only if all the following conditions apply:

- [ApplicationDataType.category](#) is set to [BOOLEAN](#), [VALUE](#), [STRING](#), or [ARRAY](#)
- in the applicable scope a [DataTypeMap](#) is available that refers to the given [ApplicationDataType](#)
- the found [DataTypeMap](#) refers to an [ImplementationDataType](#) that fulfills the requirements of [\[constr_1229\]](#)

]()

5.2.7.4 Variable-Size Array Data Type

The definition of and further explanation regarding the term [Variable-Size Array Data Type](#) can be found in chapter [2.8](#).

5.2.7.5 Wrapped Union Data Type

There are use cases for sending a [DataPrototype](#) that is effectively typed by a **union** data type over a communication network. In this case, however, it is necessary to not only send the [DataPrototype](#) itself but add an information about the applicable member of the union as a form of “meta-data” to the transmission.

By this means the sender can identify the applicable member of the union and the receiver can accordingly access the proper union element.

It is the nature of union data types that executable code shall **symmetrically** access the union, i.e. the member that was written needs to be read, the usage of a union as a “type converter” is heavily frowned upon (because it causes unspecified behavior from ISO-C:90 [23] point of view) and shall be discouraged by AUTOSAR.

Thus, AUTOSAR needs to take this condition into account and define a specific modeling for the handling of union data types.

[TPS_SWCT_01700] Definition of unions that can be transmitted over a communication network [If it is intended to send a data object typed by a union data type over a communication bus then a specific modeling is required for this purpose.

- The union data type shall never be used as such, it shall always be enclosed in an [ImplementationDataType](#) of category [STRUCTURE](#) that aggregates exactly two [ImplementationDataTypeElements](#):

- The **first** [ImplementationDataTypeElement](#) shall be used to identify the applicable element of the actual union data type.

The [shortName](#) of this element shall be set to “**memberSelector**”, it shall be of category [VALUE](#), or of category [TYPE_REFERENCE](#) that finally boils down to category [VALUE](#).

Furthermore, it shall refer to a [SwBaseType](#) with attribute [baseTypeEncoding](#) set to [NONE](#) and attribute [baseTypeSize](#) set to the value 8, 16, or 32.

This [ImplementationDataTypeElement](#) shall be called the [Member Selector](#).

- The **second** [ImplementationDataTypeElement](#) shall be of category [UNION](#), it represents the actual union “payload”.
- The purpose of the [Member Selector](#) is to identify the element of the union data type that applies for a given access to the union.

If the value of the `Member Selector` is set to 1 then the first `subElement` of the `ImplementationDataType` of category `UNION` is applicable.

If the value of the `Member Selector` is set to 2 then the second `subElement` is applicable and so on.

- The value of the `Member Selector` shall range between **the value 1** and the number of `subElements` of the `ImplementationDataTypeElement` of category `UNION`. Once again, the index counting is 1-based!
- Obviously, the actual data type used to hold the `Member Selector` shall be capable of storing a value that corresponds to the number of `subElements` of the `ImplementationDataTypeElement` of category `UNION`.
- Constraint [constr_1441] applies.

](RS_SWCT_03217)

[TPS_SWCT_01701] Wrapped Union Data Type [Data types that fulfill the requirements of [TPS_SWCT_01700] shall be called `Wrapped Union Data Types`.](RS_SWCT_03217)

[constr_1442] category TYPE_REFERENCE shall not be used for modeling the “payload” of a Wrapped Union Data Type [For the modeling of the “payload” part of a `Wrapped Union Data Type` it shall not be possible to use an `ImplementationDataTypeElement` of category `TYPE_REFERENCE` that finally (i.e. after all possible indirections are resolved) boils down to category `UNION`.]()

The definition of the `Wrapped Union Data Type` represents the **canonical way** of how union data types shall be used in AUTOSAR on the application and communication level. Consequentially, the usage of the `category` value `UNION` is effectively limited to an `ImplementationDataTypeElement`.

[constr_1444] Limited applicability of Wrapped Union Data Type [There is no support for the usage of `Wrapped Union Data Type` in `PortInterfaceMappings`, and `Diagnostics`.]()

In response to existing constraints that are out of the control of AUTOSAR, the initialization of a `Wrapped Union Data Type` is somehow complicated.

C90 [23], which is the standard language basis for AUTOSAR (see [RS_Main_00220]), allows only for the initialization of the first member of a union.

Granted, this restriction may not be sufficient to cover all use cases connected with the deployment of `Wrapped Union Data Types` in AUTOSAR, but that’s all that can be reasonably supported for the time being.

One obvious consequence of this restriction is that for any given `ValueSpecification` taken to initialize a `Wrapped Union Data Type` the value of the `Member Selector` is **strictly** locked to 1.

[constr_1445] Initialization of the Member Selector of a Wrapped Union Data Type [The `initValue` for the `Member Selector` shall never be set to any value other than 1.]()

Another aspect of the initialization of a `Wrapped Union Data Type` is that the “payload” part cannot be treated as a composite data type unless the first element of the “payload” part is typed by a composite data type.

In other words, it is not possible to initialize the first `subElement` of an `ImplementationDataTypeElement` of category `UNION`. It is only possible to assign an initial value to the “payload” part itself.

[TPS_SWCT_01702] Initialization of the “payload” of a Wrapped Union Data Type [The `initValue` for the `ImplementationDataTypeElement` of category `UNION` shall be assigned to the `ImplementationDataTypeElement` of category `UNION` but it shall reflect the structure of the first `subElement` of the `ImplementationDataTypeElement` of category `UNION`.] (*RS_SWCT_03217*)

Listing 5.8: Simplified example of a Wrapped Union Data Type

```

<IMPLEMENTATION-DATA-TYPE>
  <SHORT-NAME>UnionExample</SHORT-NAME>
  <CATEGORY>STRUCTURE</CATEGORY>
  <SUB-ELEMENTS>
    <IMPLEMENTATION-DATA-TYPE-ELEMENT>
      <SHORT-NAME>memberSelector</SHORT-NAME>
      <CATEGORY>VALUE</CATEGORY>
    </IMPLEMENTATION-DATA-TYPE-ELEMENT>
    <IMPLEMENTATION-DATA-TYPE-ELEMENT>
      <SHORT-NAME>payload</SHORT-NAME>
      <CATEGORY>UNION</CATEGORY>
      <SUB-ELEMENTS>
        <IMPLEMENTATION-DATA-TYPE-ELEMENT>
          <SHORT-NAME>primitive</SHORT-NAME>
          <CATEGORY>VALUE</CATEGORY>
        </IMPLEMENTATION-DATA-TYPE-ELEMENT>
        <IMPLEMENTATION-DATA-TYPE-ELEMENT>
          <SHORT-NAME>array</SHORT-NAME>
          <CATEGORY>ARRAY</CATEGORY>
          <SUB-ELEMENTS>
            <IMPLEMENTATION-DATA-TYPE-ELEMENT>
              <SHORT-NAME>arraySub</SHORT-NAME>
              <CATEGORY>VALUE</CATEGORY>
              <ARRAY-SIZE>4</ARRAY-SIZE>
              <ARRAY-SIZE-SEMANTICS>FIXED-SIZE</ARRAY-SIZE-SEMANTICS>
            </IMPLEMENTATION-DATA-TYPE-ELEMENT>
          </SUB-ELEMENTS>
        </IMPLEMENTATION-DATA-TYPE-ELEMENT>
      </SUB-ELEMENTS>
    </IMPLEMENTATION-DATA-TYPE-ELEMENT>
  </SUB-ELEMENTS>
</IMPLEMENTATION-DATA-TYPE>

```

In other words, if the first `subElement` of the `ImplementationDataTypeElement` of category `UNION` is of a primitive type then a `NumericalValueSpecification` shall be used to initialize the `ImplementationDataTypeElement` of category `UNION`.

If the `subElement` is typed by a composite data type then a `CompositeValueSpecification` shall be used to initialize the `ImplementationDataTypeElement` of category `UNION`.

To summarize the initialization issue, a `Wrapped Union Data Type` is modeled as a structure of two elements and requires a `RecordValueSpecification` that in turn aggregates two `ValueSpecifications`, one for the `Member Selector` that shall have no other value than 1, and one for the “payload”.

The structure of the second `ValueSpecification` depends on the data type used for the first element of the “payload”.

The following example shows a simplified and stripped-down (e.g. without the `Sw-DataDefProps` required to make the model complete) model of a `Wrapped Union Data Type`.

5.2.7.6 Optional Element Structure

As already mentioned in section 2.9, there are use cases for structured data types that contain optional elements that may or may not exist at a given time.

These data types require a specific modeling on both the level of `ApplicationDataType` and the level of `ImplementationDataType`.

[TPS_SWCT_01775] Structured data types with optional elements [A structured data type that contains at least one optional element shall be called an `Optional Element Structure`.] (*RS_SWCT_03320*)

On the level of `ApplicationDataType`, the existence of optional elements is signaled by setting the attribute `ApplicationRecordElement.isOptional` to `True`. For more details, please refer to section 5.2.4.2.2.

The description of how an `Optional Element Structure` shall be modeled using `ImplementationDataType` can be found in section 5.2.5.1.

5.3 Data Prototypes

5.3.1 Overview

[TPS_SWCT_01264] Data prototypes implement a role of a data type [Generally speaking, a data prototype represents the implementation of a role of a data type within

the definition of another data type, e.g. a “typed” data object declared within a software component or a port interface.

This means formally that it has an is-of-type relation to a data type and is usually aggregated by another element, e.g. the internal behavior or a port interface.]()

In the meta-model, various kinds of data prototypes are derived from the abstract *DataPrototype* as shown in figure 5.21.

The reason for the introduction of this hierarchy was the distinction between *Autosar-DataPrototype* (which can be used for the application and implementation types as well) and *ApplicationCompositeElementDataPrototype* (which is restricted to be used within the application types).

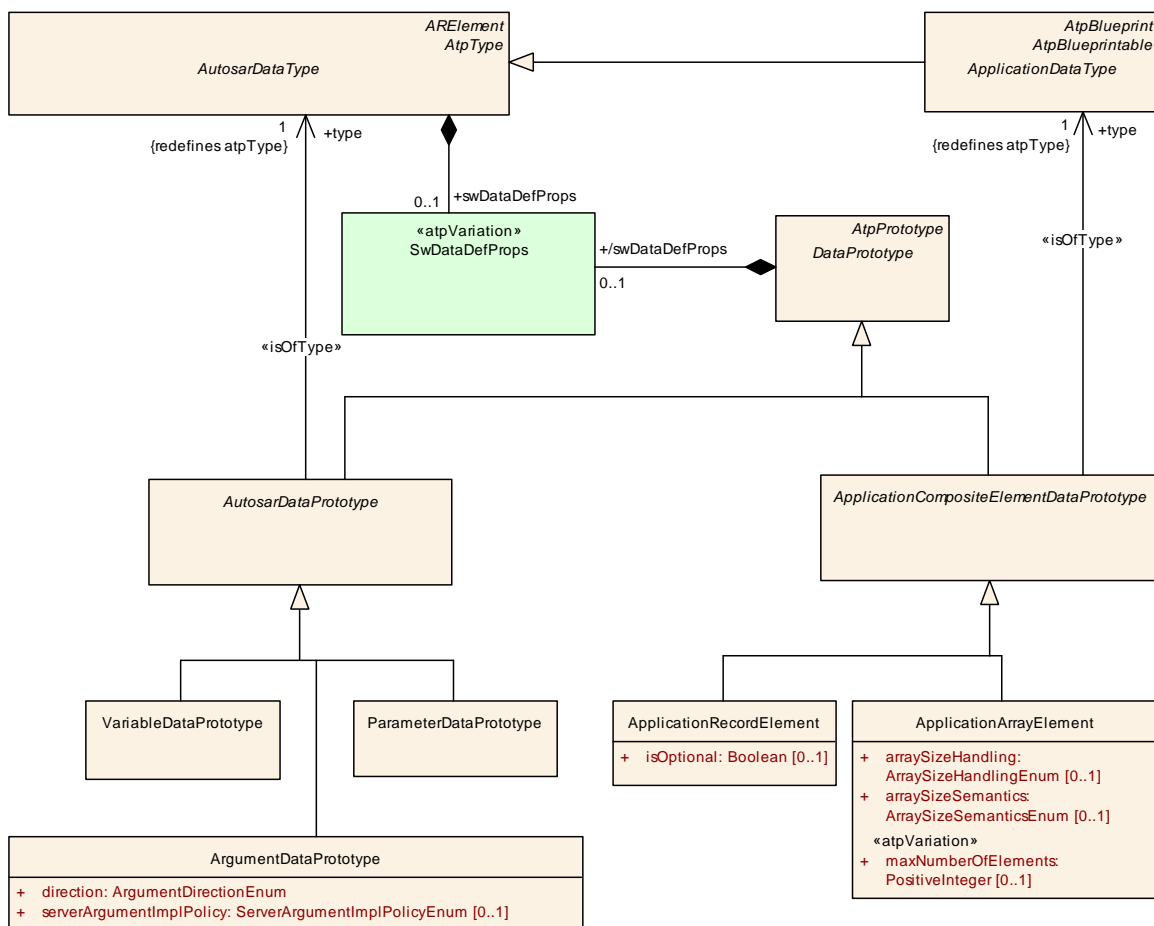

Figure 5.21: Data Prototypes Overview

Class	<i>DataPrototype</i> (abstract)			
Package	M2::AUTOSARTemplates::SWComponentTemplate::Datatype::DataPrototypes			
Note	Base class for prototypical roles of any data type.			
Base	<i>ARObject</i> , <i>AtpFeature</i> , <i>AtpPrototype</i> , <i>Identifiable</i> , <i>MultilanguageReferrable</i> , <i>Referrable</i>			
Subclasses	<i>ApplicationCompositeElementDataPrototype</i> , <i>AutosarDataPrototype</i>			
Attribute	Type	Mult.	Kind	Note
swDataDef Props	SwDataDefProps	0..1	aggr	This property allows to specify data definition properties which apply on data prototype level.

Table 5.30: DataPrototype

Class	<i>AutosarDataPrototype</i> (abstract)			
Package	M2::AUTOSARTemplates::SWComponentTemplate::Datatype::DataPrototypes			
Note	Base class for prototypical roles of an AutosarDataType.			
Base	<i>ARObject</i> , <i>AtpFeature</i> , <i>AtpPrototype</i> , <i>DataPrototype</i> , <i>Identifiable</i> , <i>MultilanguageReferrable</i> , <i>Referrable</i>			
Subclasses	<i>ArgumentDataPrototype</i> , <i>ParameterDataPrototype</i> , <i>VariableDataPrototype</i>			
Attribute	Type	Mult.	Kind	Note
type	AutosarDataType	1	tref	This represents the corresponding data type. Stereotypes: isOfType

Table 5.31: AutosarDataPrototype

Class	<i>ApplicationCompositeElementDataPrototype</i> (abstract)			
Package	M2::AUTOSARTemplates::SWComponentTemplate::Datatype::DataPrototypes			
Note	This class represents a data prototype which is aggregated within a composite application data type (record or array). It is introduced to provide a better distinction between target and context in instance Refs.			
Base	<i>ARObject</i> , <i>AtpFeature</i> , <i>AtpPrototype</i> , <i>DataPrototype</i> , <i>Identifiable</i> , <i>MultilanguageReferrable</i> , <i>Referrable</i>			
Subclasses	<i>ApplicationArrayElement</i> , <i>ApplicationRecordElement</i>			
Attribute	Type	Mult.	Kind	Note
type	ApplicationDataType	1	tref	This represents the corresponding data type. Stereotypes: isOfType

Table 5.32: ApplicationCompositeElementDataPrototype

Because these [DataPrototypes](#) are modeled as own meta-classes it is possible to define own attributes for them (on M2) which (in the M1 model) could extend or constrain the attribute values already set via the corresponding data type.

[TPS_SWCT_01265] [DataPrototype](#) aggregates an own set of [SwDataDefProps](#) [This mechanism is used here in the way that [DataPrototype](#) aggregates an own set of [SwDataDefProps](#). Thus, each kind of [DataPrototype](#) has the ability to extend or even overwrite the [SwDataDefProps](#) already defined by its [ApplicationDataType](#) or [ImplementationDataType](#).

This mechanism, if carefully applied, allows for a better reuse of data types because they can be kept free of the properties which vary according to the context or are defined in later project phases.] ()

Chapter 5.4 describes more details about this aspect of the meta-model.

[TPS_SWCT_01445] Applicability of SwDataDefProps for DataPrototypes [The applicability of SwDataDefProps for DataPrototypes shall follow the same rules as for the categories of the corresponding AutosarDataTypes.]()

The applicability of SwDataDefProps for DataPrototypes is documented in Table 5.7.

Further information can be found in table 5.33 and table 5.34.

Please note that table 5.33 does not include the ApplicationRecordElement and ApplicationArrayElement because these specializations of ApplicationCompositeElementDataPrototype are already part of table 5.7. The same applies for table 5.34 which does not include the ImplementationDataTypeElement.

Attributes of SwDataDefProps	Root EI.			Attribute Existence per Category													
	DataPrototype	InstantiationDataDefProps	ParameterAccess	VALUE	VAL_BLK	STRUCTURE	ARRAY	STRING	BOOLEAN	COM_AXIS	RES_AXIS	CURVE	MAP	CUBOID	CUBE_4	CUBE_5	
additionalNativeTypeQualifier																	
annotation	x	x	x	*	*	*	*	*	*	*	*	*	*	*	*	*	*
baseType																	
compuMethod																	
dataConstr.dataConstrRule.physConstrs	x	x		0..1	0..1		0..1		0..1			0..1	0..1	0..1	0..1	0..1	0..1
dataConstr.dataConstrRule.internalConstrs	x	x		d/c ¹	d/c		d/c		d/c			d/c	d/c	d/c	d/c	d/c	d/c
displayFormat	x	x		0..1	0..1		0..1	0..1	0..1			0..1	0..1	0..1	0..1	0..1	0..1
displayPresentation	x	x		0..1	0..1		0..1			0..1	0..1	0..1	0..1	0..1	0..1	0..1	0..1
implementationDataType																	
invalidValue																	
stepSize	x	x	x	0..1	0..1		0..1			0..1	0..1	0..1	0..1	0..1	0..1	0..1	0..1
swAddrMethod	x	x		0..1	0..1	0..1	0..1	0..1	0..1	0..1	0..1	0..1	0..1	0..1	0..1	0..1	0..1
swAlignment	x	x		0..1	0..1	0..1	0..1	0..1	0..1	0..1	0..1	0..1	0..1	0..1	0..1	0..1	0..1
swBitRepresentation																	
swCalibrationAccess	x	x		0..1	0..1	0..1	0..1	0..1	0..1	0..1	0..1	0..1	0..1	0..1	0..1	0..1	0..1
swCalprmAxisSet																	
swCalprmAxisSet.swCalprmAxis/SwAxisGrouped.swCalprmRef		x	x				0..1					0..1	0..1	0..1	0..1	0..1	0..1



¹⁴don't care



Attributes of SwDataDefProps	Root EI.			Attribute Existence per Category												
	DataPrototype	InstantiationDataDefProps	ParameterAccess	VALUE	VAL_BLK	STRUCTURE	ARRAY	STRING	BOOLEAN	COM_AXIS	RES_AXIS	CURVE	MAP	CUBOID	CUBE_4	CUBE_5
swCalprmAxisSet.swCalprmAxis/SwAxisIndividual.swVariableRef		x	x				0..1			0..1	0..1	0..1	0..1	0..1	0..1	0..1
swCalprmAxisSet.swCalprmAxis/SwAxisGrouped.sharedAxisType																
swCalprmAxisSet.swCalprmAxis/SwAxisIndividual.inputVariableType																
swCalprmAxisSet.swCalprmAxis/SwAxisIndividual.unit																
swCalprmAxisSet.swCalprmAxis.baseType																
swComparisonVariable			x									0..1	0..1	0..1	0..1	0..1
swDataDependency	x	x		0..1								0..1	0..1	0..1	0..1	0..1
swHostVariable																
swImplPolicy	x			0..1	0..1	0..1	0..1	0..1	0..1	0..1	0..1	0..1	0..1	0..1	0..1	0..1
swIntendedResolution																
swInterpolationMethod	x	x	x	0..1						0..1	0..1	0..1	0..1	0..1	0..1	0..1
swIsVirtual	x	x		0..1				0..1				0..1	0..1	0..1	0..1	0..1
swPointerTargetProps																
swRecordLayout																
swRefreshTiming	x	x		0..1	0..1			0..1	0..1							
swTextProps																
swValueBlockSize																
swValueBlockSizeMult																
unit																
valueAxisDataType																

Table 5.33: Allowed Attributes vs. **category** for **DataPrototypes** typed by **Application Data Types**

[constr_1289] Allowed Attributes vs. **category** for **DataPrototypes** typed by **ApplicationDataTypes** [The allowed values of Attributes per **category** for **DataPrototypes** typed by **ApplicationDataTypes** are documented in table 5.33.]()

Attributes of SwDataDefProps	Root Element			Attribute Existence per Category						
	DataPrototype	InstantiationDataDefProps	ParameterAccess	VALUE	DATA_REFERENCE	FUNCTION_REFERENCE	TYPE_REFERENCE	STRUCTURE	UNION	ARRAY
additionalNativeTypeQualifier										
annotation	x	x	*	*	*	*	*	*	*	*
baseType										
compuMethod										
dataConstr.dataConstrRule.physConstrs	x	x		d/c ¹⁵			d/c			d/c
dataConstr.dataConstrRule.internalConstrs	x	x		0..1			0..1			0..1
displayFormat	x	x		0..1			0..1	0..1	0..1	0..1
displayPresentation	x	x		0..1			0..1			0..1
implementationDataType										
invalidValue										
stepSize	x	x		0..1						0..1
swAddrMethod	x	x		0..1	0..1	0..1	0..1	0..1	0..1	0..1
swAlignment	x	x		0..1	0..1	0..1	0..1	0..1	0..1	0..1
swBitRepresentation										
swCalibrationAccess	x	x		0..1			0..1	0..1	0..1	0..1
swCalprmAxisSet										
swComparisonVariable										
swDataDependency										
swHostVariable										
swImplPolicy	x			0..1	0..1	0..1	0..1	0..1	0..1	0..1
swIntendedResolution										
swInterpolationMethod										
swIsVirtual										
swPointerTargetProps										
swPointerTargetProps.swDataDefProps										
swPointerTargetProps.functionPointerSignature										
swRecordLayout										
swRefreshTiming	x	x		0..1			0..1	0..1	0..1	0..1
swTextProps										
swValueBlockSize										
swValueBlockSizeMult										
unit										



¹⁵don't care



Attributes of SwDataDefProps	Root Element			Attribute Existence per Category				
valueAxisDataType								

Table 5.34: Allowed Attributes vs. `category` for `DataPrototypes` typed by `ImplementationDataTypes`

[constr_1288] Allowed Attributes vs. `category` for `DataPrototypes` typed by `ImplementationDataTypes` [The allowed values per `category` for `DataPrototypes` typed by `ImplementationDataTypes` are documented in table 5.34.]()

[TPS_SWCT_01266] Three non-abstract classes derived from `AutosarDataPrototype` [There are three non-abstract classes derived from `AutosarDataPrototype` which reflect the main use cases in the SWC-Template:

- Operation arguments (`ArgumentDataPrototype`) in a client-server interface.
- Variables (`VariableDataPrototype`) which are changed by the application software at runtime.
- Parameters (`ParameterDataPrototype`) which are constant (except for calibration access) from the application point of view.

]()

Class	VariableDataPrototype			
Package	M2::AUTOSARTemplates::SWComponentTemplate::Datatype::DataPrototypes			
Note	A <code>VariableDataPrototype</code> is used to contain values in an ECU application. This means that most likely a <code>VariableDataPrototype</code> allocates "static" memory on the ECU. In some cases optimization strategies might lead to a situation where the memory allocation can be avoided. In particular, the value of a <code>VariableDataPrototype</code> is likely to change as the ECU on which it is used executes.			
Base	<code>ARObject</code> , <code>AtpFeature</code> , <code>AtpPrototype</code> , <code>AutosarDataPrototype</code> , <code>DataPrototype</code> , <code>Identifiable</code> , <code>MultilanguageReferrable</code> , <code>Referrable</code>			
Attribute	Type	Mult.	Kind	Note
initValue	<code>ValueSpecification</code>	0..1	aggr	Specifies initial value(s) of the <code>VariableDataPrototype</code>

Table 5.35: VariableDataPrototype

Class	ParameterDataPrototype			
Package	M2::AUTOSARTemplates::SWComponentTemplate::Datatype::DataPrototypes			
Note	A parameter element used for parameter interface and internal behavior, supporting signal like parameter and characteristic value communication patterns and parameter and characteristic value definition.			
Base	<code>ARObject</code> , <code>AtpFeature</code> , <code>AtpPrototype</code> , <code>AutosarDataPrototype</code> , <code>DataPrototype</code> , <code>Identifiable</code> , <code>MultilanguageReferrable</code> , <code>Referrable</code>			
Attribute	Type	Mult.	Kind	Note
initValue	<code>ValueSpecification</code>	0..1	aggr	Specifies initial value(s) of the <code>ParameterDataPrototype</code>

Table 5.36: ParameterDataPrototype

[TPS_SWCT_01267] **DataPrototype can be aggregated in different roles** [Note that even though the meta-classes `VariableDataPrototype` and `ParameterDataPrototype` already express specific use cases of the underlying data type the same `DataPrototype` can still be aggregated in different roles, e.g. in the `SwcInternalBehavior` to express different methods how to access it.]()

An example is the aggregation of `VariableDataPrototype` by `SwcInternalBehavior` in the roles of either `implicitInterRunnableVariable` or `explicitInterRunnableVariable`. Find more information concerning these use cases in chapter 7.

[TPS_SWCT_01268] **Definition of `initValue` for a `VariableDataPrototype` or a `ParameterDataPrototype`** [It is possible to assign an `initValue` for both a `VariableDataPrototype` and a `ParameterDataPrototype`.]()

This aspect is sketched in Figure 5.22.

[TPS_SWCT_01269] **In `PortInterfaces`, initial values defined for `DataPrototypes` are ignored** [These `initValues` have no meaning for `DataPrototypes` within `PortInterfaces` because in this case a more specific definition of initial values via the so-called `ComSpec` is required.]()

For more information, please refer to chapter 4.5.

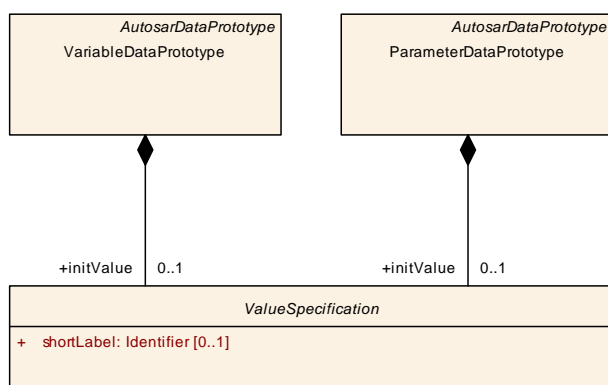

Figure 5.22: Initial value for `AutosarDataPrototypes`

Find more information about the interpretation of `initValue` in section 5.7.

[constr_1416] **Existence of `ApplicationArrayElement.maxNumberOfElements`** [The attribute `ApplicationArrayElement.maxNumberOfElements` shall exist for all `ApplicationArrayElements` defined in the scope of an `ApplicationArrayDataType` where the attribute `ApplicationArrayDataType.dynamicArraySizeProfile` does not exist.]()

This means that for fixed-size array data types the attribute `ApplicationArrayElement.maxNumberOfElements` shall be defined for every dimension of the fixed-size array data.

5.3.2 Data Constraints for DataPrototypes typed by Array DataTypes

There are cases where it should be possible to reference different `DataConstrs` from `DataPrototypes` of `category ARRAY` typed by either an `ApplicationArrayDataType` or an `ImplementationDataType` of `category ARRAY`.

For example, consider a predefined `AutosarDataType` of `category ARRAY` with `uint8` elements, but without the definition of `DataConstrs`.

This `AutosarDataType` is instantiated several times by means of the existence of `DataPrototypes` of `category ARRAY`.

Each of the derived `DataPrototypes` of `category ARRAY` may have individual upper and lower limits which apply to all elements, e.g. one `DataPrototype` has a range of 0..3 while another has a range of 0..7 for all elements.

This use case occurs, for example, when communicating array-data with different ranges over the network.

The motivation to specify the `DataConstr` at the `DataPrototype` of `category ARRAY` is:

- Make explicit that all derived `DataPrototypes` are based on the same `AutosarDataType`.
- Reduce the number of `AutosarDataTypes` in the model and in the code.
- Specify the `DataConstrs` only once where needed.
- Make explicit that all array elements have the same `DataConstrs`.

The same motivation also applies to the `SwDataDefProps.displayFormat` and `SwDataDefProps.stepSize` attributes of `DataPrototypes` of `category ARRAY`.

AUTOSAR supports this use case under the following conditions:

[constr_1407] Definition of `SwDataDefProps.dataConstr` depending on the capabilities of the data type [The definition of a `SwDataDefProps.dataConstr` according to [constr_1288] and [constr_1289] is only supported for a `DataPrototype` of `category ARRAY` if the corresponding `ApplicationArrayDataType` or `ImplementationDataType` of `category ARRAY` also supports the specification of a `SwDataDefProps.dataConstr`.]()

The prioritization of `SwDataDefProps.dataConstr` for a `DataPrototype` of `category ARRAY` follows the spirit given in [constr_1015] for the inheritance of `DataPrototypes` from `AutosarDataTypes`.

[TPS_SWCT_01796] Prioritization of `SwDataDefProps.dataConstr` for a `DataPrototype` of `category ARRAY` [A `SwDataDefProps.dataConstr` specified for a `DataPrototype` of `category ARRAY` refines the `SwDataDefProps.dataConstr` specified at the corresponding `ApplicationArrayDataType` or `ImplementationDataType` of `category ARRAY`.]()

[constr_1408] Definition of `SwDataDefProps.displayFormat` depending on the capabilities of the data type [The definition of a `SwDataDefProps.displayFormat` according to [constr_1288] and [constr_1289] is only supported for a `DataPrototype` of category `ARRAY` if the corresponding `ApplicationArrayDataType` or `ImplementationDataType` of category `ARRAY` also supports the specification of a `SwDataDefProps.displayFormat`.]()

The prioritization of `SwDataDefProps.displayFormat` for a `DataPrototype` of category `ARRAY` follows the spirit given in [constr_1015] for the inheritance of `DataPrototypes` from `AutosarDataTypes`.

[TPS_SWCT_01797] Prioritization of `SwDataDefProps.displayFormat` for a `DataPrototype` of category `ARRAY` [A `SwDataDefProps.displayFormat` specified for a `DataPrototype` of category `ARRAY` refines the `SwDataDefProps.displayFormat` specified at the corresponding `ApplicationArrayDataType` or `ImplementationDataType` of category `ARRAY`.]()

[constr_1413] Definition of `SwDataDefProps.stepSize` depending on the capabilities of the data type [The definition of a `SwDataDefProps.stepSize` according to [constr_1288] and [constr_1289] is only supported for a `DataPrototype` of category `ARRAY` if the corresponding `ApplicationArrayDataType` or `ImplementationDataType` of category `ARRAY` also supports the specification of a `SwDataDefProps.stepSize`.]()

The prioritization of `SwDataDefProps.stepSize` for a `DataPrototype` of category `ARRAY` follows the spirit given in [constr_1015] for the inheritance of `DataPrototypes` from `AutosarDataTypes`.

[TPS_SWCT_01798] Prioritization of `SwDataDefProps.stepSize` for a `DataPrototype` of category `ARRAY` [A `SwDataDefProps.stepSize` specified for a `DataPrototype` of category `ARRAY` refines the `SwDataDefProps.stepSize` specified at the corresponding `ApplicationArrayDataType` or `ImplementationDataType` of category `ARRAY`.]()

[constr_1409] Definition of `SwDataDefProps.dataConstr` depending on the capabilities of the element data type [The definition of a `SwDataDefProps.dataConstr` according to [constr_1007] and [constr_1009] is only supported for an `ApplicationArrayDataType` or an `ImplementationDataType` of category `ARRAY` if the aggregated `ApplicationArrayDataType.element` or `ImplementationDataType.subElement` also supports the specification of a `SwDataDefProps.dataConstr`.]()

[constr_1718] Inheritance of `SwDataDefProps.dataConstr` from an array data type to the array elements [A `SwDataDefProps.dataConstr` specified for an `ApplicationArrayDataType` or `ImplementationDataType` of category `ARRAY` applies to all array leaf elements represented by (potentially multiple levels of) `ApplicationArrayDataType.element` or `ImplementationDataType.subElement`.

In this case, the `ApplicationArrayDataType.element` or `ImplementationDataType.subElement` shall not have an own `SwDataDefProps.dataConstr`. This also applies for multi-dimensional array data types.]()

[constr_1410] Definition of `SwDataDefProps.displayFormat` depending on the capabilities of the element data type [The definition of a `SwDataDefProps.displayFormat` according to [constr_1007] and [constr_1009] is only supported for an `ApplicationArrayDataType` or an `ImplementationDataType` of category `ARRAY` if the aggregated `ApplicationArrayDataType.element` or `ImplementationDataType.subElement` also supports the specification of a `SwDataDefProps.displayFormat`.]()

[constr_1719] Inheritance of `SwDataDefProps.displayFormat` from an array data type to the array elements [A `SwDataDefProps.displayFormat` specified for an `ApplicationArrayDataType` or `ImplementationDataType` of category `ARRAY` applies to all array leaf elements represented by (potentially multiple levels of) `ApplicationArrayDataType.element` or `ImplementationDataType.subElement`.

In this case, the `ApplicationArrayDataType.element` or `ImplementationDataType.subElement` shall not have an own `SwDataDefProps.displayFormat`. This also applies for multi-dimensional array data types.]()

[constr_1414] Definition of `SwDataDefProps.stepSize` depending on the capabilities of the element data type [The definition of a `SwDataDefProps.stepSize` according to [constr_1007] and [constr_1009] is only supported for an `ApplicationArrayDataType` or an `ImplementationDataType` of category `ARRAY` if the aggregated `ApplicationArrayDataType.element` or `ImplementationDataType.subElement` also supports the specification of a `SwDataDefProps.stepSize`.]()

[constr_1720] Inheritance of `SwDataDefProps.stepSize` from an array data type to the array elements [A `SwDataDefProps.stepSize` specified for an `ApplicationArrayDataType` or `ImplementationDataType` of category `ARRAY` applies to all array leaf elements represented by (potentially multiple levels of) `ApplicationArrayDataType.element` or `ImplementationDataType.subElement`.

In this case, the `ApplicationArrayDataType.element` or `ImplementationDataType.subElement` shall not have an own `SwDataDefProps.stepSize`. This also applies for multi-dimensional array data types.]()

5.3.3 Reference to Data Prototypes

This chapter explains the various patterns for referencing `DataPrototypes`.

[TPS_SWCT_01446] References to a `DataPrototype` may or may not imply the necessity for using an `instanceRef` [As references to a `DataPrototype` may or may not imply the necessity for using an `instanceRef` this would mean that in some places the meta-model would have to implement both variants depending on the

use case. To avoid this, AUTOSAR defines a unified reference implementation for `VariableDataPrototypes` and `ParameterDataPrototypes`.¹()

5.3.3.1 AUTOSAR Variable Ref

[TPS_SWCT_01270] `AutosarVariableRef` [With the advent of `AutosarVariableRef` it is possible to implement a uniform reference to a `VariableDataPrototype` that covers all foreseen use cases:

- Reference to a `localVariable`, no `AtpInstanceRef` required.
- Reference to an `autosarVariable` (which involves an `AtpInstanceRef`).
- Reference to the internal structure of a `VariableDataPrototype` implemented using a composite `ImplementationDataType`.

¹()

Class	AutosarVariableRef			
Package	M2::AUTOSARTemplates::SWComponentTemplate::SwcInternalBehavior::DataElements			
Note	<p>This class represents a reference to a variable within AUTOSAR which can be one of the following use cases:</p> <p>localVariable:</p> <ul style="list-style-type: none"> • localVariable which is used as whole (e.g. InterRunnableVariable, inputValue for curve) <p>autosarVariable:</p> <ul style="list-style-type: none"> • a variable provided via Port which is used as whole (e.g. dataAccesspoints) • an element inside of a composite local variable typed by ApplicationDatatype (e.g. inputValue for a curve) • an element inside of a composite variable provided via Port and typed by ApplicationDatatype (e.g. inputValue for a curve) <p>autosarVariableInImplDatatype:</p> <ul style="list-style-type: none"> • an element inside of a composite local variable typed by ImplementationDatatype (e.g. nvram Data mapping) • an element inside of a composite variable provided via Port and typed by Implementation Datatype (e.g. inputValue for a curve) 			
Base	ARObject			
Attribute	Type	Mult.	Kind	Note
autosarVariable	<code>DataPrototype</code>	0..1	iref	This references a variable which is provided by a port and/or which is part of a CompositeDataType.
autosarVariableInImplDatatype	<code>ArVariableInImplementationDataInstanceRef</code>	0..1	aggr	This is used if the target variable is inside of variableData Prototype typed by an ImplementationDataType.





Class	AutosarVariableRef			
localVariable	VariableDataPrototype	0..1	ref	This reference is used if the variable is local to the current component. It would also be possible to use the instance reference here. Such an instance ref would not have a contextElement, since the current instance is the context. But the local instance is a special case which may provide further optimization. Therefore an explicit reference is provided for this case.

Table 5.37: AutosarVariableRef

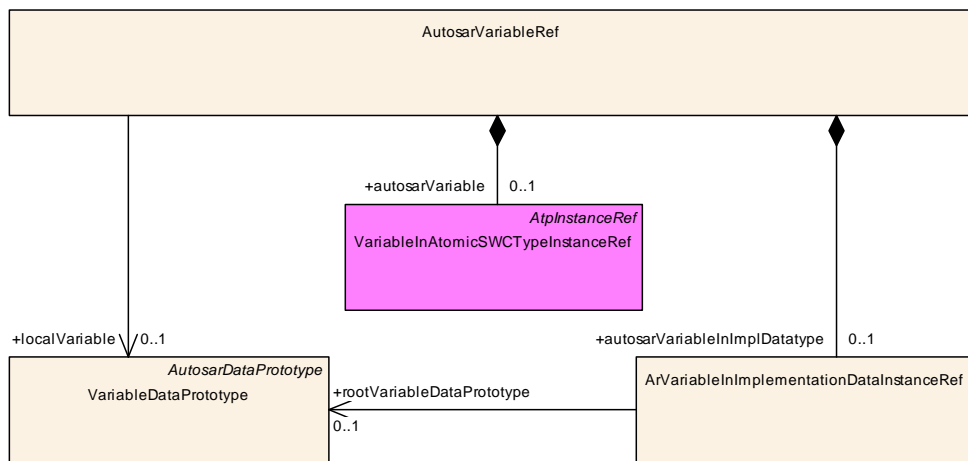

Figure 5.23: Implementation of AutosarVariableRef

Rules for the modeling and semantics of an [AtpInstanceRef](#) are defined in [11].

[constr_2536] Target of an autosarVariable in AutosarVariableRef shall refer to a variable [The target of [autosarVariable](#) (which in fact is an instance ref) in [AutosarVariableRef](#) shall either be or be nested in [VariableDataPrototype](#). This means that the target shall either be a [VariableDataPrototype](#) or an [ApplicationCompositeElementDataPrototype](#) that in turn is owned by a [VariableDataPrototype](#).]()

5.3.3.2 AUTOSAR Parameter Ref

[TPS_SWCT_01271] AutosarParameterRef [With the advent of [AutosarParameterRef](#) it is possible to implement a uniform reference to a [ParameterDataPrototype](#) that covers all foreseen use cases:

- Reference to a [localParameter](#), no [AtpInstanceRef](#) required.
- Reference to an [autosarParameter](#) (which involves an [AtpInstanceRef](#)).

]()

Please note that there is a very limited amount of use-cases available where the [AutosarParameterRef](#) can (with the active consent of the AUTOSAR standard) reference a [VariableDataPrototype](#).

[constr_1173] Applicability of AutosarParameterRef referencing a VariableDataPrototype [A reference from AutosarParameterRef to VariableDataPrototype is **only** applicable if the AutosarParameterRef is used in the context of SwAxisGrouped.]()

For example, the use case referenced in [constr_1173] applies if it is required to store a grouped axis in a variable in order to adapt the axis during run-time of the ECU by a dedicated algorithm. Note that in all cases where [constr_1173] does not apply [constr_2535] shall be fulfilled.

Class	AutosarParameterRef			
Package	M2::AUTOSARTemplates::SWComponentTemplate::SwcInternalBehavior::DataElements			
Note	<p>This class represents a reference to a parameter within AUTOSAR which can be one of the following use cases:</p> <p>localParameter:</p> <ul style="list-style-type: none"> • localParameter which is used as whole (e.g. sharedAxis for curve) <p>autosarVariable:</p> <ul style="list-style-type: none"> • a parameter provided via PortPrototype which is used as whole (e.g. parameterAccess) • an element inside of a composite local parameter typed by ApplicationDatatype (e.g. sharedAxis for a curve) • an element inside of a composite parameter provided via Port and typed by ApplicationDatatype (e.g. sharedAxis for a curve) <p>autosarParameterInImplDatatype:</p> <ul style="list-style-type: none"> • an element inside of a composite local parameter typed by ImplementationDatatype • an element inside of a composite parameter provided via PortPrototype and typed by ImplementationDatatype 			
Base	ARObject			
Attribute	Type	Mult.	Kind	Note
autosarParameter	DataPrototype	0..1	iref	This instance reference is used if the calibration parameter is either imported via a port or is part of a composite data structure.
localParameter	DataPrototype	0..1	ref	<p>In the majority of cases this reference goes to ParameterDataPrototypes rather than VariableDataPrototypes. Pointing the reference to a VariableDataPrototype is limited to special use cases, e.g. if the AutosarParameterRef is used in the context of an SwAxisGrouped.</p> <p>This reference is used if the arParameter is local to the current component.</p> <p>Of course, it would technically also be feasible to use an InstanceRef for this case. However, the InstanceRef would not have a contextElement (because the current instance is the context).</p> <p>Hence, the local instance is a special case which may provide further optimization. Therefore an explicit reference is provided for this case.</p>

Table 5.38: AutosarParameterRef

[constr_2535] Target of an autosarParameter in AutosarParameterRef shall refer to a parameter [Except for the specifically described cases where [constr_1173] applies the target of autosarParameter (which in fact is an instance ref) in AutosarParameterRef shall either be or be nested in ParameterDataPrototype.

This means that the target shall either be a `ParameterDataPrototype` or an `ApplicationCompositeElementDataPrototype` that in turn is owned by a `ParameterDataPrototype`.`]()`

5.3.3.3 Modeling Approach

[constr_1161] Applicability of the `index` attribute of `Ref` [The `index` attribute of `Ref` is limited to a given set if use cases as there are:

- `McDataInstance.instanceInMemory`
- `AutosarVariableRef`
- `AutosarParameterRef`
- `FlatInstanceDescriptor / AnyInstanceRef`

`]()`

The implementation of the `AtpInstanceRefs` for `AutosarVariableRef` and `AutosarParameterRef` probably needs some clarification regarding the references to `DataPrototypes`.

[TPS_SWCT_01374] Implementation of `AutosarParameterRef` [The reference to `rootParameterDataPrototype` is **not** redundant. It is required for identifying the `autosarParameter` itself in a `ParameterInterface` for the case that the `targetDataPrototype` is an `ApplicationCompositeElementDataPrototype`.`]()`

As explained before, the implementation of `AutosarParameterRef` in a specific case is subject to **[constr_1173]**.

[constr_1608] Existence of `rootParameterDataPrototype` [The reference `rootParameterDataPrototype` shall exist if and only if

- `AutosarDataType` of the `autosarParameter` is a composite data type and
- `targetDataPrototype` refers to a `DataPrototype` inside the `rootParameterDataPrototype`.

`]()`

Note: If the target of the `AtpInstanceRef` is an `AutosarDataPrototype` then the `rootParameterDataPrototype` shall not exist.

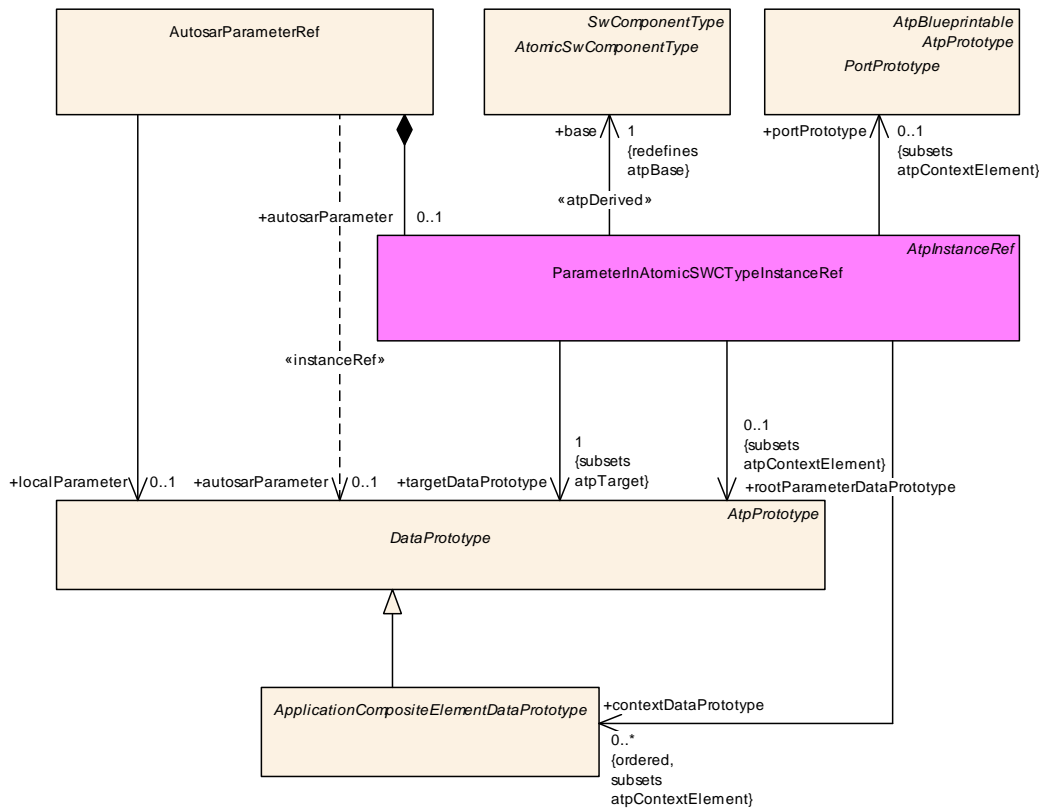

Figure 5.24: Implementation of the InstanceRef for AutosarParameterRef

[TPS_SWCT_01375] Implementation of AutosarVariableRef [The reference to rootVariableDataPrototype is not redundant. It is required for identifying the autosarVariable itself in a SenderReceiverInterface or NvDataInterface for the case that the targetDataPrototype is an ApplicationCompositeElementDataPrototype.]()

[constr_1609] Existence of rootVariableDataPrototype [The reference rootVariableDataPrototype shall exist if and only if

- the AutosarDataType of the autosarVariable is a composite data type and
- the targetDataPrototype refers to a DataPrototype inside the rootVariableDataPrototype.

]()

Note: If the target of the AtpInstanceRef is an AutosarDataPrototype then the rootVariableDataPrototype shall not exist.

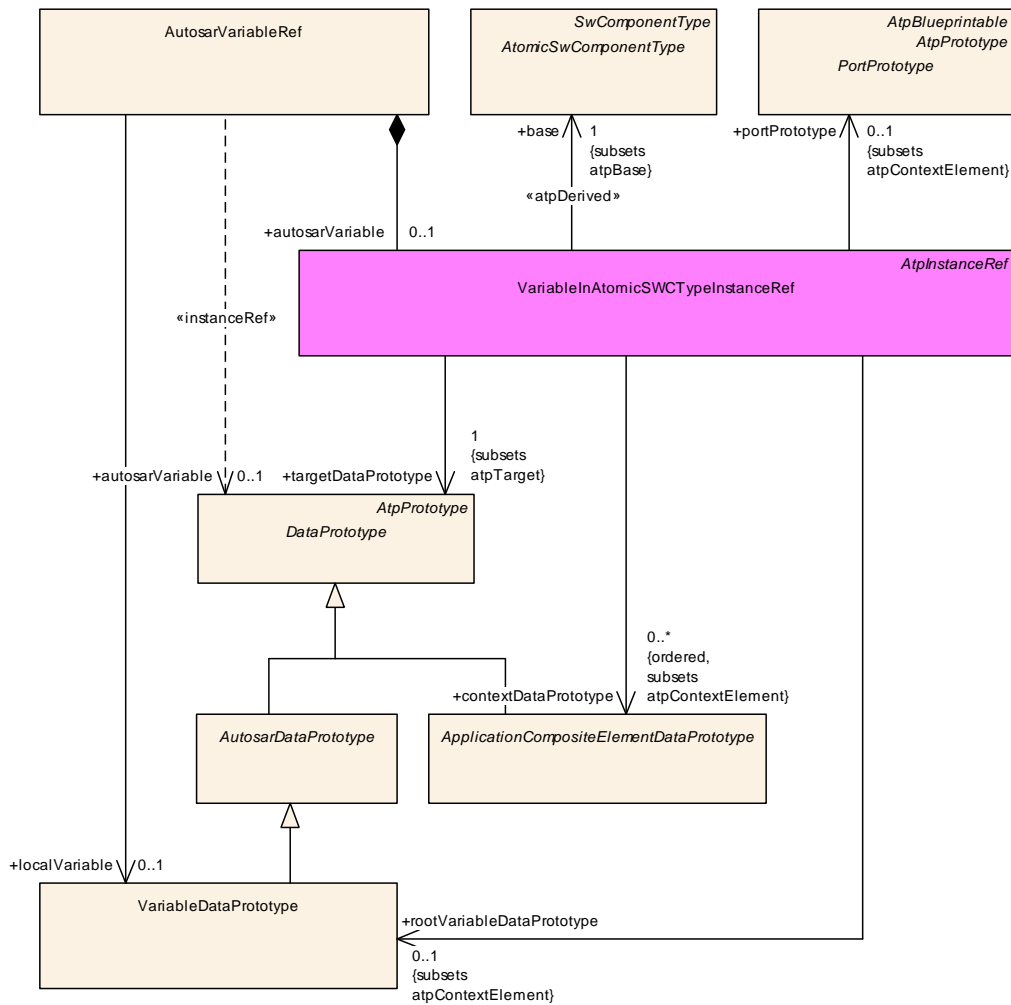

Figure 5.25: Implementation of the InstanceRef for **AutosarVariableRef**

5.3.3.4 Access into VariableDataPrototype typed by an Implementation-DataType

The meta-class `ArVariableInImplementationDataInstanceRef`, despite the name, has formally no relationship to `AtpInstanceRef`. Therefore, the following definition applies:

[TPS_SWCT_01681] Context path in `ArVariableInImplementationDataInstanceRef` [The references in the roles

- `portPrototype`
- `rootVariableDataPrototype`
- ordered collection of `contextDataPrototype`
- `targetDataPrototype`

constitute the path leading from the root to the specified inner instance of a `dataElement` inside a `VariableDataPrototype` typed by an `ImplementationDataTypes`.`()`

This relation is also depicted in Figure 5.26.

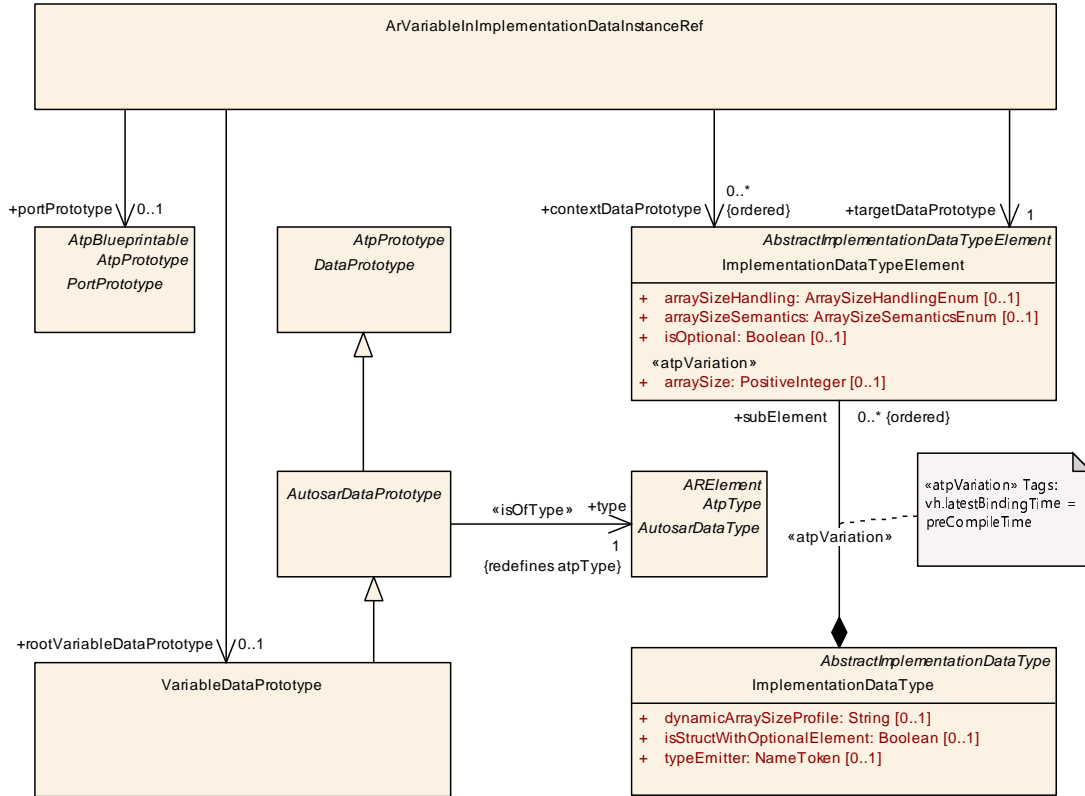

Figure 5.26: Implementation of `ArVariableInImplementationDataInstanceRef`

[constr_1423] Completeness of references `ArVariableInImplementationDataInstanceRef.contextDataPrototype` [The reference `ArVariableInImplementationDataInstanceRef.contextDataPrototype` shall be defined for

- each *leaf* (i.e. the end of a chain of aggregating elements) `ImplementationDataElement` of category `TYPE_REFERENCE` in a chain of referencing `ImplementationDataTypes` which is not the `targetDataPrototype`
- and each `ImplementationDataElement` owned by an `ImplementationDataType` or `ImplementationDataElement` of category `ARRAY` in a chain of referencing `ImplementationDataTypes`

starting from the `ImplementationDataTypes` of the `rootVariableDataPrototype` down to the leaf `ImplementationDataElement` which is typed (directly or indirectly via `ImplementationDataType` of category `TYPE_REFERENCE`) by the `ImplementationDataType` of the `targetDataPrototype`.`()`

Figure 5.27 contains an example of a nested `ImplementationDataType` along with the application of `ArVariableInImplementationDataInstanceRef`. The example contains both cases for the definition of a `contextDataPrototype` mentioned in [constr_1423].

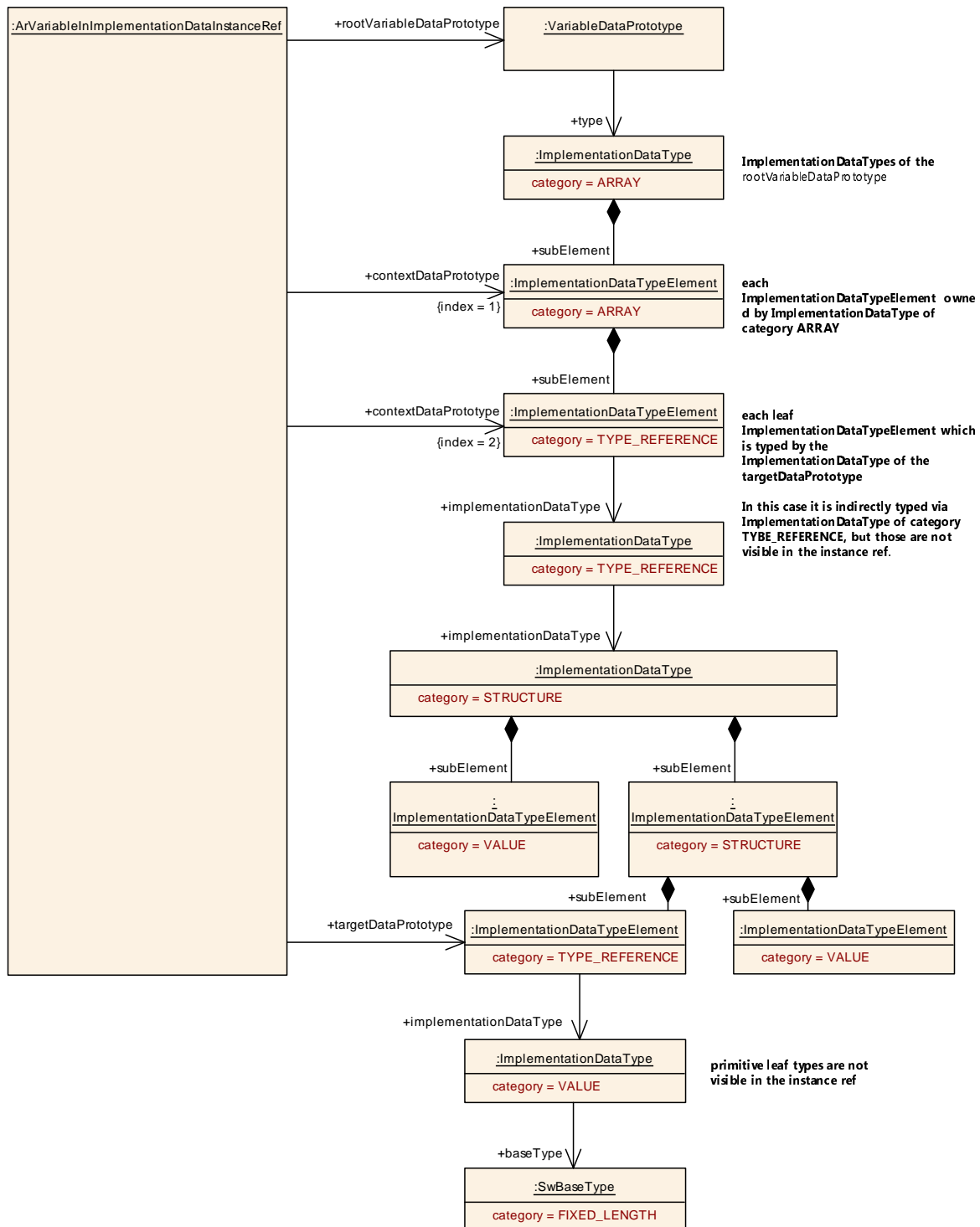

Figure 5.27: Example for the usage of `ArVariableInImplementationDataInstanceRef`

[constr_1424] Existence of [ArVariableInImplementationDataInstanceRef.contextDataPrototype](#) [The attribute [ArVariableInImplementationDataInstanceRef.contextDataPrototype](#) shall only exist for an [ImplementationDataTypeElement](#) category `TYPE_REFERENCE` or `ARRAY`.] ()

Technically, it would be possible to avoid the context for a one-dimensional array in the hierarchy. The context is still required because then the rule for the existence of contexts becomes much simpler.

Class	ArVariableInImplementationDataInstanceRef			
Package	M2::AUTOSARTemplates::SWComponentTemplate::SwcInternalBehavior::DataElements			
Note	<p>This class represents the ability to navigate into a data element inside of an VariableDataPrototype which is typed by an ImplementationDatatype.</p> <p>Note that it shall not be used if the target is the VariableDataPrototype itself (e.g. if its a primitive).</p> <p>Note that this class follows the pattern of an InstanceRef but is not implemented based on the abstract classes because the ImplementationDataType isn't either, especially because ImplementationDataTypeElement isn't derived from AtpPrototype.</p>			
Base	ARObject			
Attribute	Type	Mult.	Kind	Note
contextData Prototype (ordered)	ImplementationDataTypeElement	*	ref	<p>This is a context in case there are subelements with explicit types. The reference has to be ordered to properly reflect the nested structure.</p> <p>Tags:xml.sequenceOffset=30</p>
portPrototype	PortPrototype	0..1	ref	<p>This is the port providing/receiving the root of the variable</p> <p>Tags:xml.sequenceOffset=10</p>
rootVariable DataPrototype	VariableDataPrototype	0..1	ref	<p>This refers to the VariableDataPrototype typed by the ImplementationDatatype in which the target can be found.</p> <p>Tags:xml.sequenceOffset=20</p>
targetData Prototype	ImplementationDataTypeElement	1	ref	<p>This reference points to the target ImplementationDataTypeElement.</p> <p>Tags:xml.sequenceOffset=40</p>

Table 5.39: ArVariableInImplementationDataInstanceRef

5.3.3.5 Access into [ParameterDataPrototype](#) typed by an [ImplementationDataType](#)

Please note that it is also possible to access the inside of a nested [ParameterDataPrototype](#) typed by an [ImplementationDataType](#) in pretty much the same way as this is possible for a [VariableDataPrototype](#) typed by an [ImplementationDataType](#).

[TPS_SWCT_01738] Context path in [ArParameterInImplementationDataInstanceRef](#) [The references in the roles

- [portPrototype](#)
- [rootParameterDataPrototype](#)
- ordered collection of [contextDataPrototype](#)

- `targetDataPrototype`

constitute the path leading from the root to the specified inner instance of a `parameter` inside a `ParameterDataPrototype` typed by an `ImplementationDataType`.]()

This relation is also depicted in Figure 5.28.

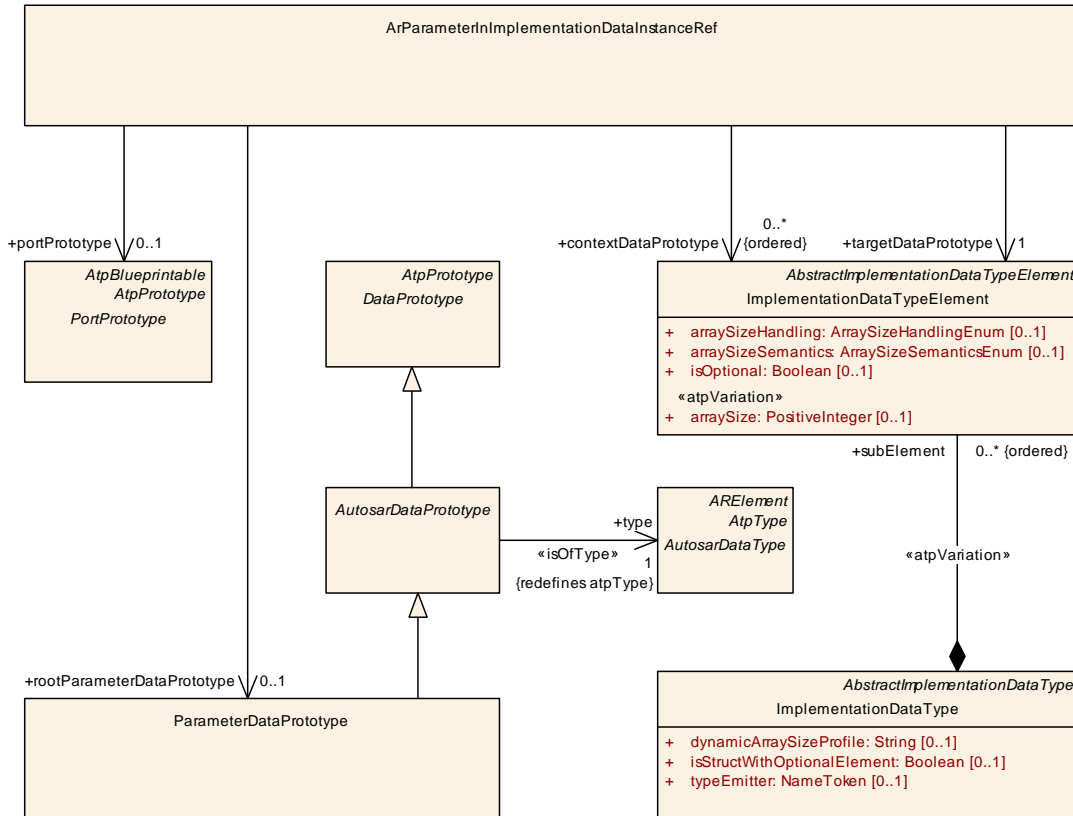

Figure 5.28: Implementation of `ArParameterInImplementationDataInstanceRef`

[constr_1516] **Completeness of references `ArParameterInImplementationDataInstanceRef.contextDataPrototype`** [The reference `ArParameterInImplementationDataInstanceRef.contextDataPrototype` shall be defined for

- each *leaf* (i.e. the end of a chain of aggregating elements) `ImplementationDataTypeElement` of category `TYPE_REFERENCE` in a chain of referencing `ImplementationDataTypes` which is not the `targetDataPrototype`
- and each `ImplementationDataTypeElement` owned by an `ImplementationDataType` or `ImplementationDataTypeElement` of category `ARRAY` in a chain of referencing `ImplementationDataTypes`

starting from the `ImplementationDataTypes` of the `rootParameterDataPrototype` down to the leaf `ImplementationDataTypeElement` which is typed (directly or indirectly via `ImplementationDataType` of category `TYPE_REFERENCE`) by the `ImplementationDataType` of the `targetDataPrototype`.]()

[constr_1517] Existence of [ArParameterInImplementationDataInstanceRef.contextDataPrototype](#) [The attribute [ArParameterInImplementationDataInstanceRef.contextDataPrototype](#) shall only exist for an [ImplementationDataTypeElement](#) category `TYPE_REFERENCE` or `ARRAY`.]()

Technically, it would be possible to avoid the context for a one-dimensional array in the hierarchy. The context is still required because then the rule for the existence of contexts becomes much simpler.

Class	ArParameterInImplementationDataInstanceRef			
Package	M2::AUTOSARTemplates::SWComponentTemplate::SwcInternalBehavior::DataElements			
Note	<p>This class represents the ability to navigate into an element inside of an ParameterDataPrototype typed by an ImplementationDatatype.</p> <p>Note that it shall not be used if the target is the ParameterDataPrototype itself (e.g. if the target is a primitive data type).</p> <p>Note that this class follows the pattern of an InstanceRef but is not implemented based on the abstract classes because the ImplementationDataType isn't either, especially because ImplementationDataTypeElement (intentionally) isn't derived from AtpPrototype.</p>			
Base	ARObject			
Attribute	Type	Mult.	Kind	Note
contextDataPrototype (ordered)	ImplementationDataTypeElement	*	ref	This is a context in case there are subelements with explicit types. The reference has to be ordered to properly reflect the nested structure.
portPrototype	PortPrototype	0..1	ref	This reference points to the PortPrototype providing/receiving the root of the parameter.
rootParameterDataPrototype	ParameterDataPrototype	0..1	ref	This refers to the ParameterDataPrototype typed by the implementationDataType in which the target can be found.
targetDataPrototype	ImplementationDataTypeElement	1	ref	This reference points to the target ImplementationDataTypeElement .

Table 5.40: ArParameterInImplementationDataInstanceRef

5.4 Properties of Data Definitions

5.4.1 Overview

As it has already been shown in the previous chapters, various properties and associations can be attached to the definition of data types as well as prototypes. These are described by the meta-class [SwDataDefProps](#) which covers all properties of a particular data object under various aspects.

In general, the properties specified within [SwDataDefProps](#) may apply to all kind of data declared within the software-component template and within the basic software module description template as well, e.g. component local data, data used for communication, data used for measurement as well as for calibration.

However, there are constraints for the attributes depending on the role of the data:

[constr_1015] Prioritization of `SwDataDefProps` [The prioritization and usage of attributes of meta-class `SwDataDefProps` shall follow the restrictions given in table 5.41.]()

Attributes of <code>SwDataDefProps</code>	Usage For			Place of Setting										
	RTE	A2L	Other Usage	ApplicationDataType	ImplementationDataType	DataPrototype	InstantiationDataDefProps	ParameterAccess	ComSpec	SwServiceArg	FlatInstanceDescriptor	McDataInstance	SwSystemconst	PerInstanceMemory
<code>additionalNativeTypeQualifier</code>	x		x	NA	D	I	NA	NA	NA	D	NA	S	NA	NA
<code>annotation</code>			x	D	A	A	A	A	A	D	NA	A	D	NA
<code>baseType</code>	x	x	x	NA	D	I	I	I	R	D	NA	S	M	NA
<code>compuMethod</code>	x	x	x	D	AI	I	I	NA	R	I	AI	S	D	NA
<code>dataConstr</code>	x	x	x	D	C	R	R	I	NA	R	NA	S	D	NA
<code>displayFormat</code>		x		D	A	R	R	I	NA	R	NA	S	D	NA
<code>displayPresentation</code>	x	x	x	D	A	R	R	NA	NA	NA	NA	S	NA	NA
<code>implementationDataType</code>	x		x	NA	D	I	I	I	NA	D	NA	NA	NA	NA
<code>invalidValue</code>	x	x		D	A	I	I	NA	D	NA	NA	S	NA	NA
<code>stepSize</code>		x		D	A	A	A	A	NA	NA	A	S	NA	NA
<code>swAddrMethod</code>	x	x	x	D	R	R	R	NA	NA	NA	R	NA	NA	D
<code>swAlignment</code>	x		x	NA	D	R	R	NA	NA	NA	NA	NA	NA	NA
<code>swBitRepresentation</code>		x	x	NA	NA	NA	NA	NA	NA	NA	NA	D	NA	NA
<code>swCalibrationAccess</code>	x	x		D	R	R	R	NA	NA	R	R	S	D	NA
<code>swCalprmAxisSet</code>	x	x		D	NA	I	I	I	NA	NA	NA	S	NA	NA
<code>swCalprmAxisSet.swCalprmAxis/SwAxisGrouped.swCalprmRef</code>		x		NA	NA	NA	D	R	NA	NA	NA	S	NA	NA
<code>swCalprmAxisSet.swCalprmAxis/SwAxisIndividual.swVariableRef</code>		x		NA	NA	NA	D	R	NA	NA	NA	S	NA	NA
<code>swCalprmAxisSet.swCalprmAxis/SwAxisGrouped.sharedAxisType</code>		x		D	NA	NA	NA	NA	NA	NA	NA	S	NA	NA
<code>swCalprmAxisSet.swCalprmAxis/SwAxisIndividual.inputVariableType</code>		x		D	NA	NA	NA	NA	NA	NA	NA	S	NA	NA
<code>swCalprmAxisSet/SwAxisIndividual.unit</code>		opt.		D	NA	I	I	I	NA	I	NA	S	NA	NA
<code>swComparisonVariable</code>		x		NA	NA	NA	NA	D	NA	NA	NA	S	NA	NA
<code>swDataDependency</code>		x	x	NA	NA	D	R	NA	NA	NA	NA	S	NA	NA
<code>swHostVariable</code>		x	x	NA	NA	NA	NA	NA	NA	NA	NA	D	NA	NA
<code>swImplPolicy</code>	x		x	D	A	A	NA	NA	NA	D	NA	NA	NA	NA
<code>swIntendedResolution</code>			x	D ¹⁶	NA	NA	NA	NA	NA	NA	NA	NA	NA	NA
<code>swInterpolationMethod</code>			x	D	I	R	R	R	NA	NA	NA	S	NA	NA
<code>swIsVirtual</code>		x		NA	NA	D	R	NA	NA	NA	NA	S	NA	NA
<code>swPointerTargetProps</code>			x	NA	D	I	NA	NA	NA	D	NA	NA	NA	NA



¹⁶`swIntendedResolution` is used only in an early phase of the definition of data types, namely in the context of the definition of so-called blueprints. To that extent, `swIntendedResolution` represents a non-binding requirement that shall later be considered for the definition of an appropriate `CompuMethod`.



Attributes of SwDataDefProps	Usage For			Place of Setting											
	RTE	A2L	Other Usage	ApplicationDataType	ImplementationDataType	DataPrototype	InstantiationDataDefProps	ParameterAccess	ComSpec	SwServiceArg	FlatInstanceDescriptor	McDataInstance	SwSystemconst	PerInstanceMemory	
swRecordLayout	x	x	x	D	NA	I	I	I	NA	NA	NA	S	NA	NA	
swRefreshTiming		x		D	R	R	R	NA	NA	R	R	R	NA	NA	
swTextProps		x	x	D	I	I	I	I	NA	NA	NA	S	NA	NA	
swValueBlockSize		x	x	D	I	I	I	I	NA	NA	NA	S	NA	NA	
swValueBlockSizeMult		x	x	D	I	I	I	I	NA	NA	NA	S	NA	NA	
unit		x	x	D	I	I	I	NA	NA	I	NA	S	D	NA	
valueAxisDataType		x	x	D	I	I	I	I	NA	NA	NA	S	NA	NA	

Table 5.41: Usage of Attributes of SwDataDefProps

Please note that this table is (by reference) a part of [constr_1015]

The following settings apply in table 5.41:

D Define the attribute independent of settings to the left.

R Use or re-define definition from the left in the scope of this element.

A Add attribute if not defined on the left, or as additional information.

If the attribute has an upper multiplicity > 1 and the attribute is defined on the left then the attribute is added to the attribute defined on the left.

If the attribute has an upper multiplicity of 1 and the attribute is not defined on the left then the attribute is defined.

If the attribute has an upper multiplicity of 1 and the attribute is already defined on the left then the attribute is not redefined but this is considered as invalid configuration.

I Inherit the definition from the left for usage in the scope of this element.

NA Attribute is **not applicable** for usage in the scope of this element.

M Attribute is **meaningless** in the scope of this element. As it was allowed in previous versions, declaring it as Not Applicable (NA) would break compatibility. Tools shall ignore such an attribute without a warning.

C This means that the left element constrains right element.

AI If the attribute is already defined on the left then the attribute is not redefined but adds implementation-related information.

Example: an `ApplicationDataType` of category `BOOLEAN` supports the definition of an own `CompuMethod` to define the semantics of e.g. (ON, OFF) or (HIGH, LOW) or (PASSED, FAILED) **as long as the number of values match and matching pairs of values on application level and implementation level exist**. In contrast, the corresponding `ImplementationDataType` uses (true, false) as the applicable literals in any of the above mentioned cases.

S Create a “Self-contained” artifact based on the left.

Example: A `CompuMethod` defined in the context of a `System` of category `ECU_EXTRACT` is copied into the separate artifact for the `McSupportData` and references need to be updated to the copy.

Use case: Provide a `McDataGenerator` with a single, self-contained file to do its job.

Some property names contain the term “variable” or “calprm”, this comes from historical¹⁷ reasons and can be taken as some hint where the property most likely applies to.

Class	<<atpVariation>> SwDataDefProps			
Package	M2::MSR::DataDictionary::DataDefProperties			
Note	<p>This class is a collection of properties relevant for data objects under various aspects. One could consider this class as a "pattern of inheritance by aggregation". The properties can be applied to all objects of all classes in which <code>SwDataDefProps</code> is aggregated.</p> <p>Note that not all of the attributes or associated elements are useful all of the time. Hence, the process definition (e.g. expressed with an OCL or a Document Control Instance MSR-DCI) has the task of implementing limitations.</p> <p><code>SwDataDefProps</code> covers various aspects:</p> <ul style="list-style-type: none"> • Structure of the data element for calibration use cases: is it a single value, a curve, or a map, but also the <code>recordLayouts</code> which specify how such elements are mapped/converted to the Data Types in the programming language (or in AUTOSAR). This is mainly expressed by properties like <code>swRecordLayout</code> and <code>swCalprmAxisSet</code> • Implementation aspects, mainly expressed by <code>swImplPolicy</code>, <code>swVariableAccessImplPolicy</code>, <code>swAddrMethod</code>, <code>swPointerTargetProps</code>, <code>baseType</code>, <code>implementationDataType</code> and <code>additionalNativeTypeQualifier</code> • Access policy for the MCD system, mainly expressed by <code>swCalibrationAccess</code> • Semantics of the data element, mainly expressed by <code>compuMethod</code> and/or <code>unit</code>, <code>dataConstr</code>, <code>invalidValue</code> • Code generation policy provided by <code>swRecordLayout</code> <p>Tags:vh.latestBindingTime=codeGenerationTime</p>			
Base	<code>ARObject</code>			
Attribute	Type	Mult.	Kind	Note



¹⁷In the beginning of ASAM and MSR measurements and calibration parameters (characteristics) were separated and the properties were merged over the time.



Class	<<atpVariation>> SwDataDefProps			
additionalNativeTypeQualifier	NativeDeclarationString	0..1	attr	<p>This attribute is used to declare native qualifiers of the programming language which can neither be deduced from the baseType (e.g. because the data object describes a pointer) nor from other more abstract attributes. Examples are qualifiers like "volatile", "strict" or "enum" of the C-language. All such declarations have to be put into one string.</p> <p>Tags:xml.sequenceOffset=235</p>
annotation	Annotation	*	aggr	<p>This aggregation allows to add annotations (yellow pads ...) related to the current data object.</p> <p>Tags: xml.roleElement=true xml.roleWrapperElement=true xml.sequenceOffset=20 xml.typeElement=false xml.typeWrapperElement=false</p>
baseType	SwBaseType	0..1	ref	<p>Base type associated with the containing data object.</p> <p>Tags:xml.sequenceOffset=50</p>
compuMethod	CompuMethod	0..1	ref	<p>Computation method associated with the semantics of this data object.</p> <p>Tags:xml.sequenceOffset=180</p>
dataConstr	DataConstr	0..1	ref	<p>Data constraint for this data object.</p> <p>Tags:xml.sequenceOffset=190</p>
displayFormat	DisplayFormatString	0..1	attr	<p>This property describes how a number is to be rendered e.g. in documents or in a measurement and calibration system.</p> <p>Tags:xml.sequenceOffset=210</p>
displayPresentation	DisplayPresentationEnum	0..1	attr	<p>This attribute controls the presentation of the related data for measurement and calibration tools.</p>
implementationDataType	AbstractImplementationDataType	0..1	ref	<p>This association denotes the ImplementationDataType of a data declaration via its aggregated SwDataDefProps. It is used whenever a data declaration is not directly referring to a base type. Especially</p> <ul style="list-style-type: none"> • redefinition of an ImplementationDataType via a "typedef" to another ImplementationDatatype • the target type of a pointer (see SwPointerTarget Props), if it does not refer to a base type directly • the data type of an array or record element within an ImplementationDataType, if it does not refer to a base type directly • the data type of an SwServiceArg, if it does not refer to a base type directly <p>Tags:xml.sequenceOffset=215</p>
invalidValue	ValueSpecification	0..1	aggr	<p>Optional value to express invalidity of the actual data element.</p> <p>Tags:xml.sequenceOffset=255</p>





Class	<<atpVariation>> SwDataDefProps			
stepSize	Float	0..1	attr	This attribute can be used to define a value which is added to or subtracted from the value of a DataPrototype when using up/down keys while calibrating.
swAddrMethod	SwAddrMethod	0..1	ref	Addressing method related to this data object. Via an association to the same SwAddrMethod it can be specified that several DataPrototypes shall be located in the same memory without already specifying the memory section itself. Tags: xml.sequenceOffset=30
swAlignment	AlignmentType	0..1	attr	The attribute describes the intended alignment of the DataPrototype. If the attribute is not defined the alignment is determined by the swBaseType size and the memory AllocationKeywordPolicy of the referenced SwAddr Method. Tags: xml.sequenceOffset=33
swBit Representation	SwBitRepresentation	0..1	aggr	Description of the binary representation in case of a bit variable. Tags: xml.sequenceOffset=60
swCalibration Access	SwCalibrationAccess Enum	0..1	attr	Specifies the read or write access by MCD tools for this data object. Tags: xml.sequenceOffset=70
swCalprmAxis Set	SwCalprmAxisSet	0..1	aggr	This specifies the properties of the axes in case of a curve or map etc. This is mainly applicable to calibration parameters. Tags: xml.sequenceOffset=90
swComparison Variable	SwVariableRefProxy	*	aggr	Variables used for comparison in an MCD process. Tags: xml.sequenceOffset=170 xml.typeElement=false
swData Dependency	SwDataDependency	0..1	aggr	Describes how the value of the data object has to be calculated from the value of another data object (by the MCD system). Tags: xml.sequenceOffset=200
swHostVariable	SwVariableRefProxy	0..1	aggr	Contains a reference to a variable which serves as a host-variable for a bit variable. Only applicable to bit objects. Tags: xml.sequenceOffset=220 xml.typeElement=false
swImplPolicy	SwImplPolicyEnum	0..1	attr	Implementation policy for this data object. Tags: xml.sequenceOffset=230
swIntended Resolution	Numerical	0..1	attr	The purpose of this element is to describe the requested quantization of data objects early on in the design process. The resolution ultimately occurs via the conversion formula present (compuMethod), which specifies the transition from the physical world to the standardized





Class		<<atpVariation>> SwDataDefProps		
				<p>world (and vice-versa) (here, "the slope per bit" is present implicitly in the conversion formula).</p> <p>In the case of a development phase without a fixed conversion formula, a pre-specification can occur through swIntendedResolution.</p> <p>The resolution is specified in the physical domain according to the property "unit".</p> <p>Tags:xml.sequenceOffset=240</p>
swInterpolation Method	Identifier	0..1	attr	<p>This is a keyword identifying the mathematical method to be applied for interpolation. The keyword needs to be related to the interpolation routine which needs to be invoked.</p> <p>Tags:xml.sequenceOffset=250</p>
swIsVirtual	Boolean	0..1	attr	<p>This element distinguishes virtual objects. Virtual objects do not appear in the memory, their derivation is much more dependent on other objects and hence they shall have a swDataDependency .</p> <p>Tags:xml.sequenceOffset=260</p>
swPointerTarget Props	SwPointerTargetProps	0..1	aggr	<p>Specifies that the containing data object is a pointer to another data object.</p> <p>Tags:xml.sequenceOffset=280</p>
swRecord Layout	SwRecordLayout	0..1	ref	<p>Record layout for this data object.</p> <p>Tags:xml.sequenceOffset=290</p>
swRefresh Timing	MultidimensionalTime	0..1	aggr	<p>This element specifies the frequency in which the object involved shall be or is called or calculated. This timing can be collected from the task in which write access processes to the variable run. But this cannot be done by the MCD system.</p> <p>So this attribute can be used in an early phase to express the desired refresh timing and later on to specify the real refresh timing.</p> <p>Tags:xml.sequenceOffset=300</p>
swTextProps	SwTextProps	0..1	aggr	<p>the specific properties if the data object is a text object.</p> <p>Tags:xml.sequenceOffset=120</p>
swValueBlock Size	Numerical	0..1	attr	<p>This represents the size of a Value Block</p> <p>Stereotypes: atpVariation</p> <p>Tags: vh.latestBindingTime=preCompileTime xml.sequenceOffset=80</p>
swValueBlock SizeMult (ordered)	Numerical	*	attr	<p>This attribute is used to specify the dimensions of a value block (VAL_BLK) for the case that that value block has more than one dimension.</p> <p>The dimensions given in this attribute are ordered such that the first entry represents the first dimension, the second entry represents the second dimension, and so on.</p>





Class	<<atpVariation>> SwDataDefProps			
				<p style="text-align: center;">△</p> For one-dimensional value blocks the attribute swValueBlockSize shall be used and this attribute shall not exist. Stereotypes: atpVariation Tags: vh.latestBindingTime=preCompileTime
unit	Unit	0..1	ref	Physical unit associated with the semantics of this data object. This attribute applies if no compuMethod is specified. If both units (this as well as via compuMethod) are specified the units shall be compatible. Tags: xml.sequenceOffset=350
valueAxisDataType	ApplicationPrimitive DataType	0..1	ref	The referenced ApplicationPrimitiveDataType represents the primitive data type of the value axis within a compound primitive (e.g. curve, map). It supersedes CompuMethod, Unit, and BaseType. Tags: xml.sequenceOffset=355

Table 5.42: SwDataDefProps

Primitive	NativeDeclarationString
Package	M2::AUTOSARTemplates::GenericStructure::GeneralTemplateClasses::PrimitiveTypes
Note	This string contains a native data declaration of a data type in a programming language. It is basically a string, but white-space shall be preserved. Tags: xml.xsd.customType=NATIVE-DECLARATION-STRING xml.xsd.type=string xml.xsd.whiteSpace=preserve

Table 5.43: NativeDeclarationString

Class	SwBitRepresentation			
Package	M2::MSR::DataDictionary::DataDefProperties			
Note	Description of the structure of a bit variable: Comprises of the bitPosition in a memory object (e.g. swHostVariable, which stands parallel to swBitRepresentation) and the numberOfBits. In this way, interrelated memory areas can be described. Non-related memory areas are not supported.			
Base	ARObject			
Attribute	Type	Mult.	Kind	Note
bitPosition	Integer	0..1	attr	If the "bit data object" is hosted within another data object (e.g. if the memory can be accessed via byte as well as bit address), this attribute specifies the position of the data object. The count starts at zero (0). Tags: xml.sequenceOffset=20
numberOfBits	Integer	0..1	attr	Number of bits allocated by a "bit data object" within its host data object. Tags: xml.sequenceOffset=30

Table 5.44: SwBitRepresentation

Primitive	DisplayFormatString
Package	M2::AUTOSARTemplates::GenericStructure::GeneralTemplateClasses::PrimitiveTypes
Note	<p>This is a display format specifier for the display of values e.g. in documents or in measurement and calibration systems.</p> <p>The display format specifier is a subset of the ANSI C printf specifiers with the following form: % [flags] [width] [.prec] type character</p> <p>For more details refer to "ASAM-HarmonizedDataObjects-V1.1.pdf" chapter 13.3.2 DISPLAY OF DATA.</p> <p>Due to the numerical nature of value settings, only the following type characters are allowed:</p> <ul style="list-style-type: none"> • d: Signed decimal integer • i: Signed decimal integer • o: Unsigned octal integer • u: Unsigned decimal integer • x: Unsigned hexadecimal integer, using "abcdef" • X: Unsigned hexadecimal integer, using "ABCDEF" • e: Signed value having the form [-]d.dddd e [sign]ddd where d is a single decimal digit, dddd is one or more decimal digits, ddd is exactly three decimal digits, and sign is + or - • E: Identical to the e format except that E rather than e introduces the exponent • f: Signed value having the form [-]dddd.dddd, where dddd is one or more decimal digits; the number of digits before the decimal point depends on the magnitude of the number, and the number of digits after the decimal point depends on the requested precision • g: Signed value printed in f or e format, whichever is more compact for the given value and precision; trailing zeros are truncated, and the decimal point appears only if one or more digits follow it • G: Identical to the g format, except that E, rather than e, introduces the exponent (where appropriate) <p>Tags: xml.xsd.customType=DISPLAY-FORMAT-STRING xml.xsd.pattern=%[\-+#]?[0-9]*(\.[0-9])?[diouxXfeEgGcs] xml.xsd.type=string</p>

Table 5.45: DisplayFormatString

Class	Annotation			
Package	M2::MSR::Documentation::Annotation			
Note	This is a plain annotation which does not have further formal data.			
Base	ARObject, GeneralAnnotation			
Attribute	Type	Mult.	Kind	Note
-	-	-	-	-

Table 5.46: Annotation

[constr_1244] DataPrototypes used in application software shall not be typed by C enums [A [DataPrototype](#) that is used in an [AtomicSwComponentType](#) shall not set [swDataDefProps.additionalNativeTypeQualifier](#) to enum.]()

[TPS_SWCT_01272] Semantics of swComparisonVariable [Please note that [swComparisonVariables](#) shall be displayed in the MCD system on the ordinate in a curve.

By showing the input value and the comparison value the calibration engineer can see if the current working point is above or below a curve provident thresholds. For example,

in a curve specifying a temperature-depending gear shift threshold engine speed the engine speed can be shown as “comparisonVariable”.

These variables can be used to display the value of a variable on the value axis of a calibration parameter (characteristic), that is currently displayed in the MCD-System.

The purpose is to compare the appropriate result from the calibration parameter in question, with a value being calculated or taken from a sensor (the comparison variable).

The sole purpose of this comparison-variable is therefore to serve the calibration process.]()

The meaning behind `swComparisonVariable` is depicted in Figure 5.29. Legend: t_x represents the current temperature and t_{mot} represents the motor temperature.

V represents the current speed as shown in the MCD system for comparison: this is the `swComparisonVariable`.

Likewise, V_s represents the speed characteristic over the temperature.

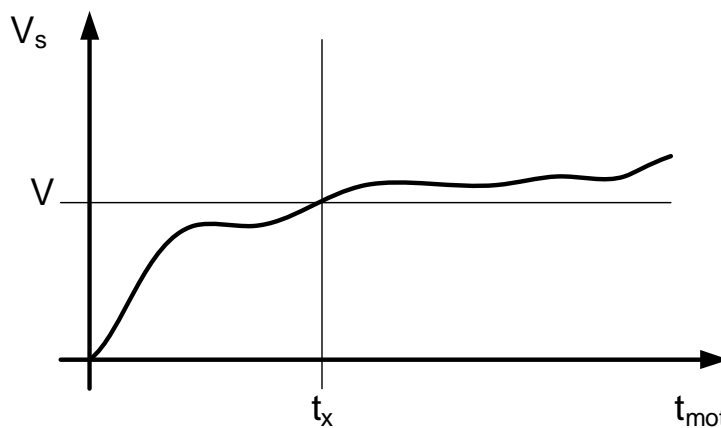

Figure 5.29: Explanation of `swComparisonVariable`

<i>Enumeration</i>	SwCalibrationAccessEnum
<i>Package</i>	M2::MSR::DataDictionary::DataDefProperties
<i>Note</i>	Determines the access rights to a data object w.r.t. measurement and calibration.
<i>Literal</i>	Description
notAccessible	The element will not be accessible via MCD tools, i.e. will not appear in the ASAP file. Tags: atp.EnumerationLiteralIndex=0
readOnly	The element will only appear as read-only in an ASAP file. Tags: atp.EnumerationLiteralIndex=1
readWrite	The element will appear in the ASAP file with both read and write access. Tags: atp.EnumerationLiteralIndex=2

Table 5.47: SwCalibrationAccessEnum

[TPS_SWCT_01273] Precedence rules for the application of `SwDataDefProps` [`SwDataDefProps` can be specified on various levels, from type over prototype to instantiation, finally data access and calibration support after RTE generation. In general, properties specified on prototype level override the ones specified on type level.

More formally, the precedence of such properties is:

1. attributes of `SwDataDefProps` defined on `ApplicationDataType` which may be overwritten by
2. attributes of `SwDataDefProps` defined on `ImplementationDataType` which may be overwritten by
3. attributes of `SwDataDefProps` defined on `DataPrototype` which may be overwritten by
4. attributes of `SwDataDefProps` defined on `InstantiationDataDefProps` which may be overwritten by
5. attributes of `SwDataDefProps` defined on `ParameterAccess` respectively `Argument` which may be overwritten by
6. attributes of `SwDataDefProps` defined on `FlatInstanceDescriptor` which may be overwritten by
7. attributes of `SwDataDefProps` defined on `McDataInstance`

]()

Note that details about applicable attributes of `SwDataDefProps` can be found in Table 5.41.

[TPS_SWCT_01274] `SwDataDefProps` used to support calibration and measurement [The last item in the list of use cases contained in [TPS_SWCT_01273] denotes that `SwDataDefProps` are also used as part of `McSupportData` which is a direct input to the generation of measurement and calibration configuration formats (so-called A2L-files).

This use case is further explained in [6]. Since these data are generated by the RTE, they will use a copy of the properties according to the precedence given above.

However, even in this use case which comes after RTE generation it is possible that properties relevant for the MCD system are added which had been undefined so far.

This for example, applies to the attribute `swRefreshTiming` which denotes a timing information relevant for the measurement system; this information may be set rather late in the process chain.]()

Obviously such an override is not applicable in all cases. In particular, the properties covering the structure shall not be redefined on `DataPrototype`. Implementation policy, semantics and code generation policy may be changed under consideration of compatibility rules.

Access policy for the MCD system is the most likely subject to be redefined on the [DataPrototype](#) of even on an instantiation level.

Section [5.4.3](#) describes how [SwDataDefProps](#) are used for measuring purposes while Section [5.4.4](#) describes the construction of characteristics based on the combination of [SwDataDefProps](#) with [DataPrototypes](#).

Section [2.2.2](#) describes in which context calibration parameters can be defined. Finally, sections [2.2.3](#), [7.5.4](#), and [5.5.4](#) show how calibration parameters are used in [RunnableEntity](#)s and show the link to an actual ECU implementation.

<i>Enumeration</i>	SwImplPolicyEnum
Package	M2::MSR::DataDictionary::DataDefProperties
Note	Specifies the implementation strategy with respect to consistency mechanisms of variables.
Literal	Description
const	forced implementation such that the running software within the ECU shall not modify it. For example implemented with the "const" modifier in C. This can be applied for parameters (not for those in NVRAM) as well as argument data prototypes. Tags: atp.EnumerationLiteralIndex=0
fixed	This data element is fixed. In particular this indicates, that it might also be implemented e.g. as in place data, (#DEFINE). Tags: atp.EnumerationLiteralIndex=1
measurementPoint	The data element is created for measurement purposes only. The data element is never read directly within the ECU software. In contrast to a "standard" data element in an unconnected provide port is, this unconnection is guaranteed for measurementPoint data elements. Tags: atp.EnumerationLiteralIndex=2
queued	The content of the data element is queued and the data element has 'event' semantics, i.e. data elements are stored in a queue and all data elements are processed in 'first in first out' order. The queuing is intended to be implemented by RTE Generator. This value is not applicable for parameters. Tags: atp.EnumerationLiteralIndex=3
standard	This is applicable for all kinds of data elements. For variable data prototypes the 'last is best' semantics applies. For parameter there is no specific implementation directive. Tags: atp.EnumerationLiteralIndex=4

Table 5.48: SwImplPolicyEnum

[TPS_SWCT_01275] values of the attribute [swImplPolicy](#) are restricted depending on the context [The values of the attribute [swImplPolicy](#) are restricted (summarized in table [5.49](#)) depending on the context. This restriction reflects the fact that not all possible implementation strategies are useful or supported for all kinds of [DataPrototypes](#).]()

The restrictions summarized in table [5.49](#) are formalized in a set of constraints below the table.

Please note that the usage of [swImplPolicy](#) is further constraint in the combination with the attribute value [swCalibrationAccess](#) as described in [[constr_1017](#)].

Attribute of SwImplPolicyEnum	VariableDataPrototype								ParameterDataPrototype					Misc.	
	VariableDataPrototype in SenderReceiverInterface	VariableDataPrototype in NvDataInterface	VariableDataPrototype in role ramBlock	VariableDataPrototype in role implicitInterRunnableVariable	VariableDataPrototype in role explicitInterRunnableVariable	VariableDataPrototype in role arTypedPerInstanceMemory	VariableDataPrototype in role staticMemory	ParameterDataPrototype in ParameterInterface	ParameterDataPrototype in role romBlock	ParameterDataPrototype in role sharedParameter	ParameterDataPrototype in role perInstanceParameter	ParameterDataPrototype in role constantMemory	ArgumentDataPrototype	SwServiceArg	
const	NA	NA	NA	NA	NA	NA	NA	x	NA	x	x	x	NA	x	
fixed	NA	NA	NA	NA	NA	NA	NA	x	NA	NA	NA	x	NA	NA	
measurementPoint	x	NA	NA	NA	NA	x	x	NA	NA	NA	NA	NA	NA	NA	
queued	x	NA	NA	NA	NA	NA	NA	NA	NA	NA	NA	NA	NA	NA	
standard	x	x	x	x	x	x	x	x	x	x	x	x	x	x	

Table 5.49: Allowed attributes values for swImplPolicy vs. DataPrototypes and their roles

The following settings apply in table 5.49:

x Attribute is applicable for usage in the scope of this element.

NA Attribute is **not** applicable for usage in the scope of this element.

[constr_2035] swImplPolicy for VariableDataPrototype in SenderReceiverInterface [The overriding swImplPolicy attribute value of a VariableDataPrototype in SenderReceiverInterface shall be standard, queued or measurementPoint.]()

[constr_2036] swImplPolicy for VariableDataPrototype in NvDataInterface [The overriding swImplPolicy attribute value of a VariableDataPrototype in NvDataInterface shall be standard.]()

[constr_2037] swImplPolicy for VariableDataPrototype in the role ramBlock [The overriding swImplPolicy attribute value of a VariableDataPrototype in the role ramBlock shall be standard.]()

[constr_2038] swImplPolicy for VariableDataPrototype in the role implicitInterRunnableVariable [The overriding swImplPolicy attribute value of a VariableDataPrototype in the role implicitInterRunnableVariable shall be standard.]()

[constr_2039] swImplPolicy for VariableDataPrototype in the role explicitInterRunnableVariable [The overriding swImplPolicy attribute value of a VariableDataPrototype in the role explicitInterRunnableVariable shall be standard.]()

[constr_2040] `swImplPolicy` for `VariableDataPrototype` in the role `arTypedPerInstanceMemory` [The overriding `swImplPolicy` attribute value of a `VariableDataPrototype` in the role `arTypedPerInstanceMemory` shall be `standard` or `measurementPoint`.]()

[constr_2041] `swImplPolicy` for `VariableDataPrototype` in the role `staticMemory` [The overriding `swImplPolicy` attribute value of a `VariableDataPrototype` in the role `staticMemory` shall be `standard` or `measurementPoint`.]()

[constr_2042] `swImplPolicy` for `ParameterDataPrototype` in `ParameterInterface` [The overriding `swImplPolicy` attribute value of a `ParameterDataPrototype` in `ParameterInterface` shall be `standard`, `const` or `fixed`.]()

[constr_2043] `swImplPolicy` for `ParameterDataPrototype` in the role `romBlock` [The overriding `swImplPolicy` attribute value of a `ParameterDataPrototype` in the role `romBlock` shall be `standard`.]()

[constr_2044] `swImplPolicy` for `ParameterDataPrototype` in the role `sharedParameter` [The overriding `swImplPolicy` attribute value of a `ParameterDataPrototype` in the role `sharedParameter` shall be `standard`, `const`.]()

[constr_2045] `swImplPolicy` for `ParameterDataPrototype` in the role `perInstanceParameter` [The overriding `swImplPolicy` attribute value of a `ParameterDataPrototype` in the role `perInstanceParameter` shall be `standard`, `const`.]()

[constr_2046] `swImplPolicy` for `ParameterDataPrototype` in the role `constantMemory` [The overriding `swImplPolicy` attribute value of a `ParameterDataPrototype` in the role `constantMemory` shall be `standard`, `const` or `fixed`.]()

[constr_2047] `swImplPolicy` for `ArgumentDataPrototype` [The overriding `swImplPolicy` attribute value of a `ArgumentDataPrototype` shall be `standard`.]()

[constr_2048] `swImplPolicy` for `SwServiceArg` [The overriding `swImplPolicy` attribute value of a `SwServiceArg` shall be `standard` or `const`.]()

[TPS_SWCT_02000] Default value for attribute `swImplPolicy` [If the attribute `swImplPolicy` is not explicitly set at any of the locations listed in “Place of Setting” for `SwDataDefProps` the default value `standard` applies.]()

Please note that the locations listed in “Place of Setting” for `SwDataDefProps` are described in Table 5.41.

5.4.2 Invalid Value

The diagram 5.5 shows that in addition to the semantics defined through the `compuMethod` (explained below in chapter 5.5.1), also an `invalidValue` can be specified. This is a requirement of the VFB [3], allowing expressing which specific value is used to indicate invalidation.

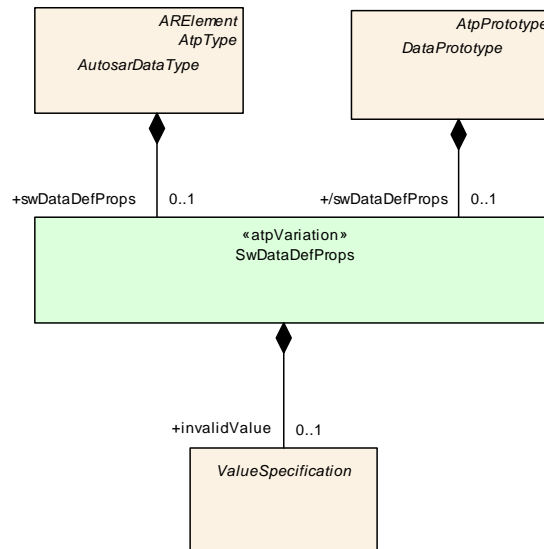

Figure 5.30: Invalid value

The `invalidValue` can be used in different flavors (also illustrated in Figure 5.6):

- **[TPS_SWCT_01432] Keep the `invalidValue` transparent to the sending and receiving software components** [On the one hand it is possible to keep the `invalidValue` transparent to the sending and receiving software components. In this case the invalidation API of the RTE on the sender side has to be used.

The receiving software component can either use the data receive status or the `DataReceiveErrorEvent` respectively `DataReceivedEvent` to decide about the validity of the received data or the receiving software component can rely on the reception of an `initValue` as a default value in case of data invalidation.

In this case the invalid value should (and usually will) be **outside the range limits** defined by the `compuMethod.()`

- **[TPS_SWCT_01434] Sender and receiver have knowledge of invalid value** [On the other hand it is possible that the communicating software components do have knowledge about the `invalidValue` and the `invalidValue` is visible for them.

This is in particular the case if the sender and receiver are calculating a checksum over a larger data structure to implement an end to end communication protection. To ensure the integrity of the checksums it is required to set invalid values by the sending component directly and to receive invalid values unchanged.

In this case the invalid value should (and usually will) be **inside the range limits** defined by the `compuMethod.>()`

- **[TPS_SWCT_01436] Different receivers require different handling of data invalidation** [It is possible that in case of 1:n communication different receivers requiring a different handling of data invalidation depending on the criticality of its functionality. For instance, one receiver applies the checksum based end to end communication protection and another receiver relies on the substitution of invalid values by `invalidValues.>()`

A typical use case for putting the `invalidValue` inside the boundaries of the applicable `CompuMethod` is a composite data type that contains the values of all individual wheel speeds. If one of the sensors fails and starts to send `invalidValue` it would probably not make sense to consider the whole composite data element invalid.

It may very likely still be possible to make sense of the remaining intact wheel speed values and carry on with whatever business the receiving software-component has with that data.

From this perspective, it would obviously be OK for the sending software-component to actively send the `invalidValue` that is then processed as a “regular” value without applying additional semantics by the RTE/Com.

[TPS_SWCT_01646] Sending `invalidValue` without invalidation applied by RTE/Com [For intentionally sending `invalidValue` without invalidation applied by RTE/Com the `SenderReceiverInterface.invalidationPolicy.handleInvalid` shall be set to the value `HandleInvalidEnum.dontInvalidate.>()`

[constr_1390] Restriction to the value of `SenderReceiverInterface.invalidationPolicy.handleInvalid` [If the value of `SenderReceiverInterface.invalidationPolicy.handleInvalid` is set to any value other than `HandleInvalidEnum.dontInvalidate` then the `invalidValue` shall not be within the interval defined by the `CompuMethod` of the applicable `dataElement.>()`

Please note that `ApplicationPrimitiveDataTypes` of category `VALUE` in principle can have an `invalidValue` provided by a `NumericalValueSpecification` because the value of the attribute `invalidValue` can be **outside the range** of the applicable `CompuMethod` (see [\[TPS_SWCT_01432\]](#)).

[TPS_SWCT_01437] `invalidValue` can also be specified without setting a `compuMethod` [An `invalidValue` can also be specified without setting a `compuMethod.>()`

Figure 5.6 illustrates the relationship between `ApplicationDataType`, `CompuMethod`, `ImplementationDataType`, `invalidValue`, `BaseType`.

[constr_2545] `invalidValue` shall fit in the specified ranges [The `invalidValue` shall be in the range of the `ImplementationDataType.>()`

Please note that the `invalidValue` is a `ValueSpecification`. Of course, it would technically be possible to use any subclass of `ValueSpecification` at this place.

[constr_1016] Restriction of `invalidValue` for `ImplementationDataType` and `ImplementationDataTypeElement` [`invalidValue` for `ImplementationDataType` and `ImplementationDataTypeElement` is restricted to be either a compatible `NumericalValueSpecification`, `TextValueSpecification` (caution, **[constr_1284]** applies) or a `ConstantReference` that in turn points to a compatible `ValueSpecification`.]()

[constr_1384] Definition of `invalidValue` for `DataPrototype` typed by `ApplicationPrimitiveDataType` of category `CURVE`, `MAP`, `CUBOID`, `CUBE_4`, `CUBE_5`, `COM_AXIS`, `RES_AXIS`, and `VAL_BLK` [An `invalidValue` shall not be specified for a `DataPrototype` typed by `ApplicationPrimitiveDataType` of category `CURVE`, `MAP`, `CUBOID`, `CUBE_4`, `CUBE_5`, `COM_AXIS`, `RES_AXIS`, and `VAL_BLK`]()

Rationale for **[constr_1384]**: there is no use case for sending a `DataPrototype` typed by `ApplicationPrimitiveDataType` of category `CURVE`, `MAP`, `CUBOID`, `CUBE_4`, `CUBE_5`, `COM_AXIS`, `RES_AXIS`, and `VAL_BLK` over a communication bus.

[constr_1242] Restriction of `invalidValue` for `ApplicationPrimitiveDataType` of category `STRING` [`invalidValue` for `ApplicationPrimitiveDataType` of category `STRING` (**[constr_1241]** applies) is restricted to be either a compatible `ApplicationValueSpecification` or a `ConstantReference` that in turn points to a compatible `ApplicationValueSpecification`.]()

[TPS_SWCT_01487] Correspondence of `invalidValue` for `ApplicationPrimitiveDataType` and `ImplementationDataType` [The `invalidValue` specified on the level of an `ApplicationPrimitiveDataType` shall correspond to the `invalidValue` specified on the level of a compatible `ImplementationDataType`. The terms “corresponds” boils down to:

- category `VALUE` or `BOOLEAN`: application of `CompuMethod`
- category `STRING`: mapping of the encoding on the `ApplicationPrimitiveDataType` side to the numerical values on the level of the `ImplementationDataType` (shall reference `SwBaseType` with `baseTypeEncoding` set to `NONE`). There is no formal support defined to check that the values of `invalidValue` really correspond to each other.

]()

[constr_1225] `DataPrototype` is typed by an `ImplementationDataType` that references a `CompuMethod` of category `TEXTTABLE` or `BITFIELD_TEXTTABLE` [If a `DataPrototype` is typed by an `ImplementationDataType` that references a `CompuMethod` of category `TEXTTABLE` or `BITFIELD_TEXTTABLE` the applicable `ValueSpecification` shall be a `TextValueSpecification`.

In this case the value provided shall match to one of the applicable text values (`vt`, `shortLabel`, `symbol`) defined by the applicable `CompuScales`.]()

Please note that several attributes of meta-class `CompuScale` can be taken to describe the actual value. It is therefore necessary to clarify what happens if several of these

attributes exist within the context of one `CompuScale`. This clarification can be found in [TPS_SWCT_01696].

[TPS_SWCT_01467] ImplementationDataType references an SwBaseType with a string encoding [If an `ImplementationDataType` references an `SwBaseType` with a string encoding the `initValue` shall still be provided as numerical values according to the string encoding.]()

[constr_1302] Restriction of data invalidation [Data invalidation is only applicable for one of the following cases applicable on the **receiving** side:

1. `VariableDataPrototypes` typed by either an `ApplicationPrimitiveDataType` or an `ImplementationDataType` of category `VALUE` or `TYPE_REFERENCE` that boils down to category `VALUE` that have defined an `invalidValue`.
2. `VariableDataPrototypes` typed by either an `ApplicationCompositeDataType` or an `ImplementationDataType` of category `STRUCTURE`, or `ARRAY` or of category `TYPE_REFERENCE` that boils down to category `STRUCTURE`, or `ARRAY` that have **at least one** primitive element with an `invalidValue`.

]()

Please note that [constr_1302], in general, leaves room for the definition of an invalid value for a `DataPrototype` typed by a `Wrapped Union Data Type` because it demands the existence of a primitive element that has an `invalidValue`. In the case of a `Wrapped Union Data Type`, the primitive element could be the `Member Selector`, and thus [constr_1302] would technically be fulfilled.

On the one hand, it does not make sense to just define an invalid value for the `Member Selector` from the semantic point of view. On the other hand, the actual payload may not even have an invalid value according to [constr_1009] or [constr_1288], respectively.

In order to simplify the situation and make a clear statement, [constr_1446] has been defined.

[constr_1446] No definition of invalidValue for a Wrapped Union Data Type [The definition of an `invalidValue` for a `DataPrototype` typed by a `Wrapped Union Data Type` is not supported.]()

[constr_1140] Combination of invalidValue with the attribute handleInvalid [The combination of setting the attribute `handleInvalid` of the meta-class `InvalidationPolicy` owned by `SenderReceiverInterface` to value `replace` **and** of setting the value of the attribute `initValue` owned by a corresponding `NonqueuedReceiverComSpec` effectively to the value of the `invalidValue` (owned by a corresponding `SwDataDefProps`) is not supported.]()

The term “corresponding” (as utilized in [constr_1140]) refers to the fact that information regarding the fulfillment of [constr_1140] is factually distributed over different areas of the meta-model. For clarification, the following relationship should be considered:

The `SenderReceiverInterface` defines how to deal with an invalid value by means of the attribute `handleInvalid` on the basis of individual `dataElements`. The `SenderReceiverInterface` is taken for typing a `RPortPrototype` that in turn owns a `ReceiverComSpec`. `[constr_1140]` applies if the particular `ReceiverComSpec` is actually a `NonqueuedReceiverComSpec` that refers to the same `dataElement`.

In this case the `invalidValue` owned by the `SwDataDefProps` that in turn is owned by the respective `dataElement` is relevant for the fulfillment of `[constr_1140]`. The “big picture” of this relationship is sketched in Figure 5.31.

[constr_1219] Invalidation depends on the value of `swImplPolicy` [Invalidation of `dataElements` is only supported for `dataElements` where the value of `swImplPolicy` is **not** set to `queued`.]()

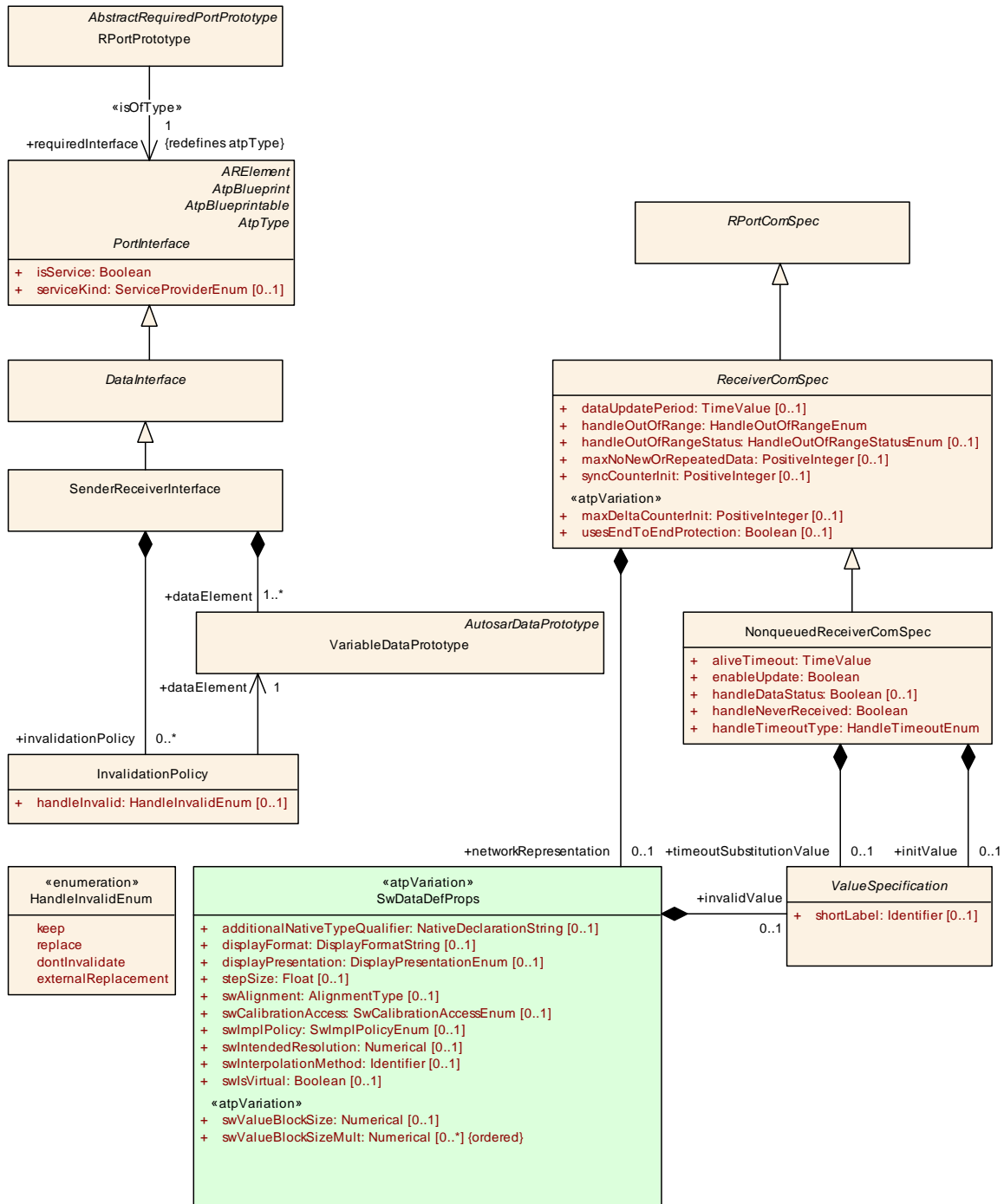

Figure 5.31: Relationships required to consider the `invalidValue`

[constr_1282] Restriction concerning the usage of `RuleBasedValueSpecification` or a `ReferenceValueSpecification` for the specification of an `invalidValue` [The aggregation of a `RuleBasedValueSpecification` or a `ReferenceValueSpecification` for the definition of a `ApplicationPrimitive-DataType.swDataDefProps.invalidValue` is not supported.]()

5.4.3 Properties for Measurement

In embedded automotive software design, measurement means access to memory locations in an ECU and transferring its contents to the measurement & calibration system. While in classical software design, variables abstract the memory locations in the code, AUTOSAR provides for this purpose the `DataPrototype` with its various specializations:

- `VariableDataPrototype` of a `SenderReceiverInterface` or `NvDataInterface` used in a `PortPrototype` (of a `SwComponentPrototype`), to capture sender-receiver and non-volatile data communication between `SwComponentPrototypes`
- `ArgumentDataPrototype` of a `ClientServerOperation` in a `ClientServerInterface` to capture client-server communication between `SwComponentPrototypes`.
- `VariableDataPrototype` in the context of an `SwcInternalBehavior` to
 - capture communication between `RunnableEntities` within a `SwComponentPrototype`
 - handle data in a non-volatile memory block
 - provide pure software component internal memory which has to be accessible for an MCD system

[TPS_SWCT_01440] Measurement is not limited to primitive objects [The ability of being measured is not restricted to primitive data (`category VALUE`) but can also be applied to composite data (`category STRUCTURE` or `ARRAY`).]()

The following semantical and structural features from `SwDataDefProps` are relevant (among other purposes) for the measurement system:

- `swCalibrationAccess`
- `swImplPolicy`
- `compuMethod`
- `unit` (if not specified by `compuMethod`)
- `baseType`
- `swAddrMethod`

[TPS_SWCT_01130] Measurement and calibration access to model elements is defined by `swCalibrationAccess` [The ability to be accessed by e.g. a calibration tool is given by setting the `swCalibrationAccess` attribute.]([RS_SWCT_03152](#))

The following table shows all valid settings of `swCalibrationAccess`:

[TPS_SWCT_01559] Default value for attribute `SwDataDefProps.swCalibrationAccess` [The default value for the attribute `SwDataDefProps.swCalibrationAccess` is `SwCalibrationAccessEnum.notAccessible`.]()

[constr_1017] Supported combinations of `swImplPolicy` and `swCalibrationAccess` [The table 5.50 defines the supported combinations of `swImplPolicy` and `swCalibrationAccess` attribute setting.]()

<code>swImplPolicy</code>	<code>swCalibrationAccess</code>		
	<code>notAccessible</code>	<code>readOnly</code>	<code>readWrite</code>
<code>fixed</code>	yes	not supported	not supported
<code>const</code>	yes	yes	not supported
<code>standard</code>	yes	yes	yes
<code>queued</code>	yes	not supported	not supported
<code>measurementPoint</code>	not supported	yes	not supported

Table 5.50: Supported combinations of `swImplPolicy` and `swCalibrationAccess`

[constr_1018] `measurementPoint` shall not be referenced by a `VariableAccess` aggregated by `RunnableEntity` in the role `dataReadAccess` [Due to the nature of `dataElements` characterized by setting the `swImplPolicy` to `measurementPoint`, such `dataElements` shall not be referenced by a `VariableAccess` aggregated by `RunnableEntity` in the role `dataReadAccess`.]()

5.4.4 Properties of Curves and Maps

A characteristic table is defined by setting the `category` of the corresponding `AutosarDataType` or `DataPrototype` to `CURVE` respectively `MAP`, `CUBOID`, `CUBE_4`, and `CUBE_5`.

Its `SwDataDefProps` determine an axis description. The type of the functional values is given by the attached `SwBaseType` and the `CompuMethod`.

The axis description itself is defined by the meta-model element `SwCalprmAxisSet` aggregating the appropriate number of `SwCalprmAxisTypeProps`.

This is the base class for a so called “individual axis” (formalized by meta-class `SwAxisIndividual`) or a “grouped axis” (formalized by meta-class `SwAxisGrouped`).

The latter is used to share axis points by several characteristic tables. Figure 5.32 shows an overview on the relevant meta-model elements.

The type of the functional values is given by the attached `SwBaseType` and the `CompuMethod` or by the referenced `ApplicationDataType`.

If an `ApplicationDataType` is referenced (via `valueAxisDataType`) this supersedes `CompuMethod`, `Unit`, and `BaseType` if these are defined in parallel.

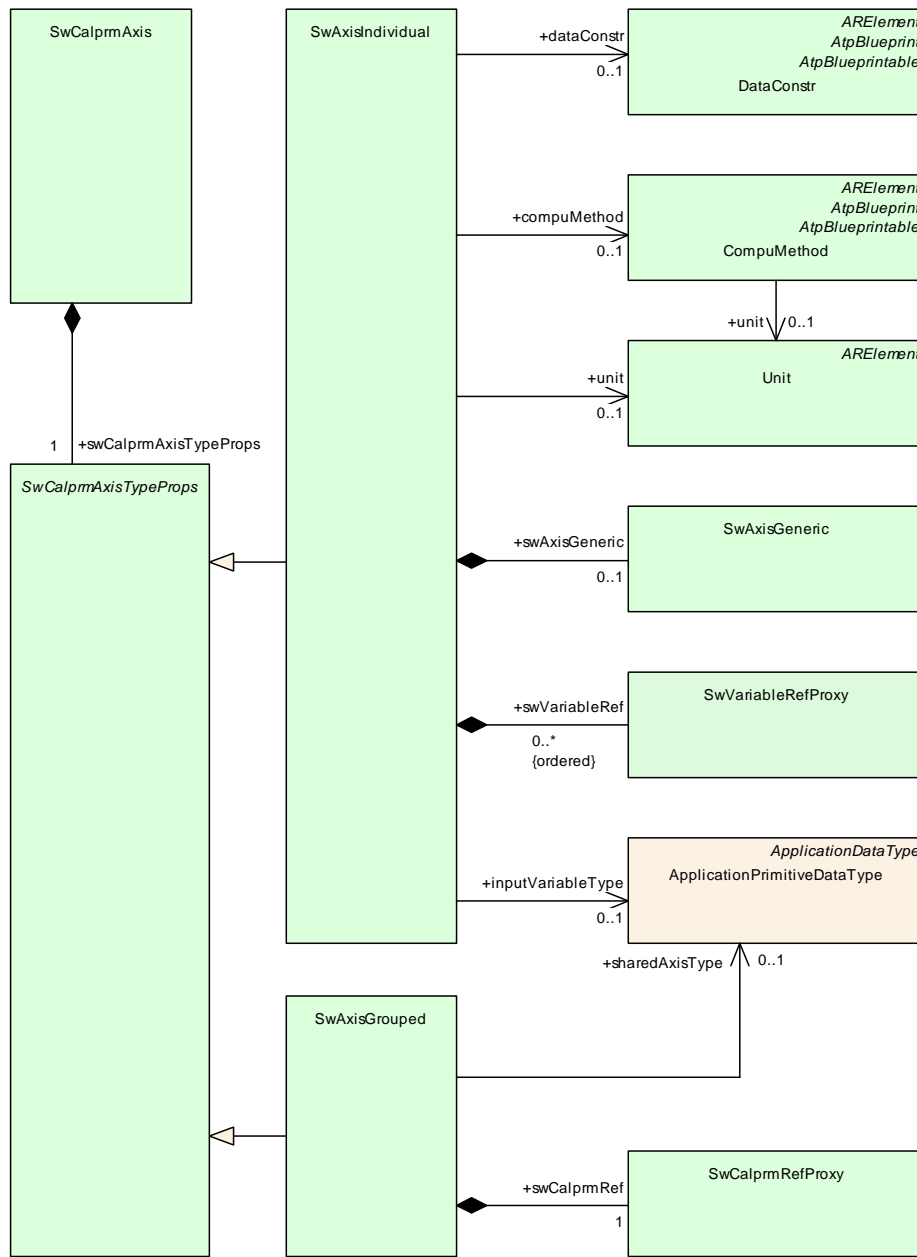

Figure 5.32: Overview on the Meta-Model for Axis Description

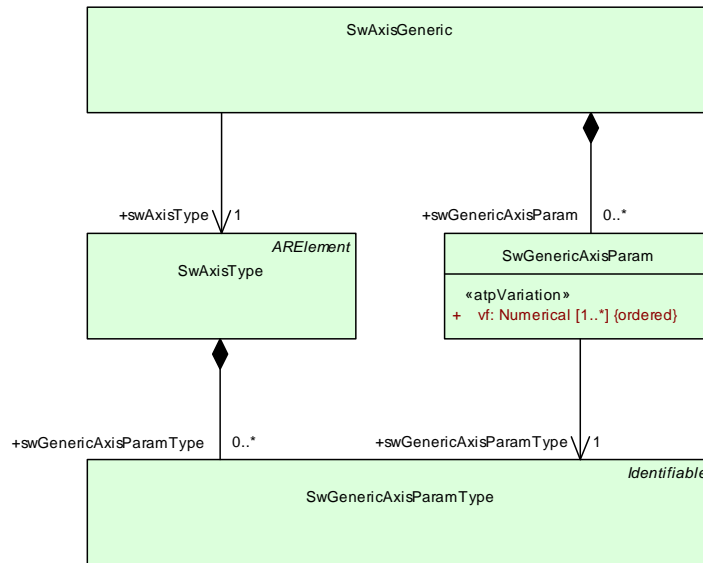

Figure 5.33: Overview on a Generic Axis

Figure 5.34 shows how an individual axis is represented by the meta-model. The corresponding M1 Model is illustrated in Figure 5.35. The `SwAxisIndividual` references value-models to account the minimum and the maximum number of axis values as well as the number of axis points.

Hence, the size of the structure to hold the functional values is determined by the number of axis values for all axes. The type of the axis values is determined when the type of the referenced input value (`swVariableRef`) has been set. For further details see 5.4.5.

[TPS_SWCT_01107] `swMinAxisPoints` and `swMaxAxisPoints` represent variation points [The value of attributes `swMinAxisPoints` and `swMaxAxisPoints` is subject to variant handling.] (*RS_SWCT_03148*)

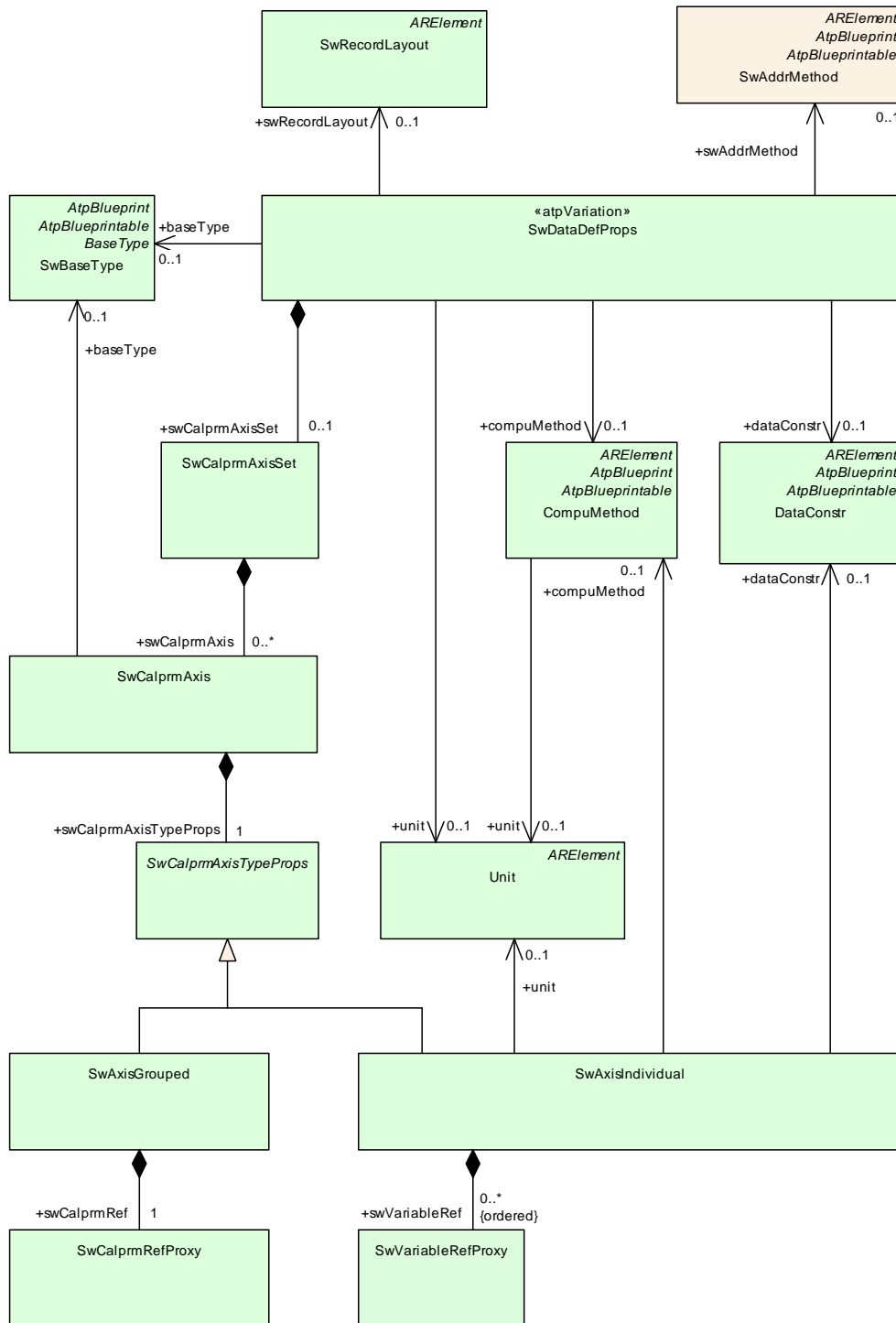

Figure 5.34: Meta-Model Elements used for a Curve

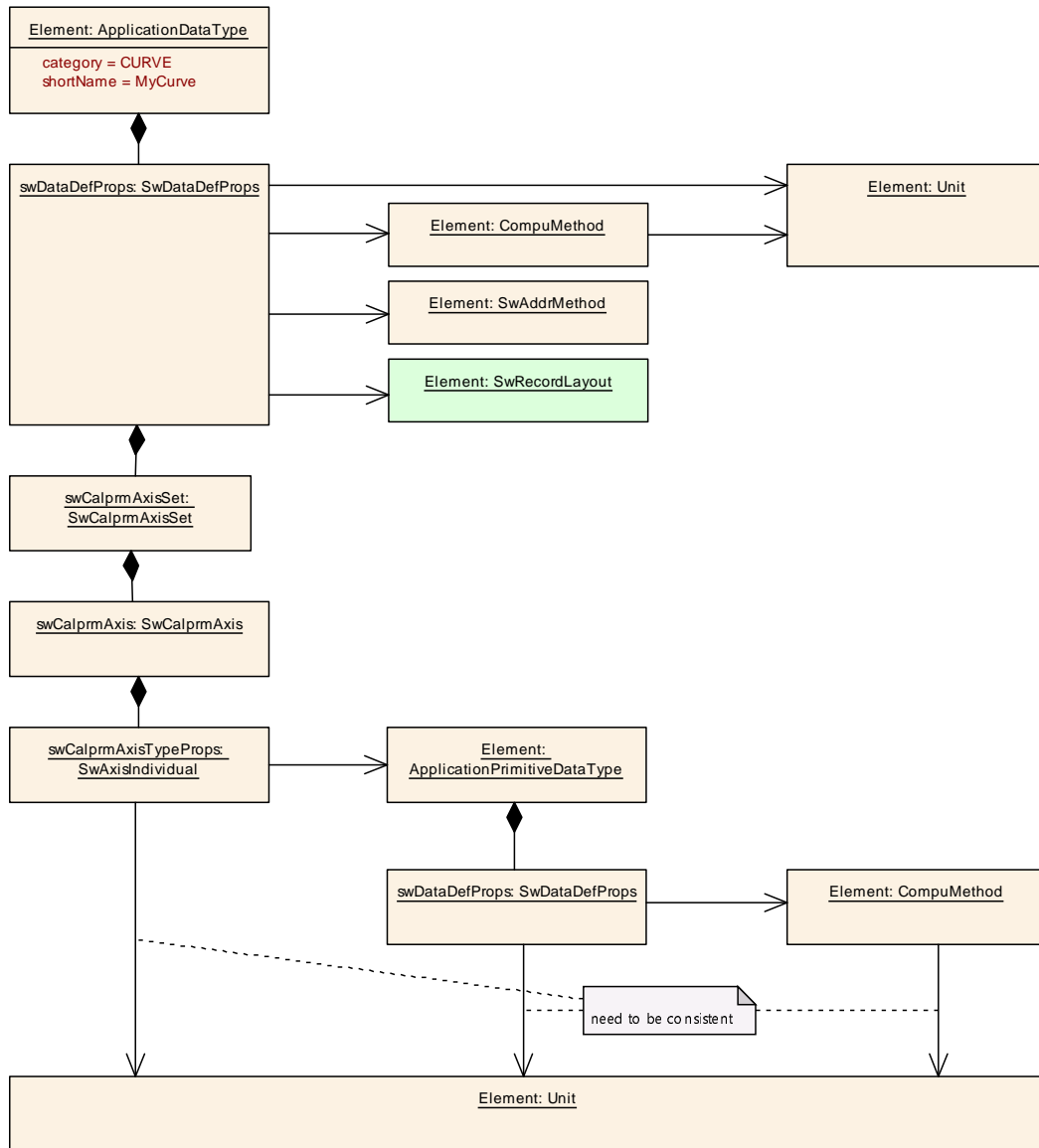

Figure 5.35: Illustration of a Curve in M1

Class	SwCalprmAxisSet			
Package	M2::MSR::DataDictionary::CalibrationParameter			
Note	This element specifies the input parameter axes (abscissas) of parameters (and variables, if these are used adaptively).			
Base	ARObject			
Attribute	Type	Mult.	Kind	Note





Class	SwCalprmAxisSet			
swCalprmAxis	SwCalprmAxis	*	aggr	<p>One axis belonging to this SwCalprmAxisSet</p> <p>Tags: xml.roleElement=true xml.roleWrapperElement=false xml.sequenceOffset=20 xml.typeElement=false xml.typeWrapperElement=false</p>

Table 5.51: SwCalprmAxisSet

Class	SwCalprmAxis			
Package	M2::MSR::DataDictionary::CalibrationParameter			
Note	This element specifies an individual input parameter axis (abscissa).			
Base	<i>ARObject</i>			
Attribute	Type	Mult.	Kind	Note
baseType	SwBaseType	0..1	ref	<p>The SwBaseType to be used for the axis. Note that this is not applicable for ApplicationDataTypes. The value shall be ignored.</p> <p>Tags: atp.Status=removed xml.sequenceOffset=110</p>
category	CalprmAxisCategory Enum	0..1	attr	<p>This property specifies the category of a particular axis.</p> <p>Tags:xml.sequenceOffset=30</p>
displayFormat	DisplayFormatString	0..1	attr	<p>This property specifies how the axis values shall be displayed e.g. in documents or in measurement and calibration tools.</p> <p>Tags:xml.sequenceOffset=100</p>
swAxisIndex	AxisIndexType	0..1	attr	<p>This attribute specifies which axis is specified by the containing SwCalprmAxis.</p> <p>For example in a curve this is usually "1". In a map this is "1" or "2".</p> <p>Tags:xml.sequenceOffset=20</p>
swCalibration Access	SwCalibrationAccess Enum	0..1	attr	<p>Describes the applicability of parameters and variables.</p> <p>Tags:xml.sequenceOffset=90</p>
swCalprmAxis TypeProps	SwCalprmAxisType Props	1	aggr	<p>specific properties depending on the type of the axis.</p> <p>Tags: xml.roleElement=false xml.roleWrapperElement=false xml.sequenceOffset=40 xml.typeElement=true xml.typeWrapperElement=false</p>

Table 5.52: SwCalprmAxis

Enumeration	CalprmAxisCategoryEnum
Package	M2::MSR::DataDictionary::CalibrationParameter
Note	This enum specifies the possible values of the category property within SwCalprmAxis.
Literal	Description
comAxis	COM_AXIS is equal to an STD_AXIS, the difference is, that a COM_AXIS is an shared axis, that means this axis can be used multiple times by different CURVEs, MAPs, CUBOIDs, CUBE_4s, and CUBE_5s. Tags: atp.EnumerationLiteralIndex=0 xml.name=COM_AXIS
fixAxis	FIX_AXIS means that the input axis is not stored. The axis is calculated using parameters and so on it is also not possible to modify the axis points. Tags: atp.EnumerationLiteralIndex=4 xml.name=FIX_AXIS
resAxis	RES_AXIS is also an shared axis like COM_AXIS, the difference is that this kind of axis can be used for rescaling. Tags: atp.EnumerationLiteralIndex=6 xml.name=RES_AXIS
stdAxis	STD_AXIS means that input and output axis definition are stored within this CURVE, MAP, CUBOID, CUBE_4, and CUBE_5. There is no shared or calculated axis. Tags: atp.EnumerationLiteralIndex=8 xml.name=STD_AXIS

Table 5.53: CalprmAxisCategoryEnum

Class	SwCalprmAxisTypeProps (abstract)			
Package	M2::MSR::DataDictionary::CalibrationParameter			
Note	Base class for the type of the calibration axis. This provides the particular model of the specialization. If the specialization would be the directly from SwCalPrmAxis, the sequence of common properties and the specializes ones would be different.			
Base	<i>ARObject</i>			
Subclasses	SwAxisGrouped , SwAxisIndividual			
Attribute	Type	Mult.	Kind	Note
maxGradient	Float	0..1	attr	This attribute defines the maximum permissible gradient for an adjustable object (curve, map or cuboid) with respect to a specific axis. MaxGrad = maximum(absolute((Value i,k - Value i-1,k)/(Axis Point i - Axis Point i-1)))
monotony	MonotonyEnum	0..1	attr	This attribute specifies the monotony constraint for an adjustable object (curve, map or cuboid) with respect to a specific axis. This information can be used by MCD system to verify whether the monotony constraint is fulfilled and to prevent from changes violating the constraint.

Table 5.54: SwCalprmAxisTypeProps

Class	SwAxisIndividual			
Package	M2::MSR::DataDictionary::Axis			
Note	This meta-class describes an axis integrated into a parameter (field etc.). The integration makes this individual to each parameter. The so-called grouped axis represents the counterpart to this. It is conceived as an independent parameter (see class SwAxisGrouped).			
Base	ARObject, SwCalprmAxisTypeProps			
Attribute	Type	Mult.	Kind	Note
compuMethod	CompuMethod	0..1	ref	This is the compuMethod which is expected for the axis. It is used in early stages if the particular input-value is not yet available. Tags: xml.sequenceOffset=30
dataConstr	DataConstr	0..1	ref	Refers to constraints, e.g. for plausibility checks. Tags: xml.sequenceOffset=80
inputVariable Type	ApplicationPrimitive DataType	0..1	ref	This is the datatype of the input value for the axis. This allows to define e.g. a type of curve, where the input value is finalized at the access point.
swAxisGeneric	SwAxisGeneric	0..1	aggr	this specifies the properties of a generic axis if applicable. Tags: xml.sequenceOffset=90
swMaxAxis Points	Integer	1	attr	Maximum number of base points contained in the axis of a map or curve. Stereotypes: atpVariation Tags: vh.latestBindingTime=preCompileTime xml.sequenceOffset=60
swMinAxis Points	Integer	1	attr	Minimum number of base points contained in the axis of a map or curve. Stereotypes: atpVariation Tags: vh.latestBindingTime=preCompileTime xml.sequenceOffset=70
swVariableRef (ordered)	SwVariableRefProxy	*	aggr	Refers to input variables of the axis. It is possible to specify more than one variable. Here the following is valid: <ul style="list-style-type: none"> The variable with the highest priority shall be given first. It is used in the generation of the code and is also displayed first in the application system. All variables referenced shall be of the same physical nature. This is usually detected in that the conversion formulae affected refer back to the same SI-units. <p>In AUTOSAR this ensured by the constraint, that the referenced input variables shall use a type compatible to "inputVariableType".</p> <ul style="list-style-type: none"> This multiple referencing allows a base point distribution for more than one input variable to be used. One example of this are the temperature curves which can depend both on the induction air temperature and the engine temperature. <p>These variables can be displayed simultaneously by MCD systems (adjustment systems), enabling operating points to be shown in the curves.</p>





Class	SwAxisIndividual			
				<p style="text-align: right;">△</p> Tags: xml.roleElement=false xml.roleWrapperElement=true xml.sequenceOffset=20 xml.typeElement=false xml.typeWrapperElement=false
unit	Unit	0..1	ref	This represents the physical unit of the input value of the axis. It is provided to support the case that the particular input variable is not yet known. Tags: xml.sequenceOffset=40

Table 5.55: SwAxisIndividual

Class	SwAxisGeneric			
Package	M2::MSR::DataDictionary::Axis			
Note	This meta-class defines a generic axis. In a generic axis the axispoints points are calculated in the ECU. The ECU is equipped with a fixed calculation algorithm. Parameters for the algorithm can be stored in the data component of the ECU. Therefore these parameters are specified in the data declaration, not in the calibration data.			
Base	<i>ARObject</i>			
Attribute	Type	Mult.	Kind	Note
swAxisType	SwAxisType	1	ref	Associated axis calculation strategy. Tags: xml.sequenceOffset=20
swGenericAxisParam	SwGenericAxisParam	*	aggr	Specific parameter of a generic axis. Tags: xml.roleElement=true xml.roleWrapperElement=true xml.sequenceOffset=40 xml.typeElement=false xml.typeWrapperElement=false

Table 5.56: SwAxisGeneric

Class	SwAxisType			
Package	M2::MSR::DataDictionary::Axis			
Note	This meta-class represents a specific axis calculation strategy. No formal specification is given, due to the fact that it is possible to use arbitrary algorithms for calculating axis-points. Instead, the algorithm is described verbally but the parameters are specified formally with respect to their names and constraints. As a result, SwAxisType mainly reserves appropriate keywords. Tags: atp.recommendedPackage=SwAxisTypes			
Base	<i>ARElement, ARObject, CollectableElement, Identifiable, MultilanguageReferrable, PackageableElement, Referrable</i>			
Attribute	Type	Mult.	Kind	Note
swGenericAxisDesc	DocumentationBlock	0..1	aggr	Associated axis description in textual form. Tags: xml.sequenceOffset=20





Class	SwAxisType			
swGenericAxisParamType	SwGenericAxisParamType	*	aggr	Parameters for this calculation algorithm. Tags: xml.roleElement=true xml.roleWrapperElement=true xml.sequenceOffset=30 xml.typeElement=false xml.typeWrapperElement=false

Table 5.57: SwAxisType

Class	SwGenericAxisParam			
Package	M2::MSR::DataDictionary::Axis			
Note	This meta-class describes a specific parameter of a generic axis. The name of the parameter is defined through a reference to a parameter type defined on a corresponding axis type. The value of the parameter is given here in case that it is not changeable during calibration. Example is shift / offset in a fixed axis.			
Base	<i>ARObject</i>			
Attribute	Type	Mult.	Kind	Note
swGenericAxisParamType	SwGenericAxisParamType	1	ref	Parameter type defined on a corresponding axis type. References can only be made to axis parameters types which are defined within the referenced axis type. Tags: xml.sequenceOffset=20
vf (ordered)	Numerical	1..*	attr	This attribute represents the value of the generic axis parameter. Stereotypes: atpVariation Tags: vh.latestBindingTime=preCompileTime xml.roleElement=true xml.roleWrapperElement=false xml.sequenceOffset=30 xml.typeElement=false

Table 5.58: SwGenericAxisParam

Class	SwGenericAxisParamType			
Package	M2::MSR::DataDictionary::Axis			
Note	This meta-class describes a generic axis parameter type, namely: <ul style="list-style-type: none"> • Plausibility checks can be specified via dataConstr. • Textual description (desc), as a formal description is not of any use, due to the large variety of possibilities. • If this parameter contains structures, these can be simulated through the recursive use of SwGenericAxisParamTypes. 			
Base	<i>ARObject</i> , <i>Identifiable</i> , <i>MultilanguageReferrable</i> , <i>Referrable</i>			
Attribute	Type	Mult.	Kind	Note
dataConstr	DataConstr	0..1	ref	This reference denoted data constraints applicable to the generic axis parameter. Tags: xml.sequenceOffset=20

Table 5.59: SwGenericAxisParamType

Class	SwAxisGrouped			
Package	M2::MSR::DataDictionary::Axis			
Note	An SwAxisGrouped is an axis which is shared between multiple calibration parameters.			
Base	ARObject, SwCalprmAxisTypeProps			
Attribute	Type	Mult.	Kind	Note
sharedAxisType	ApplicationPrimitive DataType	0..1	ref	This is the datatype of the calibration parameter providing the shared axis.
swAxisIndex	AxisIndexType	0..1	attr	Describes which axis of the referenced calibration parameter provides the values for the group axis. The index satisfies the following convention: <ul style="list-style-type: none"> • 0 = value axis. in this case, the interpolation result of the referenced parameter is used as a base point index. • The index should only be specified if the parameter under swCalprm contains more than one axis. It is standard practice for the axis index of parameters with more than one axis, to be set to 1, if data has not been assigned to swAxisIndex. Tags: xml.sequenceOffset=20
swCalprmRef	SwCalprmRefProxy	1	aggr	This property specifies the calibration parameter which serves as the input axis. In AUTOSAR, the type of the referenced Calibration parameter shall be compatible to the type specified by sharedAxisType. Tags: xml.roleElement=false xml.roleWrapperElement=false xml.sequenceOffset=30 xml.typeElement=false xml.typeWrapperElement=false

Table 5.60: SwAxisGrouped

5.4.4.1 Specification of fix Axes

In most cases the axes of a curve or map are accessible to a calibration software and it is possible to calibrate axes points and their corresponding values.

There are cases, however, where axes are intentionally declared as fix and where no intention exists to change the properties of the axis ever¹⁸.

These axes are also known as fix axes. The support for the creation of fix axes in the meta-model is based upon the usage of SwAxisGeneric as depicted in Figure 5.33.

[TPS_SWCT_01747] Value of category for fix axis [A fix axis shall be modeled as an SwCalprmAxis with attribute category set to the value FIX_AXIS.] ()

[TPS_SWCT_01748] Sub-categories of fix axes [There are different sub-categories of fix axes:

¹⁸Typically, a calibration software does not have the ability to manipulate (or even inspect) the axis' properties by inspecting the ECU's memory.

- Fix axis where the distance between axis points can be computed according to a standardized algorithm.

In this case, fix axes of arbitrary length can be described by feeding three arguments defined in the context of the axis description into the axis algorithm.

Consequently, the memory footprint of different fix axis of this `category` is literally identical, independently of the number of axis points.

The following variations exist:

- **Subcategory PAR**, i.e. `category = FIX_AXIS_PAR`: the axis is created out of a *starting value* and a *shift* that creates further axis points as using a power-of-two algorithm. The details can be found in [24].
- **Subcategory PAR_DIST**, i.e. `category = FIX_AXIS_PAR_DIST`: the axis is created out of a *starting value* and an *offset* that adds further axis points with the distance given by offset. The details can be found in [24].
- Fix axis where the axis points are defined as a list of values directly in the axis definition. This variety boils down to
 - **Subcategory PAR_LIST**, i.e. `category = FIX_AXIS_PAR_LIST`: the axis is created out of a list of numerical values that represent the axis points. The details can be found in [24].

These values of `category` shall be used for `SwAxisType.()`

As mentioned before, the modeling of a fix axis is based upon the definition of the `SwAxisGeneric`. But this statement by itself is not yet sufficient to unambiguously clarify the details of the modeling.

For this purpose, it is necessary to provide further information about the specifics of the roles `SwAxisGeneric.swAxisType` and `SwAxisGeneric.swGenericAxisParam`.

[TPS_SWCT_01749] Semantics of `SwAxisGeneric.swAxisType` in the definition of a fix axis [The role `SwAxisGeneric.swAxisType` specifies the `category` of the fix axis according to [TPS_SWCT_01748].]()

[TPS_SWCT_01750] Semantics of `SwAxisGeneric.swGenericAxisParam` in the definition of a fix axis [The role `SwAxisGeneric.swGenericAxisParam` provides the actual numeric values for the definition of the axis.

The semantics of a provided numerical value is clarified by the attribute `SwGenericAxisParamType.category` where meta-class `SwGenericAxisParamType` is referenced in the role `swGenericAxisParamType.()`

category of <code>swAxisType</code>	category of <code>SwGenericAxis-ParamType</code>	Multiplicity of <code>swGenericAxis-Param</code>	Multiplicity of <code>vf</code>
<code>FIX_AXIS_PAR</code>	OFFSET	1	1
	SHIFT	1	1
<code>FIX_AXIS_PAR_DIST</code>	OFFSET	1	1
	DISTANCE	1	1
<code>FIX_AXIS_PAR_LIST</code>	LIST	1	1..*

Table 5.61: Modeling of `SwAxisGeneric`

[constr_1544] Modeling of `SwAxisGeneric` for the definition of a fix axis [The standardized values and multiplicities within the model of an `SwAxisGeneric` according to [TPS_SWCT_01479] and [TPS_SWCT_01480] are documented in Table 5.61.]
()

The modeling of an axis of category `FIX_AXIS_PAR` is sketched in the following example model (Figure 5.36).

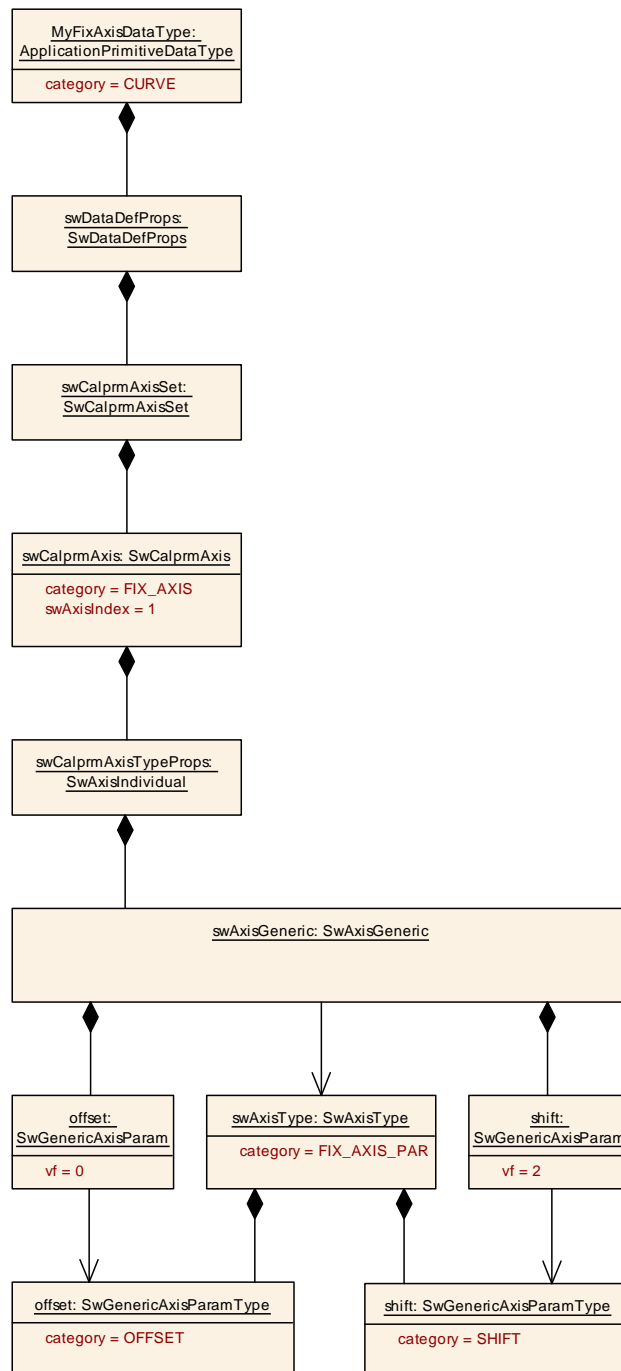

Figure 5.36: Modeling of a fix axis of category `FIX_AXIS_PAR`

The modeling of an axis of category `FIX_AXIS_PAR_DIST` is sketched in the following example model (Figure 5.37).

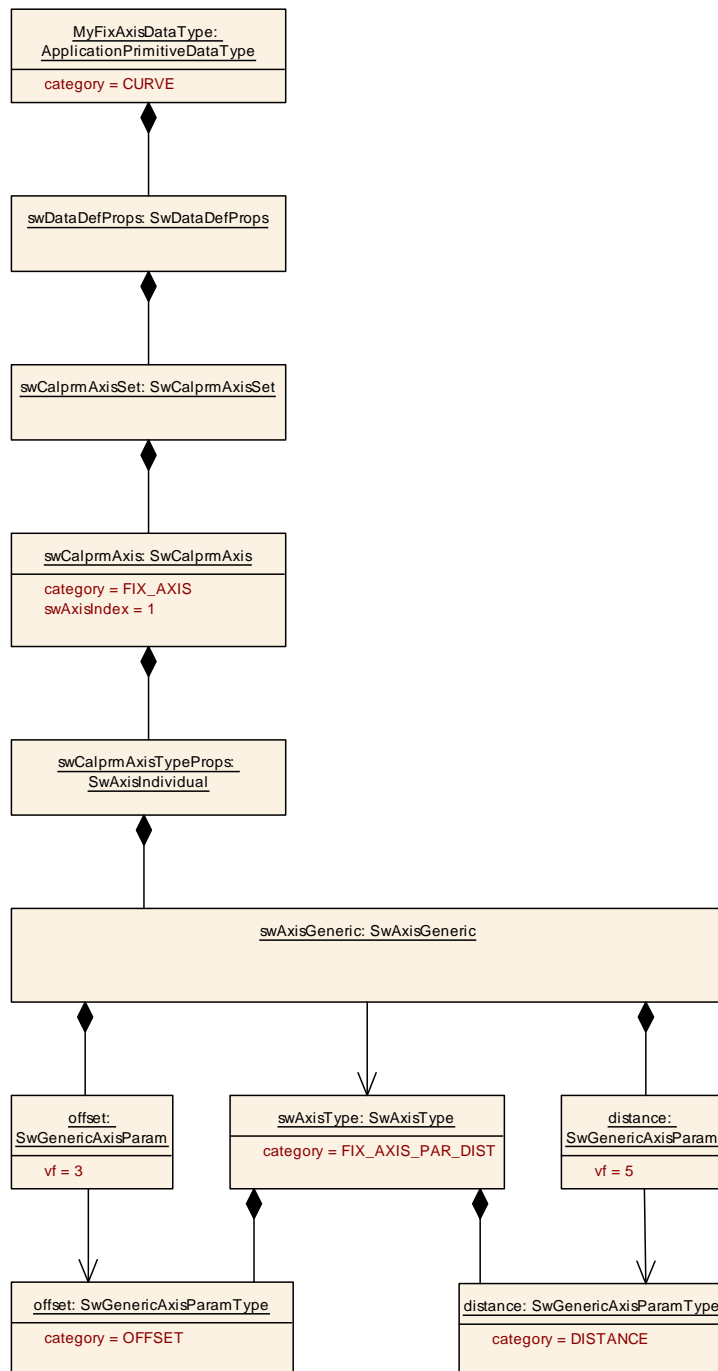

Figure 5.37: Modeling of a fix axis of category `FIX_AXIS_PAR_DIST`

The modeling of an axis of category `FIX_AXIS_PAR_LIST` is sketched in the following example model (Figure 5.38).

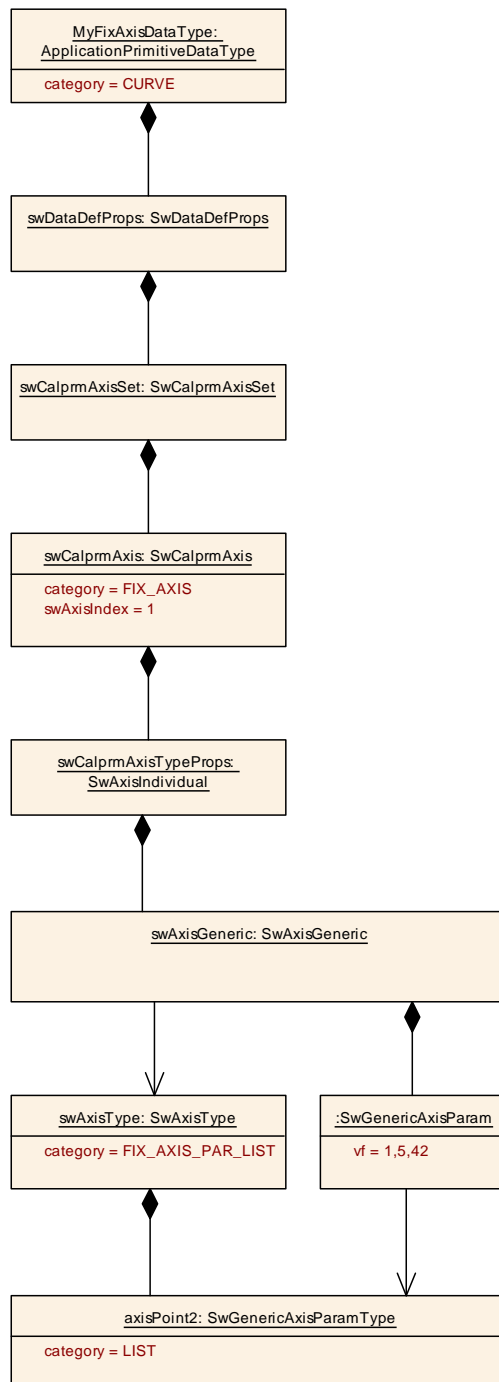

Figure 5.38: Modeling of a fix axis of category `FIX_AXIS_PAR_LIST`

Please note that the axis points and values of a fix axis are defined in the definition of the fix axis itself and therefore any initial value assigned to a fix axis would be ignored anyway.

This might lead to confusion such that the initial value does not make it into the software. In order to avoid such confusion AUTOSAR **does not support the definition of an initial value for a fix axis**.

This regulation is reflected in the existence of [[constr_1545](#)].

[constr_1545] No initialization for fix axis [An [ApplicationValueSpecification](#) taken to initialize an [ApplicationPrimitiveDataType](#) that contains a fix axis shall not contain initial values for the axis index of the fix axis inside the [ApplicationPrimitiveDataType](#).]()

Please note that the calibration software may still have access to axis points and values of the fix axis if these properties are specified in an A2L file.

For this purpose [McDataInstance](#) needs to be set up properly. The details are explained in [6].

5.4.5 Setting an Axis Input Value

When an interpolation routine is called, an input value has to be provided to find the appropriate axis entry in the implementation of a [RunnableEntity](#). However, this input value cannot be arbitrarily chosen but only be selected from available [VariableDataPrototype](#) assigned to it.

In an axis definition attached to an [ApplicationPrimitiveDataType](#), it is possible to specify the data type of the input values by means of the reference [SwAxisIndividual.inputVariableType](#).

However, the reference [SwAxisIndividual.inputVariableType](#) does not necessarily have to exist.

This leaves the consideration of compatibility between the [DataPrototype](#)(s) referenced by means of [SwAxisIndividual.swVariableRef](#) and the actual axis specification to the following attributes:

- [SwAxisIndividual.dataConstr](#)
- [SwAxisIndividual.compuMethod](#)
- [SwAxisIndividual.unit](#)

[TPS_SWCT_01676] Preferred approach to checking the compatibility of input value and axis [The compatibility in terms of data type between the description of an [SwAxisIndividual](#) and the [DataPrototype](#)(s) used as an input variable to the respective interpolation routine shall preferably be checked alternatively between

- the [ApplicationPrimitiveDataType](#)(s) of [DataPrototype](#)(s) referenced by means of [SwAxisIndividual.swVariableRef](#) (the provider in terms of compatibility)
- the [ApplicationPrimitiveDataType](#) referenced by means of [SwAxisIndividual.inputVariableType](#) (The requester in terms of compatibility).

For compatibility, the [compuMethod](#) of [SwAxisIndividual.swVariableRef](#) and the [ApplicationPrimitiveDataType](#) referenced by means of [SwAxisIndividual.inputVariableType](#) shall not be considered.]()

Rationale: in many cases the input variable is defined by a float data type to take benefit from the precision in computations. But the axis data type is an integer data type to save memory. In this situation, a requirement for compatible `compuMethods` would exclude the described scenario.

The implementation of the software-component shall make sure that the float value is properly converted and rescaled to an integer data type compatible to the axis data type.

[TPS_SWCT_01677] Fall-back approach to checking the compatibility of input value and axis [If the reference `SwAxisIndividual.inputVariableType` does not exist then the compatibility in terms of data type between the description of an `SwAxisIndividual` and the `DataPrototype(s)` used as an input variable to the respective interpolation routine shall be checked on the basis of the following references:

- `SwAxisIndividual.dataConstr`
- `SwAxisIndividual.unit`

respectively

- `SwAxisIndividual.dataConstr`
- `SwAxisIndividual.compuMethod.unit`

against their respective counterparts in the `ApplicationPrimitiveDataTypes` of the `DataPrototype(s)` referenced by means of `SwAxisIndividual.swVariableRef.()`

[constr_1420] Existence of `SwAxisIndividual.inputVariableType` [If the reference `SwAxisIndividual.inputVariableType` does not exist then either:

- `SwAxisIndividual.dataConstr`
- `SwAxisIndividual.unit`

or

- `SwAxisIndividual.dataConstr`
- `SwAxisIndividual.compuMethod.unit`

shall exist.]()

The constraint is necessary for the generation of the respective specification of the axis in A2L.

Every `ParameterDataPrototype` then allows to specify zero or more input values (being type compatible to `inputVariableType`) in its axis description.

This means that at the specification time of an `SwcInternalBehavior` a list of input values has to be specified where the implementer of a `RunnableEntity` can choose of. The input values are `DataPrototype` entities either being

- a `VariableDataPrototype` in a `SenderReceiverInterface` or `NvDataInterface` of a `PortPrototype`, of the `AtomicSwComponentType` where the `SwcInternalBehavior` is associated to, or an `ArgumentDataPrototype` in a `ClientServerOperation` of a `ClientServerInterface` in a `PortPrototype` of the `AtomicSwComponentType` where the `InternalBehavior` is associated to, or
- a `VariableDataPrototype` within the `SwcInternalBehavior`.

To achieve this, `SwAxisIndividual` is aggregating a `SwVariableRefProxy`.

Originally, MSRSW uses a `AutosarVariableRef` to set the input value of an axis appropriately. In AUTOSAR, this has been extended by first introducing a `SwVariableRefProxy`.

Note that this is a specific use case for the role `SwVariableRefProxy.autosarVariable`.

Note further that the use cases for the existence of the attributes `SwVariableRefProxy.autosarVariable` and `SwVariableRefProxy.mcDataInstanceVar` are entirely disjoint and therefore the simultaneous existence of these two attributes would not make any sense at all.

Therefore, `[constr_1382]` has been introduced to clarify this aspect.

[constr_1382] Mutually exclusive existence of attributes `SwVariableRefProxy.autosarVariable` vs. `SwVariableRefProxy.mcDataInstanceVar` [In any given AUTOSAR model, the aggregations `SwVariableRefProxy.autosarVariable` and `SwVariableRefProxy.mcDataInstanceVar` shall never exist at the same time.]()

As shown in Figure 5.39, this approach is also used to represent a `AutosarVariableRef` in all roles, e.g. the result of an interpolation routine applied to an axis, the input value determination, a list of dependent parameters, and `swDataDependency`.

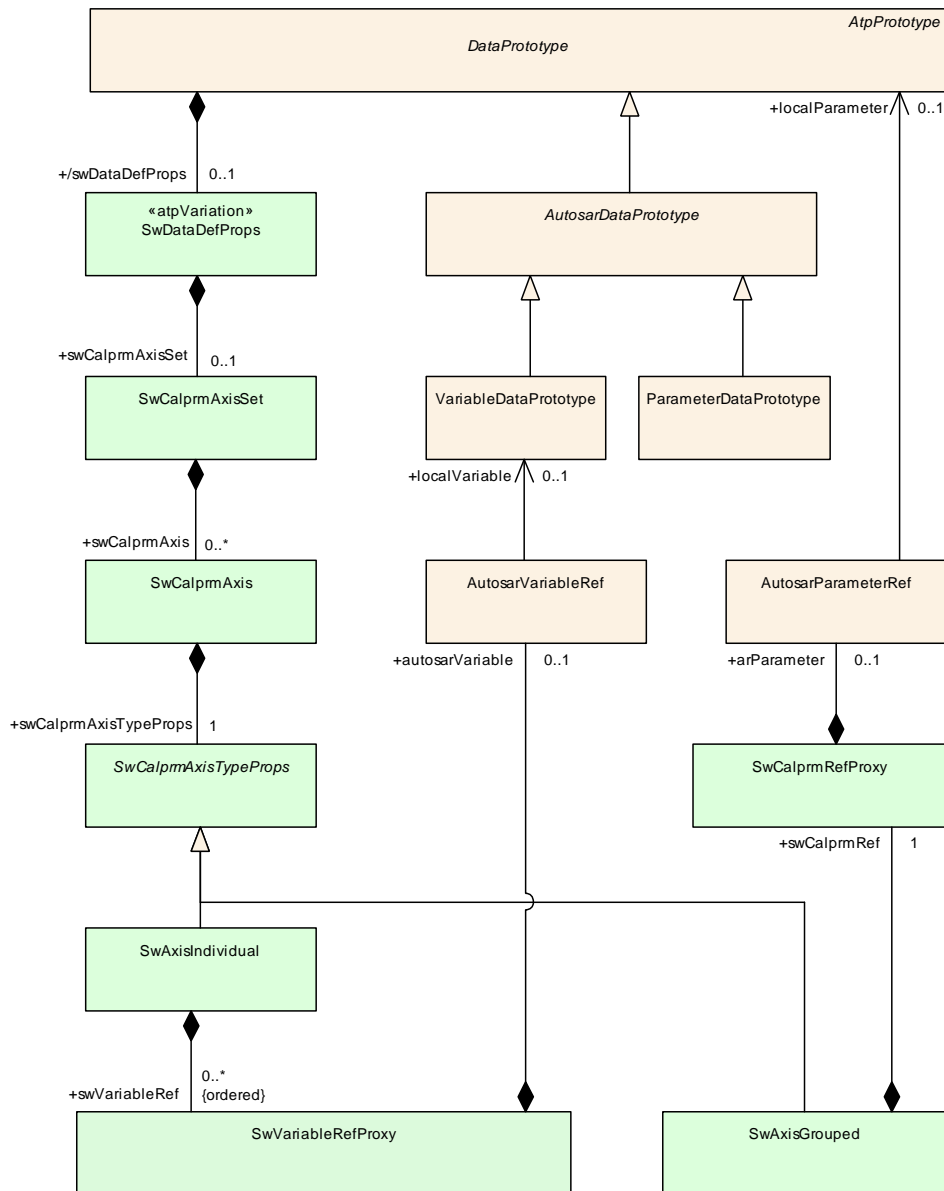

Figure 5.39: Extended Axis Elements and Input Variable Reference

With the means of `ApplicationArrayDataTypes` it's possible to define `DataPrototypes` holding an n-dimensional array of Compound Primitive Data Types of category `CURVE`, `MAP`, `CUBOID`, `CUBE_4`, `CUBE_5`, `COM_AXIS`, or `RES_AXIS`.

For those `DataPrototypes` input values for the axes should be described to enable a display of the working point in the MCD system.

Thereby, typically the whole array of the contained axes is either associated with an array of variables or with a single value. In the case of arrays typically the n-th axis is combined with the n-th input value.

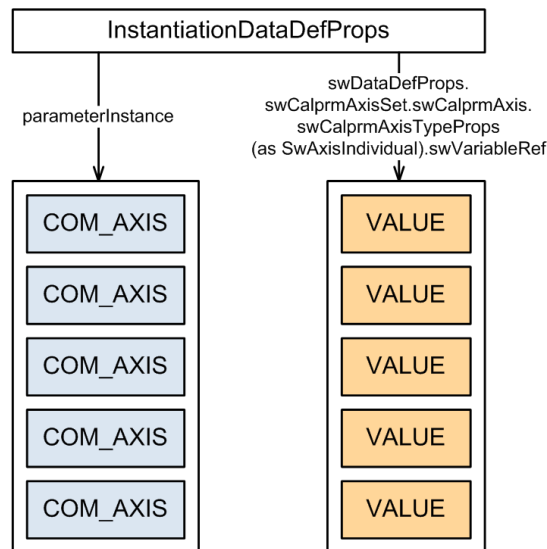

Figure 5.40: The n^{th} **COM_AXIS** in the array of **COM_AXIS**s uses the n^{th} **VALUE** in the array of **VALUE**s as working point.

[constr_1425] Definition of `swCalprmAxisSet.swCalprmAxis/ SwAxisIndividual.swVariableRef` depending on the capabilities of the data type [The definition of a `swCalprmAxisSet.swCalprmAxis/ SwAxisIndividual.swVariableRef` in the context of an `InstantiationDataDefProps` or a `ParameterAccess` is only supported for a `DataPrototype` of category `ARRAY` if the data type of the `ApplicationArrayElement` also supports the specification of a `swCalprmAxisSet.swCalprmAxis/ SwAxisIndividual.swVariableRef` according to **[constr_1289]**].

Thereby, multiple `ApplicationArrayDataTypes` might be nested to express multiple array dimensions.]()

[TPS_SWCT_01683] Specification of an array of input variable for an array of axes [For `DataPrototypes` typed by an array of elements of category `CURVE`, `MAP`, `CUBOID`, `CUBE_4`, `CUBE_5`, `COM_AXIS`, or `RES_AXIS` the applied `InstantiationDataDefProps` or `ParameterAccess` may reference a `VariableDataPrototype` typed by an `ApplicationArrayDataType` with the means of `SwAxisIndividual.swVariableRef.autosarVariable`].

This expresses the semantic that the n^{th} element in the axis array uses the n^{th} value in the input variable array for the specific `SwAxisGrouped.swAxisIndex`.]()

Please note that in this case the two associated arrays needs to have same number of dimensions and sizes of the dimensions.

[constr_1426] Consistency of array sizes for axes and input variable array [The number of array dimension defined by `ApplicationArrayDataTypes` and the values of the `maxNumberOfElements` attributes for the array of elements of category

CURVE, MAP, CUBOID, CUBE_4, CUBE_5, COM_AXIS, or RES_AXIS shall be **identical** to the number of array dimension and according value of the `maxNumberOfElements` of the `VariableDataPrototype` referenced by `SwAxisIndividual.swVariableRef.autosarVariable.()`

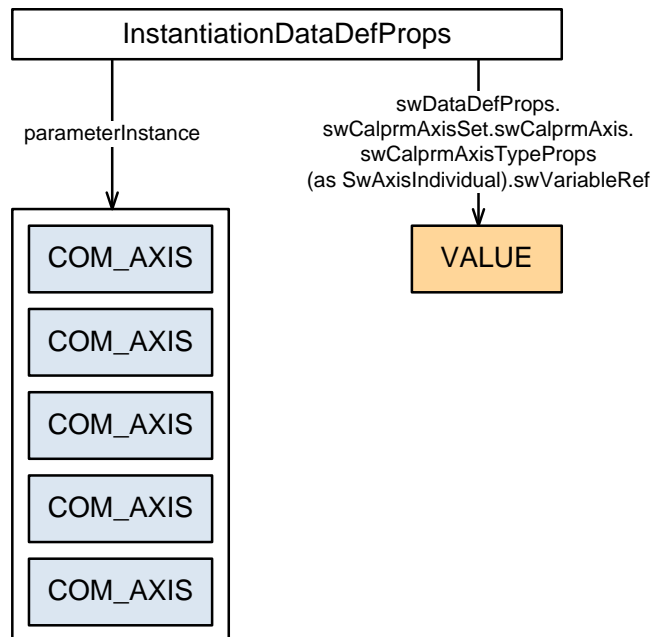

Figure 5.41: Each `COM_AXIS` in the array of `COM_AXIS`s uses the identical `VALUE` as working point.

[TPS_SWCT_01684] Specification of a single input variable for an array of axes
 [For `DataPrototypes` typed by an array of elements of `category` CURVE, MAP, CUBOID, CUBE_4, CUBE_5, COM_AXIS, or RES_AXIS the applied `InstantiationDataDefProps` or `ParameterAccess` may reference a `VariableDataPrototype` typed by an `ApplicationPrimitiveDataType` with the means of `SwAxisIndividual.swVariableRef.autosarVariable`.

This expresses the semantic that each element in the axis array uses the identical input variable for the specific `SwAxisGrouped.swAxisIndex.()`

5.4.6 Setting a Group Axis

Grouped curves share the same axis definition. In MSRSW, this is shown by referencing the `SwCalprm`, representing an individual curve, from a `SwAxisGrouped`.

Note that this does not describe which axis shall be taken from a reference `swCalprmRef` acting as a shared axis. This would be done in `SwAxisGrouped.swAxisIndex`.

AUTOSAR applies a similar proxy approach for parameters as for the variables. Therefore, an `SwCalprmRefProxy` has been introduced in MSRSW, and is aggregated by the `SwAxisGrouped` element.

The `SwCalprmRefProxy` aggregates an `AutosarParameterRef` providing an association to a `ParameterDataPrototype`, representing a curve with an axis. When defining the data-type of a parameter, the type of the shared axis is defined in `sharedAxisType`.

[constr_1020] `ParameterDataPrototype` needs to be of compatible data type as referenced in `sharedAxisType` [Finally, the `ParameterDataPrototype` assigned in `swCalprmRef` shall be typed by data type compatible to `sharedAxisType`.]
 ()

The AUTOSAR-style is shown in the upper left part of Figure 5.39, while in the upper middle the MSRSW style is shown, referencing the `SwCalprm`.

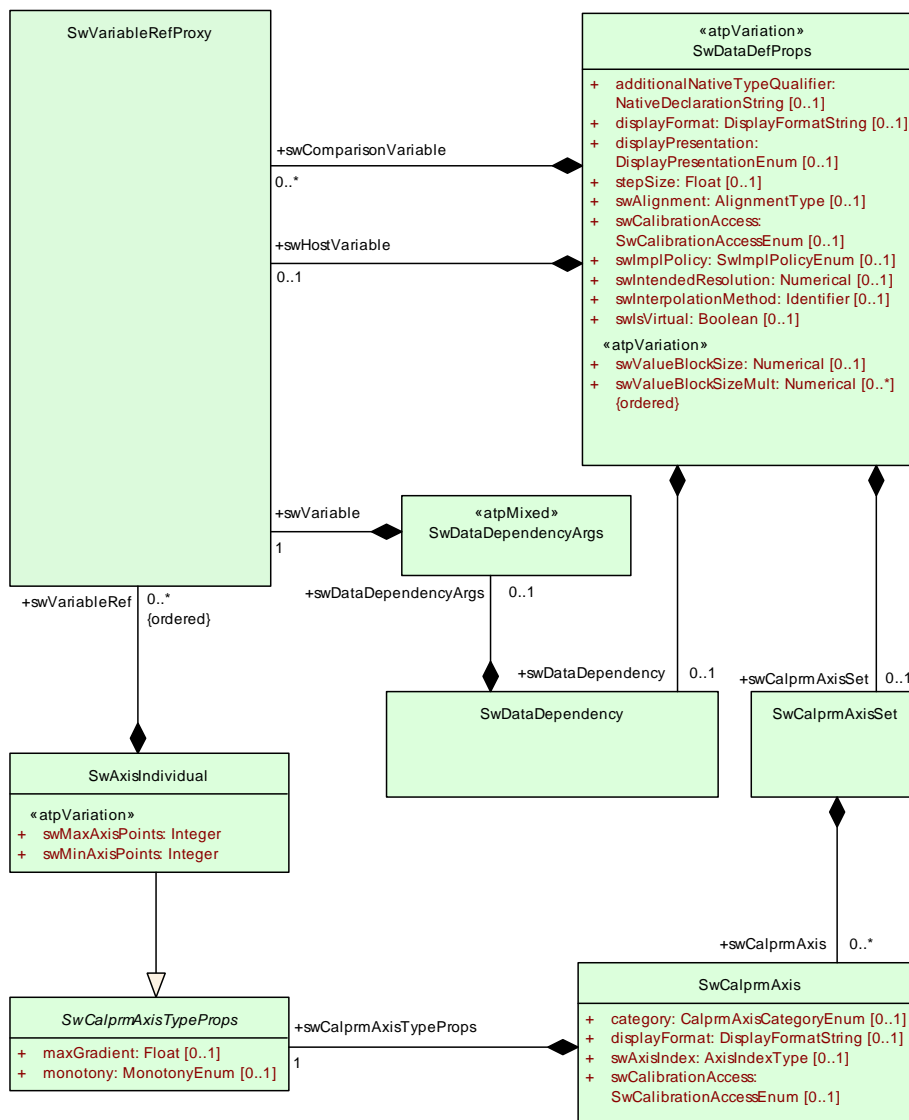

Figure 5.42: Applying Proxy Variable Reference Mechanism

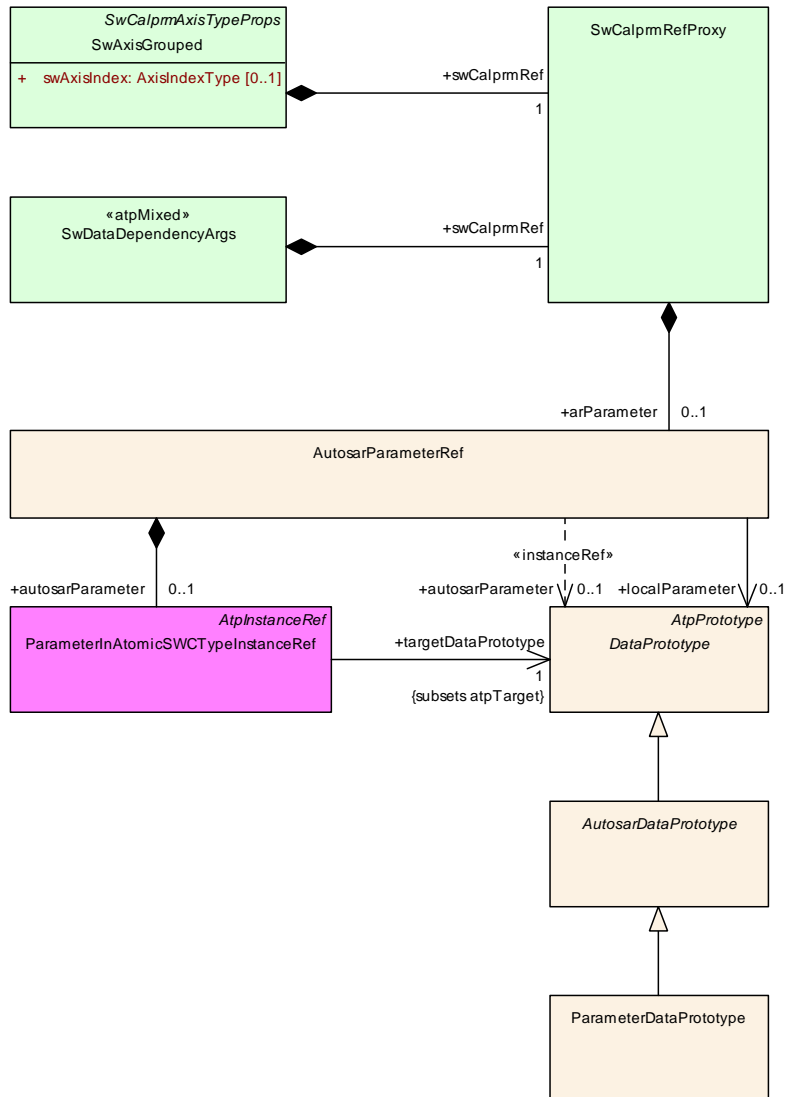

Figure 5.43: Applying Proxy Parameter Reference Mechanism

Class	SwCalprmRefProxy			
Package	M2::MSR::DataDictionary::DatadictionaryProxies			
Note	Wrapper class for different kinds of references to a calibration parameter.			
Base	ARObject			
Attribute	Type	Mult.	Kind	Note
arParameter	AutosarParameterRef	0..1	aggr	This represents a Parameter within AUTOSAR. Note that the Datatype of the referenced ParameterDataPrototype shall be an ApplicationDataType of category VALUE.





Class	SwCalprmRefProxy			
mcDataInstance	McDataInstance	0..1	ref	This reference is used in the McSupport file to express the final instance of group axis etc. It is not allowed to use this outside of an McDataInstance. The referenced mcDataInstance shall be originated from a ParameterDataPrototype.

Table 5.62: SwCalprmRefProxy

Class	SwVariableRefProxy			
Package	M2::MSR::DataDictionary::DatadictionaryProxies			
Note	Proxy class for several kinds of references to a variable.			
Base	ARObject			
Attribute	Type	Mult.	Kind	Note
autosarVariable	AutosarVariableRef	0..1	aggr	This represents the reference to a Variable in an Autosar system. Note that the target of the reference within AutosarVariableRef shall be typed by a primitive data type
mcDataInstance Var	McDataInstance	0..1	ref	This reference is used in the McSupport file to express the final instance of input values etc. It is not allowed to use this outside of an McDataInstance. The referenced mcDataInstance shall be originated from a VariableDataPrototype.

Table 5.63: SwVariableRefProxy

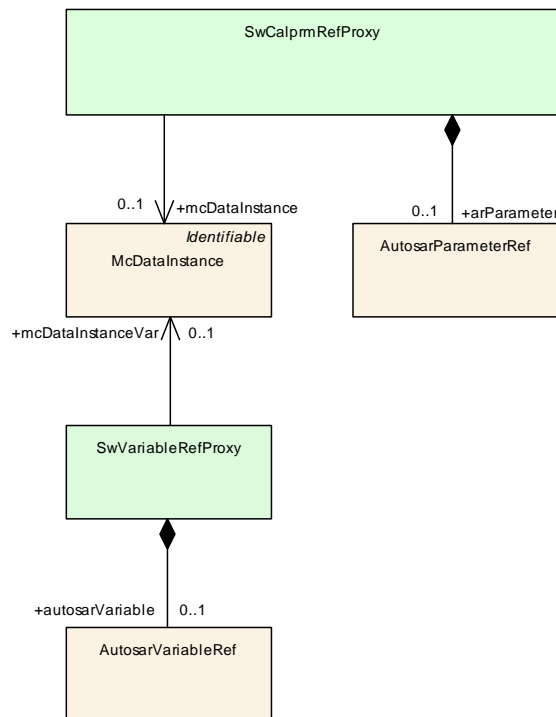

Figure 5.44: Proxy reference classes

The basic patterns for referencing `DataPrototypes` are explained in section 5.3.3. In the context of this chapter it is worth to remark that the definition of access to calibration parameters is implemented in the context of a `RunnableEntity` (see Figure 7.3).

As the definition of a calibration parameter may involve the definition of several axes the necessity to provide this amount of information might become cumbersome and (to some extent) redundant and difficult to maintain if the same calibration parameter is accessed from within several `RunnableEntities`. In other words: in this case it would be necessary to repeat the more or less complex set of information for each `RunnableEntity`.

To avoid this unnecessary level of complexity for the definition of access to calibration parameters, it is possible to define the access to the calibration parameter on the level of `InstantiationDataDefProps` which have been defined to facilitate this kind of re-use (for more information please refer to section 7.5.4). This ability is also documented in Table 5.41.

With the means of `ApplicationArrayDataTypes` its possible to define `DataPrototypes` holding an n-dimensional array of Compound Primitive Data Types of category `CURVE`, `MAP`, `CUBOID`, `CUBE_4`, and `CUBE_5`.

For those `DataPrototypes`, group axis/axes needs to be defined in case `SwAxisIndividuals` are not used for all `SwCalprmAxis` definitions.

Thereby, typically the whole array of elements of category `CURVE`, `MAP`, `CUBOID`, `CUBE_4`, and `CUBE_5` is either associated with an array of group axes or alternatively with a single group axis.

In the case of arrays typically the nth `CURVE`, `MAP`, `CUBOID`, `CUBE_4`, and `CUBE_5` is combined with the nth `COM_AXIS` or `RES_AXIS`.

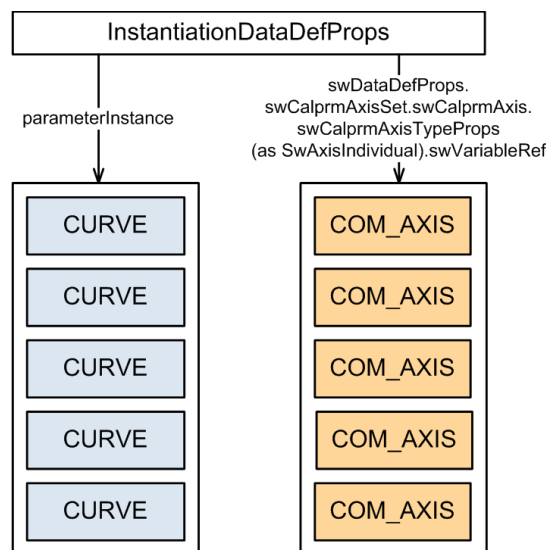

Figure 5.45: The nth `CURVE` in the array of `CURVES` relates to the nth `COM_AXIS` in the array of `COM_AXIS`s

[constr_1427] Definition of `swCalprmAxisSet.swCalprmAxis/ SwAxisGrouped.swCalprmRef` depending on the capabilities of the data type [The definition of a `swCalprmAxisSet.swCalprmAxis/ SwAxisGrouped.swCalprmRef` in the context of an `InstantiationDataDefProps` or a `ParameterAccess` is only supported for a `DataPrototype` of category `ARRAY` if the data type of the `ApplicationArrayElement` also supports the specification of a `swCalprmAxisSet.swCalprmAxis/ SwAxisGrouped.swCalprmRef` according to [\[constr_1289\]](#).

Thereby, multiple `ApplicationArrayDataTypes` might be nested to express multiple array dimensions.]()

[TPS_SWCT_01685] Specification of an array of group axes for an array of category `CURVE`, `MAP`, `CUBOID`, `CUBE_4`, or `CUBE_5` [For `DataPrototypes` typed by an array of elements of category `CURVE`, `MAP`, `CUBOID`, `CUBE_4`, or `CUBE_5` the applied `InstantiationDataDefProps` or `ParameterAccess` may reference a `DataPrototype` typed by an `ApplicationArrayDataType` with the means of `SwAxisGrouped.swCalprmRef.arParameter`.

This expresses the semantic that the n^{th} element in the `CURVE`, `MAP`, `CUBOID`, `CUBE_4`, or `CUBE_5` array uses the n^{th} group axis in the `COM_AXIS` or `RES_AXIS` array for the specific `SwAxisGrouped.swAxisIndex`.]()

Please note that in this case the two associated arrays needs to have same number of dimensions and sizes of the dimensions.

[constr_1428] Consistency of array sizes for arrays of elements of category `CURVE`, `MAP`, `CUBOID`, `CUBE_4`, or `CUBE_5` arrays and used group axes arrays [The number of array dimension defined by `ApplicationArrayDataTypes` and the values of attribute `maxNumberOfElements` attributes for the array of elements of category `CURVE`, `MAP`, `CUBOID`, `CUBE_4`, or `CUBE_5` needs to be identical to the number of array dimension and according value of the `maxNumberOfElements` of the `DataPrototype` referenced by `SwAxisGrouped.swCalprmRef.arParameter`.]()

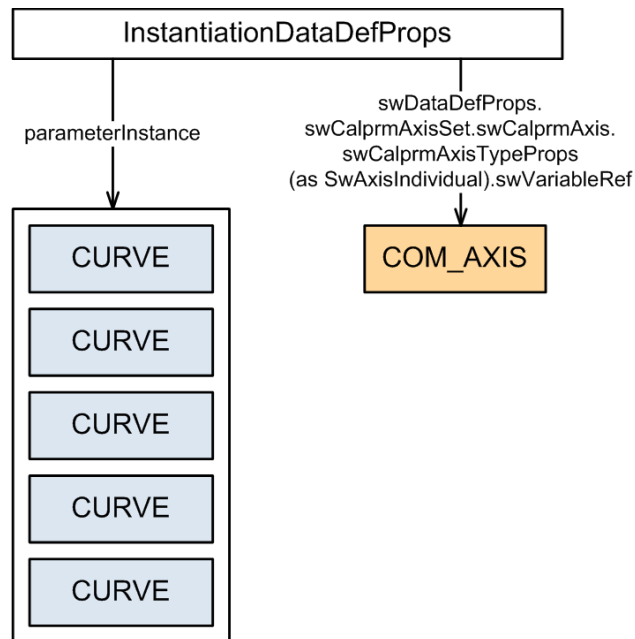

Figure 5.46: Each **MAP** in the array of **CURVES** uses the identical **COM_AXIS**

[TPS_SWCT_01686] Specification of a single group axis for an array of elements of category **CURVE**, **MAP**, **CUBOID**, **CUBE_4**, or **CUBE_5** [For *DataPrototypes* typed by an array of elements of category **CURVE**, **MAP**, **CUBOID**, **CUBE_4**, or **CUBE_5** the applied *InstantiationDataDefProps* or *ParameterAccess* may reference a *DataPrototype* typed by a *ApplicationPrimitiveDataTypes* of category **COM_AXIS** or **RES_AXIS** with the means of *SwAxisGrouped.swCalprmRef.arParameter*.

This expresses the semantic that each element in the **CURVE**, **MAP**, **CUBOID**, **CUBE_4**, or **CUBE_5** array uses the identical **COM_AXIS** or **RES_AXIS** for the specific *SwAxisGrouped.swAxisIndex*.|()

5.4.7 Specifying Data Dependencies

SwDataDependency allows dependent data elements to be specified. For example, other *ParameterDataPrototypes* can be combined into one *ParameterDataPrototype* whose consistent value is automatically derived by the measurement and calibration system. Upon adjusting one of the parameters, the dependent parameter is then also automatically adjusted according to the chosen formula.

Consider for example a rectangular triangle with a hypotenuse of length 1, where the length of the other sides are the parameters A and B. When adjusting parameter A, the parameter B has to be adjusted accordingly to $B = \sqrt{1 - A * A}$. Also, other parameters might depend on B, e.g. $B_AREA = B * B$ or $TRIANGULAR_AREA = (A * B)/2$. This example is shown in listing 5.9.

A dependent parameter should not be adjustable by itself. The only way to influence its value is through the adjustment of a parameter it depends on.

Listing 5.9: Data Dependency

```

<PER-INSTANCE-PARAMETERS>
  <PARAMETER-DATA-PROTOTYPE>
    <SHORT-NAME>A</SHORT-NAME>
    <DESC>
      <L-2 L="DE">The independent Parameter</L-2>
    </DESC>
    <CATEGORY>VALUE</CATEGORY>
  </PARAMETER-DATA-PROTOTYPE>
  <PARAMETER-DATA-PROTOTYPE>
    <SHORT-NAME>B</SHORT-NAME>
    <DESC>
      <L-2 L="DE">The dependent Parameter</L-2>
    </DESC>
    <SW-DATA-DEF-PROPS>
      <SW-DATA-DEF-PROPS-VARIANTS>
        <SW-DATA-DEF-PROPS-CONDITIONAL>
          <SW-DATA-DEPENDENCY>
            <SW-DATA-DEPENDENCY-FORMULA>SQRT ( X1 * X1 )</SW-
              DATA-DEPENDENCY-FORMULA>
            <SW-DATA-DEPENDENCY-ARGS>
              <AR-PARAMETER>
                <LOCAL-PARAMETER-REF DEST="PARAMETER-DATA-
                  PROTOTYPE">/DataDependency/foo/bar/A</
                  LOCAL-PARAMETER-REF>
              </AR-PARAMETER>
            </SW-DATA-DEPENDENCY-ARGS>
          </SW-DATA-DEPENDENCY>
        </SW-DATA-DEF-PROPS-CONDITIONAL>
      </SW-DATA-DEF-PROPS-VARIANTS>
    </SW-DATA-DEF-PROPS>
  </PARAMETER-DATA-PROTOTYPE>
  <PARAMETER-DATA-PROTOTYPE>
    <SHORT-NAME>B_AREA</SHORT-NAME>
    <DESC>
      <L-2 L="DE">The dependent Parameter</L-2>
    </DESC>
    <SW-DATA-DEF-PROPS>
      <SW-DATA-DEF-PROPS-VARIANTS>
        <SW-DATA-DEF-PROPS-CONDITIONAL>
          <SW-DATA-DEPENDENCY>
            <SW-DATA-DEPENDENCY-FORMULA>X1 * X1</SW-DATA-
              DEPENDENCY-FORMULA>
            <SW-DATA-DEPENDENCY-ARGS>
              <AR-PARAMETER>
                <LOCAL-PARAMETER-REF DEST="PARAMETER-DATA-
                  PROTOTYPE">/DataDependency/foo/bar/B</
                  LOCAL-PARAMETER-REF>
              </AR-PARAMETER>
            </SW-DATA-DEPENDENCY-ARGS>
          </SW-DATA-DEPENDENCY>
        </SW-DATA-DEF-PROPS-CONDITIONAL>
      </SW-DATA-DEF-PROPS-VARIANTS>
    </SW-DATA-DEF-PROPS>
  </PARAMETER-DATA-PROTOTYPE>

```

```

        </SW-DATA-DEF-PROPS-VARIANTS>
    </SW-DATA-DEF-PROPS>
</PARAMETER-DATA-PROTOTYPE>
<PARAMETER-DATA-PROTOTYPE>
    <SHORT-NAME>TRIANGULAR_AREA</SHORT-NAME>
    <DESC>
        <L-2 L="DE">The dependent Parameter</L-2>
    </DESC>
    <SW-DATA-DEF-PROPS>
        <SW-DATA-DEF-PROPS-VARIANTS>
            <SW-DATA-DEF-PROPS-CONDITIONAL>
                <SW-DATA-DEPENDENCY>
                    <SW-DATA-DEPENDENCY-FORMULA>(X1 * X2) / 2</SW-
                        DATA-DEPENDENCY-FORMULA>
                    <SW-DATA-DEPENDENCY-ARGS>
                        <AR-PARAMETER>
                            <LOCAL-PARAMETER-REF DEST="PARAMETER-DATA-
                                PROTOTYPE">/DataDependency/foo/bar/A</
                                    LOCAL-PARAMETER-REF>
                        </AR-PARAMETER>
                        <AR-PARAMETER>
                            <LOCAL-PARAMETER-REF DEST="PARAMETER-DATA-
                                PROTOTYPE">/DataDependency/foo/bar/B</
                                    LOCAL-PARAMETER-REF>
                        </AR-PARAMETER>
                    </SW-DATA-DEPENDENCY-ARGS>
                </SW-DATA-DEPENDENCY>
            </SW-DATA-DEF-PROPS-CONDITIONAL>
        </SW-DATA-DEF-PROPS-VARIANTS>
    </SW-DATA-DEF-PROPS>
</PARAMETER-DATA-PROTOTYPE>
</PER-INSTANCE-PARAMETERS>
</SWC-INTERNAL-BEHAVIOR>
</INTERNAL-BEHAVIORS>

```

Class	SwDataDependency			
Package	M2::MSR::DataDictionary::DataDefProperties			
Note	<p>This element describes the interdependencies of data objects, e.g. variables and parameters.</p> <p>Use cases:</p> <ul style="list-style-type: none"> Calculate the value of a calibration parameter (by the MCD system) from the value(s) of other calibration parameters. Virtual data - that means the data object is not directly in the ecu and this property describes how the "virtual variable" can be computed from the real ones (by the MCD system). 			
Base	ARObject			
Attribute	Type	Mult.	Kind	Note
swData Dependency Args	SwDataDependency Args	0..1	aggr	<p>Specifies the arguments used in the data dependency. Note that this is 0..1 since the aggregated class is a container (atpMixed).</p> <p>Tags:xml.sequenceOffset=40</p>





Class	SwDataDependency			
swDataDependencyFormula	CompuGenericMath	0..1	aggr	This element describes the formula with which the dependencies between the participating objects are defined. Tags: xml.sequenceOffset=30

Table 5.64: SwDataDependency

Class	<<atpMixed>> SwDataDependencyArgs			
Package	M2::MSR::DataDictionary::DataDefProperties			
Note	This element specifies the elements used in a SwDataDependency.			
Base	ARObject			
Attribute	Type	Mult.	Kind	Note
swCalprmRef	SwCalprmRefProxy	1	aggr	Specifies a calibration parameter as an input argument to the dependency. Tags: xml.roleElement=false xml.roleWrapperElement=false xml.sequenceOffset=60 xml.typeElement=false xml.typeWrapperElement=false
swVariable	SwVariableRefProxy	1	aggr	Specifies a variable as an input argument to the dependency. Tags: xml.roleElement=false xml.roleWrapperElement=false xml.sequenceOffset=70 xml.typeElement=false xml.typeWrapperElement=false

Table 5.65: SwDataDependencyArgs

5.4.8 Precedence of data properties with respect to data elements, axis elements, computation methods, units

There are similar attributes defined in [SwDataDefProps](#) as well as in [SwCalprmAxis](#) as well as in [CompuMethod](#). Therefore, we need to define which attribute value wins in the overall process from SWC-Description to MC-Support to ASAM-A2L.

Figure 5.47 illustrates the fact that some attributes in [SwDataDefProps](#) can also be expressed in subelements respectively in referenced elements.

[TPS_SWCT_01496] General precedence rule for attributes of [SwDataDefProps](#)

[The general precedence rule is that

- [SwDataDefProps](#) wins over [valueAxisDataType](#) (exception: [compuMethod](#) and [unit](#)).
- [SwDataDefProps](#) wins over [compuMethod](#).
- [SwDataDefProps](#) wins over [swCalprmAxisSet](#).

- SwDataDefProps.swCalprmAxisSet wins over swCalprmAxisSet.swCalprmAxis.swCalprmAxisTypeProps.compuMethod or SwAxisIndividual.inputVariableType.
- SwAxisIndividual.inputVariableType wins over SwAxisIndividual.compuMethod, SwAxisIndividual.unit, but not over SwAxisIndividual.dataConstr.

]()

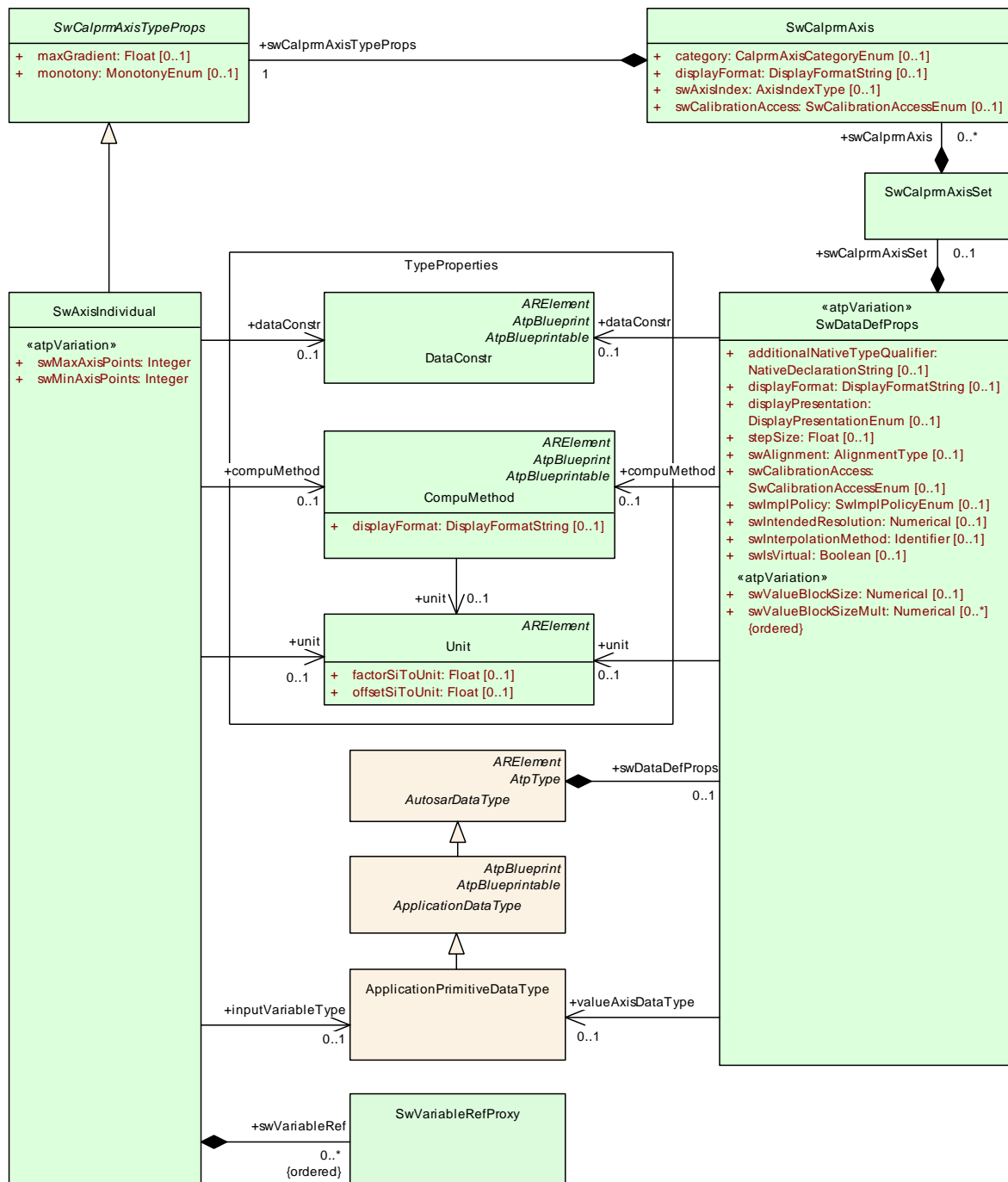

Figure 5.47: Various Attributes in the Context of SwDataDefProps

The following examples illustrate particular cases (the highest precedence comes first):

- **[TPS_SWCT_01497] Precedence of the unit of value axis** [For the usage of `unit` of value axis the following precedence rule is defined:

- `SwDataDefProps.valueAxisDataType.swDataDefProps.unit`
- `SwDataDefProps.valueAxisDataType.swDataDefProps.compuMethod.unit`
- `SwDataDefProps.unit`
- `SwDataDefProps.compuMethod.unit`

]()

[constr_2550] Units of value axis shall be consistent [The units specified in the context of value axis shall be the same, even if there is a precedence rule.]()

In particular, [constr_2550] reflects the fact that a `Unit` may be specified in different phases of the development process but finally need to be consistent.

- **[TPS_SWCT_01498] Precedence of the DataConstr of value axis** [For the usage of `DataConstr` of value axis the following precedence rule is defined:

- `SwDataDefProps.dataConstr`
- `SwDataDefProps.valueAxisDataType.swDataDefProps.dataConstr`

]()

[constr_2548] Data constraint of value axis shall match [The values compliant to `SwDataDefProps.dataConstr` shall also be compliant to `SwDataDefProps.valueAxisDataType.swDataDefProps.dataConstr`.

In other words `SwDataDefProps.dataConstr` win over but are not allowed to relax `SwDataDefProps.valueAxisDataType.swDataDefProps.dataConstr` but are not allowed]()

- **[TPS_SWCT_01499] Precedence of the CompuMethod of value axis** [For the usage of `CompuMethod` of value axis the following precedence rule is defined:

- `SwDataDefProps.valueAxisDataType.swDataDefProps.compuMethod`
- `SwDataDefProps.compuMethod`

]()

- **[TPS_SWCT_01500] Precedence of the display format of value axis** [For the usage of display format of value axis the following precedence rule is defined:

- `SwDataDefProps.displayFormat`

- `SwDataDefProps.valueAxisDataType.swDataDefProps.displayFormat`
- `SwDataDefProps.valueAxisDataType.swDataDefProps.compuMethod.displayFormat`
- `SwDataDefProps.compuMethod.displayFormat`

]()

Note that this deviates from the general rule since `displayFormat` is not an essential property. The last item in the list above is the consequence of the fact that if there is a `valueAxisDataType` it supersedes the `compuMethod`

- **[TPS_SWCT_01501] Precedence of the calibration access of value axis** [For the usage of calibration access of value axis the following precedence rule is defined:

- `SwDataDefProps.swCalibrationAccess`
- `SwDataDefProps.valueAxisDataType.swDataDefProps.swCalibrationAccess`

]()

Note that this deviates from the general rule since `swCalibrationAccess` is not such an essential property.

- **[TPS_SWCT_01502] Precedence of the Unit of the input axis** [For the usage of `Unit` of the input axis the following precedence rule is defined:

- `SwAxisIndividual.unit`
- `SwAxisIndividual.compuMethod.unit`
- `SwAxisIndividual.inputVariableType.swDataDefProps.unit`
- `SwAxisIndividual.swVariableRef.autosarVariable.autosarVariable.type.swDataDefProps.compuMethod.unit`
- `SwAxisIndividual.swVariableRef.autosarVariable.autosarVariable.type.swDataDefProps.unit`

]()

[constr_2549] Units of input axis shall be consistent [The units specified in the context of an input axis shall be compatible, even if there is a precedence rule.]()

[constr_2549] reflects the fact that `unit` may be specified in different phases of the development process but finally need to be consistent.

- **[TPS_SWCT_01503] Precedence of the DataConstr of the input axis** [For the usage of `DataConstr` of the input axis the following precedence rule is defined:

- `SwAxisIndividual.dataConstr`
- `SwAxisIndividual.inputVariableType.swDataDefProps.dataConstr`
- `SwAxisIndividual.swVariableRef.type.swDataDefProps.dataConstr`

]()

Please note that the attribute `SwAxisIndividual.inputVariableType.swDataDefProps.dataConstr` represents the input value, not the axis itself. For this reason, there is no specific constraint defined that the `dataConstr` needs to fulfill.

- **[TPS_SWCT_01504] Precedence of the display format of the input axis** [For the usage of display format of the input axis the following precedence rule is defined:

- `SwCalprmAxis.displayFormat`
- `SwCalprmAxis.swCalprmAxisTypeProps.compuMethod.displayFormat`
- `SwCalprmAxis.swCalprmAxisTypeProps.inputVariableType.swDataDefProps.displayFormat`
- `SwCalprmAxis.swCalprmAxisTypeProps.inputVariableType.swDataDefProps.compuMethod.displayFormat`
- `SwCalprmAxis.swCalprmAxisTypeProps.swVariableRef.type.swDataDefProps.displayFormat`
- `SwCalprmAxis.swCalprmAxisTypeProps.swVariableRef.type.swDataDefProps.compuMethod.displayFormat`

]()

Please note that `SwAxisIndividual.inputVariableType.swDataDefProps.dataConstr` represent the input value and not the axis itself. For this reason there is no specific constraint that `displayFormat` needs to match.

- **[TPS_SWCT_01505] Precedence of calibration access along structure hierarchies in complex types** [For the usage of calibration access along structure hierarchies in complex types the precedence rule is defined in table 5.66.]()

outer	inner	result
notAccessible	*	notAccessible
readOnly	readOnly	readOnly
readOnly	readWrite	readOnly
readOnly	notAccessible	notAccessible
readWrite	notAccessible	notAccessible
readWrite	readOnly	readOnly
readWrite	readWrite	readWrite

Table 5.66: Precedence of `swCalibrationAccess` along structure hierarchies

The interpretation of table 5.66 is that it lists possible combinations of values of `SwCalibrationAccessEnum` for outer and inner elements of a complex data type and the (in the column "result") indicates value of `SwCalibrationAccessEnum` applicable for this specific combination.

- **[TPS_SWCT_01506] Precedence of the calibration access of input axis** [For the usage of calibration access of input axis the following precedence rule is defined:
 - `SwDataDefProps.swCalibrationAccess`
 - `SwCalprmAxis.swCalibrationAccess`

]()

Note that the `swCalibrationAccess` defined on a Compound Primitive Data Type (see [TPS_SWCT_01179]) reflects the entire curve or map.

Therefore, if the entire curve or map cannot be accessed by the measurement calibration diagnostic system (MCD-System), the axis can also not be accessed. On the other hand it might be that access is granted for the value axis only but not for the axis points.

5.5 Elements used in Properties of Data Definitions

This section describes further elements which are attached to `SwDataDefProps` via associations.

5.5.1 Computation Methods

[TPS_SWCT_01276] Computation methods [An important part of semantics is the specification of a so-called computation method which specifies the conversion between the physical and the internal representation of data. This usually makes sense only for primitive data types.]()

An [ApplicationCompositeDataType](#) cannot be given a particular semantic meaning as a whole but it is obviously possible to specify the semantics of all or a part of the contained elements, i.e. the [ApplicationPrimitiveDataTypes](#).

Class	CompuMethod			
Package	M2::MSR::AsamHdo::ComputationMethod			
Note	This meta-class represents the ability to express the relationship between a physical value and the mathematical representation. Note that this is still independent of the technical implementation in data types. It only specifies the formula how the internal value corresponds to its physical pendant. Tags: atp.recommendedPackage=CompuMethods			
Base	ARElement , ARObject , AtpBlueprint , AtpBlueprintable , CollectableElement , Identifiable , Multilanguage , Referrable , PackageableElement , Referrable			
Attribute	Type	Mult.	Kind	Note
compuInternalToPhys	Compu	0..1	aggr	This specifies the computation from internal values to physical values. Tags: xml.sequenceOffset=80
compuPhysToInternal	Compu	0..1	aggr	This represents the computation from physical values to the internal values. Tags: xml.sequenceOffset=90
displayFormat	DisplayFormatString	0..1	attr	This property specifies, how the physical value shall be displayed e.g. in documents or measurement and calibration tools. Tags: xml.sequenceOffset=20
unit	Unit	0..1	ref	This is the physical unit of the Physical values for which the CompuMethod applies. Tags: xml.sequenceOffset=30

Table 5.67: CompuMethod

This meta-class [CompuMethod](#) was actually taken from the *ASAM* standard's *harmonized data objects*. This is also indicated by the green color of the meta-classes in the diagram.

Some [categorys](#) of [CompuMethod](#) cannot be successfully converted to A2L [24] because A2L does not provide an equivalent semantics that comes close to the respective AUTOSAR semantics.

A prominent example for such a case is a [CompuMethod](#) of category [SCALE_LINEAR_AND_TEXTTABLE](#) that actually has more than one linear interval and a texttable part.

[constr_1142] category of CompuMethod shall not be extended [In contrast to the general rule that [category](#) can be extended by user-specific values it is **not allowed** to extend the meaning of the attribute [category](#) of meta-class [CompuMethod](#)]()

[TPS_SWCT_01277] Computation methods are used for the conversion of internal values into their physical representation and vice versa [[CompuMethods](#) are used for the conversion of *internal* values into their *physical* representation and vice versa. The direction of the conversion depends on the origin of the value to be converted:

- If the value is provided by the ECU, then the conversion direction is from internal to physical.
- If a physical value is provided by the tester, it is converted to internal values before being sent to the ECU

]()

[TPS_SWCT_01548] Limits of a CompuMethod [In case `CompuScale.lowerLimit` and `CompuScale.upperLimit` are used to constrain the applicable range of the conversion of a `CompuMethod`, they logically represent the limiting values **before** the conversion is applied.]()

In other words, the limits are applied on the source end of the conversion rather than to the result that comes out at the other end of the conversion.

This is obviously a lot safer than the opposite approach where a given physical/internal value would first be converted to its internal/physical equivalent and then, after the conversion is finished there would be (as a second step) the obligation to check whether the result of the conversion is actually valid in terms of the applicable limits.

[TPS_SWCT_01278] CompuMethods can also be used to assign symbolic names to internal values [`CompuMethods` can also be used to assign symbolic names to internal values (like an enumeration in C) or to ranges of internal values or to single bits (like a bitfield in C).

This is also considered as a conversion between internal numbers and a semantical representation. Some examples are given below.]()

Actually, the preferred conversion direction depends on the use case.

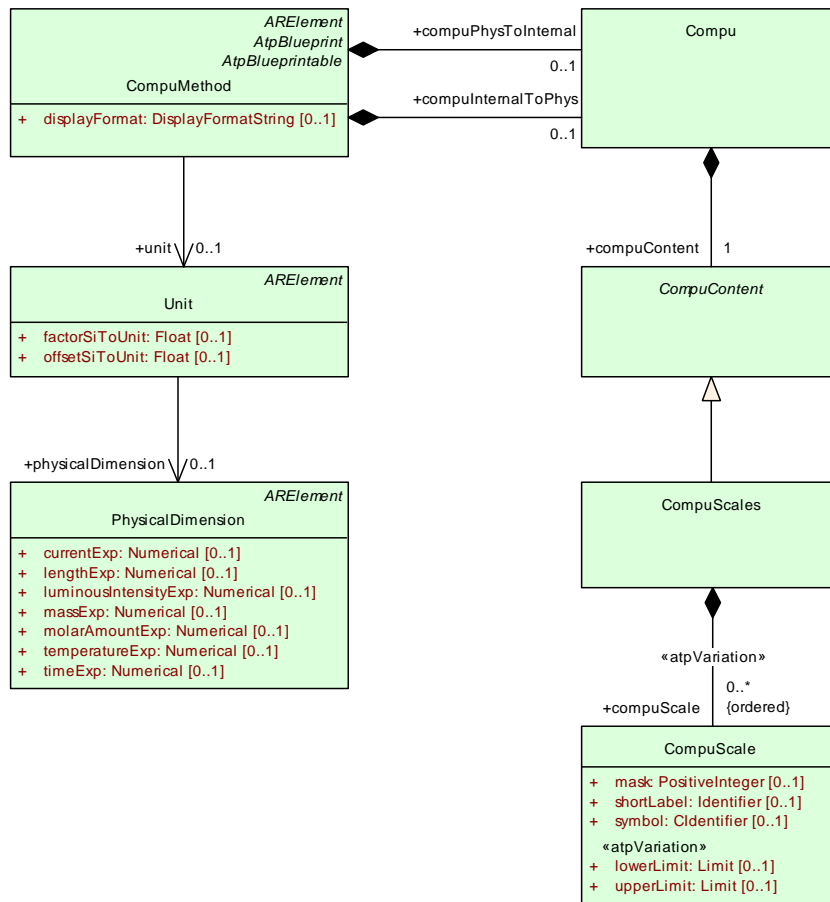

Figure 5.48: A **CompuMethod** and its attributes define data semantics

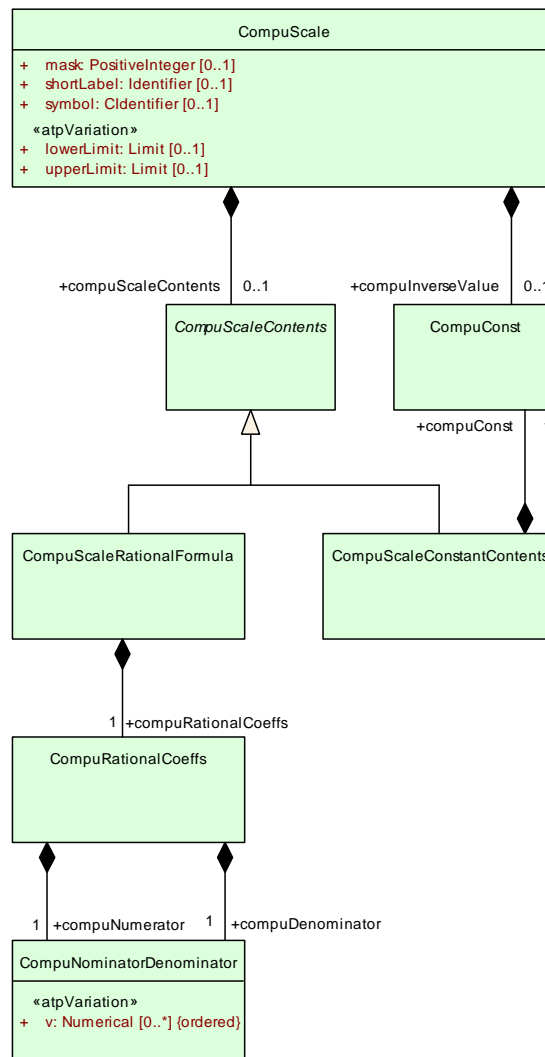

Figure 5.49: A **CompuScale and its attributes define data semantics**

In the following, the internal-to-physical conversion direction is used as the default. Usually a **CompuMethod** is defined for one conversion direction only even if it is used in both directions.

For simple functions like identical (1:1 conversion) or linear functions this is sufficient because the inverse function can be derived quite easily from the defined function. In this case also the limits for the reverse direction can be gained by applying the forward function to the forward limits.

For more complex functions (e.g. rational functions) it is usually not possible to compute the inverse function automatically. More seriously, the inversion yields ambiguous results if the function is not monotonic. To deal with such possible ambiguities directly, an inverse value can be provided explicitly for the function or for each of its parts respectively.

[constr_1022] Limits shall be defined for each direction of **CompuMethod** [In case that both domains are specified in the **CompuMethod** both shall have explicitly defined limits.]()

[TPS_SWCT_01280] CompuMethod applied to values outside of its limits [If a `CompuMethod` is applied to values outside its limits, it is up to the MCD-tool (Measurement, Calibration, Diagnostic tool) to indicate this to the user. In this case the `CompuMethod` shall not be applied at all.]()

[constr_1175] Depending on its category, CompuMethod shall refer to a unit [As a `CompuMethod` specifies the conversion between the physical world and the numerical values they shall refer to a `unit` unless the `CompuMethod`'s `category` is one of `TEXTTABLE`, `BITFIELD_TEXTTABLE`, or `IDENTICAL`.]()

[constr_1175] does *not* imply that `CompuMethods` where the `category` is one of `TEXTTABLE`, `BITFIELD_TEXTTABLE`, or `IDENTICAL` are not *allowed* to refer to a unit. They may still refer to a `unit`, but according to **[constr_1175]** this relation is not *mandated*.

A further implication is that the unit itself may not have a dimension, i.e. all exponents of SI units are 0.

Figure 5.48 sketches a conceptual overview of `CompuMethod`. It consists of the following attributes:

- **[TPS_SWCT_01281] Unit associated with a PhysicalDimension** [A unit (described in next section) can be associated with a `PhysicalDimension`.]()

Note that quantities like “%” are not derived from SI units. However, they have a meaning in the physical world and need to be represented in form of data types. Therefore, a `CompuMethod` also applies in those cases.

- **[TPS_SWCT_01430] Conversion specification from internal to physical values as well as the reverse conversion** [A conversion specification from internal to physical values, as well as the reverse conversion. Both of them in turn consist of an abstract `CompuContent`. Derived classes allow the specification of a conversion formula in two different ways.]()

[constr_1024] Stepwise definition of CompuMethods [In a bound model, the intervals (i.e. determined by attributes `CompuScale.lowerLimit` and `CompuScale.upperLimit`) defined by `CompuScales` used in the context of a given `CompuMethod` of all values of `category` except `BITFIELD_TEXTTABLE` shall **not** overlap.

For `CompuMethods` of `category` `BITFIELD_TEXTTABLE`, the combination of the interval created by attributes `CompuScale.upperLimit`, `CompuScale.lowerLimit` and `CompuScale.mask` shall be unique in the context of the enclosing `CompuMethod`.]()

The possible values of `CompuMethod.category` are listed in Table 5.78.

[TPS_SWCT_01667] Avoidance of overlapping of directly adjacent intervals within CompuMethods [Intervals of a given `CompuMethod` may be **located directly adjacent** to each other.

This means that the `upperLimit` of one `CompuScale` has the same numerical value as the `lowerLimit` of another `CompuScale` defined within the context of the `CompuMethod`.

In this case, it is necessary to properly set the attribute `CompuScale.lowerLimit.intervalType` or `CompuScale.upperLimit.intervalType` in order to avoid an overlapping.

Specifically, one of the interval boundaries shall be set to `intervalType.open` in order to avoid an overlapping.]()

- **[TPS_SWCT_01282] Number of intervals in which a given conversion applies** [`CompuScales` is a number of intervals (called `CompuScale`) within which a certain conversion applies. The respective interval is given in terms of upper and lower limit.

Within each `CompuScale` we have the abstract `CompuScaleContents`. To deal with possible ambiguities directly, an inverse value can be provided explicitly for that particular scale (`compuInverseValue`).]()

Please note that limits are explained in more detail in chapter 5.2.4.1.

- As the diagram shows, `CompuScaleContents` is an abstract meta-class. A number of derived meta-classes allow the specification of a conversion formula in a variety of ways, including:
 - mapping the whole interval to a constant (`CompuConst`)
 - providing rational coefficients of the conversion formula (`CompuRationalCoeffs`)
- **[TPS_SWCT_01283] Rational function** [The rational function is specified as rational coefficients for the numerator (`compuNumerator`) and the denominator (`compuDenominator`). `CompuNominatorDenominator` can have as many V elements as needed for the rational function.

The sequence of the values V carries the information for the exponents, that means the first V is the coefficient for x_0 , the second V is the coefficient for x_1 , etc. With this sequence the values of the exponents can be entirely represented.]()

[constr_1025] Avoid division by zero in rational formula [The rational formula shall not yield any division by zero.]()

[TPS_SWCT_01284] `CompuScale` might require a representation in the generated RTE C code [A `CompuScale` might require a representation in the generated RTE C code. For this purpose it is necessary to identify a property that controls how to symbol used for the `CompuScale` in the C code is created.

The symbol itself can be created out of different sources according to a standardized precedence schema.]()

[TPS_SWCT_01569] Definition of CompuScale Code Symbolic Name [In C code, a `CompuScale` is represented by an identifier that is, as far as AUTOSAR modeling is concerned, called a `CompuScale Symbolic Name`.

The `CompuScale Code Symbolic Name` may be taken from `CompuScale.symbol`, `CompuConstTextContent.vt`, or `CompuScale.shortLabel`. The details are explained in [TPS_SWCT_01431].]()

[TPS_SWCT_01431] Finding the symbol for the representation of a `CompuScale` with a point-range in C code [In general, the value of the attributes `symbol`, `vt`, and `shortLabel` can be taken as the source for naming the symbol that represents the `CompuScale` in the C code.

The following rule applies (lower values indicate higher priority) for all `CompuScales` with a point-range:

1. Take the value of `symbol` if this attribute exists.
2. Take the value of `vt` if it makes a valid C identifier.
3. Take the value of `shortLabel` if it exists.

Fail if none of the possible options apply.

]()

[TPS_SWCT_01695] Relation between `ValueSpecification` and the definition of `CompuScales` [In order to find a match between the content of a `ValueSpecification` and a `CompuScale` the content of the `ValueSpecification` shall be checked against the `CompuScale Value Symbolic Names` according to [TPS_SWCT_01696].

If no matching `CompuScale Value Symbolic Names` can be found then the `ValueSpecification` shall be considered unusable in the context of the `CompuMethod` that is subject to [constr_1146].]()

[TPS_SWCT_01696] `CompuScale Value Symbolic Name` [The value of the `CompuScale Value Symbolic Name` of a given `CompuScale` shall be obtained by taking the values of the following attributes according to the following priority (lower values indicate higher priority):

1. Take the value of `symbol` if this attribute exists.
2. Take the value of `vt` if this attribute exists.
3. Take the value of `shortLabel` if it exists.

]()

Just to be sure, the (obvious) difference between a `CompuScale Value Symbolic Name` and a `CompuScale Code Symbolic Name` is that the former is not required to pass as a valid C identifier.

[constr_1434] CompuScales shall not have identical CompuScale Value Symbolic Names [In a CompuMethod that is subject to [constr_1146], no two CompuScales shall have identical CompuScale Value Symbolic Names (according to [TPS_SWCT_01696]).]()

[constr_1146] Applicability of a symbol for a CompuScale in C code [The symbol attribute shall only be provided for CompuScales where the category of the enclosing CompuMethod is one of the following:

- TEXTTABLE
- SCALE_LINEAR_AND_TEXTTABLE
- SCALE_RATIONAL_AND_TEXTTABLE
- BITFIELD_TEXTTABLE

]()

Class	Compu			
Package	M2::MSR::AsamHdo::ComputationMethod			
Note	This meta-class represents the ability to express one particular computation.			
Base	ARObject			
Attribute	Type	Mult.	Kind	Note
compuContent	CompuContent	1	aggr	This specifies the details of the computation. Tags: xml.roleElement=false xml.roleWrapperElement=false xml.sequenceOffset=20 xml.typeElement=false xml.typeWrapperElement=false
compuDefault Value	CompuConst	0..1	aggr	This property can be used to specify an output value for a conversion formula, if the value to be converted lies outside the plausibility limit. Although this is possible for all conversion formulae, it is especially valid for variables with tabular conversion formulae. Tags: xml.sequenceOffset=70

Table 5.68: Compu

Class	CompuContent (abstract)			
Package	M2::MSR::AsamHdo::ComputationMethod			
Note	This abstract meta-class represents the various definition means of a computation method.			
Base	ARObject			
Subclasses	CompuScales			
Attribute	Type	Mult.	Kind	Note
–	–	–	–	–

Table 5.69: CompuContent

Class	CompuScale			
Package	M2::MSR::AsamHdo::ComputationMethod			
Note	This meta-class represents the ability to specify one segment of a segmented computation method.			
Base	ARObject			
Attribute	Type	Mult.	Kind	Note
compuInverse Value	CompuConst	0..1	aggr	This is the inverse value of the constraint. This supports the case that the scale is not reversible per se. Tags: xml.sequenceOffset=60
compuScale Contents	CompuScaleContents	0..1	aggr	This represents the computation details of the scale. Tags: xml.roleElement=false xml.roleWrapperElement=false xml.sequenceOffset=70 xml.typeElement=false xml.typeWrapperElement=false
desc	MultiLanguageOverview Paragraph	0..1	aggr	<desc> represents a general but brief description of the object in question. Tags: xml.sequenceOffset=30
lowerLimit	Limit	0..1	attr	This specifies the lower limit of the scale. Stereotypes: atpVariation Tags: vh.latestBindingTime=preCompileTime xml.sequenceOffset=40
mask	PositiveInteger	0..1	attr	In difference to all the other computational methods every COMPU-SCALE will be applied including the bit MASK. Therefore it is allowed for this type of COMPU-METHOD, that COMPU-SCALES overlap. To calculate the string reverse to a value, the string has to be split and the according value for each substring has to be summed up. The sum is finally transmitted. The processing has to be done in order of the COMPU-SCALE elements. Tags: xml.sequenceOffset=35
shortLabel	Identifier	0..1	attr	This element specifies a short name for the particular scale. The name can for example be used to derive a programming language identifier. Tags: xml.sequenceOffset=20
symbol	CIdentifier	0..1	attr	The symbol, if provided, is used by code generators to get a C identifier for the CompuScale. The name will be used as is for the code generation, therefore it needs to be unique within the generation context. Tags: xml.sequenceOffset=25
upperLimit	Limit	0..1	attr	This specifies the upper limit of a of the scale. Stereotypes: atpVariation Tags: vh.latestBindingTime=preCompileTime xml.sequenceOffset=50

Table 5.70: CompuScale

Class	CompuScales			
Package	M2::MSR::AsamHdo::ComputationMethod			
Note	This meta-class represents the ability to stepwise express a computation method.			
Base	<i>ARObject</i> , <i>CompuContent</i>			
Attribute	Type	Mult.	Kind	Note
compuScale (ordered)	CompuScale	*	aggr	This represents one scale within the compu method. Note that it contains a Variationpoint in order to support blueprints of enumerations. Stereotypes: atpVariation Tags: vh.latestBindingTime=blueprintDerivationTime xml.roleElement=true xml.roleWrapperElement=true xml.sequenceOffset=40 xml.typeElement=false xml.typeWrapperElement=false

Table 5.71: CompuScales

Class	CompuScaleContents (abstract)			
Package	M2::MSR::AsamHdo::ComputationMethod			
Note	This abstract meta-class represents the content of one particular scale.			
Base	<i>ARObject</i>			
Subclasses	CompuScaleConstantContents , CompuScaleRationalFormula			
Attribute	Type	Mult.	Kind	Note
–	–	–	–	–

Table 5.72: CompuScaleContents

Class	CompuRationalCoeffs			
Package	M2::MSR::AsamHdo::ComputationMethod			
Note	This meta-class represents the ability to express a rational function by specifying the coefficients of nominator and denominator.			
Base	<i>ARObject</i>			
Attribute	Type	Mult.	Kind	Note
compu Denominator	CompuNominator Denominator	1	aggr	This is the denominator of the expression. Tags: xml.sequenceOffset=30
compu Numerator	CompuNominator Denominator	1	aggr	This is the numerator of the rational expression. Tags: xml.sequenceOffset=20

Table 5.73: CompuRationalCoeffs

Class	CompuConst			
Package	M2::MSR::AsamHdo::ComputationMethod			
Note	This meta-class represents the fact that the value of a computation method scale is constant.			
Base	<i>ARObject</i>			





Class		CompuConst		
Attribute	Type	Mult.	Kind	Note
compuConstContent Type	CompuConstContent	1	aggr	This is the actual content of the constant compu method scale. Tags: xml.roleElement=false xml.roleWrapperElement=false xml.sequenceOffset=10 xml.typeElement=false xml.typeWrapperElement=false

Table 5.74: CompuConst

Class		CompuScaleRationalFormula		
Package	M2::MSR::AsamHdo::ComputationMethod			
Note	This meta-class represents the fact that the computation in this scale is represented as rational term.			
Base	ARObject, CompuScaleContents			
Attribute	Type	Mult.	Kind	Note
compuRationalCoeffs	CompuRationalCoeffs	1	aggr	This specifies the coefficients of the rational formula. Tags: xml.sequenceOffset=110

Table 5.75: CompuScaleRationalFormula

Class		CompuScaleConstantContents		
Package	M2::MSR::AsamHdo::ComputationMethod			
Note	This meta-class represents the fact that a particular scale of the computation method is constant.			
Base	ARObject, CompuScaleContents			
Attribute	Type	Mult.	Kind	Note
compuConst	CompuConst	1	aggr	This represents the fact that the scale is a constant. The use case is mainly a non interpolated scale. It is a simplification of the fact that a constant scale can also be expressed as Rational Function of order 0. Tags: xml.sequenceOffset=90

Table 5.76: CompuScaleConstantContents

Class		CompuNominatorDenominator		
Package	M2::MSR::AsamHdo::ComputationMethod			
Note	This class represents the ability to express a polynomial either as Nominator or as Denominator.			
Base	ARObject			
Attribute	Type	Mult.	Kind	Note





Class	CompuNominatorDenominator			
v (ordered)	Numerical	*	attr	this is the list of polynomial factors. Note that the first v represents the power=0. The polynomial is $v[0] * x^0 + v[1] * x^1 \dots$ Stereotypes: atpVariation Tags: vh.latestBindingTime=preCompileTime xml.roleElement=true xml.roleWrapperElement=false xml.sequenceOffset=20 xml.typeElement=false xml.typeWrapperElement=false

Table 5.77: CompuNominatorDenominator

Please note that the values of coefficients within a rational formula are **not restricted** to integer values. It is possible to use floating-point values as well.

The values of exponents **cannot be set arbitrarily** but are implicitly defined by the appearance of coefficients in `CompuNominatorDenominator.v`, i.e. the first value in the ordered list of `CompuNominatorDenominator.v` represents the exponent 0, the second `CompuNominatorDenominator.v` represents the exponent 1, and so on.

5.5.1.1 Category Values in the context of a CompuMethod

For a detailed description of `CompuMethods`, please refer to the *ASAM MCD 2 Harmonized Data Objects* [25].

Table 5.78 contains a definition of possible values for the attribute `category`.

ASAM Category	Meaning	Specific properties
IDENTICAL	This <code>CompuMethod</code> just hands over the internal value with an optional unit.	Only the base elements are allowed and <code>unit</code> , <code>physConstrs</code> and <code>internalConstrs</code> are optional. This is the simplest type of a <code>CompuMethod</code> .
LINEAR	A linear conversion can be performed in two steps: The internal value is multiplied with a factor; after that, an offset is added to the result of the multiplication.	Exactly one <code>CompuScale</code> , with two <code>v</code> in <code>compuNumerator</code> and one <code>v</code> in <code>compuDenominator</code> .
SCALE_LINEAR	Used for a piecewise linear conversion.	More than one <code>compuScale</code> can be defined. Additionally there have to be the <code>upperLimit</code> and <code>lowerLimit</code> elements which define the region of validity for the linear function. The boundaries of the regions shall not overlap.
SCALE_LINEAR_AND_TEXTTABLE	Used for piecewise definition of one or more linear and several texttable scales.	Properties depend on the used scale function. For details see definition of <code>SCALE_LINEAR</code> and <code>TEXTTABLE</code> . The scales shall each provide <code>lowerLimit</code> and <code>upperLimit</code> definitions.





ASAM Category	Meaning	Specific properties
RAT_FUNC	The rational function type is similar to the linear type without the restrictions for the <code>compuNumerators</code> and <code>compuDenominators</code> .	It can have as many <code>v</code> elements as needed for the rational function. The sequence of the values <code>v</code> carries the information for the exponents, that means the first <code>v</code> is the coefficient for <code>x0</code> , the second <code>v</code> is the coefficient for <code>x1</code> , etc. With this sequence the values of the exponents can be entirely represented. A rational function is only applicable for conversions in the direction that it is defined for, i.e. the automatic calculation of the inverse function is not supported by the MCD system.
SCALE_RAT_FUNC	Used for piecewise defined rational conversion.	
SCALE_RATIONAL_AND_TEXTTABLE	Used for piecewise definition of one rational and several texttable scales.	Properties depend on the used scale function. For details see definition of <code>SCALE_RAT_FUNC</code> and <code>TEXTTABLE</code> . The scales shall each provide <code>lowerLimit</code> and <code>upperLimit</code> definitions.
TEXTTABLE	The type <code>TEXTTABLE</code> is used for transformations of the internal value into textual elements.	The result is placed in the <code>vt</code> member of <code>CompuConst</code> . The <code>compuDefaultValue</code> is optional. If the reverse calculation is needed then for each scale the <code>compuInverseValue</code> can be used to define the reverse calculation result. If no inverse value is explicitly defined then the smallest possible value of the scale will be used as result of the reverse calculation. [constr_1134] applies!
TAB_NOINTP	Similar to <code>TEXTTABLE</code> , but for numerical values.	The values per scale are defined in <code>CompuConst</code> .
BITFIELD_TEXTTABLE	Similar to <code>TEXTTABLE</code> but for bit fields.	<code>BITFIELD_TEXTTABLE</code> is derived from <code>TEXTTABLE</code> . The main difference is that <code>TEXTTABLE</code> results to a single value while <code>BITFIELD_TEXTTABLE</code> results to a concatenated value set. In difference to all the other computational methods every <code>CompuScale</code> will be applied including the bit mask specified in <code>mask</code> . Therefore it is allowed for this type of <code>CompuMethod</code> , that <code>CompuScales</code> overlap. To calculate the string reverse to a value, the string has to be split and the according value for each substring has to be summed up. The sum is finally transmitted. The processing has to be done in order of the <code>CompuScale</code> elements. [constr_1135] applies!

Table 5.78: ASAM compuMethod

[constr_1134] Allowed structure of `TEXTTABLE` [`physConstrs` is not allowed. `compuInternalToPhys` shall exist with `compuScales` consisting of `upperLimit` and `lowerLimit`.]()

[constr_1135] Limit of `vt` in `BITFIELD_TEXTTABLE` [The separator is “|” and is forbidden in `vt` therefore.]()

5.5.1.2 Applicability of Attributes in the context of a CompuMethod

This section summarizes the applicability of `CompuMethod` in terms of which attributes of `CompuMethod` and related meta-classes (e.g. `CompuScale`, `CompuConst`) shall

be used depending on the nature of the `CompuMethod`, expressed by means of the value of attribute `category`.

[constr_1375] Existence of attributes of `CompuMethod` and related meta-classes
 [The existence of attributes of `CompuMethod` and related meta-classes depending on the value of the `category` shall follow the restrictions documented in Table 5.79.]()

	Attribute Existence per Category									
	IDENTICAL	LINEAR	SCALE_LINEAR	RAT_FUNC	SCALE_RAT_FUNC	TEXTTABLE	BITFIELD_TEXTTABLE	SCALE_LINEAR_AND_TEXTTABLE	SCALE_RATIONAL_AND_TEXTTABLE	TAB_NOINTP
Attributes of <code>CompuMethod</code>										
<code>compuInternalToPhys</code>	N/A	D(1)	D(1)	D(2)	D(2)	D	D	D(8)	D(2)	D
<code>compuPhysToInternal</code>	N/A	D(1)	D(1)	D(2)	D(2)	N/A	N/A	N/A	D(2,3)	N/A
Attributes of meta-classes related to <code>CompuMethod</code>										
<code>compuDefaultValue</code>	N/A	O(6)	O(6)	O(6)	O(6)	O(6)	O(6)	O(6)	O(6)	O(6)
<code>CompuScale</code>	N/A	D/1..1	D/1..n	D/1..1	D/1..n	D/1..n	D/1..n	D/1..n	D/1..n	D/1..n
<code>CompuScale.compuInverseValue</code>	N/A	N/A	N/A	O(2)	O(2)	O(5)	N/A	O(2,5)	O(2,5)	O(5)
<code>CompuScale.lowerLimit</code>	N/A	O	D	D(4)	D(4)	D	D	D	D(4)	D
<code>CompuScale.mask</code>	N/A	N/A	N/A	N/A	N/A	N/A	D	N/A	N/A	N/A
<code>CompuScale.shortLabel</code>	N/A	N/A	N/A	N/A	N/A	O(7)	O(7)	O(7)	O(7)	N/A
<code>CompuScale.symbol</code>	N/A	N/A	N/A	N/A	N/A	O(7)	O(7)	O(7)	O(7)	N/A
<code>CompuScale.upperLimit</code>	N/A	O	D	D(4)	D(4)	D	D	D	D(4)	D
<code>CompuConst</code>	N/A	N/A	N/A	N/A	N/A	D/vt	D/vt	D/vt	D/vt	D/vt or vf
<code>CompuRationalCoeffs</code>	N/A	D	D	D	D	N/A	N/A	D	D	N/A
<code>CompuRationalCoeffs.compuDenominator</code>	N/A	D/1v	D/1v	D	D	N/A	N/A	D/1v	D	N/A
<code>CompuRationalCoeffs.compuNumerator</code>	N/A	D/2v	D/2v	D	D	N/A	N/A	D/2v	D	N/A

Table 5.79: Allowed Attributes vs. `category` for `CompuMethods`

For clarification, the first two rows of Table 5.79 define the applicability of the immediate attributes of meta-class `CompuMethod`, the remainder of the table then goes into further detail regarding the usage of the attributes of related meta-classes (e.g. `CompuScale`, `CompuConst`).

Please note that annotations apply to the individual cell values. These annotations are formulated by means of a numerical value in parentheses, e.g. (1).

The legend for the individual annotations can be found below Table 5.79.

The following legend applies to the cells in table 5.79:

D Define the attribute.

N/A Attribute is **not applicable** for usage in the scope of this element.

O **Optionally** define the attribute.

In addition to the primary cell legend the following annotations apply to the cells in table 5.79:

- (1) In this case **either** `compuPhysToInternal` **or** `compuInternalToPhys` shall be defined.
- (2) In this case both `compuPhysToInternal` and `compuInternalToPhys` shall be defined unless `compuInverseValue` exists (see [TPS_SWCT_01282]). In other words, if the explicit definition of a `compuInverseValue` exists then there is no need to define conversions from internal to physical **and** vice versa.
- (3) Not applicable for `CompuScales` where attribute `compuScaleContents.compuConst` exists.
- (4) Limits shall be defined according to [constr_1022].
- (5) Restrictions on the structure of the `CompuMethod` according to [constr_1134] apply.
- (6) Specify an output value for a conversion formula if the value to be converted yields outside the plausibility limit (for more information, please refer to the class table of `Compu`).
- (7) Restricted applicability for the attribute `CompuScale.symbol`, see [constr_1146].
- (8) Mandatory for `CompuConst`; enforced for `CompuRationalCoeffs`.

5.5.1.3 CompuMethod and AutosarDataType

This chapter clarifies the applicability of `CompuMethod` for the relevant concrete sub-classes of `AutosarDataType`.

5.5.1.3.1 CompuMethod and ApplicationDataType

For `ApplicationDataType`, there are (see Table 5.7) a number values of `category` that allow for the definition of a `ApplicationDataType.swDataDefProps.compuMethod`.

Table 5.80 visualizes the allowed combinations of `ApplicationDataType.category` vs. `CompuMethod.category`.

	IDENTICAL	LINEAR	SCALE_LINEAR	SCALE_LINEAR_AND_TEXTTABLE	RAT_FUNC	SCALE_RATIONAL_AND_TEXTTABLE	TEXTTABLE	TAB_NOINTP	BITFIELD_TEXTTABLE
VALUE	x	x	x	x	x	x	x	x	x
VAL_BLK	x	x	x	x	x	x	x	x	x
BOOLEAN	n/a	n/a	n/a	n/a	n/a	n/a	x	n/a	n/a
CURVE	x	x	x	x	x	x	x	x	x
MAP	x	x	x	x	x	x	x	x	x
CUBOID	x	x	x	x	x	x	x	x	x
CUBE_4	x	x	x	x	x	x	x	x	x
CUBE_5	x	x	x	x	x	x	x	x	x

Table 5.80: ApplicationDataType.category vs. CompuMethod.category

The rows of Table 5.80 represent values of `category` for `ApplicationDataType` that are cleared for the definition of a `CompuMethod` according to Table 5.7.

The columns of Table 5.80 represent values of `category` for `CompuMethod`.

[constr_1634] Allowed combinations of ApplicationDataType.category vs. CompuMethod.category [the allowed combinations of `ApplicationDataType.category` vs. `CompuMethod.category` are described by Table 5.80.]()

5.5.1.3.2 CompuMethod and ImplementationDataType

For `ImplementationDataType`, there are (see Table 5.17) only two values of `category` that allow for the definition of a `ImplementationDataType.swDataDefProps.compuMethod`: `TEXTTABLE` and `BITFIELD_TEXTTABLE`.

[constr_1158] Applicable categories for attribute ImplementationDataType.swDataDefProps.compuMethod [The definition of the reference `ImplementationDataType.swDataDefProps.compuMethod` is restricted to a `CompuMethod` of either `category BITFIELD_TEXTTABLE` or `category TEXTTABLE` (these might be seen as implementation specific in certain cases).]()

The statement made by [constr_1158] is further visualized by Table 5.81.

	IDENTICAL	LINEAR	SCALE_LINEAR	SCALE_LINEAR_AND_TEXTTABLE	RAT_FUNC	SCALE_RATIONAL_AND_TEXTTABLE	TEXTTABLE	TAB_NOINTP	BITFIELD_TEXTTABLE
VALUE	n/a	n/a	n/a	n/a	n/a	n/a	x	n/a	x
TYPE_REFERENCE	n/a	n/a	n/a	n/a	n/a	n/a	x	n/a	x

Table 5.81: ImplementationDataType.category vs. CompuMethod.category

The rows of Table 5.81 represent values of `category` for `ImplementationDataType` that are cleared for the definition of a `CompuMethod` according to Table 5.17.

The columns of Table 5.81 represent values of `category` for `CompuMethod`.

5.5.1.4 Example for Enumeration

The following example illustrates how an enumeration is specified using `CompuMethod`.

Listing 5.10: example for enumeration

```

<COMPU-METHOD>
  <SHORT-NAME>boolean</SHORT-NAME>
  <CATEGORY>TEXTTABLE</CATEGORY>
  <COMPU-INTERNAL-TO-PHYS>
    <COMPU-SCALES>
      <COMPU-SCALE>
        <LOWER-LIMIT INTERVAL-TYPE="CLOSED">0</LOWER-LIMIT>
        <UPPER-LIMIT INTERVAL-TYPE="CLOSED">0</UPPER-LIMIT>
        <COMPU-CONST>
          <VT>>false</VT>
        </COMPU-CONST>
      </COMPU-SCALE>
      <COMPU-SCALE>
        <LOWER-LIMIT INTERVAL-TYPE="CLOSED">1</LOWER-LIMIT>
        <UPPER-LIMIT INTERVAL-TYPE="CLOSED">1</UPPER-LIMIT>
        <COMPU-CONST>
          <VT>>true</VT>
        </COMPU-CONST>
      </COMPU-SCALE>
    </COMPU-SCALES>
  </COMPU-INTERNAL-TO-PHYS>
</COMPU-METHOD>
    
```

5.5.1.5 Example for Linear Conversion

The following examples illustrate how a linear conversion is specified using `CompuMethod`.

$$F_{[kmh]} = 30_{[kmh]} + 2_{[kmh]} * x$$

Listing 5.11: example for linear `CompuMethod`

```

<COMPU-METHOD>
  <SHORT-NAME>linear</SHORT-NAME>
  <CATEGORY>LINEAR</CATEGORY>
  <UNIT-REF DEST="UNIT">kmh</UNIT-REF>
  <COMPU-INTERNAL-TO-PHYS>
    <COMPU-SCALES>
      <COMPU-SCALE>
        <COMPU-RATIONAL-COEFFS>
          <COMPU-NUMERATOR>
            <V>30</V>
            <V>2</V>
          </COMPU-NUMERATOR>
          <COMPU-DENOMINATOR>
            <V>1</V>
          </COMPU-DENOMINATOR>
        </COMPU-RATIONAL-COEFFS>
      </COMPU-SCALE>
    </COMPU-SCALES>
  </COMPU-INTERNAL-TO-PHYS>
</COMPU-METHOD>
    
```

5.5.1.6 Example for Linear Conversion with texttable

The following example illustrates how a linear conversion with a texttable is specified using `CompuMethod`.

Listing 5.12: example for linear and texttable `CompuMethod`

```

<COMPU-METHOD>
  <SHORT-NAME>linearAndTexttable</SHORT-NAME>
  <CATEGORY>SCALE_LINEAR_AND_TEXTTABLE</CATEGORY>
  <UNIT-REF DEST="UNIT">kmh</UNIT-REF>
  <COMPU-INTERNAL-TO-PHYS>
    <COMPU-SCALES>
      <COMPU-SCALE>
        <LOWER-LIMIT INTERVAL-TYPE="CLOSED">0</LOWER-LIMIT>
        <UPPER-LIMIT INTERVAL-TYPE="CLOSED">300</UPPER-LIMIT>
        <COMPU-RATIONAL-COEFFS>
          <COMPU-NUMERATOR>
            <V>30</V>
            <V>2</V>
          </COMPU-NUMERATOR>
          <COMPU-DENOMINATOR>
            <V>1</V>
          </COMPU-DENOMINATOR>
        </COMPU-RATIONAL-COEFFS>
      </COMPU-SCALE>
    </COMPU-SCALES>
  </COMPU-INTERNAL-TO-PHYS>
</COMPU-METHOD>
    
```

```

        <V>1</V>
    </COMPU-DENOMINATOR>
</COMPU-RATIONAL-COEFFS>
</COMPU-SCALE>
<COMPU-SCALE>
    <LOWER-LIMIT INTERVAL-TYPE="CLOSED">350</LOWER-LIMIT>
    <UPPER-LIMIT INTERVAL-TYPE="CLOSED">350</UPPER-LIMIT>
    <COMPU-CONST>
        <VT>SensorError</VT>
    </COMPU-CONST>
</COMPU-SCALE>
<COMPU-SCALE>
    <LOWER-LIMIT INTERVAL-TYPE="CLOSED">351</LOWER-LIMIT>
    <UPPER-LIMIT INTERVAL-TYPE="CLOSED">351</UPPER-LIMIT>
    <COMPU-CONST>
        <VT>SignalNotAvailable</VT>
    </COMPU-CONST>
</COMPU-SCALE>
</COMPU-SCALES>
</COMPU-INTERNAL-TO-PHYS>
</COMPU-METHOD>
    
```

5.5.1.7 Example for conversion specified by a rational function

The semantics of rational function is:

$$Internal = \frac{v_0 * phys^0 + v_1 * phys^1 + v_2 * phys^2 + \dots}{v_0 * phys^0 + v_1 * phys^1 + v_2 * phys^2 + \dots}$$

The following example illustrates a reciprocal conversion.

$$I = \frac{1000}{60 + 2_{[K-1]} * P_{[K]}}$$

Listing 5.13: example for rational [CompuMethod](#)

```

<COMPU-METHOD>
    <SHORT-NAME>rational</SHORT-NAME>
    <CATEGORY>RAT_FUNC</CATEGORY>
    <UNIT-REF DEST="UNIT">Kelvin</UNIT-REF>
    <COMPU-PHYS-TO-INTERNAL>
        <COMPU-SCALES>
            <COMPU-SCALE>
                <LOWER-LIMIT INTERVAL-TYPE="CLOSED">-29</LOWER-LIMIT>
                <UPPER-LIMIT INTERVAL-TYPE="OPEN">INF</UPPER-LIMIT>
            </COMPU-SCALE>
            <COMPU-RATIONAL-COEFFS>
                <COMPU-NUMERATOR>
                    <V>1000</V>
                </COMPU-NUMERATOR>
                <COMPU-DENOMINATOR>
                    <V>60</V>
            </COMPU-RATIONAL-COEFFS>
        </COMPU-SCALES>
    </COMPU-PHYS-TO-INTERNAL>
</COMPU-METHOD>
    
```

```

    <V>2</V>
  </COMPU-DENOMINATOR>
</COMPU-RATIONAL-COEFFS>
</COMPU-SCALE>
</COMPU-SCALES>
</COMPU-PHYS-TO-INTERNAL>
</COMPU-METHOD>

```

5.5.1.8 Example for BITFIELD_TEXTTABLE

The following example shows how a `CompuMethod` of category `BITFIELD_TEXTTABLE` can be used to assign a special meaning to each bit of an `AutosarDataType` of category `VALUE`:

Bit 0	front left	0(0) = no, 1(1) = yes
Bit 1	front right	0(0) = no, 1(2) = yes
Bit 2	rear left	0(0) = no, 1(4) = yes
Bit 3	rear right	0(0) = no, 1(8) = yes
Bit 4-5	problem	00(00) = flat tire 01(16) = low pressure 10(32) = unbalanced 11(48) = unknown
All Bits	error	11111111 = invalid value

Table 5.82: Example Bitfield

Note that this example is somehow tricky. Bit 6+7 are not used for valid data, but are part of the mask. By this the error can safely be masked out.

Internal: 28

```

28 = 0b0001_1100
Bit   7654 3210

```

Physical:

“problem = low pressure | rear right = yes | rear left = yes | front right = no | front left = no”

Listing 5.14: example for bit field text table `CompuMethod`

```

<COMPU-METHOD>
  <SHORT-NAME>Texttable</SHORT-NAME>
  <CATEGORY>BITFIELD_TEXTTABLE</CATEGORY>
  <COMPU-INTERNAL-TO-PHYS>
    <COMPU-SCALES>
      <!-- problem -->
    <COMPU-SCALE>
      <SHORT-LABEL>problem</SHORT-LABEL>
      <SYMBOL>problem_flat_tire</SYMBOL>
      <MASK>0b11110000</MASK>
      <LOWER-LIMIT INTERVAL-TYPE="CLOSED">0b00000000</LOWER-LIMIT>
      <UPPER-LIMIT INTERVAL-TYPE="CLOSED">0b00000000</UPPER-LIMIT>

```

```

    <COMPU-CONST>
      <VT>flat tire</VT>
    </COMPU-CONST>
  </COMPU-SCALE>
</COMPU-SCALE>
<COMPU-SCALE>
  <SHORT-LABEL>problem</SHORT-LABEL>
  <SYMBOL>problem_low_pressure</SYMBOL>
  <MASK>0b11110000</MASK>
  <LOWER-LIMIT INTERVAL-TYPE="CLOSED">0b00010000</LOWER-LIMIT>
  <UPPER-LIMIT INTERVAL-TYPE="CLOSED">0b00010000</UPPER-LIMIT>
  <COMPU-CONST>
    <VT>low pressure</VT>
  </COMPU-CONST>
</COMPU-SCALE>
<COMPU-SCALE>
  <SHORT-LABEL>problem</SHORT-LABEL>
  <SYMBOL>problem_unbalanced</SYMBOL>
  <MASK>0b11110000</MASK>
  <LOWER-LIMIT INTERVAL-TYPE="CLOSED">0b00100000</LOWER-LIMIT>
  <UPPER-LIMIT INTERVAL-TYPE="CLOSED">0b00100000</UPPER-LIMIT>
  <COMPU-CONST>
    <VT>unbalanced</VT>
  </COMPU-CONST>
</COMPU-SCALE>
<COMPU-SCALE>
  <SHORT-LABEL>problem</SHORT-LABEL>
  <SYMBOL>problem_unknown</SYMBOL>
  <MASK>0b11110000</MASK>
  <LOWER-LIMIT INTERVAL-TYPE="CLOSED">0b00110000</LOWER-LIMIT>
  <UPPER-LIMIT INTERVAL-TYPE="CLOSED">0b00110000</UPPER-LIMIT>
  <COMPU-CONST>
    <VT>unknown</VT>
  </COMPU-CONST>
</COMPU-SCALE>
<COMPU-SCALE>
  <SHORT-LABEL>problem</SHORT-LABEL>
  <SYMBOL>problem_invalid</SYMBOL>
  <MASK>0b11110000</MASK>
  <LOWER-LIMIT INTERVAL-TYPE="CLOSED">0b11110000</LOWER-LIMIT>
  <UPPER-LIMIT INTERVAL-TYPE="CLOSED">0b11110000</UPPER-LIMIT>
  <COMPU-CONST>
    <VT>invalid</VT>
  </COMPU-CONST>
</COMPU-SCALE>
<!-- rear right -->
<COMPU-SCALE>
  <SHORT-LABEL>rearRight</SHORT-LABEL>
  <SYMBOL>rearRight_no</SYMBOL>
  <MASK>0b11001000</MASK>
  <LOWER-LIMIT INTERVAL-TYPE="CLOSED">0b00000000</LOWER-LIMIT>
  <UPPER-LIMIT INTERVAL-TYPE="CLOSED">0b00000000</UPPER-LIMIT>
  <COMPU-CONST>
    <VT>no</VT>
  </COMPU-CONST>
</COMPU-SCALE>
</COMPU-SCALE>

```

```

<SHORT-LABEL>rearRight</SHORT-LABEL>
<SYMBOL>rearRight_yes</SYMBOL>
<MASK>0b11001000</MASK>
<LOWER-LIMIT INTERVAL-TYPE="CLOSED">0b00001000</LOWER-LIMIT>
<UPPER-LIMIT INTERVAL-TYPE="CLOSED">0b00001000</UPPER-LIMIT>
<COMPU-CONST>
  <VT>yes</VT>
</COMPU-CONST>
</COMPU-SCALE>
<!-- rear left -->
<COMPU-SCALE>
  <SHORT-LABEL>rearLeft</SHORT-LABEL>
  <SYMBOL>rearLeft_no</SYMBOL>
  <MASK>0b11000100</MASK>
  <LOWER-LIMIT INTERVAL-TYPE="CLOSED">0b00000000</LOWER-LIMIT>
  <UPPER-LIMIT INTERVAL-TYPE="CLOSED">0b00000000</UPPER-LIMIT>
  <COMPU-CONST>
    <VT>no</VT>
  </COMPU-CONST>
</COMPU-SCALE>
<COMPU-SCALE>
  <SHORT-LABEL>rearLeft</SHORT-LABEL>
  <SYMBOL>rearLeft_yes</SYMBOL>
  <MASK>0b11000100</MASK>
  <LOWER-LIMIT INTERVAL-TYPE="CLOSED">0b00000100</LOWER-LIMIT>
  <UPPER-LIMIT INTERVAL-TYPE="CLOSED">0b00000100</UPPER-LIMIT>
  <COMPU-CONST>
    <VT>yes</VT>
  </COMPU-CONST>
</COMPU-SCALE>
<!-- front right -->
<COMPU-SCALE>
  <SHORT-LABEL>frontRight</SHORT-LABEL>
  <SYMBOL>frontRight_no</SYMBOL>
  <MASK>0b11000010</MASK>
  <LOWER-LIMIT INTERVAL-TYPE="CLOSED">0b00000000</LOWER-LIMIT>
  <UPPER-LIMIT INTERVAL-TYPE="CLOSED">0b00000000</UPPER-LIMIT>
  <COMPU-CONST>
    <VT>no</VT>
  </COMPU-CONST>
</COMPU-SCALE>
<COMPU-SCALE>
  <SHORT-LABEL>frontRight</SHORT-LABEL>
  <SYMBOL>frontRight_yes</SYMBOL>
  <MASK>0b11000010</MASK>
  <LOWER-LIMIT INTERVAL-TYPE="CLOSED">0b00000010</LOWER-LIMIT>
  <UPPER-LIMIT INTERVAL-TYPE="CLOSED">0b00000010</UPPER-LIMIT>
  <COMPU-CONST>
    <VT>yes</VT>
  </COMPU-CONST>
</COMPU-SCALE>
<!-- front left -->
<COMPU-SCALE>
  <SHORT-LABEL>frontLeft</SHORT-LABEL>
  <SYMBOL>frontLeft_no</SYMBOL>
  <MASK>0b11000001</MASK>

```

```

<LOWER-LIMIT INTERVAL-TYPE="CLOSED">0b00000000</LOWER-LIMIT>
<UPPER-LIMIT INTERVAL-TYPE="CLOSED">0b00000000</UPPER-LIMIT>
<COMPU-CONST>
  <VT>no</VT>
</COMPU-CONST>
</COMPU-SCALE>
<COMPU-SCALE>
  <SHORT-LABEL>frontLeft</SHORT-LABEL>
  <SYMBOL>frontLeft_yes</SYMBOL>
  <MASK>0b11000001</MASK>
  <LOWER-LIMIT INTERVAL-TYPE="CLOSED">0b00000001</LOWER-LIMIT>
  <UPPER-LIMIT INTERVAL-TYPE="CLOSED">0b00000001</UPPER-LIMIT>
  <COMPU-CONST>
    <VT>yes</VT>
  </COMPU-CONST>
</COMPU-SCALE>
</COMPU-SCALES>
</COMPU-INTERNAL-TO-PHYS>
</COMPU-METHOD>

```

Class	CompuConstTextContent			
Package	M2::MSR::AsamHdo::ComputationMethod			
Note	This meta-class represents the textual content of a scale.			
Base	<i>ARObject, CompuConstContent</i>			
Attribute	Type	Mult.	Kind	Note
vt	VerbatimString	1	attr	This represents a textual constant in the computation method.

Table 5.83: CompuConstTextContent

Class	CompuConstNumericContent			
Package	M2::MSR::AsamHdo::ComputationMethod			
Note	This meta-class represents the fact that the constant value of the computation method is a numerical value. It is separated from CompuConstFormulaContent to support compatibility with ASAM HDO.			
Base	<i>ARObject, CompuConstContent</i>			
Attribute	Type	Mult.	Kind	Note
v	Numerical	1	attr	This represents the numerical value. Tags: xml.sequenceOffset=50

Table 5.84: CompuConstNumericContent

5.5.2 Physical Units, Physical Dimensions and Unit Groups

[TPS_SWCT_01285] Physical dimension [Another important part of the semantics associated with a data type is its physical dimension. Units are used to augment the value with additional information like *m/s* or *liter*. This is necessary for a correct interpretation of the physical value for input and output processes.

The conversion of values into other units like *km/h* into *miles/h* is also possible. Therefore, the unit involves information about its physical dimensions.]()

[TPS_SWCT_01056] Physical dimension [The substructure of physical dimensions defines all used quantities in the SI-System¹⁹ (e.g. velocity as length/time corresponds to m/s).]([RS_SWCT_02100](#))

[TPS_SWCT_01057] Unit references one physical dimension [The unit references one physical dimension. If the physical dimensions of two units are identical, a conversion between them is basically possible.]([RS_SWCT_02100](#))

Class	Unit			
Package	M2::MSR::AsamHdo::Units			
Note	<p>This is a physical measurement unit. All units that might be defined should stem from SI units. In order to convert one unit into another factor and offset are defined.</p> <p>For the calculation from SI-unit to the defined unit the factor (factorSiToUnit) and the offset (offsetSiToUnit) are applied as follows: $x \text{ [unit]} := y * \text{[siUnit]} * \text{factorSiToUnit} \left[\frac{\text{[unit]}}{\text{[siUnit]}} \right] + \text{offsetSiToUnit} \text{ [unit]}$</p> <p>For the calculation from a unit to SI-unit the reciprocal of the factor (factorSiToUnit) and the negation of the offset (offsetSiToUnit) are applied. $y \text{ [siUnit]} := (x * \text{[unit]} - \text{offsetSiToUnit} \text{ [unit]}) / \text{factorSiToUnit} \left[\frac{\text{[unit]}}{\text{[siUnit]}} \right]$</p> <p>Tags:atp.recommendedPackage=Units</p>			
Base	ARElement , ARObject , CollectableElement , Identifiable , MultilanguageReferrable , PackageableElement , Referrable			
Attribute	Type	Mult.	Kind	Note
displayName	SingleLanguageUnitNames	0..1	aggr	<p>This specifies how the unit shall be displayed in documents or in user interfaces of tools. The displayName corresponds to the Unit.Display in an ASAM MCD-2MC file.</p> <p>Tags:xml.sequenceOffset=20</p>
factorSiToUnit	Float	0..1	attr	<p>This is the factor for the conversion from SI Units to units. The inverse is used for conversion from units to SI Units.</p> <p>Tags:xml.sequenceOffset=30</p>
offsetSiToUnit	Float	0..1	attr	<p>This is the offset for the conversion from and to siUnits.</p> <p>Tags:xml.sequenceOffset=40</p>
physicalDimension	PhysicalDimension	0..1	ref	<p>This association represents the physical dimension to which the unit belongs to. Note that only values with units of the same physical dimensions might be converted.</p> <p>Tags:xml.sequenceOffset=50</p>

Table 5.85: Unit

[TPS_SWCT_01058] UnitGroup [The [UnitGroups](#) determine if such a conversion is appropriate.]([RS_SWCT_02100](#))

Figure 5.50 depicts the concept how units are defined.

¹⁹For the definition of what SI units are, see <http://physics.nist.gov/cuu/Units/>

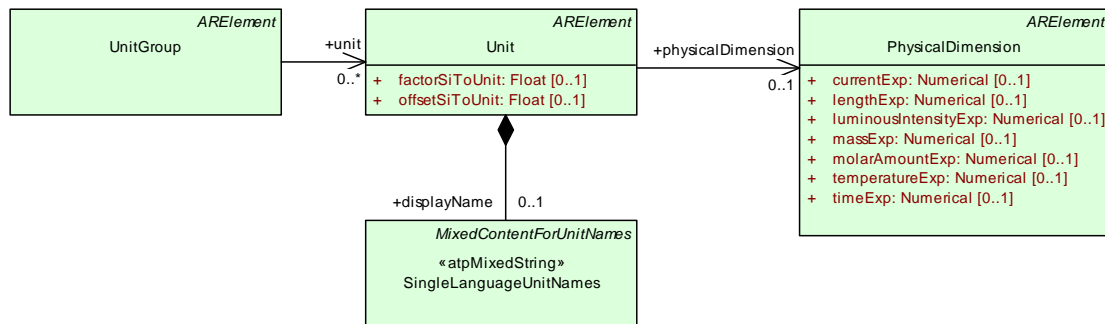

Figure 5.50: Definition of SI based units

For a detailed description of these elements please refer to the [25]. Standard units are already predefined for AUTOSAR in form of a description file.

[TPS_SWCT_01736] Default values for `Unit.physicalDimension` [If a `Unit` does not define the attribute `Unit.physicalDimension`, the default `PhysicalDimension` with the `shortName` `NoDimension` applies where all physical exponents are set to 0.] ([RS_SWCT_02100](#))

[TPS_SWCT_01059] Exponent for each of the seven fundamental dimensions [For basing a new unit directly upon SI units an exponent for each of the seven fundamental dimensions and its corresponding SI unit needs to be specified.] ([RS_SWCT_02100](#))

[TPS_SWCT_01737] Default values for physical exponents [The default value of attributes `currentExp`, `lengthExp`, `luminousIntensityExp`, `massExp`, `molarAmountExp`, `temperatureExp`, `timeExp` is 0.] ([RS_SWCT_02100](#))

[TPS_SWCT_01060] Negative exponents [Negative exponents are allowed.] ([RS_SWCT_02100](#))

Note that quantities like "%" are not derived from SI units and therefore have no association to a physical dimension.

Class	PhysicalDimension
Package	M2::MSR::AsamHdo::Units
Note	<p>This class represents a physical dimension. If the physical dimension of two units is identical, then a conversion between them is possible. The conversion between units is related to the definition of the physical dimension.</p> <p>Note that the equivalence of the exponents does not per se define the convertibility. For example Energy and Torque share the same exponents (Nm).</p> <p>Please note further the value of an exponent does not necessarily have to be an integer number. It is also possible that the value yields a rational number, e.g. to compute the square root of a given physical quantity. In this case the exponent value would be a rational number where the numerator value is 1 and the denominator value is 2.</p> <p>Tags:atp.recommendedPackage=PhysicalDimensions</p>
Base	ARElement , ARObject , CollectableElement , Identifiable , MultilanguageReferrable , PackageableElement , Referrable





<i>Class</i>	<i>PhysicalDimension</i>			
<i>Attribute</i>	<i>Type</i>	<i>Mult.</i>	<i>Kind</i>	<i>Note</i>
currentExp	Numerical	0..1	attr	This attribute represents the exponent of the physical dimension "electric current". Tags: xml.sequenceOffset=50
lengthExp	Numerical	0..1	attr	The exponent of the physical dimension "length". Tags: xml.sequenceOffset=20
luminous IntensityExp	Numerical	0..1	attr	The exponent of the physical dimension "luminous intensity". Tags: xml.sequenceOffset=80
massExp	Numerical	0..1	attr	The exponent of the physical dimension "mass". Tags: xml.sequenceOffset=30
molarAmount Exp	Numerical	0..1	attr	The exponent of the physical dimension "quantity of substance". Tags: xml.sequenceOffset=70
temperatureExp	Numerical	0..1	attr	The exponent of the physical dimension "temperature". Tags: xml.sequenceOffset=60
timeExp	Numerical	0..1	attr	The exponent of the physical dimension "time". Tags: xml.sequenceOffset=40

Table 5.86: PhysicalDimension

AUTOSAR provides the ability to map two [PhysicalDimensions](#) onto each other with the implication that the two mapped [PhysicalDimensions](#) shall be considered compatible (for more explanation please refer to [\[constr_1053\]](#)). [PhysicalDimensionMappings](#) are aggregated in form of [PhysicalDimensionMappingSets](#). This allows for gathering semantically related [PhysicalDimensionMappings](#) into the same [PhysicalDimensionMappingSet](#).

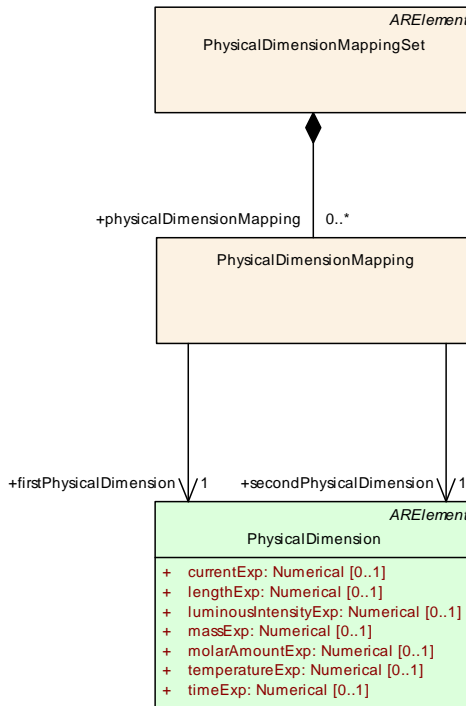

Figure 5.51: Modeling of `PhysicalDimensionMapping`

Class	PhysicalDimensionMappingSet			
Package	M2::MSR::AsamHdo::Units			
Note	This class represents a container for a list of mappings between PhysicalDimensions. Tags: atp.recommendedPackage=PhysicalDimensionMappingSets			
Base	ARElement , ARObject , CollectableElement , Identifiable , MultilanguageReferrable , PackageableElement , Referrable			
Attribute	Type	Mult.	Kind	Note
physical Dimension Mapping	PhysicalDimension Mapping	*	aggr	This aggregation represents a concrete collections of PhysicalDimensionMappings in the context of one PhysicalDimensionMappingSet.

Table 5.87: PhysicalDimensionMappingSet

Class	PhysicalDimensionMapping			
Package	M2::MSR::AsamHdo::Units			
Note	This class represents a specific mapping between two PhysicalDimensions.			
Base	ARObject			
Attribute	Type	Mult.	Kind	Note
firstPhysical Dimension	PhysicalDimension	1	ref	This represents the first PhysicalDimension of the enclosing PhysicalDimensionMapping.
secondPhysical Dimension	PhysicalDimension	1	ref	This represents the first PhysicalDimension of the enclosing PhysicalDimensionMapping.

Table 5.88: PhysicalDimensionMapping

In the following example, the units “km” and “m” and their physical dimension named “Len1” are specified. The SI base unit is “m” (Meter).

The default value of attribute `Unit.offsetSiToUnit` is 0, the default of `Unit.factorSiToUnit` is 1 (see [TPS_SWCT_01492]).

Given the equality 1 km == 1000 m, the following equation applies:

$$x[km] := y * [m] * 0.001[km/m] + 0[km]$$

This correlation is reflected in the example ARXML contained in Listing 5.15.

Listing 5.15: Example for `Unit` and `PhysicalDimension`

```

<UNIT>
  <SHORT-NAME>KiloMtr</SHORT-NAME>
  <LONG-NAME>
    <L-4 L="EN">Kilo Meter</L-4>
  </LONG-NAME>
  <DISPLAY-NAME>km</DISPLAY-NAME>
  <FACTOR-SI-TO-UNIT>0.001</FACTOR-SI-TO-UNIT>
  <OFFSET-SI-TO-UNIT>0</OFFSET-SI-TO-UNIT>
  <PHYSICAL-DIMENSION-REF BASE="PhysicalDimensions" DEST="PHYSICAL-
    DIMENSION"/>SiUnit/Len1</PHYSICAL-DIMENSION-REF>
</UNIT>

<UNIT>
  <SHORT-NAME>Mtr</SHORT-NAME>
  <LONG-NAME>
    <L-4 L="EN">Meter</L-4>
  </LONG-NAME>
  <DISPLAY-NAME>m</DISPLAY-NAME>
  <FACTOR-SI-TO-UNIT>1</FACTOR-SI-TO-UNIT>
  <OFFSET-SI-TO-UNIT>0</OFFSET-SI-TO-UNIT>
  <PHYSICAL-DIMENSION-REF BASE="PhysicalDimensions" DEST="PHYSICAL-
    DIMENSION"/>SiUnit/Len1</PHYSICAL-DIMENSION-REF>
</UNIT>

<PHYSICAL-DIMENSION>
  <SHORT-NAME>Len1</SHORT-NAME>
  <LONG-NAME>
    <L-4 L="EN">Length 1</L-4>
  </LONG-NAME>
  <LENGTH-EXP>1</LENGTH-EXP>
</PHYSICAL-DIMENSION>
  
```

[constr_1026] Compatibility of Units [For data types or prototypes, units should be referenced from within the associated `CompuMethod`. But if it is referenced from within `SwDataDefProps` and/or `PhysConstrs` (for exceptional use cases) it shall be compatible (for more details please refer to [constr_1052]) to the ones referenced from the referred `CompuMethod`.]()

Please note that for the sake of model consistency, it is also possible to define a meaningless `Unit` for all the pieces of data that conceptually do not really have a `Unit` attached to them (e.g. `ApplicationPrimitiveDataTypes` of category `BOOLEAN`).

By looking at the model, it becomes clear that the subject of whether to assign a `Unit` has been given a thought and the lack of a `Unit` is not simply the result of an oversight. For example, the AUTOSAR General Blueprints [26] define the `Unit NoUnit` for exactly this purpose.

[constr_1255] ApplicationPrimitiveDataTypes of category BOOLEAN and STRING [If a `Unit` is referenced from within `SwDataDefProps` and/or `PhysConstrs` owned by an `ApplicationPrimitiveDataTypes` of category `BOOLEAN` and `STRING` it is required that this `Unit` represents a meaningless unit, i.e. the referenced `physicalDimension` shall not define any exponent value other than 0.] ()

Class	UnitGroup			
Package	M2::MSR::AsamHdo::Units			
Note	<p>This meta-class represents the ability to specify a logical grouping of units. The category denotes the unit system that the referenced units are associated to.</p> <p>In this way, e.g. country-specific unit systems (CATEGORY="COUNTRY") can be defined as well as specific unit systems for certain application domains.</p> <p>In the same way a group of equivalent units, can be defined which are used in different countries, by setting CATEGORY="EQUIV_UNITS". KmPerHour and MilesPerHour could such be combined to one group named "vehicle_speed". The unit MeterPerSec would not belong to this group because it is normally not used for vehicle speed. But all of the mentioned units could be combined to one group named "speed".</p> <p>Note that the UnitGroup does not ensure the physical compliance of the units. This is maintained by the physical dimension.</p> <p>Tags:atp.recommendedPackage=UnitGroups</p>			
Base	<i>ARElement, ARObject, CollectableElement, Identifiable, MultilanguageReferrable, PackageableElement, Referrable</i>			
Attribute	Type	Mult.	Kind	Note
unit	<code>Unit</code>	*	ref	This represents one particular unit in the UnitGroup. Tags: xml.sequenceOffset=20

Table 5.89: UnitGroup

[TPS_SWCT_01068] Units can be grouped with the help of UnitGroup [Units can be grouped with the help of `UnitGroup`. This grouping is intended as a logical grouping which allows for example an MCD (Measurement Calibration Diagnostic) device to present different unit systems to the user such that he can choose the most appropriate one.] (*RS_SWCT_02100*)

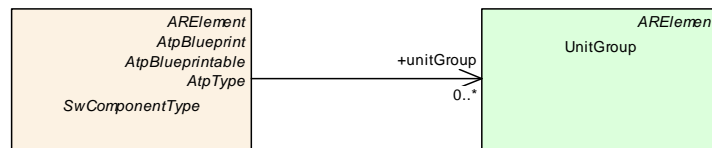

Figure 5.52: Relation of SwComponentType to UnitGroup

The association from `SwComponentType` to `UnitGroup` (beside the obvious use case to allow for the specification of `unitGroups` relevant for the enclosing `SwComponentType` in particular) is supposed to support the identification of `UnitGroups` relevant for the enclosing `System`. This aspect facilitates the creation of ASAM MCD2 files for a concrete ECU.

According to [25] the following three values for `category`s are recommended in the context of `UnitGroup`:

- `COUNTRY` collects units which are common in a particular country, denoted by the `shortName` / `longName` of the `UnitGroup`
- `CALCULATION` refers to specific units intended for the creation of data types. In this `category` of `UnitGroup`, several `Units` may refer to the same `PhysicalDimension` as well as to different `PhysicalDimension`.
- `EQUIV_UNITS` define a group of equivalent units, which are used for example in different countries.

Additional values for `category` may be mutually agreed between the stakeholders.

In the example shown in Figure 5.53, `Units` are classified by country and use.

[TPS_SWCT_01061] Conversion of units [If a unit has to be converted according to the chosen country code, the `physicalDimension` of both units shall be the same. If another unit shares the same `UnitGroup` with a `category` of `EQUIV_UNITS` it is preferred as target of the conversion.] (*RS_SWCT_02100*)

Assume "MilesPerHour" should be converted to a European unit: Based on the `physicalDimension` a conversion to "MeterPerSec" as well as "KmPerHour" is possible. In this case "KmPerHour" is preferred because "MilesPerHour" and "KmPerHour" are both members of the `UnitGroup` named "VehicleSpeed".

In contrast to this, "MeterPerSec" is not considered as appropriate for "VehicleSpeed" in this specific example.

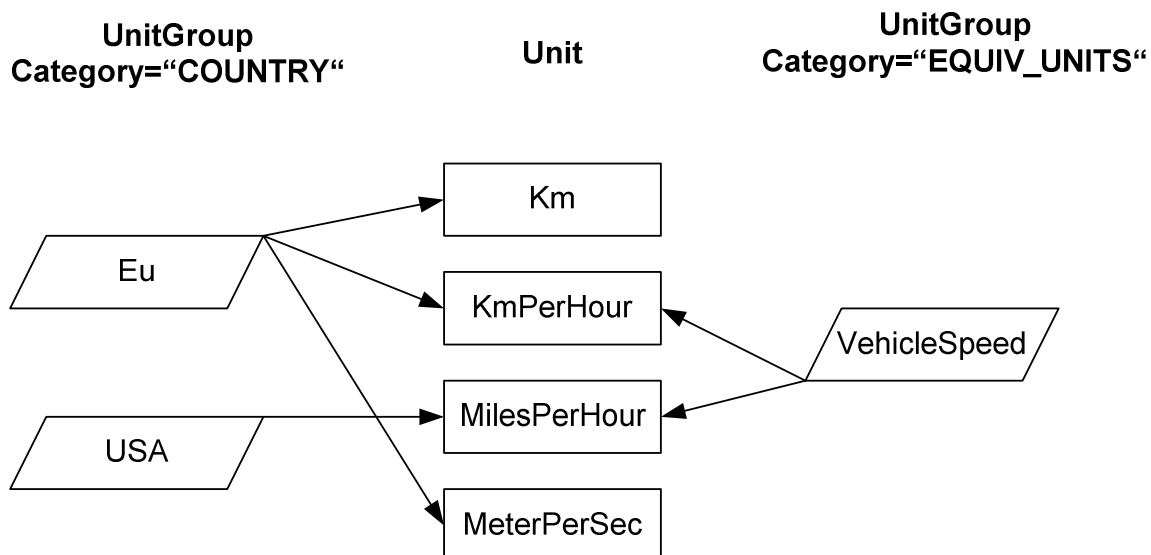

Figure 5.53: Example for units and unit groups

5.5.3 Data Constraints

Section 5.2.4.1 already shows an example on how to define constraints for the physical range of a data type, see Figure 5.4.

[TPS_SWCT_01286] DataConstr [In general, the meta-class `DataConstr` can be aggregated (via `SwDataDefProps.dataConstr`) to define various constraints for the possible values of a data type. This includes limits for the physical and internal range, as well as special constraints (`monotony`) for the setup of axis definition.]()

Figure 5.54 and the following class tables show the meta-classes involved in the definition of constraints.

A more detailed documentation of these meta-classes can be found in [25]. As refinement of these definitions, the following values apply for `constrLevel`:

[constr_2561] Application of DataConstrRule.constrLevel [`DataConstrRule.constrLevel` is limited to

- 0:** This represents so called “hard limits”. They shall always be specified.
- 1:** This represents so called “soft limits”. Soft limits may be violated after confirmation by the user of an MCD-System.

Other values may exist, but the semantics is outside the AUTOSAR scope.

]()

[TPS_SWCT_01287] Standard limits and extended limits in the ASAM-MCD2 (ASAP2) specification [The ASAM-MCD2 (ASAP2) specification [24] defines standard limits and extended limits. If extended limits exist, the standard limits may be violated upon user confirmation. Note that in consequence, of this definition, the following approach applies for A2L generation:

- If only one `DataConstrRule` with `constrLevel` set to **0** is specified, it represents the standard limits in A2L. No extended limits are generated.
- If two `DataConstrRule` exist, then:
 - the one with `constrLevel` set to **0** represents to the extended limits
 - the one with `constrLevel` set to **1** represents to the standard limits

Note that even if this is somehow counter-intuitive (since the one with `constrLevel` set to 0 changes its role), it matches the best to the definitions in ASAM-MCD2.]()

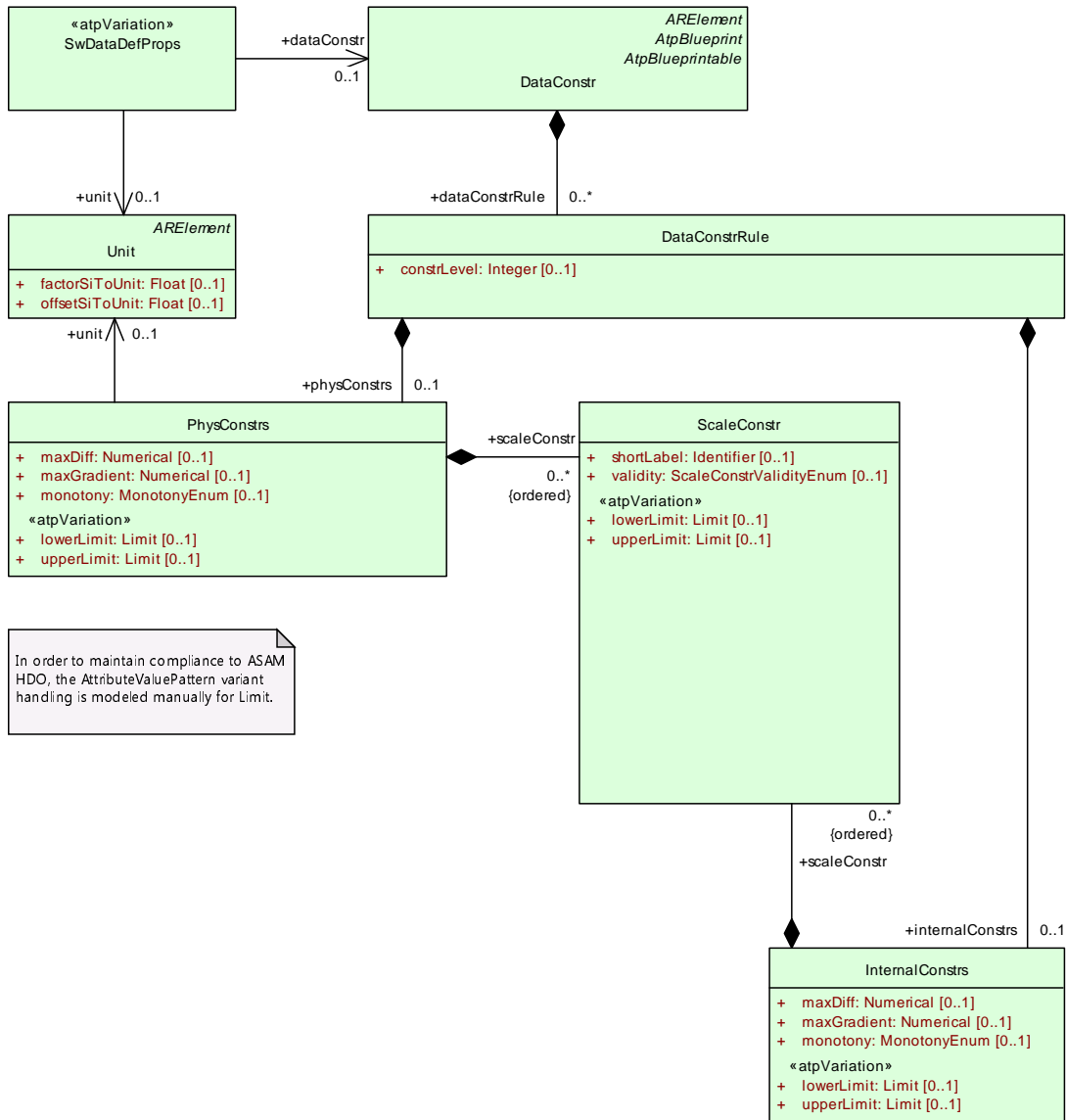

Figure 5.54: Meta-model for defining Data Constraints

Class	DataConstr			
Package	M2::MSR::AsamHdo::Constraints::GlobalConstraints			
Note	This meta-class represents the ability to specify constraints on data. Tags: atp.recommendedPackage=DataConstrs			
Base	ARElement , ARObject , AtpBlueprint , AtpBlueprintable , CollectableElement , Identifiable , Multilanguage , Referrable , PackageableElement , Referrable			
Attribute	Type	Mult.	Kind	Note





Class	DataConstr			
dataConstrRule	DataConstrRule	*	aggr	This is one particular rule within the data constraints. Tags: xml.roleElement=true xml.roleWrapperElement=true xml.sequenceOffset=30 xml.typeElement=false xml.typeWrapperElement=false

Table 5.90: DataConstr

Class	DataConstrRule			
Package	M2::MSR::AsamHdo::Constraints::GlobalConstraints			
Note	This meta-class represents the ability to express one specific data constraint rule.			
Base	ARObject			
Attribute	Type	Mult.	Kind	Note
constrLevel	Integer	0..1	attr	This attribute describes the category of a constraint. One of its functions is in the area of constraint violation, where it can be used from a certain level, to produce error messages. The lower the level, the more stringent the check. Used to distinguish hard or soft limits. Tags: xml.sequenceOffset=20
internalConstrs	InternalConstrs	0..1	aggr	Describes the limitations applicable on the internal domain (as opposed to the physical domain). Tags: xml.sequenceOffset=40
physConstrs	PhysConstrs	0..1	aggr	Describes the limitations applicable on the physical domain (as opposed to the internal domain). Tags: xml.sequenceOffset=30

Table 5.91: DataConstrRule

Class	PhysConstrs			
Package	M2::MSR::AsamHdo::Constraints::GlobalConstraints			
Note	This meta-class represents the ability to express physical constraints. Therefore it has (in opposite to InternalConstrs) a reference to a Unit.			
Base	ARObject			
Attribute	Type	Mult.	Kind	Note
lowerLimit	Limit	0..1	attr	This specifies the lower limit of the constraint. Stereotypes: atpVariation Tags: vh.latestBindingTime=preCompileTime xml.sequenceOffset=20
maxDiff	Numerical	0..1	attr	Maximum difference that is permitted between two consecutive values if the constraint is applied to an axis. Tags: xml.sequenceOffset=60





Class	PhysConstrs			
maxGradient	Numerical	0..1	attr	This element specifies the maximum slope that may be used in curves and maps. Tags: xml.sequenceOffset=50
monotony	MonotonyEnum	0..1	attr	This specifies the monotony constraints on the data object. Note that this applies only to curves and maps. Tags: xml.sequenceOffset=70
scaleConstr (ordered)	ScaleConstr	*	aggr	This is one particular scale which contributes to the data constraints. Tags: xml.roleElement=true xml.roleWrapperElement=true xml.sequenceOffset=40 xml.typeElement=false xml.typeWrapperElement=false
unit	Unit	0..1	ref	This is the unit to which the physical constraints relate to. In particular, it is the physical unit of the specified limits. Tags: xml.sequenceOffset=80
upperLimit	Limit	0..1	attr	This specifies the upper limit of the constraint. Stereotypes: atpVariation Tags: vh.latestBindingTime=preCompileTime xml.sequenceOffset=30

Table 5.92: PhysConstrs

Class	InternalConstrs			
Package	M2::MSR::AsamHdo::Constraints::GlobalConstraints			
Note	This meta-class represents the ability to express internal constraints.			
Base	<i>ARObject</i>			
Attribute	Type	Mult.	Kind	Note
lowerLimit	Limit	0..1	attr	This specifies the lower limit of the constraint. Stereotypes: atpVariation Tags: vh.latestBindingTime=preCompileTime xml.sequenceOffset=20
maxDiff	Numerical	0..1	attr	Maximum difference that is permitted between two consecutive values if the constraint is applied to an axis. Tags: xml.sequenceOffset=60
maxGradient	Numerical	0..1	attr	This element specifies the maximum slope that may be used in maps and curves. Tags: xml.sequenceOffset=50
monotony	MonotonyEnum	0..1	attr	This element specifies the monotony characteristics of the current internal or physical limits. The following table shows the monotony characteristics which are to be filled through the corresponding values. If the element has no contents or if it is omitted, "no Monotony" is the default content. Tags: xml.sequenceOffset=70





Class	InternalConstrs			
scaleConstr (ordered)	ScaleConstr	*	aggr	This is one particular scale which contributes to the data constraints. Tags: xml.roleElement=true xml.roleWrapperElement=true xml.sequenceOffset=40 xml.typeElement=false xml.typeWrapperElement=false
upperLimit	Limit	0..1	attr	This specifies the upper limit defined by the constraint. Stereotypes: atpVariation Tags: vh.latestBindingTime=preCompileTime xml.sequenceOffset=30

Table 5.93: InternalConstrs

Class	ScaleConstr			
Package	M2::MSR::AsamHdo::Constraints::GlobalConstraints			
Note	This meta-class represents the ability to specify constraints as a list of intervals (called scales).			
Base	<i>ARObject</i>			
Attribute	Type	Mult.	Kind	Note
desc	MultiLanguageOverview Paragraph	0..1	aggr	<desc> represents a general but brief description of the object in question. Tags: xml.sequenceOffset=30
lowerLimit	Limit	0..1	attr	This specifies the lower limit of the scale. Stereotypes: atpVariation Tags: vh.latestBindingTime=preCompileTime xml.sequenceOffset=40
shortLabel	Identifier	0..1	attr	This element specifies a short name for the scaleConstr. This can for example be used to create more specific messages of a constraint checker. The constraints cannot be associated in the meta-model, therefore shortLabel is somehow a substitute for shortName. Tags: xml.sequenceOffset=20
upperLimit	Limit	0..1	attr	This specifies the upper limit of a the scale. Stereotypes: atpVariation Tags: vh.latestBindingTime=preCompileTime xml.sequenceOffset=50
validity	ScaleConstrValidity Enum	0..1	attr	Specifies if the values defined by the scales are considered to be valid. If the attribute is missing then the default value is "VALID". Tags: xml.attribute=true

Table 5.94: ScaleConstr

Enumeration	ScaleConstrValidityEnum
Package	M2::MSR::AsamHdo::Constraints::GlobalConstraints
Note	This enumerator specifies the possible values of a scale.
Literal	Description
notAvailable	Currently invalid area The value usually is presented by the ECU but can currently not be performed due to e.g. initialization or temporary problems. Please note, that this behavior appears during runtime and cannot be handled while data is edited. Tags: atp.EnumerationLiteralIndex=0
notDefined	Indicates an area which is marked in a specification (e.g. as reserved) Shall usually not be set by the ECU but is used by a tester to verify correct ECU. Tags: atp.EnumerationLiteralIndex=1
notValid	The ECU cannot process the requested data. Tags: atp.EnumerationLiteralIndex=2
valid	Current value is within a valid range and can be presented to user as is. Tags: atp.EnumerationLiteralIndex=3

Table 5.95: ScaleConstrValidityEnum

Primitive	Limit			
Package	M2::AUTOSARTemplates::GenericStructure::GeneralTemplateClasses::PrimitiveTypes			
Note	This class represents the ability to express a numerical limit. Note that this is in fact a NumericalVariation Point but has the additional attribute intervalType. Tags: xml.xsd.customType=LIMIT-VALUE xml.xsd.pattern=(0[xX][0-9a-fA-F+]) (0[0-7]+) (0[bB][0-1]+) ([+-]?[1-9][0-9]+(\.[0-9]+)? [+-]?[0-9](\.[0-9]+)?)([eE]([+-]?[0-9]+)? \.[0-9]+) INF NaN xml.xsd.type=string			
Attribute	Type	Mult.	Kind	Note
intervalType	IntervalTypeEnum	0..1	attr	This specifies the type of the interval. If the attribute is missing the interval shall be considered as "CLOSED". Tags: xml.attribute=true

Table 5.96: Limit

Enumeration	MonotonyEnum
Package	M2::AUTOSARTemplates::GenericStructure::GeneralTemplateClasses::PrimitiveTypes
Note	This enumerator denotes the values for specification of monotony for e.g. curves.
Literal	Description
decreasing	This indicates that the related curve needs to be monotony decreasing. Tags: atp.EnumerationLiteralIndex=0
increasing	This indicates that the related curve needs to be monotony increasing. Tags: atp.EnumerationLiteralIndex=1
monotonous	This indicates that the values shall be monotonously decreasing or increasing, depending on the trend set by the first values of the series. Tags: atp.EnumerationLiteralIndex=2
noMonotony	This indicates that the related curve needs not to be monotony. Tags: atp.EnumerationLiteralIndex=3





Enumeration	MonotonyEnum
strictlyDecreasing	This indicates that the related curve needs to be strictly monotony decreasing. Tags: atp.EnumerationLiteralIndex=4
strictlyIncreasing	This indicates that the related curve needs to be strictly monotony increasing. Tags: atp.EnumerationLiteralIndex=5
strictMonotonous	This indicates that the values shall be strict monotonously decreasing or increasing, depending on the trend set by the first values of the series. Tags: atp.EnumerationLiteralIndex=6

Table 5.97: MonotonyEnum

[TPS_SWCT_01288] Interpretation of [PhysConstrs](#) and [InternalConstrs](#) by tools [[DataConstr](#) is an [ARElement](#) which can be reused by several data type specifications. Especially an [ImplementationDataType](#) and an [ApplicationDataType](#) which are mapped to each other, can refer to the same constraints, or they can define their own constraints.

To avoid conflicts, in both cases [PhysConstrs](#) shall be interpreted by tools only with respect to application data types while [InternalConstrs](#) shall be interpreted only with respect to implementation data types.

If only [PhysConstrs](#) are provided to [ApplicationDataTypes](#) the [CompuMethod](#) can be used to compute the [InternalConstrs](#).]()

[TPS_SWCT_01289] Semantics of [Limit](#) [Technically, a [Limit](#) specifies a boundary of the interval of valid values for a given context (i.e. a data type). Please note that the boundary might or might not be part of the interval itself, i.e. the interval might be open or closed. From the formal point of view, the range represents all real numbers defined by:

$$\begin{aligned}
 range &= \{x \in \mathbb{R} \mid lowerLimit.value < x < upperLimit.value\} \\
 &\cup \{lowerLimit.value \mid lowerLimit.intervalType == "CLOSED"\} \\
 &\cup \{upperLimit.value \mid upperLimit.intervalType == "CLOSED"\}
 \end{aligned}$$

]()

Please note that [Limit](#) inherits from [AbstractNumericalVariationPoint](#). This means it is a number which may be subject to variability. For this reason, it is not possible to constrain the content already in the xml schema.

[constr_1191] Value of [Limit](#) shall yield a numerical value [After all variability is bound, the content obtained from a limit shall yield a numerical value.]()

Nevertheless, it is not possible to distinguish on this level between float and integer values. Consequently, [\[constr_1191\]](#) will not take the burden from an AUTOSAR tool to decide whether the value provided as a limit actually makes sense in any of the given contexts.

Enumeration	IntervalTypeEnum
Package	M2::AUTOSARTemplates::GenericStructure::GeneralTemplateClasses::PrimitiveTypes
Note	This enumerator specifies the type of an interval.
Literal	Description
closed	The area is limited by the value given. The value itself is included. Tags: atp.EnumerationLiteralIndex=0
open	The area is limited by the value given. The value itself is not included. Tags: atp.EnumerationLiteralIndex=2

Table 5.98: IntervalTypeEnum

5.5.3.1 Physical Limits

Physical limits can be given at various places in the AUTOSAR Meta Model, e.g. in context of [ApplicationDataTypes](#), [DataPrototypes](#) but also without the usage of the type prototype pattern in [Compound Primitive Data Types](#) (e.g [SwAxisIndividual.dataConstr](#)).

Nevertheless, the usage of [PhysConstrs](#) requires a [CompuMethod](#) for the calculation of the numerical limits, which cannot be applied for textual conversions. For this reason following definition applies:

[TPS_SWCT_01761] Physical limits of pure textual conversions [It is not possible to define the lower or upper limit of a set of textual labels. Therefore, it is not possible to define limits for an object that can only take elements of a set of textual labels as the value.]()

Please note, as a consequence of [\[TPS_SWCT_01761\]](#) for data defined by means of a [CompuMethod](#) of [category TEXTTABLE](#) or [BITFIELD_TEXTTABLE](#) and additionally a [DataConstr](#) with a [dataConstrRule.physConstrs](#) the given [physConstrs](#) has no meaning.

[TPS_SWCT_01762] Physical limits of mixed textual conversions [The definition of the physical limits of a piece of data described by a [CompuMethod](#) of [category SCALE_LINEAR_AND_TEXTTABLE](#) and [SCALE_RATIONAL_AND_TEXTTABLE](#) can only be specified for the **linear** or **rational** part.

In addition, the defined textual labels can be used for the conversion.]()

For clarification, [\[TPS_SWCT_01761\]](#) and [\[TPS_SWCT_01762\]](#) do not limit the usage of [DataConstr.dataConstrRule.internalConstrs](#) which may define further and even tighter constraints on implementation level.

Those [internalConstrs](#) might be even given in context of a [Compound Primitive Data Type](#) (for example, in the context of an [SwAxisIndividual.inputVariableType](#) or [SwAxisIndividual.dataConstr](#)).

5.5.4 Addressing Methods

In an ECU there might be various methods to access a particular object (e.g measurement or calibration parameter) according to a given address. This variety might come from different kind of memory (near, far, ...) but also from indirections which are introduced by the compiler.

[TPS_SWCT_01290] [SwAddrMethod](#) [In order to allow a measurement and calibration system to access such objects [SwAddrMethods](#) are specified. Another purpose of this feature is to support the definition of abstract memory sections, i.e. to specify which variables shall be put together in the same sections in case of generated code (especially for data allocated by the RTE).

[SwAddrMethod](#) will be used to group data, for example, to cover the fact that sometimes it is required that one or more calibration parameters out of the overall collection of calibration parameters of a [SwComponentPrototype](#) respectively an AUTOSAR software component shall be placed in another memory location than the other parameters of the [SwComponentPrototype](#) respectively the AUTOSAR software component.]()

[TPS_SWCT_01291] Association of [MemorySection](#) with [SwAddrMethod](#) [In [Implementation](#) the particular [MemorySection](#) is associated with the [SwAddrMethod](#). This association indicates that all objects of the associated addressing method shall be placed in the given memory section.]()

Class	MemorySection
Package	M2::AUTOSARTemplates::CommonStructure::ResourceConsumption::MemorySectionUsage
Note	<p>Provides a description of an abstract memory section used in the Implementation for code or data. It shall be declared by the Implementation Description of the module or component, which actually allocates the memory in its code. This means in case of data prototypes which are allocated by the RTE, that the generated Implementation Description of the RTE shall contain the corresponding MemorySections.</p> <p>The attribute "symbol" (if symbol is missing: "shortName") defines the module or component specific section name used in the code. For details see the document "Specification of Memory Mapping". Typically the section name is build according the pattern:</p> <p><SwAddrMethod shortName>[_<further specialization nominator>][_<alignment>] where</p> <ul style="list-style-type: none"> • [<SwAddrMethod shortName>] is the shortName of the referenced SwAddrMethod • [<further specialization nominator>] is an optional infix to indicate the specialization in the case that several MemorySections for different purpose of the same Implementation Description referring to the same or equally named SwAddrMethods. • [<alignment>] is the alignment attributes value and is only applicable in the case that the memoryAllocationKeywordPolicy value of the referenced SwAddrMethod is set to addrMethod ShortNameAndAlignment <p>MemorySection used to Implement the code of RunnableEntitys and BswSchedulableEntitys shall have a symbol (if missing: shortName) identical to the referred SwAddrMethod to conform to the generated RTE header files.</p> <p>In addition to the section name described above, a prefix is used in the corresponding macro code in order to define a name space. This prefix is by default given by the shortName of the BswModule Description resp. the SwComponentType. It can be superseded by the prefix attribute.</p>
Base	<i>ARObject, Identifiable, MultilanguageReferrable, Referrable</i>





Class		MemorySection		
Attribute	Type	Mult.	Kind	Note
alignment	AlignmentType	0..1	attr	The attribute describes the alignment of objects within this memory section.
executableEntity	ExecutableEntity	*	ref	Reference to the ExecutableEntities located in this section. This allows to locate different Executable Entities in different sections even if the associated Sw Addrmethod is the same. This is applicable to code sections only.
memClass Symbol	CIdentifier	0..1	attr	Defines a specific symbol in order to generate the compiler abstraction "memclass" code for this Memory Section. The existence of this attribute supersedes the usage of swAddrmethod.shortName for this purpose. The complete name of the "memclass" preprocessor symbol is constructed as <prefix>_<memClassSymbol> where prefix is defined in the same way as for the enclosing MemorySection. See also AUTOSAR_SWS_CompilerAbstraction SWS_COMPILER_00040.
option	Identifier	*	attr	This attribute introduces the ability to specify further intended properties of this MemorySection. The following two values are standardized (to be used for code sections only and exclusively to each other): <ul style="list-style-type: none"> • INLINE - The code section is declared with the compiler abstraction macro INLINE. • LOCAL_INLINE - The code section is declared with the compiler abstraction macro LOCAL_INLINE In both cases (INLINE and LOCAL_INLINE) the inline expansion depends on the compiler specific implementation of these macros. Depending on this, the code section either corresponds to an actual section in memory or is put into the section of the caller. See AUTOSAR_SWS_CompilerAbstraction for more details.
prefix	SectionNamePrefix	0..1	ref	The prefix used to set the memory section's namespace in the code. The existence of a prefix element supersedes rules for a default prefix (such as the Bsw ModuleDescription's shortName). This allows the user to define several name spaces for memory sections within the scope of one module, cluster or SWC.
size	PositiveInteger	0..1	attr	The size in bytes of the section.
swAddrmethod	SwAddrMethod	1	ref	This association indicates that this module specific (abstract) memory section is part of an overall SwAddr Method, referred by the upstream declarations (e.g. calibration parameters, data element prototypes, code entities) which share a common addressing strategy. This can be evaluated for the ECU configuration of the build support. This association shall always be declared by the Implementation description of the module or component, which allocates the memory in its code. This means in case of data prototypes which are allocated by the RTE, that the software components only declare the grouping of its data prototypes to SwAddrMethods, and the generated Implementation Description of the RTE actually sets up this association.





Class	MemorySection			
symbol	Identifier	0..1	attr	Defines the section name as explained in the main description. By using this attribute for code generation (instead of the shortName) it is possible to define several different MemorySections having the same name - e.g. symbol = CODE - but using different sectionName Prefixes.

Table 5.99: MemorySection

Class	SwAddrMethod			
Package	M2::MSR::DataDictionary::AuxillaryObjects			
Note	Used to assign a common addressing method, e.g. common memory section, to data or code objects. These objects could actually live in different modules or components. Tags: atp.recommendedPackage=SwAddrMethods			
Base	ARElement , ARObject , AtpBlueprint , AtpBlueprintable , CollectableElement , Identifiable , MultilanguageReferrable , PackageableElement , Referrable			
Attribute	Type	Mult.	Kind	Note
memory Allocation KeywordPolicy	MemoryAllocationKeywordPolicyType	0..1	attr	Enumeration to specify the name pattern of the Memory Allocation Keyword.
option	Identifier	*	attr	This attribute introduces the ability to specify further intended properties of the MemorySection in with the related objects shall be placed. These properties are handled as to be selected. The intended options are mentioned in the list. In the Memory Mapping configuration, this option list is used to determine an appropriate MemMapAddressing ModeSet.
section Initialization Policy	SectionInitializationPolicyType	0..1	attr	Specifies the expected initialization of the variables (inclusive those which are implementing VariableData Prototypes). Therefore this is an implementation constraint for initialization code of BSW modules (especially RTE) as well as the start-up code which initializes the memory segment to which the AutosarData Prototypes referring to the SwAddrMethod's are later on mapped. If the attribute is not defined it has the identical semantic as the attribute value "INIT"
sectionType	MemorySectionType	0..1	attr	Defines the type of memory sections which can be associated with this addressing method.

Table 5.100: SwAddrMethod

[TPS_SWCT_01456] Predefined values for [MemorySection.option](#) and [SwAddrMethod.option](#) [The following values of [MemorySection.option](#) and [SwAddrMethod.option](#) are predefined by AUTOSAR:

resetSafe This corresponds to variables of ECU-functions which values shall endure a ECU reset.

protected This corresponds to variables, constants, and code which shall not be accessible and modifiable from the outside without a security mechanism.

offline This corresponds to calibration parameters which shall not be modifiable during ECU operation.

coreGlobal This corresponds to variables, constants, and code which have to be accessible by any core in case of multi-core ECUs.

coreLocal This corresponds to variables, constants, and code which have to be accessible by one core in case of multi-core ECUs.

nvData This corresponds to variables of ECU-functions which shall be stored in non-volatile data. This option is applicable for memory used as a `RAM Block` managed by the NvM.

safetyQM This corresponds to variables, constants, and code without any safety integrity level and therefore having a QM rating.

safetyAsilA This corresponds to variables, constants, and code with the safety integrity level A.

safetyAsilB This corresponds to variables, constants, and code with the safety integrity level B.

safetyAsilC This corresponds to variables, constants, and code with the safety integrity level C.

safetyAsilD This corresponds to variables, constants, and code with the safety integrity level D.

configClassPreBuild This corresponds to config data which is assigned at pre-compile or link time.

configClassPostBuild This corresponds to config data which is assigned at post-build time.

]()

Obviously, the multiplicity of both the attribute `MemorySection.option` and `SwAddrMethod.option` allows for the appearance of more than one value. For example, a combination of the values `resetSafe`, `protected`, and `safetyAsilC` makes perfect sense on a particular list and can be used to express a meaning that combines the semantics of both values with each other.

However, this combination of values is not arbitrarily possible. It is therefore necessary to formulate a constraint that regulates the appearance of the safety-related values mentioned in [TPS_SWCT_01456].

In other words, it would not make any sense to attribute a given memory object with two different ASIL [27] values appearing on the same list.

If these values were combined on a particular list, the intended semantics would be ambiguous and could not clearly be determined. Therefore, [constr_1311] applies.

[constr_1311] Appearance of safety-related possible values of `MemorySection.option` or `SwAddrMethod.option` [Any given collection of values stored in the attributes `MemorySection.option` or `SwAddrMethod.option` according to [TPS_SWCT_01456] shall at most include a single value out of the following list:

- `safetyQM`
- `safetyAsilA`
- `safetyAsilB`
- `safetyAsilC`
- `safetyAsilD`

]()

[constr_1381] Appearance of core-related possible values of `MemorySection.option` or `SwAddrMethod.option` [Any given collection of values stored in the attributes `MemorySection.option` or `SwAddrMethod.option` according to [TPS_SWCT_01456] shall at most include a single value out of the following list:

- `coreGlobal`
- `coreLocal`

]()

[TPS_SWCT_01294] Missing `SwDataDefProps.swAddrMethod` [If the association `SwDataDefProps.swAddrMethod` is missing the object can be placed anywhere without restriction, e.g. using a default behavior of the RTE generator. Contradicting specifications (e.g. two different component types request different associations for one particular `SwAddrMethod`) shall be flagged as an error.]()

Figure 5.56 illustrates the usage of `SwAddrMethod` in the context of a `DataPrototype`.

[TPS_SWCT_01292] Usage of `SwAddrMethod` in the context of a `DataPrototype` [The software component which defines the `DataPrototype` will in general not be the same to which the `Implementation` that actually contains the description of the `MemorySection` belongs.

The reason for this is that the resources for data allocated by the RTE will be described in the `Implementation` of the RTE. The indirection via `SwAddrMethod` makes this possible.]()

[TPS_SWCT_01293] RTE Generator has to derive the Memory Allocation Keyword [Please note that the RTE Generator has to derive the Memory Allocation Keyword used for `RunnableEntitys` and `BswSchedulableEntitys` from the `shortName` of the `SwAddrMethod` only because the alignment defined in `MemorySection` is not known at contract phase.]()

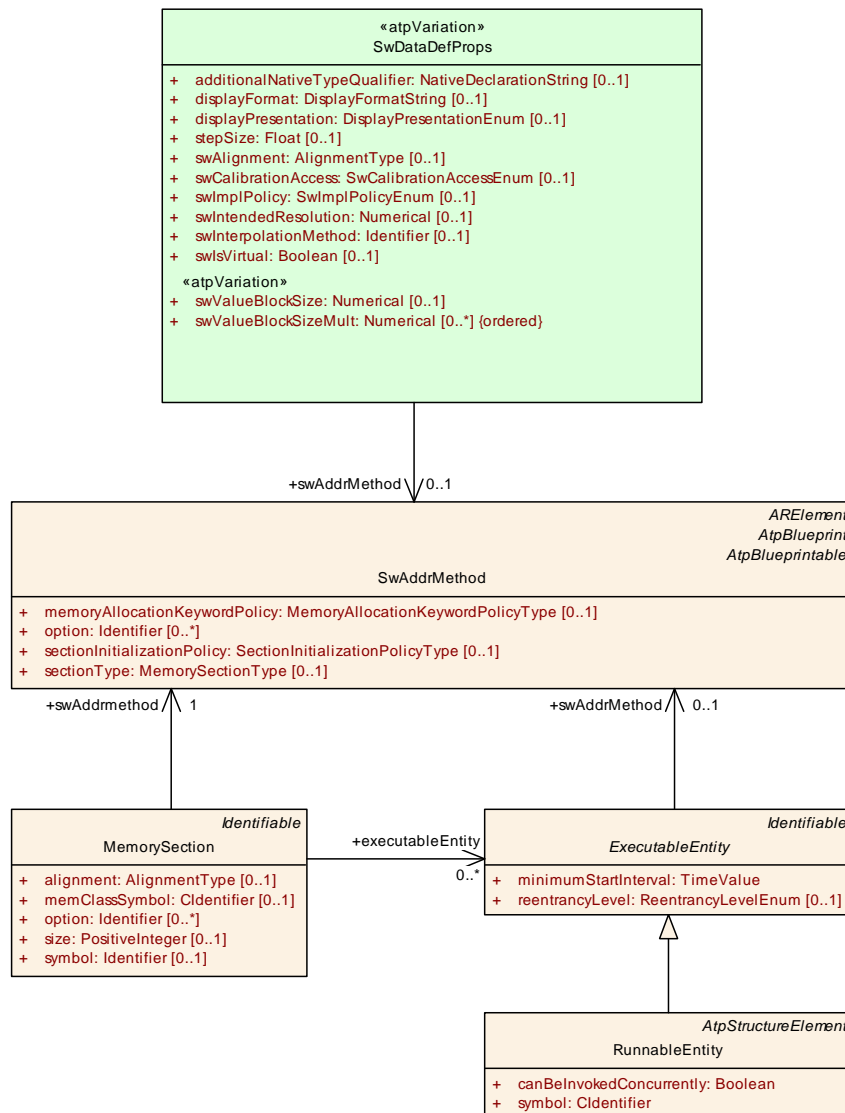

Figure 5.55: **SwAddrMethod**

[constr_2034] **SwAddrMethod** referenced by **RunnableEntities** or **BswSchedulableEntities** [RunnableEntities and BswSchedulableEntities shall not reference a SwAddrMethod which attribute `memoryAllocationKeywordPolicy` is set to `addrMethodShortNameAndAlignment`.]()

[constr_1402] **Applicability of core-related possible values of MemorySection.option or SwAddrMethod.option related to SwAddrMethod.sectionInitializationPolicy** [If the attribute `SwAddrMethod.option` or `MemorySection.option` is set to `coreLocal` then the attribute `SwAddrMethod.sectionInitializationPolicy` of the same `SwAddrMethod` respectively the `MemorySection.swAddrMethod` shall be either set to `INIT` or `CLEARED`.]()

The purpose of [constr_1402] is a reduction of the complexity of memory layouts and reduce the amount of memory gaps due to allocation restrictions.

Primitive	SectionInitializationPolicyType
Package	M2::AUTOSARTemplates::GenericStructure::GeneralTemplateClasses::PrimitiveTypes
Note	<p>SectionInitializationPolicyType describes the intended initialization of MemorySections. The following values are standardized in AUTOSAR Methodology:</p> <ul style="list-style-type: none"> • NO-INIT: No initialization and no clearing is performed. Such data elements shall not be read before one has written a value into it. • INIT: To be used for data that are initialized by every reset to the specified value (initValue). • POWER-ON-INIT: To be used for data that are initialized by "Power On" to the specified value (initValue). Note: there might be several resets between power on resets. • CLEARED: To be used for data that are initialized by every reset to zero. • POWER-ON-CLEARED: To be used for data that are initialized by "Power On" to zero. Note: there might be several resets between power on resets. <p>Please note that the values are defined similar to the representation of enumeration types in the XML schema to ensure backward compatibility.</p> <p>Tags: xml.xsd.customType=SECTION-INITIALIZATION-POLICY-TYPE xml.xsd.type=NMTOKEN</p>

Table 5.101: SectionInitializationPolicyType

Enumeration	MemorySectionType
Package	M2::MSR::DataDictionary::AuxillaryObjects
Note	Enumeration to specify the essential nature of the data which can be allocated in a common memory class by the means of the AUTOSAR Memory Mapping.
Literal	Description
calibrationVariables	<p>This memory section is reserved for "virtual variables" that are computed by an MCD system during a measurement session but do not exist in the ECU memory.</p> <p>Tags:atp.EnumerationLiteralIndex=2</p>
calprm	<p>To be used for calibratable constants of ECU-functions.</p> <p>Tags:atp.EnumerationLiteralIndex=3</p>
code	<p>To be used for mapping code to application block, boot block, external flash etc.</p> <p>Tags:atp.EnumerationLiteralIndex=4</p>
configData	<p>Constants with attributes that show that they reside in one segment for module configuration.</p> <p>Tags:atp.EnumerationLiteralIndex=5</p>
const	<p>To be used for global or static constants.</p> <p>Tags:atp.EnumerationLiteralIndex=6</p>
excludeFromFlash	<p>This memory section is reserved for "virtual parameters" that are taken for computing the values of so-called dependent parameter of an MCD system. Dependent Parameters that are not at the same time "virtual parameters" are allocated in the ECU memory.</p> <p>Virtual parameters, on the other hand, are not allocated in the ECU memory. Virtual parameters exist in the ECU Hex file for the purpose of being considered (for computing the values of dependent parameters) during an offline-calibration session.</p> <p>Tags:atp.EnumerationLiteralIndex=7</p>
var	<p>To be used for global or static variables. The expected initialization is specified with the attribute sectionInitializationPolicy.</p> <p>Tags:atp.EnumerationLiteralIndex=9</p>

Table 5.102: MemorySectionType

<i>Enumeration</i>	MemoryAllocationKeywordPolicyType
Package	M2::MSR::DataDictionary::AuxillaryObjects
Note	Enumeration to specify the name pattern of the Memory Allocation Keyword.
Literal	Description
addrMethodShort Name	The MemorySection shortNames of referring MemorySections and therefore the belonging Memory Allocation Keywords in the code are build with the shortName of the SwAddrMethod. This is the default value if the attribute does not exist. Tags: atp.EnumerationLiteralIndex=0
addrMethodShort NameAndAlignment	The MemorySection shortNames of referring MemorySections and therefore the belonging Memory Allocation Keywords in the code are build with the shortName of the SwAddrMethod and a variable alignment postfix. Thereby the alignment postfix needs to be consistent with the alignment attribute of the related MemorySection. Tags: atp.EnumerationLiteralIndex=1

Table 5.103: MemoryAllocationKeywordPolicyType

<i>Primitive</i>	AlignmentType
Package	M2::AUTOSARTemplates::GenericStructure::GeneralTemplateClasses::PrimitiveTypes
Note	This primitive represents the alignment of objects within a memory section. The value is in number of bits or UNKNOWN (deprecated), 8 , 16, 32 UNSPECIFIED, BOOLEAN, or PTR. Typical values for numbers are 8, 16, 32. Tags: xml.xsd.customType=ALIGNMENT-TYPE xml.xsd.pattern=[1-9][0-9]*[0[xX]][0-9a-fA-F]*[0[bB]][0-1]+[0[0-7]]* UNSPECIFIED UNKNOWN BOOLEAN PTR xml.xsd.type=string

Table 5.104: AlignmentType

For more information on the specification of the `MemorySection` refer to [6].

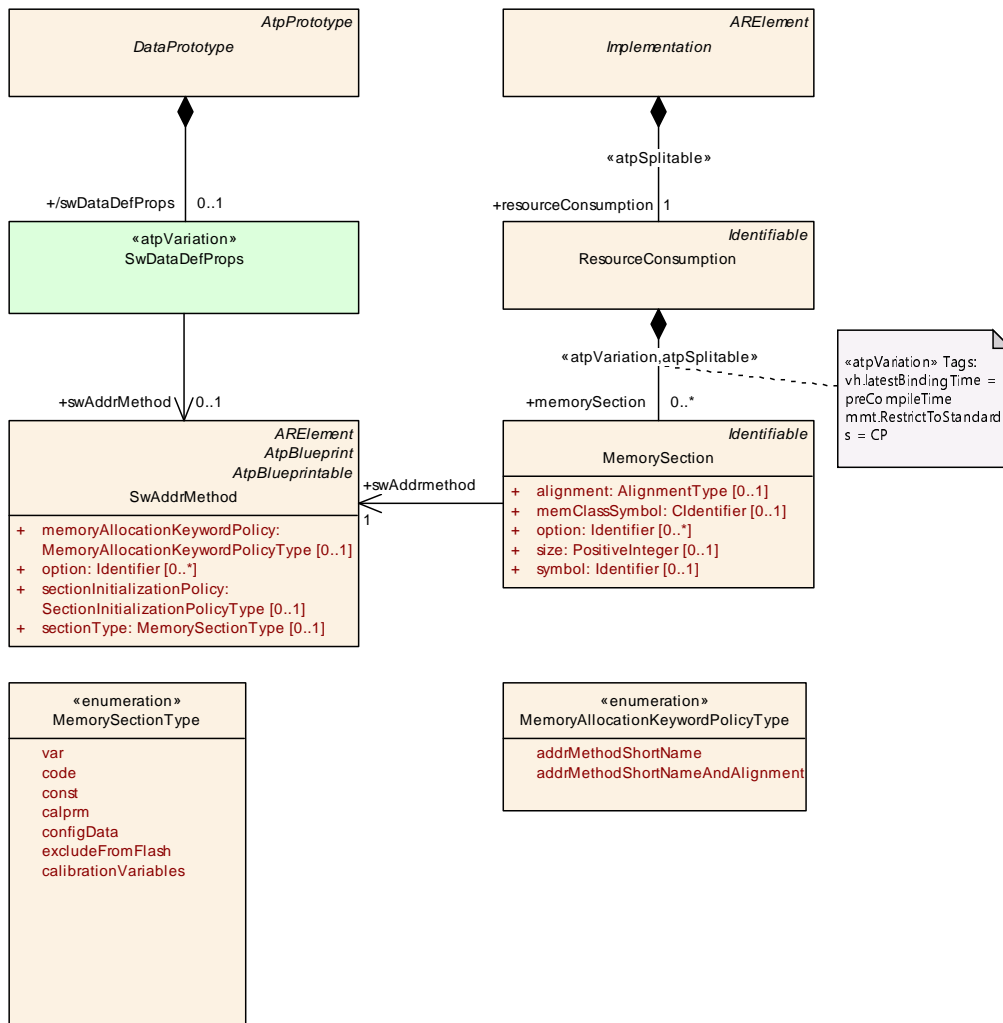

Figure 5.56: Assigning an address method to a memory section

5.5.5 Record Layouts

[TPS_SWCT_01295] **SwRecordLayout** [The **SwRecordLayout** describes how data is serialized in the memory of an ECU. This information is important with respect to the following aspects:

- to inform a measurement and calibration system how the data is serialized in the memory of an ECU
- to make sure that the software development results in the intended data structures
- to identify the proper interpolation routines

Via the **SwDataDefProps** a record-layout can be associated to a data entity. If the very same serialization approach is used for multiple **ApplicationDataTypes** all of

these may refer to the same `SwRecordLayout` even if the size of the data is different.]
()

5.5.5.1 Specifying Record Layouts

As mentioned above, the purpose of record layout is to specify how an object (e.g. a calibration parameter) is serialized in memory of an ECU. The canonical approach for this is to define nested groups (`SwRecordLayoutGroup`).

These groups indicate the structure of the corresponding `Implementation-DataType`. The serialization is then executed by iterating over the axes of a curve, a map, or iterating along a string. The contents of such a record layout group (`SwRecordLayoutGroupContent`) is a mixture of (thus nested) groups and values (`SwRecordLayoutV`).

These values refer to particular properties of the object (e.g. value, count, ...). By application of this pattern, the serialization of any complex object can be specified.

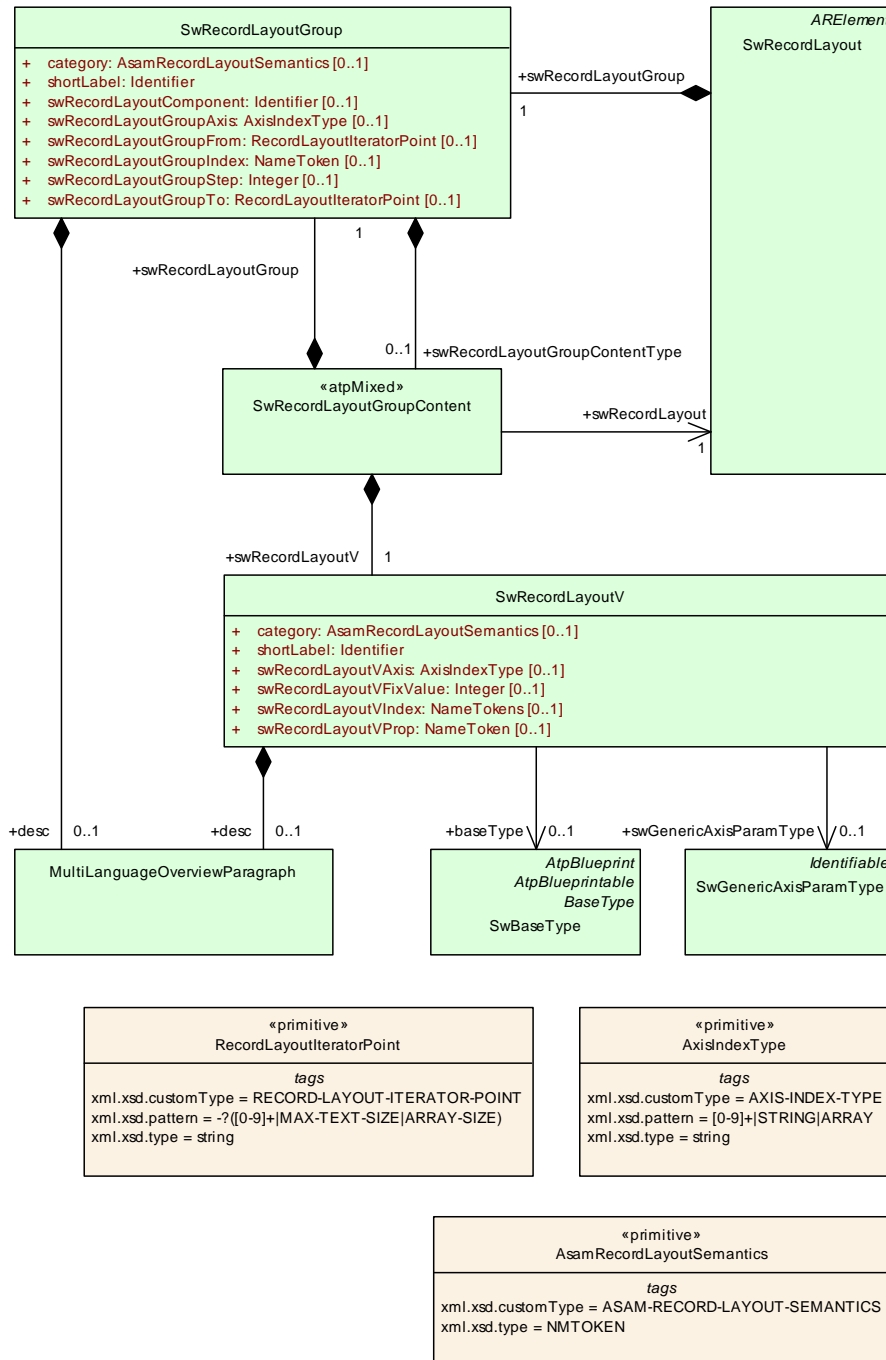

Figure 5.57: Specification of a record layout

Class	SwRecordLayout
Package	M2::MSR::DataDictionary::RecordLayout





Class	SwRecordLayout			
Note	Defines how the data objects (variables, calibration parameters etc.) are to be stored in the ECU memory. As an example, this definition specifies the sequence of axis points in the ECU memory. Iterations through axis values are stored within the sub-elements swRecordLayoutGroup. Tags: atp.recommendedPackage=SwRecordLayouts			
Base	ARElement , ARObject , CollectableElement , Identifiable , MultilanguageReferrable , PackageableElement , Referrable			
Attribute	Type	Mult.	Kind	Note
swRecordLayoutGroup	SwRecordLayoutGroup	1	aggr	This is the top level record layout group. Tags: xml.roleElement=true xml.roleWrapperElement=false xml.sequenceOffset=20 xml.typeElement=false xml.typeWrapperElement=false

Table 5.105: SwRecordLayout

Class	SwRecordLayoutV			
Package	M2::MSR::DataDictionary::RecordLayout			
Note	This element specifies which values are stored for the current SwRecordLayoutGroup. If no baseType is present, the SwBaseType referenced initially in the parent SwRecordLayoutGroup is valid. The specification of swRecordLayoutVAxis gives the axis of the values which shall be stored in accordance with the current record layout SwRecordLayoutGroup. In swRecordLayoutVProp one can specify the information which shall be stored.			
Base	ARObject			
Attribute	Type	Mult.	Kind	Note
baseType	SwBaseType	0..1	ref	This association allows to refer to a base type in case a specific encoding is intended. If no base type is referred, the base type referenced initially in the corresponding DataPrototype is to be used. Tags: xml.sequenceOffset=30
category	AsamRecordLayoutSemantics	0..1	attr	This attribute denotes the semantics in particular in terms of the corresponding A2L-Keyword. This is to support the mapping of the more general record layouts in AUTOSAR/MSR to the specific A2I keywords. It is possible to express the specific semantics of A2I RecordLayout keywords in swRecordlayoutGroup but not always vice versa. Therefore the mapping is provided in this optional attribute. Tags: xml.sequenceOffset=5
desc	MultiLanguageOverviewParagraph	0..1	aggr	This aggregation allows for a brief description about the particular record layout value which can help to identify the entry. In-depth documentation should be added to the introduction of the surrounding record layout. Tags: xml.sequenceOffset=20
shortLabel	Identifier	1	attr	This attribute specifies a name which can be used e.g. when ECU code is generated from the record layout value. Tags: xml.sequenceOffset=3





Class	SwRecordLayoutV			
swGenericAxisParamType	SwGenericAxisParamType	0..1	ref	This association supports the case that a value from a generic axis definition shall be stored. This value is denoted by a particular generic axis parameter type. Tags: xml.sequenceOffset=70
swRecordLayoutVAxis	AxisIndexType	0..1	attr	This attribute gives the index of the axis of which values that are stored in the record. swRecordVIndex refers to the symbolic names of the iterators for which the axis value shall be stored in the record. In case of nested iterators (mainly for multidimensional objects) the iterator names are specified as whitespace-separated names. These symbolic names relate to swRecordLayoutGroupIndex. The iterators are processed from left to right in such a manner that they symbolize the loop index from the outside to the inside. It is considered an error if more components are specified than axes exist in the related ApplicationDataType. Tags: xml.sequenceOffset=40
swRecordLayoutVFixValue	Integer	0..1	attr	This attribute specifies the filler character for the current record layout, in the form of hex digits. It is also used to specify the fix value for e.g. FIXRIGHTDIFF. Tags: xml.sequenceOffset=80
swRecordLayoutVIndex	NameTokens	0..1	attr	The symbolic value for iteration, or the symbolic values separated by whitespaces, refer to the symbolic values given in swRecordLayoutGroupIndex . The iterators are processed from left to right, in such a manner that they symbolize the loop index from the outside to the inside. It is considered an error if the record layout is referenced by an entity which has less number of axes than index names referenced here. Tags: xml.sequenceOffset=60
swRecordLayoutVProp	NameToken	0..1	attr	This attribute describes the kind of values to be stored. More details see below. The standardized values foreseen for this attribute are defined in [TPS_SWCT_01489] . Tags: xml.sequenceOffset=50

Table 5.106: SwRecordLayoutV

Class	SwRecordLayoutGroup			
Package	M2::MSR::DataDictionary::RecordLayout			
Note	Specifies how a record layout is set up. Using SwRecordLayoutGroup it recursively models iterations through axis values. The subelement swRecordLayoutGroupContentType may reference other SwRecordLayouts, SwRecordLayoutVs and SwRecordLayoutGroups for the modeled record layout.			
Base	<i>ARObject</i>			
Attribute	Type	Mult.	Kind	Note





Class	SwRecordLayoutGroup			
category	AsamRecordLayoutSemantics	0..1	attr	<p>This attribute denotes the semantics in particular in terms of the corresponding A2L-Keyword. This is to support the mapping of the more general record layouts in AUTOSAR/MSR to the specific A2I keywords.</p> <p>It is possible to express the specific semantics of A2I recordlayout keywords in swRecordlayoutGroup but not always vice versa. Therefore the mapping is provided in this optional attribute.</p> <p>Tags:xml.sequenceOffset=5</p>
desc	MultiLanguageOverview Paragraph	0..1	aggr	<p>This aggregation allows a brief description about the particular record layout group which can help to identify the entry. In-depth documentation should be added to the introduction of the surrounding record layout.</p> <p>Tags:xml.sequenceOffset=20</p>
shortLabel	Identifier	1	attr	<p>This attribute specifies a name which can be used e.g. when ECU code is generated from the record layout group.</p> <p>Tags:xml.sequenceOffset=3</p>
swGenericAxisParamType	SwGenericAxisParamType	0..1	ref	<p>This association allows to specify record layout groups to iterate over generic axis parameters. For example, if the generic axis parameter is an array, the record layout group will iterate over this array.</p> <p>Obviously, the axis referred to by swRecordLayoutGroup Axis shall be a generic axis in which the referenced Sw GenericAxisType is aggregated.</p> <p>Tags:xml.sequenceOffset=50</p>
swRecordLayoutComponent	Identifier	0..1	attr	<p>This attribute is used to denote the component to which the group in question applies. Thus, the record layout supports structured objects.</p> <p>This secures independence from the sequence of components, because they can be referred to via name.</p> <p>Tags:xml.sequenceOffset=90</p>
swRecordLayoutGroupAxis	AxisIndexType	0..1	attr	<p>This attribute specifies the iteration axis number for a Sw RecordLayoutGroup. The current record layout group then refers exactly to the axis with this number. This means that the values are taken by iterating along the thus referenced axis.</p> <p>Tags:xml.sequenceOffset=30</p>
swRecordLayoutGroupContentType	SwRecordLayoutGroupContent	0..1	aggr	<p>This is the contents of the recordLayout which is produced for every step of iteration.</p> <p>Tags: xml.roleElement=false xml.roleWrapperElement=false xml.sequenceOffset=100 xml.typeElement=false xml.typeWrapperElement=false</p>
swRecordLayoutGroupFrom	RecordLayoutIteratorPoint	0..1	attr	<p>This attribute specifies the iterator index for the point in the axis from which a record layout group is commenced.</p> <p>Negative values are also possible, i.e. the value -4 counts from the fourth value from the end. If this property is missing, the iteration starts with '1'.</p> <p>Tags:xml.sequenceOffset=60</p>





Class	SwRecordLayoutGroup			
swRecordLayoutGroupIndex	NameToken	0..1	attr	This attribute attributes a symbolic name to the iterator of the superimposed record layout group. This can be referenced as a loop index in contained SwRecordLayoutV elements. Tags: xml.sequenceOffset=40
swRecordLayoutGroupStep	Integer	0..1	attr	This attribute specifies the step width for the iterator index that is used for the current record layout group. Note that negative values are also possible, in case of the starting point is higher than the endpoint. If the property is missing, the step width is "1". Tags: xml.sequenceOffset=80
swRecordLayoutGroupTo	RecordLayoutIteratorPoint	0..1	attr	This attribute specifies the end point for the iteration. Negative values are also possible, i.e. the value -4 counts up to the fourth value from the end. If this property is not there, the iteration ends at "-1" which is the last element. Note that depending on the arraySizeSemantics of SwTextProps the iteration ends at the value specified in swMaxTextSize. Tags: xml.sequenceOffset=70

Table 5.107: SwRecordLayoutGroup

Class	<<atpMixed>> SwRecordLayoutGroupContent			
Package	M2::MSR::DataDictionary::RecordLayout			
Note	This is the contents of a RecordLayout which is inserted for every iteration. Note that since this is atp Mixed, multiple properties can be inserted for each iteration.			
Base	ARObject			
Attribute	Type	Mult.	Kind	Note
swRecordLayout	SwRecordLayout	1	ref	This association allows to support reusable "sub"-record layouts. In particular, the contents of the referenced record layout shall be used as if the record layout group in the referenced record layout was aggregated in the current record layout group. So, semantically it would be equivalent to replace the particular association with an aggregation of the swRecordLayoutGroup of the referenced SwRecordLayout. Tags: xml.sequenceOffset=110
swRecordLayoutGroup	SwRecordLayoutGroup	1	aggr	This aggregation provides support for nested iterations. For example, if a map is to be handled, then we might have two nested SwRecordLayoutGroups, one for the x-axis and one for the y-axis. The inner iteration runs faster. Tags: xml.sequenceOffset=130
swRecordLayoutV	SwRecordLayoutV	1	aggr	Particular Value specification for this record layout group. Tags: xml.sequenceOffset=120

Table 5.108: SwRecordLayoutGroupContent

[constr_1264] Iteration along output axis is only supported for **VALUE** and **VAL_ - BLK** [swRecordLayoutVIndex in SwRecordLayoutV cannot be 0 for any value of SwRecordLayoutV.category other than VALUE and VAL_BLK.]()

For **CURVE**, **MAP**, etc. the iteration shall be performed along the input axis.

Primitive	AxisIndexType
Package	M2::MSR::DataDictionary::RecordLayout
Note	<p>This meta-class specifies an axis in a curve/map data object. The index satisfies the following convention:</p> <ul style="list-style-type: none"> • 0 output "axis" • 1 input axis 1 (X input axis e.g. of a CURVE) • 2 input axis 2 (Y input axis e.g. of a MAP) • 3 input axis 3 (Z input axis e.g. of a CUBOID) • 4 input axis 3 (Z4 input axis e.g. of a CUBE_4) • 5 input axis 3 (Z5 input axis e.g. of a CUBE_5) • 6..9 etc. <p>The output "axis" provides access to the output value of the parameter. Note that this access is usually performed via an index according to the input axis.</p> <p>In addition to this, the Values STRING and ARRAY support specific iterations.</p> <p>Tags: xml.xsd.customType=AXIS-INDEX-TYPE xml.xsd.pattern=[0-9]+ STRING ARRAY xml.xsd.type=string</p>

Table 5.109: AxisIndexType

Primitive	RecordLayoutIteratorPoint
Package	M2::MSR::DataDictionary::RecordLayout
Note	<p>This meta-class denotes a start / endpoint for the iteration of a SwRecordLayoutGroup. It can be an integer or one of the keywords MAX-TEXT-SIZE ARRAY-SIZE. Note that negative numbers are counted backwards. Therefore e.g. -1 refers to the last value.</p> <p>Tags: xml.xsd.customType=RECORD-LAYOUT-ITERATOR-POINT xml.xsd.pattern=-?([0-9]+ MAX-TEXT-SIZE ARRAY-SIZE) xml.xsd.type=string</p>

Table 5.110: RecordLayoutIteratorPoint

[TPS_SWCT_01489] Standardized values of [SwRecordLayoutV.swRecordLayoutVProp](#) [SwRecordLayoutV.swRecordLayoutVProp describes the type of values to be stored. The standardized values for [SwRecordLayoutV.swRecordLayoutVProp](#) are listed in Table 5.111.]()

Property	Description
VALUE	The value of the axis for the current iterator point. This is e.g. the particular point on an input-axis, but also the particular character in a string.
COUNT	The amount of values of the axis.
LEFTDIFF	The difference to the previous axis point.
RIGHTDIFF	The difference to the next axis point.
DIST	The distance value of this axis in case of a fixed axis with distance specification.
SHIFT	The shift value of this axis in case of a fixed axis with shift/offset.
OFFSET	The offset value of this axis in case of a fixed axis with shift/offset.
SOURCE-ADR	The address of the source of this axis (Note that this does not apply to the value axis).





RESULT-ADR	The address of the result for this axis (note that this does not apply to input axis).
ADDRESS	The address of the axis point.
FILL	Fill with the hex value specified as contents of <code>swRecordLayoutVFixValue</code> .
FIXLEFTDIFF	Difference between this and a fixed left-hand value specified in <code>swRecordLayoutVFixValue</code> .
FIXRIGHTDIFF	Difference between this and a fixed right-hand value specified in <code>swRecordLayoutVFixValue</code> .

Table 5.111: swRecordLayoutVProp

Figure 5.58 and Figure 5.59 illustrate most of these properties.

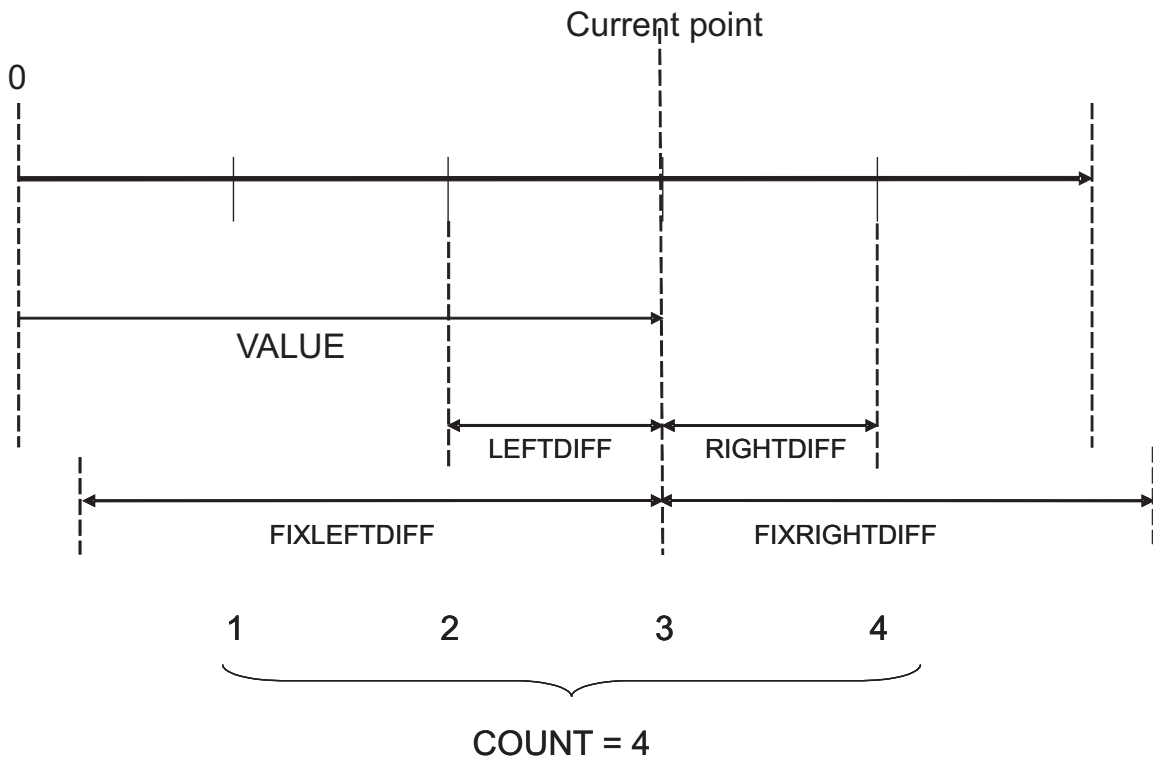

Figure 5.58: Values for swRecordLayoutVProp for individual axis

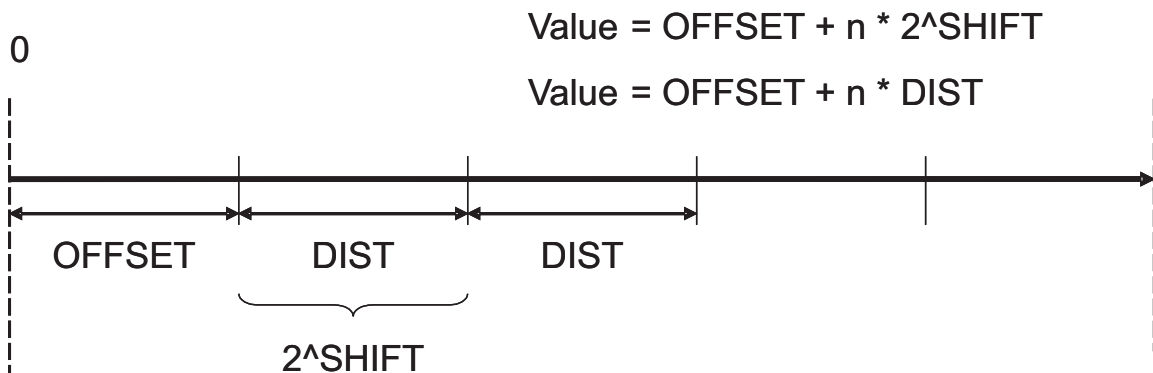

Figure 5.59: Values for swRecordLayoutVProp for fixed axis

[TPS_SWCT_01296] Different approaches of ASAM MCD-2MC and AUTOSAR with respect to `SwRecordLayout` [ASAM MCD-2D specification (also known as

A2L, or ASAP) uses keywords in record layouts where MSR/AUTOSAR uses the more generic approach specified here.

It may happen that this generic approach cannot always be safely mapped to the A2L keywords. Therefore, [SwRecordLayoutV.category](#) as well as [SwRecordLayoutGroup.category](#) can assist the conversion to the current A2L format. | ()

Primitive	AsamRecordLayoutSemantics
Package	M2::MSR::DataDictionary::RecordLayout
Note	<p>This meta-class is used to denote the semantics in particular in terms of the corresponding A2L-Keyword. This is to support the mapping of the more general record layouts in AUTOSAR/MSR to the specific A2L keywords.</p> <p>It is possible to express the specific semantics of A2L RecordLayout keywords in SwRecordLayoutGroup but not always vice versa. Therefore the mapping is provided in this optional attribute.</p> <p>It is specified as NMTOKEN to reduce the direct dependency of ASAM an AUTOSAR standards.</p> <p>Tags: xml.xsd.customType=ASAM-RECORD-LAYOUT-SEMANTICS xml.xsd.type=NMTOKEN</p>

Table 5.112: AsamRecordLayoutSemantics

The values of [SwRecordLayoutV.category](#) or [SwRecordLayoutGroup.category](#) can, for example, be taken from the ASAM MCD 2D specification provided in [24]. Examples are:

- INDEX_INCR
- INDEX_DECR
- COLUMN_DIR
- ROW_DIR
- ALTERNATE_WITH_X
- ALTERNATE_WITH_Y
- ALTERNATE_CURVES

The consistency of these values of [SwRecordLayoutV.category](#) or [SwRecordLayoutGroup.category](#) with the structure of the [SwRecordLayout](#) shall be ensured by the author of the [SwRecordLayout](#).

Note that there are keywords in A2L bound to a calibration parameter which in MSR/AUTOSAR are represented by the [SwRecordLayout](#) (DEPOSIT etc.).

The following XML fragment provides an example for a [SwRecordLayout](#) for a curve. Note that in this case recognizing the patterns represented by the A2L-Keywords (shown in XML-Comment) is pretty straight forward, even if the keywords were not provided in the [SwRecordLayoutV.category](#) as well as [SwRecordLayoutGroup.category](#).

Listing 5.16: Example for RecordLayout of a curve

```
<SW-RECORD-LAYOUT>
```



```

<SHORT-NAME>RecordLayoutCurve</SHORT-NAME>
<SW-RECORD-LAYOUT-GROUP>
  <SW-RECORD-LAYOUT-V><!-- SRC_ADDR_X -->
    <SHORT-LABEL>srcAdr</SHORT-LABEL>
    <SW-RECORD-LAYOUT-V-PROP>SOURCE-ADR</SW-RECORD-LAYOUT-V-PROP>
  </SW-RECORD-LAYOUT-V>
  <SW-RECORD-LAYOUT-V><!-- NO_AXIS_PTS_X -->
    <SHORT-LABEL>noOfAxisPts</SHORT-LABEL>
    <SW-RECORD-LAYOUT-V-PROP>COUNT</SW-RECORD-LAYOUT-V-PROP>
    <SW-RECORD-LAYOUT-V-INDEX>1</SW-RECORD-LAYOUT-V-INDEX>
  </SW-RECORD-LAYOUT-V>
  <SW-RECORD-LAYOUT-GROUP><!-- AXIS_PTS_X -->
    <SHORT-LABEL>xPts</SHORT-LABEL>
    <CATEGORY>INDEX_INCR</CATEGORY>
    <SW-RECORD-LAYOUT-GROUP-AXIS>1</SW-RECORD-LAYOUT-GROUP-AXIS>
    <SW-RECORD-LAYOUT-GROUP-FROM>1</SW-RECORD-LAYOUT-GROUP-FROM>
    <SW-RECORD-LAYOUT-GROUP-TO>-1</SW-RECORD-LAYOUT-GROUP-TO>
    <SW-RECORD-LAYOUT-V>
      <SHORT-LABEL>xPt</SHORT-LABEL>
      <SW-RECORD-LAYOUT-V-AXIS>1</SW-RECORD-LAYOUT-V-AXIS> <!--
        AXIS_PTS_X -->
      <SW-RECORD-LAYOUT-V-PROP>VALUE</SW-RECORD-LAYOUT-V-PROP>
    </SW-RECORD-LAYOUT-V>
  </SW-RECORD-LAYOUT-GROUP>
  <SW-RECORD-LAYOUT-GROUP>
    <SHORT-LABEL>values</SHORT-LABEL><!-- FNC_VALUES -->
    <CATEGORY>COLUMN_DIR</CATEGORY>
    <SW-RECORD-LAYOUT-GROUP-AXIS>0</SW-RECORD-LAYOUT-GROUP-AXIS>
    <SW-RECORD-LAYOUT-GROUP-FROM>1</SW-RECORD-LAYOUT-GROUP-FROM>
    <SW-RECORD-LAYOUT-GROUP-TO>-1</SW-RECORD-LAYOUT-GROUP-TO>
    <SW-RECORD-LAYOUT-V>
      <SHORT-LABEL>value</SHORT-LABEL>
      <SW-RECORD-LAYOUT-V-AXIS>0</SW-RECORD-LAYOUT-V-AXIS><!--
        FNC_VALUES -->
      <SW-RECORD-LAYOUT-V-PROP>VALUE</SW-RECORD-LAYOUT-V-PROP>
    </SW-RECORD-LAYOUT-V>
  </SW-RECORD-LAYOUT-GROUP>
</SW-RECORD-LAYOUT-GROUP>
</SW-RECORD-LAYOUT>

```

5.5.5.2 RecordLayouts and DataTypes

[constr_1027] Types for record layouts [Because [ParameterDataPrototypes](#) have a `<<isOfType>>`-relation to [ApplicationDataTypes](#) or [ImplementationDataTypes](#) the related data types shall properly match to the details as specified in [swDataDefProps](#).]()

This is exemplified in figure 5.60.

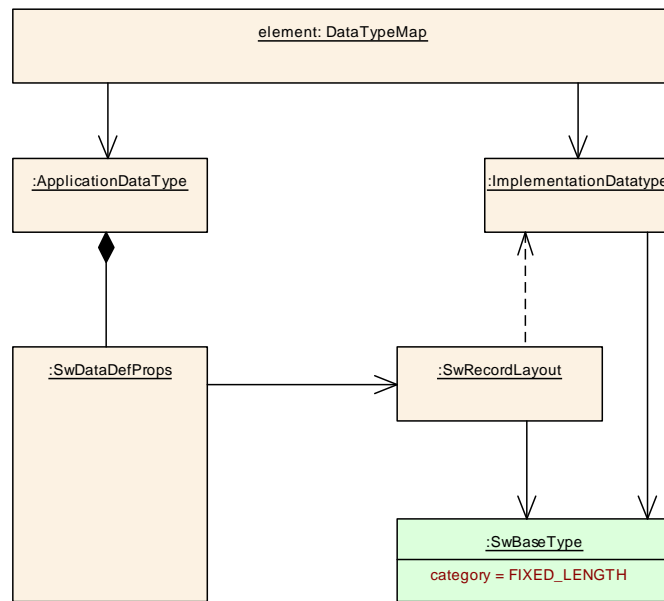

Figure 5.60: Dependency of **AutosarDataTypes** and **SwRecordLayouts**

[TPS_SWCT_01297] **Compliance of [ApplicationDataTypes](#) or [ImplementationDataTypes](#) to [swDataDefProps](#)** [In order to maintain this compliance the following options exist:

- Manually create [ImplementationDataTypes](#) from corresponding [ApplicationDataTypes](#) and the referenced [SwRecordLayouts](#)
- Automatically create [ImplementationDataTypes](#) according to the existing definition of [SwRecordLayouts](#). This could be performed by a model transformation according to the algorithm shown below.

]()

[TPS_SWCT_01298] **Computing [SwRecordLayout](#) from [ImplementationDataTypes](#) is not possible** [Note that computing [SwRecordLayouts](#) from [ImplementationDataTypes](#) is not really possible because the particular semantics of the components is not available ([swRecordLayoutVProp](#)).]()

Figures 5.61, 5.62, 5.63, 5.64, and 5.65 illustrate how data types can be derived from [SwRecordLayouts](#). Please note that the figures simplify some aspects of the actual modeling. In particular, aggregations of [SwDataDefProps](#) are left out for the sake of visual clarity.

Note that in each of these diagrams, the “blue” data types are derived from the record layout.

These diagrams illustrate in particular the fact that on the level of [ApplicationDataType](#) even complex entities such as curves and maps appear primitive data types. The inner details of such entities are handled e.g. by service libraries.

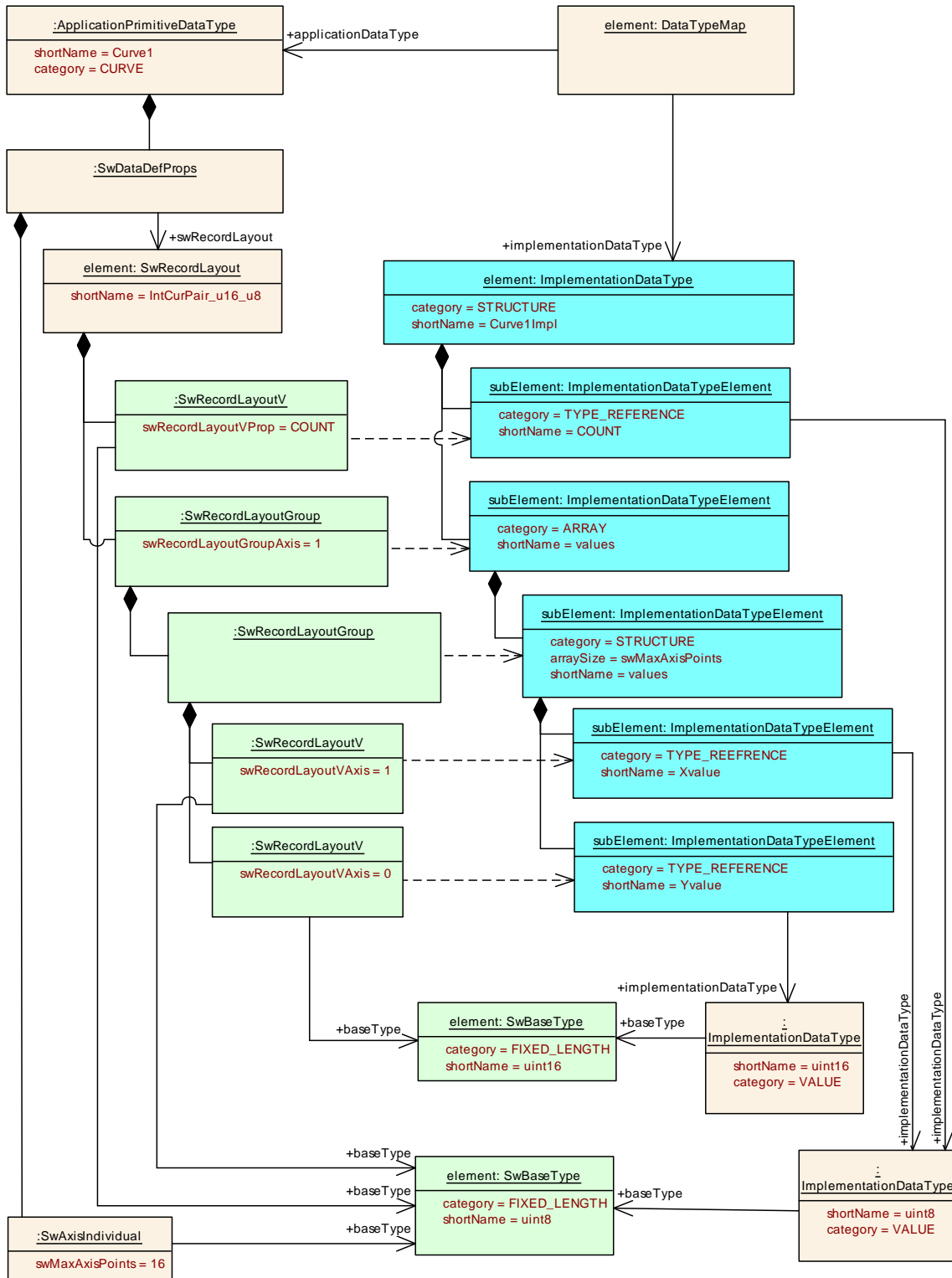

Figure 5.62: Curve implemented as array of value pairs

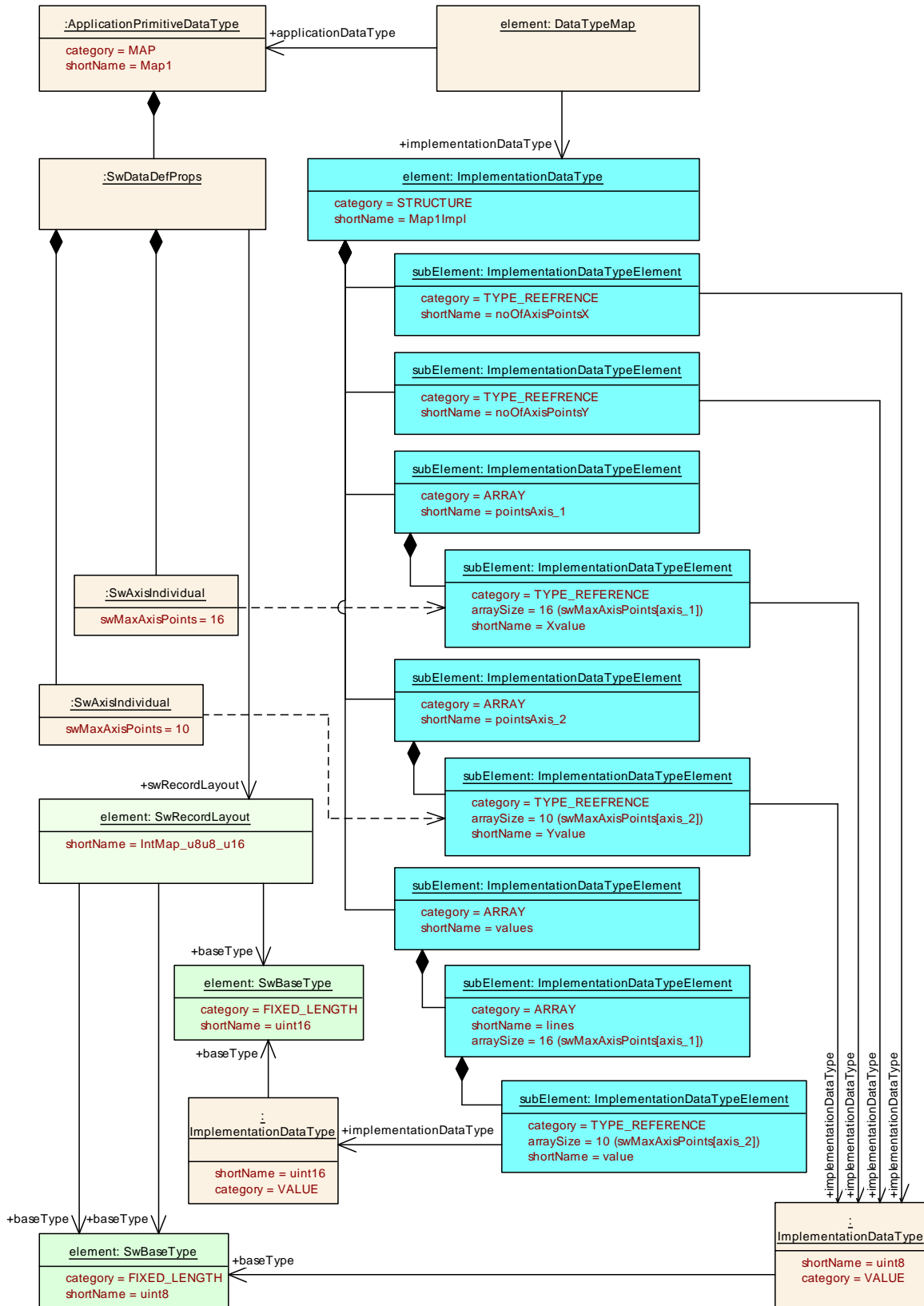

Figure 5.63: Record layout and data type for a map

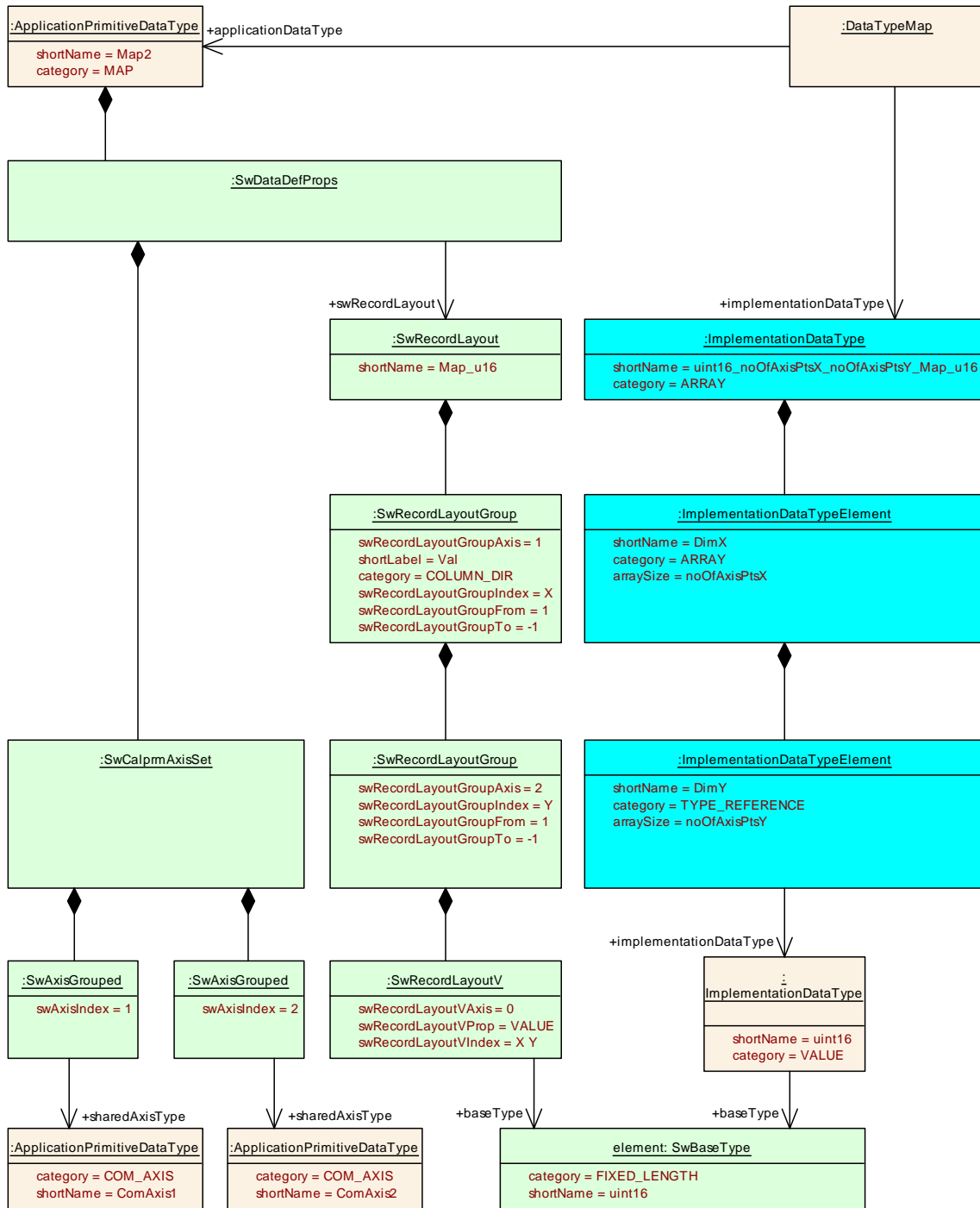

Figure 5.65: Record layout for the definition of a map implemented by an array data type

The algorithm to generate the desired data types is illustrated in the following two diagrams.

We create an `ImplementationDataType` for each `ApplicationDataType`. Figure 5.66 illustrates how to map the details.

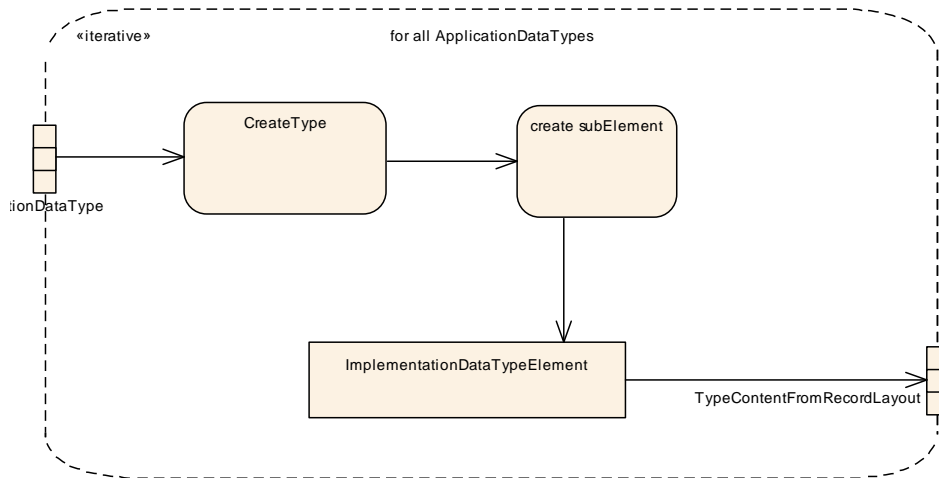

Figure 5.66: algorithm to map the details of an application data type to the corresponding implementation data type according to the record layout

[TPS_SWCT_01299] Relation of `swRecordLayoutGroup` to `subElement` [For each `swRecordLayoutGroup` an appropriate `subElement` shall be created.

The algorithm shall be recursively applied to the newly created `ImplementationDataTypeElements`. As the record layout groups are nested, this recursion yields the complete structure in the `ImplementationDataType`.]()

Please note that the refinement of the sub element happens according to the approach sketched in figure 5.67.

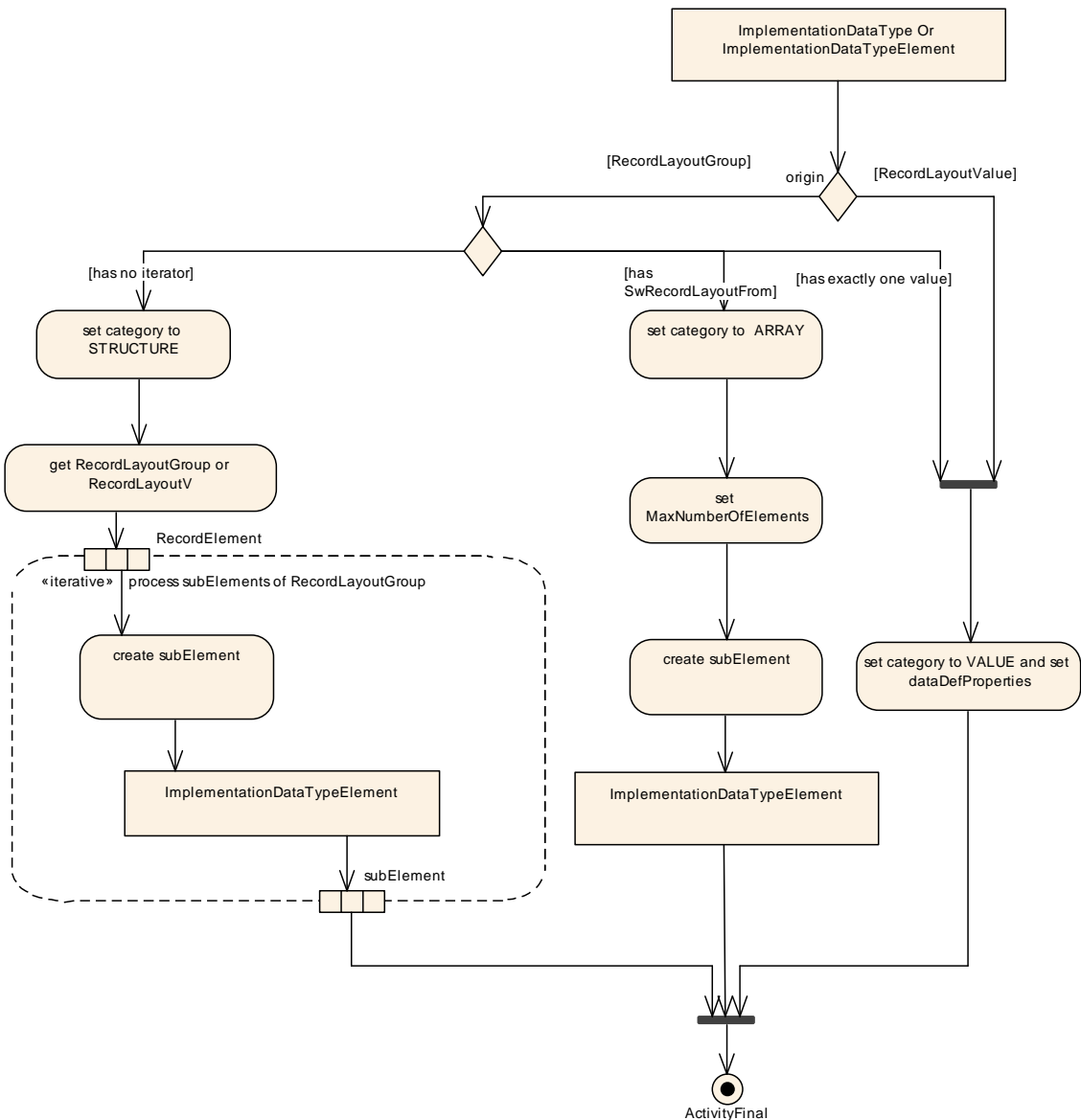

Figure 5.67: refining subElements

5.5.5.3 Record Layouts and Interpolation Routines

[TPS_SWCT_01300] Relationship between record layouts and interpolation routines [The relationship between record layouts and interpolation routines can be specified in [InterpolationRoutineMappingSet](#).

The interpolation routine is represented as [BswModuleEntry](#) and implements a particular interpolation method which is denoted in the value of [InterpolationRoutine.shortLabel](#).

The intended interpolation method is denoted in the value of attribute [SwDataDefProps.swInterpolationMethod](#).()

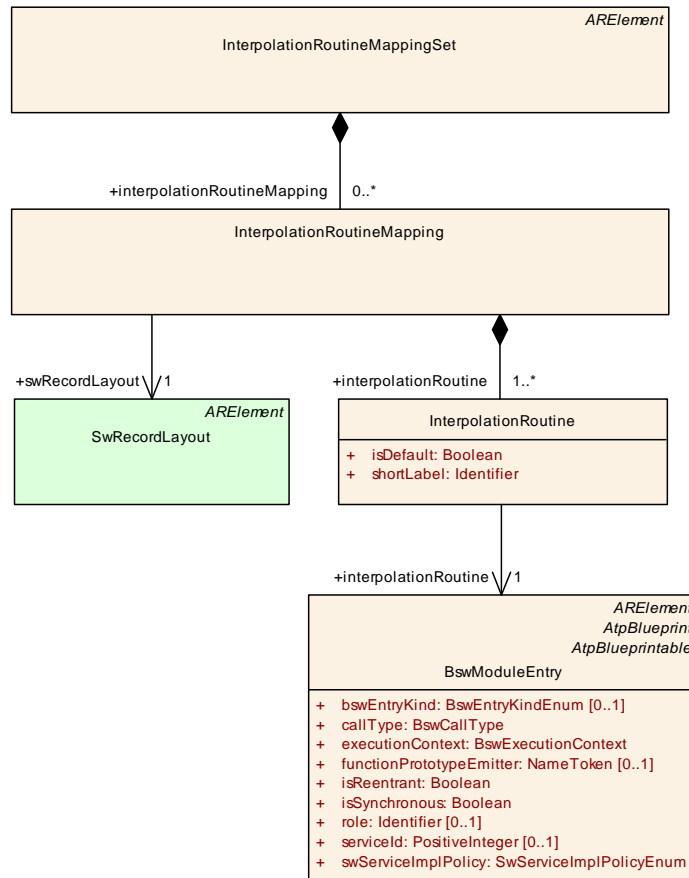

Figure 5.68: Mapping of Record Layouts and Interpolation Routines

Class	InterpolationRoutineMappingSet			
Package	M2::AUTOSARTemplates::SWComponentTemplate::MeasurementAndCalibration::InterpolationRoutineMappingSet			
Note	This meta-class specifies a set of interpolation routine mappings. Tags: atp.recommendedPackage=InterpolationRoutineMappingSets			
Base	ARElement , ARObject , CollectableElement , Identifiable , MultilanguageReferrable , PackageableElement , Referrable			
Attribute	Type	Mult.	Kind	Note
interpolation Routine Mapping	InterpolationRoutineMapping	*	aggr	This specifies one particular mapping of recordlayout and its matching interpolationRoutines.

Table 5.113: InterpolationRoutineMappingSet

Class	InterpolationRoutineMapping
Package	M2::AUTOSARTemplates::SWComponentTemplate::MeasurementAndCalibration::InterpolationRoutineMappingSet





Class	InterpolationRoutineMapping			
Note	This meta-class provides a mapping between one record layout and its matching interpolation routines. This allows to formally specify the semantics of the interpolation routines. The use case is such that the curves/Maps define an interpolation method. This mapping table specifies which interpolation routine implements methods for a particular record layout. Using this information, the implementer of a software-component can select the appropriate interpolation routine.			
Base	<i>ARObject</i>			
Attribute	Type	Mult.	Kind	Note
interpolation Routine	InterpolationRoutine	1..*	aggr	This is one particular interpolation routine which is mapped to the record layout.
swRecord Layout	SwRecordLayout	1	ref	This refers to the record layout which is mapped to interpolation routines.

Table 5.114: InterpolationRoutineMapping

Class	InterpolationRoutine			
Package	M2::AUTOSARTemplates::SWComponentTemplate::MeasurementAndCalibration::InterpolationRoutineMappingSet			
Note	This represents an interpolation routine taken to evaluate the contents of a curve or map against a specific input value.			
Base	<i>ARObject</i>			
Attribute	Type	Mult.	Kind	Note
interpolation Routine	BswModuleEntry	1	ref	This specifies a BswModuleEntry which implements the current interpolation method for the given record layout. Tags: xml.sequenceOffset=30
isDefault	Boolean	1	attr	This specifies if the current interpolationMethod is the default for the referenced record layout. Tags: xml.sequenceOffset=20
shortLabel	Identifier	1	attr	This is the name of the interpolation method which is implemented by the referenced bswModuleEntry. It corresponds to swInterpolationMethod in SwDataDef Props. Tags: xml.sequenceOffset=10

Table 5.115: InterpolationRoutine

5.5.6 Display Presentation

[TPS_SWCT_01756] Semantics of [SwDataDefProps.displayPresentation](#)

[The attribute [SwDataDefProps.displayPresentation](#) is used to control the presentation of data within measurement and calibration tools.

When such a tool displays a series of measurement values its useful to indicate to the displaying tool whether the series of measurement values can be seen as a continuous graph or as a set of discrete values, i.e. step-wise.

For instance, a continuous graph is appropriate for the case that the values do not bounce arbitrarily within one measurement cycle, e.g. a temperature variable.]()

On the other hand, a discrete handling is correct if each value of the measured variable has a distinct meaning and therefore may arbitrarily change within one measurement cycle, e.g. a state variable.

Another use case is the indication of how an ECU utilizes a `DataPrototype` of category `CURVE`, `MAP`, or `CUBOID` to determine a single value out of one or several working points in axis.

This can be either done via interpolation between the sampling points on each axis or without interpolation by taking the nearest sampling point.

The first option requires the continuous representation for the determined value in the displaying tool whereas the second option expects a discrete handling of the determined value.

[constr_1592] Definition of `SwDataDefProps.displayPresentation` depending on the capabilities of the data type [The definition of a `SwDataDefProps.displayPresentation` according to [constr_1288] and [constr_1289] shall only be applied for a `DataPrototype` of category `ARRAY` if the corresponding `ApplicationArrayDataType` or `ImplementationDataType` of category `ARRAY` supports the specification of a `SwDataDefProps.displayPresentation`.]()

[constr_1602] Definition of `SwDataDefProps.displayPresentation` depending on the capabilities of the element [The definition of a `SwDataDefProps.displayPresentation` according to [constr_1007] and [constr_1009] is only supported for an `ApplicationArrayDataType` or an `ImplementationDataType` of category `ARRAY` if the aggregated `ApplicationArrayDataType.element` or `ImplementationDataType.subElement` also supports the specification of a `SwDataDefProps.displayPresentation`.]()

[TPS_SWCT_01757] Not-applicable scenario for `presentationContinuous` [If the semantics of the `DataPrototype` is described by means of a `CompuMethod` of category `TEXTTABLE`, `BITFIELD_TEXTTABLE` or `TAB_NOINTP` the option to set attribute `displayPresentation` is meaningless because the step-wise change of data is an intrinsic property of the data object.]()

[TPS_SWCT_01758] Applicable value range of `SwDataDefProps.displayPresentation` [If the semantics of a `DataPrototype` is described by means of a `CompuMethod` of category `IDENTICAL`, `LINEAR`, `RAT_FUNC` the attribute `SwDataDefProps.displayPresentation` describes the presentation of data for the complete value range.

If the semantics of a `DataPrototype` is described by means of a `CompuMethod` of category `SCALE_LINEAR_AND_TEXTTABLE` or `SCALE_RATIONAL_AND_TEXTTABLE` the attribute `SwDataDefProps.displayPresentation` describes the presentation of data only for the value range outside the `TEXTTABLE` values.]()

Enumeration	DisplayPresentationEnum
Package	M2::MSR::DataDictionary::DataDefProperties
Note	This meta-class represents the ability to provide values for controlling the presentation of data within measurement and calibration tools.
Literal	Description
presentation Continuous	The presentation of data shall form a continuous graph between data points. Tags: atp.EnumerationLiteralIndex=0
presentation Discrete	The presentation of data shall be step-shaped between data points. Tags: atp.EnumerationLiteralIndex=1

Table 5.116: DisplayPresentationEnum

5.6 Specification of Constant Values

5.6.1 Overview

[TPS_SWCT_01177] **Assignment of constant values** [Constant values can be assigned to a meta-class by aggregating the meta-class [ValueSpecification](#). This aggregation can be used in two ways:

1. by referencing to a reusable [ConstantSpecification](#) which contains another [ValueSpecification](#)
2. or through an inline aggregation of a value specification of various kind.

|(RS_SWCT_03175)

Class	ConstantSpecification			
Package	M2::AUTOSARTemplates::CommonStructure::Constants			
Note	Specification of a constant that can be part of a package, i.e. it can be defined stand-alone. Tags: atp.recommendedPackage=ConstantSpecifications			
Base	ARElement , ARObject , CollectableElement , Identifiable , MultilanguageReferrable , PackageableElement , Referrable			
Attribute	Type	Mult.	Kind	Note
valueSpec	ValueSpecification	1	aggr	Specification of an expression leading to a value for this constant.

Table 5.117: ConstantSpecification

Class	ValueSpecification (abstract)
Package	M2::AUTOSARTemplates::CommonStructure::Constants
Note	Base class for expressions leading to a value which can be used to initialize a data object.
Base	ARObject





Class	ValueSpecification (abstract)			
Subclasses	AbstractRuleBasedValueSpecification , ApplicationValueSpecification , CompositeValueSpecification , ConstantReference , NotAvailableValueSpecification , NumericalValueSpecification , ReferenceValueSpecification , TextValueSpecification			
Attribute	Type	Mult.	Kind	Note
shortLabel	Identifier	0..1	attr	This can be used to identify particular value specifications for human readers, for example elements of a record type.

Table 5.118: ValueSpecification

Class	CompositeValueSpecification (abstract)			
Package	M2::AUTOSARTemplates::CommonStructure::Constants			
Note	This abstract meta-class acts a base class for ValueSpecifications that have a composite form.			
Base	ARObject , ValueSpecification			
Subclasses	ArrayValueSpecification , RecordValueSpecification			
Attribute	Type	Mult.	Kind	Note
–	–	–	–	–

Table 5.119: CompositeValueSpecification

Class	ArrayValueSpecification			
Package	M2::AUTOSARTemplates::CommonStructure::Constants			
Note	Specifies the values for an array.			
Base	ARObject , CompositeValueSpecification , ValueSpecification			
Attribute	Type	Mult.	Kind	Note
element (ordered)	ValueSpecification	*	aggr	The value for a single array element. All Value Specifications aggregated by ArrayValueSpecification shall have the same structure. Stereotypes: atpVariation Tags: vh.latestBindingTime=preCompileTime
intendedPartial Initialization Count	PositiveInteger	0..1	attr	This attribute shall only have a meaning for dynamic arrays and shall be taken as a sanity check: the number filled in the attribute shall be identical to the number of ArrayValueSpecification.element. If the attribute does not exist it means that no partial initialization is intended.

Table 5.120: ArrayValueSpecification

Class	RecordValueSpecification			
Package	M2::AUTOSARTemplates::CommonStructure::Constants			
Note	Specifies the values for a record.			
Base	ARObject , CompositeValueSpecification , ValueSpecification			
Attribute	Type	Mult.	Kind	Note





Class	RecordValueSpecification			
field (ordered)	ValueSpecification	1..*	aggr	The value for a single record field. This could also be mapped explicitly to a record element of the data type using the shortName of the ValueSpecification. But this would introduce a relationship to the data type that is too strong. As of now, it is only important that the structure of the data type matches the structure of the Value Specification independently of the shortNames. Stereotypes: atpVariation Tags: vh.latestBindingTime=preCompileTime

Table 5.121: RecordValueSpecification

Class	TextValueSpecification			
Package	M2::AUTOSARTemplates::CommonStructure::Constants			
Note	The purpose of TextValueSpecification is to define the labels that correspond to enumeration values.			
Base	<i>ARObject</i> , ValueSpecification			
Attribute	Type	Mult.	Kind	Note
value	VerbatimString	1	attr	This is the value itself. Note that vt uses the operator to separate the values for the different bitfield masks in case that the semantics of the related DataPrototype is described by means of a BITFIELD_TEXTTABLE in the associated CompuMethod.

Table 5.122: TextValueSpecification

Class	NumericalValueSpecification			
Package	M2::AUTOSARTemplates::CommonStructure::Constants			
Note	A numerical ValueSpecification which is intended to be assigned to a Primitive data element. Note that the numerical value is a variant, it can be computed by a formula.			
Base	<i>ARObject</i> , ValueSpecification			
Attribute	Type	Mult.	Kind	Note
value	Numerical	1	attr	This is the value itself. Stereotypes: atpVariation Tags: vh.latestBindingTime=preCompileTime

Table 5.123: NumericalValueSpecification

Class	ReferenceValueSpecification			
Package	M2::AUTOSARTemplates::CommonStructure::Constants			
Note	Specifies a reference to a data prototype to be used as an initial value for a pointer in the software.			
Base	<i>ARObject</i> , ValueSpecification			
Attribute	Type	Mult.	Kind	Note
referenceValue	DataPrototype	1	ref	The referenced data prototype.

Table 5.124: ReferenceValueSpecification

Figure 5.69 shows the specialized subclasses of [ValueSpecification](#) which allow defining values for different use cases.

[TPS_SWCT_01178] **Specialized subclasses of `ValueSpecification`** [The use case for specialized subclasses of `ValueSpecification` are:

- Reference to a constant (which is actually a reusable value specification) by means of a `ConstantReference`.
- `TextValueSpecification`
- `NumericalValueSpecification`
- `ArrayValueSpecification`
- `RecordValueSpecification`
- `ApplicationValueSpecification`: this can be used to specify the value of Compound Primitive Data Types (see [TPS_SWCT_01179]) such as curves and maps. It is also possible to use this in general (e.g. for a primitive calibration value) for the specification of a value of a `DataPrototype` typed by an `ApplicationDataType`.

Note that `ApplicationValueSpecification` is modeled along the example of ASAM CDF (for more information please refer to [28]).

- reference to a `DataPrototype`: this can be used to describe initial values for pointer variables in the basic software. One use case is the exchange of data descriptions used to access calibration data for software emulation methods (see [6] for details).
- `ApplicationRuleBasedValueSpecification`
- `NumericalRuleBasedValueSpecification`

](*RS_SWCT_03175*)

It's important to understand that although the name of the meta-class `TextValueSpecification` suggests that it is the preferred way for the definition of an `invalidValue` or `initValue` of a `VariableDataPrototype/ParameterDataPrototype` typed by an `ApplicationPrimitiveDataType` of category `STRING` the `TextValueSpecification` actually has a different purpose (as defined by [`constr_1284`]).

[`constr_1284`] **Limitation of the use of `TextValueSpecification`** [`TextValueSpecification` shall **only** be used in the context of an `AutosarDataType` that references a `CompuMethod` in the role `ImplementationDataType.swDataDef-Props.compuMethod` of category `TEXTTABLE` and `BITFIELD_TEXTTABLE`.]()

In other words, the purpose of `TextValueSpecification` is to define the labels that correspond to enumeration values. The constraints [`constr_1225`] and [`constr_1284`] correspond to each other such that [`constr_1225`] demands the usage of `TextValueSpecification` for the definition of labels for enumeration values while [`constr_1284`] says that the definition of labels for enumeration values is the only use case for `TextValueSpecification`.

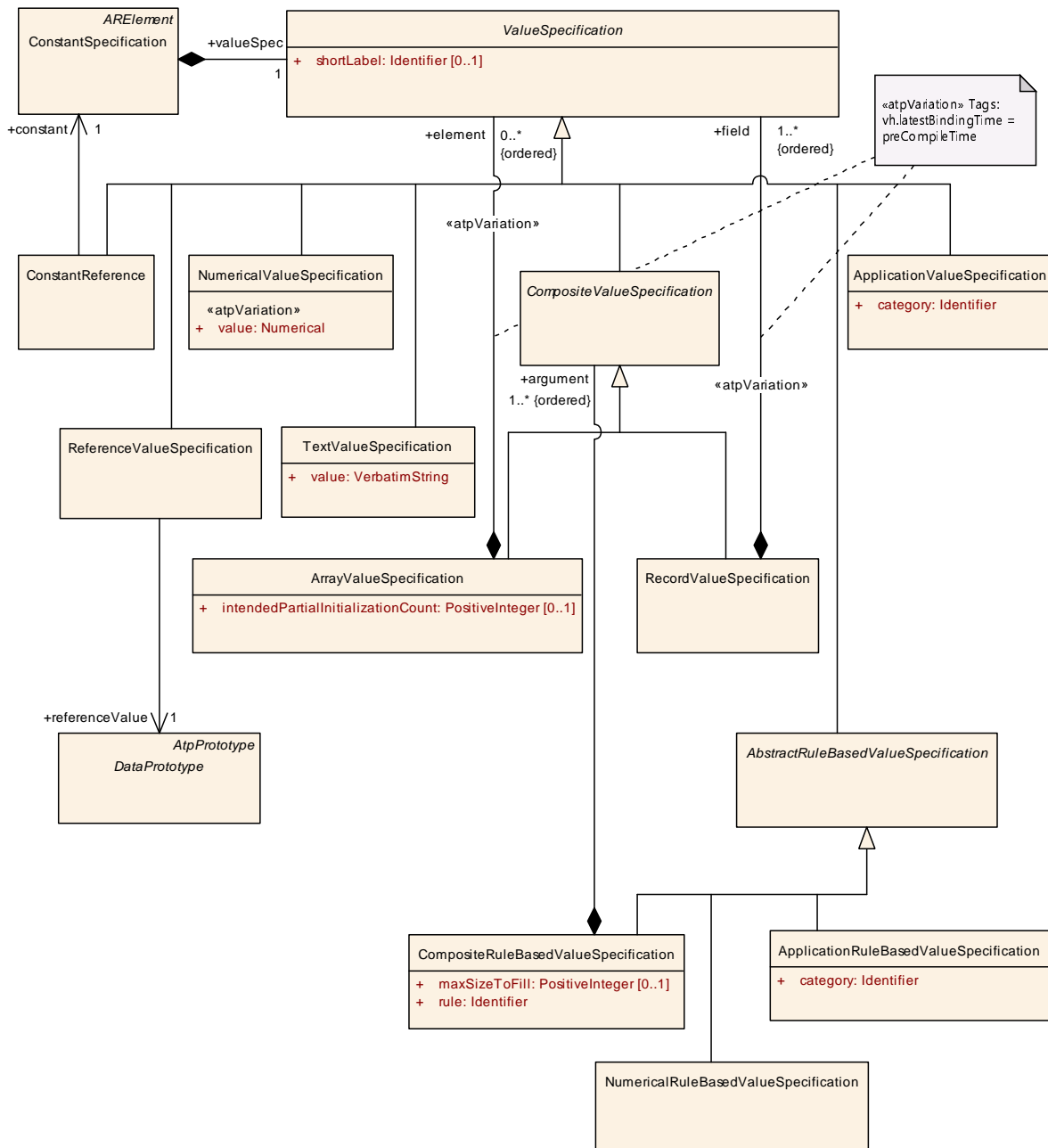

Figure 5.69: Summary of ValueSpecification

Note that ValueSpecification does not inherit from any data type. This would cause a redundancy²⁰ in the meta-model since the intended data type of a ValueSpecification is already determined by the context in which it is aggregated.

Nonetheless, the intended data type imposes a certain constraint on the content of a ValueSpecification:

²⁰For example, “1” can be taken as a constant value for many data types. If the ValueSpecification were instead referring to a specific AutosarDataType it would be necessary to define a “1” for every single AutosarDataType this value is supposed to be used in combination with.

[constr_4035] ValueSpecification shall fit into data type [An instance of `ValueSpecification` which is used to assign a value to a software object typed by an `AutosarDataType` shall fit into this `AutosarDataType` without losing information.]
()

For example, it is not allowed to assign the numerical value “1.5” as initial value to a data prototype typed by an `ImplementationDataType` which has an integer base type.

[constr_1271] RecordValueSpecification.fields shall be identical to the number of ApplicationRecordDataType.elements [The initialization of an `DataPrototype` typed by an `ApplicationRecordDataType` by means of a `RecordValueSpecification` shall exactly match the structure of the `ApplicationRecordDataType`.]

For this means, it is required that the number of `RecordValueSpecification.fields` shall be identical to the number of `ApplicationRecordDataType.elements`.] ()

[constr_1272] RecordValueSpecification.fields shall be identical to the number of subElements of ImplementationDataType of category STRUCTURE [The initialization of an `DataPrototype` typed by an `ImplementationDataType` of category `STRUCTURE` by means of a `RecordValueSpecification` shall exactly match the structure of the `ImplementationDataType` of category `STRUCTURE`.]

For this means, it is required that the number of `RecordValueSpecification.fields` shall be identical to the number of `ImplementationDataType.subElements`.] ()

The requirement to exactly match the structure shall not be applied if a `NotAvailableValueSpecification` is found.

If the corresponding `ApplicationRecordElement` is typed by an `ApplicationRecordDataType` then the comparison of structural compliance between `ApplicationRecordDataType` and `ValueSpecification` shall continue beyond the encountered `NotAvailableValueSpecification`.

Class	NotAvailableValueSpecification			
Package	M2::AUTOSARTemplates::CommonStructure::Constants			
Note	This meta-class provides the ability to specify a <code>ValueSpecification</code> to state that the respective element is not available. This ability is needed to support the existence of <code>ApplicationRecordElements</code> where attribute <code>isOptional</code> is set to the value <code>True</code> . Tags: atp.Status=draft			
Base	<code>ARObject</code> , <code>ValueSpecification</code>			
Attribute	Type	Mult.	Kind	Note
–	–	–	–	–

Table 5.125: NotAvailableValueSpecification

For deeply nested composite data types (including [ImplementationDataTypes](#) created in response to the existence of a Compound Primitive Data Type) [[constr_1271](#)], [[constr_1272](#)], and [[constr_1273](#)] shall be applied recursively according to the nature of the given nesting levels. For the “leaf” elements [[constr_4035](#)] applies.

5.6.2 Specification of Values based on Rules

5.6.2.1 Support for primitive Data Types

[TPS_SWCT_01484] Meaning of [ApplicationRuleBasedValueSpecification](#)
[The purpose of the [ApplicationRuleBasedValueSpecification](#) is to provide means for a compact provision of values for [DataPrototypes](#) that otherwise would require a high volume (in terms of serialized ARXML) of e.g. initialization data.

[ApplicationRuleBasedValueSpecification](#) may be used for [ApplicationArrayDataType](#), and also (if applicable) to the so-called Compound Primitive Data Types.]([RS_SWCT_03260](#))

For example, an [ApplicationArrayDataType](#) that has 100 elements would need to be initialized such that for each element a dedicated initial value is provided.

In the most prominent cases the majority of these elements are initialized with an identical value (e.g. 0) and only the first few elements differ in terms of initialization values.

Please note that [ApplicationRuleBasedValueSpecification](#) applies for arrays typed by a primitive data type. Rule-based value specification of arrays of a composite data type is done by means of the [CompositeRuleBasedValueSpecification](#).

Class	AbstractRuleBasedValueSpecification (abstract)			
Package	M2::AUTOSARTemplates::CommonStructure::Constants			
Note	This represents an abstract base class for all rule-based value specifications.			
Base	ARObject , ValueSpecification			
Subclasses	ApplicationRuleBasedValueSpecification , CompositeRuleBasedValueSpecification , NumericalRuleBasedValueSpecification			
Attribute	Type	Mult.	Kind	Note
–	–	–	–	–

Table 5.126: AbstractRuleBasedValueSpecification

Class	ApplicationRuleBasedValueSpecification			
Package	M2::AUTOSARTemplates::CommonStructure::Constants			
Note	This meta-class represents rule based values for DataPrototypes typed by ApplicationDataTypes (ApplicationArrayDataType or a compound ApplicationPrimitiveDataType which also boils down to an array-nature).			
Base	ARObject , AbstractRuleBasedValueSpecification , ValueSpecification			





Class		ApplicationRuleBasedValueSpecification		
Attribute	Type	Mult.	Kind	Note
category	Identifier	1	attr	This represents the category of the RuleBasedValue Specification Tags: xml.sequenceOffset=-20
swAxisCont (ordered)	RuleBasedAxisCont	*	aggr	This represents the axis values of a Compound Primitive Data Type (curve or map). The first swAxisCont describes the x-axis, the second swAxisCont describes the y-axis, the third swAxisCont describes the z-axis. In addition to this, the axis can be denoted in swAxisIndex.
swValueCont	RuleBasedValueCont	0..1	aggr	This represents the values of an array or Compound Primitive Data Type.

Table 5.127: ApplicationRuleBasedValueSpecification

Class		RuleBasedAxisCont		
Package		M2::AUTOSARTemplates::CommonStructure::Constants		
Note		This represents the values for the axis of a compound primitive (curve, map). For standard and fix axes, SwAxisCont contains the values of the axis directly. The axis values of SwAxisCont with the category COM_AXIS, RES_AXIS are for display only. For editing and processing, only the values in the related GroupAxis are binding.		
Base		<i>ARObject</i>		
Attribute	Type	Mult.	Kind	Note
category	CalprmAxisCategory Enum	1	attr	This category specifies the particular axis types: <ul style="list-style-type: none"> • STD_AXIS • COM_AXIS • RES_AXIS (swArraysize necessary) Tags: xml.sequenceOffset=20
ruleBased Values	RuleBasedValue Specification	1	aggr	This represents the rule based value specification for the axis of a compound primitive (curve, map). Tags: xml.roleElement=true xml.roleWrapperElement=false xml.sequenceOffset=80 xml.typeWrapperElement=false
swArraysize	ValueList	1	aggr	For multidimensional compound primitives (curve, map ...) it is necessary to know the dimensions.They are specified using swArraySize. Tags: xml.sequenceOffset=40
swAxisIndex	AxisIndexType	1	attr	This property allows to explicitly assign the axis contents to a particular axis. It is specified by numbers where 1 corresponds to the x-axis. It is also possible to derive the axis association from the sequence of the parent. Tags: xml.sequenceOffset=50
unit	Unit	0..1	ref	This represents the physical unit of the provided values. Tags: xml.sequenceOffset=30

Table 5.128: RuleBasedAxisCont

Class	RuleBasedValueCont			
Package	M2::AUTOSARTemplates::CommonStructure::Constants			
Note	This represents the values of a compound primitive (CURVE, MAP, CUBOID, CUBE_4, CUBE_5, VAL_BLK) or an array.			
Base	ARObject			
Attribute	Type	Mult.	Kind	Note
ruleBasedValues	RuleBasedValueSpecification	1	aggr	This represents the rule based value specification for the array or compound primitive (CURVE, MAP, CUBOID, CUBE_4, CUBE_5, VAL_BLK). Tags: xml.roleElement=true xml.roleWrapperElement=false xml.sequenceOffset=80 xml.typeWrapperElement=false
swArraysizes	ValueList	0..1	aggr	This attribute defines the size of each dimension for compound primitives CURVE, MAP, CUBOID, CUBE_4, CUBE_5, COM_AXIS, RES_AXIS, VAL_BLK, STRING. For each dimension one value has to be defined, e.g. one in case of COM_AXIS and two or more in case of MAP. Tags: xml.sequenceOffset=40
unit	Unit	0..1	ref	This represents the physical unit of the provided values. Tags: xml.sequenceOffset=30

Table 5.129: RuleBasedValueCont

In case the [ApplicationRuleBasedValueSpecification](#) is applied to [Compound Primitive Data Types](#) basically the same rules apply for [ApplicationRuleBasedValueSpecification](#) as defined for [ApplicationValueSpecification](#).

[constr_2057] Mandatory information of a [RuleBasedAxisCont](#) [If the attribute [swAxisCont](#) is defined for an [ApplicationRuleBasedValueSpecification](#) the [RuleBasedAxisCont](#) shall define one [swAxisIndex](#) value and one [swArraysizes](#) value per dimension, even in the case when the owning [ApplicationRuleBasedValueSpecification](#) defines only the content of a single dimensional object like a [CURVE](#).]()

[constr_2058] Mandatory information of a [RuleBasedValueCont](#) [If the attribute [swValueCont](#) is defined for an [ApplicationRuleBasedValueSpecification](#) the [RuleBasedValueCont](#) shall always define the attribute [swArraysizes](#) if the [ApplicationRuleBasedValueSpecification](#) is of category [CURVE](#), [MAP](#), [CUBOID](#), [CUBE_4](#), [CUBE_5](#), [COM_AXIS](#), [RES_AXIS](#), [VAL_BLK](#) or [ARRAY](#).]()

Please note that for multidimensional [Compound Primitive Data Types](#) (e.g. [MAP](#)) it is necessary to know the dimensions in order to be able to process the [SwValues](#). [\[constr_2057\]](#) and [\[constr_2058\]](#) shall support a consistent handling of single and multidimensional [Compound Primitive Data Types](#).

If the [ApplicationRuleBasedValueSpecification](#) defines values for a [Compound Primitive Data Type](#) with more than one input axis the [swArraysizes](#) gets mandatory to ensure the correct processing of the values calculated by rule.

[TPS_SWCT_02053] Values of **RuleBasedAxisCont** with the **category COM_AXIS, RES_AXIS** are for display only [In case of **ApplicationRuleBasedValueSpecifications** of category **MAP, CUBOID, CUBE_4, CUBE_5** or **CURVE** it is possible that the **RuleBasedAxisCont** of axes can be omitted if the axis is of category **COM_AXIS** or **RES_AXIS**.

If **RuleBasedAxisCont** values exists in such cases for the axes these are for display purpose only because the related **DataPrototype** of the **MAP** or **CURVE** does not hold the values of such axes. These are properties of the **DataPrototype** of the **COM_AXIS** or **RES_AXIS**.]()

Hence, values of the **COM_AXIS** itself are described by **RuleBasedValueCont**.

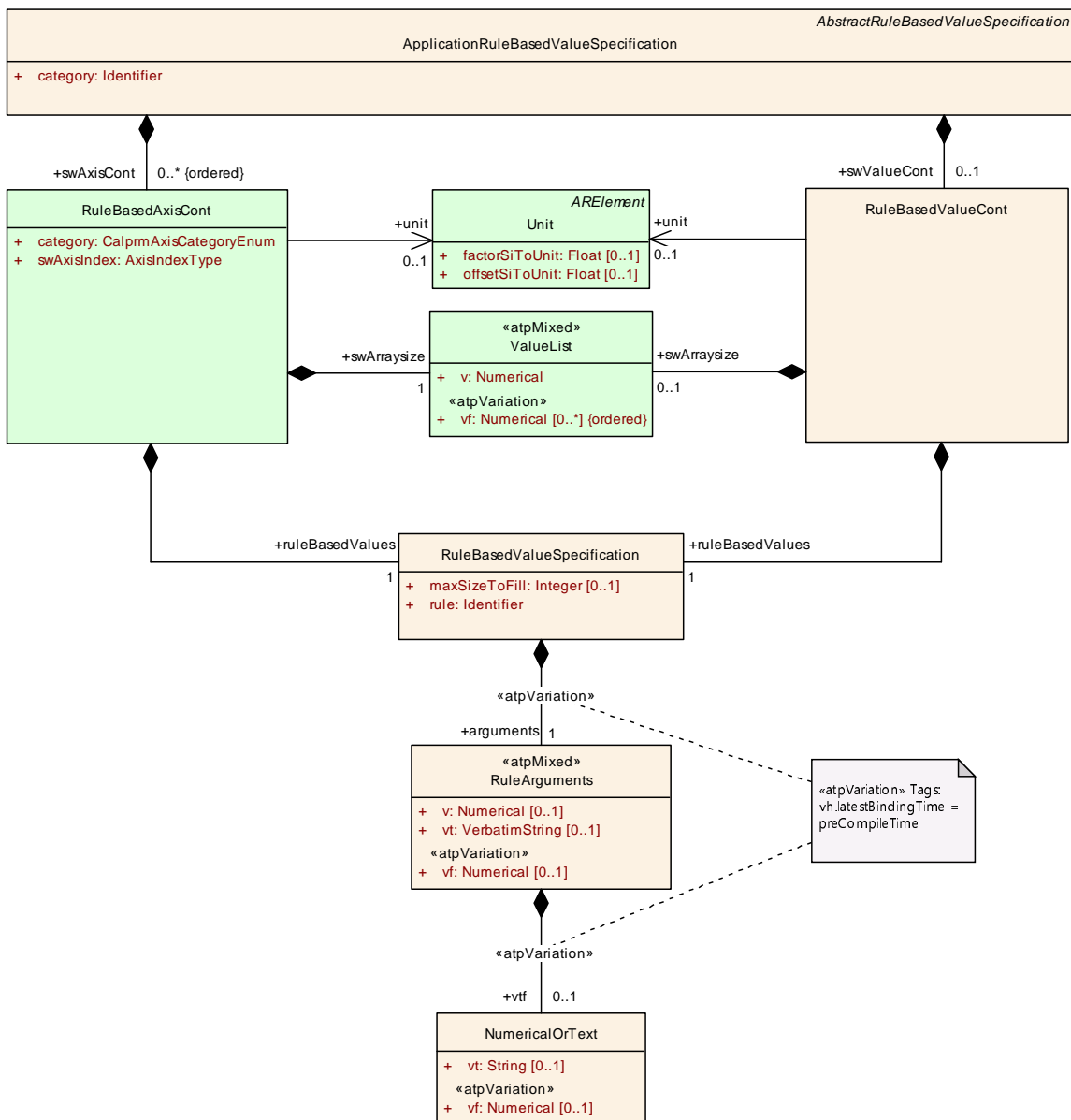

Figure 5.70: Definition of an **ApplicationRuleBasedValueSpecification**

[TPS_SWCT_01528] Meaning of **NumericalRuleBasedValueSpecification**
 [The purpose of the **NumericalRuleBasedValueSpecification** is to provide means for a compact provision of values for **DataPrototypes** that otherwise would require a high volume (in terms of serialized ARXML) of e.g. initialization data. **NumericalRuleBasedValueSpecification** may used for **DataPrototypes** typed by **ImplementationDataTypes** of category **ARRAY** or Compound Primitive Data Types mapped to **ImplementationDataTypes** of category **ARRAY**.] (*RS_SWCT_03260*)

Concerning `initValues` for Compound Primitive Data Types please note as well [TPS_SWCT_01185].

Class	NumericalRuleBasedValueSpecification			
Package	M2::AUTOSARTemplates::CommonStructure::Constants			
Note	This meta-class is used to support a rule-based initialization approach for data types with an array-nature (ImplementationDataType of category ARRAY).			
Base	<i>ARObject, AbstractRuleBasedValueSpecification, ValueSpecification</i>			
Attribute	Type	Mult.	Kind	Note
ruleBased Values	RuleBasedValueSpecification	1	aggr	This represents the rule based value specification for the array. Tags: xml.roleElement=true xml.roleWrapperElement=false xml.typeWrapperElement=false

Table 5.130: NumericalRuleBasedValueSpecification

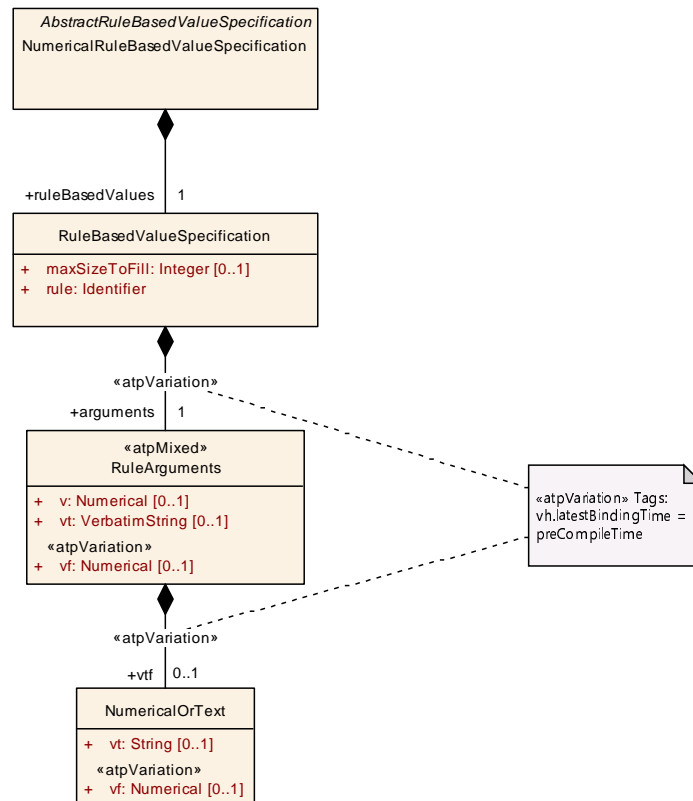

Figure 5.71: Definition of an NumericalRuleBasedValueSpecification

[TPS_SWCT_01495] **Standardized value of `RuleBasedValueSpecification.rule`** [AUTOSAR reserves a dedicated value of `RuleBasedValueSpecification.rule` in a standardized semantics:

- `FILL_UNTIL_END`
- `FILL_UNTIL_MAX_SIZE`

The meaning of this value of `rule` is explained in [TPS_SWCT_01494] and [TPS_SWCT_01609].] (*RS_SWCT_03260*, *RS_SWCT_03181*)

[TPS_SWCT_01485] **The order of `RuleArguments` arguments shall be respected** [The order of arguments in `RuleArguments` corresponds to the order of elements in the array, i.e. the first argument corresponds to the first element of the array, the second argument corresponds to the second element of the array, and so on.] (*RS_SWCT_03260*)

Please note that a single argument can be defined by the attributes

- `RuleArguments.v`
- `RuleArguments.vf`
- `RuleArguments.vt`
- `RuleArguments.vtf.vf`
- `RuleArguments.vtf.vt`

[TPS_SWCT_01493] **The number of `RuleBasedValueSpecification.arguments` shall not exceed the array size** [If the number of `RuleBasedValueSpecification.arguments` exceeds the number of elements of an array that it is applied to then the `RuleBasedValueSpecification.arguments` that go beyond the last element of the array shall be ignored.] (*RS_SWCT_03260*)

[TPS_SWCT_01494] **A `RuleBasedValueSpecification` of `rule FILL_UNTIL_END` shall fill the value of the last `RuleBasedValueSpecification.arguments` until the last element of the array** [The following rule applies to `RuleBasedValueSpecifications` of `rule FILL_UNTIL_END`:

If the number of `RuleBasedValueSpecification.arguments` is smaller than the number of elements of the array it is applied to then the value of the last `RuleBasedValueSpecification.arguments` shall be applied to any following element of the array until the last element of the array.] (*RS_SWCT_03260*)

[TPS_SWCT_01609] **A `RuleBasedValueSpecification` of `rule FILL_UNTIL_MAX_SIZE` shall fill the value of the last `RuleBasedValueSpecification.arguments` until the number of elements specified in `maxSizeToFill`** [The following rule applies to `RuleBasedValueSpecifications` of `rule FILL_UNTIL_MAX_SIZE`:

If the number of `RuleBasedValueSpecification.arguments` is smaller than the number of elements of the array it is applied to and smaller than `maxSizeToFill`, then

the value of the last `RuleBasedValueSpecification.arguments` shall be applied to so many of the following elements that the first `maxSizeToFill` elements of the array are filled.] (*RS_SWCT_03260*)

Class	RuleBasedValueSpecification			
Package	M2::AUTOSARTemplates::CommonStructure::Constants			
Note	This meta-class is used to support a rule-based initialization approach for data types with an array-nature (ApplicationArrayDataType and ImplementationDataType of category ARRAY) or a compound Application PrimitiveDataType (which also boils down to an array-nature).			
Base	ARObject			
Attribute	Type	Mult.	Kind	Note
arguments	RuleArguments	1	aggr	This represents the arguments for the RuleBasedValue Specification. Stereotypes: atpVariation Tags: vh.latestBindingTime=preCompileTime xml.sequenceOffset=30
maxSizeToFill	Integer	0..1	attr	If a rule is chosen which does not fill until the end, this determines until which size the rule shall fill the values. Tags: xml.sequenceOffset=40
rule	Identifier	1	attr	This denotes the name of the rule of the RuleBasedValue Specification. The rule determines the calculation specification according which the arguments are used to calculated the values. Tags: xml.sequenceOffset=20

Table 5.131: RuleBasedValueSpecification

Class	<<atpMixed>> RuleArguments			
Package	M2::AUTOSARTemplates::CommonStructure::Constants			
Note	This represents the arguments for a rule-based value specification.			
Base	ARObject			
Attribute	Type	Mult.	Kind	Note
v	Numerical	0..1	attr	This represents a numerical value for the RuleBased ValueSpecification.
vf	Numerical	0..1	attr	This represents a numerical value for the RuleBased ValueSpecification which may subject to variability. The latest binding time of the VariationPoint shall be pre CompileTime. Stereotypes: atpVariation Tags: vh.latestBindingTime=preCompileTime
vt	VerbatimString	0..1	attr	This represents a textual value for the RuleBasedValue Specification.
vtf	NumericalOrText	0..1	aggr	This aggregation represents the ability to provide a value that is either numerical or text which existence is subject to variability. Stereotypes: atpVariation Tags: vh.latestBindingTime=preCompileTime

Table 5.132: RuleArguments

5.6.2.2 Support for composite Data Types

[TPS_SWCT_01692] Meaning of [CompositeRuleBasedValueSpecification](#)
[The rule-based initialization of arrays of a composite data type is modeled by means of the [CompositeRuleBasedValueSpecification](#).] ([RS_SWCT_03260](#))

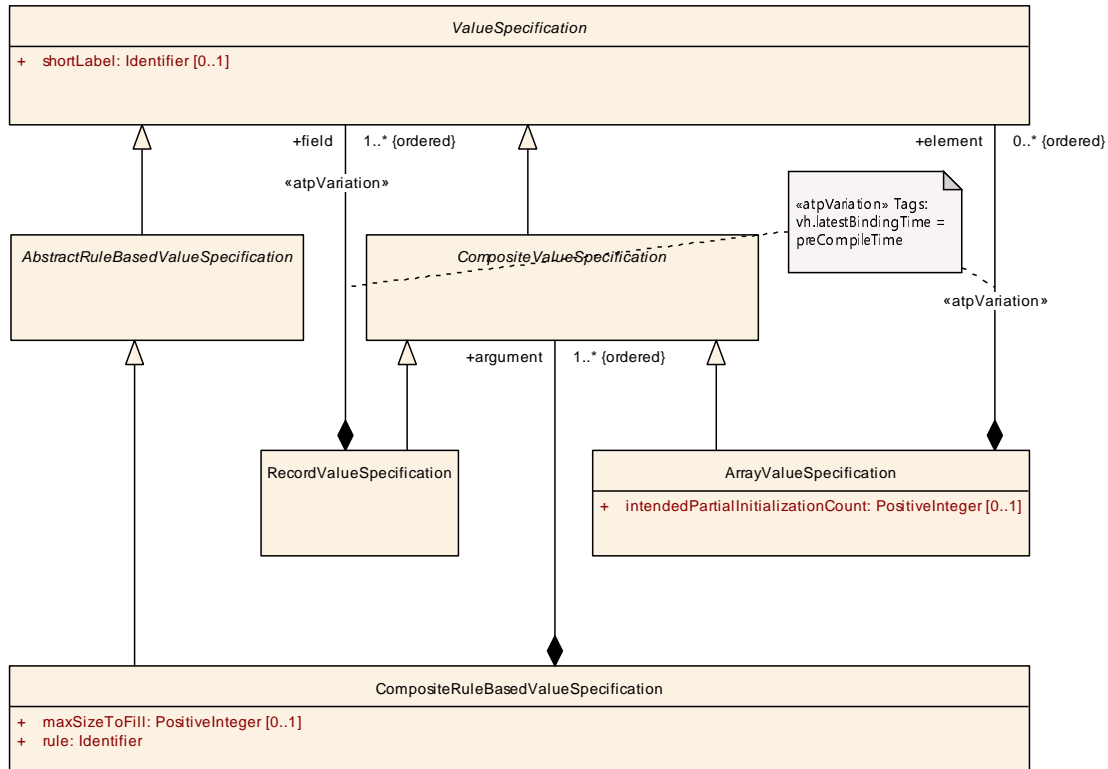

Figure 5.72: Rule-based value specification of arrays of a composite data type

Class	CompositeRuleBasedValueSpecification			
Package	M2::AUTOSARTemplates::CommonStructure::Constants			
Note	This meta-class represents rule based values for DataPrototypes typed by composite ApplicationData Types.			
Base	<i>ARObject</i> , <i>AbstractRuleBasedValueSpecification</i> , <i>ValueSpecification</i>			
Attribute	Type	Mult.	Kind	Note
argument (ordered)	CompositeValueSpecification	1..*	aggr	This represents the collection of aggregated Value Specifications. The last ValueSpecification in the collection shall be taken to execute the filling rule. Tags: xml.sequenceOffset=30
maxSizeToFill	PositiveInteger	0..1	attr	If a rule is chosen which does not fill until the end, this determines until which size the rule shall fill the values. Tags: xml.sequenceOffset=40





Class		CompositeRuleBasedValueSpecification		
rule	Identifier	1	attr	This denotes the name of the rule of the RuleBasedValue Specification. The rule determines the calculation specification according which the arguments are used to calculated the values. Tags: xml.sequenceOffset=20

Table 5.133: CompositeRuleBasedValueSpecification

As an example of how the rule-based initialization of composite data structures works, please consider the composite structure sketched in Figure 5.73. In simple terms, it describes an array consisting of elements that themselves are typed by a structure of two primitive elements.

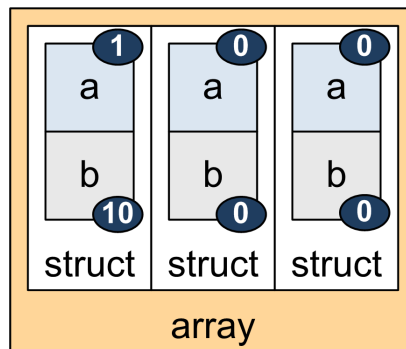

Figure 5.73: Example for the explanation of rule-based composite value-specification

In this example, the element “a” of the first structure shall be initialized with the value 1, the corresponding “b” element shall be assigned a 10. All other values in all following elements shall be set to 0. This is also indicated by the numbers in ellipses in Figure 5.73.

The implementation of the example in ARXML is illustrated in Listing 5.17. As already explained before, the last (in the order of appearance) *ValueSpecification* in the context of an *AbstractRuleBasedValueSpecification* is taken to execute the rule (as described above).

Listing 5.17: Example for composite rule-based value specification

```

<ARRAY-VALUE-SPECIFICATION>
  <ELEMENTS>
    <COMPOSITE-RULE-BASED-VALUE-SPECIFICATION>
      <RULE>FILL_UNTIL_END</RULE>
      <ARGUMENTS>
        <RECORD-VALUE-SPECIFICATION>
          <FIELDS>
            <APPLICATION-VALUE-SPECIFICATION>
              <SW-VALUE-CONT>
                <SW-VALUES-PHYS>
                  <V>1</V>
                </SW-VALUES-PHYS>
              </SW-VALUE-CONT>
            </FIELDS>
          </RECORD-VALUE-SPECIFICATION>
        </ARGUMENTS>
      </COMPOSITE-RULE-BASED-VALUE-SPECIFICATION>
    </ELEMENTS>
  </ARRAY-VALUE-SPECIFICATION>

```

```

</APPLICATION-VALUE-SPECIFICATION>
<APPLICATION-VALUE-SPECIFICATION>
  <SW-VALUE-CONT>
    <SW-VALUES-PHYS>
      <V>10</V>
    </SW-VALUES-PHYS>
  </SW-VALUE-CONT>
</APPLICATION-VALUE-SPECIFICATION>
</FIELDS>
</RECORD-VALUE-SPECIFICATION>
<RECORD-VALUE-SPECIFICATION>
  <FIELDS>
    <APPLICATION-VALUE-SPECIFICATION>
      <SW-VALUE-CONT>
        <SW-VALUES-PHYS>
          <V>0</V>
        </SW-VALUES-PHYS>
      </SW-VALUE-CONT>
    </APPLICATION-VALUE-SPECIFICATION>
    <APPLICATION-VALUE-SPECIFICATION>
      <SW-VALUE-CONT>
        <SW-VALUES-PHYS>
          <V>0</V>
        </SW-VALUES-PHYS>
      </SW-VALUE-CONT>
    </APPLICATION-VALUE-SPECIFICATION>
  </FIELDS>
</RECORD-VALUE-SPECIFICATION>
</ARGUMENTS>
</COMPOSITE-RULE-BASED-VALUE-SPECIFICATION>
</ELEMENTS>
</ARRAY-VALUE-SPECIFICATION>

```

A more complicated example is sketched in Figure 5.74. Here, a deeply nested composite data structure is described: an array of structures that in turn contain an array.

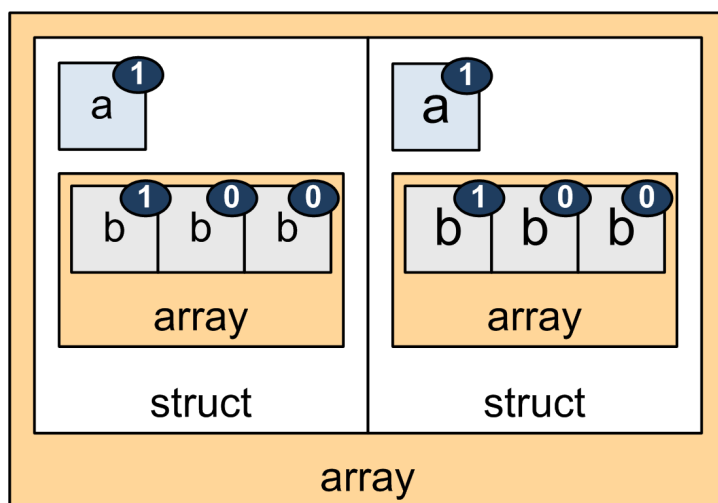

Figure 5.74: Value specification for a deeply nested array

To keep the ARXML listing as simple as possible, the example assumes that **all** (as opposed to the initialization of the first, and then of all other elements) “struct” elements shall be initialized with the same value.

The deeply nested “array” is initialized by means of an [ApplicationRuleBased-ValueSpecification](#).

Listing 5.18: Value specification for a deeply nested array

```

<ARRAY-VALUE-SPECIFICATION>
  <ELEMENTS>
    <COMPOSITE-RULE-BASED-VALUE-SPECIFICATION>
      <RULE>FILL_UNTIL_END</RULE>
      <ARGUMENTS>
        <RECORD-VALUE-SPECIFICATION>
          <FIELDS>
            <APPLICATION-VALUE-SPECIFICATION>
              <SW-VALUE-CONT>
                <SW-VALUES-PHYS>
                  <V>1</V>
                </SW-VALUES-PHYS>
              </SW-VALUE-CONT>
            </APPLICATION-VALUE-SPECIFICATION>
          <ARRAY-VALUE-SPECIFICATION>
            <ELEMENTS>
              <APPLICATION-RULE-BASED-VALUE-SPECIFICATION>
                <SW-VALUE-CONT>
                  <RULE-BASED-VALUES>
                    <RULE>FILL_UNTIL_END</RULE>
                    <ARGUMENTSS>
                      <RULE-ARGUMENTS>
                        <V>1</V>
                        <V>0</V>
                      </RULE-ARGUMENTS>
                    </ARGUMENTSS>
                  </RULE-BASED-VALUES>
                </SW-VALUE-CONT>
              </APPLICATION-RULE-BASED-VALUE-SPECIFICATION>
            </ELEMENTS>
          </ARRAY-VALUE-SPECIFICATION>
        </FIELDS>
      </RECORD-VALUE-SPECIFICATION>
    </ARGUMENTS>
  </COMPOSITE-RULE-BASED-VALUE-SPECIFICATION>
</ELEMENTS>
</ARRAY-VALUE-SPECIFICATION>

```

Please note that the usage of [RuleBasedValueSpecification](#) and [CompositeRuleBasedValueSpecification](#) is, to some extent, interchangeable. This is illustrated by the following example:

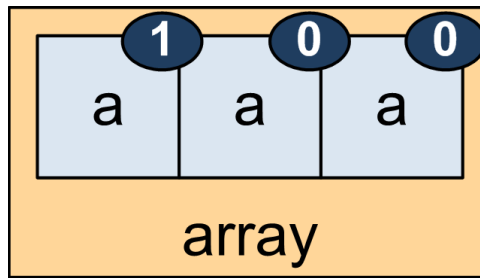

Figure 5.75: Value specification for a simple array

Listing 5.19: Value specification for a simple array, the “composite” way

```

<ARRAY-VALUE-SPECIFICATION>
  <ELEMENTS>
    <COMPOSITE-RULE-BASED-VALUE-SPECIFICATION>
      <RULE>FILL_UNTIL_END</RULE>
      <ARGUMENTS>
        <ARRAY-VALUE-SPECIFICATION>
          <ELEMENTS>
            <APPLICATION-VALUE-SPECIFICATION>
              <SW-VALUE-CONT>
                <SW-VALUES-PHYS>
                  <V>1</V>
                </SW-VALUES-PHYS>
              </SW-VALUE-CONT>
            </APPLICATION-VALUE-SPECIFICATION>
            <APPLICATION-VALUE-SPECIFICATION>
              <SW-VALUE-CONT>
                <SW-VALUES-PHYS>
                  <V>0</V>
                </SW-VALUES-PHYS>
              </SW-VALUE-CONT>
            </APPLICATION-VALUE-SPECIFICATION>
          </ELEMENTS>
        </ARRAY-VALUE-SPECIFICATION>
      </ARGUMENTS>
    </COMPOSITE-RULE-BASED-VALUE-SPECIFICATION>
  </ELEMENTS>
</ARRAY-VALUE-SPECIFICATION>

```

For clarification, Listing 5.19 implements the rule-based initialization of the example array by means of a [CompositeRuleBasedValueSpecification](#), whereas Listing 5.20 uses an [ApplicationRuleBasedValueSpecification](#).

Listing 5.20: Value specification for a simple array, the “primitive” way

```

<ARRAY-VALUE-SPECIFICATION>
  <ELEMENTS>
    <APPLICATION-RULE-BASED-VALUE-SPECIFICATION>
      <SW-VALUE-CONT>
        <RULE-BASED-VALUES>
          <RULE>FILL_UNTIL_END</RULE>
          <ARGUMENTSS>
            <RULE-ARGUMENTS>
              <V>1</V>
            </RULE-ARGUMENTS>
          </ARGUMENTSS>
        </RULE-BASED-VALUES>
      </SW-VALUE-CONT>
    </APPLICATION-RULE-BASED-VALUE-SPECIFICATION>
  </ELEMENTS>
</ARRAY-VALUE-SPECIFICATION>

```

```

        <V>0</V>
    </RULE-ARGUMENTS>
</ARGUMENTSS>
</RULE-BASED-VALUES>
</SW-VALUE-CONT>
</APPLICATION-RULE-BASED-VALUE-SPECIFICATION>
</ELEMENTS>
</ARRAY-VALUE-SPECIFICATION>

```

AUTOSAR intentionally supports both alternatives (i.e. as implemented in Listing 5.19 and in Listing 5.20)

5.6.3 Reference to Constant

Note the specific meaning of `ConstantReference`: it passes the definition of the value on to a `ConstantSpecification` that is defined as part of an AUTOSAR `ARPackage`.

Class	<code>ConstantReference</code>			
Package	M2::AUTOSARTemplates::CommonStructure::Constants			
Note	Instead of defining this value inline, a constant is referenced.			
Base	<code>ARObject</code> , <code>ValueSpecification</code>			
Attribute	Type	Mult.	Kind	Note
constant	<code>ConstantSpecification</code>	1	ref	The referenced constant.

Table 5.134: ConstantReference

5.6.4 Values for Variable-Size Array

Variable-size data types have the ability to change the number of valid elements at run-time. However, in many situations it is necessary to define an `ArrayValueSpecification` for such a data type.

An `ArrayValueSpecification` that can be used for a *variable-size array* data type needs to be able to handle the following cases:

- Full initialization of the entire array-data type. This case is identical to the creation of a `ArrayValueSpecification` for a fixed-size array data type.
- Provision of values for the **first n elements** of the *variable-size array*. This case is also known as *partial initialization*.
- Creation of an empty `ArrayValueSpecification`, i.e. an `ArrayValueSpecification` carries the semantics of intentionally initializing 0 elements of a *variable-size array*. Note the semantical difference between not initializing at all and intentionally initializing 0 elements of the *variable-size array*.

All the described cases shall be supported by AUTOSAR. As already described, the existence of an `ArrayValueSpecification` with the full number of elements is identical to the fixed size case. The "empty" case could be seen as a subset of the partial initialization.

The partial initialization of *variable-size arrays* has two facets:

[TPS_SWCT_01793] Initialization of a *variable-size array* typed by an `ImplementationDataType` [A *variable-size array* that is modeled by means of an `ImplementationDataType` is actually existing as a structure consisting of a *size indicator* and an *array that carries the payload*.

Therefore, the *partial initialization* shall be implemented by explicitly initializing the *size indicator* to a value between 0 and the applicable `ImplementationDataTypeElement.arraySize` and provide the corresponding number of `ValueSpecifications` for the *payload*.] ([RS_SWCT_03175](#), [RS_SWCT_03181](#))

[TPS_SWCT_01794] Initialization of a *variable-size array* typed by an `ApplicationArrayDataType` [A *variable-size array* that is modeled by means of an `ApplicationArrayDataType` where attribute `arraySizeSemantics` is set to `variableSize` does not contain any size-indicator element and therefore requires a different approach for *partial initialization*.

For this purpose, `ArrayValueSpecification.intendedPartialInitializationCount` shall be used for the specification of the number of elements that shall be initialized.] ([RS_SWCT_03175](#), [RS_SWCT_03181](#))

The applicability of attribute `ArrayValueSpecification.intendedPartialInitializationCount` is limited to the use case of initializing a *variable-size array* typed by an `ApplicationArrayDataType`. AUTOSAR does not foresee any other use case for this attribute.

[constr_1712] Existence of attribute `ArrayValueSpecification.intendedPartialInitializationCount` [An `ArrayValueSpecification` where attribute `intendedPartialInitializationCount` exists shall only be applied for the initialization of an `ApplicationArrayDataType` where attribute `arraySizeSemantics` is set to `variableSize`.] ()

[constr_1273] Rules for the initialization of `ApplicationArrayDataType` by means of `ArrayValueSpecification` [The following rules apply for the initialization of a `DataPrototype` typed by an `ApplicationArrayDataType` by means of an `ArrayValueSpecification`:

- If the attribute `ApplicationArrayDataType.element.arraySizeSemantics` is set to `fixedSize` then the `ArrayValueSpecification` shall exactly match the structure of the `ApplicationArrayDataType`.

This means that the number of `ArrayValueSpecification.elements` shall be identical to the value of `ApplicationArrayDataType.element.maxNumberOfElements`.

- If the attribute `ApplicationArrayType.element.arraySizeSemantics` is set to **variableSize** and the `ArrayValueSpecification` **does not define** attribute `intendedPartialInitializationCount` then `ArrayValueSpecification` shall **exactly** match the structure of the `ApplicationArrayType`.

This means that the number of `ArrayValueSpecification.elements` shall be identical to the value of `ApplicationArrayType.element.maxNumberOfElements`.

- If the attribute `ApplicationArrayType.element.arraySizeSemantics` is set to **variableSize** and the `ArrayValueSpecification` specifies a value for attribute `intendedPartialInitializationCount` then `ArrayValueSpecification` shall contain **exactly** `intendedPartialInitializationCount` elements.

This includes the case that the value of `intendedPartialInitializationCount` is set to 0 (i.e. "empty" initialization) and the case that the `intendedPartialInitializationCount` is set to the value of the respective `ApplicationArrayElement.maxNumberOfElements` (i.e. "full" initialization).

]()

[constr_1274] Rules for the initialization of array-shaped `ImplementationDataType` by means of `ArrayValueSpecification` [The following rules apply for the initialization of a `DataPrototype` typed by an `ImplementationDataType` of category ARRAY by means of an `ArrayValueSpecification`:

- If the attribute `ImplementationDataType.subElement.arraySizeSemantics` is set to **fixedSize** then the `ArrayValueSpecification` shall exactly match the structure of the `ImplementationDataType`.

This means that the number of `ArrayValueSpecification.elements` shall be identical to the value of `ImplementationDataType.subElement.arraySize`.

- If the attribute `ImplementationDataType.subElement.arraySizeSemantics` is set to **variableSize** and the `ArrayValueSpecification` **does not define** attribute `intendedPartialInitializationCount` then `ArrayValueSpecification` shall **exactly** match the structure of the `ApplicationArrayType`.

This means that the number of `ArrayValueSpecification.elements` shall be identical to the value of `ImplementationDataType.subElement.arraySize`.

- If the attribute `ImplementationDataType.subElement.arraySizeSemantics` is set to **variableSize** and the `ArrayValueSpecification` specifies a value for attribute `intendedPartialInitializationCount` then `ArrayValueSpecification` shall contain **exactly** `intendedPartialInitializationCount` elements.

This includes the case that the value of `intendedPartialInitializationCount` is set to 0 (i.e. "empty" initialization) and the case that the `intendedPartialInitializationCount` is set to the value of the respective `ImplementationDataTypeElement.arraySize` (i.e. "full" initialization).

]()

Please note that the *partial initialization* of a *variable-size array* is also supported by means of using an `ApplicationRuleBasedValueSpecification` (for the case that an `ApplicationArrayType` is used to model the *variable-size array*) or a `NumericalRuleBasedValueSpecification` (for the case that a `ImplementationDataType` is used to model the *variable-size array*).

More details can be found in section 5.6.2.

5.6.5 Values for Compound Primitive Data Types

[TPS_SWCT_01180] Maximum possible size of Compound Primitive Data Type [Note that if the size of the Compound Primitive Data Type (see [TPS_SWCT_01179]) (curve/map) is defined using an `AttributeValueVariationPoint` (in other words `swMaxAxisPoints`, `swValueBlockSize`, `swValueBlockSizeMult` dependent on the value of `SwSystemconst`) the `initValue` shall provide the maximum possible amount of values.] ([RS_SWCT_03216](#))

In this case it is the responsibility of model author to ensure that the size of the specified init values matches the range of the involved system constants.

Class	SwSystemconst			
Package	M2::MSR::DataDictionary::SystemConstant			
Note	<p>This element defines a system constant which serves an input to select a particular variation point. In particular a system constant serves as an operand of the binding function (<code>swSyscond</code>) in a Variation point.</p> <p>Note that the binding process can only happen if a value was assigned to to the referenced system constants.</p> <p>Tags:atp.recommendedPackage=SwSystemconsts</p>			
Base	ARElement , ARObject , AtpDefinition , CollectableElement , Identifiable , MultilanguageReferrable , PackageableElement , Referrable			
Attribute	Type	Mult.	Kind	Note
swDataDef Props	SwDataDefProps	0..1	aggr	<p>This denotes the data defintion properties of the system constant. This supports to express the limits and optionally a conversion within the internal to physical values by a compu method.</p> <p>Tags:xml.sequenceOffset=40</p>

Table 5.135: SwSystemconst

[constr_1160] Size of Compound Primitive Data Type is variant [For Compound Primitive Data Types (see [TPS_SWCT_01179]) where the size is subject to variation the size of the specified `initValues` shall match the range of the involved `SwSystemconst`.]()

[TPS_SWCT_01181] Bound model specifies a primitive which is smaller than the maximum defined by the range of the involved `SwSystemconst` [The processing tools shall take the lower part of the `initValues` in case the bound model specifies a primitive which is smaller than the maximum defined by the range of the involved `SwSystemconst`.] (*RS_SWCT_03216, RS_SWCT_03148*)

The consequences of [TPS_SWCT_01181] are exemplified by Figure 5.76.

[constr_2050] Mandatory information of a `SwAxisCont` [If the attribute `swAxisCont` is defined for an `ApplicationValueSpecification` the `SwAxisCont` shall define one `swAxisIndex` value and one `swArraysize` value per dimension, even in the case when the owning `ApplicationValueSpecification` defines only the content of a single dimensional object like a CURVE.] ()

[constr_2051] Mandatory information of a `SwValueCont` [If the attribute `swValueCont` is defined for an `ApplicationValueSpecification` the `SwValueCont` shall always define the attribute `swArraysize` if the `ApplicationValueSpecification` is of category CURVE, MAP, CUBOID, CUBE_4, CUBE_5, COM_AXIS, RES_AXIS, or VAL_BLK.] ()

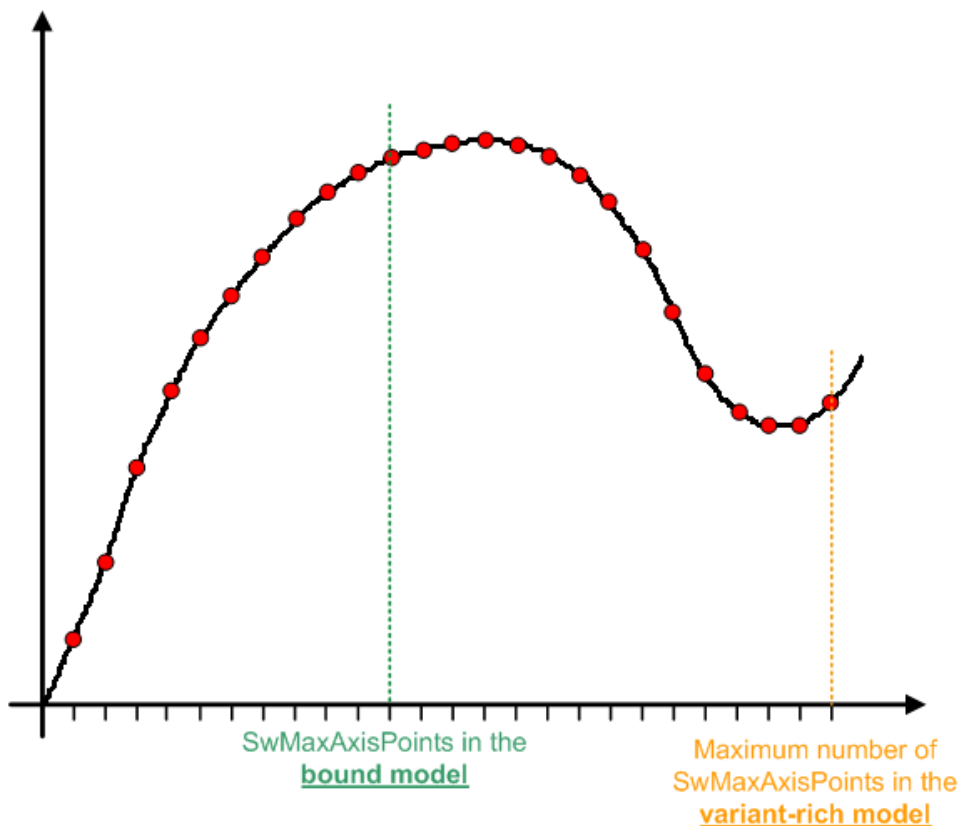

Figure 5.76: Explanation of `swMaxAxisPoints`

Please note that for multidimensional Compound Primitive Types (e.g. MAP) it is necessary to know the dimensions in order to be able to process the `SwValues`. `[constr_2050]` and `[constr_2051]` shall support a consistent handling of single and multidimensional Compound Primitive Data Types.

`[constr_2052]` Values of `swArraysize` and the number of values provided by `swValuesPhys` shall be consistent. `[swValuesPhys` shall define as many numbers of values as the `swArraysize` defines.

In other words, in the bound model the number of descendants (`v`, or `vf`, or `vt`, or `vtf`) shall be identical to the number of elements of the related `DataPrototype` typed by an `ApplicationPrimitiveDataType`.

If several `swArraysize` values are provided, these have to be multiplied in order to get the total number of `swValuesPhys` values. `()`

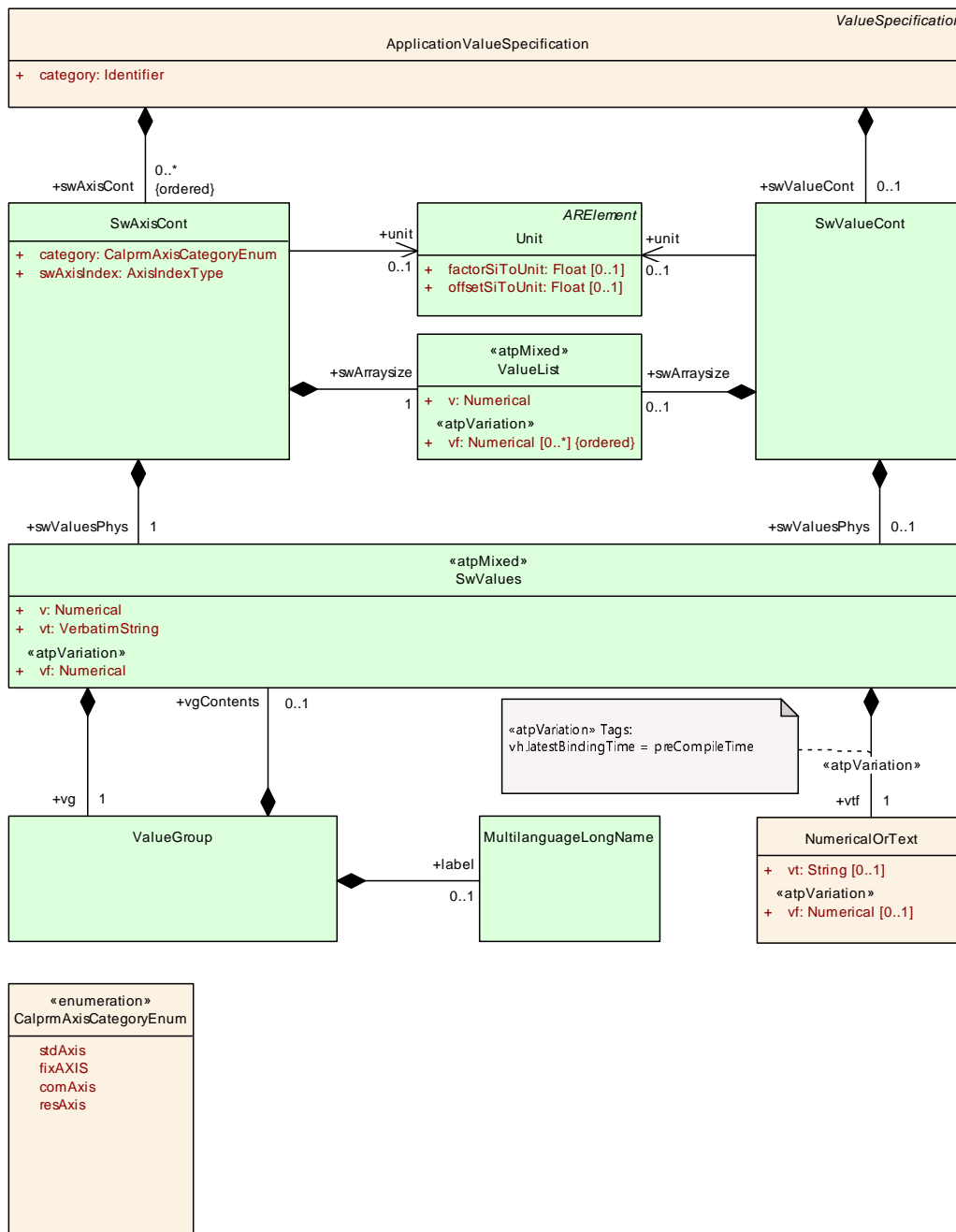

Figure 5.77: Definition of an **ApplicationValueSpecification**

Please note that case of Compound Primitive Data Types typically the attribute `swValuesPhys` defines more than one value. [constr_2051] and [constr_2052] shall enable a consistent handling of the `swValuesPhys` values regardless how many dimensions the related Compound Primitive Type defines.

If the `ApplicationValueSpecification` defines values for a Compound Primitive Data Type with more than one input axis the `swArraysize` gets mandatory to ensure the correct processing of the `swValuesPhys` values independent of the existence of `SwValues.vg`.

[TPS_SWCT_02001] Values of **SwAxisCont** with the **category COM_AXIS, RES_AXIS** are for display only [In case of **ApplicationValueSpecifications** of category **MAP, CUBOID, CUBE_4, CUBE_5, and CURVE** it is possible that the **SwAxisCont** of axes can be omitted if the axis is of **category COM_AXIS or RES_AXIS**.

If **SwAxisCont** values exists in such cases for the axes these are for display purpose only because the related **DataPrototype** of the **MAP, CUBOID, CUBE_4, CUBE_5, or CURVE** does not hold the values of such axes. These are properties of the **DataPrototype** of the **COM_AXIS or RES_AXIS**.]()

Hence, values of the **COM_AXIS** itself are described by **SwValueCont**.

[constr_1243] **NumericalOrText** shall either define **vf** or **vt** [Within the context of one **NumericalOrText**, either the attribute **vf** or the attribute **vt** shall be defined. The existence of both attributes at the same time is not permitted.]()

[constr_1519] Existence of attributes vs. **category** of **ApplicationValueSpecification** [The existence of attributes of meta-class **ApplicationValueSpecification** vs. the value of **category** is regulated by Table 5.136.]()

Attribute of ApplicationValueSpecification	Attribute Existence per Category									
	VALUE	STRING	BOOLEAN	COM_AXIS	RES_AXIS	CURVE	MAP	CUBOID	CUBE_4	CUBE_5
swValueCont	D	D	D	D	D	D	D	D	D	D
swValueCont.unit	O	O	O	O	O	O	O	O	O	O
swValueCont.swValuesPhys	D	D	D	D	D	D	D	D	D	D
swValueCont.swArraysize	N/A	N/A	N/A	D	D	D	D	D	D	D
swAxisCont	N/A	N/A	N/A	N/A	D	D	D	D	D	D
swAxisCont.unit	N/A	N/A	N/A	N/A	O	O	O	O	O	O
swAxisCont.category	N/A	N/A	N/A	N/A	D	D	D	D	D	D
swAxisCont.swAxisIndex	N/A	N/A	N/A	N/A	D	D	D	D	D	D
swAxisCont.swArraysize	N/A	N/A	N/A	N/A	D	D	D	D	D	D
swAxisCont.swValuesPhys	N/A	N/A	N/A	N/A	D	O(1)	O(1)	O(1)	O(1)	O(1)

Table 5.136: Allowed Attributes vs. category for ApplicationValueSpecification

The following legend applies to the cells in table 5.136:

D Define the attribute.

N/A Attribute is **not applicable** for usage in the scope of this element.

O **Optionally** define the attribute.

In addition to the primary cell legend the following annotations apply to the cells in table 5.79:

(1) Optional if **COM_AXIS** or **RES_AXIS** is used, otherwise attribute shall exist.

Class	ApplicationValueSpecification			
Package	M2::AUTOSARTemplates::CommonStructure::Constants			
Note	<p>This meta-class represents values for DataPrototypes typed by ApplicationDataTypes (this includes in particular compound primitives).</p> <p>For further details refer to ASAM CDF 2.0. This meta-class corresponds to some extent with SW-INSTANCE in ASAM CDF 2.0.</p>			
Base	<i>ARObject</i> , <i>ValueSpecification</i>			
Attribute	Type	Mult.	Kind	Note
category	Identifier	1	attr	Specifies to which category of ApplicationDataType this ApplicationValueSpecification can be applied (e.g. as an initial value), thus imposing constraints on the structure and semantics of the contained values, see [constr_1006] and [constr_2051].
swAxisCont (ordered)	SwAxisCont	*	aggr	<p>This represents the axis values of a Compound Primitive Data Type (curve or map).</p> <p>The first swAxisCont describes the x-axis, the second swAxisCont describes the y-axis, the third swAxisCont describes the z-axis. In addition to this, the axis can be denoted in swAxisIndex.</p>
swValueCont	SwValueCont	0..1	aggr	This represents the values of a Compound Primitive Data Type.

Table 5.137: ApplicationValueSpecification

Class	SwAxisCont			
Package	M2::MSR::CalibrationData::CalibrationValue			
Note	<p>This represents the values for the axis of a compound primitive (curve, map).</p> <p>For standard and fix axes, SwAxisCont contains the values of the axis directly.</p> <p>The axis values of SwAxisCont with the category COM_AXIS, RES_AXIS are for display only. For editing and processing, only the values in the related GroupAxis are binding.</p>			
Base	<i>ARObject</i>			
Attribute	Type	Mult.	Kind	Note
category	CalprmAxisCategory Enum	1	attr	<p>This category specifies the particular axis types:</p> <ul style="list-style-type: none"> • STD_AXIS • COM_AXIS • RES_AXIS (swArraysize necessary) <p>Tags:xml.sequenceOffset=20</p>
swArraysize	ValueList	1	aggr	<p>For multidimensional compound primitives (curve, map ...) it is necessary to know the dimensions. They are specified using swArraySize.</p> <ul style="list-style-type: none"> • RES_AXIS <p>Tags:xml.sequenceOffset=70</p>
swAxisIndex	AxisIndexType	1	attr	<p>This property allows to explicitly assign the axis contents to a particular axis. It is specified by numbers where 1 corresponds to the x-axis. It is also possible to derive the axis association from the sequence of the parent.</p> <p>Tags:xml.sequenceOffset=50</p>
swValuesPhys	SwValues	1	aggr	<p>swValuesPhys represents the values in the physical domain.</p> <p>Tags:xml.sequenceOffset=80</p>





Class		SwAxisCont		
unit	Unit	0..1	ref	This represents the physical unit of the provided values. Tags: xml.sequenceOffset=30
unitDisplay Name	SingleLanguageUnit Names	0..1	aggr	This represents the display name which is used for the physical unit of the axis. Tags: xml.sequenceOffset=40

Table 5.138: SwAxisCont

Class		SwValueCont		
Package		M2::MSR::CalibrationData::CalibrationValue		
Note		This metaclass represents the content of one particular SwInstance.		
Base		ARObject		
Attribute	Type	Mult.	Kind	Note
swArraysizes	ValueList	0..1	aggr	This attribute defines the size of each dimension for compound primitives CURVE, MAP, CUBOID, CUBE_4, CUBE_5, COM_AXIS, RES_AXIS, VAL_BLK, STRING. For each dimension one value has to be defined, e.g. one in case of COM_AXIS and two or more in case of MAP. Tags: xml.sequenceOffset=40
swValuesPhys	SwValues	0..1	aggr	swValuesPhys represents the values in the physical domain. Tags: xml.sequenceOffset=50
unit	Unit	0..1	ref	This represents the physical unit of the provided values. Tags: xml.sequenceOffset=20
unitDisplay Name	SingleLanguageUnit Names	0..1	aggr	This specifies how the physical units of the current value set shall be displayed in documents or in user interfaces of tools. Tags: xml.sequenceOffset=30

Table 5.139: SwValueCont

Class		<<atpMixed>> SwValues		
Package		M2::MSR::CalibrationData::CalibrationValue		
Note		This meta-class represents a list of values. These values can either be the input values of a curve (abscissa values) or the associated values (ordinate values). In case of multidimensional structures, the values are ordered such that the lowest index runs the fastest. In particular for maps and cuboids etc. the resulting long value list can be subsectioned using Value Group. But the processing needs to be done as if vg is not there. Note that numerical values and textual values should not be mixed.		
Base		ARObject		
Attribute	Type	Mult.	Kind	Note
v	Numerical	1	attr	This is a non variant Value. It is provided for sake of Compatibility to ASAM CDF. Tags: xml.sequenceOffset=40





Class	<<atpMixed>> SwValues			
vf	Numerical	1	attr	This allows to specify the value as VariationPoint. It is distinguished to non variant for sake of compatibility to ASAM CDF 2.0. Stereotypes: atpVariation Tags: vh.latestBindingTime=preCompileTime xml.sequenceOffset=20
vg	ValueGroup	1	aggr	This allows to have intersections in the values in order to support specific rendering (eg. using stylesheets). For tools it is important that the v values are always processed in the same (flattened) order and the tool is able to interpret it without respecting vg. Tags: xml.sequenceOffset=50
vt	VerbatimString	1	attr	This represents the values of textual data elements (Strings). Note that vt uses the to separate the values for the different bitfield masks in case that the semantics of the related DataPrototype is described by means of a BITFIELD_TEXTTABLE in the associated CompuMethod. Tags: xml.sequenceOffset=30
vtf	NumericalOrText	1	aggr	This aggregation represents the ability to provide a value that is either numerical or text which existence is subject to variability. From the formal point of view, the aggregation needs to have the multiplicity 1 because SwValues is modelled with stereotype <<atpMixed>>. Nevertheless, the existence of vtf is optional and subject to constraints. Stereotypes: atpVariation Tags: vh.latestBindingTime=preCompileTime

Table 5.140: SwValues

Class	ValueGroup			
Package	M2::MSR::CalibrationData::CalibrationValue			
Note	This element enables values to be grouped. It can be used to perform row and column-orientated groupings, so that these can be rendered properly e.g. as a table.			
Base	ARObject			
Attribute	Type	Mult.	Kind	Note
label	MultilanguageLong Name	0..1	aggr	This label allows to give the valueGroup a particular name. It can be used if the Values are rendered as a table. Tags: xml.sequenceOffset=20
vgContents	SwValues	0..1	aggr	This represents the contents of the value group. Tags: xml.roleElement=false xml.roleWrapperElement=false xml.sequenceOffset=30 xml.typeElement=false xml.typeWrapperElement=false

Table 5.141: ValueGroup

Class	<<atpMixed>> ValueList			
Package	M2::MSR::DataDictionary::DataDefProperties			
Note	This is a generic list of numerical values.			
Base	<i>ARObject</i>			
Attribute	Type	Mult.	Kind	Note
v	Numerical	1	attr	This is a particular numerical value without variation. Tags: xml.sequenceOffset=30
vf (ordered)	Numerical	*	attr	This is one entry in the list of numerical values Stereotypes: atpVariation Tags: vh.latestBindingTime=preCompileTime xml.roleElement=true xml.roleWrapperElement=false xml.typeElement=false xml.typeWrapperElement=false

Table 5.142: ValueList

Class	NumericalOrText			
Package	M2::AUTOSARTemplates::CommonStructure::Constants			
Note	This meta-class represents the ability to yield either a numerical or a string. A typical use case is that two or more instances of this meta-class are aggregated with a VariationPoint where some instances yield strings while other instances yield numerical depending on the resolution of the binding expression.			
Base	<i>ARObject</i>			
Attribute	Type	Mult.	Kind	Note
vf	Numerical	0..1	attr	This attribute represents the ability to provide a numerical value. The latest binding time of the VariationPoint shall be preCompileTime. Stereotypes: atpVariation Tags: vh.latestBindingTime=preCompileTime xml.sequenceOffset=10
vt	String	0..1	attr	This attribute represents the ability to provide a textual value. Tags: xml.sequenceOffset=20

Table 5.143: NumericalOrText

5.6.6 Values for BITFIELD_TEXTTABLE

A [CompuMethod](#) of [category BITFIELD_TEXTTABLE](#) effectively defines a data type where single bits or a set of single bits have an individual meaning.

In other words, the definition of a [ValueSpecification](#) according to a [CompuMethod](#) of [category BITFIELD_TEXTTABLE](#) translates into the statement: “each unique value of attribute [CompuScale.mask](#) (because this is how the single bits or sets of single bits are identified) in the context of the enclosing [CompuMethod](#) delivers one contribution to the definition of the [ValueSpecification](#)”.

[TPS_SWCT_01792] Initialization of a **DataPrototype** associated with a **CompuMethod** of category **BITFIELD_TEXTTABLE** [The initialization of a **DataPrototype** associated with a **CompuMethod** of category **BITFIELD_TEXTTABLE** requires the simultaneous initialization of all single bits or sets of bits represented by the respective definition of bitmask.

Access to the elements is possible by using bit-operations, therefore the initialization needs to be defined in a way that bit-operations can be used to apply the provided value.

In other words, the overall value shall be created out of bitwise or-ing (represented by the usage of the “|” symbol) contributions from the individual subsets.]()

Listing 5.21 shows the definition of an **ApplicationValueSpecification** that can be taken e.g. for the initialization of a **DataPrototype** typed by an **ApplicationDataType** that refers to a **CompuMethod** of category **BITFIELD_TEXTTABLE**.

Listing 5.21: Example for the definition of an **ApplicationValueSpecification for **BITFIELD_TEXTTABLE****

```
<APPLICATION-VALUE-SPECIFICATION>
  <SHORT-LABEL>tirePressureInit</SHORT-LABEL>
  <CATEGORY>VALUE</CATEGORY>
  <SW-VALUE-CONT>
    <SW-VALUES-PHYS>
      <VT>problem_low_Pressure|rearRight_yes|rearLeft_yes|frontRight_no|
        frontLeft_no</VT>
    </SW-VALUES-PHYS>
  </SW-VALUE-CONT>
</APPLICATION-VALUE-SPECIFICATION>
```

Listing 5.22 shows the definition of an **TextValueSpecification** that can be taken e.g. for the initialization of a **DataPrototype** typed by an **ImplementationDataType** that refers to a **CompuMethod** of category **BITFIELD_TEXTTABLE**.

Listing 5.22: Example for the definition of a **TextValueSpecification for **BITFIELD_TEXTTABLE****

```
<TEXT-VALUE-SPECIFICATION>
  <SHORT-LABEL>tirePressureInit</SHORT-LABEL>
  <VALUE>problem_low_Pressure|rearRight_yes|rearLeft_yes|frontRight_no|
    frontLeft_no</VALUE>
</TEXT-VALUE-SPECIFICATION>
```

Listing 5.23 shows the definition of an **NumericalValueSpecification** that can be taken e.g. for the initialization of a **DataPrototype** typed by an **ImplementationDataType** that refers to a **CompuMethod** of category **BITFIELD_TEXTTABLE**.

Listing 5.23: Example for the definition of a **NumericalValueSpecification for **BITFIELD_TEXTTABLE****

```
<NUMERICAL-VALUE-SPECIFICATION>
  <SHORT-LABEL>tirePressureInit</SHORT-LABEL>
  <VALUE>42</VALUE>
</NUMERICAL-VALUE-SPECIFICATION>
```

Please note that areas of the initialized `DataPrototype` that are not covered by the bit-masks may contain arbitrary values. If this needs to be avoided, it is necessary to add “dummy” bit-masks to the semantically not relevant parts of the value of the `DataPrototype`.

5.6.7 Examples

5.6.7.1 Example for Constant Specification for CURVE

The following example illustrates how a `ConstantSpecification` is specified for a `CURVE`. Please note, that in this example the `vf` attribute is used for the `swArraysize` as well as for the `swValuesPhys`. The basic intention of `vf` is the usage for variant rich models but it is valid as well if `vf` contains invariant values.

Listing 5.24: Example for Constant Specification for CURVE

```

<CONSTANT-SPECIFICATION>
  <SHORT-NAME>PhysInitValuesOfCurve</SHORT-NAME>
  <DESC>
    <L-2 L="EN">This example shows a ConstantSpecification for a
      CURVE where the axis is a STD_AXIS</L-2>
  </DESC>
  <VALUE-SPEC>
    <APPLICATION-VALUE-SPECIFICATION>
      <CATEGORY>CURVE</CATEGORY>
      <SW-AXIS-CONTS>
        <SW-AXIS-CONT>
          <CATEGORY>STD_AXIS</CATEGORY>
          <SW-AXIS-INDEX>1</SW-AXIS-INDEX>
          <SW-ARRAYSIZE>
            <VF>4</VF>
          </SW-ARRAYSIZE>
          <SW-VALUES-PHYS>
            <VF>0</VF>
            <VF>1</VF>
            <VF>2</VF>
            <VF>3</VF>
          </SW-VALUES-PHYS>
        </SW-AXIS-CONT>
      </SW-AXIS-CONTS>
      <SW-VALUE-CONT>
        <UNIT-REF DEST="UNIT">/Units/NwtMtr</UNIT-REF>
        <SW-ARRAYSIZE>
          <VF>4</VF>
        </SW-ARRAYSIZE>
        <SW-VALUES-PHYS>
          <VF>00.000</VF>
          <VF>10.000</VF>
          <VF>20.000</VF>
          <VF>30.000</VF>
        </SW-VALUES-PHYS>
      </SW-VALUE-CONT>
    </APPLICATION-VALUE-SPECIFICATION>
  
```

```
</VALUE-SPEC>
</CONSTANT-SPECIFICATION>
```

5.6.7.2 Example for Constant Specification for MAP

The following example illustrates how an `ConstantSpecification` is specified for a MAP. In this case one axis of the MAP is a `STD_AXIS` and the second one is a `COM_AXIS`.

Please note that in this example the `v` attribute is used for the `swArraysize` as well as for the `swValuesPhys`.

This is possible because the example contains only invariant values.

Listing 5.25: Example for Constant Specification for MAP

```
<CONSTANT-SPECIFICATION>
  <SHORT-NAME>PhysInitValuesOfMap</SHORT-NAME>
  <DESC>
    <L-2 L="EN">This example shows a ConstantSpecification for a MAP
      where the first axis is a STD_AXIS and the second axis is a
      COM_AXIS</L-2>
  </DESC>
  <VALUE-SPEC>
    <APPLICATION-VALUE-SPECIFICATION>
      <CATEGORY>MAP</CATEGORY>
      <SW-AXIS-CONTS>
        <SW-AXIS-CONT>
          <CATEGORY>STD_AXIS</CATEGORY>
          <SW-AXIS-INDEX>1</SW-AXIS-INDEX>
          <SW-ARRAYSIZE>
            <V>4</V>
          </SW-ARRAYSIZE>
          <SW-VALUES-PHYS>
            <V>0</V>
            <V>1</V>
            <V>2</V>
            <V>3</V>
          </SW-VALUES-PHYS>
        </SW-AXIS-CONT>
      </SW-AXIS-CONTS>
      <SW-VALUE-CONT>
        <UNIT-REF DEST="UNIT">/Units/NwtMtr</UNIT-REF>
        <SW-ARRAYSIZE>
          <V>4</V>
          <V>2</V>
        </SW-ARRAYSIZE>
        <SW-VALUES-PHYS>
          <VG>
            <LABEL>
              <L-4 L="EN">Values for axis index 2 equals 0</L-4>
            </LABEL>
            <V>00</V>
            <V>10</V>
```

```

    <V>20</V>
    <V>30</V>
  </VG>
<VG>
  <LABEL>
    <L-4 L="EN">Values for axis index 2 equals 1</L-4>
  </LABEL>
  <V>01</V>
  <V>11</V>
  <V>21</V>
  <V>31</V>
</VG>
</SW-VALUES-PHYS>
</SW-VALUE-CONT>
</APPLICATION-VALUE-SPECIFICATION>
</VALUE-SPEC>
</CONSTANT-SPECIFICATION>

```

5.6.7.3 Example for Constant Specification for MAP with two STD_AXIS

The example contained in this sub-chapter illustrates the creation of the `ConstantSpecification` for a MAP that (in contrast to the previous example sketched in Listing 5.25) consists of two `STD_AXIS`.

Like in the previous example, the `v` attribute is used for the `swArraysize` as well as for the `swValuesPhys`.

Listing 5.26: Example for Constant Specification for STD_AXIS

```

<SHORT-NAME>MapExample</SHORT-NAME>
<VALUE-SPEC>
  <APPLICATION-VALUE-SPECIFICATION>
    <CATEGORY>MAP</CATEGORY>
    <SW-AXIS-CONTS>
      <SW-AXIS-CONT>
        <SW-AXIS-INDEX>1</SW-AXIS-INDEX>
        <SW-ARRAYSIZE>
          <V>4</V>
        </SW-ARRAYSIZE>
        <SW-VALUES-PHYS>
          <V>1</V>
          <V>2</V>
          <V>3</V>
          <V>4</V>
        </SW-VALUES-PHYS>
      </SW-AXIS-CONT>
      <SW-AXIS-CONT>
        <SW-AXIS-INDEX>2</SW-AXIS-INDEX>
        <SW-ARRAYSIZE>
          <V>2</V>
        </SW-ARRAYSIZE>
        <SW-VALUES-PHYS>
          <V>10</V>
          <V>11</V>

```

```

    </SW-VALUES-PHYS>
  </SW-AXIS-CONT>
</SW-AXIS-CONTS>
<SW-VALUE-CONT>
  <SW-ARRAYSIZE>
    <V>4</V>
    <V>2</V>
  </SW-ARRAYSIZE>
  <SW-VALUES-PHYS>
    <VG>
      <LABEL>
        <L-4 L="EN">Values for 10</L-4>
      </LABEL>
      <V>110</V>
      <V>210</V>
      <V>310</V>
      <V>410</V>
    </VG>
    <VG>
      <LABEL>
        <L-4 L="EN">Values for 11</L-4>
      </LABEL>
      <V>111</V>
      <V>211</V>
      <V>311</V>
      <V>411</V>
    </VG>
  </SW-VALUES-PHYS>
</SW-VALUE-CONT>
</APPLICATION-VALUE-SPECIFICATION>
</VALUE-SPEC>
</CONSTANT-SPECIFICATION>

```

5.6.7.4 Example for Constant Specification for COM_AXIS

The following example illustrates how an [ConstantSpecification](#) is specified for a [COM_AXIS](#).

Listing 5.27: Example for Constant Specification for COM_AXIS

```

<CONSTANT-SPECIFICATION>
  <SHORT-NAME>PhysInitValuesOfComAxis</SHORT-NAME>
  <DESC>
    <L-2 L="EN">This example shows a ConstantSpecification for a
      COM_AXIS</L-2>
  </DESC>
  <VALUE-SPEC>
    <APPLICATION-VALUE-SPECIFICATION>
      <CATEGORY>COM_AXIS</CATEGORY>
      <SW-VALUE-CONT>
        <UNIT-REF DEST="UNIT">/Units/Rpm</UNIT-REF>
        <SW-ARRAYSIZE>
          <V>6</V>
        </SW-ARRAYSIZE>

```

```

<SW-VALUES-PHYS>
  <V>0</V>
  <V>500</V>
  <V>1000</V>
  <V>1500</V>
  <V>3000</V>
  <V>5000</V>
</SW-VALUES-PHYS>
</SW-VALUE-CONT>
</APPLICATION-VALUE-SPECIFICATION>
</VALUE-SPEC>
</CONSTANT-SPECIFICATION>

```

5.7 Initial Values

5.7.1 Overview

[TPS_SWCT_01301] Importance of initial values [If the value of a [VariableDataPrototype/ParameterDataPrototype](#) has not properly been set by a piece of software it can still happen that another piece of software tries to access the value of the [VariableDataPrototype/ParameterDataPrototype](#).

For various reasons it is therefore advised to be able to specify an initial value for a [VariableDataPrototype/ParameterDataPrototype](#) in case the value has not been assigned in a controlled manner. However, the definition of an initial value in many cases depends on a context in which the value is accessed.]()

Therefore, the AUTOSAR standard foresees means for defining initial values for [VariableDataPrototypes/ParameterDataPrototypes](#) on different conceptual levels.

That is, although defined for the same [VariableDataPrototype/ParameterDataPrototype](#), an initial value defined on one conceptual level can “supersede” the definition of another initial value on a different conceptual level provided that the priority of the first is higher than the priority of the latter.

The meaning of “supersede” in this context is that that the definition of an initial value on a specific conceptual level is the only relevant definition of an initial value on that level.

[TPS_SWCT_01518] Priority of initial value definition with respect to conceptual levels [Any initial value defined in the context of a conceptual level of lower priority is ignored!]()

[constr_1706] Definition of initial value for data transmission [Initial values for data transmission shall only be defined by means of [NonqueuedSenderComSpec.initValue](#) resp. [NonqueuedReceiverComSpec.initValue](#). Any definition of an [initValue](#) defined in the context of [VariableDataPrototype](#) shall be ignored.]()

[TPS_SWCT_01182] Conceptual levels for the definition of initial values [The following conceptual levels for the definition of initial values exist:

1. It is possible to aggregate an `initValue` directly at the definition of any `VariableDataPrototype/ParameterDataPrototype`. A restriction applies, please consult with [\[constr_1706\]](#).
2. It is possible to aggregate an `initValue` at the level of a `ComSpec`, namely:
 - `NonqueuedSenderComSpec`
 - `NonqueuedReceiverComSpec`
 - `ParameterProvideComSpec`
 - `ParameterRequireComSpec`
 - `NvRequireComSpec`
 - `NvProvideComSpec`
3. It is possible to aggregate a `implInitValue` and an `applInitValue` at the definition of a `CalibrationParameterValue`.

The priority of one definition of an initial value over another is reflected by the numerical order of the above enumeration, e.g. a definition on level 3 supersedes a definition on level 2.]()

5.7.2 Initial Value Representation

[TPS_SWCT_01183] Actual value of an `initValue` shall be interpreted according to the `AutosarDataType` [A `DataPrototype` can be typed by either an `ApplicationDataType` or else an `ImplementationDataType`. Therefore, the actual value of an `initValue` shall be interpreted according to the `AutosarDataType` that types the `DataPrototype`.

That is, if the `DataPrototype` is typed by an `ApplicationDataType` the value shall be interpreted as a physical value while if the `DataPrototype` is typed by an `ImplementationDataType` the value is to be interpreted as the direct numerical representation.]([RS_SWCT_03216](#), [RS_SWCT_03217](#))

[TPS_SWCT_01184] `ApplicationPrimitiveDataTypes` with `category VALUE` [In case of `ApplicationPrimitiveDataTypes` with `category VALUE` it is sufficient if the `initValues` are provided as physical values only because the RTE Generator should be able to evaluate the related `CompuMethod` appropriately.]([RS_SWCT_03216](#), [RS_SWCT_03217](#))

Please note that `DataPrototypes` that refer to `CompuMethods` of category `SCALE__LINEAR_AND_TEXTTABLE` (or similar) shall be initialized by means of the definition of several `ApplicationValueSpecification.swValueCont.swValuesPhys.vtf`.

Depending on the evaluation of the binding expression either a numerical value or a string is taken to initialize the `DataPrototype`.

[TPS_SWCT_01185] initValues for Compound Primitive Data Types [The definition of `initValues` in the numerical representation for Compound Primitive Data Type is done such that the `initValues` have to be provided as a `RecordValueSpecification` respectively an `ArrayValueSpecification` or `NumericalRuleBasedValueSpecification` matching to the related `ImplementationDataType`. The additional representation can be provided and associated by means of a `ConstantSpecificationMapping`.] (*RS_SWCT_03216*)

Please note that the definition of Compound Primitive Data Type can be found in section 5.6.

[constr_1221] DataPrototype is typed by an ApplicationPrimitiveDataType [If a `DataPrototype` is typed by an `ApplicationPrimitiveDataType` its `initValue` shall be provided by an `ApplicationValueSpecification`.

If the underlying `ApplicationPrimitiveDataType` represents an enumeration, the value provided shall match to one of the applicable text values (`vt`, `shortLabel`, `symbol`) defined by the applicable `CompuScales`.] ()

Please note that several attributes of meta-class `CompuScale` can be taken to describe the actual value. It is therefore necessary to clarify what happens if several of these attributes exist within the context of one `CompuScale`. This clarification can be found in [TPS_SWCT_01696].

[constr_1385] DataPrototype is typed by an ImplementationDataType [If a `DataPrototype` is typed by an `ImplementationDataType` its `initValue` shall **not** be provided by an `ApplicationValueSpecification`.] ()

[constr_1222] category of an AutosarDataType used to type a DataPrototype is set to STRING [If the `category` of an `AutosarDataType` used to type a `DataPrototype` is set to `STRING` the `ApplicationValueSpecification` used to initialize the `DataPrototype` shall be of `category STRING`.] ()

[constr_1223] DataPrototype is typed by an ApplicationRecordDataType [If a `DataPrototype` is typed by an `ApplicationRecordDataType` the corresponding `initValue` shall be provided by a `RecordValueSpecification`.] ()

[constr_1224] DataPrototype is typed by an ApplicationArrayDataType [If a `DataPrototype` is typed by an `ApplicationArrayDataType` the corresponding `initValue` shall be provided by an `ArrayValueSpecification` or `ApplicationRuleBasedValueSpecification`.] ()

5.7.3 Constant Specification Mapping

[TPS_SWCT_01186] **ConstantSpecificationMapping** [The `ConstantSpecificationMapping` is used to associate `ValueSpecifications` defined in the implementation domain with corresponding `ValueSpecifications` defined in the application domain.]()

To make this possible the `ValueSpecification` actually needs to be a `ConstantReference`.

The `ConstantSpecification` referenced by the `ConstantReference` is also the target of the references owned by `ConstantSpecificationMapping`.]()

[constr_1029] **ConstantSpecificationMapping and ConstantSpecification** [It is required that one `ConstantSpecification` referenced from a `ConstantSpecificationMapping` needs to be defined in the application domain (`applConstant`) and the other referenced `ConstantSpecification` needs to be defined in the implementation domain (`implConstant`).]()

[TPS_SWCT_01187] **ConstantSpecificationMappingSet** referenced by the **InternalBehavior** [In most cases the meta-class `ConstantSpecificationMappingSet` will be referenced by the `InternalBehavior`. This `ConstantSpecificationMappingSet` contains the applicable `ConstantSpecificationMappings`.]()

However, in some specializations the software-components will not have an `InternalBehavior`:

- [constr_1030] **ParameterSwComponentType** references **ConstantSpecificationMappingSet** [`ParameterSwComponentType`: here the `ConstantSpecificationMappingSet` is directly associated by the `ParameterSwComponentType`.]()
- [constr_1031] **NvBlockSwComponentType** references **ConstantSpecificationMappingSet** [`NvBlockSwComponentType`: in this case the `ConstantSpecificationMappingSet` is associated with the aggregated `NvBlockDescriptor`.]()

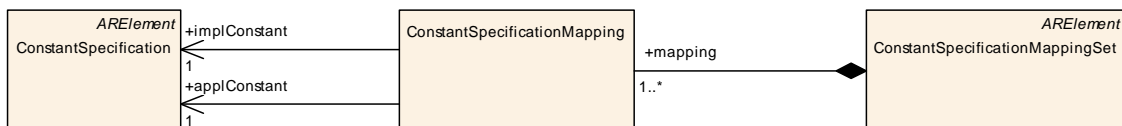

Figure 5.78: Constant Mapping

Class	ConstantSpecificationMapping			
Package	M2::AUTOSARTemplates::CommonStructure::Constants			
Note	<p>This meta-class is used to create an association of two ConstantSpecifications. One Constant Specification is supposed to be defined in the application domain while the other should be defined in the implementation domain.</p> <p>Hence the ConstantSpecificationMapping needs to be used where a ConstantSpecification defined in one domain needs to be associated to a ConstantSpecification in the other domain.</p> <p>This information is crucial for the RTE generator.</p>			
Base	<i>ARObject</i>			
Attribute	Type	Mult.	Kind	Note
applConstant	ConstantSpecification	1	ref	A ConstantSpecification defined in the application domain.
implConstant	ConstantSpecification	1	ref	A ConstantSpecification defined in the implementation domain.

Table 5.144: ConstantSpecificationMapping

Class	ConstantSpecificationMappingSet			
Package	M2::AUTOSARTemplates::CommonStructure::Constants			
Note	<p>This meta-class represents the ability to map two ConstantSpecifications to each others. One Constant Specification is supposed to be described in the application domain and the other should be described in the implementation domain.</p> <p>Tags:atp.recommendedPackage=ConstantSpecificationMappingSets</p>			
Base	<i>ARElement, ARObject, CollectableElement, Identifiable, MultilanguageReferrable, Packageable Element, Referrable</i>			
Attribute	Type	Mult.	Kind	Note
mapping	ConstantSpecification Mapping	1..*	aggr	ConstantSpecificationMappings owned by the Constant SpecificationMappingSet.

Table 5.145: ConstantSpecificationMappingSet

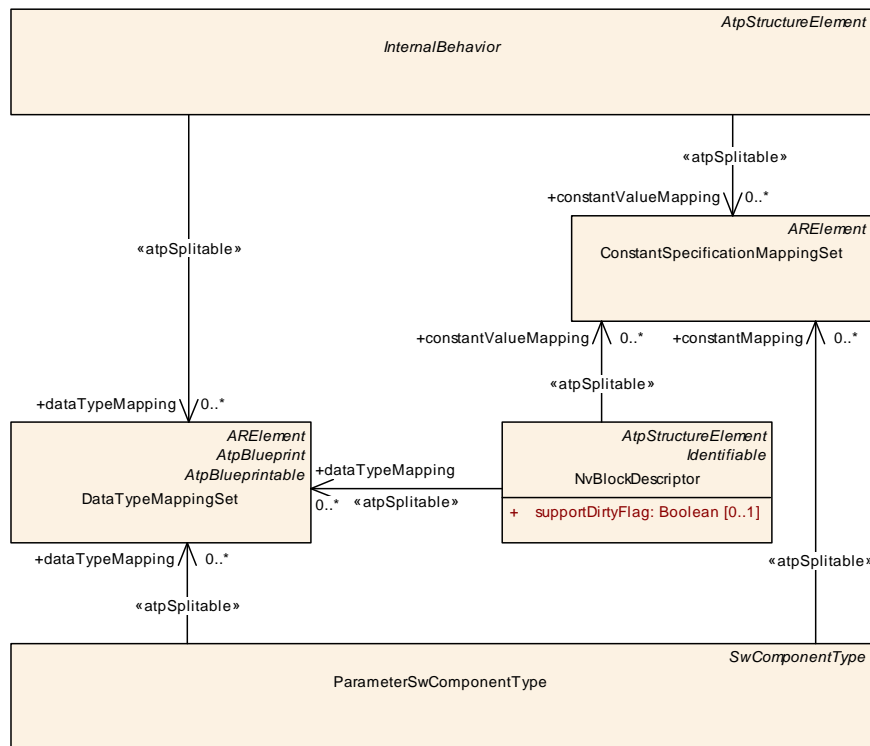

Figure 5.79: Aggregation of **ConstantSpecificationMappingSet**

5.7.4 Initial Values For CalibrationParameters

[TPS_SWCT_01188] Definition of calibration data sets through RTE-generator and compiler [It is possible to provide sets of initial values for calibration parameters which are instance specific, thus overriding any initial values predefined by a [ParameterDataPrototype](#), [ParameterRequireComSpec](#) or a [ParameterProvideComSpec](#).

This allows to create the calibration data sets through RTE-generator and compiler. These initial values are specified in [CalibrationParameterValueSet](#) and [CalibrationParameterValue](#). The latter aggregates a [ValueSpecification](#) in two different roles:

- [applInitValue](#) for data structured according to [ApplicationDataType](#). In this case the values are defined in the physical domain.
- [implInitValue](#) for data structured according to [ImplementationDataType](#). In this case the values are defined in the numerical domain.

]([RS_SWCT_03175](#))

Anyhow, these initial values can be imported from e.g. an ASAM CDF file.

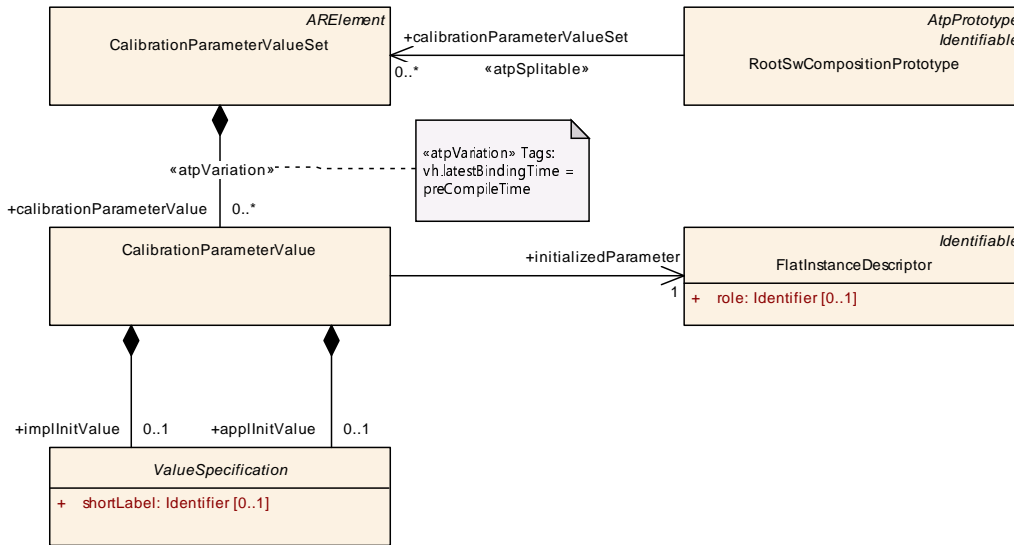

Figure 5.80: Calibration Parameter Values

Class	CalibrationParameterValueSet			
Package	M2::AUTOSARTemplates::SWComponentTemplate::MeasurementAndCalibration::CalibrationParameter Values			
Note	Specification of a constant that can be part of a package, i.e. it can be defined stand-alone. Tags: atp.recommendedPackage=CalibrationParameterValueSets			
Base	ARElement , ARObject , CollectableElement , Identifiable , MultilanguageReferrable , Packageable Element , Referrable			
Attribute	Type	Mult.	Kind	Note
calibration ParameterValue	CalibrationParameter Value	*	aggr	This represents single CalibrationParameterValues in the CalibrationParameterValueSet. Stereotypes: atpVariation Tags: vh.latestBindingTime=preCompileTime

Table 5.146: CalibrationParameterValueSet

Class	CalibrationParameterValue			
Package	M2::AUTOSARTemplates::SWComponentTemplate::MeasurementAndCalibration::CalibrationParameter Values			
Note	Specifies instance specific calibration parameter values used to initialize the memory objects implementing calibration parameters in the generated RTE code. RTE generator will use the implInitValue to override the initial values specified for the DataPrototypes of a component type. The applInitValue is used to exchange init values with the component vendor not publishing the transformation algorithm between ApplicationDataTypes and ImplementationDataTypes or defining an instance specific initialization of components which are only defined with ApplicationDataTypes. Note: If both representations of init values are available these need to represent the same content. Note further that in this case an explicit mapping of ValueSpecification is not implemented because calibration parameters are delivered back after the calibration phase.			
Base	ARObject			
Attribute	Type	Mult.	Kind	Note





Class	CalibrationParameterValue			
applInitValue	ValueSpecification	0..1	aggr	This is the initial value specification structured according to the ApplicationDataType
implInitValue	ValueSpecification	0..1	aggr	This is the initial value specification structured according to the ImplementationDataType
initializedParameter	FlatInstanceDescriptor	1	ref	This represents the parameter that is initialized by the CalibrationParameterValue .

Table 5.147: CalibrationParameterValue

5.7.5 Initial Value for optional Element

The existence of optional elements in a given [AutosarDataType](#) needs to be properly considered for the definition of an initial value.

5.7.5.1 Initial Value for optional ApplicationRecordElement

An initial value for a given [DataPrototype](#) typed by an [ApplicationRecord-DataType](#) is defined by means of an [RecordValueSpecification](#). The existence of [ApplicationRecordElements](#) where attribute [isOptional](#) is set to `True` also needs to be considered in order to not violate [[constr_1271](#)].

In other words, the place in the structure that represents a non-available optional element of the structure needs to be filled with a special kind of [ValueSpecification](#), i.e. the [NotAvailableValueSpecification](#) in order to unambiguously convey the information that this element is not available for the specific [DataPrototype](#).

5.7.5.2 Initial Value for optional ImplementationDataTypeElement

[TPS_SWCT_01785] Initial value for [ImplementationDataType](#) of category **STRUCTURE** where attribute [isStructWithOptionalElement](#) set to the value `True` [If an initial value is to be provided for an [ImplementationDataType](#) of category `STRUCTURE` where attribute [isStructWithOptionalElement](#) set to the value `True` then an initial value shall be defined for all [Implementation-DataTypeElements](#) including the first [ImplementationDataTypeElement](#) where the [shortName](#) is set to the value `availabilityBitfield`.] ([RS_SWCT_03320](#))

[TPS_SWCT_01786] Initial value for the [ImplementationDataTypeElement](#) where the [shortName](#) is set to the value `availabilityBitfield` [The initial value for the [ImplementationDataTypeElement](#) where the [shortName](#) is set to the value `availabilityBitfield` shall be defined in a way that the bit that represents the existence of a given element is set to `True` if the element shall initially be available.

If the corresponding element shall not be initially available then the respective bit shall be set to `False`.] ([RS_SWCT_03320](#))

[TPS_SWCT_01787] Initialization of not-available `ImplementationDataTypeElement` [If a given `ImplementationDataTypeElement` is not available in the context of the definition of an initial value then a “dummy” initial value shall be defined anyway for the element in order to not break [[constr_1272](#)].

The provided `ValueSpecification` shall be considered as “don’t care”.] ()

Form the perspective of performance, it is recommended to use the value 0 for an initialization according to [[TPS_SWCT_01787](#)] of non-available `ImplementationDataTypeElement`.

6 Compatibility

6.1 Introduction

In order to connect `PortPrototypes` of `SwComponentTypes`, the compatibility of `PortPrototype`s needs to be verified. This section defines the basic rules for formal compatibility of `PortPrototype`s.

Compatibility will be defined bottom-up, i.e. first the rules for compatible `Autosar-DataTypes` are set up, then the rules for the different types of `PortInterfaces` are derived.

Another aspect of compatibility is whether two model-elements (e.g. `ApplicationDataType` vs. `ImplementationDataType`) can be mapped to each other.

For the compatibility of `PortInterfaces` basically two options apply:

1. finding of matching pairs of elements of `PortInterfaces` is based on matching `shortName` plus the application of compatibility rules for their attributes.
2. a `PortInterfaceMapping` can be taken to declare two elements of `PortPrototypes` as compatible without applying further formal checks.

6.2 Compatibility of Data Types

The AUTOSAR meta model defines a number of meta-classes (e.g. `ApplicationPrimitiveDataType`) that eventually refer to a set of attributes (e.g. a lower boundary for its values) relevant for compatibility checking.

Instantiating a data-type related meta-class defines a data type on M1 level (e.g. `temperatureType`). In other words: `ApplicationPrimitiveDataType` is an M2 artifact; it is taken as the template for creating a corresponding M1 artifact `temperatureType`.

In this context, the issue of compatibility refers to the M1 objects, i.e. the instances of sub-classes of `AutosarDataType` need to be considered. For this purpose the relevant part of the AUTOSAR meta-model need to be fully explored with respect to compatibility.

6.2.1 ApplicationDataType

6.2.1.1 ApplicationPrimitiveDataType

[constr_1047] Compatibility of `ApplicationPrimitiveDataTypes` [Instances of `ApplicationPrimitiveDataType` are compatible if and only if one of the following conditions applies:

1. All the following subconditions apply:

- (a) They have the same `category`.
 - (b) The `swDataDefProps` attached to the M1 data types are compatible.
2. In the context of using the `ApplicationPrimitiveDataType`, a `DataPrototypeMapping` exists that refers to a `DataPrototype` typed by one of the `ApplicationPrimitiveDataTypes` in the role `firstDataPrototype` and to another `DataPrototype` typed by the other `ApplicationPrimitiveDataType` in the role `secondDataPrototype`.
 3. In the context of using the `ApplicationPrimitiveDataType`, a `DataPrototypeMapping` exists that refers to a `DataPrototype` typed by the `ApplicationPrimitiveDataType` in the role `secondDataPrototype` and to another `DataPrototype` typed by an `ApplicationCompositeDataType` in the role `firstDataPrototype` and additionally for the side of the `ApplicationCompositeDataType` a corresponding `ApplicationCompositeDataTypeSubElementRef` exists in the role `firstElement` that in turn references an `ApplicationCompositeElementDataPrototype`.

]()

Please note that the meaning of “`swDataDefProps` attached to the M1 data types are compatible” is explained in section 6.2.4.

Please note further that it is **not** required that the `shortNames` of two data types shall be identical in order to consider the two data types as compatible.

6.2.1.2 ApplicationCompositeDataType

An instance of an `ApplicationRecordDataType` is never compatible to an instance of an `ApplicationArrayDataType` **unless** a `PortInterfaceMapping` exists that details the terms of compatibility (see [TPS_SWCT_01543]).

[constr_1048] Compatibility of `ApplicationRecordDataTypes` [Instances of `ApplicationRecordDataTypes` are compatible if and only if one of the following conditions applies:

1. All *elements at the same record position* are of compatible `AutosarDataTypes` (either `ApplicationCompositeDataTypes` or `ApplicationPrimitiveDataTypes`).
2. For each `ApplicationRecordDataType.element`, the attribute `isOptional` shall either
 - not exist on both sides or
 - be set to the value `False` if it only exists on one side or
 - have the identical value on both sides.

3. In the context of a `DataPrototypeMapping`, for each `ApplicationRecordElement` of the required `ApplicationRecordDataType` a `SubElementMapping` exists such that a `ApplicationCompositeDataTypeSubElementRef` in the role `firstElement` or `secondElement` exists that references the required `ApplicationRecordElement` **and** a corresponding `ApplicationCompositeDataTypeSubElementRef` exists in the **other** role (i.e. `secondElement` or `firstElement`) that in turn references an `ApplicationRecordElement` of the provided `ApplicationRecordDataType`.

]()

[constr_1049] Compatibility of `ApplicationArrayDataTypes` [Instances of `ApplicationArrayDataType` are compatible if and only if one of the following conditions applies:

1. All the following subconditions apply:
 - (a) Their `elements` are of a compatible `AutosarDataTypes` (either `ApplicationCompositeDataTypes` or `ApplicationPrimitiveDataTypes`).
 - (b) The attributes `maxNumberOfElements` and `arraySizeSemantics` (given the existence) have identical values.
2. In the context of a `DataPrototypeMapping`, for the `ApplicationArrayElement` of the required `ApplicationArrayDataType` a `SubElementMapping` exists such that a `ApplicationCompositeDataTypeSubElementRef` in the role `firstElement` or `secondElement` exists that references the required `ApplicationArrayElement` **and** a corresponding `ApplicationCompositeDataTypeSubElementRef` exists in the **other** role (i.e. `secondElement` or `firstElement`) that in turn references an `ApplicationArrayElement` of the provided `ApplicationArrayDataType`.

]()

6.2.2 ImplementationDataType

[constr_1050] Compatibility of `ImplementationDataTypes` [Instances of `ImplementationDataType` are compatible if and only if after all type-references are resolved one of the following rules apply:

1. All the following subconditions apply:
 - (a) They have the same `category`.
 - (b) They have the identical structure (this refers to `ImplementationDataTypeElement` and their `subElements`).
 - (c) The attributes `arraySize` and `arraySizeSemantics` have (given the existence) identical values.

- (d) For each `ImplementationDataType.subElement`, the attribute `isOptional` shall either
- not exist on both sides or
 - be set to the value `False` if it only exists on one side or
 - have the identical value on both sides.
- (e) The `swDataDefProps` attached to the M1 data types are compatible.
2. In the context of using the `ImplementationDataType`, a `DataPrototypeMapping` exists that refers to a `DataPrototype` typed by one of the `ImplementationDataTypes` in the role `firstDataPrototype` and to another `DataPrototype` typed by the other `ImplementationDataType` in the role `secondDataPrototype`.
 3. In the context of using the `ImplementationDataType`, a `DataPrototypeMapping` exists that refers to a `DataPrototype` typed by the `ImplementationDataTypes` in the role `secondDataPrototype` and to another `DataPrototype` typed by an `ImplementationDataType` with a `subElement` in the role `firstDataPrototype` and additionally for the side of the `ImplementationDataType` with a `subElement` a corresponding `ImplementationDataTypeSubElementRef` exists in the role `firstElement` that in turn references an `ImplementationDataTypeElement`.

]()

Please note that the meaning of “`swDataDefProps` attached to the M1 data types are compatible” is explained in section 6.2.4.

Please note that it is **not** required that the `shortNames` of two data types shall be identical in order to consider the two data types as compatible.

The following constraint applies for the case that mode manager and mode user are using different `ImplementationDataTypes`. From the point of view of the RTE there is only the necessity that all possible numbers used to represent `ModeDeclarations` of the mode manager has to fit into the range of the data type used for the mode user.

[constr_1168] Compatibility of `ImplementationDataTypes` used in the `ModeRequestTypeMap` [Both `ImplementationDataTypes` shall fulfill [constr_1167].

In addition to that, the possible numbers used for representing `ModeDeclarations` on the side of the mode manager shall match the supported range of the `ImplementationDataType` used for representing `ModeDeclarations` on the side of the mode user (see [constr_1075]).]()

6.2.3 Compatibility of SwBaseType

[constr_1220] Compatibility of SwBaseType [Two `SwBaseTypes` are compatible if and only if attributes `baseTypeSize` respectively `byteOrder`, `memAlignment`, `baseTypeEncoding`, and `nativeDeclaration` have identical values.]()

6.2.4 Compatibility of SwDataDefProps

[constr_1051] Compatibility of SwDataDefProps [`SwDataDefProps` are compatible if and only if:

1. They refer to compatible `Unit` definitions, or neither of them has an associated `Unit`.
2. They refer to compatible conversion methods or neither of them associates such a method.
3. They both aggregate a `ValueSpecification` in the role `invalidValue` or neither of them aggregates a `ValueSpecification` in the role `invalidValue`.
4. If existent (see previous condition), one of the following conditions apply to `ValueSpecifications` aggregated in the role `invalidValue` for being considered compatible (after following and resolving indirections created by `ConstantReference`):
 - (a) both are `ApplicationValueSpecifications` and the values are compatible according to [TPS_GST_02501].
 - (b) both are `NumericalValueSpecifications` and the values are compatible according to [TPS_GST_02501].
 - (c) both are `TextValueSpecifications` and the values are identical.
 - (d) both are `ArrayValueSpecifications` and the values are identical.
 - (e) both are `RecordValueSpecifications` and the values are identical.
 - (f) if one is a `NumericalValueSpecification` and the other one is an `ApplicationValueSpecification` then the check for compatibility shall apply the `CompuMethod` on the physical value such that a comparison on the implementation level becomes possible. [TPS_GST_02501] applies¹.
5. They refer to compatible data constraints `dataConstr`.
6. They refer to compatible `swRecordLayouts`

All other attributes (e.g. `swCalibrationAccess` do not affect compatibility).]()

¹if one is a `NumericalValueSpecification` and the other one is an `ApplicationValueSpecification` and the application of the `CompuMethod` on the side of the `ApplicationValueSpecification` does not yield a valid number a comparison is not possible.

Please note that compatible conversion methods are described in chapter 6.2.4.5.

6.2.4.1 Compatibility of Units

[constr_1052] Compatibility of Units [Two `Unit` definitions are compatible if and only if:

1. They have compatible (see [TPS_GST_02501]) values of attributes `factorSiToUnit` and `offsetSiToUnit`.
2. They either refer to identical definitions of `PhysicalDimension` or neither of them associates a `PhysicalDimension`.

]()

Please note that it is **not** required that the `shortNames` of two `Units` shall be identical in order to consider the two units as compatible.

[TPS_SWCT_01492] Default values for `factorSiToUnit` and `offsetSiToUnit` [The default value of attribute `Unit.factorSiToUnit` is 1.

The default value of attribute `Unit.offsetSiToUnit` is 0.]()

Further constraints apply specifically for the handling of `Units` in the context of assigning a `ValueSpecification` to a given `AutosarDataPrototype`:

[constr_1391] Compatibility of Units in the context of assignment using an `ApplicationValueSpecification` [If an `ApplicationValueSpecification` is used in the context of an assignment to an `AutosarDataPrototype` then the `ApplicationValueSpecification.swValueCont.unit` shall be compatible to the `Unit` used in the definition of the given `AutosarDataPrototype`, i.e. `AutosarDataType.swDataDefProps.unit`.]()

[constr_1392] Compatibility of Units in the context of assignment using an `ApplicationRuleBasedValueSpecification` [If an `ApplicationRuleBasedValueSpecification` is used in the context of an assignment to an `AutosarDataPrototype` then the `ApplicationRuleBasedValueSpecification.swValueCont.unit` shall be compatible to the `Unit` used in the definition of the given `AutosarDataPrototype`, i.e. `AutosarDataType.swDataDefProps.unit`.]()

[constr_1393] Existence of `RuleBasedValueCont.unit` [For every `RuleBasedValueCont` the attribute `unit` shall exist.]()

Please note that the multiplicity of `RuleBasedValueCont.unit` is set to 0..1 while the multiplicity of the corresponding `SwValueCont.unit` is set to 1.

This inconsistency cannot be resolved by increasing the lower multiplicity of `RuleBasedValueCont.unit` because this would create an incompatible XML Schema. However, the creation of [constr_1393] effectively yields the same result.

6.2.4.2 Compatibility of PhysicalDimensions

[constr_1053] Compatibility of PhysicalDimensions [Two PhysicalDimension definitions are compatible if and only if the values of

- lengthExp
- massExp
- timeExp
- currentExp
- temperatureExp
- molarAmountExp
- luminousIntensityExp

are identical and **either** the shortNames are identical **or** a PhysicalDimension-Mapping exists that maps one of the PhysicalDimensions in the role first-PhysicalDimension and the other PhysicalDimension in the role secondPhysicalDimension.]()

For clarification, there are some physical dimensions around that share the identical values for the exponents but still have a completely different meaning and shall therefore not be considered compatible. For precisely this reason **[constr_1053] requires** the shortNames of two PhysicalDimensions to be identical as a prerequisite for compatibility.

For example, there are at least two physical dimensions that share the values of

- lengthExp = 2
- massExp = 1
- timeExp = -2
- currentExp = 0
- temperatureExp = 0
- molarAmountExp = 0
- luminousIntensityExp = 0

The unit described by this set of exponents is usually referred to as “Nm” for *newton-meter* and it can be used for *torque* just as well as for *energy*. Obviously, two Units shall never be considered compatible if one refers to *torque* and the other one refers to *energy*.

6.2.4.3 Compatibility of Data Constraints

The compatibility of two `DataConstrs` depends on the context in which the owning data elements are connected:

[constr_1126] Compatibility of `DataConstrs` [The `DataConstr` (e.g. the limits) defined by the type of the providing data element shall be within the constraints defined by the type of the requiring data element.]()

For client-server communication, the following rules apply:

- For `arguments` with attribute `direction` set to the value `in`, the client shall take the role of the *provider* and the server shall take the role of the *requiring side*.
- For `arguments` with attribute `direction` set to the value `inout` the `DataConstr` shall be equal on both sides.
- For `arguments` with attribute `direction` set to the value `out`, the server shall take the role of the *provider* and the client shall take the role of the *requiring side*.

]()

In addition, it is always allowed that the requiring element defines no constraints.

[constr_1278] `PhysConstrs` references a `Unit` [`DataConstrs` are only compatible if the `DataConstr.dataConstrRule.physConstrs.unit` are compatible or neither `DataConstr.dataConstrRule.physConstrs.unit` exist.]()

[constr_1054] No `DataConstr` available at the provider [If the provider defines no constraints, it is only compatible with a receiver which also defines no constraints at all.]()

In other words, this is not a compatibility rule for the types but for the data prototypes.

6.2.4.4 Compatibility in case of `ImplementationDataType`

If the `SwDataDefProps` are owned by an `ImplementationDataType`, further conditions shall be met to ensure compatibility.

Note that depending on the `category` of the `ImplementationDataType`, at most one of these four constraints is actually relevant:

1. `category` **[constr_1055] `ImplementationDataType` has `category VALUE`** [The attributes `baseType` shall refer to a compatible `SwBaseType`]() (see explanation in the following rule). The rules regarding the compatibility of `SwBaseTypes` are covered by [constr_1220].

2. `category TYPE_REFERENCE: [constr_1056] ImplementationDataType` has `category TYPE_REFERENCE` [The `ImplementationDataTypes` referenced by the attributes `SwDataDefProps.implementationDataType` shall be compatible.]()
3. `category DATA_REFERENCE: [constr_1057] ImplementationDataType` has `category DATA_REFERENCE` [The attributes `SwDataDefProps.swPointerTargetProps` shall have identical `targetCategory` and shall refer to `SwDataDefProps` where all attributes are identical]() (in other words, the target types of the pointers shall be identical, not only compatible).
4. `category FUNCTION_REFERENCE: [constr_1058] ImplementationDataType` has `category FUNCTION_REFERENCE` [The attributes `SwDataDefProps.swPointerTargetProps.functionPointerSignature` shall refer to `BswModuleEntry`s which each resolve to the **same function signature**.]()

Please note that the term “same signature” refers to the following predicates:

- same number of arguments
- return values and arguments shall have **identical** - not only *compatible* - data types

Two `SwBaseTypes` are compatible (in the sense of allowing a connection of ports via the RTE) if a simple conversion rule exists between the two types in the underlying programming language.

Admittedly, this is a rather weak condition. But because the definition of `SwBaseTypes` can contain a `nativeDeclaration` it is not possible to state this rule more specifically.

However, conversion between base types is considered as a less common use case than the simple case that the connected types just contain two identical `SwBaseTypes` (which is of course included in the rule).

Please note that, in addition, the existence of `ApplicationDataTypes` also constrains the possible `SwBaseTypes` via the compatibility rules for the mapping between `ApplicationDataTypes` and `ImplementationDataType` as will be explained in more detail in chapter 6.2.5.

6.2.4.5 Compatibility of CompuMethods

[constr_1163] Compatibility of `CompuMethods` [Two `CompuMethod` definitions are compatible if and only if all attributes **except**

- `shortName`
- `desc`

- `introduction`
- `longName`
- `adminData`
- `annotation`
- `displayFormat`

are **identical and** the `compuScales` and `units` are compatible.}]()

[constr_1153] Applicability of compatibility requirements for `CompuScales`
[Compatibility requirements for `CompuScales` shall only apply for `CompuScales` where the `category` of the enclosing `CompuMethod` is one of the following:

- `TEXTTABLE`
- `SCALE_LINEAR_AND_TEXTTABLE`
- `SCALE_RATIONAL_AND_TEXTTABLE`
- `TAB_NOINTP`
- `BITFIELD_TEXTTABLE`
- `LINEAR`
- `RAT_FUNC`
- `IDENTICAL`

]()

[constr_1154] Compatibility of `CompuScales` for sender-receiver communication and similar use cases [For sender-receiver communication and similar use cases, it is required that the set of `CompuScales` defined in the `CompuMethod` of the provider of the communication (i.e. on the side of the `PPortPrototype`) shall be a subset of the set of `CompuScales` defined in the `CompuMethod` on the required side (i.e. on the side of the `RPortPrototype`).]()

[constr_1155] Compatibility of `CompuScales` for client-server communication
[For client-server communication, the following rules apply:

For `arguments` of direction `IN` the `CompuScales` defined in the `CompuMethod` of the client (i.e. on the side of the `RPortPrototype`) shall be a subset of the set of `CompuScales` defined in the `CompuMethod` supported at the server (i.e. on the side of the `PPortPrototype`).

For `arguments` of the direction `OUT` the set of `CompuScales` defined in the `CompuMethod` of the server (i.e. on the side of the `PPortPrototype`) shall be a subset of the set of `CompuScales` defined in the `CompuMethod` supported at the client (i.e. on the side of the `RPortPrototype`).

For `arguments` of direction `INOUT` the set of `CompuScales` defined in the `CompuMethod` of server and client shall be identical.]()

[constr_1156] Relevance of “names” of `CompuScales` [`CompuScales` which contribute to tabular conversion by having a `compuConst` are compatible **if and only if** the “names” of the `compuScales`, (namely `shortLabel`, `compuConst` and `symbol`) are equal. If the scale has no `compuConst`, “names” of `CompuScales` are not relevant for compatibility.]()

[constr_1157] Applicability of constraints of `CompuScales` [The constraints [`constr_1154`], [`constr_1155`], and [`constr_1156`] shall **only** apply in the absence of a `TextTableMapping` which shall take precedence regarding the compatibility if it exists.]()

[constr_1176] Compatibility of `CompuScales` of category `LINEAR` and `RAT_FUNC` [`CompuScales` of category `LINEAR` and `RAT_FUNC` are considered compatible if they yield the same conversion.]()

For example, $\frac{n_0+n_1*phys}{d_0+d_1*phys}$ is compatible to $\frac{N_0+N_1*phys}{D_0}$ if $n_0 \sim N_0 \ \&\& \ n_1 \sim N_1 \ \&\& \ d_0 \sim D_0 \ \&\& \ d_1 \sim 0$.

Note that \sim indicates compatibility of numerical values according to [TPS_GST_02501].

[constr_1192] Compatibility of “`IDENTICAL`” to “`RAT_FUNC`” or “`LINEAR`” [Similar to [`constr_1176`], a `CompuScale` where the `category` of the enclosing `CompuMethod` is set to `IDENTICAL` is considered compatible to a `CompuScale` where the `category` of the enclosing `CompuMethod` is set to `RAT_FUNC` or `LINEAR` if the following rule applies:

$$int = \frac{N_0+N_1*phys+N_i*phys^i}{D_0+D_1*phys+D_i*phys^i} = phys$$

]()

For example, this is the case for

$$N_0 \sim 0 \ \&\& \ D_0 \sim 1 \ \&\& \ N_1 \sim 1 \ \&\& \ D_1 \sim 0 \ \&\& \ N_i \sim D_i \sim 0 \ \forall i > 1.$$

Please note that the compatibility does not depend on the direction (`compuInternalToPhys` vs. `compuPhysToInternal`) of `CompuMethods` of category `LINEAR`.

6.2.4.6 Compatibility of Record Layouts

[constr_1162] Compatibility of `SwRecordLayouts` [Two `SwRecordLayout` definitions are compatible if and only if all attributes **except**

- `shortName`
- `desc`
- `introduction`
- `longName`

- `adminData`
- `annotation`

are **identical**.]()

6.2.5 Compatibility of `ApplicationDataType` and `ImplementationDataType`

The usage of `ApplicationDataTypes` implies that also a corresponding `ImplementationDataType` exists at a certain point in time. The `ImplementationDataType` is required as the basis for configuring and generating the RTE and/or contract phase header files.

[TPS_SWCT_01461] Existence of `ImplementationDataType` [The existence of `ImplementationDataTypes` is **not** required until the methodology step of generating an RTE or executing the RTE contract phase. Before arriving at this step in the methodology, it is perfectly feasible to use only `ApplicationDataTypes` for describing the semantics of software-components.]()

As a consequence, it is necessary to define compatibility rules that unambiguously clarify the conformance of an `ApplicationDataType` with an `ImplementationDataType` and vice versa.

Please note that this kind of compatibility also supports situations where e.g. a `dataElement` typed by an `ApplicationDataType` without a corresponding `ImplementationDataType` in a `PPortPrototype` should be connected to a `dataElement` typed by an `ImplementationDataType` in an `RPortPrototype`.

In general, the compatibility rules for allowing a data type mapping are the same as the rules for connections. Exceptions are explicitly stated in the rules below.

Several rules depend on the `category` of the data types:

1. As a general rule, if an `ImplementationDataType` of `category TYPE_REFERENCE` is targeted by a type mapping or port connection all the rules given below apply to the `ImplementationDataType` which is finally valid after resolving all such references.

This is not repeated in all rules. As an example, if we say that something can be mapped/connected to an `ImplementationDataType` of `category VALUE` this shall include the possibility of mapping/connecting to an `ImplementationDataType` of `category TYPE_REFERENCE` which refers to another `ImplementationDataType` of `category VALUE`.

2. **[constr_1059] Compatibility of data types with `category VALUE`** [An `ApplicationDataType` of `category VALUE` shall (after all indirections created by `ImplementationDataTypes` of `category TYPE_REFERENCE` are resolved) only be mapped/connected to an `ImplementationDataType` which also has `category VALUE`.]()

In this case, the `ImplementationDataType.baseType` shall be able to express all the numerical values required by the `ApplicationDataType`, see Figure 5.6.

This condition is fulfilled if the numerical range which can be expressed by the `SwBaseType` at least covers the range defined by the limits in `ApplicationDataType.swDataDefProps.dataConstr` (which are either internal limits or physical limits to be converted via the `CompuMethod` which also has to be provided by the `ApplicationDataType`).

Note that for sender-receiver communication of a data element via a network there is the possibility to reduce the numerical range against what has been defined via the corresponding data type. However, this is not achieved via mapping to another `ImplementationDataType` at the data element itself but via the `networkRepresentation` of the `ComSpec` (for further explanation of this aspect see section 4.5.1).

3. **[constr_1060] Compatibility of data types with category ARRAY, VAL_BLK** [An `ApplicationDataType` of category ARRAY, VAL_BLK shall (after all indirections created by `ImplementationDataTypes` of category TYPE_REFERENCE are resolved) only be mapped/connected to
- an `ImplementationDataType` of category ARRAY or
 - an `ImplementationDataType` that represents a Variable-Size Array Data Type (see [TPS_SWCT_01610]).

]()

In this case, the array size, the `arraySizeSemantics` (given that it exists) and the type of the array elements of the `ImplementationDataType` shall be such that they can be mapped/transferred 1:1 by order to the corresponding application data and vice versa.

Note that in case of mapping between arrays it is not required that a `DataTypeMap` exists between the data types of the array elements or that the respective `shortNames` are identical.

4. **[constr_1061] Compatibility of data types with category STRUCTURE** [An `ApplicationDataType` of category STRUCTURE shall (after all indirections created by `ImplementationDataTypes` of category TYPE_REFERENCE are resolved) only be mapped/connected to an `ImplementationDataType` of category STRUCTURE.]()

This means, that the corresponding pairs of elements shall also have compatible types. Note that it is not required that the data types of the single elements have identical `shortNames` or that a `DataTypeMap` exists for each pair of single element.

5. **[constr_1662] Compatibility of `ApplicationRecordDataType` and `ImplementationDataType` that both represent an `Optional Element Structure`** [An `ApplicationRecordDataType` that represents an `Optional Element Structure` shall (after all indirections created by `ImplementationDataTypes` of category `TYPE_REFERENCE` are resolved) only be mapped/connected to an `ImplementationDataType` of category `STRUCTURE` that represents an `Optional Element Structure` if corresponding pairs of elements have the same value of the attribute `isOptional`.]()
6. **[constr_1063] Compatibility of data types with category `BOOLEAN`** [An `ApplicationDataType` of category `BOOLEAN` shall (after all indirections created by `ImplementationDataTypes` of category `TYPE_REFERENCE` are resolved) only be mapped/connected to an `ImplementationDataType` of category `VALUE`.]()
7. **[constr_1064] Compatibility of data types with category `COM_AXIS`, `RES_AXIS`, `CURVE`, `MAP`, `CUBOID`, `CUBE_4`, or `CUBE_5`** [An `ApplicationDataType` of category `COM_AXIS`, `RES_AXIS`, `CURVE`, `MAP`, `CUBOID`, `CUBE_4`, or `CUBE_5` shall (after all indirections created by `ImplementationDataTypes` of category `TYPE_REFERENCE` are resolved) only be mapped/connected to an `ImplementationDataType` of category `STRUCTURE` or `ARRAY`.]()

There are several possibilities how to express these types via plain or nested arrays and/or structures on implementation level.

Some examples are given in 5.4.4. In any case, the primitive elements of the implementation type shall fit (by their order in memory) to the corresponding `SwRecordLayout`.

It is not required, to define `DataTypeMaps` for the sub-elements or both representations.

8. **[constr_1066] Forbidden mappings to `ImplementationDataType`** [An `ApplicationDataType` shall never be mapped to an `ImplementationDataType` of category `UNION`, `DATA_REFERENCE`, or `FUNCTION_REFERENCE`.]()

Concerning the `SwDataDefProps` of an `ApplicationDataType` instance or an `ImplementationDataType` instance which shall be mapped/connected on M1, we refer to the table shown in figure 5.41. The following rules apply:

1. The cases where the `ImplementationDataType` is not allowed to set a property but only “inherits” it from the `ApplicationDataType` are not relevant for compatibility. These attributes are simply not allowed in the `ImplementationDataType`.
2. In case that only the `ImplementationDataType` may “define” the property this definition shall fit into the semantical requirements given by the `ApplicationDataType` in order to make the two types compatible.

This is namely important for the attribute `baseType` and is explained above in the rule for types of `category` VALUE.

3. In case the `ImplementationDataType` may “add” a property it may only add but not change a property defined by the `ApplicationDataType` (namely `note`, `displayFormat`, and `swImplPolicy`) in order to be compatible.

This means that the respective computation methods can be defined in only one of the types in order to be compatible. In all other cases, only the `ApplicationDataType` may define the computation method.

4. For the compatibility with respect to connectors there are some additional rules for the values of the attribute `swImplPolicy` which are considered general rules on the level of `DataPrototypes` and `PortInterfaces`.

Therefore, these additional rules are explained in chapter 6.3 and chapter 6.4.4.

5. The case that an `ImplementationDataType` may “redefine” a property which is already set by the `ApplicationDataType` is not considered as relevant for the compatibility with respect to mapping of the types in general but of course there may be project specific rules as to which redefinition is allowed (e.g. for `swAddrMethod` or `dataConstr`). See also 5.5.3 about data constraints.
6. For the compatibility with respect to connectors the attribute `dataConstr` shall be treated in the same way as for compatibility of data types in general, for more details please refer to 6.2.4.

6.3 Compatibility of Variable Data Prototypes and Parameter Data Prototypes

[constr_1068] Compatibility of `VariableDataPrototypes` or `ParameterDataPrototypes` typed by primitive data types [Two `VariableDataPrototypes` or `ParameterDataPrototypes` of `ApplicationPrimitiveDataTypes` or `ImplementationDataTypes` of `category` VALUE, BOOLEAN, or STRING are compatible if and only if one of the following conditions applies:

1. All the following subconditions apply:
 - (a) They are typed by (read “refer to”) compatible `AutosarDataTypes`
 - (b) The two `VariableDataPrototypes` or `ParameterDataPrototypes` have identical `shortNames`. This is required to map `VariableDataPrototypes` in unordered `SenderReceiverInterfaces`, `NvDataInterfaces` and `ParameterInterfaces`.
 - (c) The attribute `swImplPolicy` is either set to `queued` for both or none of the `VariableDataPrototypes`.

2. In the context of a `DataPrototypeMapping`, one of the applicable `VariableDataPrototypes` or `ParameterDataPrototypes` is referenced by the `DataPrototypeMapping` in the role `firstDataPrototype` and the other `VariableDataPrototypes` or `ParameterDataPrototypes` is referenced by the same `DataPrototypeMapping` in the role `secondDataPrototype`.

]()

[constr_1187] Compatibility of `VariableDataPrototypes` or `ParameterDataPrototypes` typed by composite data types [

`DataPrototypes` of `ApplicationCompositeDataTypes` or `ImplementationDataTypes` of category `STRUCTURE` or `ARRAY` are compatible if one of the following conditions evaluates to true:

1. The underlying `ApplicationCompositeDataTypes` or `ImplementationDataTypes` of category `STRUCTURE` or `ARRAY` are identical
2. The underlying `ApplicationCompositeDataTypes` or `ImplementationDataTypes` of category `STRUCTURE` or `ARRAY` fulfill the following condition:
 - They consist of the same number of elements **and**
 - They are composed of compatible `AutosarDataTypes` (either `ApplicationCompositeDataTypes` or `ImplementationDataTypes` of category `STRUCTURE` or `ARRAY` **OR** `ApplicationPrimitiveDataTypes` or `ImplementationDataTypes` of category `VALUE`, `BOOLEAN`, or `STRING`) **in the same order and**
 - All attributes match exactly, except for the `shortName` of the M1 `AutosarDataType`.
3. In the context of a `DataPrototypeMapping`, for each `ApplicationCompositeElementDataPrototype` of the required `DataPrototype` a `SubElementMapping` exists such that a `ApplicationCompositeDataTypeSubElementRef` in the role `firstElement` or `secondElement` exists that references the required `ApplicationCompositeElementDataPrototype` **and** a corresponding `ApplicationCompositeDataTypeSubElementRef` exists in the **other** role (i.e. `secondElement` or `firstElement`) that in turn references an `ApplicationCompositeElementDataPrototype` of the provided `ApplicationCompositeDataType`.
4. If and only if the `DataPrototype` is **not** typed by an `ApplicationDataType` but by an `ImplementationDataType`: in the context of a `DataPrototypeMapping`, for each `ImplementationDataTypeElement` of the required `DataPrototype` a `SubElementMapping` exists such that a `ImplementationDataTypeSubElementRef` in the role `firstElement` or `secondElement` exists that references the required `ImplementationDataTypeElement` **and** a corresponding `ImplementationDataTypeSubElementRef` exists in the **other** role (i.e. `secondElement` or `firstElement`) that in turn references

an `ImplementationDataTypeElement` of the provided `ImplementationDataType`.

]0

6.4 Compatibility of Sender Receiver Interfaces, Parameter Interfaces and Non Volatile Data Interfaces

Please note that this compatibility requirement only satisfies static correctness which means that logical consistency is not assured (e.g. that a receiver shall process a certain data value to correctly interpret the following values).

6.4.1 Connection of Required and Provided Port via AssemblySwConnector

The compatibility of `SenderReceiverInterfaces`, `NvDataInterfaces` and `ParameterInterfaces` are considered for connecting of `PortPrototypes` with an `AssemblySwConnector`.

[constr_1069] Compatibility of `PortPrototypes` of different `DataInterfaces` in the context of `AssemblySwConnectors` [`PortPrototypes` of different `DataInterfaces` are compatible if and only if

1. One of the following conditions applies:
 - (a) For each `VariableDataPrototype` or `ParameterDataPrototype` defined in the context of the `DataInterface` of the required `PortPrototype` a compatible (see [constr_1068]) `VariableDataPrototype` or `ParameterDataPrototype` exists in the `DataInterface` of the provided `PortPrototype`.

The `shortNames` of `VariableDataPrototypes` and `ParameterDataPrototypes` are used to identify the pair.
 - (b) A `VariableAndParameterInterfaceMapping.dataMapping` exists for which the following conditions apply:
 - i. It is referenced by the corresponding `SwConnector`.
 - ii. It references one of the two `VariableDataPrototypes` or `ParameterDataPrototypes` in the role `firstDataPrototype` and the other in the role `secondDataPrototype`.
2. For each such pair, the values of their `isService` attributes are identical.

]0

The table 6.1 defines which `PortInterface` elements are compatible depending on the `PortInterface` type and the `swImplPolicy` attributes of the `PortInterface` elements.

6.4.2 Connection of Inner and Outer Port via `DelegationSwConnector`

The compatibility of `SenderReceiverInterfaces`, `NvDataInterfaces` and `ParameterInterfaces` is considered for connecting of `PortPrototypes` with a `DelegationSwConnector`.

[constr_1070] Compatibility of `PortPrototypes` of different `DataInterfaces` in the context of `DelegationSwConnectors` [`PortPrototypes` of different `DataInterfaces` are compatible if and only if

1. One of the following conditions applies:

- (a) For each `VariableDataPrototype` or `ParameterDataPrototype` defined in the context of the `DataInterface` of the required inner `PortPrototype` a compatible `VariableDataPrototype` or `ParameterDataPrototype` exists in the `DataInterface` of the required outer `PortPrototype`.

The `shortName` of `VariableDataPrototypes` and `ParameterDataPrototypes` are used to identify the pair.

[constr_1071] defines which `PortInterface` elements are compatible depending on the `PortInterface` type and the `swImplPolicy` attributes of the `PortInterface` elements.

- (b) A `VariableAndParameterInterfaceMapping.dataMapping` exists for which the following conditions apply:
 - i. It is referenced by the corresponding `SwConnector`.
 - ii. It references one of the two `VariableDataPrototypes` or `ParameterDataPrototypes` in the role `firstDataPrototype` and the other in the role `secondDataPrototype`.

2. One of the following conditions applies:

- (a) For at least one `VariableDataPrototype` or `ParameterDataPrototype` defined in the context of the `SenderReceiverInterface`, `NvDataInterface` or `ParameterInterface` of the provided inner `PortPrototype` a compatible `VariableDataPrototype` or `ParameterDataPrototype` exists in the `SenderReceiverInterface`, `NvDataInterface` or `ParameterInterface` of the provided outer `PortPrototype`.

The `shortNames` of `VariableDataPrototypes` and `ParameterDataPrototypes` are used to identify the pair.

[constr_1071] defines which `PortInterface` elements are compatible depending on the `PortInterface` type and the `swImplPolicy` attributes of the `PortInterface` elements.

- (b) A `VariableAndParameterInterfaceMapping.dataMapping` exists for which the following conditions apply:
 - i. It is (if a corresponding `SwConnector` already exists) referenced by the corresponding `SwConnector`.
 - ii. It references one of the two `VariableDataPrototypes` or `ParameterDataPrototypes` in the role `firstDataPrototype` and the other in the role `secondDataPrototype`.
- 3. For each such pair, the values of their `isService` attributes are identical.

]0

6.4.3 Connection of Required and Provided Port via PassThroughSwConnector

[constr_1248] **Compatibility of `PortPrototypes` of different `DataInterfaces` in the context of a `PassThroughSwConnector`** [`PortPrototypes` of different `DataInterfaces` are considered compatible if and only if

1. For **at least one** `VariableDataPrototype` or `ParameterDataPrototype` defined in the context of the `DataInterface` of the required outer `PortPrototype` a compatible `VariableDataPrototype` or `ParameterDataPrototype` exists in the `DataInterface` of the provided outer `PortPrototype`.

Either the `shortName` of `VariableDataPrototypes` and `ParameterDataPrototypes` are used to identify the pair **or** a `PortInterfaceMapping` exists that defines which differently named elements of `PortInterfaces` correlate with each other.

2. For each such pair, the values of the `PortInterface.isService` attributes are identical.

]0

The table 6.1 defines which elements of `PortInterface` are considered compatible depending on the type of `PortInterface` as well as the attribute `swImplPolicy` of the elements of `PortInterfaces`.

6.4.4 Compatibility of ParameterDataPrototype and VariableDataPrototype depending on PortInterface Type

Table 6.1 contains a comprehensive description of which combinations of `ParameterDataPrototype` and `VariableDataPrototype` used in `PortPrototypes` typed by various kinds of `PortInterfaces` are considered compatible.

[constr_1071] compatibility of `ParameterDataPrototype` and `VariableDataPrototype` [Combinations of `ParameterDataPrototype` and `VariableDataPrototype` used in `PortPrototypes` typed by various kinds of `PortInterfaces` shall only be allowed where Table 6.1 contains the value “yes”.]()

The following legend applies for the abbreviations used in table 6.1:

Interface Element i.e. elements of `PortInterface`

PDP `ParameterDataPrototype`

VDP `VariableDataPrototype`

Port Interface i.e. kind of `PortInterface`

Prm `ParameterInterface`

S/R `SenderReceiverInterface`

NvD `NvDataInterface`

Provided Port Required Outer Port Provided Inner Port Required Outer Port			Required Port Required Inner Port Provided Outer Port Provided Outer Port					
<code>PortInterface</code>			Prm			S/R		NvD
Interface Element			PDP			VDP		VDP
<code>SwImplPolicyEnum</code>			<code>fixed</code>	<code>const</code>	<code>standard</code>	<code>standard</code>	<code>queued</code>	<code>standard</code>
Prm	PDP	<code>fixed</code>	yes	yes	yes	yes	no	yes
		<code>const</code>	no	yes	yes	yes	no	yes
		<code>standard</code>	no	no	yes	yes	no	yes
S/R	VDP	<code>standard</code>	no	no	no	yes	no	yes
		<code>queued</code>	no	no	no	no	yes	no
NvD	VDP	<code>standard</code>	no	no	no	yes	no	yes

Table 6.1: Overview of compatibility of `ParameterDataPrototype` and `VariableDataPrototype`

[constr_1071] defines which `PortInterface` elements are compatible depending on the kind of `PortInterface` and the `swImplPolicy` attributes of the `PortInterface` elements.

[constr_1287] Compatibility of `SenderReceiverInterfaces` with respect to `invalidationPolicy` [`VariableDataPrototypes` defined in the context of the `SenderReceiverInterface` are only compatible if the `invalidationPolicies` have the same value.]()

[TPS_SWCT_01567] Default behavior for **invalidationPolicy** [For `VariableDataPrototypes` and `ParameterDataPrototypes` in the context of `NvDataInterface` respectively `ParameterInterface`, the `invalidationPolicy` is treated like “Invalidation is switched off” (`dontInvalidate`).] (*RS_SWCT_00200*)

6.5 Compatibility of Mode Switch Interfaces

Please note that this compatibility requirement only satisfies static correctness which means that logical consistency is not assured (e.g. that a receiver shall process a certain data value to correctly interpret the following values).

Note that concerning the compatibility of `ModeSwitchInterfaces` it is necessary to distinguish between the context of an `AssemblySwConnector`, the context of an `DelegationSwConnector`, and the context of a `PassThroughSwConnector`.

6.5.1 Connection of Required and Provided Port via `AssemblySwConnector`

Here, the compatibility of `ModeSwitchInterfaces` is considered for the context of an `AssemblySwConnector`.

[constr_1072] Compatibility of **`ModeSwitchInterfaces`** in the context of an **`AssemblySwConnector`** [`PortPrototypes` of different `ModeSwitchInterfaces` are compatible if and only if

1. One of the following conditions applies:
 - (a) For the `ModeDeclarationGroupPrototype` defined in the context of the `ModeSwitchInterface` of the required `PortPrototype` a compatible `ModeDeclarationGroupPrototype` exists in the `ModeSwitchInterface` of the provided `PortPrototype`.
 - (b) A `ModeInterfaceMapping.modeMapping` exists for which the following conditions apply:
 - i. It is referenced by the corresponding `SwConnector`.
 - ii. It references one of the two `ModeDeclarationGroupPrototypes` in the role `firstModeGroup` and the other in the role `secondModeGroup`.
2. For each such pair, the values of their `isService` attributes are identical.

]0

6.5.2 Connection of Inner and Outer Port via DelegationSwConnector

Here, the compatibility of `ModeSwitchInterfaces` is considered for the context of a `DelegationSwConnector`.

[constr_1073] Compatibility of `ModeSwitchInterfaces` in the context of an `DelegationSwConnector` [`PortPrototypes` of different `ModeSwitchInterfaces` are compatible if and only if

1. One of the following conditions applies:
 - (a) For the `ModeDeclarationGroupPrototype` defined in the context of the `ModeSwitchInterface` of the inner `PortPrototype` a compatible `ModeDeclarationGroupPrototype` exists in the `ModeSwitchInterface` of the outer `PortPrototype`.
 - (b) A `ModeInterfaceMapping.modeMapping` exists for which the following conditions apply:
 - i. It is referenced by the corresponding `SwConnector`.
 - ii. It references one of the two `ModeDeclarationGroupPrototypes` in the role `firstModeGroup` and the other in the role `secondModeGroup`.
2. For each such pair, the values of their `isService` attributes are identical.

]()

6.5.3 Connection of Outer and Outer Port via PassThroughSwConnector

[constr_1249] Compatibility of `ModeSwitchInterfaces` in the context of a `PassThroughSwConnector` [`PortPrototypes` of different `ModeSwitchInterfaces` are considered compatible if and only if

1. For the `ModeDeclarationGroupPrototype` defined in the context of the `ModeSwitchInterface` of the required outer `PortPrototype` a compatible `ModeDeclarationGroupPrototype` exists in the `ModeSwitchInterface` of the provided outer `PortPrototype`.

Either the `shortNames` of the `ModeDeclarationGroupPrototypes` are used to identify the pair **or** a `ModeInterfaceMapping` exists that maps the corresponding `ModeDeclarationGroupPrototypes`.
2. For each such pair, the values of the `PortInterface.isService` attributes are identical.

]()

6.6 Compatibility of Mode Declaration Group Prototypes

[constr_1074] Compatibility of `ModeDeclarationGroupPrototypes` [

`ModeDeclarationGroupPrototypes` are compatible if and only if one of the following conditions applies:

1. They are typed by (read “refer to”) compatible `ModeDeclarationGroups`.
2. A `ModeDeclarationGroupPrototypeMapping` exists that identifies the differently named `ModeDeclarationGroupPrototypes` that correlate with each other. [constr_1210] applies.

]()

6.7 Compatibility of Mode Declaration Groups

[constr_1075] Compatibility of `ModeDeclarationGroups` [`ModeDeclarationGroups` are compatible if and only if one of the following conditions applies:

1. All the following subconditions apply:
 - (a) They define an identical number of `ModeDeclarations`.
 - (b) Each `ModeDeclaration` on the required side corresponds to a `ModeDeclaration` on the provided side with an identical `shortName`.
 - (c) The `initialModes` on both sides refer to `ModeDeclarations` with identical `shortNames`.
 - (d) The attribute `ModeDeclarationGroup.modeUserErrorBehavior.errorReactionPolicy` has identical values on both sides.
 - (e) The attribute `ModeDeclarationGroup.modeManagerErrorBehavior.errorReactionPolicy` has identical values on both sides.
 - (f) The attribute `ModeDeclarationGroup.modeUserErrorBehavior.defaultMode` either does not exist on both sides or refers on both sides to `ModeDeclarations` with identical `shortNames`.
 - (g) The attribute `ModeDeclarationGroup.modeManagerErrorBehavior.defaultMode` either does not exist on both sides or refers on both sides to `ModeDeclarations` with identical `shortNames`.
 - (h) one of the following subconditions applies:
 - the attribute `category` has the value `ALPHABETIC_ORDER` on both sides.

- the attribute `category` has the value `EXPLICIT_ORDER` on both sides **and** the matching `ModeDeclarations` according to 1(b) have the identical values of the attributes `ModeDeclaration.value` **and** also the value of `ModeDeclarationGroup.onTransitionValue` matches on both sides.
2. A `ModeDeclarationMapping` is applied which identifies the corresponding `ModeDeclarations`.

In addition, the compatibility of corresponding `ModeTransitions` shall be checked, i.e. [`constr_1194`] and [`constr_1245`] apply.]()

[constr_1245] Consideration of `ModeTransitions` for the compatibility of `ModeDeclarationGroups` [One of the following conditions for the consideration of `ModeTransitions` for the compatibility of `ModeDeclarationGroups` shall apply:

- **Either** the mode provider **or** the mode user define `ModeTransitions`.
- The `ModeTransitions` defined in the context of the mode provider are **identical** to the `ModeTransitions` defined in the context of the mode user **or** a `ModeDeclarationMapping` mapping is applied.

]()

[constr_1194] Identical `ModeTransitions` [Two `ModeDeclarationGroups` contain identical `modeTransitions` if and only if

1. For each `ModeTransition` defined in the context of the mode provider one `ModeTransition` with the same `shortName` is defined in the context of the mode user.
2. Each pair of `ModeTransitions` in both `ModeDeclarationGroups` identified by their respective `shortName` have identical targets (in terms of the `shortName` of the referenced `ModeDeclaration`) of the references `enteredMode` and `exitedMode`.

]()

6.8 Compatibility of Argument Prototypes

[constr_1076] Compatibility of `ArgumentDataPrototypes` [Two `ArgumentDataPrototypes` are compatible if and only if

1. They are typed by compatible `AutosarDataTypes` **or** a `ClientServerOperationMapping.argumentMapping` exists that references one `ArgumentDataPrototype` in the role `firstDataPrototype` and the other `ArgumentDataPrototype` in the role `secondDataPrototype`.
2. They have the same value of the argument `direction` (`in`, `out` or `inout`), i.e. [`constr_1268`] applies.

]0

6.9 Compatibility of Application Errors

[constr_1077] Compatibility of `ApplicationErrors` [Two `ApplicationErrors` are compatible if and only if one of the following conditions applies:

1. All the following subconditions apply:
 - (a) They have the same `shortName`.
 - (b) They have the same attributes. Especially the `errorCode` shall be identical in both `ApplicationErrors`.
2. A `ClientServerInterfaceMapping.errorMapping` exists that references one of the `ApplicationErrors` in the role `firstApplicationError` and the other `ApplicationErrors` in the role `secondApplicationError`.

]0

6.10 Compatibility of Client/Server Operations

[constr_1078] Compatibility of `ClientServerOperations` [Two `ClientServerOperations` are compatible if their signatures match. In particular, they are compatible if and only if

1. They have the same number of `ArgumentDataPrototypes`.
2. The n-th arguments of both `ClientServerOperations` are compatible. This implies ordering of `ArgumentDataPrototypes`.
3. They have identical values of attribute `diagArgIntegrity` or the attribute `diagArgIntegrity` does not exist on both sides.
4. They have the same `shortName` (again allows for mapping in `PortInterfaces`).
5. The required `ClientServerOperation` specifies a compatible `ApplicationError` for each `ApplicationError` that is possibly raised by the provided `ClientServerOperation`, maybe more. Thereby, `ClientServerOperations` that refer to a `possibleError` that represents the value `E_OK` are compatible to `ClientServerOperations` that do refer to `possibleErrors` where none of them represents the value `E_OK`.

]0

6.11 Compatibility of Client Server Interfaces

Please note that this compatibility requirement only satisfies static correctness which means that logical consistency is not assured (e.g. that a client shall call a certain operation to allow the server to work correctly).

6.11.1 Connection of Required and Provided Port via AssemblySwConnector

[constr_1079] Compatibility of `ClientServerInterfaces` in the context of an `AssemblySwConnector` [`ClientServerInterfaces` are compatible if and only if

1. One of the following conditions applies:
 - (a) For each `ClientServerOperation` defined in the context of the `ClientServerInterface` of the required `PortPrototype` a compatible `ClientServerOperation` exists in the `ClientServerInterface` of the provided `PortPrototype`. The `shortNames` of `ClientServerOperations` are used to identify the pair.
 - (b) A `ClientServerInterfaceMapping.operationMapping` exists for which the following conditions apply:
 - i. It is referenced by the corresponding `SwConnector`.
 - ii. It references one of the two `ClientServerOperations` in the role `firstOperation` and the other in the role `secondOperation`.
2. For each such pair, the values of their `isService` attributes are identical.

]()

6.11.2 Connection of Inner and Outer Port via DelegationSwConnector

[constr_1080] Compatibility of `ClientServerInterfaces` in the context of an `DelegationSwConnector` [`ClientServerInterfaces` are compatible if and only if

1. One of the following conditions applies:
 - (a) For each `ClientServerOperation` defined in the context of the `ClientServerInterface` of the required inner `PortPrototype` a compatible `ClientServerOperation` exists in the `ClientServerInterface` of the required outer `PortPrototype`. The `shortNames` of `ClientServerOperations` are used to identify the pair.
 - (b) A `ClientServerInterfaceMapping.operationMapping` exists for which the following conditions apply:
 - i. It is referenced by the corresponding `SwConnector`.

- ii. It references one of the two `ClientServerOperations` in the role `firstOperation` and the other in the role `secondOperation`.
 2. One of the following conditions applies:
 - (a) For at least one `ClientServerOperation` defined in the context of the `ClientServerInterface` of the provided inner `PortPrototype` a compatible `ClientServerOperation` exists in the `ClientServerInterface` of the provided outer `PortPrototype`. The `shortNames` of `ClientServerOperations` are used to identify the pair.
 - (b) A `ClientServerInterfaceMapping.operationMapping` exists for which the following conditions apply:
 - i. It is referenced by the corresponding `SwConnector`.
 - ii. It references one of the two `ClientServerOperations` in the role `firstOperation` and the other in the role `secondOperation`.
 3. For each such pair, the values of their `isService` attributes are identical.

]()

6.11.3 Connection of Outer and Outer Port via `PassThroughSwConnector`

[constr_1250] Compatibility of `ClientServerInterfaces` in the context of a `PassThroughSwConnector` [`PortPrototypes` of different `ClientServerInterfaces` are considered compatible if and only if

1. For at least one `ClientServerOperation` defined in the context of the `ClientServerInterface` of the provided outer `PortPrototype` a compatible `ClientServerOperation` exists in the `ClientServerInterface` of the required outer `PortPrototype`.
Either the `shortNames` of the `ClientServerOperations` are used to identify the pair **or** a `ClientServerInterfaceMapping` exists that maps the corresponding `ClientServerOperations`.
2. For each such pair, the values of the `PortInterface.isService` attributes are identical.

]()

6.12 Compatibility of Trigger Interfaces

Please note that this compatibility requirement only satisfies static correctness which means that logical consistency is not assured (e.g. that a client shall call a certain operation to allow the server to work correctly).

6.12.1 Connection of Required and Provided Port via AssemblySwConnector

[constr_1081] Compatibility of TriggerInterfaces in the context of an AssemblySwConnector [TriggerInterfaces are compatible if and only if

1. One of the following conditions applies:
 - (a) For each Trigger defined in the context of the TriggerInterface of the required PortPrototype a compatible Trigger exists in the TriggerInterface of the provided PortPrototype. The shortNames of Trigger are used to identify the pair.
 - (b) A TriggerInterfaceMapping.triggerMapping exists for which the following conditions apply:
 - i. It is referenced by the corresponding SwConnector.
 - ii. It references one of the two Triggers in the role firstTrigger and the other in the role secondTrigger.
2. For each such pair, the values of their isService attributes are identical.

]()

6.12.2 Connection of Inner and Outer Port via DelegationSwConnector

[constr_1082] Compatibility of TriggerInterfaces in the context of an DelegationSwConnector [TriggerInterfaces are compatible if and only if all the following conditions apply:

1. One of the following subconditions applies:
 - (a) For each Trigger defined in the context of the TriggerInterface of the **required** inner PortPrototype a compatible Trigger exists in the TriggerInterface of the **required** outer PortPrototype. The shortNames of Trigger are used to identify the pair.
 - (b) For at least one Trigger defined in the context of the TriggerInterface of the **provided** outer PortPrototype a compatible Trigger exists in the TriggerInterface of the **provided** inner PortPrototype. The shortNames of Trigger are used to identify the pair.
 - (c) A TriggerInterfaceMapping.triggerMapping exists for which all the following conditions apply:
 - i. It is referenced by the corresponding SwConnector.
 - ii. It references one of the two Triggers in the role firstTrigger and the other in the role secondTrigger.
2. For each such pair, the values of their isService attributes are identical.

]()

6.12.3 Connection of Outer and Outer Port via PassThroughSwConnector

[constr_1251] Compatibility of PortPrototypes of TriggerInterfaces in the context of a PassThroughSwConnector [PortPrototypes of different TriggerInterfaces are considered compatible if and only if

1. For **at least one** Trigger defined in the context of the TriggerInterface of the required outer PortPrototype a compatible Trigger exists in the TriggerInterface of the provided outer PortPrototype.

Either the shortName of Triggers are used to identify the pair **or** a TriggerInterfaceMapping exists that that refers to one of the Triggers in the role firstTrigger and to the other in the role secondTrigger.

2. For each such pair, the values of the PortInterface.isService attributes are identical.

]()

6.13 Compatibility of Trigger

[constr_1083] Compatibility of Triggers [Triggers are compatible if they have an identical shortName.]()

6.14 Entire Delegation of a Provided Port Prototype

[constr_1084] delegation of a provided outer PortPrototype [The delegation of a provided outer PortPrototype is properly defined if the following criteria are fulfilled:

1. For each VariableDataPrototype or ParameterDataPrototype present in the SenderReceiverInterface, NvDataInterface, or ParameterInterface of the provided outer PortPrototype at least one connection via DelegationSwConnector to a provided inner PortPrototype **or** PassThroughSwConnector to a required outer PortPrototype with a compatible VariableDataPrototype or ParameterDataPrototype in the SenderReceiverInterface NvDataInterface or ParameterInterface of the provided inner PortPrototype **or** required outer PortPrototype exists.

Either the shortNames of VariableDataPrototypes or ParameterDataPrototypes are used to identify the pair **or** a PortInterfaceMapping defines which differently named PortInterface elements correlate with each other.

2. For each `VariableDataPrototype` provided by a `PRPortPrototype` that is typed by a `SenderReceiverInterface` or `NvDataInterface` and that is referenced in the role `outerPort` by a `DelegationSwConnector` a corresponding `VariableDataPrototype` owned by an `innerPort` shall be provided by either a `PPortPrototype` or a `PRPortPrototype`.

Either the `shortNames` of `VariableDataPrototypes` are used to identify the pair or a `PortInterfaceMapping` defines which differently named `PortInterface` elements correlate with each other.

3. For the `ModeDeclarationGroupPrototype` present in the `ModeSwitchInterface` of the provided outer `PortPrototype` exactly one connection via `DelegationSwConnector` to a provided inner `PortPrototype` or `PassThroughSwConnector` to a required outer `PortPrototype` with a compatible `ModeDeclarationGroupPrototype` in the `ModeSwitchInterface` of the provided inner `PortPrototype` or required outer `PortPrototype` exists.

Either the `shortNames` of `ModeDeclarationGroupPrototypes` are used to identify the pair or a `PortInterfaceMapping` defines which differently named `PortInterface` elements correlate with each other.

4. For each `ClientServerOperation` present in the `ClientServerInterface` of the provided outer `PortPrototype` exactly one connection via `DelegationSwConnector` to a provided inner `PortPrototype` or `PassThroughSwConnector` to a required outer `PortPrototype` with a compatible `ClientServerOperation` in the `ClientServerInterface` of the provided inner `PortPrototype` or required outer `PortPrototype` exists.

Either the `shortNames` of `ClientServerOperations` are used to identify the pair or a `PortInterfaceMapping` defines which differently named `PortInterface` elements correlate with each other.

5. For each `Trigger` present in the `TriggerInterface` of the provided outer `PortPrototype` exactly one connection via `DelegationSwConnector` to a provided inner `PortPrototype` or `PassThroughSwConnector` to a required outer `PortPrototype` with a compatible `Trigger` in the `TriggerInterface` of the provided inner `PortPrototype` or required outer `PortPrototype` exists.

Either the `shortNames` of `Triggers` are used to identify the pair or a `PortInterfaceMapping` defines which differently named `PortInterface` elements correlate with each other.

]0

Table 6.1 defines which `PortInterface` elements are compatible depending on the kind of `PortInterface` and the `swImplPolicy` attributes of the `PortInterface` elements.

6.14.1 Split and Merge of PortInterface Elements

With the definition of compatibility rules in chapter 6.4, 6.11, and 6.12, it is possible to split and distribute elements of a `PortPrototype` typed by a `PortInterface` containing a superset of `PortInterface` elements to `PortPrototypes` of type of `PortInterfaces` containing subsets of `PortInterface` elements.

Please find examples that explain the usage of splitting and merging in section 6.16.2.

6.15 Compatibility in Case of a Flat ECU Extract

Please note that in the case of a flat ECU extract of software-components specific compatibility rules apply. To some extent, these rules contradict the rules existing for the pure VFB approach (see chapter 6). That is, if the split-and-merge pattern has been applied on the creation of `DelegationSwConnectors` it might happen that compatibility rules defined in chapter 6 are violated.

However, given that the flattened ECU extract has been created out of a valid `CompositionSwComponentType` the flattened ECU extract does not become invalid in this case. In other words, the transformation does not create an invalid model out of a valid model.

However, to support this statement it is necessary to define additional compatibility rules that properly cover this case and allow for a successful validation of the flattened ECU extract.

For the flat ECU extract the compatibility of `SenderReceiverInterfaces`, `NvDataInterfaces`, and `ParameterInterfaces` is considered for connecting of `PortPrototypes` with a `DelegationSwConnector`.

[constr_1085] Compatibility in the case of a flat ECU extract [`PortPrototypes` of different `SenderReceiverInterfaces`, `NvDataInterfaces`, and `ParameterInterfaces` are compatible if and only if for at least one `VariableDataPrototype` or `ParameterDataPrototype` defined in the context of the `SenderReceiverInterface`, `NvDataInterface`, or `ParameterInterface` of the `RPortPrototype` a compatible `VariableDataPrototype` or `ParameterDataPrototype` exists in the `SenderReceiverInterface`, `NvDataInterface`, or `ParameterInterface` of the provided `PortPrototype`.

The compatibility of `PortInterface` elements depends on the kind of `PortInterface` and the `swImplPolicy` attributes of the `PortInterface` elements.

Either the `shortNames` of `VariableDataPrototypes` and `ParameterDataPrototypes` are used to identify the pair or a `PortInterfaceMapping` defines which differently named `PortInterface` elements correlate with each other.] ()

For clarification, table 6.1 defines which `PortInterface` elements are compatible depending on the kind of `PortInterface` and the `swImplPolicy` attributes of the `PortInterface` elements.

Please note that in case of the flat ECU extract it might happen that `AssemblySwConnectors` that connect to a specific `RPortPrototype` also connect to `PPortPrototypes` that do not fulfill the compatibility rule specified in 6.4.1.

In particular, the `dataElements` might correspond to `dataElements` defined in the scope of different `PPortPrototypes`. In other words, in the flat ECU extract it is possible to merge `dataElements` from different providers.

6.16 Compatibility Examples

This section provides some examples that may explain the compatibility of `PortPrototypes`.

6.16.1 Compatibility on Assembly Level

The rules for compatibility with respect to the connection of `dataElements` by means of `AssemblySwConnectors` are perhaps easier to digest than the delegation case but nonetheless it seems appropriate to provide a set of examples that illustrate the compatibility issue.

6.16.1.1 Legal Use

One of the less trivial examples of this kind is the case of sender/receiver n:1 communication. Figure 6.1 sketches a case where both sender software-components provide the dull set of `dataElements` that are required by the `RPortPrototype` of the receiving software-component.

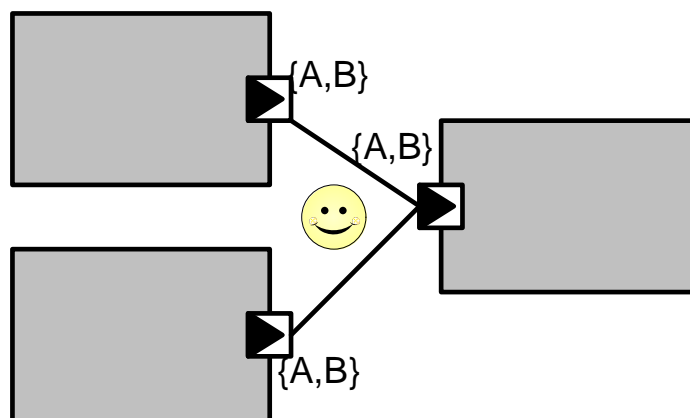

Figure 6.1: legal n:1 communication

The next case (exemplified by Figure 6.2) implements a situation where one sender provides two `dataElements` {A, B} while the other sender provides only as subset of these, i.e. {B}.

As the `RPortPrototype` of the receiving software-component requires only the `dataElement` {B} compatibility issues will not occur because for every required `dataElement` a compatible `dataElement` is provided.

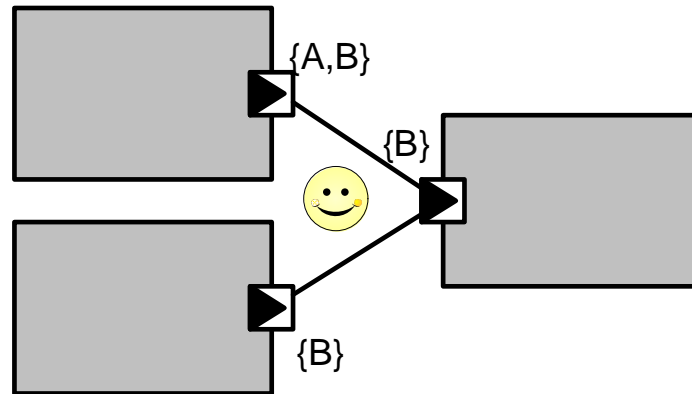

Figure 6.2: legal n:1 communication

6.16.1.2 Illegal Use

One possible example for an illegal configuration of a sender/receiver communication is the scenario sketched in Figure 6.3. Although the sender software-components in total provide the set of required `dataElements` the *individual AssemblySwConnectors* create incompatible connections between sender and receiver.

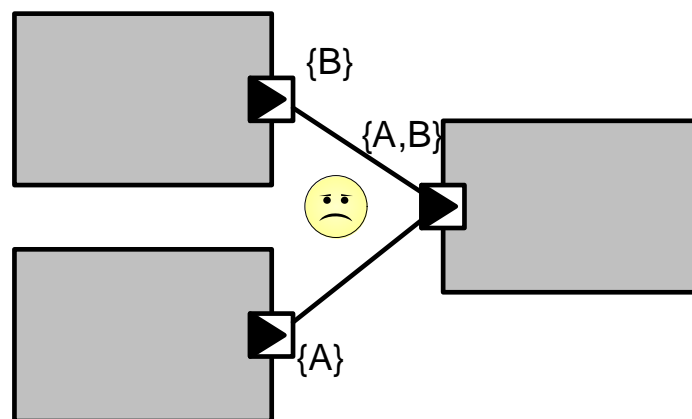

Figure 6.3: illegal n:1 communication

6.16.2 Compatibility on Delegation Level

The rules for compatibility with respect to the delegation of `dataElements` perhaps require some explanation in terms of examples. The first example 6.4 describes a legal situation where two `DelegationSwConnectors` split the `dataElements` contained in the `RPortPrototype` owned by a `CompositionSwComponentType`.

6.16.2.1 Legal Use

The examples explain the usage of `DelegationSwConnectors` in different configurations and different values of `DelegatedPortAnnotation`. Please note that the `DelegatedPortAnnotation` is usually defined before the internal structure of a `CompositionSwComponentType` is fully clarified.

At a later point in time it has to be consistent or can be removed. Decorating the example with applicable values of `DelegatedPortAnnotation` should facilitate the understanding of the meaning of the `DelegatedPortAnnotation`.

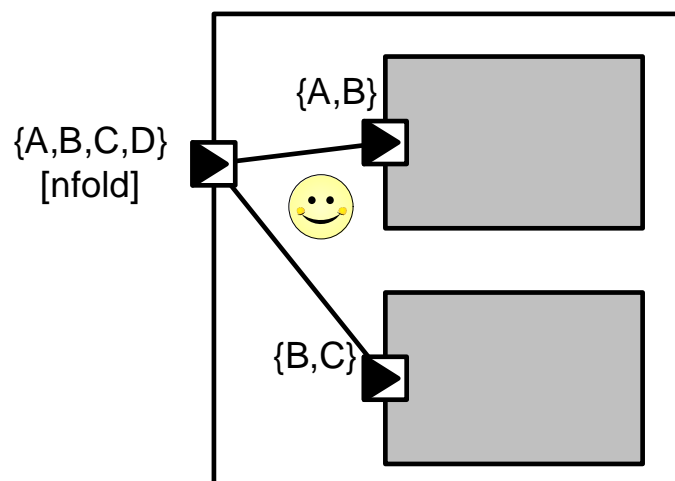

Figure 6.4: Legal split of delegation connector

All required `dataElements` are provided by the `DelegationSwConnectors` attached to the delegation `RPortPrototype`. The fact that `dataElement` D is not conveyed to any of the `RPortPrototypes` owned by the `SwComponentPrototypes` does not have any impact on the compatibility.

In other words: the `RPortPrototype` at the `CompositionSwComponentType` actually contains the superset of `dataElements` `{A, B, C, D}`. The two required inner `PortPrototypes` of the `SwComponentPrototypes` contain the subsets of `VariableDataPrototypes` `{A, B}` and `{B, C}`. In this case the resulting communication pattern on the VFB for B would be 1:n.

This requires the value of the attribute `signalFan` of `DelegatedPortAnnotation` to be set to the value `nfold`.

In the next example the `RPortPrototype` of the `CompositionSwComponentType` contains the superset of `dataElements` {A, B}. The two `RPortPrototypes` of the `SwComponentPrototypes` contain *different* subsets, i.e. {A} and {B}.

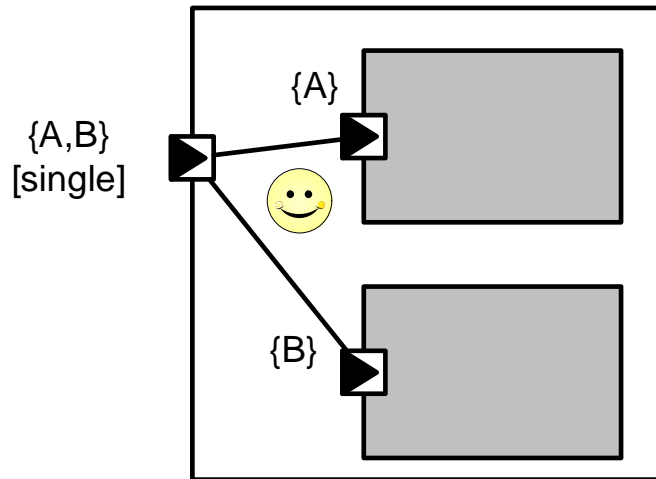

Figure 6.5: Legal split of delegation connector

In this case the resulting communication pattern on the `VFB` would be `n:1`. In this case the value of the attribute `signalFan` of `DelegatedPortAnnotation` should be set to `single`.

The next example is about the merge of `DelegationSwConnectors`. The `PPortPrototype` owned by the `CompositionSwComponentType` contains a superset of `dataElements` {A, B}. The two `PPortPrototypes` of the `SwComponentPrototypes` contain a *disjoint* subset each, i.e. {A} and {B}.

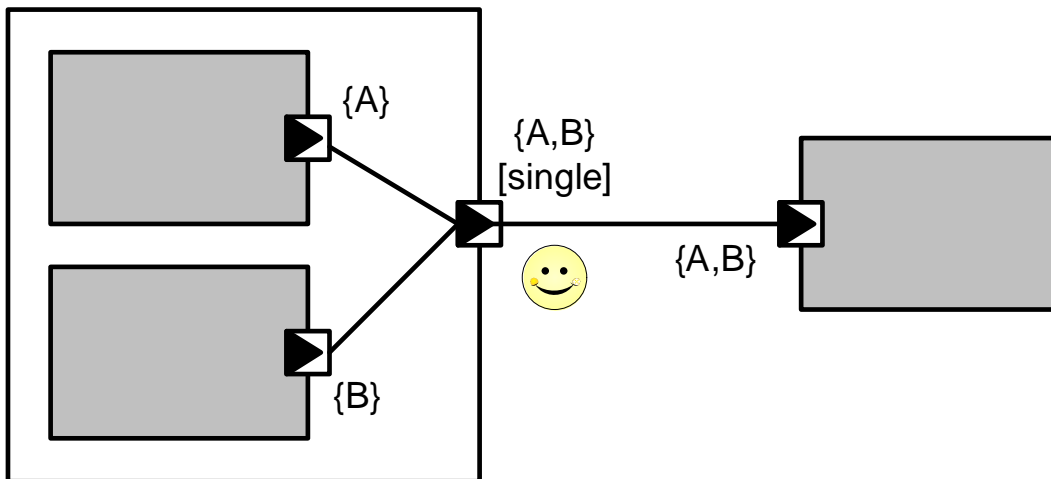

Figure 6.6: Legal merge of delegation connector

In this case the resulting communication pattern on the `VFB` would be `1:x`, with `x` taking values between 0 and `n`. In this case the value of the attribute `signalFan` of `DelegatedPortAnnotation` should be set to `single`. All `VariableDataPrototypes` of the provided outer `PortPrototypes` are provided by exactly one provided inner `PortPrototype`.

As a variation of this theme, the next example features a `PPortPrototype` owned by a `CompositionSwComponentType` that contains the superset of `dataElements` {A, B, C}.

The `PPortPrototypes` of the `SwComponentPrototypes` in turn contain subsets of `dataElements`, i.e. {A, B} and {B, C}. In this case the resulting communication pattern on the VFB for {B} would be n:1.

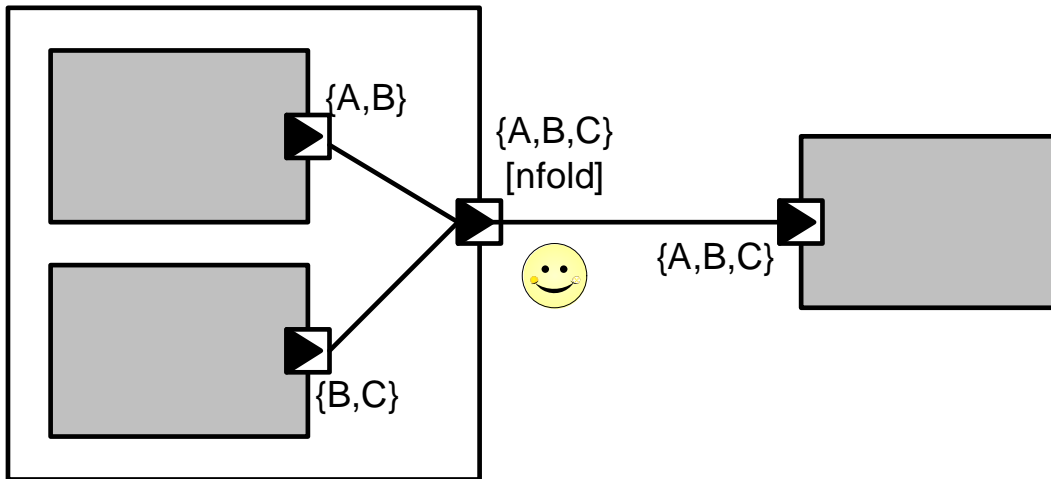

Figure 6.7: Legal merge of delegation connector

This would require the value of the attribute `signalFan` of `DelegatedPortAnnotation` to be set to `nfold`. All `dataElements` of the delegation `PPortPrototype` are provided by at least one `PPortPrototype` of the `SwComponentPrototypes`. Therefore, the criteria of `entire delegation` defined in chapter 6.14 are fulfilled.

The next example looks very similar. However, the subtle difference is that the second `SwComponentPrototype` provides `dataElements` {C, D} rather than {B, C}.

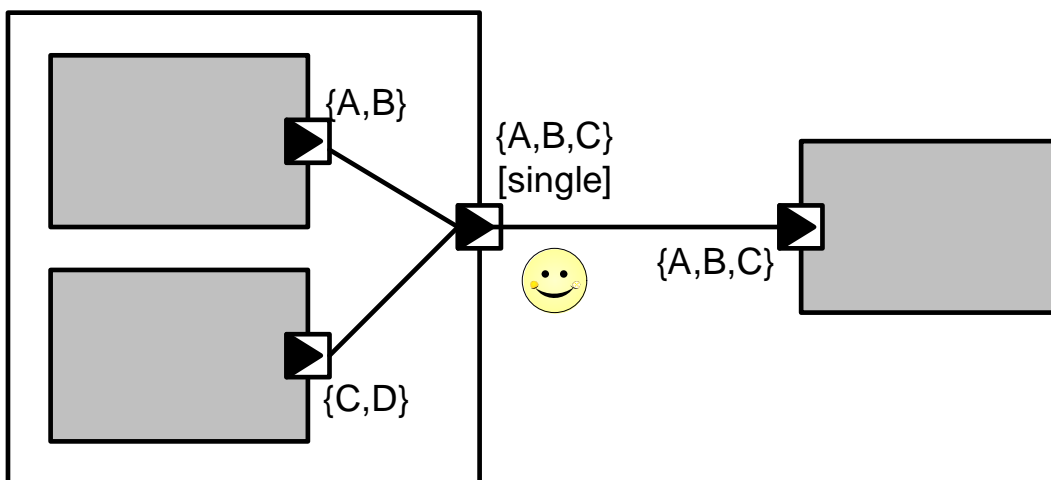

Figure 6.8: Legal merge of delegation connector

Although `dataElement` {D} does not appear in the delegation `PPortPrototype`, the compatibility rules are fully satisfied with this scenario.

The next example shows a valid delegation of *SwConnectors* that goes end-to-end via *CompositionSwComponentTypes* to included *SwComponentPrototypes*.

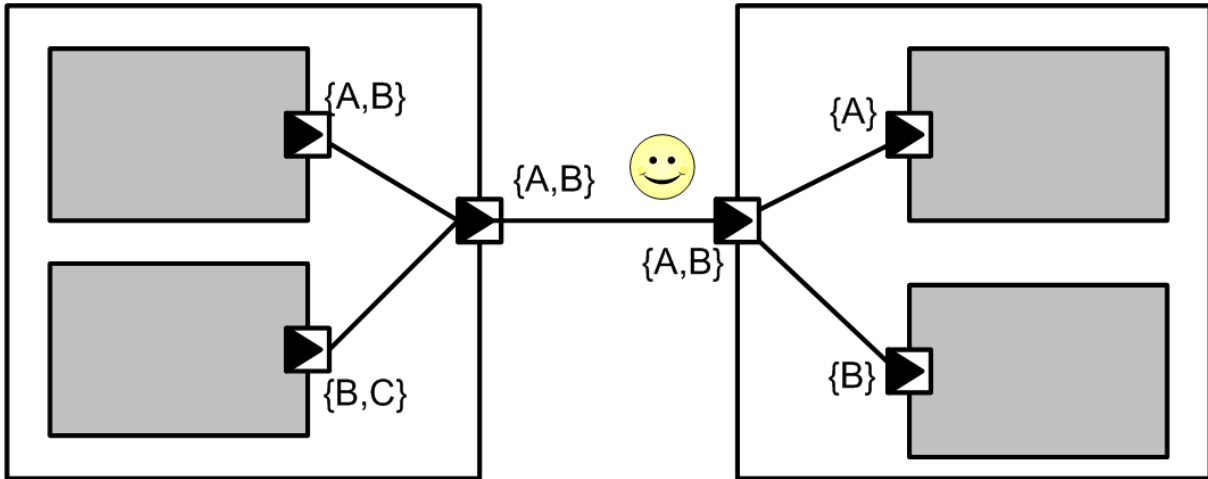

Figure 6.9: Valid delegation of *SwConnectors* that goes end-to-end

6.16.2.2 Illegal Use

The first example for an illegal use of splitting of *dataElements* suffers from the fact that not all *dataElements* owned by the *RPortPrototypes* of the *SwComponentPrototypes* are available from the connected *RPortPrototypes* owned by the *CompositionSwComponentType*.

Although *dataElements* the connections in total match (*{A}* and *{B}* are connected to a *PortPrototype* requiring *{A, B}*) the compatibility rules are not fulfilled because they apply separately for *each SwConnector*

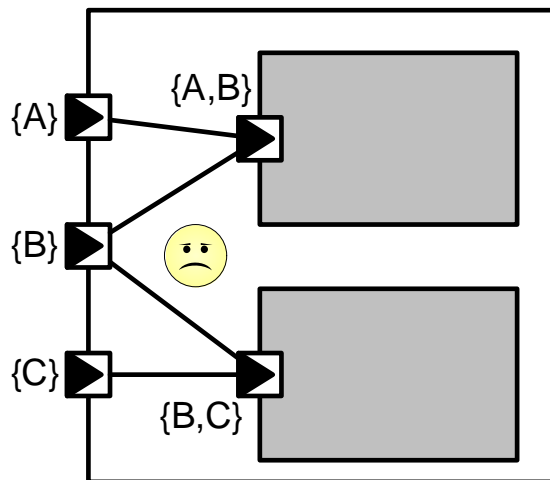

Figure 6.10: Illegal split of delegation connector

In the next example compatibility is also not fulfilled because the required *dataElement* *{E}* is not provided by the delegation *RPortPrototype*.

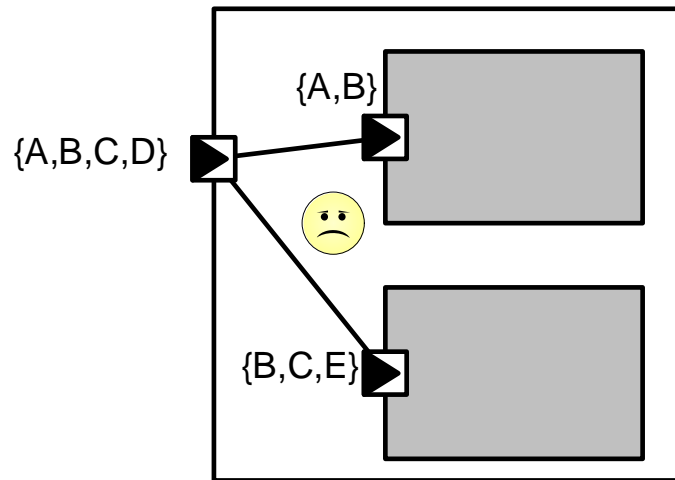

Figure 6.11: Illegal split of delegation connector

An incompatible merge of *DelegationSwConnectors* is sketched in Figure 6.12. In this case the *dataElement* {E} is *not* provided by one of the *PPortPrototypes* owned by the *SwComponentPrototypes* inside the *CompositionSwComponentType*.

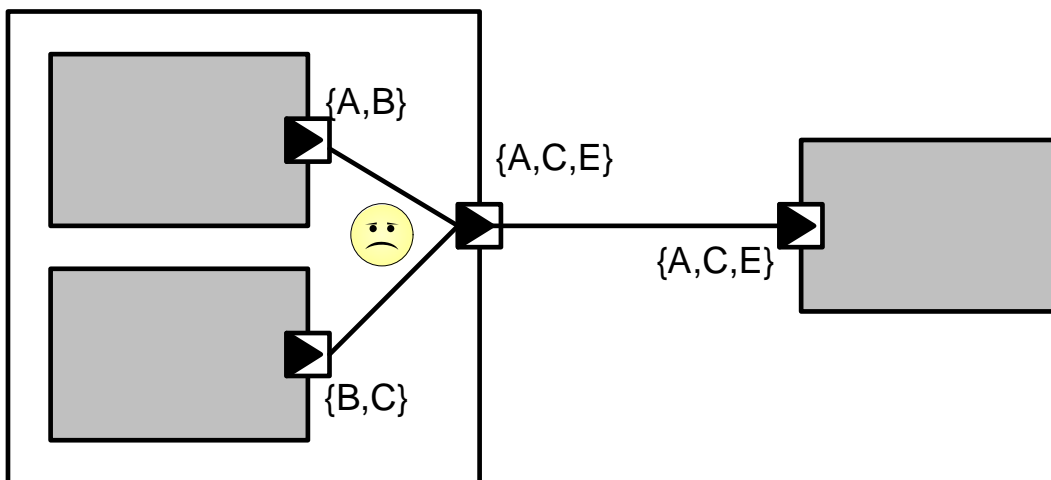

Figure 6.12: Illegal merge of delegation connector

The next example shows an invalid delegation of *SwConnectors* that goes end-to-end via *CompositionSwComponentTypes* to included *SwComponentPrototypes*.

Similar to the example sketched in Figure 6.12, the *dataElement* {E} is *not* provided by one of the *PPortPrototypes* owned by the *SwComponentPrototypes* inside the *CompositionSwComponentType*.

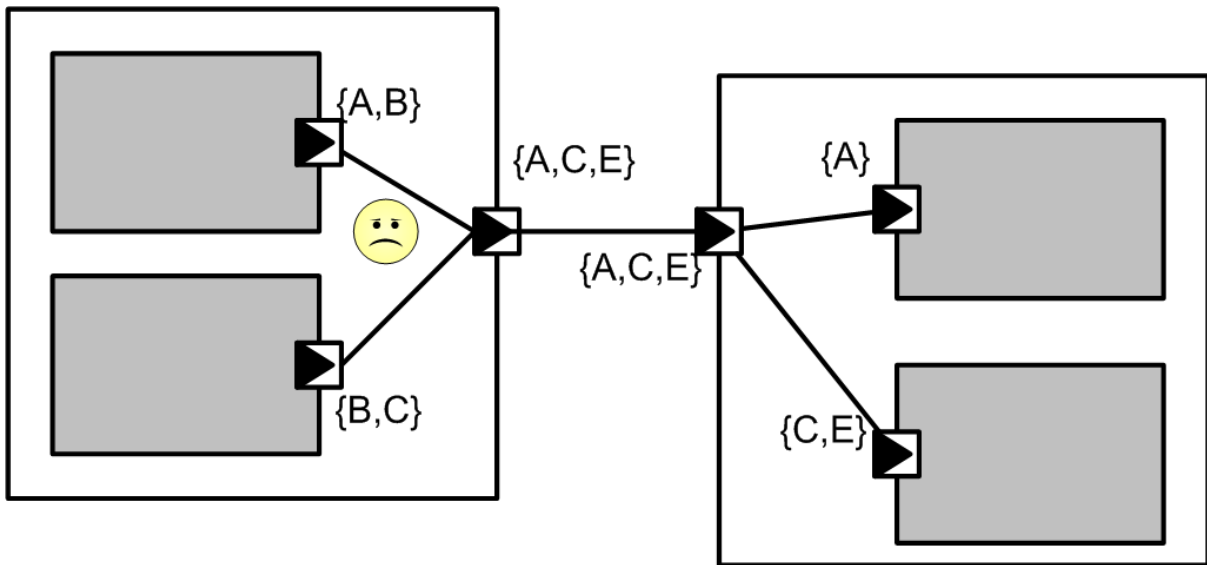

Figure 6.13: Invalid delegation of **SwConnectors** that goes end-to-end

7 Internal Behavior

7.1 Introduction

[TPS_SWCT_01075] **SwcInternalBehavior** [SwcInternalBehavior provides means for formally defining the behavior of an AtomicSwComponentType.] (RS_SWCT_03040)

This chapter focuses on the description of the SwcInternalBehavior meta-class and the various meta-classes it aggregates. An overview of the meta-class is sketched in Figure 7.2. Please note that SwcInternalBehavior inherits from InternalBehavior.

The role of SwcInternalBehavior in the context of an AUTOSAR software-component is depicted in Figure 7.1. As mentioned in section 3.2, the reason to make the aggregation of SwcInternalBehavior to AtomicSwComponentType «atpSplittable» is to allow for the development of SwcInternalBehavior in a later process step (e.g. after the VFB view has been completed).

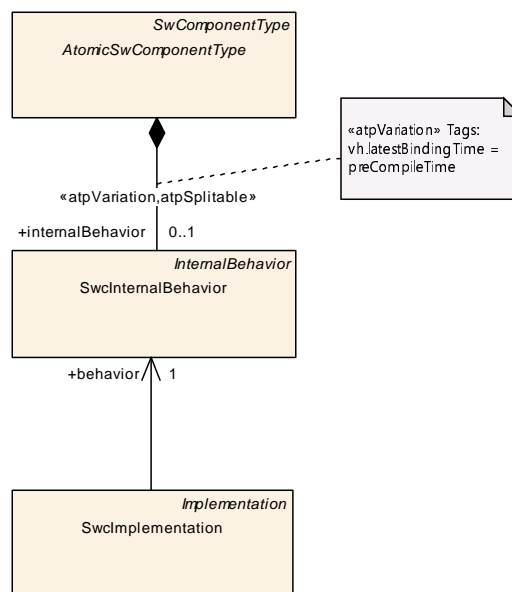

Figure 7.1: The “big picture” of SwcInternalBehavior

Class	<i>InternalBehavior</i> (abstract)
Package	M2::AUTOSARTemplates::CommonStructure::InternalBehavior
Note	Common base class (abstract) for the internal behavior of both software components and basic software modules/clusters.
Base	ARObject, AtpClassifier, AtpFeature, AtpStructureElement, Identifiable, MultilanguageReferrable, Referrable
Subclasses	BswInternalBehavior, SwcInternalBehavior





Class		InternalBehavior (abstract)		
Attribute	Type	Mult.	Kind	Note
constantMemory	ParameterDataPrototype	*	aggr	<p>Describes a read only memory object containing characteristic value(s) implemented by this InternalBehavior.</p> <p>The shortName of ParameterDataPrototype has to be equal to the "C" identifier of the described constant.</p> <p>The characteristic value(s) might be shared between SwComponentPrototypes of the same SwComponentType.</p> <p>The aggregation of constantMemory is subject to variability with the purpose to support variability in the software component or module implementations. Typically different algorithms in the implementation are requiring different number of memory objects.</p> <p>Stereotypes: atpSplitable; atpVariation Tags: atp.Splitkey=shortName, variationPoint.shortLabel vh.latestBindingTime=preCompileTime</p>
constantValueMapping	ConstantSpecificationMappingSet	*	ref	<p>Reference to the ConstanSpecificationMapping to be applied for the particular InternalBehavior</p> <p>Stereotypes: atpSplitable Tags:atp.Splitkey=constantValueMapping</p>
dataTypeMapping	DataTypeMappingSet	*	ref	<p>Reference to the DataTypeMapping to be applied for the particular InternalBehavior</p> <p>Stereotypes: atpSplitable Tags:atp.Splitkey=dataTypeMapping</p>
exclusiveArea	ExclusiveArea	*	aggr	<p>This specifies an ExclusiveArea for this InternalBehavior. The exclusiveArea is local to the component resp. module. The aggregation of ExclusiveAreas is subject to variability. Note: the number of ExclusiveAreas might vary due to the conditional existence of RunnableEntities or BswModuleEntities.</p> <p>Stereotypes: atpSplitable; atpVariation Tags: atp.Splitkey=shortName, variationPoint.shortLabel vh.latestBindingTime=preCompileTime</p>
exclusiveAreaNestingOrder	ExclusiveAreaNestingOrder	*	aggr	<p>This represents the set of ExclusiveAreaNestingOrder owned by the InternalBehavior.</p> <p>Stereotypes: atpSplitable; atpVariation Tags: atp.Splitkey=shortName, variationPoint.shortLabel vh.latestBindingTime=preCompileTime</p>
staticMemory	VariableDataPrototype	*	aggr	<p>Describes a read and writeable static memory object representing measurement variables implemented by this software component. The term "static" is used in the meaning of "non-temporary" and does not necessarily specify a linker encapsulation. This kind of memory is only supported if supportsMultipleInstantiation is FALSE.</p> <p>The shortName of the VariableDataPrototype has to be equal with the "C" identifier of the described variable.</p> <p>The aggregation of staticMemory is subject to variability with the purpose to support variability in the software component's implementations.</p>





Class	InternalBehavior (abstract)			
				Typically different algorithms in the implementation are requiring different number of memory objects. Stereotypes: atpSplitable; atpVariation Tags: atp.Splitkey=shortName, variationPoint.shortLabel vh.latestBindingTime=preCompileTime

Table 7.1: InternalBehavior

Class	SwcInternalBehavior			
Package	M2::AUTOSARTemplates::SWComponentTemplate::SwcInternalBehavior			
Note	The SwcInternalBehavior of an AtomicSwComponentType describes the relevant aspects of the software-component with respect to the RTE, i.e. the RunnableEntities and the RTEEvents they respond to.			
Base	ARObject, AtpClassifier, AtpFeature, AtpStructureElement, Identifiable , InternalBehavior , Multilanguage Referrable , Referrable			
Attribute	Type	Mult.	Kind	Note
arTypedPerInstanceMemory	VariableDataPrototype	*	aggr	Defines an AUTOSAR typed memory-block that needs to be available for each instance of the SW-component. This is typically only useful if supportsMultipleInstantiation is set to "true" or if the component defines NVRAM access via permanent blocks. The aggregation of arTypedPerInstanceMemory is subject to variability with the purpose to support variability in the software component's implementations. Typically different algorithms in the implementation are requiring different number of memory objects. Stereotypes: atpSplitable; atpVariation Tags: atp.Splitkey=shortName, variationPoint.shortLabel vh.latestBindingTime=preCompileTime
event	RTEEvent	*	aggr	This is a RTEEvent specified for the particular Swc InternalBehavior. The aggregation of RTEEvent is subject to variability with the purpose to support the conditional existence of RTE events. Note: the number of RTE events might vary due to the conditional existence of PortPrototypes using Data ReceivedEvents or due to different scheduling needs of algorithms. Stereotypes: atpSplitable; atpVariation Tags: atp.Splitkey=shortName, variationPoint.shortLabel vh.latestBindingTime=preCompileTime
exclusiveAreaPolicy	SwcExclusiveAreaPolicy	*	aggr	Options how to generate the ExclusiveArea related APIs. When no SwcExclusiveAreaPolicy is specified for an ExclusiveArea the default values apply. Stereotypes: atpSplitable; atpVariation Tags: atp.Splitkey=exclusiveAreaPolicy, variationPoint.shortLabel vh.latestBindingTime=preCompileTime





Class	SwcInternalBehavior			
explicitInterRunnableVariable	VariableDataPrototype	*	aggr	<p>Implement state message semantics for establishing communication among runnables of the same component. The aggregation of explicitInterRunnableVariable is subject to variability with the purpose to support variability in the software components implementations. Typically different algorithms in the implementation are requiring different number of memory objects.</p> <p>Stereotypes: atpSplitable; atpVariation Tags: atp.Splitkey=shortName, variationPoint.shortLabel vh.latestBindingTime=preCompileTime</p>
handleTerminationAndRestart	HandleTerminationAndRestartEnum	1	attr	<p>This attribute controls the behavior with respect to stopping and restarting. The corresponding AtomicSwComponentType may either not support stop and restart, or support only stop, or support both stop and restart.</p>
implicitInterRunnableVariable	VariableDataPrototype	*	aggr	<p>Implement state message semantics for establishing communication among runnables of the same component. The aggregation of implicitInterRunnableVariable is subject to variability with the purpose to support variability in the software components implementations. Typically different algorithms in the implementation are requiring different number of memory objects.</p> <p>Stereotypes: atpSplitable; atpVariation Tags: atp.Splitkey=shortName, variationPoint.shortLabel vh.latestBindingTime=preCompileTime</p>
includedDataTypeSet	IncludedDataTypeSet	*	aggr	<p>The includedDataTypeSet is used by a software component for its implementation.</p> <p>Stereotypes: atpSplitable Tags:atp.Splitkey=includedDataTypeSet</p>
includedModeDeclarationGroupSet	IncludedModeDeclarationGroupSet	*	aggr	<p>This aggregation represents the included Mode DeclarationGroups</p> <p>Stereotypes: atpSplitable Tags:atp.Splitkey=includedModeDeclarationGroupSet</p>
instantiationDataDefProps	InstantiationDataDefProps	*	aggr	<p>The purpose of this is that within the context of a given SwComponentType some data def properties of individual instantiations can be modified. The aggregation of InstantiationDataDefProps is subject to variability with the purpose to support the conditional existence of Port Prototypes and component local memories like "per InstanceParameter" or "arTypedPerInstanceMemory".</p> <p>Stereotypes: atpSplitable; atpVariation Tags: atp.Splitkey=instantiationDataDefProps, variationPoint.shortLabel vh.latestBindingTime=preCompileTime</p>
perInstanceMemory	PerInstanceMemory	*	aggr	<p>Defines a per-instance memory object needed by this software component. The aggregation of PerInstanceMemory is subject to variability with the purpose to support variability in the software components implementations. Typically different algorithms in the implementation are requiring different number of memory objects.</p>





Class	SwcInternalBehavior			
				<p style="text-align: center;">△</p> <p>Stereotypes: atpSplitable; atpVariation Tags: atp.Splitkey=shortName, variationPoint.shortLabel vh.latestBindingTime=preCompileTime</p>
perInstanceParameter	ParameterData Prototype	*	aggr	<p>Defines parameter(s) or characteristic value(s) that needs to be available for each instance of the software-component. This is typically only useful if supportsMultipleInstantiation is set to "true". The aggregation of perInstanceParameter is subject to variability with the purpose to support variability in the software components implementations. Typically different algorithms in the implementation are requiring different number of memory objects.</p> <p>Stereotypes: atpSplitable; atpVariation Tags: atp.Splitkey=shortName, variationPoint.shortLabel vh.latestBindingTime=preCompileTime</p>
portAPIOption	PortAPIOption	*	aggr	<p>Options for generating the signature of port-related calls from a runnable to the RTE and vice versa. The aggregation of PortPrototypes is subject to variability with the purpose to support the conditional existence of ports.</p> <p>Stereotypes: atpSplitable; atpVariation Tags: atp.Splitkey=portAPIOption, variationPoint.shortLabel vh.latestBindingTime=preCompileTime</p>
runnable	RunnableEntity	*	aggr	<p>This is a RunnableEntity specified for the particular Swc InternalBehavior.</p> <p>The aggregation of RunnableEntity is subject to variability with the purpose to support the conditional existence of RunnableEntities. Note: the number of RunnableEntities might vary due to the conditional existence of Port Prototypes using DataReceivedEvents or due to different scheduling needs of algorithms.</p> <p>Stereotypes: atpSplitable; atpVariation Tags: atp.Splitkey=shortName, variationPoint.shortLabel vh.latestBindingTime=preCompileTime</p>
serviceDependency	SwcService Dependency	*	aggr	<p>Defines the requirements on AUTOSAR Services for a particular item.</p> <p>The aggregation of SwcServiceDependency is subject to variability with the purpose to support the conditional existence of ports as well as the conditional existence of ServiceNeeds.</p> <p>The SwcServiceDependency owned by an SwcInternal Behavior can be located in a different physical file in order to support that SwcServiceDependency might be provided in later development steps or even by different expert domain (e.g OBD expert for Obd related Service Needs) tools. Therefore the aggregation is <<atp Splitable>>.</p> <p>Stereotypes: atpSplitable; atpVariation Tags: atp.Splitkey=shortName, variationPoint.shortLabel vh.latestBindingTime=preCompileTime</p>





Class	SwcInternalBehavior			
shared Parameter	ParameterData Prototype	*	aggr	<p>Defines parameter(s) or characteristic value(s) shared between SwComponentPrototypes of the same Sw ComponentType The aggregation of sharedParameter is subject to variability with the purpose to support variability in the software components implementations. Typically different algorithms in the implementation are requiring different number of memory objects.</p> <p>Stereotypes: atpSplitable; atpVariation Tags: atp.Splitkey=shortName, variationPoint.shortLabel vh.latestBindingTime=preCompileTime</p>
supports Multiple Instantiation	Boolean	1	attr	<p>Indicate whether the corresponding software-component can be multiply instantiated on one ECU. In this case the attribute will result in an appropriate component API on programming language level (with or without instance handle).</p>
variationPoint Proxy	VariationPointProxy	*	aggr	<p>Proxy of a variation points in the C/C++ implementation.</p> <p>Stereotypes: atpSplitable Tags:atp.Splitkey=shortName</p>

Table 7.2: SwcInternalBehavior

Enumeration	HandleTerminationAndRestartEnum
Package	M2::AUTOSARTemplates::SWComponentTemplate::SwcInternalBehavior
Note	Controls the behavior of an AtomicSwComponentType with respect to stop and restart.
Literal	Description
canBeTerminated	<p>Supports termination.</p> <p>Tags:atp.EnumerationLiteralIndex=0</p>
canBeTerminated AndRestarted	<p>Supports termination and restarting.</p> <p>Tags:atp.EnumerationLiteralIndex=1</p>
noSupport	<p>Stop and restart is not supported at all.</p> <p>Tags:atp.EnumerationLiteralIndex=2</p>

Table 7.3: HandleTerminationAndRestartEnum

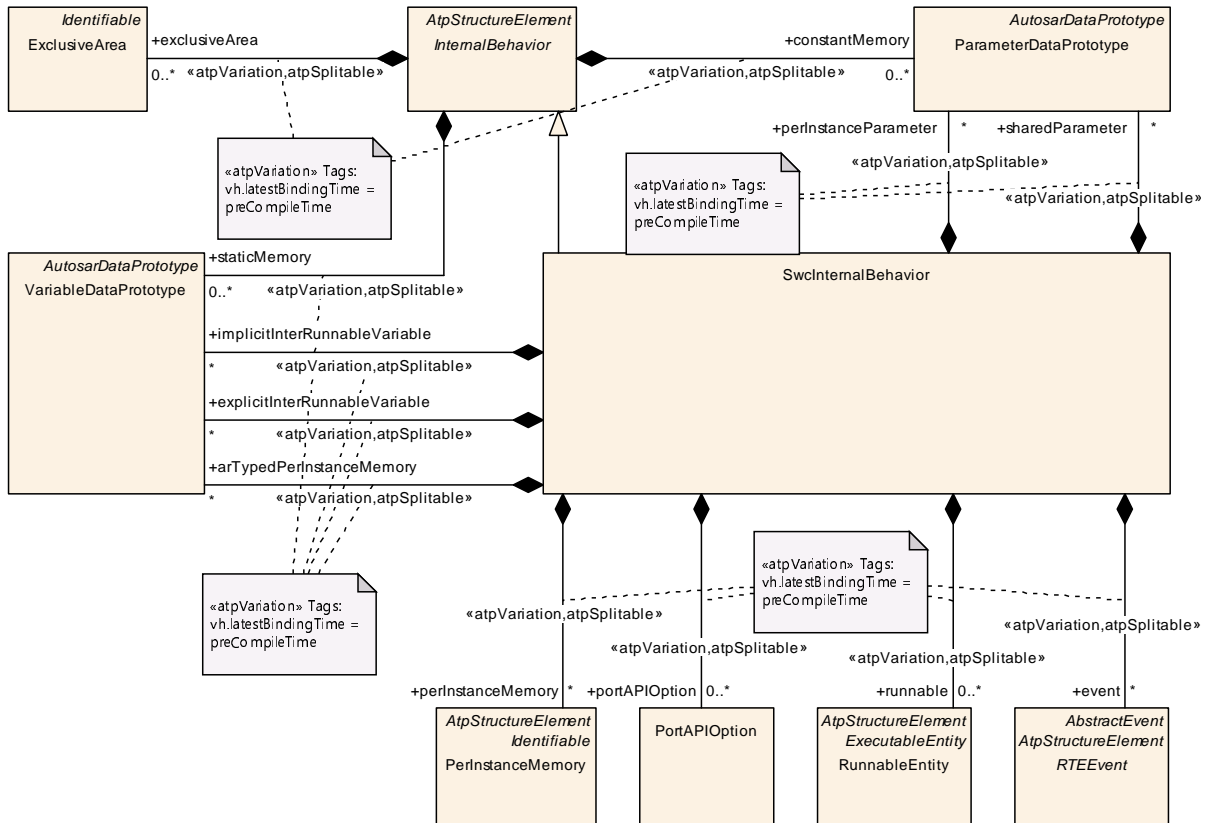

Figure 7.2: SwcInternalBehavior

7.2 Runnable Entity

The concept of `RunnableEntity` (more details can be found in Figure 7.3) is defined in the specification of the Virtual Function Bus [3].

[TPS_SWCT_01030] **RunnableEntity** [`RunnableEntity`s are the smallest code-fragments that are provided by a software-component and are (at least indirectly) a subject for scheduling by the underlying operating system or else (in rare cases) for execution in ISR context.] (*RS_SWCT_00070, RS_SWCT_00090, RS_SWCT_03050*)

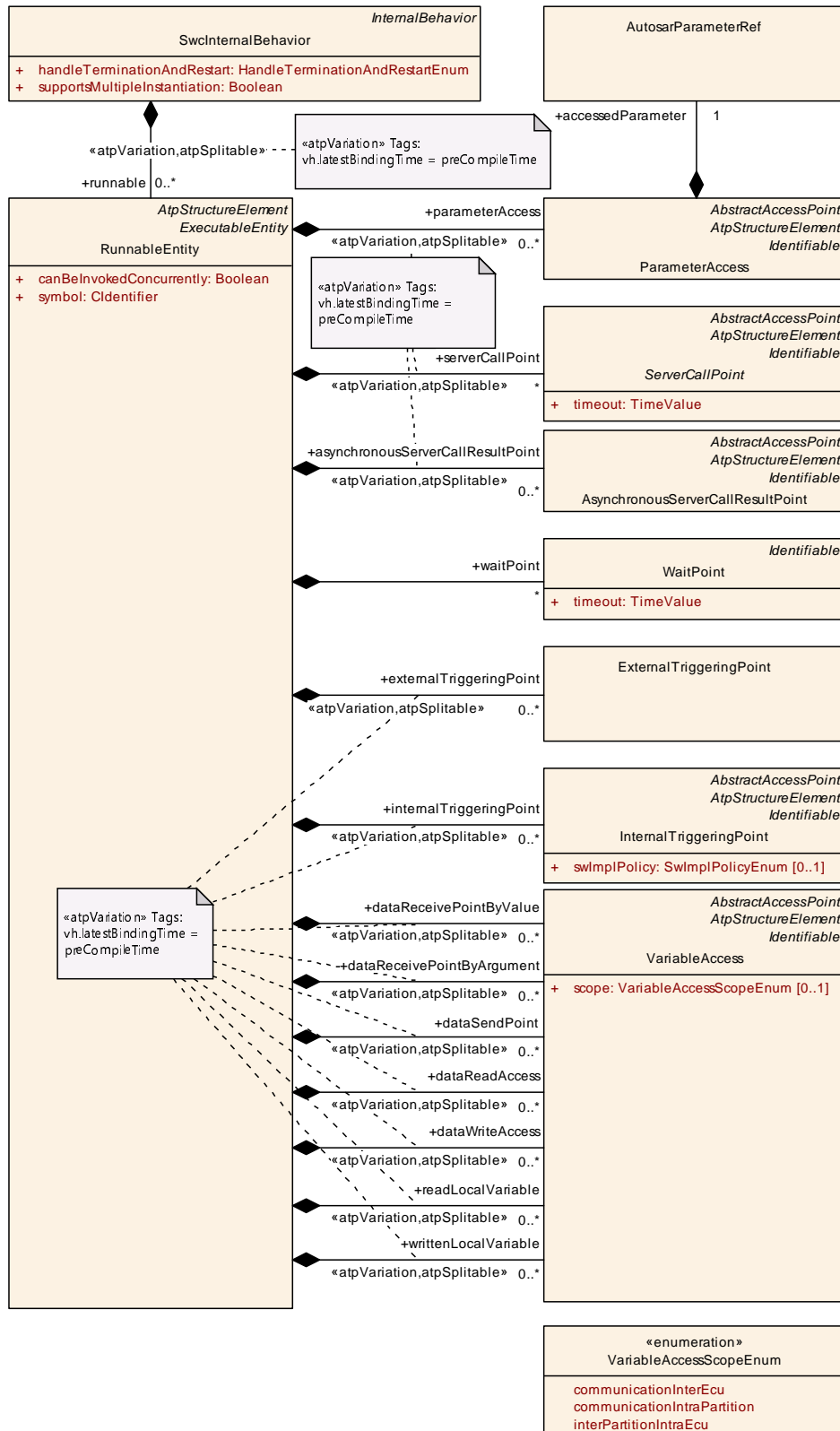

Figure 7.3: Details of RunnableEntity

[TPS_SWCT_01097] **CompositionSwComponentType** cannot have **RunnableEntities** [It is intentionally not possible for **CompositionSwComponentType** to define a **SwcInternalBehavior**. Consequently, **CompositionSwComponentTypes** don't have **RunnableEntities** by themselves.]([RS_SWCT_00070](#), [RS_SWCT_00090](#), [RS_SWCT_03050](#))

[TPS_SWCT_01098] Only **AtomicSwComponentType** can have **RunnableEntities** [Only the **AtomicSwComponentType** that are populating a **CompositionSwComponentType** as **SwComponentPrototypes** may have **RunnableEntities**.]([RS_SWCT_00070](#), [RS_SWCT_00090](#), [RS_SWCT_03050](#))

This correlation is depicted in Figure 7.4.

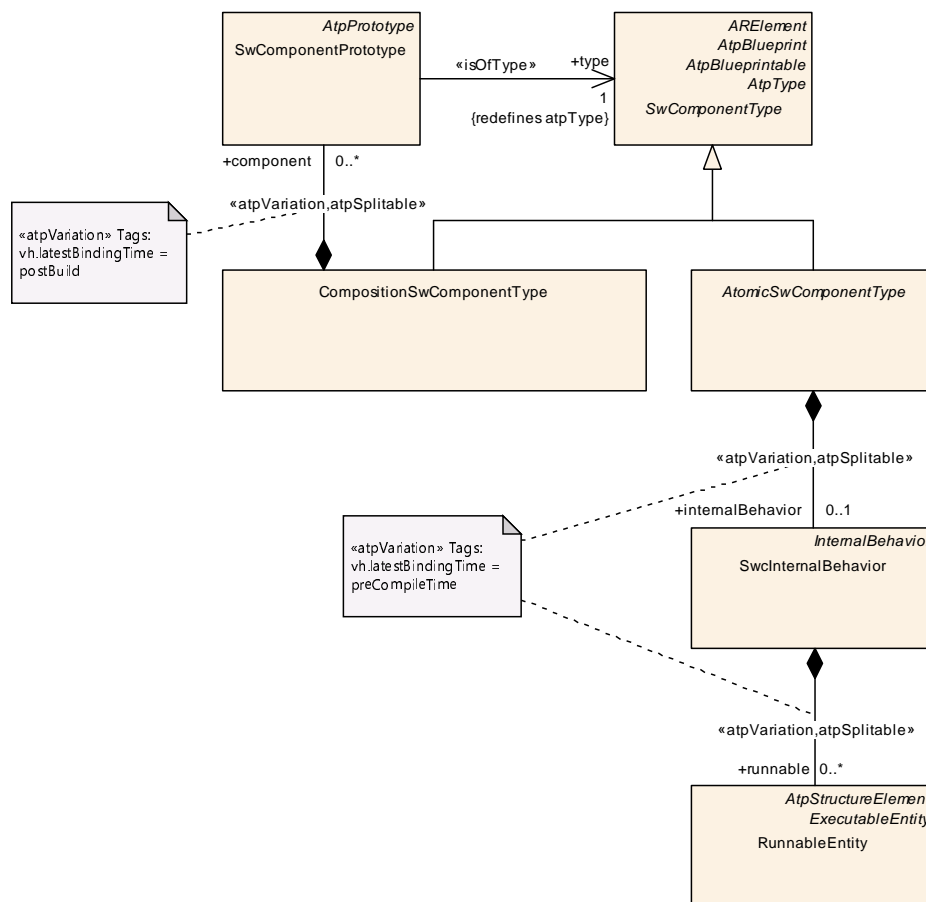

Figure 7.4: Only **AtomicSwComponentTypes** may have **RunnableEntities**

Please note that **RunnableEntities** exist in several categories that have different properties. Please find more explanation about categories of **RunnableEntities** in section 7.2.4.4.

Class	RunnableEntity			
Package	M2::AUTOSARTemplates::SWComponentTemplate::SwcInternalBehavior			
Note	A RunnableEntity represents the smallest code-fragment that is provided by an AtomicSwComponent Type and are executed under control of the RTE. RunnableEntities are for instance set up to respond to data reception or operation invocation on a server.			
Base	ARObject, AtpClassifier, AtpFeature, AtpStructureElement, ExecutableEntity , Identifiable , Multilanguage Referrable , Referrable			
Attribute	Type	Mult.	Kind	Note
argument (ordered)	RunnableEntity Argument	*	aggr	This represents the formal definition of a an argument to a RunnableEntity.
asynchronous ServerCall ResultPoint	AsynchronousServerCallResultPoint	*	aggr	The server call result point admits a runnable to fetch the result of an asynchronous server call. The aggregation of AsynchronousServerCallResultPoint is subject to variability with the purpose to support the conditional existence of client server PortPrototypes and the variant existence of server call result points in the implementation. Stereotypes: atpSplitable; atpVariation Tags: atp.Splitkey=shortName, variationPoint.shortLabel vh.latestBindingTime=preCompileTime
canBelvoked Concurrently	Boolean	1	attr	If the value of this attribute is set to "true" the enclosing RunnableEntity can be invoked concurrently (even for one instance of the corresponding AtomicSwComponent Type). This implies that it is the responsibility of the implementation of the RunnableEntity to take care of this form of concurrency. Note that the default value of this attribute is set to "false".
dataRead Access	VariableAccess	*	aggr	RunnableEntity has implicit read access to dataElement of a sender-receiver PortPrototype or nv data of a nv data PortPrototype. The aggregation of dataReadAccess is subject to variability with the purpose to support the conditional existence of sender receiver ports or the variant existence of dataReadAccess in the implementation. Stereotypes: atpSplitable; atpVariation Tags: atp.Splitkey=shortName, variationPoint.shortLabel vh.latestBindingTime=preCompileTime
dataReceive PointBy Argument	VariableAccess	*	aggr	RunnableEntity has explicit read access to dataElement of a sender-receiver PortPrototype or nv data of a nv data PortPrototype. The result is passed back to the application by means of an argument in the function signature. The aggregation of dataReceivePointByArgument is subject to variability with the purpose to support the conditional existence of sender receiver PortPrototype or the variant existence of data receive points in the implementation. Stereotypes: atpSplitable; atpVariation Tags: atp.Splitkey=shortName, variationPoint.shortLabel vh.latestBindingTime=preCompileTime





Class	RunnableEntity			
dataReceivePointByValue	VariableAccess	*	aggr	<p>RunnableEntity has explicit read access to dataElement of a sender-receiver PortPrototype or nv data of a nv data PortPrototype.</p> <p>The result is passed back to the application by means of the return value. The aggregation of dataReceivePointByValue is subject to variability with the purpose to support the conditional existence of sender receiver ports or the variant existence of data receive points in the implementation.</p> <p>Stereotypes: atpSplitable; atpVariation Tags: atp.Splitkey=shortName, variationPoint.shortLabel vh.latestBindingTime=preCompileTime</p>
dataSendPoint	VariableAccess	*	aggr	<p>RunnableEntity has explicit write access to dataElement of a sender-receiver PortPrototype or nv data of a nv data PortPrototype.</p> <p>The aggregation of dataSendPoint is subject to variability with the purpose to support the conditional existence of sender receiver PortPrototype or the variant existence of data send points in the implementation.</p> <p>Stereotypes: atpSplitable; atpVariation Tags: atp.Splitkey=shortName, variationPoint.shortLabel vh.latestBindingTime=preCompileTime</p>
dataWriteAccess	VariableAccess	*	aggr	<p>RunnableEntity has implicit write access to dataElement of a sender-receiver PortPrototype or nv data of a nv data PortPrototype.</p> <p>The aggregation of dataWriteAccess is subject to variability with the purpose to support the conditional existence of sender receiver ports or the variant existence of dataWriteAccess in the implementation.</p> <p>Stereotypes: atpSplitable; atpVariation Tags: atp.Splitkey=shortName, variationPoint.shortLabel vh.latestBindingTime=preCompileTime</p>
externalTriggeringPoint	ExternalTriggeringPoint	*	aggr	<p>The aggregation of ExternalTriggeringPoint is subject to variability with the purpose to support the conditional existence of trigger ports or the variant existence of external triggering points in the implementation.</p> <p>Stereotypes: atpSplitable; atpVariation Tags: atp.Splitkey=ident.shortName, variationPoint.shortLabel vh.latestBindingTime=preCompileTime</p>
internalTriggeringPoint	InternalTriggeringPoint	*	aggr	<p>The aggregation of InternalTriggeringPoint is subject to variability with the purpose to support the variant existence of internal triggering points in the implementation.</p> <p>Stereotypes: atpSplitable; atpVariation Tags: atp.Splitkey=shortName, variationPoint.shortLabel vh.latestBindingTime=preCompileTime</p>





Class	RunnableEntity			
modeAccess Point	ModeAccessPoint	*	aggr	<p>The runnable has a mode access point. The aggregation of ModeAccessPoint is subject to variability with the purpose to support the conditional existence of mode ports or the variant existence of mode access points in the implementation.</p> <p>Stereotypes: atpSplitable; atpVariation Tags: atp.Splitkey=ident.shortName, variationPoint.shortLabel vh.latestBindingTime=preCompileTime</p>
modeSwitch Point	ModeSwitchPoint	*	aggr	<p>The runnable has a mode switch point. The aggregation of ModeSwitchPoint is subject to variability with the purpose to support the conditional existence of mode ports or the variant existence of mode switch points in the implementation.</p> <p>Stereotypes: atpSplitable; atpVariation Tags: atp.Splitkey=shortName, variationPoint.shortLabel vh.latestBindingTime=preCompileTime</p>
parameter Access	ParameterAccess	*	aggr	<p>The presence of a ParameterAccess implies that a RunnableEntity needs read only access to a Parameter DataPrototype which may either be local or within a Port Prototype.</p> <p>The aggregation of ParameterAccess is subject to variability with the purpose to support the conditional existence of parameter ports and component local parameters as well as the variant existence of Parameter Access (points) in the implementation.</p> <p>Stereotypes: atpSplitable; atpVariation Tags: atp.Splitkey=shortName, variationPoint.shortLabel vh.latestBindingTime=preCompileTime</p>
readLocal Variable	VariableAccess	*	aggr	<p>The presence of a readLocalVariable implies that a RunnableEntity needs read access to a VariableData Prototype in the role of implicitInterRunnableVariable or explicitInterRunnableVariable.</p> <p>The aggregation of readLocalVariable is subject to variability with the purpose to support the conditional existence of implicitInterRunnableVariable and explicit InterRunnableVariable or the variant existence of read LocalVariable (points) in the implementation.</p> <p>Stereotypes: atpSplitable; atpVariation Tags: atp.Splitkey=shortName, variationPoint.shortLabel vh.latestBindingTime=preCompileTime</p>
serverCallPoint	ServerCallPoint	*	aggr	<p>The RunnableEntity has a ServerCallPoint. The aggregation of ServerCallPoint is subject to variability with the purpose to support the conditional existence of client server PortPrototypes or the variant existence of server call points in the implementation.</p> <p>Stereotypes: atpSplitable; atpVariation Tags: atp.Splitkey=shortName, variationPoint.shortLabel vh.latestBindingTime=preCompileTime</p>
symbol	CIdentifier	1	attr	<p>The symbol describing this RunnableEntity's entry point. This is considered the API of the RunnableEntity and is required during the RTE contract phase.</p>





Class	RunnableEntity			
waitPoint	WaitPoint	*	aggr	The WaitPoint associated with the RunnableEntity.
writtenLocalVariable	VariableAccess	*	aggr	<p>The presence of a writtenLocalVariable implies that a RunnableEntity needs write access to a VariableData Prototype in the role of implicitInterRunnableVariable or explicitInterRunnableVariable.</p> <p>The aggregation of writtenLocalVariable is subject to variability with the purpose to support the conditional existence of implicitInterRunnableVariable and explicitInterRunnableVariable or the variant existence of writtenLocalVariable (points) in the implementation.</p> <p>Stereotypes: atpSplittable; atpVariation Tags: atp.Splitkey=shortName, variationPoint.shortLabel vh.latestBindingTime=preCompileTime</p>

Table 7.4: RunnableEntity

[TPS_SWCT_01302] Semantics of [minimumStartInterval](#) [The attribute [ExecutableEntity.minimumStartInterval](#) defines the time interval that the RTE will guarantee to not go below between scheduling two consecutive executions of the corresponding [RunnableEntity](#).]()

[TPS_SWCT_01303] [symbol](#) attribute describes the [RunnableEntity](#)'s entry point [The [RunnableEntity.symbol](#) attribute is describing the [RunnableEntity](#)'s entry point.]()

The implication [RunnableEntity.symbol](#) on the uniqueness of symbols in the scope of one [EcuInstance](#) is described in [constr_2025] [10].

A [RunnableEntity](#) inherits several attributes from its base class [ExecutableEntity](#) due to the fact that these are also used in the Basic Software Module Description Template [6]. Here the following constraint applies:

[constr_4082] [RunnableEntity.reentrancyLevel](#) shall not be set. [The optional attribute [reentrancyLevel](#) shall not be set for a [RunnableEntity](#). This attribute would define more specific reentrancy features than the mandatory attribute [canBeInvokedConcurrently](#). These features are currently only supported for Basic Software.]()

Please note that the formal definition of the semantics of a [RunnableEntity](#) has strong relations to the specification of the AUTOSAR RTE [2]. The definition of the RTE semantics, however, is not in the scope of this document.

However, the formal definition requires some background discussion that can't be completely left out of this document. Otherwise, the meaning of specific model elements could not be understood properly.

Please note further that there are legitimate use cases for software-components without any [RunnableEntities](#), e.g. in following situations:

- An `NvBlockSwComponentType` does not require any `RunnableEntity` if there is no need to proxy any `PortPrototype` typed by either of the `ClientServerInterfaces` `NvMService` or `NvMAdmin`.
- A `ServiceSwComponentType` runs in a reduced configuration and does not have to offer any `PortPrototype` to any service-using application software-component.
- A software-component is configured in a reduced configuration where none of the functionality is selected. In this case, it's simpler to keep the empty software-component instead of adding further `VariationPoints` at many other elements, e.g. `SwComponentPrototype`.

On top of that, a variation-based approach would require the conditional existence of other `ARElements` which are not yet supported, e.g. a `SwcImplementation` that references the `AtomicSwComponentType`.

7.2.1 Concurrency and Reentrancy of a `RunnableEntity` that cannot be Invoked Concurrently

This section applies to the case that the value of the attribute `canBeInvokedConcurrently` is `false`. During runtime, each `RunnableEntity` of each instance of an `AtomicSwComponentType` is in a specific run-time state.

The details of the definition and semantics of run-time states can be found in [2]. Nevertheless, this chapter contains a brief description of the fundamental concepts in order to properly being able to discuss the formal modeling of `RunnableEntities`.

[TPS_SWCT_01313] Conditions for a transition from `suspended` to `to be started` [The `SwcInternalBehavior` describes for each `RunnableEntity` the conditions for a transition from `suspended` to `to be started` should occur. This is done using the concept of an `RTEEvent`.]()

When a `RunnableEntity` is in state `to be started`, the RTE can decide to start running the `RunnableEntity`. The delay between entering the state `to be started` (e.g. a message has been received in response to which the `RunnableEntity` should run) and moving into the state `running` (the first instruction of the `RunnableEntity` has been executed) depends on the scheduling strategy of the RTE, i.e. the mapping of `RunnableEntities` on AUTOSAR OS tasks.

The transition from the state `running` into the state `suspended` is in the hands of the `RunnableEntity`: the transition occurs when the `RunnableEntity` returns (thereby handing over control to the AUTOSAR OS [29]). Some `RunnableEntities` (like cat. 2 `RunnableEntities`) might never return to the `suspended` state once they entered the `running` state.

They might enter the `preempted` state when being preempted. The same applies if a `RunnableEntity` needs to wait for a `WaitPoint` to be unblocked.

[TPS_SWCT_01304] Cat. 1A and 1B RunnableEntitys will eventually terminate [Cat. 1A and 1B `RunnableEntitys` will eventually return after having executed a specific finite algorithm (the execution time of which might be provided).]()

[TPS_SWCT_01305] RunnableEntity as one that cannot be invoked concurrently [In case the `SwcInternalBehavior` defines a `RunnableEntity` as one that cannot be invoked concurrently it is the responsibility of the RTE to make sure that the `RunnableEntity` is never started concurrently (for example, in two different AUTOSAR OS tasks). This implies that the implementation of the `AtomicSwComponentType` does not need to worry about concurrency issues.]()

For example: The internal behavior of an `AtomicSwComponentType` *MyComponentType* describes a `RunnableEntity` *R1* which should be enabled when an `operation` on a client-server `PPortPrototype` of the `AtomicSwComponentType` is invoked. The `AtomicSwComponentType` specifies that the `RunnableEntity` *R1* cannot be invoked concurrently.

The `AtomicSwComponentType` *MyComponentType* is instantiated on an ECU. When a call of the operation is received, the corresponding instance of the `RunnableEntity` *R1* is enabled and the RTE will start executing the `RunnableEntity` (the `RunnableEntity` is in state `running`) in a task eventually managed by the AUTOSAR OS.

If another call of the `operation` is received while the `RunnableEntity` is in state `running`, it is not allowed that the RTE runs the `RunnableEntity` again in a second task. Rather, the RTE has to wait (and maybe queue the second incoming request) until the `RunnableEntity` has returned and has moved to the `suspended` state.

7.2.2 Concurrency and Reentrancy of a RunnableEntity that can be Invoked Concurrently

This section applies to the case that the value of the attribute `canBeInvokedConcurrently` is set to `true`.

In this case, it is allowed that the same `RunnableEntity` is running several times concurrently in different AUTOSAR OS tasks. This implies that the state machine defined in [2] is not the state of the `RunnableEntity` anymore, but can be cloned an arbitrary number of times.

[TPS_SWCT_01306] Software-component description itself does not put any bounds on the number of concurrent invocations of a RunnableEntity [The software-component description itself does not put any bounds on the number of concurrent invocations of the `RunnableEntity` that are allowed.

The software-component description only specifies whether the `RunnableEntity` can be invoked concurrently or not.

Allowing concurrent invocation of a `RunnableEntity` implies that the implementation of the `AtomicSwComponentType` needs to take care of this additional form of concurrency.]()

For example: The `SwcInternalBehavior` of a component-type `MyComponentType` describes a `RunnableEntity R1` which should be enabled when a `ClientServerOperation` on a `PPortPrototype` typed by a `ClientServerInterface` of the `AtomicSwComponentType` is invoked.

The `AtomicSwComponentType` specifies that the `RunnableEntity R1` can be invoked concurrently. The `AtomicSwComponentType MyComponentType` is instantiated on an ECU.

When a call of the `ClientServerOperation` is received the corresponding instance of the `RunnableEntity R1` is enabled and the RTE will start executing the `RunnableEntity` (the `RunnableEntity` is in state `running`) in a task eventually managed by the AUTOSAR OS.

If another call of the `ClientServerOperation` is received, it is allowed that the same `RunnableEntity` is started again in a different task.

A typical use-case of concurrent `RunnableEntity`s is the implementation of AUTOSAR services. The AUTOSAR services will typically take care of concurrency internally: several software-components can directly use the services in parallel.

The ECU-integrator could then decide that the `RunnableEntity` implementing the AUTOSAR service runs directly in the context (in the task) of the `AtomicSwComponentType` invoking the service.

This is a very efficient and direct coupling between the client and the server: the connector between the client and the server is reduced to a local function-call.

7.2.3 Timed Activation of Runnable Entities

In many cases, `RunnableEntity`s need to be activated in response to timing events rather than related to communication (e.g. the reception of a response to an asynchronous operation invocation). Many `RunnableEntity`s will need to run cyclically with a fixed rate.

The approach taken in the software-component description is to define so-called `TimingEvents` (please find more details in Figure 7.5) as special kinds of `RTEEvent`s. So far, only one kind of timing-related `RTEEvent` has been defined: a simple periodic `TimingEvent`.

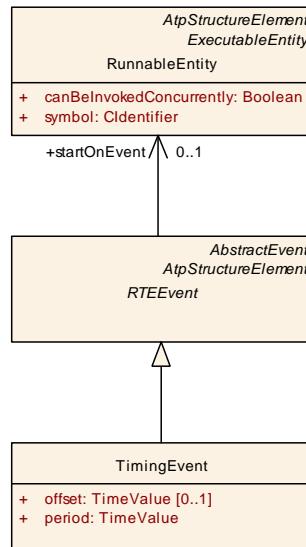

Figure 7.5: Periodic activation of RunnableEntities

[TPS_SWCT_01519] RTE executes certain RunnableEntity periodically [If the `SwcInternalBehavior` of an `AtomicSwComponentType` requires that the RTE executes certain `RunnableEntity`s periodically, the description needs to define a `TimingEvent` with the desired period.

This `TimingEvent` then contains a reference to the `RunnableEntity` that needs to be executed with this period.]()

[constr_2031] Period of TimingEvent shall be greater than 0 [The value of the attribute `period` of `TimingEvent` shall be greater than 0.]()

Note that it is possible to override the attribute `period` on the level of instantiation. See [TPS_SWCT_02507] for more details.

Class	TimingEvent			
Package	M2::AUTOSARTemplates::SWComponentTemplate::SwcInternalBehavior::RTEEvents			
Note	TimingEvent references the RunnableEntity that need to be started in response to the TimingEvent			
Base	ARObject, AbstractEvent, AtpClassifier, AtpFeature, AtpStructureElement, Identifiable, Multilanguage Referrable, RTEEvent, Referrable			
Attribute	Type	Mult.	Kind	Note
offset	TimeValue	0..1	attr	The value makes an assumption about the time offset of the first activation of the RunnableEntity triggered by the mapped TimingEvent relative to the periodic activation of the time base of this TimingEvent. Unit: second.
period	TimeValue	1	attr	Period of timing event in seconds. The value of this attribute shall be greater than zero.

Table 7.5: TimingEvent

[constr_1622] Value of TimingEvent.offset vs. TimingEvent.period [If a value is defined for attribute `TimingEvent.offset` then this value shall be greater than 0 and less or equal than the value of attribute `TimingEvent.period` of the respective `TimingEvent`.]()

The motivation for the existence of [constr_1622] is that the mapped `TimingEvent` could not be implemented with the given `period` if the activation `offset` is greater than the period of the `TimingEvent`.

7.2.4 Additional Remarks and Clarifications

7.2.4.1 Reentrancy and Multiple Instantiation

This chapter is emphasizing on the specific meanings of combinations of the attributes `SwcInternalBehavior.supportsMultipleInstantiation` and `RunnableEntity.canBeInvokedConcurrently`.

[TPS_SWCT_01307] **supportsMultipleInstantiation vs. canBeInvokedConcurrently** [The semantics of combining the attributes `supportsMultipleInstantiation` and `canBeInvokedConcurrently` is summarized in Table 7.6.]
()

<code>supportsMultipleInstantiation</code>	<code>canBeInvokedConcurrently</code>	Implication for an implementation of a <code>RunnableEntity</code>
false	false	This implies that the implementation of the <code>RunnableEntity</code> will never be invoked concurrently from several tasks. The implementation does not need to care about reentrancy issues and can typically use <code>static</code> variables to store state.
true	false	In case there are several instances of the same <code>AtomicSwComponentType</code> on the local ECU, the implementation of the <code>RunnableEntity</code> can still be invoked concurrently from several tasks. However, there will be no concurrent invocations of the implementation with the same <code>instance handle</code> . To ensure that this is safe, the implementation will typically use per-instance memory.
true	true	In this case the <code>RunnableEntity</code> can be invoked concurrently from several tasks, even with the same <code>instance handle</code> .

Table 7.6: supportsMultipleInstantiation vs. canBeInvokedConcurrently

In case the implementation of a `AtomicSwComponentType` decides to map several `RunnableEntity`s to the same `symbol` there are reentrancy problems to be sorted out. However, this scenario is not supported by RTE [2] anyway and shall therefore be avoided.

7.2.4.2 Reentrancy and “Library Functions”

Note that all code that is called by different `RunnableEntity`s (like e.g. library routines, etc.) shall obviously be reentrant. A filter algorithm implemented in C, for example, is not allowed to store values from previous runs by means of `static` variables or variables with external binding.

7.2.4.3 Compatibility of ClientServerOperations triggering the same RunnableEntity

[TPS_SWCT_01309] signature of a RunnableEntity depends on the connected RTEEvent [The signature of a RunnableEntity depends on the connected RTEEvent.

Multiple OperationInvokedEvents that trigger the same RunnableEntity are only supported if all referenced ClientServerOperations would result in the same RunnableEntity signature for the server RunnableEntity.]()

[constr_2000] Compatibility of ClientServerOperations triggering the same RunnableEntity [The ClientServerOperations are considered compatible if

- the number of arguments (which can be ArgumentDataPrototypes or related PortDefinedArgumentValues) is equal and
- the corresponding arguments (i.e. first argument on both sides, second argument on both sides, etc.) are compatible
- and the respective values of PortAPIOption.errorHandling are identical.

In particular, this means that:

- for combinations of ArgumentDataPrototypes and ArgumentDataPrototypes where the serverArgumentImplPolicy is set to useArgumentType the referred ImplementationDataTypes shall be compatible.

In case of data types of category STRUCTURE all by order matching ImplementationDataTypeElements shall be named equally.

- for combinations of PortDefinedArgumentValues and ArgumentDataPrototypes where the serverArgumentImplPolicy is set to useArgumentType the referred ImplementationDataTypes shall be compatible.

In case of ImplementationDataTypeElements of category STRUCTURE all by order matching ImplementationDataTypeElements of the structure shall be named equally.

- for ArgumentDataPrototypes where the serverArgumentImplPolicy is set to useVoid an arbitrary ImplementationDataType is referred to.

In addition, it is required that the return value defined on both sides shall match (in terms of Std_ReturnType vs. void) and also the possibleErrors are compatible.]()

[TPS_SWCT_01520] Implication of the existence of possibleError on compatibility of ClientServerOperations [An implication of [constr_2000] is that a ClientServerOperation that defines any possibleError is not compatible with a ClientServerOperation that defines no possibleError at all because this configuration leads to different data type of the return value of the C function that implements the applicable RunnableEntity.]()

7.2.4.4 Categories of Runnable Entities

[TPS_SWCT_01310] **Categories of RunnableEntity** [RunnableEntity are subdivided into the following categories:

Category 1 RunnableEntity of Category 1 do not have WaitPoints and are required to terminate in a finite amount of time. Category 1 is divided into two subcategories: Category 1A and Category 1B.

Category 1A RunnableEntity are only allowed to use implicit APIs.

Category 1B RunnableEntity are additionally allowed to invoke a server, to use explicit APIs, to issue triggers, to switch modes and to use ExclusiveAreas.

Category 2 In contrast to Category 1, RunnableEntity, RunnableEntity of Category 2 always aggregate at least one WaitPoint¹. Typically, such a RunnableEntity implements an internal loop where one iteration through the loop is triggered whenever a WaitPoint is resolved.

]()

For more details regarding details of the modeling of meta-class RunnableEntity, please refer to Figure 7.3.

The resource need of a RunnableEntity in its later integration usually depends on the used features of the Runtime Environment.

In the AUTOSAR Methodology, the ECU integrator is required to map various RunnableEntity to a limited amount of OS Tasks in a specific order.

The RunnableEntity categories are useful to indicate the later integration effort and resource need on the basis of the RunnableEntity's design.

Thereby Category 1A RunnableEntity do not utilize RTE features which are blocking or delaying the execution of the RunnableEntity. As long as the RunnableEntity implementation guaranties stable execution times it's rather simple and reliable to integrate them in a calculation chain.

As opposed to Category 1A, the scheduling behavior of Category 2 RunnableEntity at runtime depends on the interaction with the interfaces of the enclosing software component.

For instance, the suspend-times of the OS Task, where the RunnableEntity is mapped to, may depend on actual data reception and/or occurrence of timeouts.

Moreover, it's usually not possible to map more than one RunnableEntity to an OS Task when the RunnableEntity implements an infinite internal loop, triggered whenever a WaitPoint is resolved.

¹Category 2 RunnableEntity usually have to be mapped to *Extended Tasks*, because only extended tasks provide the task state WAITING.

In case of Category 1B, additional side conditions impact the schedule behavior and required OS features. For instance, a server call might be simply implemented as direct function call in case of intra partition communication **or** might require a more complex implementation in case of inter-ECU communication.

7.2.4.5 Arguments of a Runnable Entity

In many cases an RTE generator will be able to figure out not only the number and data type of arguments to a `RunnableEntity` but also the name of the arguments. In some cases, however, formal support from the upstream templates is required to facilitate this task.

[TPS_SWCT_01311] Name of an operation argument [This support is available by means of the meta-class `RunnableEntityArgument` that contributes the name of the argument by means of the value of the attribute `symbol`.

As a `RunnableEntity` might need to define many arguments the aggregation of `RunnableEntityArgument` at `RunnableEntity` in the role `argument` has the multiplicity `0..*` and as the order of these arguments is significant the meta-model defines the aggregation as `ordered2`.]()

[constr_1164] Number of arguments owned by a RunnableEntity [If a given `RunnableEntity` owns `RunnableEntityArguments` in the role `argument`, then the number of these `RunnableEntityArguments` shall be identical to the number of applicable `portArgValues` of the `PortAPIOption` that references the `PortPrototype` that in turn is referenced by the `OperationInvokedEvent` that references the `RunnableEntity` **plus** the number of `ArgumentDataPrototypes` aggregated in the role `argument` by the `ClientServerOperation` referenced by said `OperationInvokedEvent`.]()

[constr_1165] Applicability of RunnableEntityArgument [The existence of a `RunnableEntityArgument` is limited to `RunnableEntity`s triggered by a `ClientServerOperation`.]()

[TPS_SWCT_01312] RunnableEntity has a mapping to BswModuleEntry [The existence of `RunnableEntityArguments` in the role `argument` owned by a `RunnableEntity` shall be **ignored** by an RTE generator if a mapping to a `BswModuleEntry` exists.

In this case the name of arguments to the `RunnableEntity` shall be derived from the applicable `SwServiceArgs` owned by the mapped `BswModuleEntry`.]()

²as the arguments are **ordered** they do not need to be `Referrable` in order to be able to identify individual `arguments`

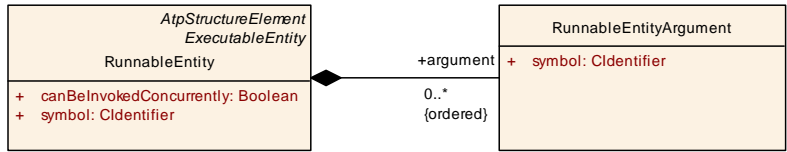

Figure 7.6: Arguments of a RunnableEntity

Class	RunnableEntityArgument			
Package	M2::AUTOSARTemplates::SWComponentTemplate::SwcInternalBehavior::RunnableEntity			
Note	This meta-class represents the ability to provide specific information regarding the arguments to a RunnableEntity.			
Base	ARObject			
Attribute	Type	Mult.	Kind	Note
symbol	CIdentifier	1	attr	This represents the symbol to be generated into the actual signature on the level of the C programming language.

Table 7.7: RunnableEntityArgument

7.2.5 Activation Reason of a Runnable Entity

It is feasible to activate a given [RunnableEntity](#) by means of several [RTEEvents](#). In many cases, it is therefore necessary to retrieve the information about the activating [RTEEvent](#) from within the implementation of the [RunnableEntity](#).

As a typical use case, consider a [RunnableEntity](#) that is cyclically activated (by means of a [TimingEvent](#)) and in addition it shall also be executed sporadically, e.g. in response to the reception ([DataReceivedEvent](#)) of a [dataElement](#).

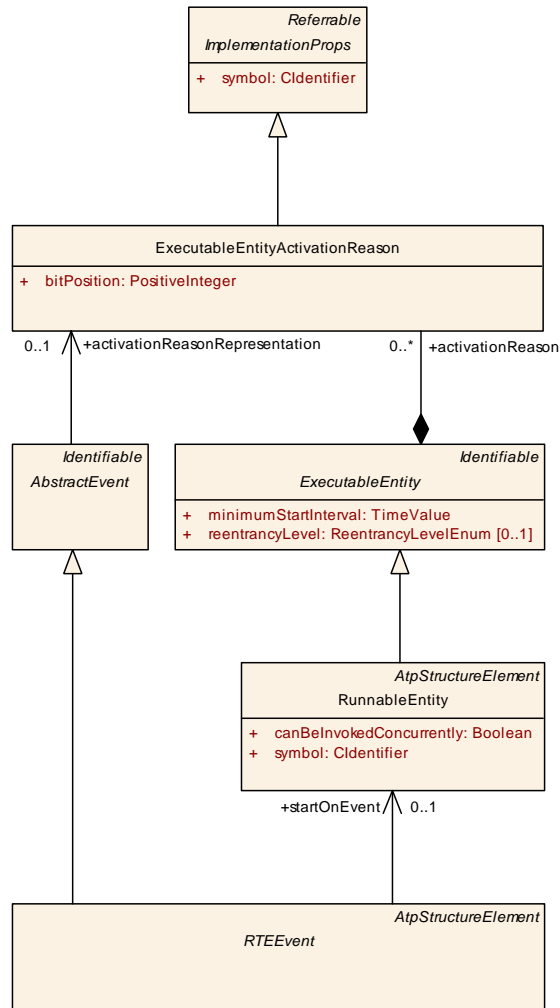

Figure 7.7: ExecutableEntityActivationReason and RunnableEntity

[TPS_SWCT_01469] RTE API for retrieving the current activation reason [The aggregation of a ExecutableEntityActivationReason allows for the RTE generator to create an RTE API for retrieving the current activation reason.] (RS_SWCT_03045)

For details about the implementation of this feature, please refer to the specification of the RTE [2]

[constr_1226] Applicable range for ExecutableEntityActivationReason.bitPosition [The value of attribute ExecutableEntityActivationReason.bitPosition shall be in the range of 0 .. 31.]()

[constr_1227] Value of attribute ExecutableEntityActivationReason.bitPosition shall be unique [The value of attributes ExecutableEntityActivationReason.bitPosition and ExecutableEntityActivationReason.symbol shall be unique in the context of the enclosing RunnableEntity.]()

[constr_1228] RTEEvent that is referenced by a WaitPoint in the role trigger shall not reference ExecutableEntityActivationReason [An RTEEvent that is

referenced by a `WaitPoint` in the role `trigger` shall not reference `ExecutableEntityActivationReason` in the role `activationReasonRepresentation`.|()

The rationale for the existence of [constr_1228] is obviously that in the described situation the `RunnableEntity` is already activated and therefore the mentioned `RTEEvent` does not deliver any information related to the activation reason of said `RunnableEntity`.

Class	ExecutableEntity (abstract)			
Package	M2::AUTOSARTemplates::CommonStructure::InternalBehavior			
Note	Abstraction of executable code.			
Base	<i>ARObject</i> , <i>Identifiable</i> , <i>MultilanguageReferrable</i> , <i>Referrable</i>			
Subclasses	<i>BswModuleEntity</i> , <i>RunnableEntity</i>			
Attribute	Type	Mult.	Kind	Note
activationReason	ExecutableEntityActivationReason	*	aggr	If the ExecutableEntity provides at least one activationReason element the RTE resp. BSW Scheduler shall provide means to read the activation vector of this executable entity execution. If no activationReason element is provided the feature of being able to determine the activating RTEEvent is disabled for this ExecutableEntity.
canEnterExclusiveArea	ExclusiveArea	*	ref	This means that the executable entity can enter/leave the referenced exclusive area through explicit API calls.
exclusiveAreaNestingOrder	ExclusiveAreaNestingOrder	*	ref	This represents the set of ExclusiveAreaNestingOrders recognized by this ExecutableEntity.
minimumStartInterval	TimeValue	1	attr	Specifies the time in seconds by which two consecutive starts of an ExecutableEntity are guaranteed to be separated.
reentrancyLevel	ReentrancyLevelEnum	0..1	attr	The reentrancy level of this ExecutableEntity. See the documentation of the enumeration type ReentrancyLevelEnum for details. Please note that nonReentrant interfaces can have also reentrant or multicoreReentrant implementations, and reentrant interfaces can also have multicoreReentrant implementations.
runsInsideExclusiveArea	ExclusiveArea	*	ref	The executable entity runs completely inside the referenced exclusive area.
swAddrMethod	SwAddrMethod	0..1	ref	Addressing method related to this code entity. Via an association to the same SwAddrMethod, it can be specified that several code entities (even of different modules or components) shall be located in the same memory without already specifying the memory section itself.

Table 7.8: ExecutableEntity

Class	ExecutableEntityActivationReason
Package	M2::AUTOSARTemplates::CommonStructure::InternalBehavior
Note	This meta-class represents the ability to define the reason for the activation of the enclosing Executable Entity.
Base	<i>ARObject</i> , <i>ImplementationProps</i> , <i>Referrable</i>





Class		ExecutableEntityActivationReason		
Attribute	Type	Mult.	Kind	Note
bitPosition	PositiveInteger	1	attr	This attribute allows for defining the position of the enclosing ExecutableEntityActivationReason in the activation vector.

Table 7.9: ExecutableEntityActivationReason

Please note that the attribute `ExecutableEntityActivationReason.symbol` is needed for the generation of a unique identifier that represents the specific activation reason in the RTE code.

7.2.6 Runnable Entity for Initialization Purpose

One way to make sure that certain initializations are applied before a software-component enters its state of normal operation is to use the AUTOSAR mode-management, in particular by defining a `ModeDeclarationGroup` that contains a specific `ModeDeclaration` with the semantics of representing a mode that is exclusively used for setting up and initializing a software-component.

However, this approach comes with a certain amount of footprint that may be acceptable in some cases but there may also be cases where a simpler approach comes in handy. The simple approach to initialization consists of a `RunnableEntity` that is triggered by a special kind of `RTEEvent`, i.e. the so-called `InitEvent`.

[TPS_SWCT_01525] `InitEvent` references a `RunnableEntity` in the role `startOnEvent` [In addition to using a mode-based approach for executing initialization `RunnableEntities` it is also possible to let an `InitEvent` reference a `RunnableEntity` in the role `startOnEvent`.

This approach to the initialization of software-components is orthogonal to the mode-based approach. Especially, the `RunnableEntities` triggered by an `InitEvent` are expected to be executed after the RTE has been fully initialized. This means restrictions regarding the availability of RTE APIs during the ECU initialization are not relevant for `RunnableEntities` triggered by an `InitEvent`.] (*RS_SWCT_03290*)

[constr_1257] No `WaitPoints` allowed [A `RunnableEntity` referenced by an `InitEvent` in the role `startOnEvent` shall not aggregate a `WaitPoint`.] ()

Rationale: a `WaitPoint` may indefinitely defer the completion of the `RunnableEntities` triggered by an `InitEvent` and therefore contradict the semantics of the `RunnableEntity`.

[constr_1258] Value of `minimumStartInterval` for `RunnableEntities` triggered by an `InitEvent` [The value of the attribute `ExecutableEntity.minimumStartInterval` for a `RunnableEntities` that is triggered by an `InitEvent` shall always be set to 0.] ()

Rationale: it does not make sense to talk about intervals of activating `RunnableEntities` triggered by an `InitEvent` as these are not supposed to be executed repeatedly.

[constr_1259] Aggregation of `AsynchronousServerCallPoint` and `AsynchronousServerCallResultPoint` [A `RunnableEntity` referenced by an `InitEvent` in the role `startOnEvent` may aggregate an `AsynchronousServerCallPoint` but it shall not aggregate an `AsynchronousServerCallResultPoint`.]()

Rationale: as mentioned before `WaitPoints` shall not be aggregated by a `RunnableEntity` triggered by an `InitEvent` in the role `startOnEvent`. It is allowed (although considered unlikely to happen) to have an `AsynchronousServerCallPoint` but it is not allowed to fetch the result of the call within the same `RunnableEntity`.

A `RunnableEntity` triggered by an `InitEvent` in the role `startOnEvent` may aggregate a `SynchronousServerCallPoint` but the usage of this configuration is discouraged.

[constr_1260] No mode disabling for `InitEvents` [An `InitEvent` shall not have a reference to a `ModeDeclaration` in the role `disabledMode`.]()

Rationale: the concept of `RunnableEntity` triggered by an `InitEvent` is (as mentioned before) orthogonal to the mode concept and therefore shall be implemented independent of modes.

7.3 RTEEvent

During execution, several `RTEEvents` will occur, such as the reception of a remote invocation of a `ClientServerOperation` on a `PPortPrototype` or a timeout on an `RPortPrototype` that is not receiving the `VariableDataPrototypes` it expects to receive.

[TPS_SWCT_01314] `RTEEvent` [The description of an `RTEEvent` includes two aspects:

1. defining an `RTEEvent`
2. defining how the RTE should deal with the `RTEEvent` when it occurs.

]()

Class	AbstractEvent (abstract)			
Package	M2::AUTOSARTemplates::CommonStructure::InternalBehavior			
Note	This meta-class represents the abstract ability to model an event that can be taken to implement application software or basic software in AUTOSAR.			
Base	ARObject, Identifiable , MultilanguageReferrable , Referrable			
Subclasses	BswEvent , RTEEvent			
Attribute	Type	Mult.	Kind	Note
activationReasonRepresentation	ExecutableEntityActivationReason	0..1	ref	If the activationReasonRepresentation is referenced from the enclosing AbstractEvent this shall be taken as an indication that the latter contributes to the activating vector of this ExecutableEntity that owns the referenced ExecutableEntityActivationReason.

Table 7.10: AbstractEvent

Class	RTEEvent (abstract)			
Package	M2::AUTOSARTemplates::SWComponentTemplate::SwcInternalBehavior::RTEEvents			
Note	Abstract base class for all RTE-related events			
Base	ARObject, AbstractEvent , AtpClassifier , AtpFeature , AtpStructureElement , Identifiable , MultilanguageReferrable , Referrable			
Subclasses	AsynchronousServerCallReturnsEvent , BackgroundEvent , DataReceiveErrorEvent , DataReceivedEvent , DataSendCompletedEvent , DataWriteCompletedEvent , ExternalTriggerOccurredEvent , InitEvent , InternalTriggerOccurredEvent , ModeSwitchedAckEvent , OperationInvokedEvent , SwcModeManagerErrorEvent , SwcModeSwitchEvent , TimingEvent , TransformerHardErrorEvent			
Attribute	Type	Mult.	Kind	Note
disabledMode	ModeDeclaration	*	iref	Reference to the Modes that disable the Event. Stereotypes: atpSplitable Tags: atp.Splitkey=contextPort, contextModeDeclarationGroupPrototype, targetModeDeclaration
startOnEvent	RunnableEntity	0..1	ref	RunnableEntity starts when the corresponding RTEEvent occurs.

Table 7.11: RTEEvent

Class	AsynchronousServerCallReturnsEvent			
Package	M2::AUTOSARTemplates::SWComponentTemplate::SwcInternalBehavior::RTEEvents			
Note	This event is raised when an asynchronous server call is finished.			
Base	ARObject, AbstractEvent , AtpClassifier , AtpFeature , AtpStructureElement , Identifiable , MultilanguageReferrable , RTEEvent , Referrable			
Attribute	Type	Mult.	Kind	Note
eventSource	AsynchronousServerCallResultPoint	1	ref	The referenced AsynchronousServerCallResultPoint which is raises the RTEEvent in case of returning asynchronous server call.

Table 7.12: AsynchronousServerCallReturnsEvent

Class	DataSendCompletedEvent			
Package	M2::AUTOSARTemplates::SWComponentTemplate::SwcInternalBehavior::RTEEvents			
Note	The event is raised when the referenced data elements have been sent or an error occurs.			
Base	<i>ARObject</i> , AbstractEvent , <i>AtpClassifier</i> , <i>AtpFeature</i> , <i>AtpStructureElement</i> , Identifiable , Multilanguage , Referrable , <i>RTEEvent</i> , Referrable			
Attribute	Type	Mult.	Kind	Note
eventSource	VariableAccess	1	ref	The variable access that triggers the event.

Table 7.13: DataSendCompletedEvent

Class	DataWriteCompletedEvent			
Package	M2::AUTOSARTemplates::SWComponentTemplate::SwcInternalBehavior::RTEEvents			
Note	This event is raised if an implicit write access was successful or an error occurred.			
Base	<i>ARObject</i> , AbstractEvent , <i>AtpClassifier</i> , <i>AtpFeature</i> , <i>AtpStructureElement</i> , Identifiable , Multilanguage , Referrable , <i>RTEEvent</i> , Referrable			
Attribute	Type	Mult.	Kind	Note
eventSource	VariableAccess	1	ref	The variable access that triggers the event.

Table 7.14: DataWriteCompletedEvent

Class	DataReceivedEvent			
Package	M2::AUTOSARTemplates::SWComponentTemplate::SwcInternalBehavior::RTEEvents			
Note	The event is raised when the referenced data elements are received.			
Base	<i>ARObject</i> , AbstractEvent , <i>AtpClassifier</i> , <i>AtpFeature</i> , <i>AtpStructureElement</i> , Identifiable , Multilanguage , Referrable , <i>RTEEvent</i> , Referrable			
Attribute	Type	Mult.	Kind	Note
data	VariableDataPrototype	0..1	iref	Data element referenced by event

Table 7.15: DataReceivedEvent

Class	DataReceiveErrorEvent			
Package	M2::AUTOSARTemplates::SWComponentTemplate::SwcInternalBehavior::RTEEvents			
Note	This event is raised by the RTE when the Com layer detects and notifies an error concerning the reception of the referenced data element.			
Base	<i>ARObject</i> , AbstractEvent , <i>AtpClassifier</i> , <i>AtpFeature</i> , <i>AtpStructureElement</i> , Identifiable , Multilanguage , Referrable , <i>RTEEvent</i> , Referrable			
Attribute	Type	Mult.	Kind	Note
data	VariableDataPrototype	0..1	iref	Data element referenced by event

Table 7.16: DataReceiveErrorEvent

Class	OperationInvokedEvent			
Package	M2::AUTOSARTemplates::SWComponentTemplate::SwcInternalBehavior::RTEEvents			
Note	The OperationInvokedEvent references the ClientServerOperation invoked by the client.			





Class	OperationInvokedEvent			
Base	ARObject , AbstractEvent , AtpClassifier , AtpFeature , AtpStructureElement , Identifiable , Multilanguage , Referrable , RTEEvent , Referrable			
Attribute	Type	Mult.	Kind	Note
operation	ClientServerOperation	0..1	iref	The operation to be executed as the consequence of the event.

Table 7.17: OperationInvokedEvent

[constr_1523] No mode disabling for [OperationInvokedEvents](#) [An [OperationInvokedEvent](#) shall not have a reference to a [ModeDeclaration](#) in the role [disabledMode](#).]()

Rationale for the existence of [\[constr_1523\]](#):

The RTE does not support the disabling of server [RunnableEntities](#) by modes. Instead, the server shall respond with an explicit error code if the execution of the server operation is not possible in specific side conditions.

For more explanation about the semantics of meta-class [TimingEvent](#), please refer to section [7.2.3](#).

Class	BackgroundEvent			
Package	M2::AUTOSARTemplates::SWComponentTemplate::SwcInternalBehavior::RTEEvents			
Note	This event is used to trigger RunnableEntities that are supposed to be executed in the background.			
Base	ARObject , AbstractEvent , AtpClassifier , AtpFeature , AtpStructureElement , Identifiable , Multilanguage , Referrable , RTEEvent , Referrable			
Attribute	Type	Mult.	Kind	Note
–	–	–	–	–

Table 7.18: BackgroundEvent

Class	SwcModeSwitchEvent			
Package	M2::AUTOSARTemplates::SWComponentTemplate::SwcInternalBehavior::RTEEvents			
Note	This event is raised upon a received mode change.			
Base	ARObject , AbstractEvent , AtpClassifier , AtpFeature , AtpStructureElement , Identifiable , Multilanguage , Referrable , RTEEvent , Referrable			
Attribute	Type	Mult.	Kind	Note
activation	ModeActivationKind	1	attr	Specifies if the event is activated on entering or exiting the referenced Mode.
mode (ordered)	ModeDeclaration	1..2	iref	Reference to one or two Modes that initiate the SwcModeSwitchEvent .

Table 7.19: SwcModeSwitchEvent

Enumeration	ModeActivationKind
Package	M2::AUTOSARTemplates::CommonStructure::ModeDeclaration
Note	Kind of mode switch condition used for activation of an event, as further described for each enumeration field.
Literal	Description
onEntry	On entering the referred mode. Tags: atp.EnumerationLiteralIndex=0
onExit	On exiting the referred mode. Tags: atp.EnumerationLiteralIndex=1
onTransition	On transition of the 1st referred mode to the 2nd referred mode. Tags: atp.EnumerationLiteralIndex=2

Table 7.20: ModeActivationKind

Class	ModeSwitchedAckEvent			
Package	M2::AUTOSARTemplates::SWComponentTemplate::SwcInternalBehavior::RTEEvents			
Note	The event is raised when the referenced modes have been received or an error occurs.			
Base	ARObject, AbstractEvent , AtpClassifier , AtpFeature , AtpStructureElement , Identifiable , Multilanguage Referrable , RTEEvent , Referrable			
Attribute	Type	Mult.	Kind	Note
eventSource	ModeSwitchPoint	1	ref	Mode switch point that triggers the event.

Table 7.21: ModeSwitchedAckEvent

Class	ExternalTriggerOccurredEvent			
Package	M2::AUTOSARTemplates::SWComponentTemplate::SwcInternalBehavior::RTEEvents			
Note	The event is raised when the referenced trigger have been occurred.			
Base	ARObject, AbstractEvent , AtpClassifier , AtpFeature , AtpStructureElement , Identifiable , Multilanguage Referrable , RTEEvent , Referrable			
Attribute	Type	Mult.	Kind	Note
trigger	Trigger	0..1	iref	Reference to the applicable Trigger.

Table 7.22: ExternalTriggerOccurredEvent

Class	InternalTriggerOccurredEvent			
Package	M2::AUTOSARTemplates::SWComponentTemplate::SwcInternalBehavior::RTEEvents			
Note	The event is raised when the referenced internal trigger have been occurred.			
Base	ARObject, AbstractEvent , AtpClassifier , AtpFeature , AtpStructureElement , Identifiable , Multilanguage Referrable , RTEEvent , Referrable			
Attribute	Type	Mult.	Kind	Note
eventSource	InternalTriggeringPoint	1	ref	Internal Triggering Point that triggers the event.

Table 7.23: InternalTriggerOccurredEvent

Class	InitEvent			
Package	M2::AUTOSARTemplates::SWComponentTemplate::SwcInternalBehavior::RTEEvents			
Note	This RTEEvent is supposed to be used for initialization purposes, i.e. for starting and restarting a partition. It is not guaranteed that all RunnableEntities referenced by this InitEvent are executed before the 'regular' RunnableEntities are executed for the first time. The execution order depends on the task mapping.			
Base	ARObject, AbstractEvent , AtpClassifier , AtpFeature , AtpStructureElement , Identifiable , Multilanguage Referrable , RTEEvent , Referrable			
Attribute	Type	Mult.	Kind	Note
-	-	-	-	-

Table 7.24: InitEvent

Class	TransformerHardErrorEvent			
Package	M2::AUTOSARTemplates::SWComponentTemplate::SwcInternalBehavior::RTEEvents			
Note	The event is raised when data are received which should trigger a Client/Server operation or an external trigger but during transformation of the data a hard transformer error occurred.			
Base	ARObject, AbstractEvent , AtpClassifier , AtpFeature , AtpStructureElement , Identifiable , Multilanguage Referrable , RTEEvent , Referrable			
Attribute	Type	Mult.	Kind	Note
operation	ClientServerOperation	0..1	iref	This represents the ClientServerOperation to which the TransformerHardErrorEvent refers to.
trigger	Trigger	0..1	iref	Trigger for which the transformer can trigger this TransformerHardErrorEvent

Table 7.25: TransformerHardErrorEvent

[constr_1397] Existence of attributes of [TransformerHardErrorEvent](#) [For any given [TransformerHardErrorEvent](#), either the attribute [TransformerHardErrorEvent.operation](#) or [TransformerHardErrorEvent.trigger](#) shall exist.]()

In other words, the attributes [operation](#) and [trigger](#) of meta-class [TransformerHardErrorEvent](#) shall be used mutually exclusive.

[TPS_SWCT_01315] Interaction of [RunnableEntity](#) with [RTEEvent](#) [As described in the Virtual Functional Bus specification [3], the [RunnableEntities](#) of an [AtomicSwComponentType](#) can interact with the occurrence of such [RTEEvents](#) in two ways:

- the RTE can be instructed to enable a specific [RunnableEntity](#) when the [RTEEvent](#) occurs
- the RTE can provide [WaitPoints](#), that allow a [RunnableEntity](#) to block until an [RTEEvent](#) in a set of [RTEEvents](#) occurs.

]()

7.3.1 Defining an Event

The description of the `SwcInternalBehavior` includes a description of all `RTEEvents` that the `SwcInternalBehavior` of the `AtomicSwComponentType` relies on.

[TPS_SWCT_01316] **Abstract base class `RTEEvent`** [The meta-class `RTEEvent` shows up as an “abstract” base-class in the meta-model: the exact attributes of the `RTEEvent` depend on the specific sub-class of `RTEEvent` that is used for the purpose.] ()

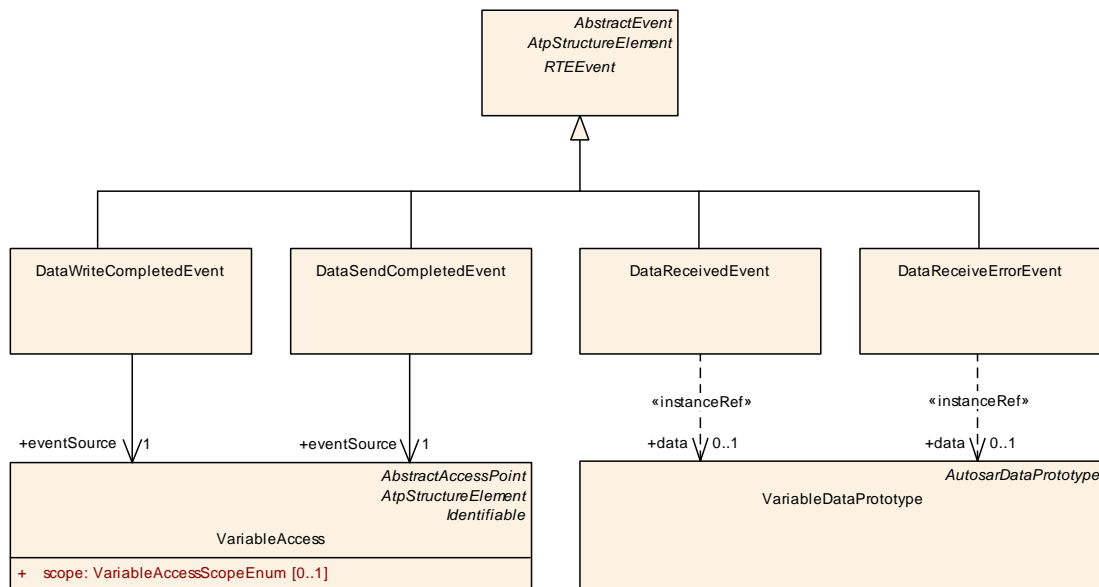

Figure 7.8: `RTEEvents` used in the context of sender/receiver communication

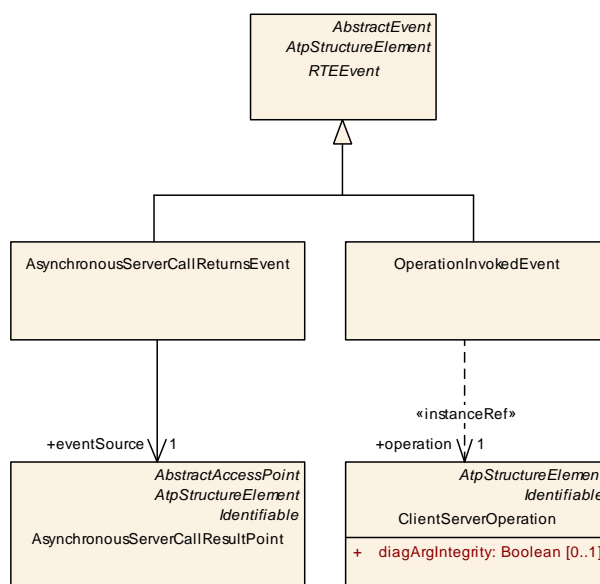

Figure 7.9: `RTEEvents` used in the context of client/server communication

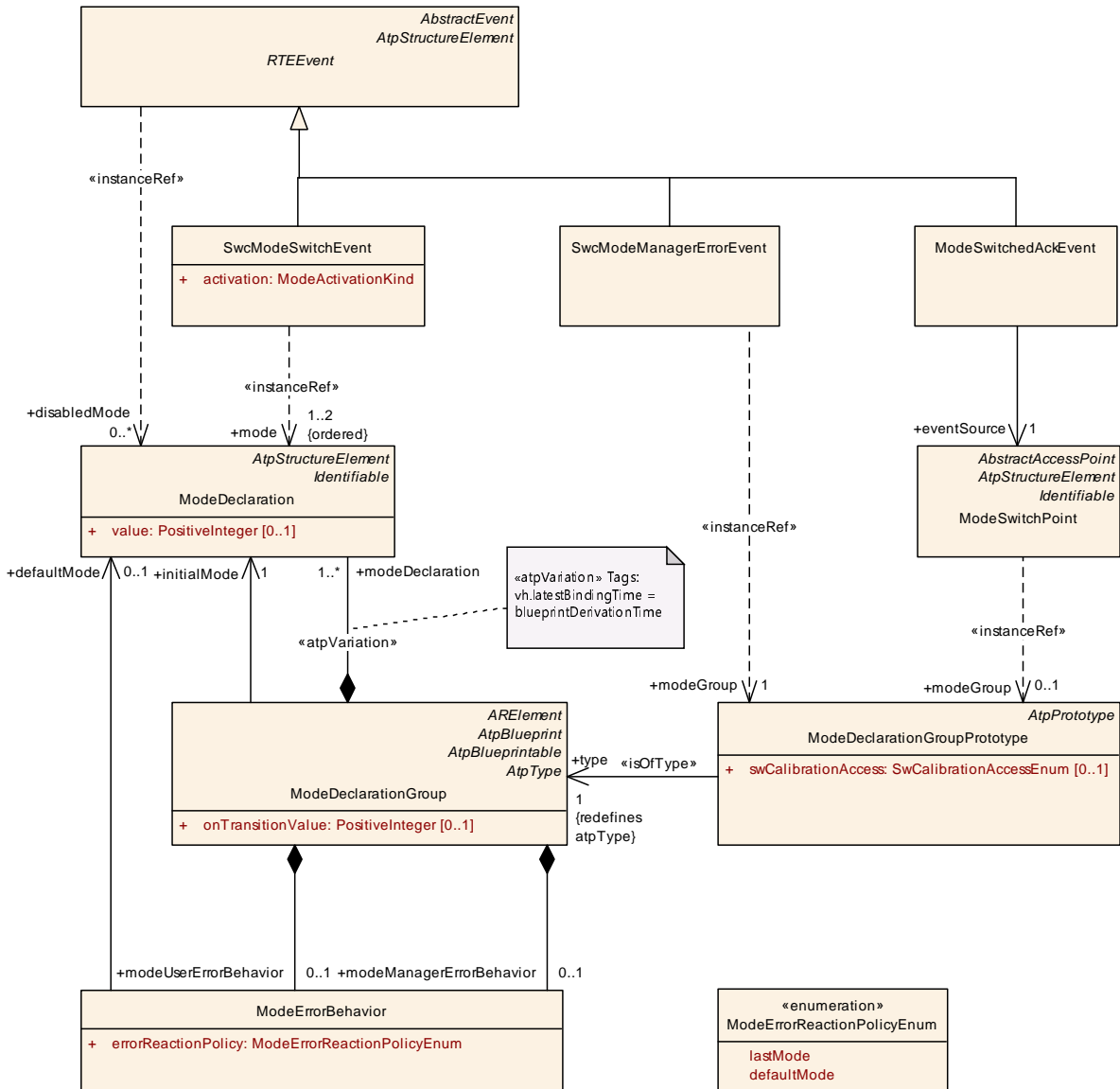

Figure 7.10: RTEEvents used in the context of mode communication

Please note that more explanation about the semantics of the meta-classes **SwcMode-ManagerErrorEvent** and **ModeErrorBehavior** can be found in section 9.4.

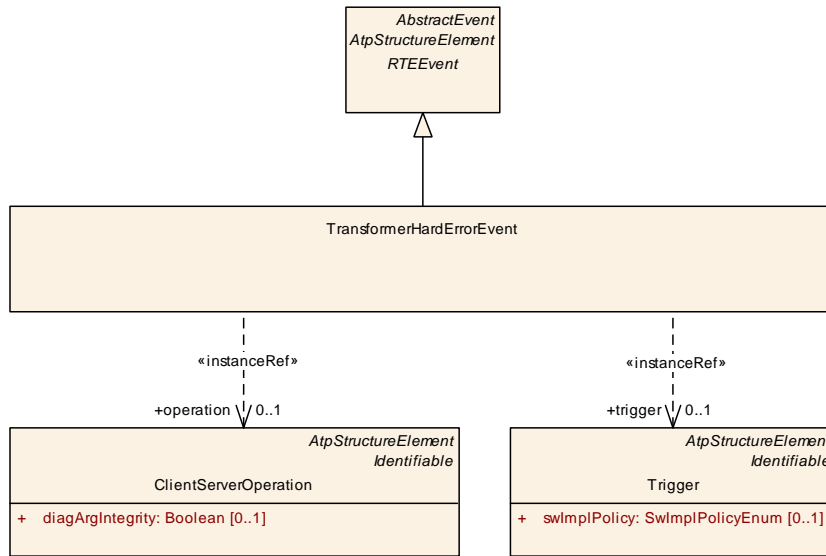

Figure 7.11: **RTEEvent** used in the context of data transformation

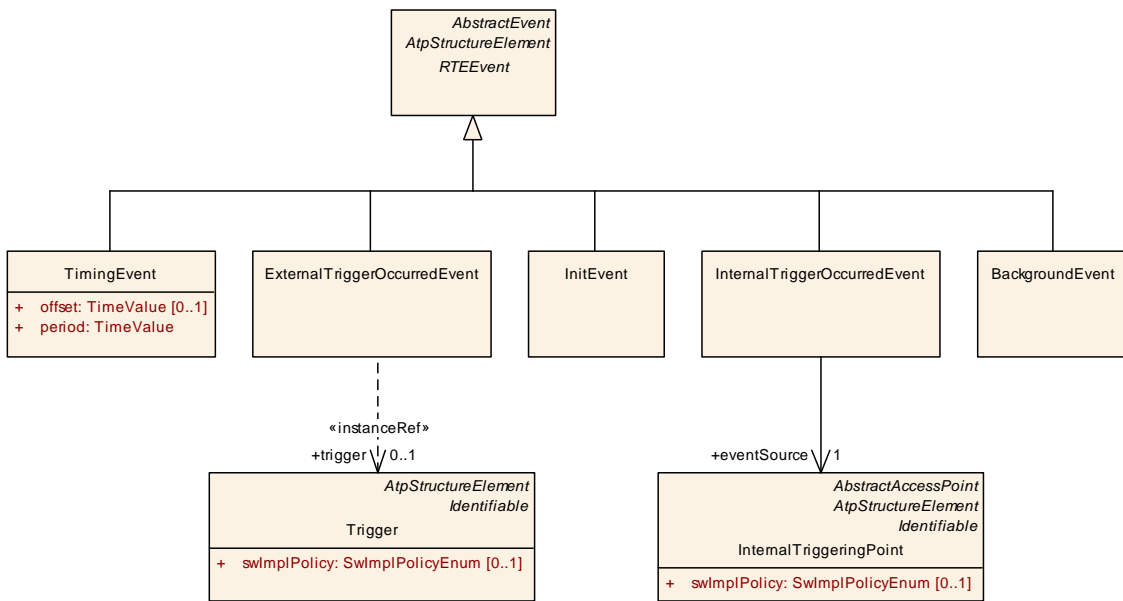

Figure 7.12: **RTEEvents** for purposes other than communication

The details of the various kinds of concrete **RTEEvents** (such as the **TimingEvent**, **DataSendCompletedEvent**, etc.), is described in chapters 7.5.1, 7.5.2 and 7.2.3.

7.3.2 Defining how to Respond to an Event

[TPS_SWCT_01317] RTE triggers **RunnableEntity in response to occurring **RTEEvent**** [If the software-component description contains a reference from an **RTEEvent** to a **RunnableEntity** in the role **startOnEvent**, it is the responsibility of the RTE to trigger the execution of the corresponding **RunnableEntity** when the **RTEEvent** occurs.]()

[TPS_SWCT_01318] **RunnableEntity** and **WaitPoint** [In case the **RunnableEntity** wants to block and wait for **RTEEvents** (which makes the **RunnableEntity** into a cat. 2 **RunnableEntity**), the description of the **RunnableEntity** may include the definition of a **WaitPoint**.

Such a **WaitPoint** contains a reference to an **RTEEvent** that can unblock the specific **WaitPoint**. In other words: the **WaitPoint** will block until the referenced **RTEEvents** occurs or the period specified in the attribute **timeout** expires.]()

Figure 7.13 gives an overview of the modeling of **WaitPoint**.

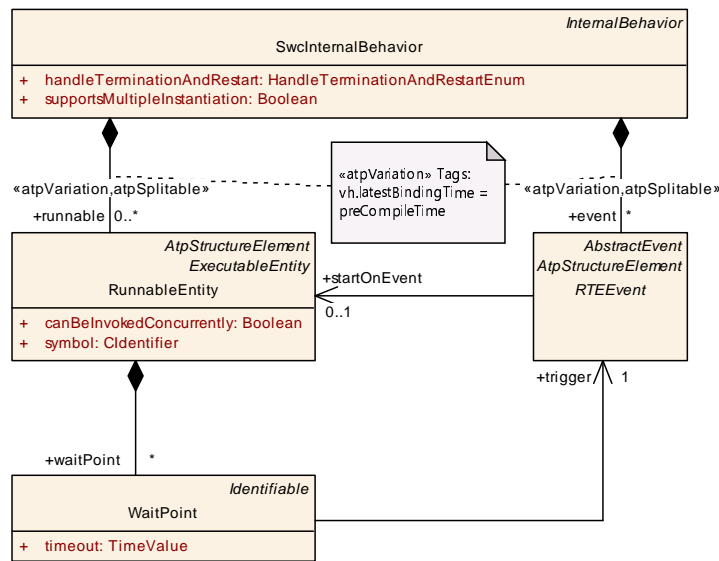

Figure 7.13: Description of the interaction between an **RTEEvent** and **RunnableEntities**

[constr_1090] **WaitPoint** and **RunnableEntity** [A single **RunnableEntity** can actually wait only at a single **WaitPoint** provided that the **RunnableEntity** can only be scheduled a single time³.]()

[constr_1091] **RTEEvents** that can unblock a **WaitPoint** [The only **RTEEvents** that are qualified for unblocking a **WaitPoint** are:

- **DataReceivedEvent**
- **DataSendCompletedEvent**
- **ModeSwitchedAckEvent**
- **AsynchronousServerCallReturnsEvent**

]()

[TPS_SWCT_01319] **RTEEvent** can be used to trigger **WaitPoints** in different **RunnableEntities** [It is in general possible that a single **RTEEvent** can be used to trigger **WaitPoints** in different **RunnableEntities**.]()

³This constraint is valid at least in the ISO 17356-3 [30] standard where an extended task (that can have wait points) can only exist a single time in the context of the scheduler.

Concerning `DataReceivedEvents` consider as well [constr_2021].

Class	WaitPoint			
Package	M2::AUTOSARTemplates::SWComponentTemplate::SwcInternalBehavior::RTEEvents			
Note	This defines a wait-point for which the <code>RunnableEntity</code> can wait.			
Base	<code>ARObject</code> , <code>Identifiable</code> , <code>MultilanguageReferrable</code> , <code>Referrable</code>			
Attribute	Type	Mult.	Kind	Note
timeout	<code>TimeValue</code>	1	attr	Time in seconds before the <code>WaitPoint</code> times out and the blocking wait call returns with an error indicating the timeout.
trigger	<code>RTEEvent</code>	1	ref	This is the <code>RTEEvent</code> this <code>WaitPoint</code> is waiting for.

Table 7.26: WaitPoint

[constr_1096] `SwcModeSwitchEvent` and `WaitPoint` [A `RunnableEntity` that has a `WaitPoint` shall not be referenced by a `SwcModeSwitchEvent`.]()

[TPS_SWCT_01320] `RunnableEntities` of category 2 [A `RunnableEntity` that aggregate a `WaitPoint` are by definition of category 2 and therefore are not required to terminate ever. It is therefore difficult to let a `RunnableEntity` of category 2 implement a mode switch.]()

[constr_1097] `RunnableEntity` that has a `WaitPoint` [A `RunnableEntity` that has a `WaitPoint` shall not be referenced by a `RTEEvent` that has a reference in the role `disabledMode`.]()

[TPS_SWCT_01324] **Mode switches need to be completed in finite time** [Mode switches need to be completed in finite time and a `RunnableEntity` that has a `WaitPoint` can never guarantee that the `WaitPoint` is resolved within finite time.]()

In addition to this, the `RunnableEntity` with a `WaitPoint` that would be affected by a mode disabling would typically already run when the mode disabling applies. It could not be terminated at this point in time.

7.4 Communication among Runnable Entities

It is taken for granted that particular `RunnableEntities` within a specific `AtomicSwComponentType` will need to communicate among each other.

[TPS_SWCT_01321] **Communication among `RunnableEntities`** [The RTE needs to provide synchronization mechanisms to the `RunnableEntities` such that safe (in the multi-threading sense) exchange of data is possible.

In this case, the use of `PortPrototypes` is (although technically feasible) not required for the purpose.]([RS_SWCT_00120](#))

[TPS_SWCT_01592] **Communication among `RunnableEntities` of different instances of the same `AtomicSwComponentType`** [The communication among `RunnableEntities` of different instances of the same `AtomicSwComponentType` is only supported via `PortPrototypes`.]([RS_SWCT_00120](#))

Several concepts for implementing communication among `RunnableEntity`s can be identified.

As an introduction, the section 2.3.1 describes the various techniques that the RTE might use to provide efficient interaction between `RunnableEntity`s within one `AtomicSwComponentType`.

Two possible approaches for formal specification of this kind of communication are described:

- Specifying that several `RunnableEntity`s belong in a specific `ExclusiveArea`
- Specifying the data exchanged between the `RunnableEntity`s

7.4.1 Description Possibility 1: Exclusive Area

This section describes how the concept of `ExclusiveAreas` can be used in the description of the `SwcInternalBehavior` of an `AtomicSwComponentType`.

Please note that `ExclusiveAreas` are actually owned by the base class of `SwcInternalBehavior`, i.e. `InternalBehavior`. These `ExclusiveAreas` do not imply a specific implementation (e.g. with mutual-exclusion semaphores).

Class	ExclusiveArea			
Package	M2::AUTOSARTemplates::CommonStructure::InternalBehavior			
Note	Prevents an executable entity running in the area from being preempted.			
Base	<code>ARObject</code> , <code>Identifiable</code> , <code>MultilanguageReferrable</code> , <code>Referrable</code>			
Attribute	Type	Mult.	Kind	Note
–	–	–	–	–

Table 7.27: ExclusiveArea

[TPS_SWCT_01031] ExclusiveArea [An `ExclusiveArea` merely specifies a constraint on the scheduling policy and configuration of the RTE:

If two or more `RunnableEntity`s refer to the same `ExclusiveArea` only one of these `RunnableEntity`s is allowed to be executed while being inside that `ExclusiveArea`.] (`RS_SWCT_00120`, `RS_SWCT_02090`)

In other words: these `RunnableEntity`s shall not run concurrently (preempt each other) while executing inside the `ExclusiveArea`.

Please find more details about the formal definition of meta-class `ExclusiveArea` in Figure 7.14.

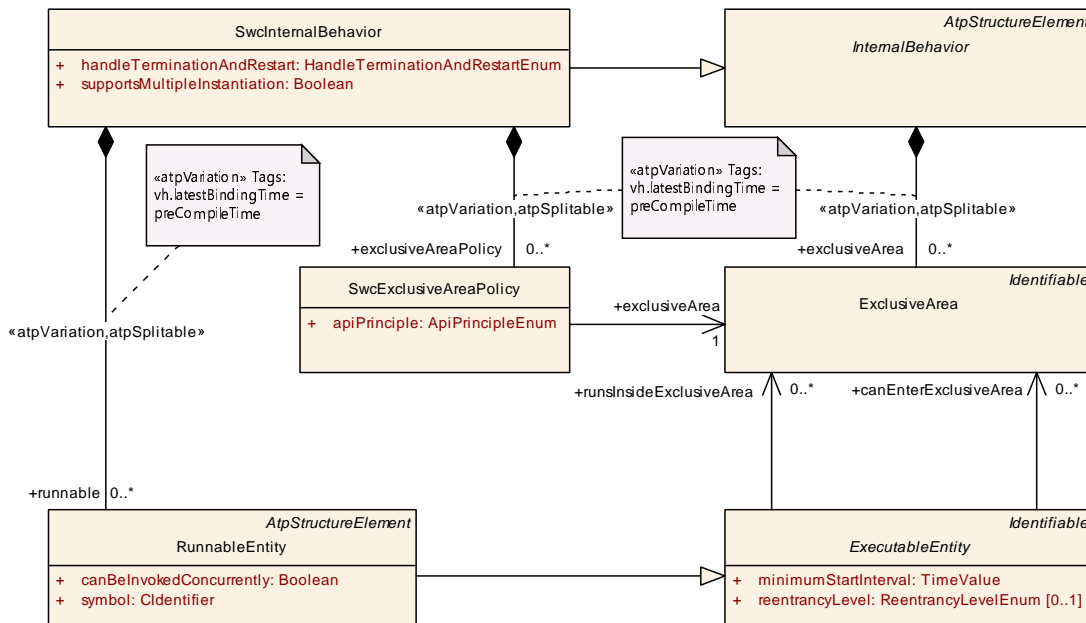

Figure 7.14: Description of logical exclusive areas

[TPS_SWCT_01049] Two ways to use the **ExclusiveAreas** [There are in general two ways to use the **ExclusiveAreas**. During its execution, a **RunnableEntity** can enter and exit an **ExclusiveArea** (in which case **ExecutableEntity.canEnterExclusiveArea** shall exist).

As an alternative, it can be specified that the entire execution of a given **RunnableEntity** shall be guarded by an **ExclusiveArea** (this requires the existence of **ExecutableEntity.runsInsideExclusiveArea**).] (*RS_SWCT_00120, RS_SWCT_02090*)

Please note that the options for entering an **ExclusiveArea** are documented in section 7.4.1.1 and section 7.4.1.2

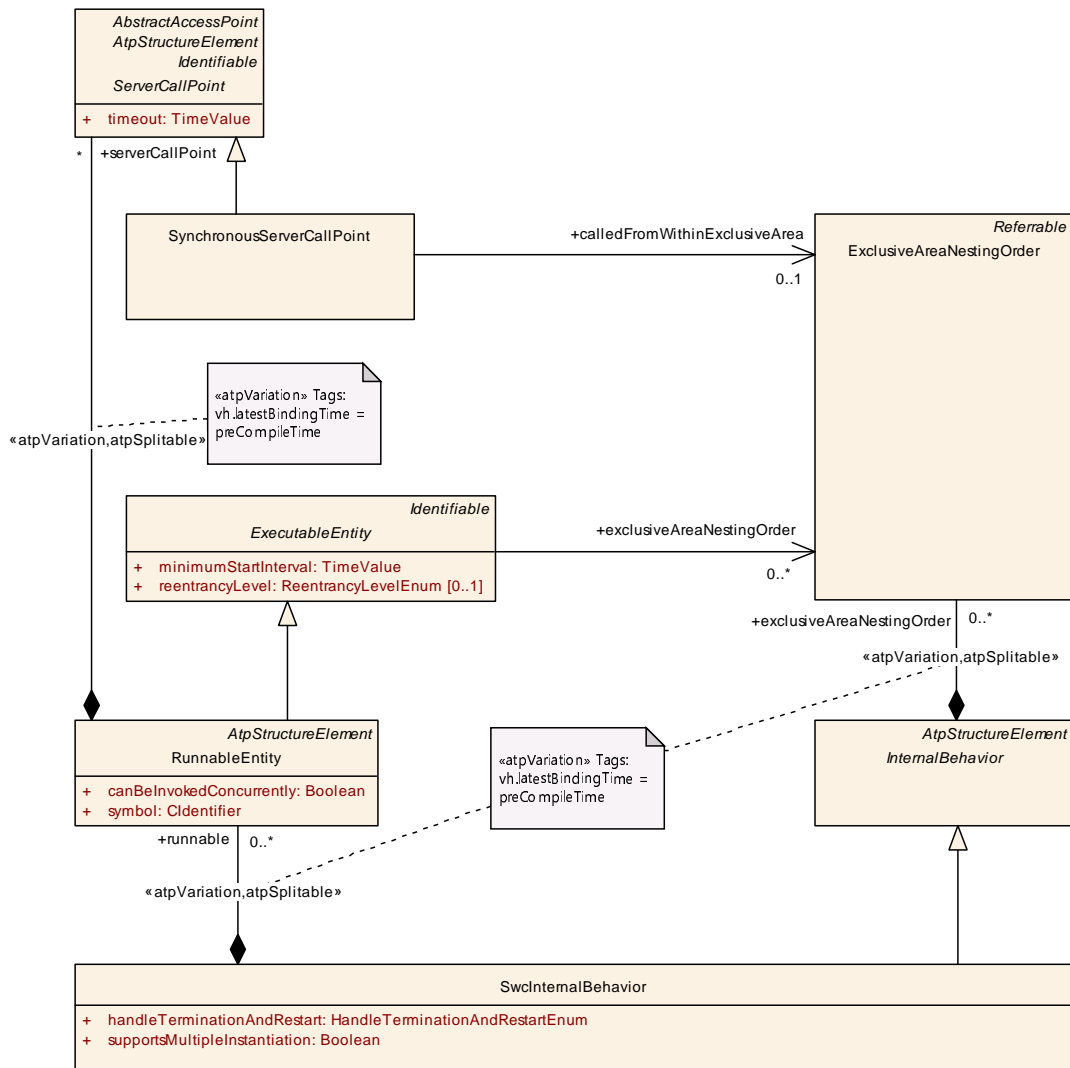

Figure 7.16: Nested usage of ExclusiveArea and the impact on SynchronousServerCallPoint

An ExclusiveAreaNestingOrder is aggregated by the InternalBehavior that in turn also owns RunnableEntity.

[TPS_SWCT_01460] Relation of SynchronousServerCallPoint to ExclusiveAreaNestingOrder [In case other RunnableEntities are invoked synchronously from within the RunnableEntity the ExclusiveAreaNestingOrder can then be referenced by one or several SynchronousServerCallPoints to specify the calling environment of the invoked server with regard to ExclusiveAreas.] (RS_SWCT_03055)

The purpose of this configuration is to analyze the resource locking behavior for complete call trees.

Class	ExclusiveAreaNestingOrder			
Package	M2::AUTOSARTemplates::CommonStructure::InternalBehavior			
Note	This meta-class represents the ability to define a nesting order of ExclusiveAreas. A nesting order (that may occur in the executable code) is formally defined to be able to analyze the resource locking behavior.			
Base	ARObject, Referrable			
Attribute	Type	Mult.	Kind	Note
exclusiveArea (ordered)	ExclusiveArea	*	ref	This represents a specific scenario of how Exclusive Areas can be used in terms of the nesting order.

Table 7.28: ExclusiveAreaNestingOrder

7.4.1.1 Entire Runnable Runs in the Exclusive Area

[TPS_SWCT_01050] RunnableEntity always runs inside an ExclusiveArea [In the first approach, the formal description specifies that certain RunnableEntities always run inside an ExclusiveArea.] (RS_SWCT_00120, RS_SWCT_02090)

For example, if the formal description specifies that both RunnableEntity 'r1' and RunnableEntity 'r2' run within ExclusiveArea 's1', the RTE shall make sure that RunnableEntities 'r1' and 'r2' never run concurrently; the scheduler should never preempt 'r1' to run 'r2'.

Note that this pattern does not force the RTE to implement this by using semaphores or mutexes that are taken before the RunnableEntity starts and given when the RunnableEntity returns. It only obliges the RTE to make sure that both RunnableEntities are never running concurrently.

This requirement could be implemented by several of the implementation strategies described above. For example:

1. Scheduling strategy: if, for example, RunnableEntities 'r1' and 'r2' are mapped to the same task, the criterion is automatically satisfied. For this purpose it is necessary to make sure that the OS can only execute a single instance of the task into which the RunnableEntities are put.
2. Mutual exclusion semaphores: in case 'r1' and 'r2' are mapped to different tasks ('T1', respectively 'T2'), the OS shall make sure that while 'T1' is executing 'r1', 'T2' running 'r2' can never preempt it and vice-versa. This could be implemented by taking a mutual-exclusion semaphore before executing 'r1' (or 'r2') in the context of 't1' (or 't2') and returning the semaphore on exiting the RunnableEntity.

7.4.1.2 Runnable would Dynamically Enter and Leave the Exclusive Area

[TPS_SWCT_01051] RunnableEntity explicitly enters and leaves a specific ExclusiveArea [In the second approach, the RunnableEntity would explicitly make

API-calls to the RTE within the implementation of the `RunnableEntity` to enter and leave a specific `ExclusiveArea`.] ([RS_SWCT_00120](#), [RS_SWCT_02090](#))

This could, for example, be implemented by means of the priority ceiling concept described in chapter [2.3.1.3](#).

Additionally, it is possible to define the execution time the `RunnableEntity` will spend in this `ExclusiveArea` segment. Please note that although this aspect is described in [6] the concept can be applied to software-components as well.

7.4.1.3 Configuration of API Generation

For certain usage scenarios of `ExclusiveAreas` it is considered advantageous if each `RunnableEntity` uses a distinct set of enter and exit APIs.

This distinct set of APIs support `ExclusiveArea` implementations where for the `RunnableEntity(s)` with the highest priority the lock is omitted.

This is possible when the `RunnableEntity(s)` with the highest priority can't be interrupted by `RunnableEntitys` scheduled with lower priority.

To support this kind of implementations, the software-component description has to state (by means of attribute `SwcInternalBehavior.exclusiveAreaPolicy.apiPrinciple`) that it requests APIs individually for each `RunnableEntity` referencing an `ExclusiveArea` in the role `canEnterExclusiveArea`.

Class	SwcExclusiveAreaPolicy			
Package	M2::AUTOSARTemplates::SWComponentTemplate::SwcInternalBehavior			
Note	Options how to generate the ExclusiveArea related APIs. If no SwcExclusiveAreaPolicy is specified for an ExclusiveArea the default values apply.			
Base	<i>ARObject</i>			
Attribute	Type	Mult.	Kind	Note
apiPrinciple	ApiPrincipleEnum	1	attr	Specifies for this ExclusiveArea if either one common set of Enter and Exit APIs for the whole software component is requested from the Rte or if the set of Enter and Exit APIs is expected per RunnableEntity. The default value is "common".
exclusiveArea	ExclusiveArea	1	ref	This reference represents the ExclusiveArea for which the policy applies.

Table 7.29: SwcExclusiveAreaPolicy

Enumeration	ApiPrincipleEnum
Package	M2::AUTOSARTemplates::CommonStructure::InternalBehavior
Note	This enumeration represents the ability to control the granularity of API generation.
Literal	Description





Enumeration	ApiPrincipleEnum
common	The Rte or SchM API is provided for the whole software component / BSW Module Tags: atp.EnumerationLiteralIndex=0
perExecutable	The Rte or SchM API is provided for a specific ExecutableEntity of a software component / BSW Module Tags: atp.EnumerationLiteralIndex=1

Table 7.30: ApiPrincipleEnum

[TPS_SWCT_01713] ExclusiveArea is entered and exited by a common set of APIs [If the value of attribute `SwcExclusiveAreaPolicy.apiPrinciple` is set to `ApiPrincipleEnum.common` then the RTE provides **one set** of enter and exit APIs to be shared among all `RunnableEntity`s of the whole software-component.] ([RS_SWCT_00120](#), [RS_SWCT_02090](#))

In this case, the same enter and exit code is executed by all affected `RunnableEntity`s and there is no way to have a special treatment for the `RunnableEntity`(s) executed in the context with the highest priority.

[TPS_SWCT_01714] ExclusiveArea is entered and exited by an individual set of APIs [If the value of attribute `SwcExclusiveAreaPolicy.apiPrinciple` is set to `ApiPrincipleEnum.perExecutable` then the RTE provides **individual** sets of APIs for entering and exiting `ExclusiveArea`s for each affected `RunnableEntity`.] ([RS_SWCT_00120](#), [RS_SWCT_02090](#))

In this case, the implementation of enter and exit code for the `RunnableEntity` executed in the execution context with the highest priority can be left empty.

In order to avoid the existence of contradicting settings of `SwcExclusiveAreaPolicies` for one `ExclusiveArea` [[constr_1468](#)] applies.

[constr_1468] Limitation on the number of SwcExclusiveAreaPolicies [An `ExclusiveArea` shall only be referenced by **at most** one `SwcExclusiveAreaPolicy`.]()

7.4.2 Description Possibility 2: Inter-Runnable Variable

For certain cases the `ExclusiveArea` concept does not provide enough information to configure the RTE correctly. In these cases it may be advised to opt for a different approach that is based on the guarded access to variables protected by the RTE.

For the purpose of identifying pieces of data that shall be accessed concurrently from different `RunnableEntity`s formal support is required. In AUTOSAR, this aspect is summarized under the term "inter-runnable variable".

[TPS_SWCT_01052] Inter-runnable variable [These so-called "inter-runnable variables" are described with the element `VariableDataPrototype` aggregated in

the role `explicitInterRunnableVariable` or `implicitInterRunnableVariable`.] (*RS_SWCT_00120*, *RS_SWCT_02090*)

[TPS_SWCT_01053] Relationship of interchanged data with `RunnableEntity`
[Furthermore, the relationship of these data with `RunnableEntity` shall be specified.

For this specific purpose, `RunnableEntity` aggregates `VariableAccess` in the roles `readLocalVariable` and `writtenLocalVariable`.

Also, `SwcInternalBehavior` aggregates `VariableDataPrototype` in the roles `explicitInterRunnableVariable` and `implicitInterRunnableVariable`.

The connection between `RunnableEntity` and the `explicitInterRunnableVariable` and `implicitInterRunnableVariable` is created if the reference `AutosarVariableRef.localVariable` to the respective `VariableDataPrototype` exists.] (*RS_SWCT_00120*, *RS_SWCT_02090*)

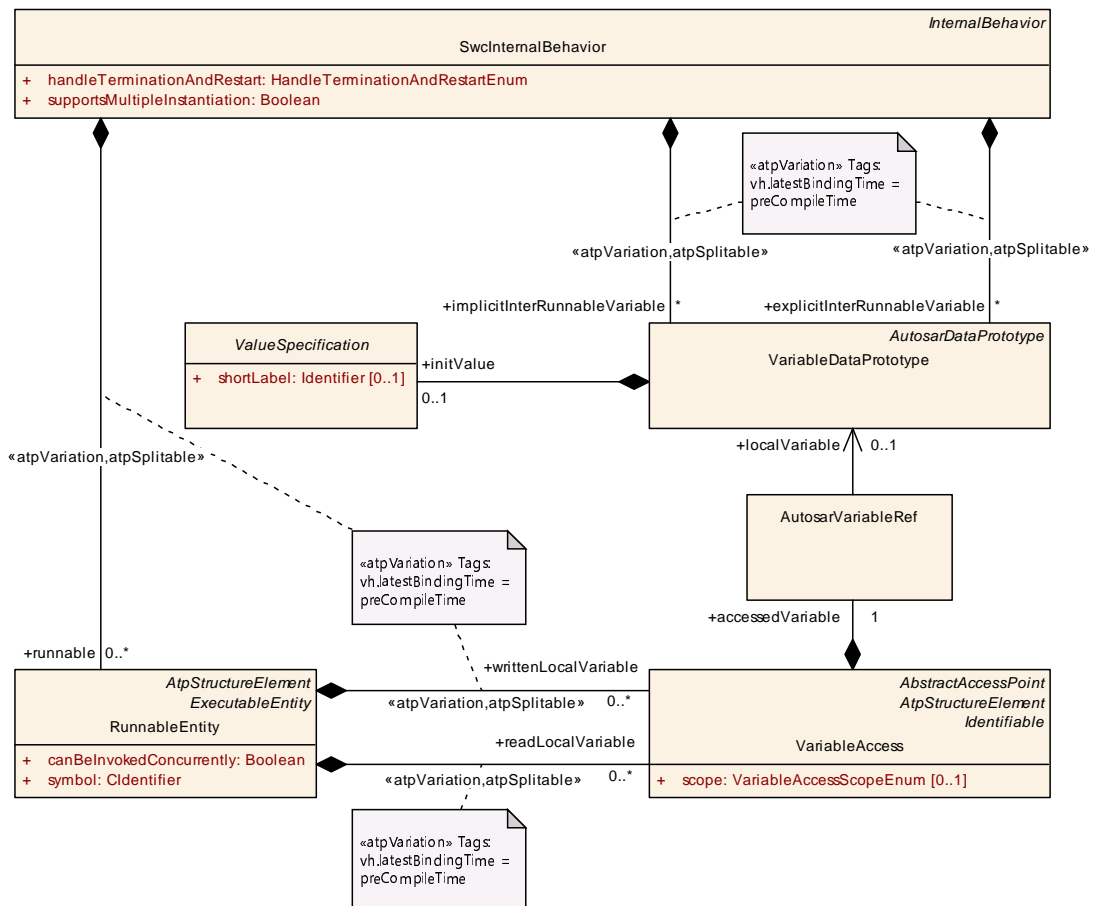

Figure 7.17: `implicitInterRunnableVariable` vs. `explicitInterRunnableVariable`

[TPS_SWCT_01521] Use `AutosarVariableRef.localVariable` for referencing inter-runnable variables [A `RunnableEntity` that defines a `VariableAccess` in

role `writtenLocalVariable` and `readLocalVariable` shall make use of `AutosarVariableRef.localVariable.()`

[constr_2026] Referenced `VariableDataPrototype` from `AutosarVariableRef` of `VariableAccess` in role `writtenLocalVariable` and `readLocalVariable` [A `VariableDataPrototype` in the `localVariable` reference needs to be owned by the same `SwcInternalBehavior` as this `RunnableEntity` belongs to, and the referenced `VariableDataPrototype` has to be defined in the role `implicitInterRunnableVariable` or `explicitInterRunnableVariable`.]()

Obviously, the data-type of an `implicitInterRunnableVariable` or `explicitInterRunnableVariable` is described by the data type of the `VariableDataPrototype` (which is derived from `DataPrototype`).

[TPS_SWCT_01637] Initial value for a specific `implicitInterRunnableVariable` or `explicitInterRunnableVariable` [It is possible (but not mandatory) to define an initial value for a specific `implicitInterRunnableVariable` or `explicitInterRunnableVariable`.

For this purpose the `VariableDataPrototype` in the role of `explicitInterRunnableVariable` or `implicitInterRunnableVariable` is able to aggregate a `ValueSpecification` in the role `initValue`.]([RS_SWCT_02090](#))

The statement made by [\[TPS_SWCT_01637\]](#) is reflected by [Figure 7.17](#)

[TPS_SWCT_01522] No initial value is specified for `implicitInterRunnableVariable` or `explicitInterRunnableVariable` [Please note that the behavior is undefined if no initial value is specified and a `RunnableEntity` reads an `implicitInterRunnableVariable` or `explicitInterRunnableVariable` before it is actually written to by another `RunnableEntity`.]()

As already mentioned before, the concept of an "inter-runnable variable" can be used in *two different flavors*. This is indicated by the two different roles `explicitInterRunnableVariable` or `implicitInterRunnableVariable` in which the `VariableDataPrototype` serving as the "inter-runnable variable" is aggregated.

These resemble the communication principles applied for the communication on the level of `SwComponentTypes`.

Please note that the two different kinds of inter-runnable variables are accessed via different RTE [2] API calls.

[TPS_SWCT_01054] Semantics of the `explicitInterRunnableVariable` [The semantics of the `explicitInterRunnableVariable` is that *explicit* implies the direct access to the value of a `VariableDataPrototype` used in the role `explicitInterRunnableVariable`.

By this means it is possible to get different values for a specific `VariableDataPrototype` each time the corresponding API call is executed.]([RS_SWCT_00120](#), [RS_SWCT_02090](#))

[TPS_SWCT_01055] **Semantics of `implicitInterRunnableVariable`** [The `implicitInterRunnableVariable` corresponds to an execution model where the value of an `VariableDataPrototype` does not change (for the reading `RunnableEntity`, obviously) during the runtime of a `RunnableEntity`.] ([RS_SWCT_00120](#), [RS_SWCT_02090](#))

This approach is in detail described in chapter [2.3.1.4](#).

[constr_1296] **DataPrototypes used as `explicitInterRunnableVariable` or `implicitInterRunnableVariable` and category `DATA_REFERENCE`** [A `VariableDataPrototype` shall not be aggregated by `SwcInternalBehavior` in either the role `explicitInterRunnableVariable` or `implicitInterRunnableVariable` if the `VariableDataPrototype` (after potential indirections via `TYPE_REFERENCE` are resolved) is either typed by or mapped to an `ImplementationDataType` of category `DATA_REFERENCE`.] ()

7.4.3 Inter Runnable Triggering

The concept of *inter-runnable triggering* allows one `RunnableEntity` to trigger another `RunnableEntity` within an `AtomicSwComponentType`. This approach conceptually supports the decoupling of calculation and processing sequences inside a software-component.

By mappings of the `InternalTriggerOccurredEvents` to OS Tasks running at different priorities the triggered `RunnableEntity`s are in turn executed with a different priority as the triggering `RunnableEntity`.

For example, a cyclically triggered `RunnableEntity` which shall not exceed a certain worst case execution time (WCET) activates a second `RunnableEntity` if an error occurred in order to be able to execute a (potentially) time-consuming exception-handling on a lower level of priority.

Class	InternalTriggeringPoint			
Package	M2::AUTOSARTemplates::SWComponentTemplate::SwcInternalBehavior::Trigger			
Note	If a RunnableEntity owns an InternalTriggeringPoint it is entitled to trigger the execution of Runnable Entities of the corresponding software-component.			
Base	ARObject, AbstractAccessPoint , AtpClassifier , AtpFeature , AtpStructureElement , Identifiable , MultilanguageReferrable , Referrable			
Attribute	Type	Mult.	Kind	Note
swImplPolicy	SwImplPolicyEnum	0..1	attr	This attribute, when set to value queued, allows for a queued processing of Triggers.

Table 7.31: InternalTriggeringPoint

The description of the corresponding *external* trigger communication is contained in chapter 7.5.3.

7.5 Data Access of RunnableEntities

This section describes the communication properties of an [AtomicSwComponentType](#). This is done mainly from the point of view of a [RunnableEntity](#) (the concept of a [RunnableEntity](#) is introduced in chapter 7.2).

However, the usage of a [PortPrototype](#) in a specific role within an [AtomicSwComponentType](#) also has an impact on communication behavior.

Access of [RunnableEntities](#) to the different elements in [PortInterfaces](#) or the [InternalBehavior](#) are modeled by a set of meta classes specific to the communication pattern and the kind of access.

Nevertheless, all of those meta classes inherit from [AbstractAccessPoint](#) in order to enable the ability to be referenced in a harmonized way to by additional descriptions.

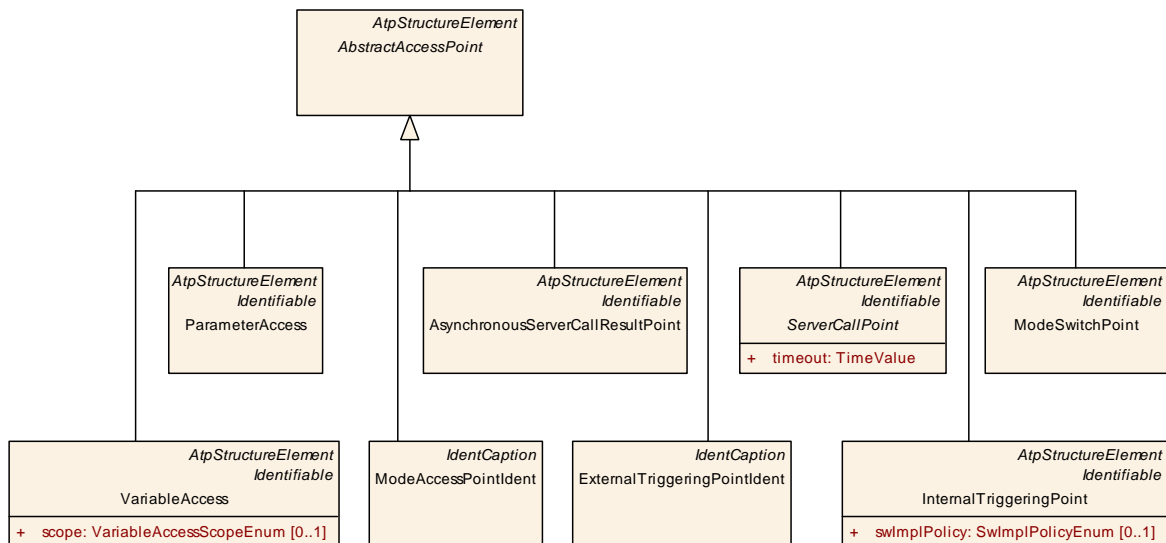

Figure 7.19: Modeling of the [AbstractAccessPoint](#)

Class	AbstractAccessPoint (abstract)			
Package	M2::AUTOSARTemplates::SWComponentTemplate::SwcInternalBehavior::AccessCount			
Note	Abstract class indicating an access point from an ExecutableEntity.			
Base	ARObject, AtpClassifier, AtpFeature, AtpStructureElement, Identifiable, MultilanguageReferrable, Referrable			
Subclasses	AsynchronousServerCallResultPoint, ExternalTriggeringPointIdent, InternalTriggeringPoint, ModeAccessPointIdent, ModeSwitchPoint, ParameterAccess, ServerCallPoint, VariableAccess			
Attribute	Type	Mult.	Kind	Note
–	–	–	–	–

Table 7.32: AbstractAccessPoint

RunnableEntity that access DataPrototypes in the context of PortPrototypes are **not** allowed to extend the data access to sub-elements of the respective DataPrototypes.

For example, assume a DataPrototype that effectively implements a structure of two elements A and B. It is **not** supported to only send or receive only element A or B of the structure.

This assertion leads to the existence of [constr_1429] and, by extension, [constr_1430].

[constr_1429] Access to data within PortPrototypes from within RunnableEntities [For a VariableAccess that is aggregated in the roles

- RunnableEntity.dataWriteAccess
- RunnableEntity.dataReadAccess
- RunnableEntity.dataSendPoint
- RunnableEntity.dataReceivePointByArgument
- RunnableEntity.dataReceivePointByValue

the existence of the following attributes is not allowed:

- VariableAccess.accessedVariable.autosarVariable.contextDataPrototype
- VariableAccess.accessedVariable.autosarVariable.rootVariableDataPrototype
- VariableAccess.accessedVariable.autosarVariableInImplDatatype
- VariableAccess.accessedVariable.localVariable

In other words: in this case, only the references VariableAccess.accessedVariable.autosarVariable.portPrototype and VariableAccess.accessedVariable.autosarVariable.targetDataPrototype shall exist and the latter shall **exclusively** refer to a VariableDataPrototype that is aggregated as either

- `SenderReceiverInterface.dataElement` or
- `NvDataInterface.nvData`.

]()

[constr_1430] Access to local data from within `RunnableEntity`s [For `VariableAccess` that is aggregated in the roles

- `RunnableEntity.writtenLocalVariable`
- `RunnableEntity.readLocalVariable`

the existence of the following attributes is not allowed:

- `VariableAccess.accessedVariable.autosarVariableInImplDatatype`
- `VariableAccess.accessedVariable.autosarVariable`

In other words, **only** the reference `VariableAccess.accessedVariable.localVariable` shall be used in this case.]()

[constr_1431] Access to parameters from within `RunnableEntity`s [For a `ParameterAccess` that is aggregated in the role `RunnableEntity.parameterAccess` the existence of the following attributes is not allowed:

- `ParameterAccess.accessedParameter.autosarParameter.contextDataPrototype`
- `ParameterAccess.accessedParameter.autosarParameter.rootParameterDataPrototype`

In other words: in this case, **one** of the following alternatives is allowed to exist:

- a combination of
 - `ParameterAccess.accessedParameter.autosarParameter.portPrototype` and
 - `ParameterAccess.accessedParameter.autosarParameter.targetDataPrototype` that **exclusively** refers to a `ParameterDataPrototype` aggregated by a `ParameterInterface` in the role `parameter`.
- `ParameterAccess.accessedParameter.localParameter` that refers to a `ParameterDataPrototype` that is either aggregated as
 - `InternalBehavior.constantMemory` or
 - `SwcInternalBehavior.perInstanceParameter` or
 - `SwcInternalBehavior.sharedParameter`.

]()

7.5.1 RunnableEntities and Sender Receiver Communication

This section describes aspects relevant for the sender-receiver communication of a software-component. These mainly influence the behavior and API of the AUTOSAR RTE.

[TPS_SWCT_01322] Interaction patterns for the application of the sender-receiver paradigm [The possible interaction patterns for the application of the sender-receiver paradigm are explained, namely:

1. Data-access in a cat. 1 [RunnableEntity](#),
2. explicit sending,
3. the [DataSendCompletedEvent](#): dealing with the success/failure of an explicit send, and
4. the [DataReceivedEvent](#): responding to the reception of data
5. the [DataReceiveErrorEvent](#): notifying an error concerning the reception of data.

]([RS_SWCT_00200](#))

7.5.1.1 Terminology

The AUTOSAR meta-model foresees two different approaches for sender-receiver communication. These are described in detail in chapters [7.5.1.2](#) and [7.5.1.3](#). However, it turned out that it is rather cumbersome to discuss issues of communication approaches directly on the basis of meta-classes and their attributes.

Therefore, it seems appropriate to introduce a dedicated terminology for this purpose. The approach eventually selected was originally introduced by the contributors to the RTE specification.

This terminology proposes to use the term “implicit” for communication based on *data-access* (for more information about details of this approach please consult chapter [7.5.1.2](#)) and “explicit” for communication based on so-called *data-points* (please refer to chapter [7.5.1.3](#)).

The motivation for the differentiation between “implicit” and “explicit” was originally the characteristics of the RTE specification that foresaw an API for handling a [dataSendPoint](#) or [dataReceivePointByValue](#) in contrast to the *data-access* that was supposed to be part of the function signature (therefore, no API was required) of a specific [RunnableEntity](#).

Although the specification of the RTE changed in the meantime (and the original motivation no longer applies) it turned out that the terminology based on “implicit” and “explicit” communication was already widely used within AUTOSAR.

As no consensus could be reached over alternative proposals this terminology approach is taken over by this document as well.

7.5.1.2 Data Access

[TPS_SWCT_01323] Read and write access to a `dataElement` [The `SwcInternalBehavior` may specify that a `RunnableEntity` needs read-access (respectively write-access) to the `VariableDataPrototypes` in the role `dataElement` of an `RPortPrototype` (respectively `PPortPrototype`, or `PRPortPrototype`).] (*RS_SWCT_00200*)

[TPS_SWCT_01325] Read and write access is only applicable for `RunnableEntity`s of category 1 [The usage of the data-access mechanism to the `VariableDataPrototypes` is appropriate for cat. 1 `RunnableEntity`s only because it by concept guarantees finite response time (as opposed to e.g. unlimited blocking wait for some data).] (*RS_SWCT_00200*)

For more explanation, let's suppose a cat. 2 `RunnableEntity` would have a `dataReadAccess` and a `dataWriteAccess`. The received `dataElement` would be updated **before** the `RunnableEntity` actually starts being executed and even if the `RunnableEntity` runs for a very long time the value of the `dataElement` would remain as is and never change.

On the other hand, the `RunnableEntity` might use its `dataWriteAccess` to perform a write access on the `dataElement` but the actual value might never make it beyond the `RunnableEntity` because

1. the latter is not required to terminate ever and
2. the actual write access is executed *after* the `RunnableEntity` terminates.

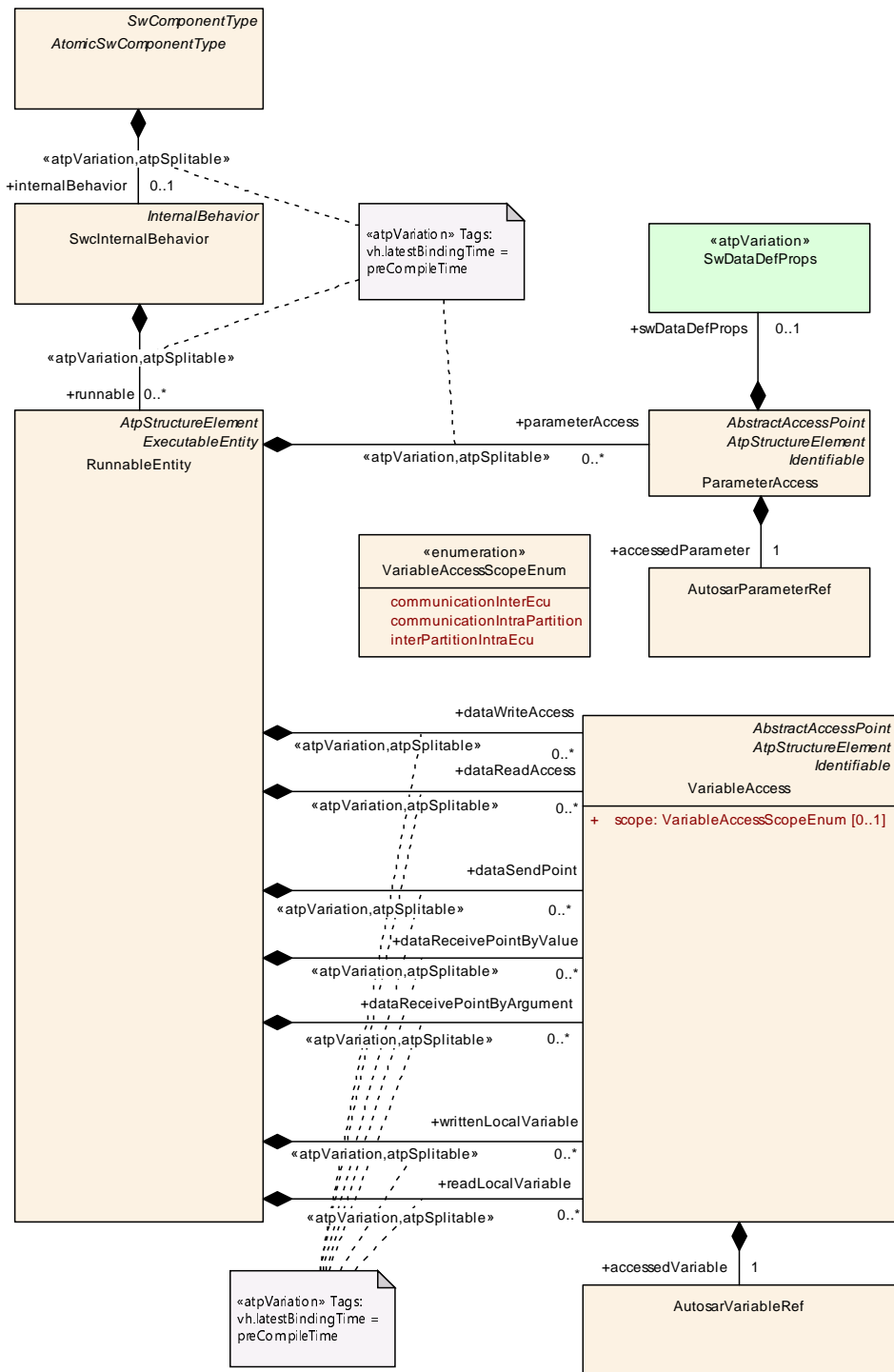

Figure 7.20: DataReadAccess and DataWriteAccess

Class	VariableAccess			
Package	M2::AUTOSARTemplates::SWComponentTemplate::SwcInternalBehavior::DataElements			
Note	The presence of a VariableAccess implies that a RunnableEntity needs access to a VariableData Prototype. The kind of access is specified by the role in which the class is used.			
Base	ARObject, AbstractAccessPoint , AtpClassifier , AtpFeature , AtpStructureElement , Identifiable , MultilanguageReferrable , Referrable			
Attribute	Type	Mult.	Kind	Note
accessed Variable	AutosarVariableRef	1	aggr	This denotes the accessed variable.
scope	VariableAccessScope Enum	0..1	attr	This attribute allows for constraining the scope of the corresponding communication. For example, it possible to express whether the communication is intended to cross the boundary of an ECU or whether it is intended not to cross the boundary of a single partition.

Table 7.33: VariableAccess

Enumeration	VariableAccessScopeEnum		
Package	M2::AUTOSARTemplates::SWComponentTemplate::SwcInternalBehavior::DataElements		
Note	This enumeration defines scopes for communication.		
Literal	Description		
communicationInter Ecu	This case is foreseen to express that the corresponding communication shall be considered inter-ECU, i.e. it will cross the ECU boundary. This is considered the default case. Tags: atp.EnumerationLiteralIndex=0		
communicationIntra Partition	This case is foreseen to express that the corresponding communication shall not cross the boundary of a partition. Tags: atp.EnumerationLiteralIndex=1		
interPartitionIntra Ecu	In this case the communication shall cross the boundaries of partitions within one ECU but it shall not cross the boundaries of the ECU itself. Tags: atp.EnumerationLiteralIndex=2		

Table 7.34: VariableAccessScopeEnum

[TPS_SWCT_01326] Constrain the scope of a specific communication [The purpose of the attribute [scope](#) of meta-class [VariableAccess](#) is to constrain the scope of the corresponding communication.

The main use-case for this ability is the development of a software-component where certain end-points of communication from or to the software-component are known to fulfill a certain constraint, e.g. execute within the same partition. ([RS_SWCT_00200](#))

[TPS_SWCT_01328] Default value of attribute [scope](#) [The default value of attribute [scope](#) is set to [communicationInterEcu](#).] ([RS_SWCT_00200](#))

[constr_1141] Applicability of the [scope](#) attribute [

The attribute [scope](#) of meta-class [VariableAccess](#) shall **only** be applied with respect to the aggregation of [VariableAccess](#) in the following roles:

- [dataReadAccess](#)
- [dataWriteAccess](#)

- `dataSendPoint`
- `dataReceivePointByValue`
- `dataReceivePointByArgument`

]

This aspect is depicted in Figure 7.20.

7.5.1.3 Explicit Sending and Receiving

[TPS_SWCT_01330] RunnableEntity can also have dataSendPoints [A `RunnableEntity` can also have `dataSendPoints` (i.e. aggregate `VariableAccess` in the role `dataSendPoint`).

Using an `instanceRef` association, these eventually reference a `VariableDataPrototype` in the context of an `AbstractProvidedPortPrototype`, owned by the `AtomicSwComponentType` that is associated with the `RunnableEntity` that in turn owns the `dataSendPoint`.] (*RS_SWCT_00200*)

[constr_2004] Referenced VariableDataPrototype from AutosarVariableRef of VariableAccess in role dataSendPoint [A `VariableAccess` in the role `dataSendPoint` shall refer to a `PPortPrototype` or `PRPortPrototype` that is typed by either a `SenderReceiverInterface` or a `NvDataInterface`.] ()

[TPS_SWCT_01331] dataWriteAccess vs. dataSendPoint [As opposed to the `dataWriteAccess`:

- Using the `dataSendPoint`, the `RunnableEntity` needs to explicitly “send” through an API; when using a `dataWriteAccess`, the `RunnableEntity` only needs to modify the value of certain variables.
- Using `dataSendPoint`, the `Runnable` can decide to “send” an arbitrary number of times; when using `dataWriteAccess` the new value of the `VariableDataPrototype` is only made available after the `RunnableEntity` terminates.
- The presence of a `dataSendPoint` per definition lets the corresponding `RunnableEntity` attain cat. 1B.

] (*RS_SWCT_00200*)

[TPS_SWCT_01663] dataReadAccess vs. dataReceivePointByValue or dataReceivePointByArgument [As opposed to the `dataReadAccess`:

- Using the `dataReceivePointByValue` or `dataReceivePointByArgument`, the `RunnableEntity` always “receives” the latest value of the `dataElement` for each call to the respective API during the execution of the `RunnableEntity`.

This aspect is visualized in Figure 7.22.

[constr_1277] SwDataDefProps.swImplPolicy of a VariableDataPrototype referenced by a VariableAccess aggregated in the role dataReceivePointByValue [The SwDataDefProps.swImplPolicy of a VariableDataPrototype referenced by a VariableAccess aggregated in the role dataReceivePointByValue shall not be set to queued.]()

Rationale for [constr_1277]: when using the return value of the applicable RTE API function to return the value of a VariableDataPrototype there is no way⁴ to provide an indication that the queue is empty. Therefore, the only safe approach is to not permit this scenario at all, hence the constraint.

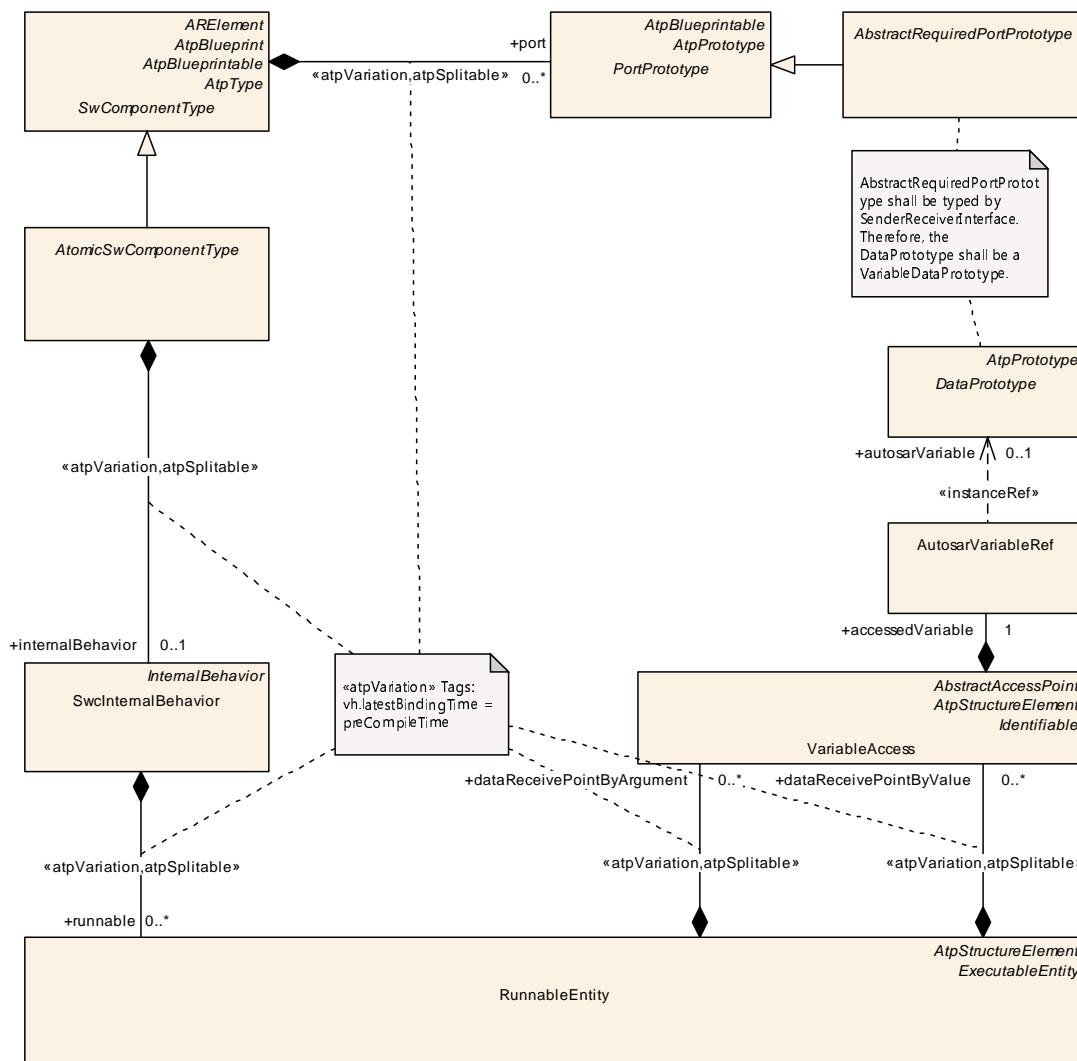

Figure 7.22: Definition of an explicit request to receive data

⁴That is, other than to use a function argument to return the status of the queue but that would obviously beat the purpose of the API function.

[TPS_SWCT_01333] dataReceivePointByValue/dataReceivePointByArgument vs. dataReadAccess [By using a `dataReceivePointByValue` or `dataReceivePointByArgument` instead of `dataReadAccess` the constraining access to the referenced `VariableDataPrototype` (other `RunnableEntity`s shall not change the `VariableDataPrototype` during the read execution) is limited to a short, well-defined amount of time.] (*RS_SWCT_00200*)

[TPS_SWCT_01334] RunnableEntitys of category 1 may have dataReceivePointByValues/dataReceivePointByArguments [Therefore, category 1 `RunnableEntity`s may also have `dataReceivePointByValues/dataReceivePointByArguments` and consequently become `RunnableEntity`s of category 1B] (*RS_SWCT_00200*)

Please note that the categories of `RunnableEntity` are explained in section 7.2.4.4.

Similar to the `dataReadAccess`, constraints apply to the reference target of the `AutosarVariableRef` of `VariableAccess` in role `dataReceivePointByValue` or `dataReceivePointByArgument`.

[constr_2005] Referenced VariableDataPrototype from AutosarVariableRef of VariableAccess in role dataReceivePointByValue or dataReceivePointByArgument [A `VariableAccess` in the role `dataReceivePointByValue` or `dataReceivePointByArgument` shall refer to an `RPortPrototype` or `PRPortPrototype` that is typed by either a `SenderReceiverInterface` or an `NvDataInterface`.] ()

[TPS_SWCT_01335] Combine dataReceivePointByValue or dataReceivePointByArgument with a WaitPoint [In general, it is possible to combine a `dataReceivePointByValue` or `dataReceivePointByArgument` with a `WaitPoint` in the scope of a particular `RunnableEntity`.

This allows for a call to a blocking receive routine implemented by the RTE. The `timeout` attribute of meta-class `WaitPoint` can be used to specify the time until the blocking call expires.

But in case of non-queued communication it is **not supported** that a `DataReceivedEvent` is used in combination with a `WaitPoint` (see [constr_2021]). This contradicts the approach of the last-is-best semantics.] (*RS_SWCT_00200*)

[constr_2021] WaitPoint referencing a DataReceivedEvent can not be used for non-queued communication [A `WaitPoint` referencing a `DataReceivedEvent` is permitted if and only if the `swImplPolicy` of the `VariableDataPrototype` referenced by this `DataReceivedEvent` is set to `queued`.] ()

Please note however, that in this case (in response to the presence of a `WaitPoint`) the `RunnableEntity` becomes category 2.

7.5.1.4 Implicit Sending and Receiving

Implicit sending and receiving aims at the optimization of computation effort for sender-receiver communication.

Instead of executing the full amount of functionality for each call to a send-API or receive-API the implicit communication only receives implicitly received values latest before the start of the execution of a `RunnableEntity` and sends implicitly sent values earliest after termination of the `RunnableEntity`.

[TPS_SWCT_01329] Access to specific data is implemented by means of aggregating the meta-class `VariableAccess` in specific roles [Please note that from the formal point of view access to specific data is implemented by means of aggregating the meta-class `VariableAccess` in specific roles.

This means that `dataReadAccess` for a read-access while the write-access is defined by means of aggregating `VariableAccess` in the role `dataWriteAccess`.] (*RS_SWCT_00200*)

This aspect is depicted in Figure 7.19.

The following constraints apply to the reference target of the `AutosarVariableRef` of `VariableAccess` in role `dataReadAccess` or `dataWriteAccess`.

[constr_2002] Referenced `VariableDataPrototype` from `AutosarVariableRef` of `VariableAccess` in role `dataReadAccess` [A `VariableAccess` in the role `dataReadAccess` shall refer to an `RPortPrototype` or `PRPortPrototype` that is typed by either a `SenderReceiverInterface` or a `NvDataInterface`.] ()

[constr_2003] Referenced `VariableDataPrototype` from `AutosarVariableRef` of `VariableAccess` in role `dataWriteAccess` [A `VariableAccess` in the role `dataWriteAccess` shall refer to a `PPortPrototype` or `PRPortPrototype` that is typed by either a `SenderReceiverInterface` or a `NvDataInterface`.] ()

By access with `VariableAccess` in the `dataReadAccess` role always the last value of the `VariableDataPrototype` buffered before the `RunnableEntity` starts will be read during the execution of the `RunnableEntity`.

It would therefore not make any sense to provide a queue of values for the purpose of accessing a `dataElement` in the role `dataReadAccess`.

[constr_2020] `dataReadAccess` can not be used for queued communication [The `swImplPolicy` of the `VariableDataPrototype` referenced by a `VariableAccess` in role `dataReadAccess` shall **not** be set to `queued`.] ()

[constr_1256] Acknowledgement feedback in n:1 writer case [Within the scope of one `SwcInternalBehavior`, it is **not** allowed that two or more aggregated `RunnableEntities` own either `dataSendPoints` or `dataWriteAccesses` that in turn point to the identical `accessedVariable.autosarVariable.targetDataPrototype` if the attribute `transmissionAcknowledge` exists in the context of the

`SenderComSpec` owned by the `dataSendPoint.accessedVariable.autosar-Variable.portPrototype` (or the respective construct for `dataWriteAccess`) that also refers to said `dataElement`.]()

The background of [constr_1256] is that if two or more `RunnableEntity`s exist that can write to the identical `dataElement` it may happen that more than one `RunnableEntity` actually write to the respective `dataElement` **before** the “first” acknowledgement is received. In this case it will never be possible to determine exactly which transmission has been acknowledged.

The difference between implicit and explicit sender/receiver communication is explained in [TPS_SWCT_01331] and [TPS_SWCT_01663].

7.5.1.5 DataSendCompletedEvent

[TPS_SWCT_01336] `dataSendPoint` also allows for the definition of a `DataSendCompletedEvent` [The `dataSendPoint` also allows for the definition of a `DataSendCompletedEvent`. This `RTEEvent` occurs when the data has been successfully sent or when an error has occurred during sending.] (*RS_SWCT_00200*)

Please note that this feature can only be used if the `AtomicSwComponentType` describes the meaning of success or failure of the send-operation.

In particular, via a `SenderComSpec` class different acknowledgement requests (in this case: successful transmission) can be attached to a `PPortPrototype` or `PRPortPrototype`, as is shown in Figure 4.34.

This will configure the RTE such that when data is sent the RTE will try to obtain the specified acknowledgement; possibly by waiting a certain `timeout` period.

[constr_2033] **Timeout of `DataSendCompletedEvent`** [The `timeout` value of a `WaitPoint` associated with a `DataSendCompletedEvent` shall have the same value as the corresponding value of `TransmissionAcknowledgementRequest.timeout`.]()

7.5.1.6 DataWriteCompletedEvent

[TPS_SWCT_01557] `dataWriteAccess` also allows for the definition of a `DataWriteCompletedEvent` [The `dataWriteAccess` also allows for the definition of a `DataWriteCompletedEvent`. This `RTEEvent` occurs when the data has been successfully sent or when an error has occurred during sending.] (*RS_SWCT_00200*)

Please note that this feature can only be used if the `AtomicSwComponentType` describes the meaning of success or failure of the send-operation.

7.5.1.7 DataReceivedEvent

[TPS_SWCT_01337] **DataReceivedEvent** [A receiver is notified through the same event mechanism when a **VariableDataPrototype** is received. The **DataReceivedEvent** is directly associated with the corresponding **VariableDataPrototype**.] (RS_SWCT_00200)

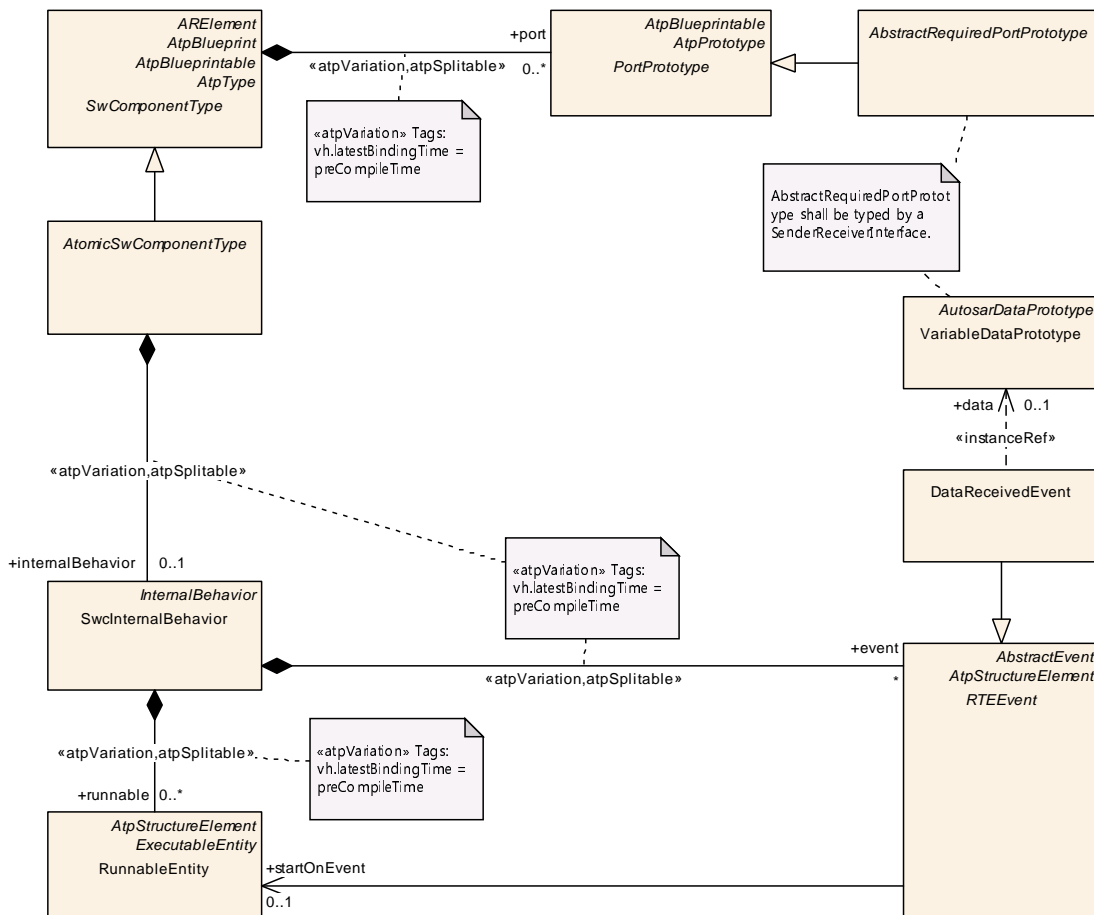

Figure 7.24: Receiver is notified by an event when new data has arrived

7.5.1.8 DataReceiveErrorEvent

[TPS_SWCT_01338] **DataReceiveErrorEvent** [A receiver is notified of **DataReceiveErrorEvent** through the activation of its **RunnableEntity** which is referenced by this **RTEEvent**. A **DataReceiveErrorEvent** includes a reference to a **VariableDataPrototype** and is raised by the RTE when an error concerning the reception of the referenced data is detected by the COM⁵ layer. The following cases present some situations which will cause the RTE to raise a **DataReceiveErrorEvent**:

⁵In case of internal communication the RTE is not enforced to use the COM layer. It is also possible to implement the required behavior directly in the RTE.

- the RTE receives a signal-outdated notification from the COM layer when a monitored periodic signal is not received in time. The COM layer monitors the validity of the signal's value based on the value of the `aliveTimeout` attribute of `ReceiverComSpec` referencing the `VariableDataPrototype` associated with the signal. If the time elapsed since the last update of a signal's value exceeds its `aliveTimeout` then the COM layer notifies the RTE of a signal outdated error.
- The RTE receives a signal invalid notification from the COM layer when the COM layer detects that an incoming signal has the predefined "invalid" value.

]([RS_SWCT_00200](#))

[TPS_SWCT_01339] RTE activates `RunnableEntity` in response to `DataReceiveErrorEvent` [A `DataReceiveErrorEvent` is used by the RTE to activate a `RunnableEntity` that is supposed to handle the above-mentioned errors.

The error code will be made available to the activated `RunnableEntity` through the appropriate RTE API function.]([RS_SWCT_00200](#))

[TPS_SWCT_01340] `DataReceiveErrorEvent` cannot be combined with a `WaitPoint` [Please note that a `DataReceiveErrorEvent` cannot be associated with a `WaitPoint`, see [[constr_1091](#)].

It can only be used for the receiver software-component in a sender-receiver communication and its data reference is restricted to `VariableDataPrototypes` with their `swImplPolicy` attribute not set to `queued`.]([RS_SWCT_00200](#))

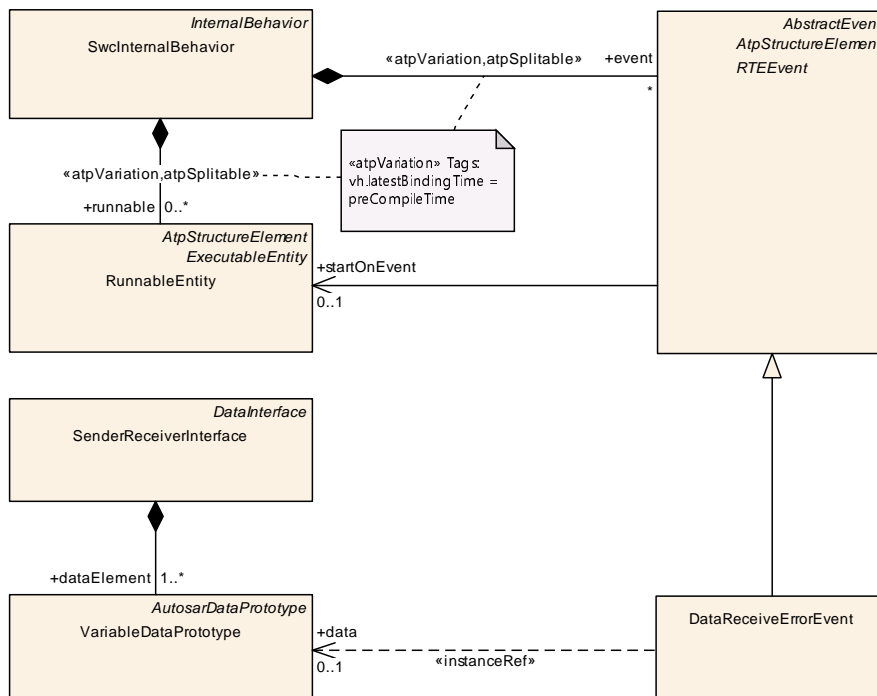

Figure 7.25: `DataReceiveErrorEvent` references a `Runnable` and a `VariableDataPrototype`

[TPS_SWCT_01341] **DataReceiveErrorEvent** is directly associated with the corresponding **VariableDataPrototype** [The `DataReceiveErrorEvent` is directly associated with the corresponding `VariableDataPrototype` and references the `RunnableEntity` that is activated due to the occurrence of this `RTEEvent`.] ([RS_SWCT_00200](#))

This aspect is depicted in Figure 7.25.

7.5.2 RunnableEntities and Client Server Communication

7.5.2.1 Invoking an Operation

[TPS_SWCT_01342] **Invocation of a server operation** [A `RunnableEntity` invokes a server operation formally defined as a `ClientServerOperation` via an `RPortPrototype` of the enclosing `SwComponentPrototype` typed by a particular `AtomicSwComponentType`.] ([RS_SWCT_00200](#))

[TPS_SWCT_01343] **Synchronous vs. asynchronous invocation** [A `ClientServerOperation` itself can be invoked either “synchronously” or “asynchronously”.] ([RS_SWCT_00200](#))

In the majority of cases the `ClientServerOperation` will be invoked at a different `SwComponentPrototype` but in general it would be possible to invoke a `ClientServerOperation` on the same `SwComponentPrototype` as well.

The decision whether a specific `ClientServerOperation` is called synchronously or asynchronously needs to be specified in the formal description of the corresponding `AtomicSwComponentType`, namely in the context of an `SwcInternalBehavior` (see Figure 7.26 for more details).

But it is not supported to invoke the same instance of a `ClientServerOperation` synchronously and asynchronously together.

[constr_2022] **Mutually exclusive use of SynchronousServerCallPoints and AsynchronousServerCallPoints** [A `ClientServerOperation` of a particular `RPortPrototype` shall be mutually exclusive referenced by either a `SynchronousServerCallPoints` or an `AsynchronousServerCallPoints`.] ()

[constr_2023] **Consistency of timeout values** [The `timeout` values of all `ServerCallPoints` referencing the same instance of `ClientServerOperation` in a `RPortPrototype` shall be identical.] ()

[TPS_SWCT_01345] **Synchronous operation invocation** [In case of a synchronous operation invocation the particular `RunnableEntity` merely needs a `SynchronousServerCallPoint`.] ([RS_SWCT_00200](#))

More information can be found in Figure 7.26.

[TPS_SWCT_01346] **Asynchronous operation invocation** [Asynchronous invocation is a bit more complex because it is necessary to specify how to respond to a notification about the completion of the corresponding operation.

This is done using the generic `RTEEvent` mechanism: the notification about an asynchronously executed operation having completed is implemented as an `AsynchronousServerCallReturnsEvent`.

Therefore, if an `AsynchronousServerCallReturnsEvent` is raised the RTE can either trigger the execution of a specific `RunnableEntity` or the `AtomicSwComponentType` can implement a `WaitPoint` that blocks the execution of the calling `RunnableEntity` until the `AsynchronousServerCallReturnsEvent` is recognized.] (*RS_SWCT_00200*)

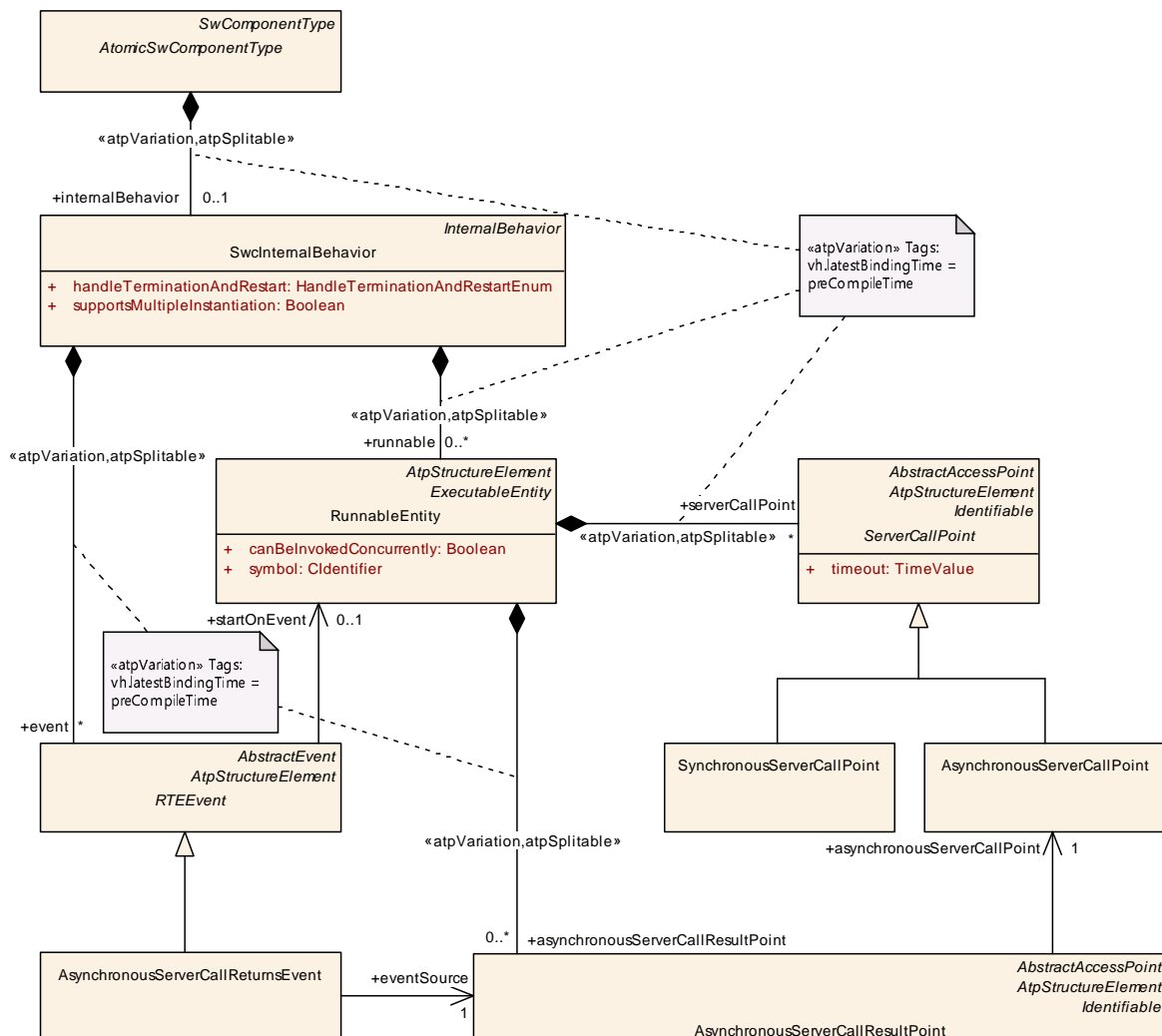

Figure 7.26: Model of a server call point.

For example, let's consider the case of an asynchronous call to a remote operation where the RTE is supposed to trigger a specific `RunnableEntity` when the operation completes. The description of the corresponding `AtomicSwComponentType` would typically contain the following elements:

1. The `AtomicSwComponentType` contains an `RPortPrototype` 'myPort' typed by a `PortInterface` that in turn contains the definition of an `ClientServerOperation` 'remoteOperation'.
2. The `AtomicSwComponentType`'s `SwcInternalBehavior` contains at least two `RunnableEntities`: the `RunnableEntity` 'main' is supposed to invoke the operation; the `RunnableEntity` 'callback' is the one that should be called when the operation completes.
3. The description of the `RunnableEntity` 'main' contains an `AsynchronousServerCallPoint` 'invokeMyOperation' referencing the respective `ClientServerOperation` in the `PortInterface` used to type the `PortPrototype` 'myPort'. This implies that the `RunnableEntity` is allowed to invoke this operation asynchronously.
4. The description of the `RunnableEntity` 'callback' contains an `AsynchronousServerCallResultPoint` 'fetchMyOperationResults' referencing the respective `AsynchronousServerCallPoint` 'invokeMyOperation'. This implies that the `RunnableEntity` is allowed to fetch the results of the asynchronously invoked operation.
5. The description of the `SwcInternalBehavior` includes an `AsynchronousServerCallReturnsEvent` 'myOperationReturns' which references the previously defined `AsynchronousServerCallResultPoint` 'fetchMyOperationResults'.
6. The description of the `AsynchronousServerCallReturnsEvent` 'myOperationReturns' references the `RunnableEntity` 'callback', indicating that the RTE should trigger the execution of this Runnable when 'myOperationReturns' is raised.

Class	ServerCallPoint (abstract)			
Package	M2::AUTOSARTemplates::SWComponentTemplate::SwcInternalBehavior::ServerCall			
Note	If a RunnableEntity owns a ServerCallPoint it is entitled to invoke a particular ClientServerOperation of a specific RPortPrototype of the corresponding AtomicSwComponentType			
Base	<i>ARObject</i> , <i>AbstractAccessPoint</i> , <i>AtpClassifier</i> , <i>AtpFeature</i> , <i>AtpStructureElement</i> , <i>Identifiable</i> , <i>MultilanguageReferrable</i> , <i>Referrable</i>			
Subclasses	<i>AsynchronousServerCallPoint</i> , <i>SynchronousServerCallPoint</i>			
Attribute	Type	Mult.	Kind	Note
operation	<code>ClientServerOperation</code>	0..1	iref	The operation that is called by this runnable.
timeout	<code>TimeValue</code>	1	attr	Time in seconds before the server call times out and returns with an error message. It depends on the call type (synchronous or asynchronous) how this is reported.

Table 7.35: ServerCallPoint

Class	SynchronousServerCallPoint			
Package	M2::AUTOSARTemplates::SWComponentTemplate::SwcInternalBehavior::ServerCall			
Note	This means that the RunnableEntity is supposed to perform a blocking wait for a response from the server.			
Base	ARObject, AbstractAccessPoint , AtpClassifier, AtpFeature, AtpStructureElement, Identifiable , MultilanguageReferrable , Referrable , ServerCallPoint			
Attribute	Type	Mult.	Kind	Note
calledFrom WithinExclusive Area	ExclusiveAreaNesting Order	0..1	ref	This indicates that the call point is located at the deepest level inside one or more ExclusiveAreas that are nested in the given order.

Table 7.36: SynchronousServerCallPoint

Class	AsynchronousServerCallPoint			
Package	M2::AUTOSARTemplates::SWComponentTemplate::SwcInternalBehavior::ServerCall			
Note	An AsynchronousServerCallPoint is used for asynchronous invocation of a ClientServerOperation. IMPORTANT: a ServerCallPoint cannot be used concurrently. Once the client RunnableEntity has made the invocation, the ServerCallPoint cannot be used until the call returns (or an error occurs!) at which point the ServerCallPoint becomes available again.			
Base	ARObject, AbstractAccessPoint , AtpClassifier, AtpFeature, AtpStructureElement, Identifiable , MultilanguageReferrable , Referrable , ServerCallPoint			
Attribute	Type	Mult.	Kind	Note
–	–	–	–	–

Table 7.37: AsynchronousServerCallPoint

Class	AsynchronousServerCallResultPoint			
Package	M2::AUTOSARTemplates::SWComponentTemplate::SwcInternalBehavior::ServerCall			
Note	If a RunnableEntity owns a AsynchronousServerCallResultPoint it is entitled to get the result of the referenced AsynchronousServerCallPoint. If it is associated with AsynchronousServerCallReturnsEvent, this RTEEvent notifies the completion of the required ClientServerOperation or a timeout. The occurrence of this event can either unblock a WaitPoint or can lead to the invocation of a RunnableEntity.			
Base	ARObject, AbstractAccessPoint , AtpClassifier, AtpFeature, AtpStructureElement, Identifiable , MultilanguageReferrable , Referrable			
Attribute	Type	Mult.	Kind	Note
asynchronous ServerCallPoint	AsynchronousServer CallPoint	1	ref	The referenced Asynchronous Server Call Point defines the asynchronous server call from which the results are returned.

Table 7.38: AsynchronousServerCallResultPoint

[constr_2006] Number of [AsynchronousServerCallResultPoint](#) referencing to one [AsynchronousServerCallPoint](#) [The [AsynchronousServerCallPoint](#) may be referenced by at most one [AsynchronousServerCallResultPoint](#).

If the reference exists, this means that only the [RunnableEntity](#) with this [AsynchronousServerCallResultPoint](#) can fetch the result of the asynchronous server invocation of this particular [AsynchronousServerCallPoint](#).|()

Please note that if an `AsynchronousServerCallPoint` is **not** referenced by an `AsynchronousServerCallResultPoint` this means that there is no operation result to fetch or the caller **is not interested** in the result.

This information might be used by the RTE generator to optimize the data consistency mechanisms.

[TPS_SWCT_01347] Blocking access to operation result in an asynchronous operation invocation [If the call of the RTE fetching the operations results shall block until the server returns, the `RunnableEntity` with the `AsynchronousServerCallResultPoint` needs additional a `WaitPoint` referencing the `AsynchronousServerCallReturnsEvent` which is associated with the `AsynchronousServerCallResultPoint` representing the operations results access.

In this case the `AsynchronousServerCallReturnsEvent` shall not define a `startOnEvent` reference to a `RunnableEntity`.] (*RS_SWCT_00200*)

[constr_2030] AsynchronousServerCallResultPoint combined with WaitPoint shall belong to the same RunnableEntity [A `WaitPoint` referencing a `AsynchronousServerCallReturnsEvent` as well as a `AsynchronousServerCallResultPoint` referenced by said `AsynchronousServerCallReturnsEvent` shall be aggregated by the same `RunnableEntity`.] ()

[constr_1521] Reference from AsynchronousServerCallReturnsEvent to AsynchronousServerCallResultPoint [In the context of a `RunnableEntity`, a given `AsynchronousServerCallResultPoint` shall only be referenced by one `AsynchronousServerCallReturnsEvent` in the role `eventSource`.] ()

7.5.2.2 Providing an Implementation of an Operation

A software-component can define an `OperationInvokedEvent` for each operation inside one of the server `AbstractProvidedPortPrototypes`. This way a `RunnableEntity` may respond to such an invocation through the generic event handling mechanisms described above (as formally expressed in Figure 7.27).

this server `RunnableEntity` or trigger sink `RunnableEntity` cannot be started because the re-transformed data are not available.] ([RS_SWCT_03222](#))

This might be a problem for the software-component if the software-component wants to react on transformer errors.

[TPS_SWCT_01616] Semantics of `TransformerHardErrorEvent` [A software-component can define a `TransformerHardErrorEvent`

- for each `ClientServerOperation` inside one of the server `PPortPrototypes` (i.e. typed by a `ClientServerInterface`) or
- for each `Trigger` in trigger sink `RPortPrototypes` (i.e. typed by a `TriggerInterface`).

This way, a given `RunnableEntity` may define its response to a transformer error.] ([RS_SWCT_03222](#))

7.5.3 RunnableEntities and External Trigger Event Communication

7.5.3.1 Trigger Source

[TPS_SWCT_01348] Trigger source [A `RunnableEntity` of the triggering software-component raises an external trigger event via an `AbstractProvidedPortPrototype` of the enclosing `SwComponentPrototype` typed by a particular `AtomicSwComponentType`.

For this purpose the particular `RunnableEntity` needs an `ExternalTriggeringPoint` that references the particular instance of the trigger in a `PPortPrototype`.] ([RS_SWCT_00200](#))

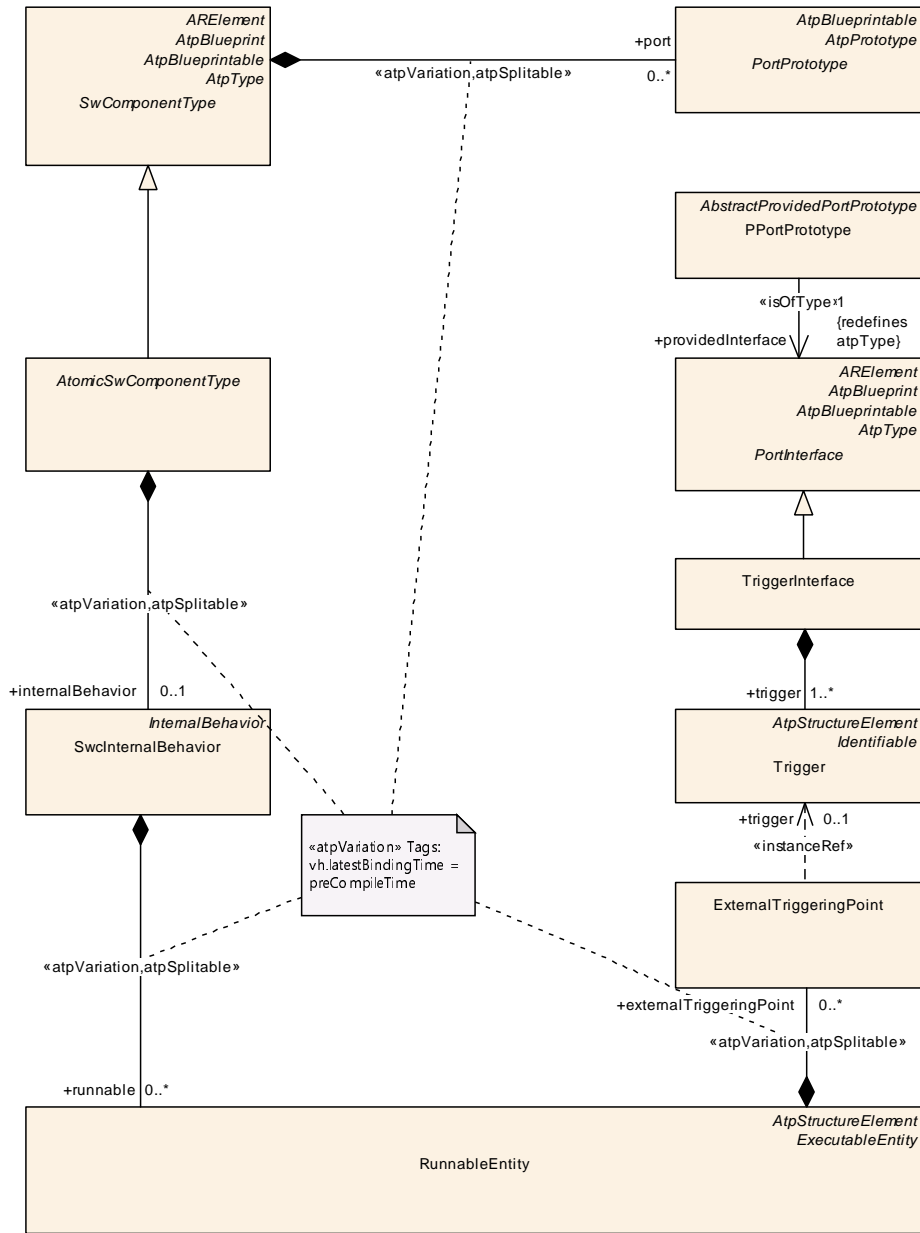

Figure 7.28: Model structure of a trigger source.

Class	ExternalTriggeringPoint			
Package	M2::AUTOSARTemplates::SWComponentTemplate::SwcInternalBehavior::Trigger			
Note	If a RunnableEntity owns an ExternalTriggeringPoint it is entitled to raise an ExternalTriggerOccurred Event.			
Base	ARObject			
Attribute	Type	Mult.	Kind	Note





Class	ExternalTriggeringPoint			
ident	ExternalTriggeringPoint Ident	0..1	aggr	<p>The aggregation in the role ident provides the ability to make the ExternalTriggeringPoint identifiable.</p> <p>From the semantical point of view, the ExternalTriggeringPoint is considered a first-class Identifiable and therefore the aggregation in the role ident shall always exist (until it may be possible to let ModeAccessPoint directly inherit from Identifiable).</p> <p>Tags: atp.Status=shallBecomeMandatory xml.sequenceOffset=-100</p>
trigger	Trigger	0..1	iref	<p>The trigger taken for the ExternalTriggeringPoint.</p> <p>Tags: xml.namePlural=TRIGGER-IREF xml.roleElement=false xml.roleWrapperElement=true xml.typeElement=true xml.typeWrapperElement=false</p>

Table 7.39: ExternalTriggeringPoint

7.5.3.2 Trigger Sink

The activation of [RunnableEntity](#)s in the trigger sink is effected through the generic event handling mechanism.

[TPS_SWCT_01349] Trigger sink [The fact that a [RunnableEntity](#) shall be activated on occurrence of an external trigger event is formally defined by means of [ExternalTriggerOccurredEvent](#) that references a particular instance of the trigger in a [RPortPrototype](#) and additionally the [RunnableEntity](#) to be executed in response to the event.] ([RS_SWCT_00200](#))

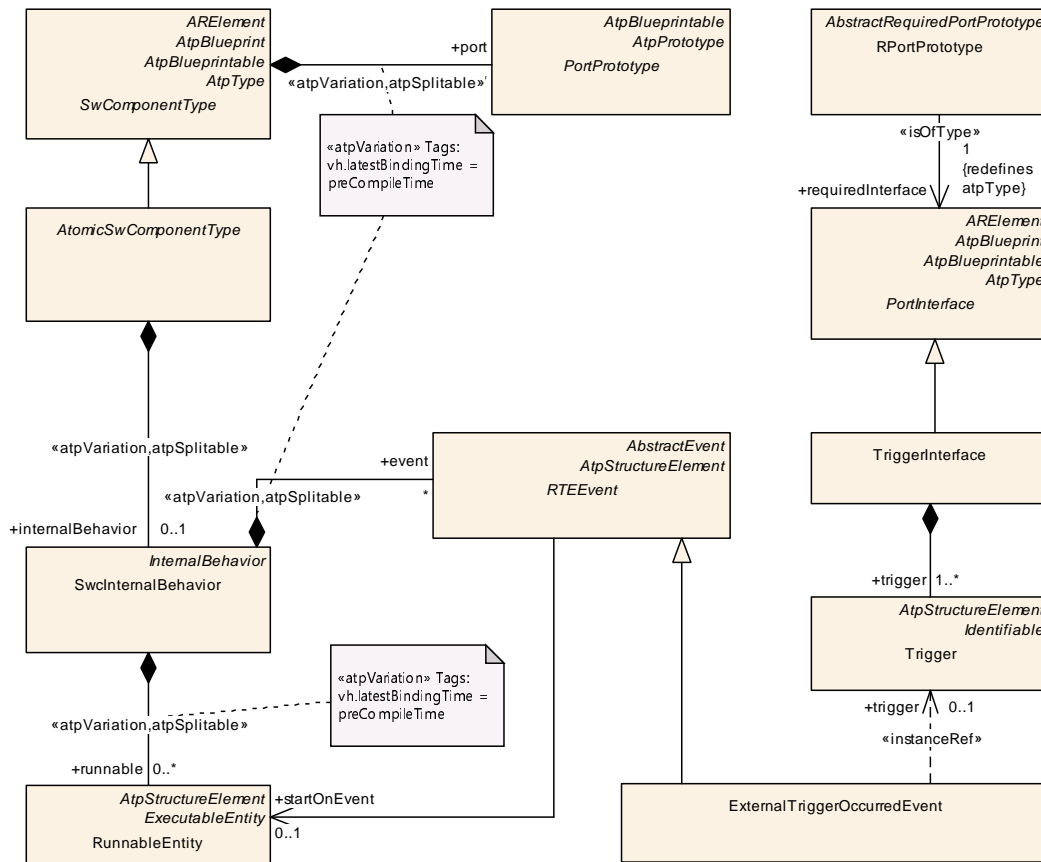

Figure 7.29: Model structure of a trigger sink

7.5.4 RunnableEntities and Parameter Access

There are several ways a Calibration Parameter is provided within a software component.

[TPS_SWCT_01350] Calibration Parameters shared among several *SwComponentTypes* [As mentioned above, if Calibration Parameters are shared among several *SwComponentTypes* a dedicated *PortInterface* in a *PortPrototype* will be used.] (*RS_SWCT_00200*)

The designer of a software-component can use this access mechanism when designing a *RunnableEntity* using, as input value, a *DataPrototype*

- from an arbitrary *RPortPrototype* associated with a *ClientServerInterface*, *SenderReceiverInterface* or a *NvDataInterface*,
- *VariableDataPrototype* in the context of an *SwcInternalBehavior*

This input value will be fed to an interpolation routine whose result can be used internally or transferred to an adjacent *SwComponentPrototype* via dedicated *PortPrototypes*. Typically, there will be a dedicated *RunnableEntity* (with “ReceiveMode”

Class	ParameterAccess			
Package	M2::AUTOSARTemplates::SWComponentTemplate::SwcInternalBehavior::DataElements			
Note	The presence of a ParameterAccess implies that a RunnableEntity needs access to a ParameterData Prototype.			
Base	<i>ARObject</i> , <i>AbstractAccessPoint</i> , <i>AtpClassifier</i> , <i>AtpFeature</i> , <i>AtpStructureElement</i> , <i>Identifiable</i> , <i>MultilanguageReferrable</i> , <i>Referrable</i>			
Attribute	Type	Mult.	Kind	Note
accessed Parameter	AutosarParameterRef	1	aggr	Reference to the accessed calibration parameter.
swDataDef Props	SwDataDefProps	0..1	aggr	This allows denote instance and access specific properties, mainly input values and common axis.

Table 7.40: ParameterAccess

[TPS_SWCT_01351] Access to a [ParameterDataPrototype](#) [The access to a [ParameterDataPrototype](#) will be indicated

- by the [ParameterAccess](#) entity if the [RunnableEntity](#) wants to access it from a [RPortPrototype](#).
- by defining the [ParameterAccess](#) association from a [RunnableEntity](#) to the [ParameterDataPrototype](#) in the roles [sharedParameter](#) or [perInstanceParameter](#).

]([RS_SWCT_00200](#))

Please find more information about the topic of [TPS_SWCT_01351] in Figure 7.30 as well as in Figure 2.3 in the lower association from [RunnableEntity](#) to [ParameterDataPrototype](#)

Note: A [ParameterDataPrototype](#) in the roles [constantMemory](#) is not provided by the RTE and therefore the [ParameterAccess](#) association is not required to control the RTE API generation.

7.5.4.1 InstantiationDataDefProps

Typically, the accessibility and further information like alias names for a particular piece of data is modeled on the level of [DataPrototypes](#) (especially [VariableDataPrototypes](#), [ParameterDataPrototypes](#)).

But due to the recursive structure of the meta-model concerning data types (an [ApplicationCompositeDataType](#) consists of [DataPrototypes](#)), a part of the relevant MCD information is described directly in the data type (in case of a [ApplicationCompositeDataType](#)).

This is a strong restriction in the re-use of data types because the [ApplicationCompositeDataType](#) should be re-used for different [VariableDataPrototypes](#) and [ParameterDataPrototypes](#) to guarantee type compatibility on C-implementation

level (e.g. data of a [PortPrototype](#) is stored in a PIM or a [ParameterDataPrototype](#) used as ROM Block and shall be typed by the same data type as NVRAM Block).

This restriction is overcome by [InstantiationDataDefProps](#) as shown in figure 7.31

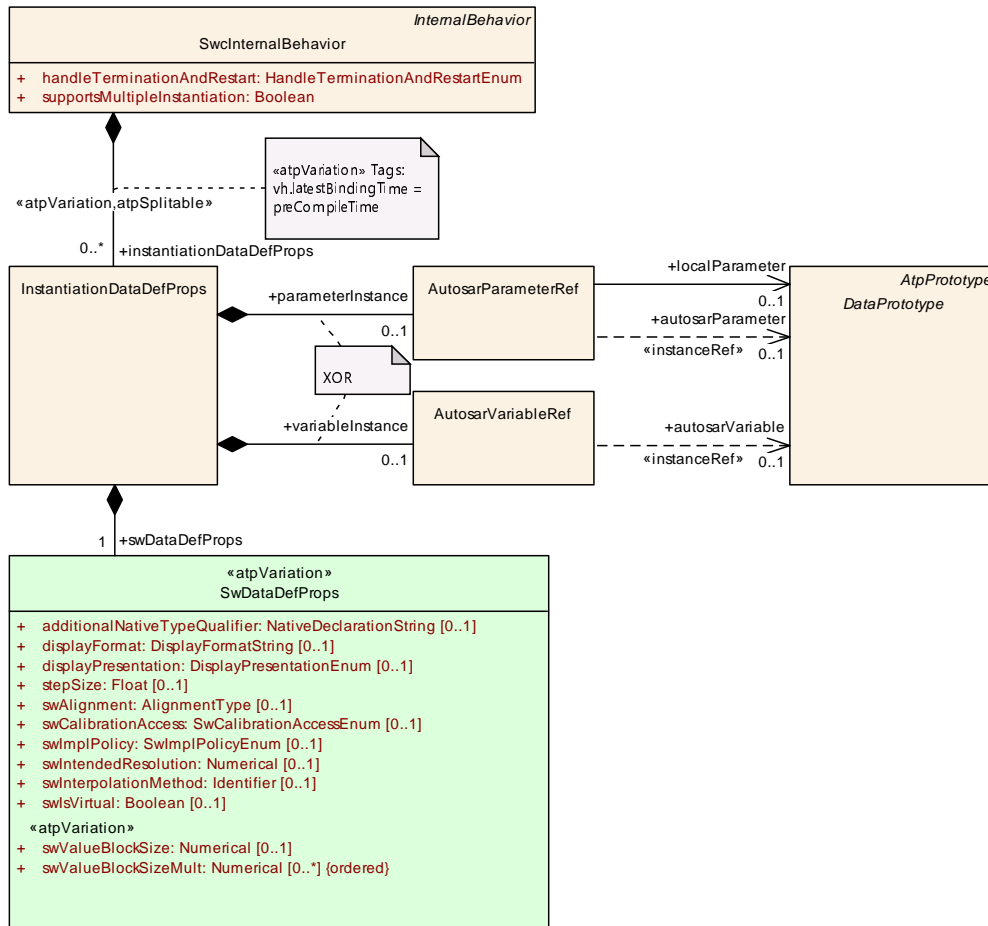

Figure 7.31: applying instantiation specific data definition properties

Class	InstantiationDataDefProps
Package	M2::AUTOSARTemplates::SWComponentTemplate::SwcInternalBehavior::InstantiationDataDefProps
Note	<p>This is a general class allowing to apply additional SwDataDefProps to particular instantiations of a Data Prototype.</p> <p>Typically the accessibility and further information like alias names for a particular data is modeled on the level of DataPrototypes (especially VariableDataPrototypes, ParameterDataPrototypes). But due to the recursive structure of the meta-model concerning data types (a composite (data) type consists out of data prototypes) a part of the MCD information is described in the data type (in case of Application CompositeDataType).</p>



Class		InstantiationDataDefProps		
	This is a strong restriction in the reuse of data typed because the data type should be re-used for different VariableDataPrototypes and ParameterDataPrototypes to guarantee type compatibility on C-implementation level (e.g. data of a Port is stored in PIM or a ParameterDataPrototype used as ROM Block and shall be typed by the same data type as NVRAM Block). This class overcomes such a restriction if applied properly.			
Base	ARObject			
Attribute	Type	Mult.	Kind	Note
parameter Instance	AutosarParameterRef	0..1	aggr	This is the particular ParameterDataPrototypes on which the swDataDefProps shall be applied.
swDataDef Props	SwDataDefProps	1	aggr	These are the particular data definition properties which shall be applied
variableInstance	AutosarVariableRef	0..1	aggr	This is the particular VariableDataPrototypes on which the swDataDefProps shall be applied.

Table 7.41: InstantiationDataDefProps

7.5.5 RunnableEntities and Mode Communication

For the communication of modes between [RunnableEntities](#) we have to distinguish between two use cases.

[TPS_SWCT_01352] Requested mode is just sent and received as an ordinary data value [In the first case, a requested mode is just sent and received as an ordinary data value without specifying the details of mode switching in the corresponding port interface.

This mechanism is used if the receiving [RunnableEntity](#) is not directly implementing a mode switch but does further processing of the mode request. This is especially needed to transfer mode requests between ECUs.

In this case, the mode is transferred via sender-receiver communication so that the involved [RunnableEntities](#) just need the same type of APIs against the RTE as for sender-receiver communication.

This is possible, because [ModeDeclarationGroupPrototypes](#) can be mapped to an [ImplementationDataTypes](#). ([RS_SWCT_00200](#))

This concept and the meta-classes needed for the mapping are further explained in chapter [4.2.5](#).

[TPS_SWCT_01353] RunnableEntities react on a mode request via a corresponding RTEEvent [In the second case, one [RunnableEntity](#) “sends” a mode request and one or more other [RunnableEntities](#) react on the request via a corresponding [RTEEvent](#) or by being suppressed from being triggered any longer by other [RTEEvents](#).

In this case, special APIs against the RTE are required and the RTE has to implement the actual mode switch. This kind of communication is only possible between software-components on the same ECU. [\(RS_SWCT_00200, RS_SWCT_03202\)](#)

For further explanation of the general concept refer to chapter 4.2.5 and for the details of the meta-model for mode switches refer to chapter 9.

7.6 Port API Options

[\[TPS_SWCT_01354\]](#) **PortAPIOption** [The RTE Generator needs additional options per [PortPrototype](#) to choose the proper generation schema. These are subsumed in the [PortAPIOption](#) element.] ()

Please note that meta-class [PortAPIOption](#) is depicted in Figure 7.32.

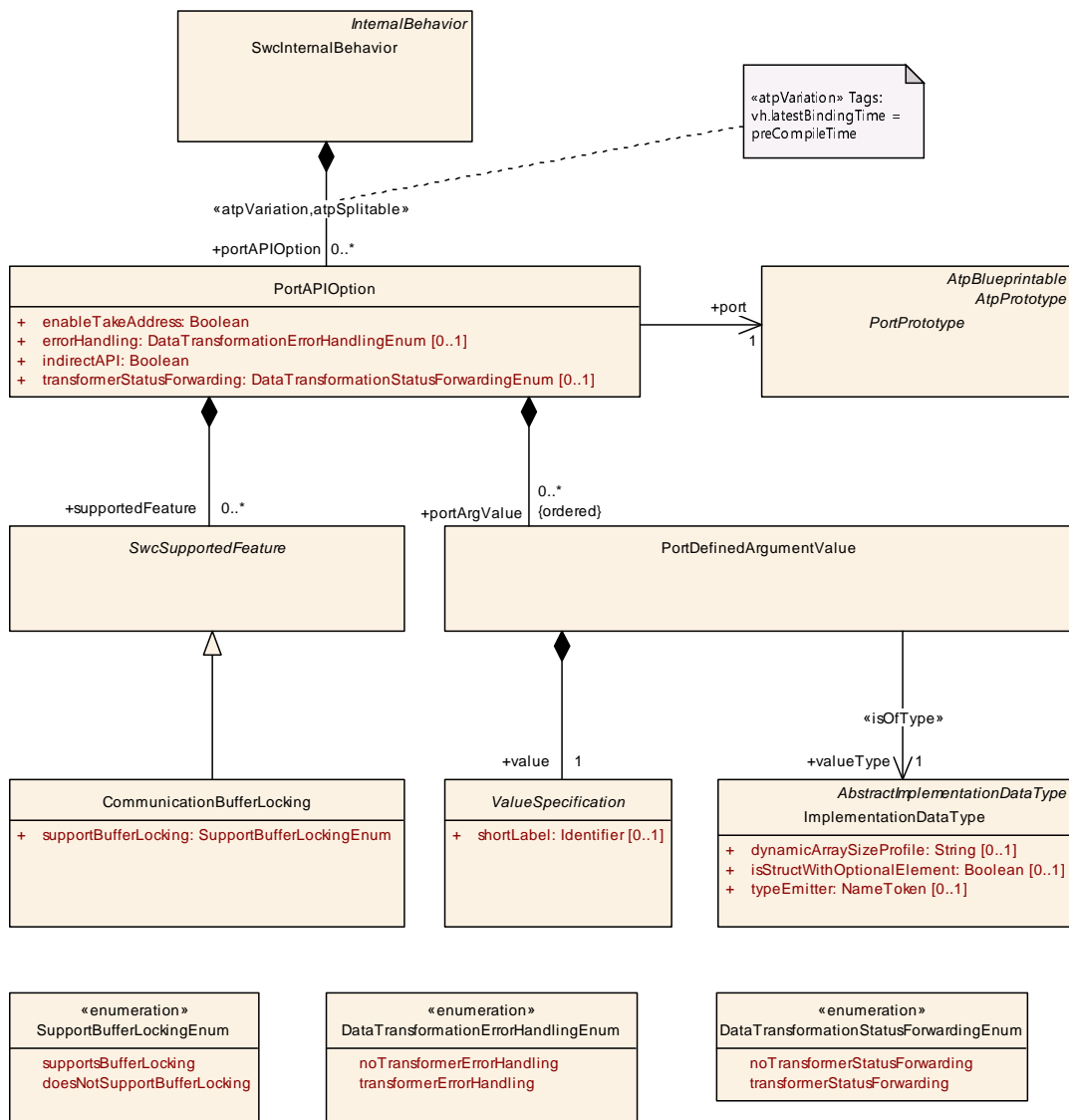

Figure 7.32: Port API Options.

Class	PortAPIOption			
Package	M2::AUTOSARTemplates::SWComponentTemplate::SwcInternalBehavior::PortAPIOptions			
Note	Options how to generate the signatures of calls for an AtomicSwComponentType in order to communicate over a PortPrototype (for calls into a RunnableEntity as well as for calls from a RunnableEntity to the PortPrototype).			
Base	ARObject			
Attribute	Type	Mult.	Kind	Note
enableTakeAddress	Boolean	1	attr	If set to true, the software-component is able to use the API reference for deriving a pointer to an object.
errorHandling	DataTransformationErrorHandlingEnum	0..1	attr	This specifies whether a RunnableEntity accessing a Port Prototype that is referenced by this PortAPIOption shall specifically handle transformer errors or not.
indirectAPI	Boolean	1	attr	If set to true this attribute specifies an "indirect API" to be generated for the associated port which means that the software-component is able to access the actions on a port via a pointer to an object representing a port. This allows e.g. iterating over ports in a loop. This option has no effect for PPortPrototypes of client/server interfaces.
port	PortPrototype	1	ref	The option is valid for generated functions related to communication over this port
portArgValue (ordered)	PortDefinedArgumentValue	*	aggr	An argument value defined by this port.
supportedFeature	SwcSupportedFeature	*	aggr	This collection specifies which features are supported by the RunnableEntitys which access a PortPrototype that it referenced by this PortAPIOption.
transformerStatusForwarding	DataTransformationStatusForwardingEnum	0..1	attr	This specifies whether a RunnableEntity accessing a Port Prototype that is referenced by this PortAPIOption shall be able to forward a status to the transformer chain. Tags: atp.Status=draft

Table 7.42: PortAPIOption

[TPS_SWCT_01626] Error notification of data transformer errors [If the attribute [PortAPIOption.errorHandling](#) is set to [transformerErrorHandling](#) then all [RunnableEntitys](#) accessing the [PortPrototype](#) referenced by [port](#) shall handle the extended transformer error notification.] ([RS_SWCT_03222](#))

Enumeration	DataTransformationErrorHandlingEnum
Package	M2::AUTOSARTemplates::SWComponentTemplate::SwcInternalBehavior::PortAPIOptions
Note	This enumeration defines different ways how a RunnableEntity shall handle transformer errors.
Literal	Description
noTransformerErrorHandling	A runnable does not handle transformer errors. Tags: atp.EnumerationLiteralIndex=0
transformerErrorHandling	The runnable implements the handling of transformer errors. Tags: atp.EnumerationLiteralIndex=1

Table 7.43: DataTransformationErrorHandlingEnum

[TPS_SWCT_03500] Status forwarding to data transformer [If the attribute [PortAPIOption.transformerStatusForwarding](#) is set to [transformerStatusForwarding](#) then all [RunnableEntitys](#) accessing the [PortPrototype](#) referenced by [port](#) shall provide the to be forwarded transformer status.] ()

[TPS_SWCT_03501] Applicability of status forwarding to data transformer [The attribute `PortAPIOption.transformerStatusForwarding` shall only be set to `transformerStatusForwarding` if the transported data is originating from a transformed source and is not altered.]()

The restriction of [TPS_SWCT_03501] is especially necessary in case of E2E protected data routing where the source of the data is received with a *transformer error* using `PortAPIOption.errorHandling = transformerErrorHandling`.

Enumeration	DataTransformationStatusForwardingEnum
Package	M2::AUTOSARTemplates::SWComponentTemplate::SwcInternalBehavior::PortAPIOptions
Note	This enumeration defines different ways how a RunnableEntity shall be able to forward status into the transformer chain. Tags: atp.Status=draft
Literal	Description
noTransformerStatusForwarding	The runnable is not able to forward a transformer status. Tags: atp.EnumerationLiteralIndex=0
transformerStatusForwarding	The runnable is able to forward a transformer status. Tags: atp.EnumerationLiteralIndex=1

Table 7.44: DataTransformationStatusForwardingEnum

7.6.1 Enable to Take Address

[TPS_SWCT_01355] enableTakeAddress = true [If the attribute `enableTakeAddress = true` the generated API functions related to this `PortPrototype` shall be implemented by means of true/native C functions (as opposed to function-like preprocessor macros) so that it is possible to access the API functions via their address (by means of function-pointers).]()

The main focus of the feature is support for configuration of AUTOSAR Services which are limited to single instances.

[constr_2024] enableTakeAddress is restricted to single instantiation [The definition of a `PortAPIOption` with `enableTakeAddress` set to `true` is only permitted for software-components where the attribute `SwcInternalBehavior.supportsMultipleInstantiation` is set to `false`.]()

7.6.2 Indirect API Generation

[TPS_SWCT_01356] indirectAPI option switches the generation of the RTE's indirect API functionality [The `indirectAPI` option switches the generation of the RTE's indirect API functionality for a certain `PortPrototype`. The generated indirect API does allow iterating over ports within the SW-Component.]()

7.6.3 Port Defined Argument Value

[TPS_SWCT_01357] Definition of implicit values that are passed by the RTE to the server's entry point [In addition to the formal parameters of a client/server invocation that are defined as part of the server's `PortInterface`, it is possible to specify a number of implicit values that are passed by the RTE to the server's entry point.]()

The initial need for this feature arises in the context of basic software services - although it is not limited to those.

For a service like the NVRAM manager, every accessing port is in addition to its logical identity - as a sequence of `shortNames` - uniquely identified through a NVRAM specific memory block id. This block id shall be defined in the context of ECU integration and not by the client components.

Instead of exposing this mechanism on the logical `ClientServerInterface` level in form of a formal `argument`, one or more `PortDefinedArgumentValues` can be specified.

[TPS_SWCT_01358] Values are hidden from the client components [Because these values are specified in the context of the provide-port only they are hidden from the client components keeping their design and code independent of the server component details.]()

In the example of the NVRAM manager, this allows to define the block id in the context of ECU integration and not by the client components.

Figure 7.32 shows the meta-model of Port API Options and the `portArgValue`.

[constr_1150] Usage of `valueType` for `PortDefinedArgumentValue` [The `valueType` (typically this boils down to integer values used to specify an "id") associated with `PortDefinedArgumentValue` shall be of `category VALUE` or `TYPE_REFERENCE`. The latter case is only supported if the value of `category` of the target data type is set to `VALUE`.]()

In case of a `PPortPrototype` of the NVRAM example this list would have just one value of type `int8` or `int16` holding the memory block id.

[constr_1386] `PortDefinedArgumentValue` shall only be defined for `AbstractProvidedPortPrototype` [A `PortAPIOption` which aggregates at least one `PortDefinedArgumentValue` in the role `portArgValue` shall reference an `AbstractProvidedPortPrototype` typed by a `ClientServerInterface` in the role `port`.]()

To be clear, this means that `PortDefinedArgumentValues` may not be used together with `RPortPrototypes`.

Class	PortDefinedArgumentValue			
Package	M2::AUTOSARTemplates::SWComponentTemplate::SwcInternalBehavior::PortAPIOptions			
Note	A PortDefinedArgumentValue is passed to a RunnableEntity dealing with the ClientServerOperations provided by a given PortPrototype. Note that this is restricted to PPortPrototypes of a ClientServer Interface.			
Base	ARObject			
Attribute	Type	Mult.	Kind	Note
value	ValueSpecification	1	aggr	Specifies the actual value.
valueType	ImplementationData Type	1	tref	The implementation type of this argument value. It should not be composite type or a pointer. Stereotypes: isOfType

Table 7.45: PortDefinedArgumentValue

7.6.4 Supported Features

Historically, the [PortAPIOption](#) has undergone a number of extensions that usually ended up in additional primitive or composite attributes.

As further requests for extensions keep coming in, focus was put on limiting the complexity of the overall modeling of [PortAPIOption](#). In response to this, a new extension approach has been defined to keep the surroundings of [PortAPIOption](#) manageable.

In particular, [PortAPIOption](#) aggregates the abstract meta-class [SwcSupportedFeature](#) in the role [supportedFeature](#) (see Figure 7.32).

The actual aggregation of [supportedFeature](#) will consist of concrete sub-classes of [SwcSupportedFeature](#).

It will be possible to add further sub-classes of [SwcSupportedFeature](#) to add further functionality without increasing the modeling complexity of [PortAPIOption](#), at the expense of having to formulate additional constraints.

Class	SwcSupportedFeature (abstract)			
Package	M2::AUTOSARTemplates::SWComponentTemplate::SwcInternalBehavior::PortAPIOptions			
Note	This meta-class represents a abstract base class for features that can be supported by a RunnableEntity.			
Base	ARObject			
Subclasses	CommunicationBufferLocking			
Attribute	Type	Mult.	Kind	Note
–	–	–	–	–

Table 7.46: SwcSupportedFeature

7.6.4.1 Buffer Locking

[TPS_SWCT_01687] Support of locked communication buffers [If a `CommunicationBufferLocking` where attribute `supportBufferLocking` is set to value `supportsBufferLocking` is aggregated in the role `PortAPIOption.supportedFeature` then all `RunnableEntity`s accessing the enclosing `PortPrototype` shall be able to support the return value `RTE_E_COM_BUSY`.]()

[constr_1432] Multiplicity of `CommunicationBufferLocking` [In a concrete aggregated set of `PortAPIOption.supportedFeature`, `CommunicationBufferLocking` shall exist at most once.]()

Class	<code>CommunicationBufferLocking</code>			
Package	M2::AUTOSARTemplates::SWComponentTemplate::SwcInternalBehavior::PortAPIOptions			
Note	The aggregation of this meta-class specifies that a <code>RunnableEntity</code> supports locked communication buffers supplied by the RTE. It is able to cope with the error <code>RTE_E_COM_BUSY</code> .			
Base	<code>ARObject</code> , <code>SwcSupportedFeature</code>			
Attribute	Type	Mult.	Kind	Note
supportBufferLocking	<code>SupportBufferLockingEnum</code>	1	attr	This attribute is used to indicate the intended buffer locking behavior.

Table 7.47: CommunicationBufferLocking

Enumeration	<code>SupportBufferLockingEnum</code>
Package	M2::AUTOSARTemplates::SWComponentTemplate::SwcInternalBehavior::PortAPIOptions
Note	This enumeration represents the ability to define the buffer locking behavior.
Literal	Description
doesNotSupportBufferLocking	Buffer locking is not supported. Tags: atp.EnumerationLiteralIndex=0
supportsBufferLocking	Buffer locking is supported. Tags: atp.EnumerationLiteralIndex=1

Table 7.48: SupportBufferLockingEnum

7.7 PerInstanceMemory

[TPS_SWCT_01359] Private memory per instance [`AtomicSwComponentTypes` that support multiple instantiation (attribute `supportsMultipleInstantiation == true`) will typically need a given amount of private memory per instance. It is the responsibility of the RTE to provide a mechanism with which each instance of an `AtomicSwComponentType` can access its own instance-specific memory.]()

[TPS_SWCT_01360] Arbitrary number of per-instance memory blocks [An `AtomicSwComponentType` can define an arbitrary number of per-instance memory blocks.]()

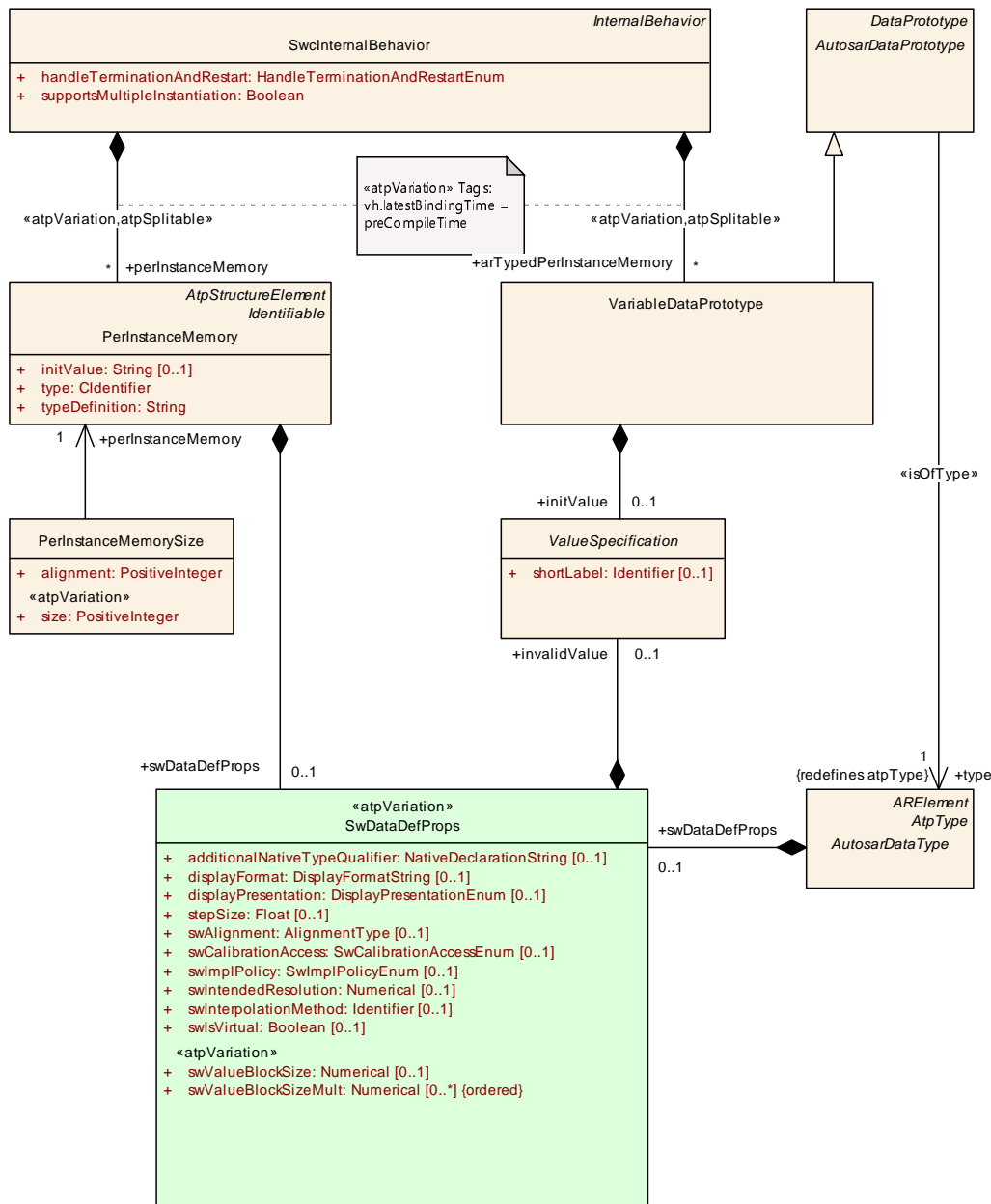

Figure 7.33: PerInstanceMemory

[TPS_SWCT_01361] attribute `supportsMultipleInstantiation == false` [AtomicSwComponentTypes that do *not* support multiple instantiation (attribute `supportsMultipleInstantiation == false`) do not necessarily need to use the `PerInstanceMemory`: because there will only be a single instance of the `AtomicSwComponentType` on an ECU, the `AtomicSwComponentType` can use static variables to store the `AtomicSwComponentType`'s internal state.

However, the usage of `PerInstanceMemory` is also allowed in this case.]()

[TPS_SWCT_01362] Initialization of `PerInstanceMemory` [Note that the `PerInstanceMemory` is not initialized by the RTE if no `initValue` is defined. In this case, it

is the responsibility of the `AtomicSwComponentType` to initialize the `PerInstanceMemory`.]()

7.7.1 `PerInstanceMemory` typed by “C” Data Types

[TPS_SWCT_01363] `PerInstanceMemory` typed by “C” Data Types [For each such memory block, the software-component description shall provide the name of the data type (the “C”-type) it needs to store in the memory block in the attribute `type`.

This attribute allows for the RTE to generate an API function that provides a convenient and type-safe access to the data item.

In addition, the software-component description shall define the data type in the attribute `typeDefinition`. This attribute is supposed to contain a C typedef of the data type in valid C-syntax.]()

In other words, this `typeDefinition` shall be formulated such that it can be included verbatim in a C header file.

[constr_2007] Consistency of `typeDefinition` attribute [All `PerInstanceMemory`s of the same `SwcInternalBehavior` with identical `type` attribute shall define an identical `typeDefinition` attribute as well.]()

[TPS_SWCT_01364] Initial value of a `PerInstanceMemory` typed by “C” Data Types [The `initValue` is a comma separated list which can be used verbatim by the RTE generator as constant initializer.]()

[TPS_SWCT_01574] `PerInstanceMemory.typeDefinition` shall not contain a function pointer [The attribute `PerInstanceMemory.typeDefinition` is not allowed to contain a function pointer.]()

Please note that, although [TPS_SWCT_01574] is formulated like a constraint and the statement that it makes certainly has a constraint-ish nature, there is hardly a way to actually **enforce** the regulation because the content of `PerInstanceMemory.typeDefinition` is non-formal (modeled by the non-specific i.e. `String`).

Therefore, a specification item has been used for the description of the respective semantics rather than a constraint.

More details on the use of these attributes in the generation of software-component header-files can be found in the RTE specification [2].

Class	PerInstanceMemory			
Package	M2::AUTOSARTemplates::SWComponentTemplate::SwcInternalBehavior::PerInstanceMemory			
Note	Defines a 'C' typed memory-block that needs to be available for each instance of the SW-component. This is typically only useful if supportsMultipleInstantiation is set to "true" or if the software-component defines NVRAM access via permanent blocks.			
Base	ARObject, AtpClassifier, AtpFeature, AtpStructureElement, Identifiable , MultilanguageReferrable , Referrable			
Attribute	Type	Mult.	Kind	Note
initValue	String	0..1	attr	Specifies initial value(s) of the PerInstanceMemory
swDataDef Props	SwDataDefProps	0..1	aggr	This represents the ability to to allocate RAM at specific memory sections, for example, to support the RAM Block recovery strategy by mapping to uninitialized RAM.
type	CIdentifier	1	attr	The name of the "C"-type
typeDefinition	String	1	attr	A definition of the type with the syntax of a 'C' typedef.

Table 7.49: PerInstanceMemory

7.7.2 PerInstanceMemory typed by AUTOSAR Data Types

[TPS_SWCT_01365] **PerInstanceMemory typed by AUTOSAR Data Types** [A [PerInstanceMemory](#) typed with AUTOSAR data types is defined by a [VariableDataPrototype](#) in the role [arTypedPerInstanceMemory](#).

[VariableDataPrototype](#) is derived from [DataPrototype](#) which has an association to an [AutosarDataType](#).]()

This defines the data type of the AUTOSAR-typed [PerInstanceMemory](#).

[TPS_SWCT_01366] **Initial value of a PerInstanceMemory typed by AUTOSAR Data Types** [The [initValue](#) is described with a [ValueSpecification](#)]()

[TPS_SWCT_01367] **Typed by AUTOSAR data type vs. typed by C data type** [In difference to the "C" typed [PerInstanceMemory](#) the AUTOSAR-typed [PerInstanceMemory](#) is able to define information controlling the visibility in an MCD system via a [SwDataDefProps](#) for the purpose of measurement or defining an input value of an axis.]()

For more information about the relevance for measurement please refer to chapter 5.4.3. The aspect of defining an input value of an axis is explained in chapter 5.4.5.

Note: Due to the use of [AutosarDataType](#) the AUTOSAR-typed [PerInstanceMemory](#) can not support C++ specific types or pointer types directly.

7.8 Static Memory and Constant Memory

[TPS_SWCT_01368] **Describe static and constant memory** [Static memory (formalized by means of [InternalBehavior.staticMemory](#)) and constant memory (formalized by means of [InternalBehavior.constantMemory](#)) can be used whenever

`AutosarDataTypes` should be used in the implementation of an `AtomicSwComponentType` but no involvement of the RTE (for memory allocation and management) is required. `()`

This includes special cases of measurement and calibration but also debugging.

[TPS_SWCT_01483] Use static and constant memory to support Measurement and Calibration [The information about these characteristic values and variables is given with the purpose to support Measurement and Calibration and has to be taken into account for the generation of A2L files.

A proprietary generator shall take care of these data for the purpose of generating A2L. `()`

Please note that the topic “measurement and calibration” is discussed in chapter 2.2.

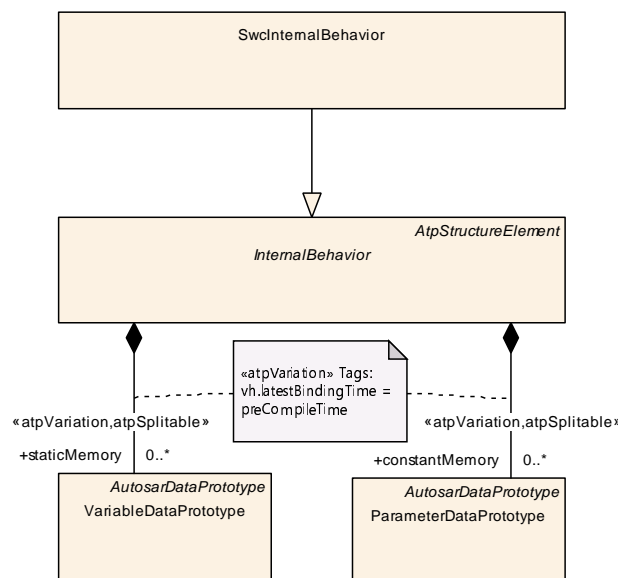

Figure 7.34: Static Memory and Constant Memory

[TPS_SWCT_01369] Static and constant memory is not instantiated by the RTE [In contrast to the other kinds of memory like `implicitInterRunnableVariable`, `implicitInterRunnableVariable`, `PerInstanceMemory`, `sharedParameter` or `perInstanceParameter` the `staticMemory` and `constantMemory` are **not** instantiated by the RTE. `()`

This allows for more efficient implementations (especially for software-components provided as object code) by avoidance of the additional indirection caused by the RTE’s component data structure.

Further on, this kind of memory reduces the dependencies of the software-component implementation to generated RTE code which is appreciated for safety related functionalities.

Due to the instantiation of the memory by the software-component’s implementation the `constantMemory` behaves like a `sharedParameter` (see chapter 2.2.3.2)

[constr_2028] staticMemory is restricted to single instantiation [The `staticMemory` is only supported if the attribute `supportsMultipleInstantiation` of the owning `SwcInternalBehavior` is set to `false`.]()

This constraint prevents hidden communication between `SwComponentPrototypes` of the same `SwComponentType`.

[constr_2029] shortName of constantMemory and staticMemory [The `shortName` of a `VariableDataPrototype` in role `staticMemory` or a `ParameterDataPrototype` in role `constantMemory` has to be equal with the 'C' identifier of the described variable or constant.]()

7.9 Included AUTOSAR Data Types

[TPS_SWCT_01155] IncludedDataSet [An `IncludedDataSet` declares that a set of `AutosarDataTypes` are used for the C / C++ implementation of the software component. The `AutosarDataTypes` become part of the contract.]()

[TPS_SWCT_01156] Required if the AutosarDataType is not used for any DataPrototype [This information is required if the `AutosarDataType` is not used for any `DataPrototype` owned by this software component or if a prefix for C language identifiers belonging to `AutosarDataTypes` shall be defined.]()

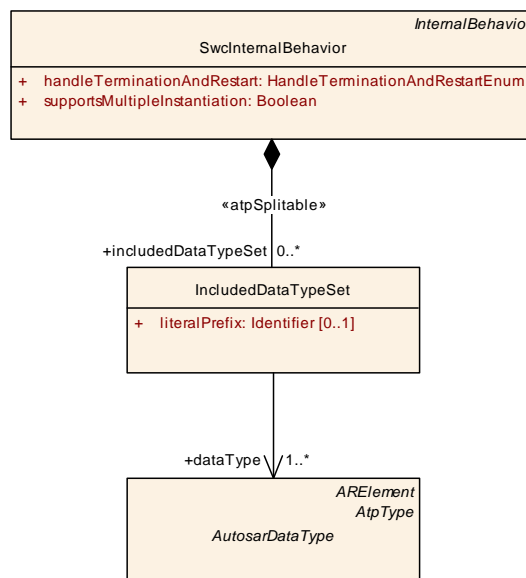

Figure 7.35: Included AUTOSAR Data Types

Class	IncludedDataTypeSet			
Package	M2::AUTOSARTemplates::SWComponentTemplate::SwcInternalBehavior::IncludedDataTypes			
Note	<p>An includedDataTypeSet declares that a set of AutosarDataType is used by a basic software module or a software component for its implementation and the AutosarDataType becomes part of the contract.</p> <p>This information is required if the AutosarDataType is not used for any DataPrototype owned by this software component or if the enumeration literals, lowerLimit and upperLimit constants shall be generated with a literalPrefix.</p> <p>The optional literalPrefix is used to add a common prefix on enumeration literals, lowerLimit and upperLimit constants created by the RTE.</p>			
Base	ARObject			
Attribute	Type	Mult.	Kind	Note
dataType	AutosarDataType	1..*	ref	AutosarDataType belonging to the includedDataTypeSet
literalPrefix	Identifier	0..1	attr	LiteralPrefix defines a common prefix for all AutosarDataTypes of the includedDataTypeSet to be added on enumeration literals, lowerLimit and upperLimit constants created by the RTE.

Table 7.50: IncludedDataTypeSet

This supports the common usage of the AUTOSAR data type system for RTE provided memory objects and memory objects declared by the software component implementation.

Further on, this enables the generation of the RTE Application Types Header File for AUTOSAR services containing the required data types for the C-API before the data type usage in dedicated ports for an ECU is known.

[TPS_SWCT_01157] Attribute [literalPrefix](#) of [IncludedDataTypeSet](#) [In addition, the [literalPrefix](#) might be used to separate the namespace of C language identifiers belonging to equally named [AutosarDataTypes](#) used for the same software component C implementation.]()

7.10 Included Mode Declaration Groups

[TPS_SWCT_01153] [IncludedModeDeclarationGroupSet](#) [Similar to the consideration of data types using [IncludedDataTypeSet](#), [SwcInternalBehavior](#) aggregates [IncludedModeDeclarationGroupSet](#) that in turn allows for referencing [ModeDeclarationGroups](#) with the intent to express that the referenced [ModeDeclarationGroups](#) are used in the context of the enclosing [AtomicSwComponentType](#).]()

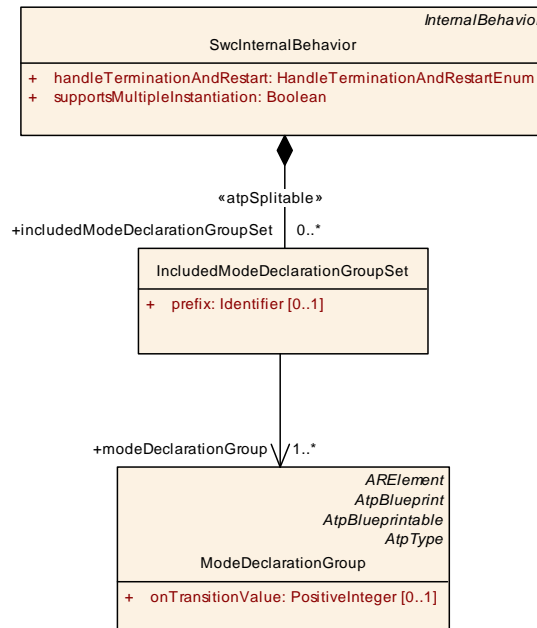

Figure 7.36: Included ModeDeclarationGroups

Class	IncludedModeDeclarationGroupSet			
Package	M2::AUTOSARTemplates::SWComponentTemplate::SwcInternalBehavior::ModeDeclarationGroup			
Note	An IncludedModeDeclarationGroupSet declares that a set of ModeDeclarationGroups used by the software component for its implementation and consequently these ModeDeclarationGroups become part of the contract.			
Base	ARObject			
Attribute	Type	Mult.	Kind	Note
mode Declaration Group	ModeDeclarationGroup	1..*	ref	This represents the referenced ModeDeclarationGroup.
prefix	Identifier	0..1	attr	The prefix shall be used by the RTE generator as a prefix for the creation of symbols related to the referenced ModeDeclarationGroups, e.g RTE_TRANSITION_<Mode DeclarationGroup>.

Table 7.51: IncludedModeDeclarationGroupSet

[TPS_SWCT_01154] Attribute prefix of IncludedModeDeclarationGroupSet

[The optional attribute prefix of IncludedModeDeclarationGroupSet can be used to define a prefix that the RTE generator shall use to define symbols related to the included ModeDeclarationGroups with the intent to avoid potential name clashes.]

()

Rationale: If the attribute prefix is required, changes to software-component source code may be necessary.

7.11 Service Needs

7.11.1 Overview

[TPS_SWCT_01043] ApplicationSwComponentTypes are independent from actual ECU Hardware [ApplicationSwComponentTypes are designed to be independent of their mapping to actual ECU Hardware.] (RS_SWCT_02060)

However, each software-component might need services which are provided by the ECU Basic Software through AUTOSAR Services.

[TPS_SWCT_01044] ServiceNeeds [The ServiceNeeds are used to provide detailed information what the software-component expects from the AUTOSAR Services when integrated on an actual ECU.

Note that only AtomicSwComponentTypes and NvBlockSwComponentTypes can be connected to AUTOSAR Services.] (RS_SWCT_02060)

Please note that some ServiceNeeds are on display in Figures 7.37, 7.38, 7.39, and 7.40.

[TPS_SWCT_01045] Actual values of ECU configuration parameters fulfill the requirements given by the ServiceNeeds [When integrating application software-components on an ECU, the actual values of ECU configuration parameters shall be chosen so that they fulfill the requirements given by the ServiceNeeds of all the integrated AtomicSwComponentTypes.] (RS_SWCT_02060)

Note that the actual values of configuration parameters will in addition depend on the properties of the basic software and the hardware of that specific ECU, see also chapter 11.

For further information about the relation between the ServiceNeeds and the ECU configuration parameters see [31].

Class	ServiceNeeds (abstract)			
Package	M2::AUTOSARTemplates::CommonStructure::ServiceNeeds			
Note	This expresses the abstract needs that a Software Component or Basic Software Module has on the configuration of an AUTOSAR Service to which it will be connected. "Abstract needs" means that the model abstracts from the Configuration Parameters of the underlying Basic Software.			
Base	ARObject, Identifiable, MultilanguageReferrable, Referrable			
Subclasses	BswMgrNeeds, ComMgrUserNeeds, CryptoServiceJobNeeds, CryptoServiceNeeds, DiagnosticCapabilityElement, DltUserNeeds, DolpServiceNeeds, EcuStateMgrUserNeeds, ErrorTracerNeeds, FunctionInhibitionAvailabilityNeeds, FunctionInhibitionNeeds, GlobalSupervisionNeeds, HardwareTestNeeds, IndicatorStatusNeeds, J1939RmIncomingRequestServiceNeeds, J1939RmOutgoingRequestServiceNeeds, NvBlockNeeds, SecureOnBoardCommunicationNeeds, SupervisedEntityCheckpointNeeds, SupervisedEntityNeeds, SyncTimeBaseMgrUserNeeds, V2xFacUserNeeds, V2xMUserNeeds, VendorSpecificServiceNeeds			
Attribute	Type	Mult.	Kind	Note





<i>Class</i>	<i>ServiceNeeds</i> (abstract)			
-	-	-	-	-

Table 7.52: ServiceNeeds

The meta-class [ServiceNeeds](#) and the sub-classes for several Services are located in the `CommonStructure` package of the meta-model because they are also used in the Basic Software Module Description Template [6].

The meta-classes derived from [ServiceNeeds](#) is shown in the next figures.

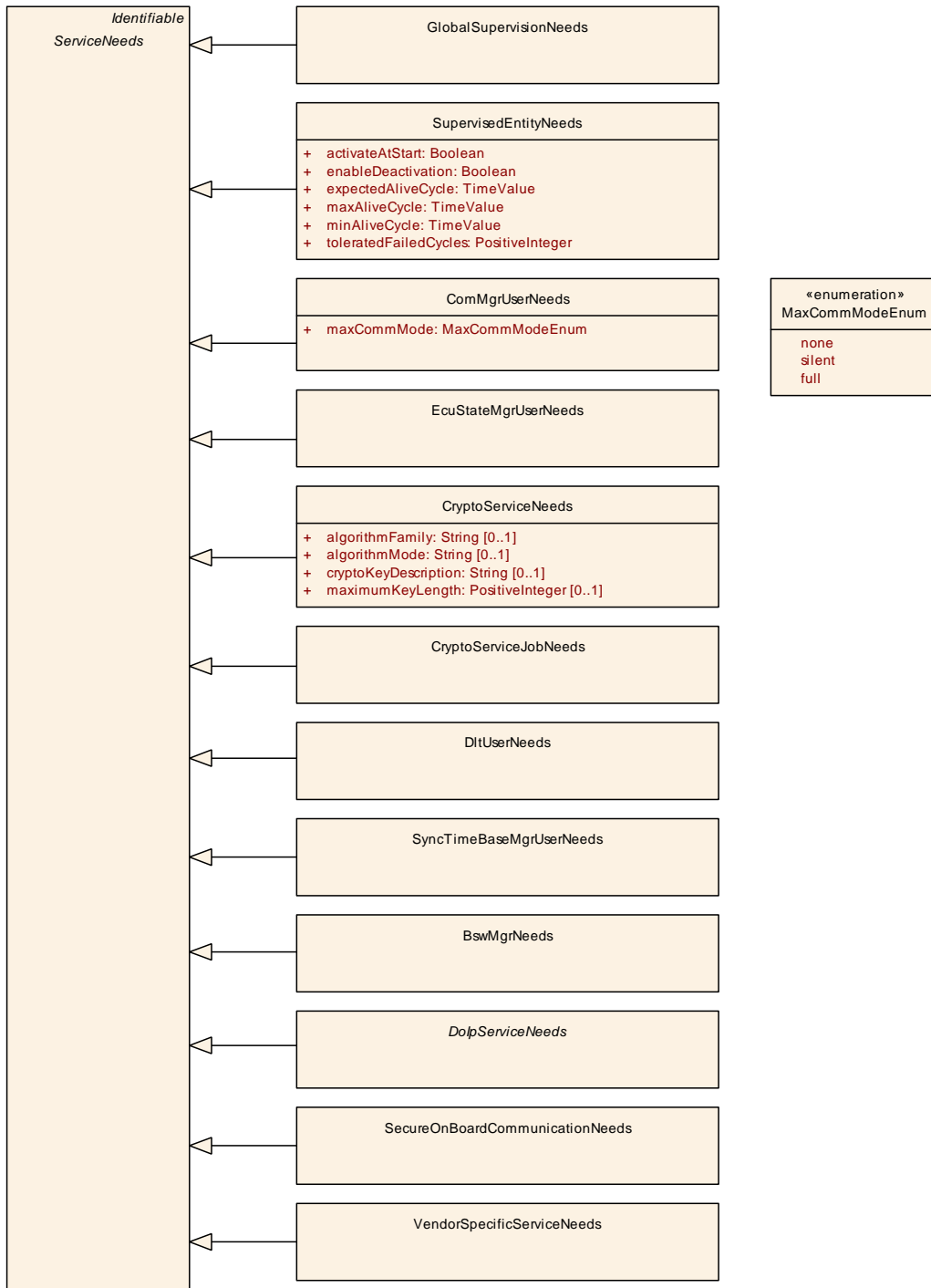

Figure 7.37: ServiceNeeds: General ServiceNeeds

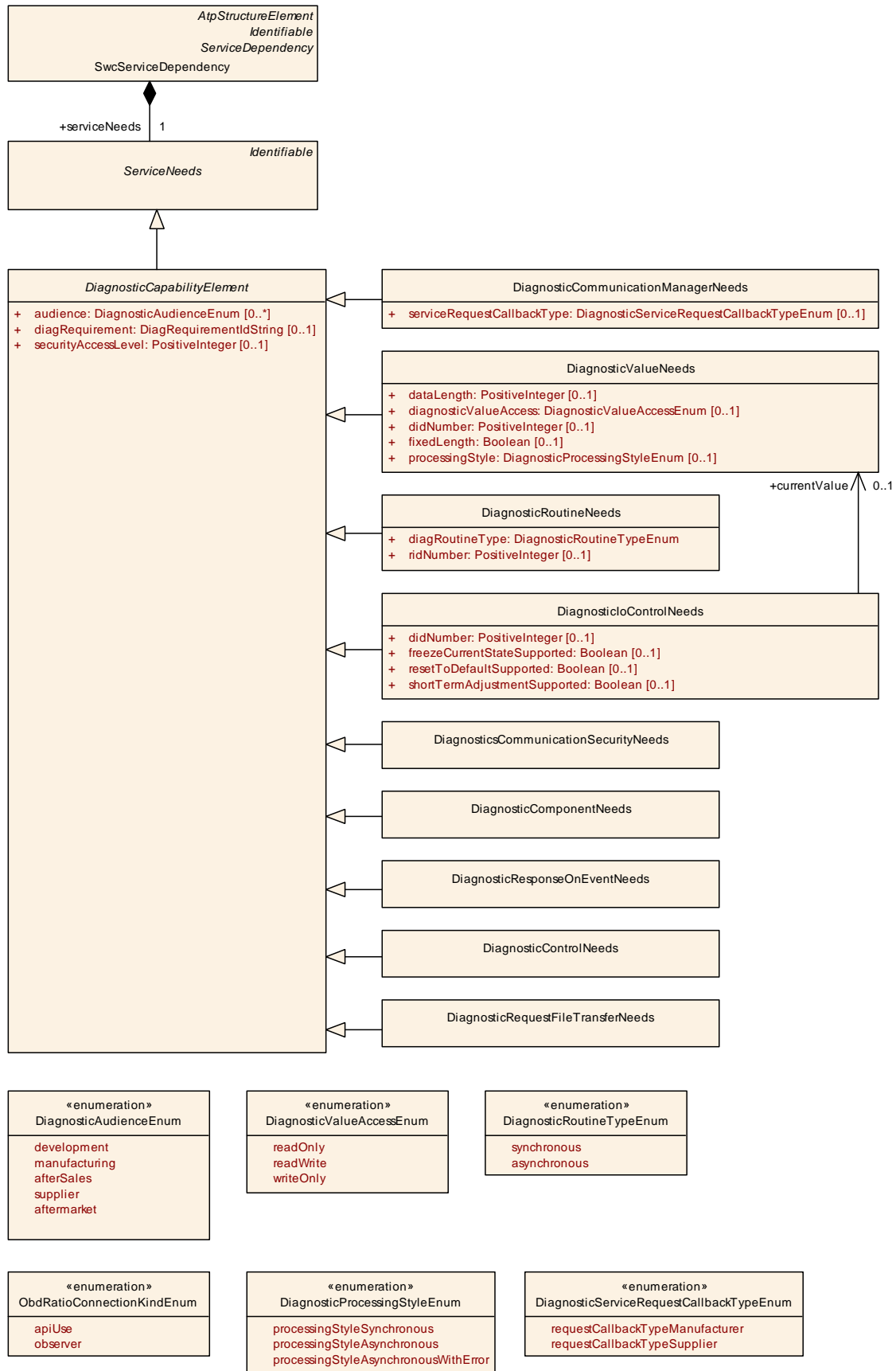

Figure 7.38: General diagnostic service-related ServiceNeeds

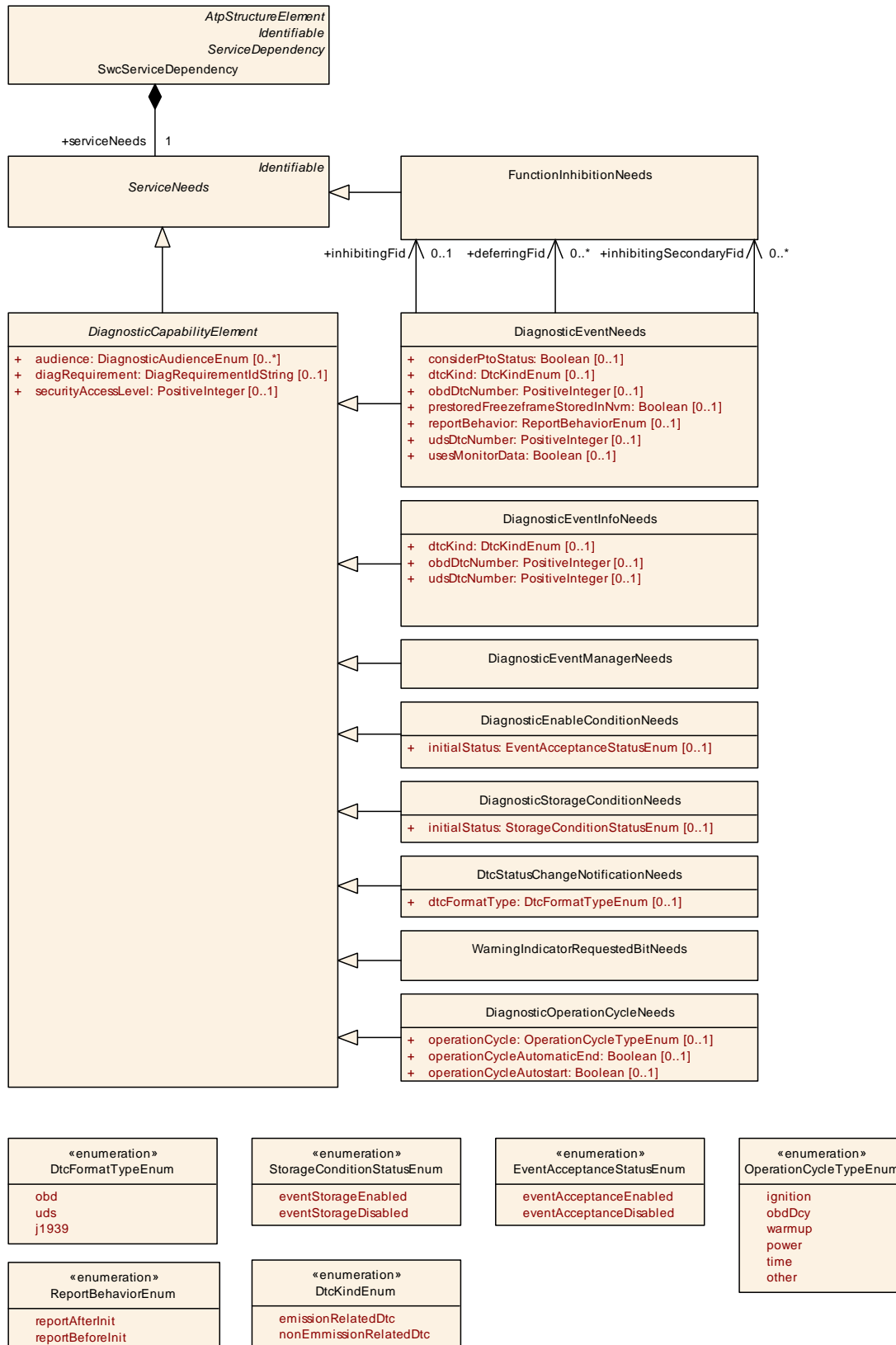

Figure 7.39: General diagnostic event-handling related *ServiceNeeds*

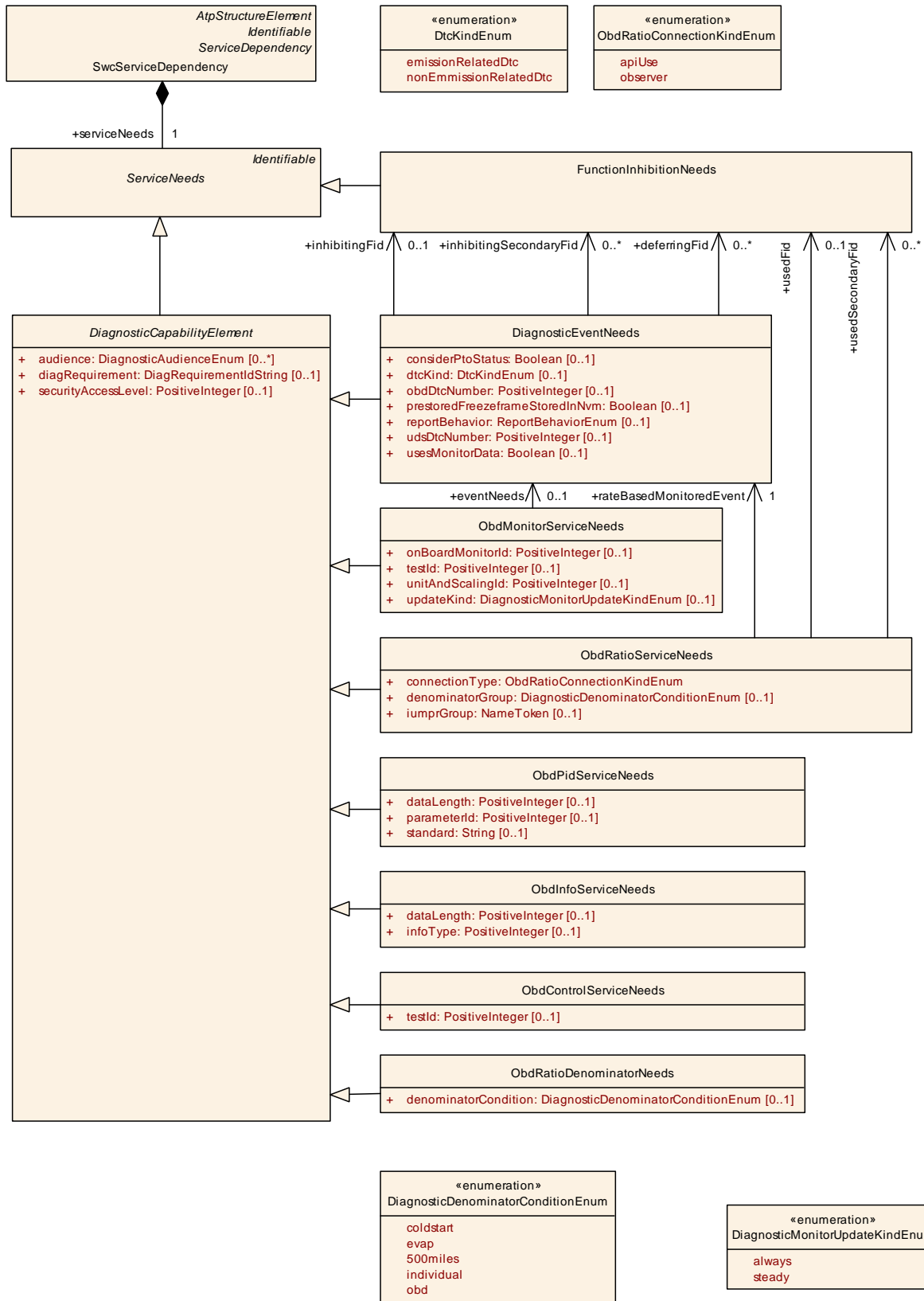

Figure 7.40: ServiceNeeds: Diagnostic-related ServiceNeeds with emphasis on OBD

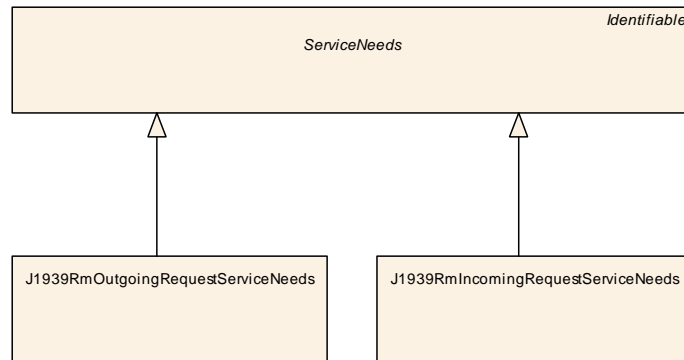

Figure 7.41: ServiceNeeds: J1939-related ServiceNeeds

Please note that the vast majority of the subclasses of meta-class `ServiceNeeds` are associated with standardized behavior of AUTOSAR services. However, there are cases where a user-specific behavior is required and for this purpose a specific flavor of `ServiceNeeds` is available.

[TPS_SWCT_01693] Usage of VendorSpecificServiceNeeds [It is possible to define `VendorSpecificServiceNeeds` for the purpose of implementing a vendor-specific, i.e. non-standardized, service. `VendorSpecificServiceNeeds` does not provide any attributes and its meaning shall be described by means of the `category` attribute.] (*RS_SWCT_02060*)

Class	VendorSpecificServiceNeeds			
Package	M2::AUTOSARTemplates::CommonStructure::ServiceNeeds			
Note	This represents the ability to define vendor-specific service needs.			
Base	<code>ARObject</code> , <code>Identifiable</code> , <code>MultilanguageReferrable</code> , <code>Referrable</code> , <code>ServiceNeeds</code>			
Attribute	Type	Mult.	Kind	Note
-	-	-	-	-

Table 7.53: VendorSpecificServiceNeeds

7.11.2 Assignment of Service Needs to Ports and Data

[TPS_SWCT_01046] ServiceNeeds are defined in the scope of the SwcInternalBehavior [`ServiceNeeds` specified by `AtomicSwComponentTypes` are defined in the scope of the `SwcInternalBehavior` because in several cases they need associations to other parts of the `SwcInternalBehavior`.

In most cases they are related to certain `PortPrototypes` belonging to the `AtomicSwComponentTypes` because `AtomicSwComponentTypes` communicate with AUTOSAR Services via these `PortPrototypes`.] (*RS_SWCT_02060*)

In addition, a `ServiceNeeds` element can also have relations to some data declared within the same `SwcInternalBehavior`, namely some use cases of the NVRAM Service, require a Permanent RAM Block and/or ROM Block declared in the context of the single software component.

A further use case requires that a `ServiceNeeds` element is linked to a `PortGroup`. Especially, a `ServiceNeeds` can represent a group of `PortPrototypes` as input to configure the communication manager in order to handle the communication state of those `PortPrototypes`.

These relationships to `PortPrototypes`, data and `PortGroups` are required as input for tools in order to generate the XML descriptions and configurations of the basic software which implements the Service according to the needs of several `AtomicSwComponentTypes` are integrated on an ECU, see chapter 11.

The relationship to `PortPrototypes` is defined via the meta-class `RoleBasedPortAssignment` and the relationship to data is defined via the meta-class `RoleBasedDataAssignment`.

Both are aggregating an attribute `role` which allows to define the role of the `PortPrototypes` or data in the specific context.

[constr_2027] `SwServiceDependency` shall be defined for service ports only [A `PortPrototype` that is referenced by a `SwServiceDependency` via `assignedPort` or via `assignedData` shall be typed by a `PortInterface` that has `isService` set to `true`.

This rule does **not** apply to `PortPrototypes` referenced by a `RoleBasedPortAssignment` where the attribute `role` is set to any of the following values:

- `NvMService`
- `NvMNotifyJobFinished`
- `NvMNotifyInitBlock`
- `NvMAdmin`
- `NvMMirror`
- `NvDataPort`

Furthermore, the rule does **not** apply to the case described in [TPS_SWCT_01579], [TPS_SWCT_01580], as well as [TPS_SWCT_01572].()

The actual mapping between the `ServiceNeeds` element and its various relationships is provided by the meta-class `SwServiceDependency` as shown in figure 7.43.

Note the difference between the associations to `PortPrototypes` and to `PortGroups`: While the `RoleBasedPortAssignment` is part of the `SwInternalBehavior` a `PortGroup` is defined for the `SwComponentType` (thus belongs to the VFB level) and it is linked to the `PortGroups` of other `SwComponentTypes`.

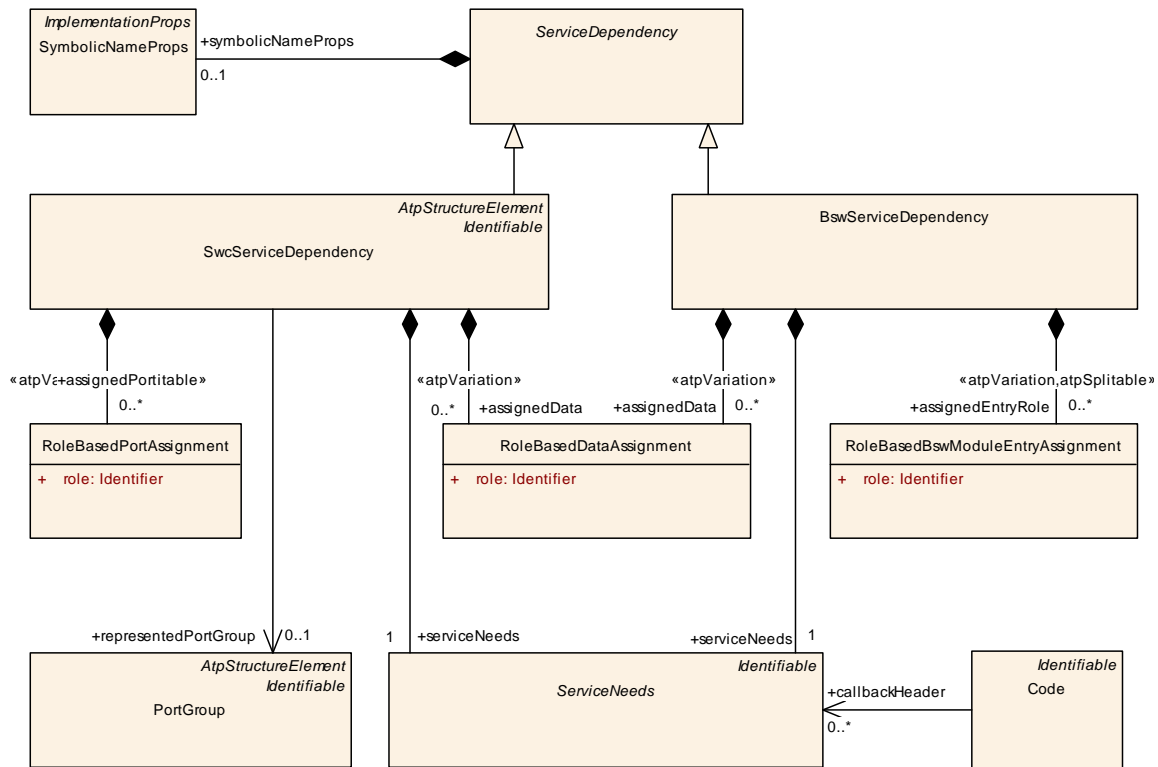

Figure 7.42: ServiceDependency is the abstract base class of SwcServiceDependency

This means a `PortGroup` represents a system feature, whereas the `RoleBasedPortAssignment` is a local feature for the purpose of communication with the AUTOSAR Service.

[TPS_SWCT_01556] Rule for setting `RoleBasedPortAssignment.role` [The value of `RoleBasedPortAssignment.role` cannot arbitrarily set but shall to equal to the `shortName` of the applicable `PortInterface` taken from the standardized AUTOSAR Service Interface model (this implies that the `category` of the `ARPackage` that owns the `PortInterface` is set to `BLUEPRINT`⁶ and the top-most `ARPackage.shortName` is set to `AUTOSAR`, see also [26])..]()

[TPS_SWCT_01660] Values of `SwcServiceDependency.category` reserved by the standard [The following values of `SwcServiceDependency.category` are reserved by the AUTOSAR standard:

SERVICE : this applies for all the cases where `SwcServiceDependency` is intended to be used for the design of `ServiceSwComponentTypes`.

NV_BLOCK_COMPONENT : this applies if the `SwcServiceDependency` is intended to be used for the design of an `NvBlockSwComponentType`.

]()

⁶see [TPS_STDT_00033]

[TPS_SWCT_01661] Default value of **SwcServiceDependency.category** [If the attribute **SwcServiceDependency.category** does not exist then the value **SERVICE** shall be assumed for **SwcServiceDependency.category**.]()

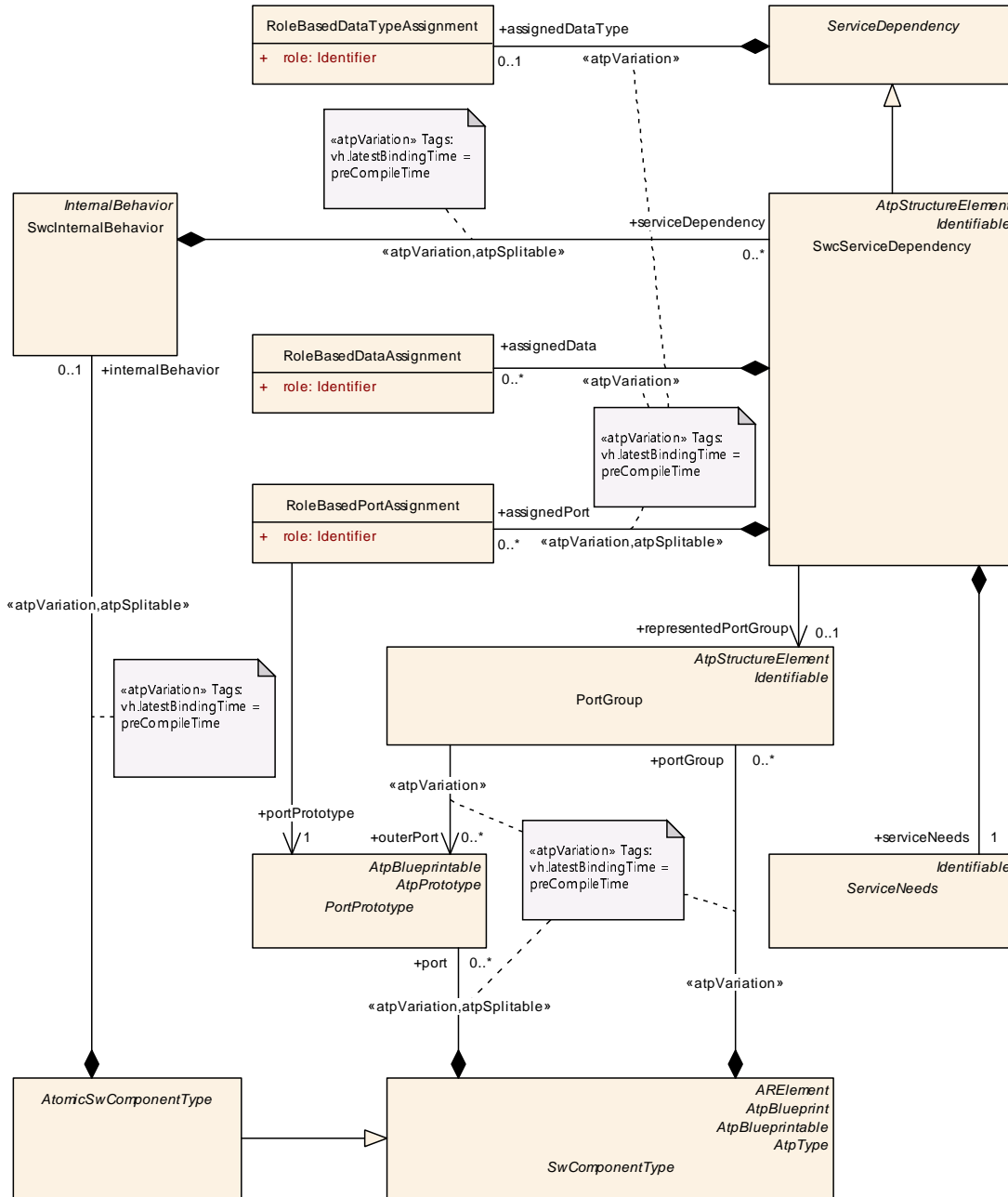

Figure 7.43: SwcServiceDependency in the SwcInternalBehavior

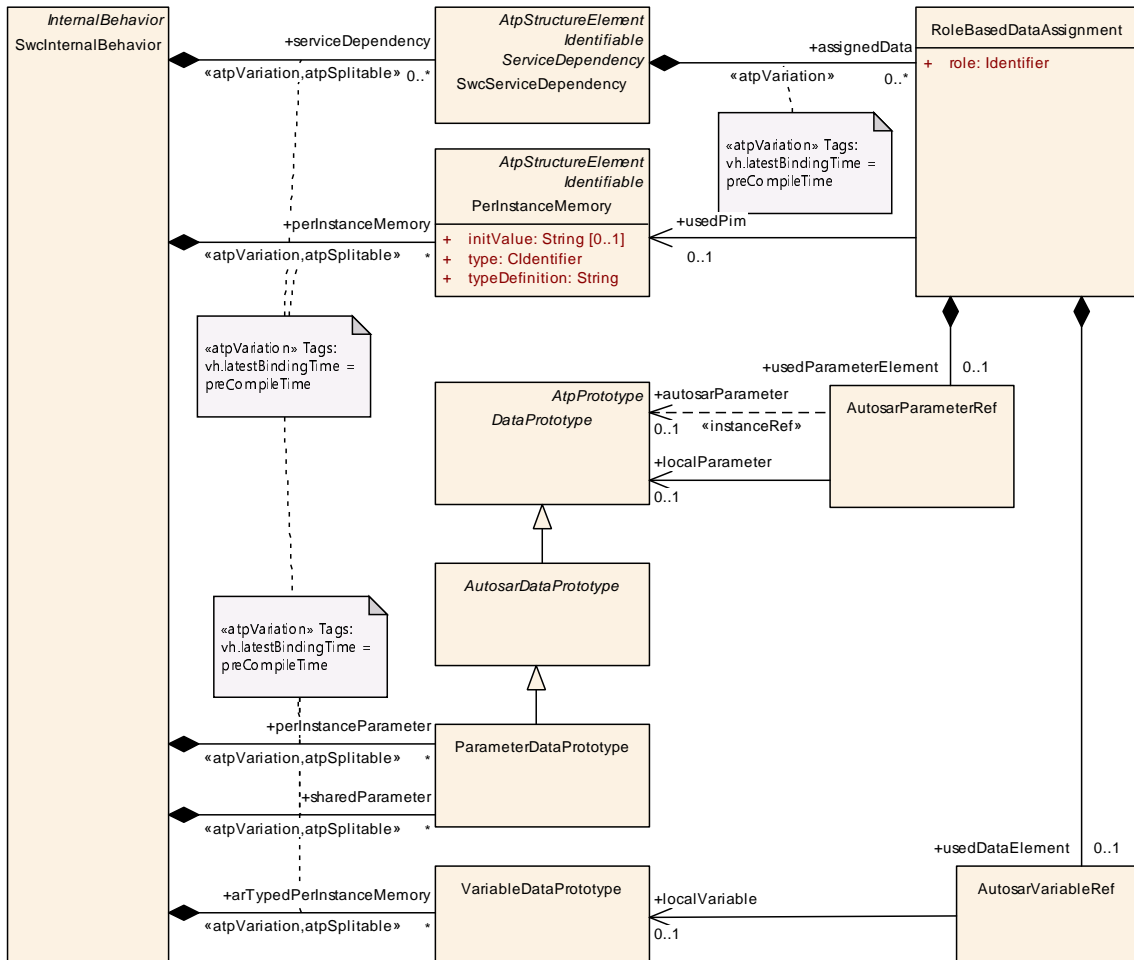

Figure 7.44: Details of *RoleBasedDataAssignment* for local data

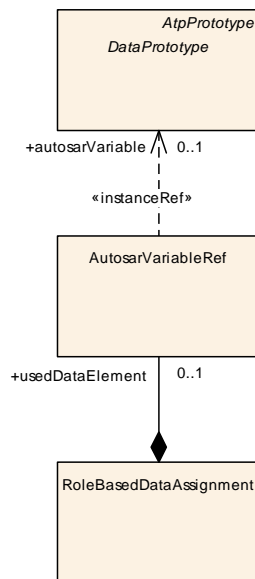

Figure 7.45: Details of *RoleBasedDataAssignment* for accessing *DataPrototypes* in *PortPrototypes*

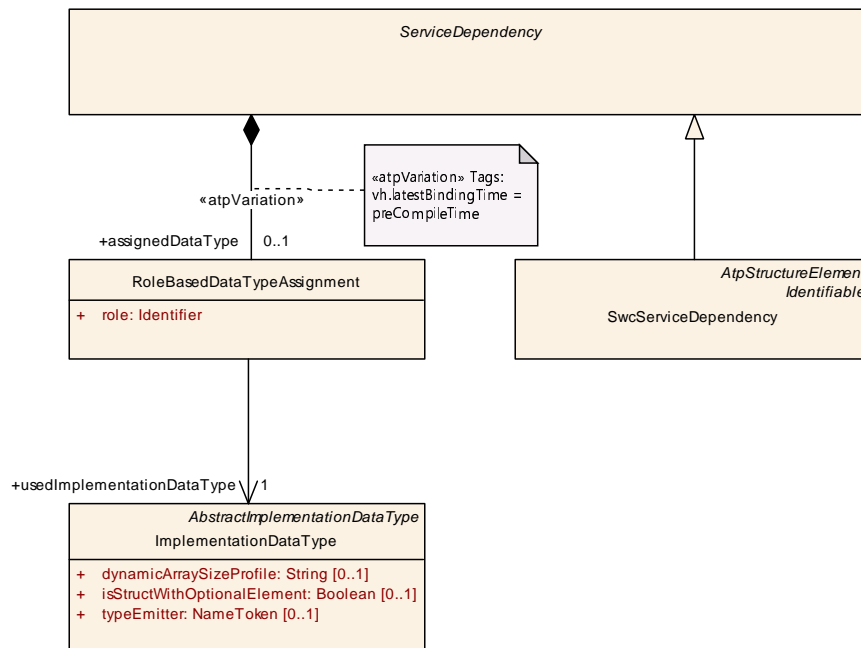

Figure 7.46: Details of `RoleBasedDataTypeAssignment` for local data

Please note that there are cases where the granularity of existing `ServiceInterfaces` does not match the granularity of existing `SwcServiceDependency.serviceNeeds`.

In other words, there are `Service Interfaces` that cover the semantics of different kinds of `ServiceNeeds`. One example is the `ClientServerInterface DataServices_{Data}` which basically supports the access to diagnostic values **as well as** I/O control of the same value.

Figure 7.47 provides a graphical sketch of how the modeling for this case is foreseen.

[TPS_SWCT_01689] Relation between `SwcServiceDependencies` and `PortPrototypes` [It is positively possible to create a model where two or more `SwcServiceDependencies`, by way of the `RoleBasedPortAssignment` or `RoleBasedDataAssignment`, refer to a single `PortPrototype`.]()

As indicated by Figure 7.47, there are two potentially competing `SwcServiceDependencies` that could be taken to contribute their `shortName` for filling in the suffix of the `DataServices_{Data}`.

In this case, it is actually necessary to settle the “over-supply of `shortNames`” by regulation of the AUTOSAR standard. [TPS_SWCT_01691] has been created for this purpose.

Another realistic example where [TPS_SWCT_01689] applies is an `AtomicSwComponentType` that exposes a `PPortPrototype` typed by a `SenderReceiverInterface` and the `dataElement(s)` within the `PPortPrototype` are both accessed as diagnostic values (see chapter 13.8.4.3) **and** are used to send mode requests to the BswM (see chapter 13.6.4).

Note that in this case a regulation regarding the `shortNames` of the affected `SwcServiceDependencies` is not required because the applicable `SenderReceiverInterface` is not standardized and does not require the assignment of a name suffix from the existing model.

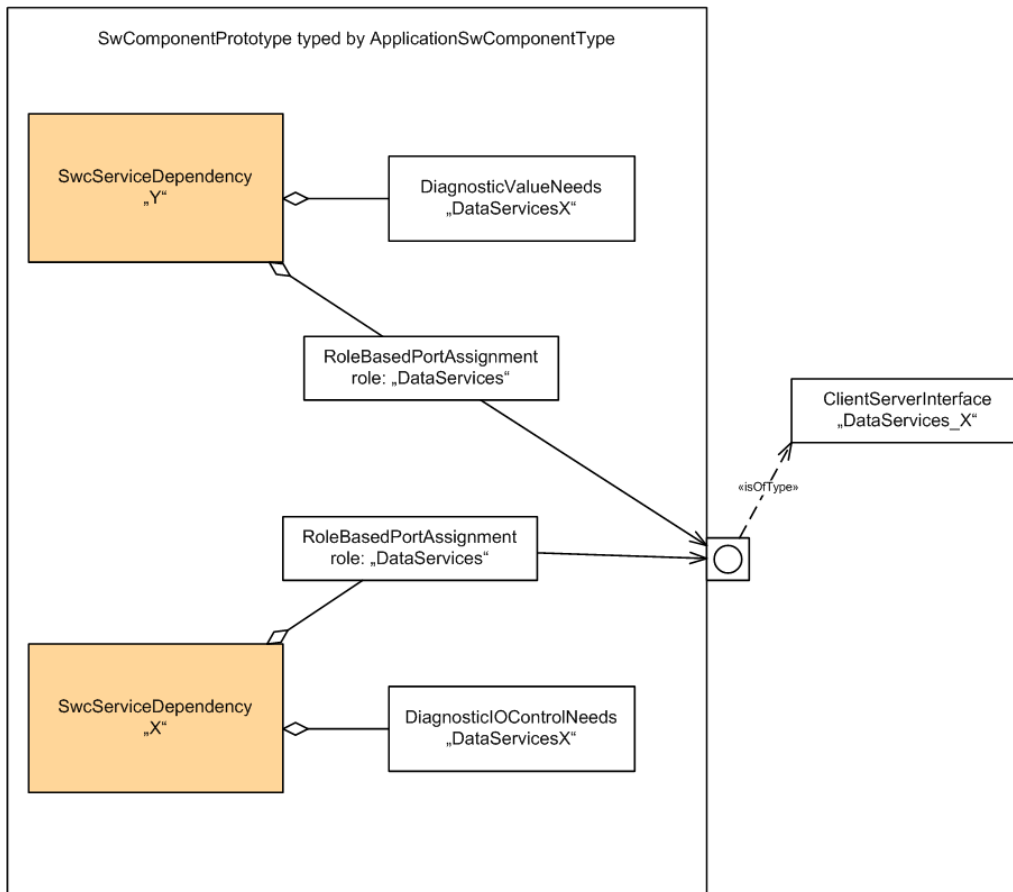

Figure 7.47: Two `SwcServiceDependencies` referencing one `PortPrototype`

[TPS_SWCT_01005] Usage of `SwcServiceDependencies` for vendor-specific services [`SwcServiceDependencies` can also be used for vendor-specific services. In this case the `SwcServiceDependency` shall not contain any of the standardized `ServiceNeeds`. For this purpose the `VendorSpecificServiceNeeds` is available.]()

Class	SwcServiceDependency
Package	M2::AUTOSARTemplates::SWComponentTemplate::SwcInternalBehavior::ServiceMapping
Note	Specialization of <code>ServiceDependency</code> in the context of an <code>SwcInternalBehavior</code> . It allows to associate ports, port groups and (in special cases) data defined for an atomic software component to a given <code>ServiceNeeds</code> element.
Base	<code>ARObject</code> , <code>AtpClassifier</code> , <code>AtpFeature</code> , <code>AtpStructureElement</code> , <code>Identifiable</code> , <code>MultilanguageReferrable</code> , <code>Referrable</code> , <code>ServiceDependency</code>





Class		SwcServiceDependency		
Attribute	Type	Mult.	Kind	Note
assignedData	RoleBasedData Assignment	*	aggr	Defines the role of an associated data object of the same component. Stereotypes: atpVariation Tags: vh.latestBindingTime=preCompileTime
assignedPort	RoleBasedPort Assignment	*	aggr	Defines the role of an associated port of the same component. Stereotypes: atpSplittable; atpVariation Tags: atp.Splitkey=assignedPort, variationPoint.shortLabel vh.latestBindingTime=preCompileTime
representedPort Group	PortGroup	0..1	ref	This reference specifies an association between the ServiceNeeds and a PortGroup, for example to request a communication mode which applies for communication via these ports. The referred PortGroup shall be local to this atomic SWC, but via the links between the Port Groups, a tool can evaluate this information such that all the ports linked via this port group on the same ECU can be found.
serviceNeeds	ServiceNeeds	1	aggr	The associated ServiceNeeds.

Table 7.54: SwcServiceDependency

Class		ServiceDependency (abstract)		
Package	M2::AUTOSARTemplates::CommonStructure::ServiceNeeds			
Note	Collects all dependencies of a software module or component on an AUTOSAR Service related to a specific item (e.g. an NVRAM Block, a diagnostic event etc.). It defines the quality of service (Service Needs) of this item as well as (optionally) references to additional elements. This information is required for tools in order to generate the related basic software configuration and ServiceSwComponentTypes.			
Base	ARObject			
Subclasses	BswServiceDependency , SwcServiceDependency			
Attribute	Type	Mult.	Kind	Note
assignedData Type	RoleBasedDataType Assignment	0..1	aggr	This is the role of the assignment data type in the given context. Stereotypes: atpVariation Tags: vh.latestBindingTime=preCompileTime
symbolicName Props	SymbolicNameProps	0..1	aggr	This attribute can be taken to contribute to the creation of symbolic name values.

Table 7.55: ServiceDependency

Class		SymbolicNameProps		
Package	M2::AUTOSARTemplates::CommonStructure::ServiceNeeds			
Note	This meta-class can be taken to contribute to the creation of symbolic name values.			
Base	ARObject , ImplementationProps , Referrable			
Attribute	Type	Mult.	Kind	Note





Class	SymbolicNameProps			
–	–	–	–	–

Table 7.56: SymbolicNameProps

Class	RoleBasedPortAssignment			
Package	M2::AUTOSARTemplates::SWComponentTemplate::SwcInternalBehavior::ServiceMapping			
Note	This class specifies an assignment of a role to a particular service port (RPortPrototype or PPort Prototype) of an AtomicSwComponentType. With this assignment, the role of the service port can be mapped to a specific ServiceNeeds element, so that a tool is able to create the correct connector.			
Base	ARObject			
Attribute	Type	Mult.	Kind	Note
portPrototype	PortPrototype	1	ref	Service PortPrototype used in the assigned role. This PortPrototype shall either belong to the same AtomicSw ComponentType as the SwcInternalBehavior which owns the ServiceDependency or to the same NvBlockSw ComponentType as the NvBlockDescriptor.
role	Identifier	1	attr	This is the role of the assigned Port in the given context. The value shall be a shortName of the Blueprint of a Port Interface as standardized in the Software Specification of the related AUTOSAR Service.

Table 7.57: RoleBasedPortAssignment

Class	RoleBasedDataAssignment			
Package	M2::AUTOSARTemplates::CommonStructure::ServiceNeeds			
Note	This class specifies an assignment of a role to a particular data object in the SwcInternalBehavior of a software component (or in the BswModuleBehavior of a module or cluster) in the context of an AUTOSAR Service. With this assignment, the role of the data can be mapped to a specific ServiceNeeds element, so that a tool is able to create the correct access.			
Base	ARObject			
Attribute	Type	Mult.	Kind	Note
role	Identifier	1	attr	This is the role of the assigned data in the given context, for example for an NVRAM Block it is used to distinguish between an mirror block and a ROM default block. Possible values need to be specified on M1 level. This also is intended to support the so called "Signal based Approach" of the DCM. In this use case the name of the involved data element is required. This name shall be taken from the DataElement referenced by the property usedDataElement. The following values are standardized: <ul style="list-style-type: none"> • ramBlock indicates data to be used as a mirror for an NVRAM Block.





Class	RoleBasedDataAssignment			
				△ <ul style="list-style-type: none"> • defaultValue indicates constant data to be used as default in the context of this ServiceNeeds, e.g. for an NVRAM Block. • signalBasedDiagnostics indicates the RoleBasedDataAssignment shall be used for signal based diagnostics.
usedDataElement	AutosarVariableRef	0..1	aggr	The VariableDataPrototype used in this role, e.g. <ul style="list-style-type: none"> • Permanent RAM Block of an NVRAM Block which shall belong to the same SwcInternalBehavior or BswInternalBehavior. • In the role signalBasedDiagnostics it has to refer to a VariableDataPrototype in a SenderReceiverInterface or a NvDataInterface.
usedParameterElement	AutosarParameterRef	0..1	aggr	The ParameterDataPrototype used in this role, e.g. <ul style="list-style-type: none"> • ROM Block of an NVRAM Block. It shall belong to the same SwcInternalBehavior or BswInternalbehavior. • In the role signalBasedDiagnostics it has to refer to a ParameterDataPrototype in a ParameterInterface.
usedPim	PerInstanceMemory	0..1	ref	The (untyped) PerInstanceMemory used in this role (e.g. as a Permanent RAM Block for an NVRAM Block).

Table 7.58: RoleBasedDataAssignment

Class	RoleBasedDataTypeAssignment			
Package	M2::AUTOSARTemplates::SWComponentTemplate::SwcInternalBehavior::ServiceMapping			
Note	This class specifies an assignment of a role to a particular data type of a software component (or in the BswModuleBehavior of a module or cluster) in the context of an AUTOSAR Service. With this assignment, the role of the data type can be mapped to a specific ServiceNeeds element, so that a tool is able to create the correct access.			
Base	<i>ARObject</i>			
Attribute	Type	Mult.	Kind	Note
role	Identifier	1	attr	This is the role of the associated data type in the given context.
usedImplementationDataType	ImplementationDataType	1	ref	This represents the associated ImplementationDataType.

Table 7.59: RoleBasedDataTypeAssignment

7.12 Variation Point Proxy

[TPS_SWCT_01370] [VariationPointProxy](#) [Variability inside a software-component may exist in two different levels of abstraction:

- A **structural** variation point affects the existence or non-existence of structural model elements. A structural variation point is modeled by means of the meta-class [VariationPoint](#).

- A **functional** variation point affects solely the functionality in the implementation (read: source code) of the software-component. A functional variation point is modeled by means of the meta-class `VariationPointProxy`.

In other words, this enables the developer of a software-component to implement variability that is limited to the software-component's functionality. This kind of variability is resolved

- by a code generator (`bindingTime = codeGenerationTime`)
- by the preprocessor (`bindingTime = preCompileTime`).
- as a post-build value evaluation (in this case `postBuildValueAccess` and `postBuildVariantCondition` shall exist).

]([RS_SWCT_03100](#))

Please note that in the first two cases of the second bullet list in [[TPS_SWCT_01370](#)] the evaluation of `conditionAccess` shall replace the formula by the result.

The name `VariationPointProxy` was motivated by the fact that it represents a model element that is not directly related to the **structure** but to the code and from this point of view acts as a proxy to the **functional** variation existing in the code.

The consequence of the two levels of abstraction is that (from a model processing point of view) it would be possible to bind all structural variation points entirely while keeping some or all of the functional variation points unbound. This is an explanation for the existence of [[TPS_SWCT_01371](#)].

[[TPS_SWCT_01371](#)] **VariationPointProxy vs. VariationPoint** [The difference between a `VariationPoint` and a `VariationPointProxy` is that if during the process of binding the formula evaluates to 0 the `VariationPointProxy` remains in the model while the `VariationPoint` as well as its owner is removed from the model.] ([RS_SWCT_03100](#))

Nevertheless, the binding of the variability is described by the means of `SwSystem-constantValueSets` and `PostBuildVariantCriterionValueSets`.

[[TPS_SWCT_01448](#)] **Pre-defined values for the category of VariationPointProxy** [AUTOSAR pre-defines two possible values for the `category` of `VariationPointProxy`. The meaning of the values, however, depends on the particular modeling of individual `VariationPointProxys`, see [[TPS_SWCT_01370](#)].

VALUE In the “pre-build” case this means that `valueAccess` shall yield an integer literal. In the “post-build” case, on the other hand, this means that `postBuild-ValueAccess` shall yield an integer value conform with the `implementation-DataType`.

In this context, [[constr_1388](#)] applies.

CONDITION In this case it is **possible** (though not mandatory) to define a `VariationPointProxy` that actually works in a combination of the “pre-build” and “post-build” scenario.

In other words, in the “pre-build” case `conditionAccess` shall yield a *boolean* value and in the “post-build” case `postBuildVariantCondition` shall also yield a *boolean* value.

An *and* operator shall be applied to all boolean values returned by `conditionAccess` and the collection of `postBuildVariantCondition` in order to yield the actual result of the condition. [TPS_GST_00259] and [SWS_Rte_08069] apply.

For the `postBuildVariantCondition` an implicit reference to the `PlatformData Type boolean` shall be assumed.

In contrast to the value `VALUE` it is possible to define a `VariationPointProxy` that uses **both** `conditionAccess` **and** `postBuildVariantCondition`.

]([RS_SWCT_03100](#))

[constr_1388] VariationPointProxy of category VALUE shall not mix “pre-build” and “post-build” use-cases [If the value of `category` of the `VariationPointProxy` is set to `VALUE` then there can only be one value yield from the evaluation of a `VariationPointProxy`. In other words, a `VariationPointProxy` of `category VALUE` shall not mix the “pre-build” and “post-build” use-cases.]()

[constr_1389] Restriction regarding the value of category of VariationPointProxy.implementationDataType [`VariationPointProxy.implementationDataType` shall **not** be of `category STRUCTURE, ARRAY, UNION, FUNCTION_REFERENCE, and DATA_REFERENCE`.

The `VariationPointProxy.implementationDataType` shall be of `category VALUE or TYPE_REFERENCE` that, after all references are resolved, yields an `ImplementationDataType` of `category VALUE`.]()

[TPS_SWCT_01372] bindingTime = preCompileTime [In case of `bindingTime = preCompileTime` the RTE provides macro definitions that can be used for pre-processor directives to implement `preCompileTime` variability in C/C++ code.]([RS_SWCT_03100](#))

[TPS_SWCT_01373] RTE generator shall evaluate the SwSystemconstDependentFormula [It is in the scope of the RTE generator to evaluate the `SwSystemconstDependentFormula` which has a higher precedence than the standard C Pre-processor and to provide the resulting values to the software-component’s implementation.]([RS_SWCT_03100](#))

For further details (beyond the statements made in [[TPS_SWCT_01372](#)] and [[TPS_SWCT_01373](#)]) about the impact of the existence of a `VariationPointProxy` on the RTE please refer to [2].

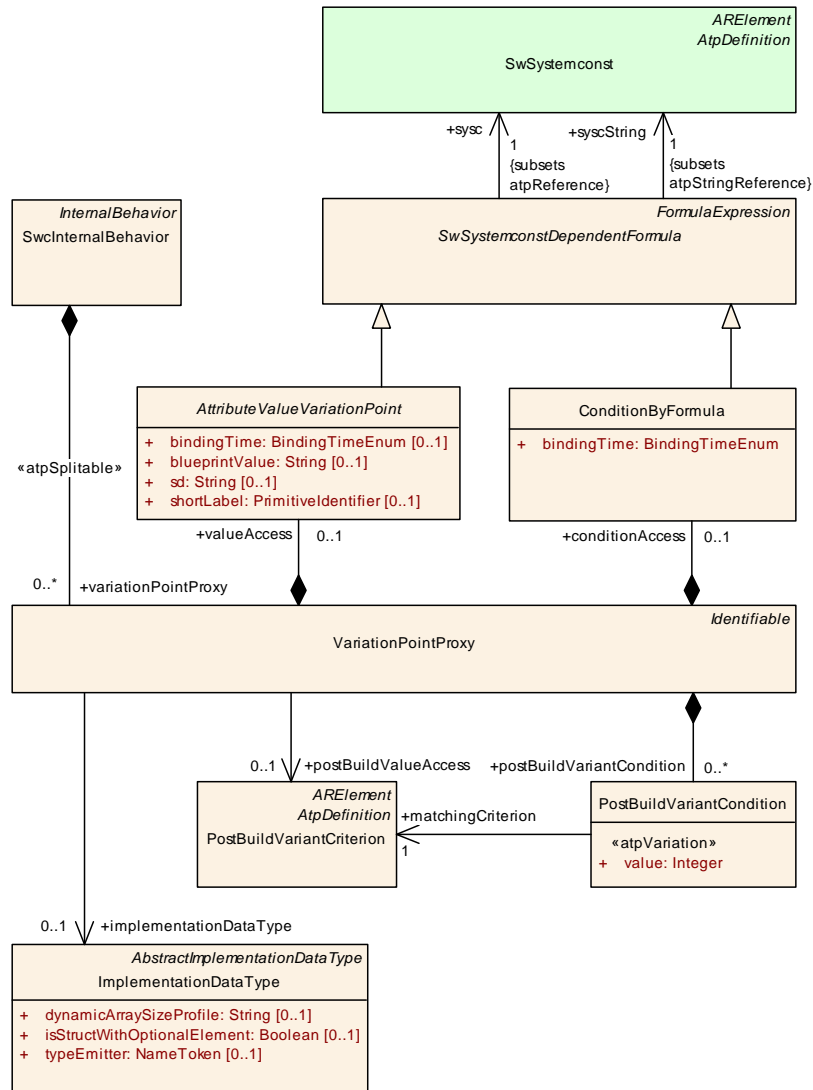

Figure 7.48: VariationPointProxy

Class	VariationPointProxy			
Package	M2::AUTOSARTemplates::SWComponentTemplate::SwcInternalBehavior::VariantHandling			
Note	The VariationPointProxy represents variation points of the C/C++ implementation. In case of bindingTime = compileTime the RTE provides defines which can be used for Pre Processor directives to implement compileTime variability.			
Base	ARObject, Identifiable, MultilanguageReferrable, Referrable			
Attribute	Type	Mult.	Kind	Note
conditionAccess	ConditionByFormula	0..1	aggr	This condition acts as Binding Function for the Variation Point.
implementation DataType	ImplementationDataType	0..1	ref	This association to ImplementationDataType shall be taken as an implementation hint by the RTE generator.





Class	VariationPointProxy			
postBuildValue Access	PostBuildVariant Criterion	0..1	ref	This represents the applicable PostBuildVariantCriterion in the context of a VariationPointProxy. Note that the technical details how to access the particular postBuildValueAccess are still considered internal to the RTE and are consequently not standardized.
postBuildVariant Condition	PostBuildVariant Condition	*	aggr	This represents that applicable PostBuoldVariant Condition in the context of aVariationPointProxy.
valueAccess	AttributeValueVariation Point	0..1	aggr	This value acts as Binding Function for the VariationPoint.

Table 7.60: VariationPointProxy

Please note that the usage of attributes of meta-class [VariationPointProxy](#) is not arbitrarily possible but subject to conditions. In particular, there are certain use-cases that dictate how and with which multiplicity attributes of [VariationPointProxy](#) shall be used.

In particular, the applicable use-cases are defined by a combination of the binding time, i.e. *PreBuild* (all pre-build binding times are summarized as *PreBuild*) vs. *Post-Build*, and the value of [VariationPointProxy.category](#) (the details are explained in table 7.61 or [constr_1253], respectively).

[constr_1253] Supported usage of [VariationPointProxy](#) [The allowed multiplicities for attributes of [VariationPointProxy](#) depending on the applicable binding time and the value of [VariationPointProxy.category](#) are documented in Table 7.61.

For clarification, the multiplicities of attributes of meta-class [VariationPointProxy](#) that are **not** explicitly mentioned in a given row of table 7.61 shall be interpreted as [0..1]

BindingTime	category	Allowed Attribute Multiplicity
<i>PreBuild</i>	VALUE	valueAccess [1]
	CONDITION	conditionAccess [1]
<i>PostBuild</i>	VALUE	postBuildValueAccess [1], implementationDataType [1]
	CONDITION	postBuildVariantCondition [1..*], conditionAccess [0..1]

Table 7.61: Supported usage of [VariationPointProxy](#)

Class	<<atpMixedString>> ConditionByFormula
Package	M2::AUTOSARTemplates::GenericStructure::VariantHandling





Class	<<atpMixedString>> ConditionByFormula			
Note	<p>This class represents a condition which is computed based on system constants according to the specified expression. The expected result is considered as boolean value.</p> <p>The result of the expression is interpreted as a condition.</p> <ul style="list-style-type: none"> • "0" represents "false"; • a value other than zero is considered "true" 			
Base	<i>ARObject, FormulaExpression, SwSystemconstDependentFormula</i>			
Attribute	Type	Mult.	Kind	Note
bindingTime	BindingTimeEnum	1	attr	<p>This attribute specifies the point in time when condition may be evaluated at earliest. At this point in time all referenced system constants shall have a value.</p> <p>Tags:xml.attribute=true</p>

Table 7.62: ConditionByFormula

Class	<<atpMixedString>> AttributeValueVariationPoint (abstract)			
Package	M2::AUTOSARTemplates::GenericStructure::VariantHandling::AttributeValueVariationPoints			
Note	This class represents the ability to derive the value of the Attribute from a system constant (by Sw SystemconstDependentFormula). It also provides a bindingTime.			
Base	<i>ARObject, FormulaExpression, SwSystemconstDependentFormula</i>			
Subclasses	<i>AbstractEnumerationValueVariationPoint, AbstractNumericalVariationPoint, BooleanValueVariationPoint, FloatValueVariationPoint, IntegerValueVariationPoint, NameTokenValueVariationPoint, PositiveIntegerValueVariationPoint, TimeValueValueVariationPoint, UnlimitedIntegerValueVariationPoint</i>			
Attribute	Type	Mult.	Kind	Note
bindingTime	BindingTimeEnum	0..1	attr	<p>This is the binding time in which the attribute value needs to be bound.</p> <p>If this attribute is missing, the attribute is not a variation point. In particular this means that It needs to be a single value according to the type specified in the pure model. It is an error if it is still a formula.</p> <p>Tags:xml.attribute=true</p>
blueprintValue	String	0..1	attr	<p>This represents a description that documents how the value shall be defined when deriving objects from the blueprint.</p> <p>Tags:xml.attribute=true</p>
sd	String	0..1	attr	<p>This special data is provided to allow synchronization of Attribute value variation points with variant management systems. The usage is subject of agreement between the involved parties.</p> <p>Tags:xml.attribute=true</p>
shortLabel	PrimitiveIdentifier	0..1	attr	<p>This allows to identify the variation point. It is also intended to allow RTE support for CompileTime Variation points.</p> <p>Tags:xml.attribute=true</p>

Table 7.63: AttributeValueVariationPoint

Class	PostBuildVariantCriterion			
Package	M2::AUTOSARTemplates::GenericStructure::VariantHandling			
Note	This class specifies one particular PostBuildVariantSelector. Tags: atp.recommendedPackage=PostBuildVariantCriteria			
Base	ARElement , ARObject , AtpDefinition , CollectableElement , Identifiable , MultilanguageReferrable , PackageableElement , Referrable			
Attribute	Type	Mult.	Kind	Note
compuMethod	CompuMethod	1	ref	The compuMethod specifies the possible values for the variant criterion serving as an enumerator.

Table 7.64: PostBuildVariantCriterion

Class	PostBuildVariantCondition			
Package	M2::AUTOSARTemplates::GenericStructure::VariantHandling			
Note	This class specifies the value which shall be assigned to a particular variant criterion in order to bind the variation point. If multiple criterion/value pairs are specified, they shall all match to bind the variation point. In other words binding can be represented by (criterion1 == value1) && (condition2 == value2) ...			
Base	ARObject			
Attribute	Type	Mult.	Kind	Note
matching Criterion	PostBuildVariantCriterion	1	ref	This is the criterion which needs to match the value in order to make the PostbuildVariantCondition to be true.
value	Integer	1	attr	This is the particular value of the post-build variant criterion. Stereotypes: atpVariation Tags: vh.latestBindingTime=preCompileTime

Table 7.65: PostBuildVariantCondition

8 Implementation

Previous versions of this document contained a comprehensive description of the meta-class `Implementation`. This meta-class still exists but the description of most of its content has been moved to another document, in particular the specification of the Basic Software Module Description Template [6].

Please note that the Software Component Template and the Basic Software Module Description Template share the content of `Implementation`. However, the semantics of `Implementation` is closer to the Basic Software Module Description Template.

Nevertheless, there is still content strictly related to the Software Component Template. This part of `Implementation` consisting of `SwcImplementation` (see Figure 8.1) remains in this document.

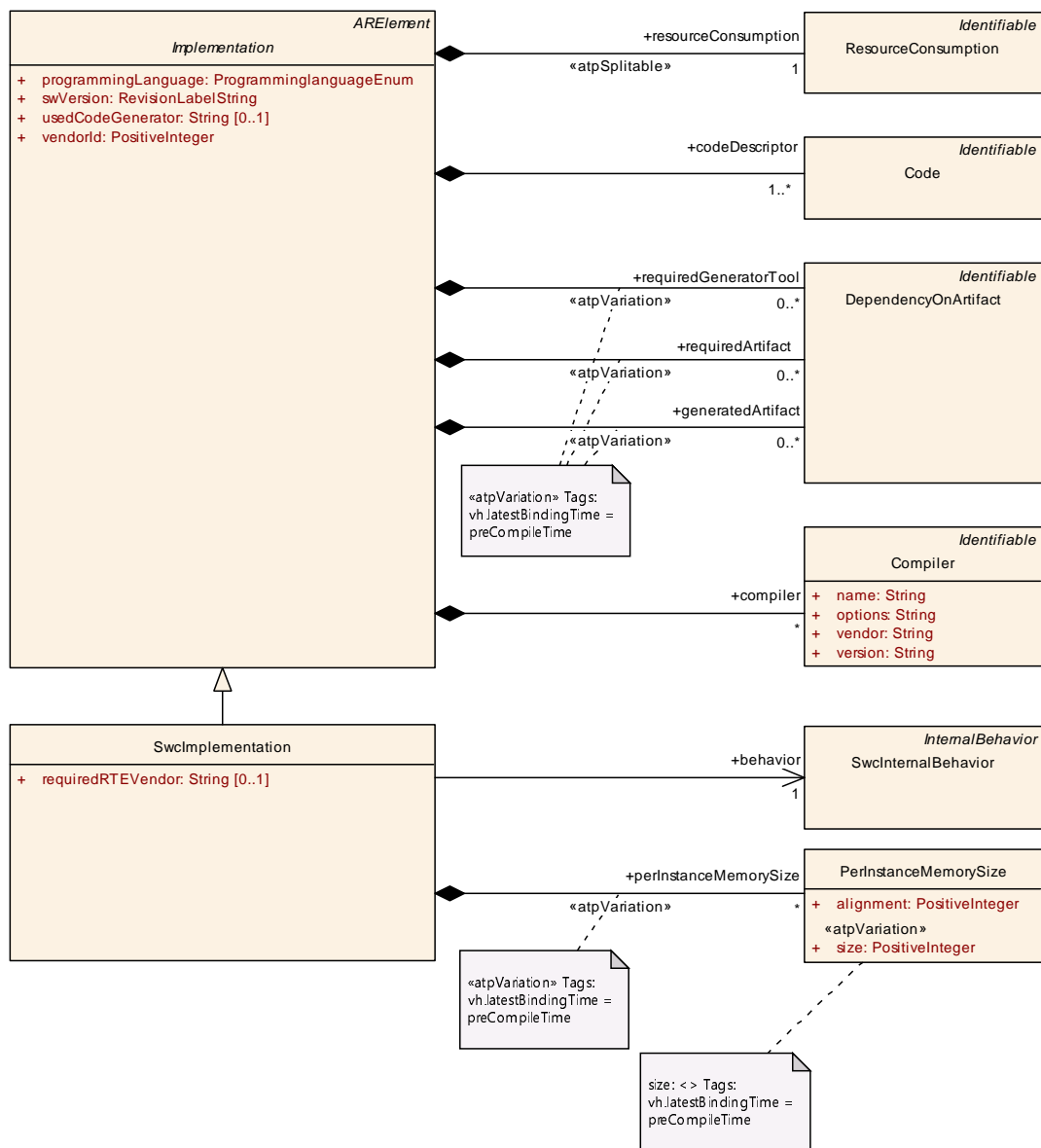

Figure 8.1: Implementation part specific to the Software Component Template

Class	Implementation (abstract)			
Package	M2::AUTOSARTemplates::CommonStructure::Implementation			
Note	Description of an implementation a single software component or module.			
Base	ARElement , ARObject , CollectableElement , Identifiable , MultilanguageReferrable , PackageableElement , Referrable			
Subclasses	BswImplementation , SwcImplementation			
Attribute	Type	Mult.	Kind	Note
buildActionManifest	BuildActionManifest	0..1	ref	A manifest specifying the intended build actions for the software delivered with this implementation. Stereotypes: atpVariation Tags: vh.latestBindingTime=codeGenerationTime
codeDescriptor	Code	1..*	aggr	Specifies the provided implementation code.
compiler	Compiler	*	aggr	Specifies the compiler for which this implementation has been released
generatedArtifact	DependencyOnArtifact	*	aggr	Relates to an artifact that will be generated during the integration of this Implementation by an associated generator tool. Note that this is an optional information since it might not always be in the scope of a single module or component to provide this information. Stereotypes: atpVariation Tags: vh.latestBindingTime=preCompileTime
hwElement	HwElement	*	ref	The hardware elements (e.g. the processor) required for this implementation.
linker	Linker	*	aggr	Specifies the linker for which this implementation has been released.
mcSupport	McSupportData	0..1	aggr	The measurement & calibration support data belonging to this implementation. The aggregation is <<atpSplitable>> because in case of an already existing BSW Implementation model, this description will be added later in the process, namely at code generation time. Stereotypes: atpSplitable Tags: atp.Splitkey=mcSupport
programmingLanguage	ProgramminglanguageEnum	1	attr	Programming language the implementation was created in.
requiredArtifact	DependencyOnArtifact	*	aggr	Specifies that this Implementation depends on the existence of another artifact (e.g. a library). This aggregation of DependencyOnArtifact is subject to variability with the purpose to support variability in the implementations. Different algorithms in the implementation might cause different dependencies, e.g. the number of used libraries. Stereotypes: atpVariation Tags: vh.latestBindingTime=preCompileTime
requiredGeneratorTool	DependencyOnArtifact	*	aggr	Relates this Implementation to a generator tool in order to generate additional artifacts during integration. Stereotypes: atpVariation Tags: vh.latestBindingTime=preCompileTime
resourceConsumption	ResourceConsumption	1	aggr	All static and dynamic resources for each implementation are described within the ResourceConsumption class. Stereotypes: atpSplitable Tags: atp.Splitkey=shortName





Class	Implementation (abstract)			
swcBswMapping	SwcBswMapping	0..1	ref	This allows a mapping between an SWC and a BSW behavior to be attached to an implementation description (for AUTOSAR Service, ECU Abstraction and Complex Driver Components). It is up to the methodology to define whether this reference has to be set for the Swc- or Bsw Implementation or for both.
swVersion	RevisionLabelString	1	attr	Software version of this implementation. The numbering contains three levels (like major, minor, patch), its values are vendor specific.
usedCodeGenerator	String	0..1	attr	Optional: code generator used.
vendorId	PositiveInteger	1	attr	Vendor ID of this Implementation according to the AUTOSAR vendor list

Table 8.1: Implementation

Class	SwcImplementation			
Package	M2::AUTOSARTemplates::SWComponentTemplate::SwcImplementation			
Note	This meta-class represents a specialization of the general Implementation meta-class with respect to the usage in application software. Tags: atp.recommendedPackage=SwcImplementations			
Base	ARElement , ARObject , CollectableElement , Identifiable , Implementation , MultilanguageReferrable , PackageableElement , Referrable			
Attribute	Type	Mult.	Kind	Note
behavior	SwcInternalBehavior	1	ref	The internal behavior implemented by this Implementation.
perInstanceMemorySize	PerInstanceMemorySize	*	aggr	Allows a definition of the size of the per-instance memory for this implementation. The aggregation of PerInstanceMemorySize is subject to variability with the purpose to support variability in the software components implementations. Typically different algorithms in the implementation are requiring different number of memory objects, in this case PerInstanceMemory. Stereotypes: atpVariation Tags: vh.latestBindingTime=preCompileTime
requiredRTEVendor	String	0..1	attr	Identify a specific RTE vendor. This information is potentially important at the time of integrating (in particular: linking) the application code with the RTE. The semantics is that (if the association exists) the corresponding code has been created to fit to the vendor-mode RTE provided by this specific vendor. Attempting to integrate the code with another RTE generated in vendor mode is in general not possible.

Table 8.2: SwcImplementation

Class	PerInstanceMemorySize
Package	M2::AUTOSARTemplates::SWComponentTemplate::SwcImplementation
Note	Resources needed by the allocation of PerInstanceMemory for each SWC instance. Note that these resources are not covered by an ObjectFileSection, because they are supposed to be allocated by the RTE.





Class		PerInstanceMemorySize		
Base		<i>ARObject</i>		
Attribute	Type	Mult.	Kind	Note
alignment	PositiveInteger	1	attr	Required alignment (1,2,4,...) of the referenced Per InstanceMemory. Unit: byte.
perInstanceMemory	PerInstanceMemory	1	ref	This represents the referenced PerInstanceMemory.
size	PositiveInteger	1	attr	Size (in bytes) of the reference perInstanceMemory. The aggregation of PerInstanceMemorySize is subject to variability with the purpose to support variability in the software components implementations. Different algorithms in the implementation might require a different PerInstanceMemorySize. Stereotypes: atpVariation Tags: vh.latestBindingTime=preCompileTime

Table 8.3: PerInstanceMemorySize

9 Mode Management

In general, the `Software Component Template` doesn't define the kind of modes that shall be supported by `State Managers` or software-components explicitly. However the `Software Component Template` provides generic mechanisms for describing modes.

In this section the general relationship between modes, interfaces, and software-components is discussed.

The assumption from the software-component point of view is that `State Managers` are using a Standardized AUTOSAR `PortInterface`¹ to influence the `SwComponentType` and also provide a `PortInterface` to get requests and confirmations from the `SwComponentType`.

They will be implemented as `AUTOSAR services` and be part of the `Basic Software` on each ECU. The actual modes a `State Manager` provides will have to be standardized as well to allow compatibility between software-components.

It is also possible to define a mode manager in the `Application Software` and the same functionality is supported as for mode managers implemented in the `Basic Software`.

[TPS_SWCT_01581] Communication patterns for mode-related communication [Mode-related communication shall implement a 1:1 or 1:n scenario but the creation of an n:1 configuration shall be considered invalid.] ([RS_SWCT_03200](#), [RS_SWCT_03110](#))

As a consequence of [\[TPS_SWCT_01581\]](#), [\[constr_1101\]](#) is formulated.

[constr_1101] Mode-related communication [An `RPortPrototype` typed by `ModeSwitchInterface` shall not be referenced by more than one `SwConnector`.] ()

9.1 Declaration of Modes

The `SW-Component Template` provides some simple means to define collections of modes.

[TPS_SWCT_01071] ModeDeclaration [The name of the mode is the most important attribute that has to be provided for each `ModeDeclaration`. The `ModeDeclarations` are grouped together within the `ModeDeclarationGroup`.] ([RS_SWCT_03200](#), [RS_SWCT_03110](#))

[TPS_SWCT_01067] Initial mode [The `initialMode` is active before any mode switches occurred.] ([RS_SWCT_03200](#))

This is shown in [Figure 9.1](#)

¹See also AUTOSAR Glossary for "Standardized AUTOSAR Interface".

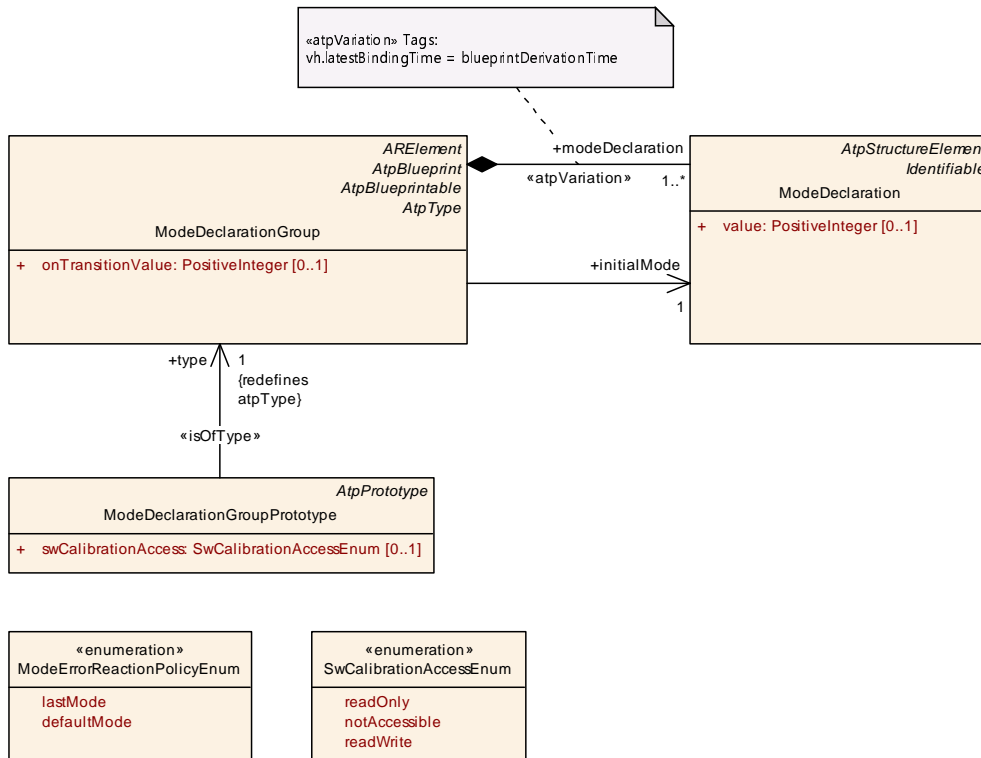

Figure 9.1: ModeDeclaration

The class `ModeDeclarationGroup` has been introduced to support the grouping of modes and (on M1 level) to provide predefined sets of modes that could be standardized and re-used. The set of modes eventually defines a flat (i.e. no hierarchical states) state-machine where only one mode can be active at a given point in time.

Again, please note that the actual definition of modes and their relationship is not in the responsibility of this document. In other words: the definition of modes represents M1 artifacts whereas this document is limited to describing M2 model elements.

Both `ModeDeclaration` and `ModeDeclarationGroup` own attributes that facilitate the generation of C source code from the formal definition.

[TPS_SWCT_01008] Definition of positive integer values that are directly taken over by the RTE generator for creating the programmatic representations of the `ModeDeclaration` [The attributes `ModeDeclaration.value` and `ModeDeclarationGroup.onTransitionValue` allow for the definition of positive integer values that are directly taken over by the RTE generator for creating the programmatic representations of the `ModeDeclaration` and `ModeDeclarationGroup` in the source code.] ([RS_SWCT_03200](#))

[constr_1399] Standardized values of `ModeDeclarationGroup.category` [The AUTOSAR standard defines the following values of the attribute `ModeDeclarationGroup.category` with a standardized meaning:

- EXPLICIT_ORDER
- ALPHABETIC_ORDER

[TPS_SWCT_01010] defines the meaning of these values.

It is **not allowed** to define any custom or project-specific value of the attribute `ModeDeclarationGroup.category`.()

As the attributes `ModeDeclaration.value` and `ModeDeclarationGroup.onTransitionValue` are optional the following rule applies:

[constr_1298] Existence of attributes if `category` of a `ModeDeclarationGroup` is set to `EXPLICIT_ORDER` [The attributes `ModeDeclarationGroup.onTransitionValue` and `ModeDeclaration.value` (for each `ModeDeclaration`) shall be set if the `category` of a `ModeDeclarationGroup` is set to `EXPLICIT_ORDER`.]()

[constr_1299] Existence of attributes if `category` of a `ModeDeclarationGroup` is set to other than `EXPLICIT_ORDER` [The attributes `ModeDeclarationGroup.onTransitionValue` or `ModeDeclaration.value` (for any `ModeDeclaration`) shall **not** be set if the `category` of a `ModeDeclarationGroup` is set to any value other than `EXPLICIT_ORDER`.]()

[constr_1181] Numerical values used in `ModeDeclaration.value` and `ModeDeclarationGroup.onTransitionValue` [The numerical values used to define the `value` attributes and the `onTransitionValue` attribute of a `ModeDeclarationGroup` shall not overlap.]()

In other words, it is not allowed that the values of two `value` attributes within one `ModeDeclarationGroup` have the same numerical value. Neither is it allowed that the numerical value of the `ModeDeclarationGroup.onTransitionValue` attribute and the numerical value of one of the corresponding `value` attributes are identical.

[TPS_SWCT_01009] The numerical values used to define the values of `ModeDeclaration.value` and `ModeDeclarationGroup.onTransitionValue` can be arbitrarily defined [As long as the constraints [constr_1181], [constr_1298], and [constr_1299] are fulfilled, the numerical values used to define the values of `ModeDeclaration.value` and `ModeDeclarationGroup.onTransitionValue` can be arbitrarily defined. The numerical values are not required to be consecutive. Gaps are positively allowed.](*RS_SWCT_03200*)

Example: the following example of a set of numerical values fulfills all requirements on the definition of `ModeDeclaration.value` and `ModeDeclarationGroup.onTransitionValue`: {1,2, 5, 100}.

Please note that the ability to define `ModeDeclaration.value` and `ModeDeclarationGroup.onTransitionValue` introduces second heuristics for “ordering” `ModeDeclarations`. If `ModeDeclaration.value` and `ModeDeclarationGroup.onTransitionValue` are not defined the assignment of numerical values to the representations of individual `ModeDeclarations` it is up to the RTE generator to come up with the applicable numerical values.

[TPS_SWCT_01010] `category`s for the definition of a `ModeDeclarationGroup` [In order to support a clear separation between the two possible ways to influence the

definition of the programmatic representation of `ModeDeclarations` two `category`s shall be defined for the definition of a `ModeDeclarationGroup`.

- The value of `category` of a `ModeDeclarationGroup` shall be set to `EXPLICIT_ORDER` if it is intended to control the source code generation by means of the values of the attributes `ModeDeclaration.value` and `ModeDeclarationGroup.onTransitionValue`.
- The value of `category` of a `ModeDeclarationGroup` shall be set to `ALPHABETIC_ORDER` if it is intended to let the RTE generator control the source code generation according to the alphabetical sorting.

]([RS_SWCT_03200](#))

More information regarding this aspect can be found in [SWS_Rte_02568].

[TPS_SWCT_01011] Default `category` of a `ModeDeclarationGroup` [For reasons of backwards-compatibility with previous releases of AUTOSAR the default value of the `category` of a `ModeDeclarationGroup` shall be `ALPHABETIC_ORDER`.] ([RS_SWCT_03200](#))

Class	ModeDeclaration			
Package	M2::AUTOSARTemplates::CommonStructure::ModeDeclaration			
Note	Declaration of one Mode. The name and semantics of a specific mode is not defined in the meta-model. Tags: atp.ManifestKind=ExecutionManifest,MachineManifest			
Base	<i>ARObject</i> , <i>AtpClassifier</i> , <i>AtpFeature</i> , <i>AtpStructureElement</i> , <i>Identifiable</i> , <i>MultilanguageReferrable</i> , <i>Referrable</i>			
Attribute	Type	Mult.	Kind	Note
value	PositiveInteger	0..1	attr	The RTE shall take the value of this attribute for generating the source code representation of this Mode Declaration.

Table 9.1: ModeDeclaration

Class	ModeDeclarationGroup			
Package	M2::AUTOSARTemplates::CommonStructure::ModeDeclaration			
Note	A collection of Mode Declarations. Also, the initial mode is explicitly identified. Tags: atp.ManifestKind=ExecutionManifest,MachineManifest atp.recommendedPackage=ModeDeclarationGroups			
Base	<i>ARElement</i> , <i>ARObject</i> , <i>AtpBlueprint</i> , <i>AtpBlueprintable</i> , <i>AtpClassifier</i> , <i>AtpType</i> , <i>CollectableElement</i> , <i>Identifiable</i> , <i>MultilanguageReferrable</i> , <i>PackageableElement</i> , <i>Referrable</i>			
Attribute	Type	Mult.	Kind	Note
initialMode	ModeDeclaration	1	ref	The initial mode of the ModeDeclarationGroup. This mode is active before any mode switches occurred.
mode Declaration	ModeDeclaration	1..*	aggr	The ModeDeclarations collected in this ModeDeclaration Group. Stereotypes: atpVariation Tags: vh.latestBindingTime=blueprintDerivationTime





Class	ModeDeclarationGroup			
modeManager ErrorBehavior	ModeErrorBehavior	0..1	aggr	This represents the ability to define the error behavior expected by the mode manager in case of errors on the mode user side (e.g. terminated mode user).
modeTransition	ModeTransition	*	aggr	This represents the available ModeTransitions of the ModeDeclarationGroup
modeUserError Behavior	ModeErrorBehavior	0..1	aggr	This represents the definition of the error behavior expected by the mode user in case of errors on the mode manager side (e.g. terminated mode manager).
onTransition Value	PositiveInteger	0..1	attr	The value of this attribute shall be taken into account by the RTE generator for programmatically representing a value used for the transition between two statuses.

Table 9.2: ModeDeclarationGroup

[TPS_SWCT_01450] **Semantics of a [ModeTransition](#)** [In addition to the ability to specify [ModeDeclarations](#) within a [ModeDeclarationGroup](#) it is also feasible to define possible transitions between [ModeDeclarations](#) within the given [ModeDeclarationGroup](#). This can be done by means of aggregation [ModeTransition](#) at [ModeDeclarationGroup](#) in the role `modeTransition`.] ([RS_SWCT_03200](#))

More details are explained in [Figure 9.2](#).

[TPS_SWCT_01451] **Relations between [ModeTransition](#) and [ModeDeclaration](#)** [[ModeTransition](#) has two associations with the multiplicity 1 to [ModeDeclaration](#):

- The reference `enteredMode` denotes a [ModeDeclaration](#) that can be entered as part of the enclosing [ModeTransition](#).
- The reference `exitedMode` denotes a [ModeDeclaration](#) that can be exited as part of the enclosing [ModeTransition](#).

] ([RS_SWCT_03200](#))

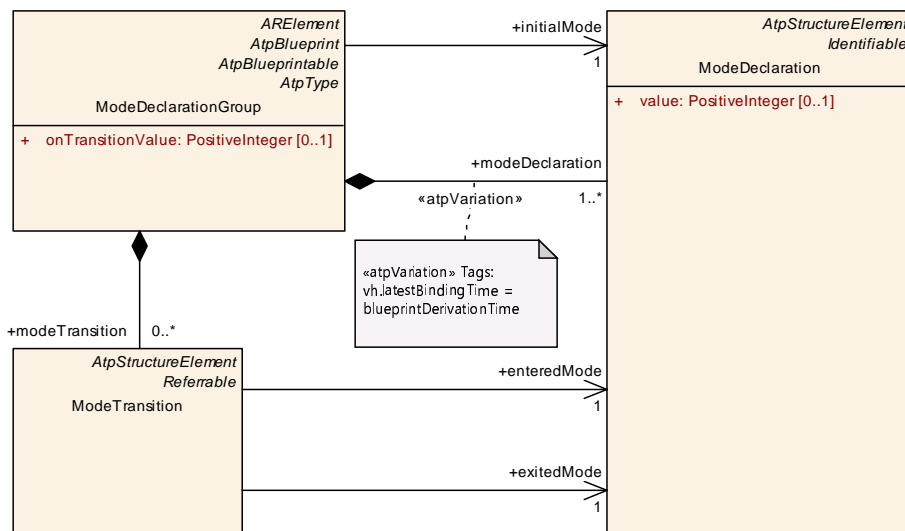

Figure 9.2: ModeTransition

[constr_1193] ModeDeclaration shall be referenced by at least one ModeTransition in the role enteredMode [For each `ModeDeclaration` at least one `ModeTransition` shall reference the `ModeDeclaration` in the role `enteredMode`. This constraint shall apply **only** if there is at least one `ModeTransition` defined in the context of the enclosing `ModeDeclarationGroup` and it shall **not** apply to the `initialMode`.]()

For clarification, the `ModeDeclarationGroup.initialMode` does not need to be referenced by an `enteredMode` because by identifying this `ModeDeclaration` in the role `initialMode` it is clear that the `ModeDeclaration` will be entered at least once.

Class	ModeTransition			
Package	M2::AUTOSARTemplates::CommonStructure::ModeDeclaration			
Note	This meta-class represents the ability to describe possible <code>ModeTransitions</code> in the context of a <code>ModeDeclarationGroup</code> .			
Base	<code>ARObject</code> , <code>AtpClassifier</code> , <code>AtpFeature</code> , <code>AtpStructureElement</code> , <code>Identifiable</code> , <code>MultilanguageReferrable</code> , <code>Referrable</code>			
Attribute	Type	Mult.	Kind	Note
<code>enteredMode</code>	<code>ModeDeclaration</code>	1	ref	This represents the entered model of the <code>ModeTransition</code> .
<code>exitedMode</code>	<code>ModeDeclaration</code>	1	ref	This represents the exited mode of the <code>ModeTransition</code>

Table 9.3: ModeTransition

9.2 Modes and Events

[TPS_SWCT_01376] Software-components need to be capable of reacting to state changes [Software-components need to be capable of reacting to state changes issued by some `Mode Manager` and adopt their behavior to the new situation.]([RS_SWCT_03110](#))

Such a mode dependent software-component is shown in [Figure 9.3](#).

[TPS_SWCT_01077] Configure the response to mode changes [Since the behavior of `AtomicSwComponentTypes` is mainly determined by the `RunnableEntities` contained in the `SwcInternalBehavior`, it is necessary to configure the response to mode changes on the level of `RunnableEntities`.]([RS_SWCT_03120](#))

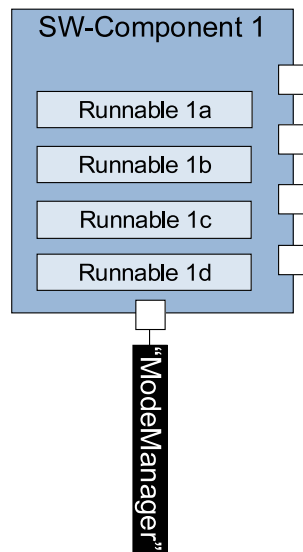

Figure 9.3: State Managers and software-components

Figure 9.4 shows an excerpt of the meta-model illustrating how the relationship between the current mode and the `SwcInternalBehavior` of the `AtomicSwComponentType` can be described.

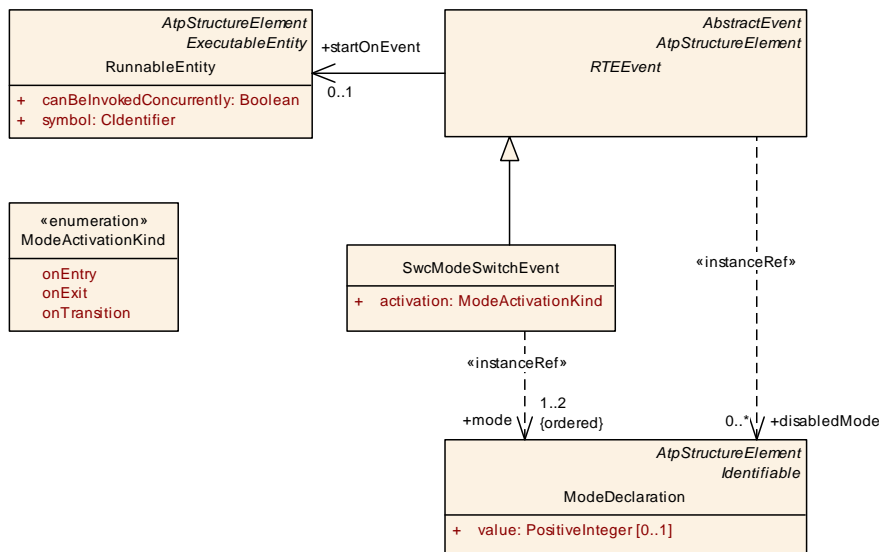

Figure 9.4: Modes and events

[TPS_SWCT_01377] Two mechanisms to define how `SwcInternalBehavior` should interact with the mode management [A `AtomicSwComponentType` can use two mechanisms to define how its `SwcInternalBehavior` should interact with the mode management.] (*RS_SWCT_03110*)

Both mechanisms are visible in Figure 9.4.

[TPS_SWCT_01378] `AtomicSwComponentType` can define an `SwcModeSwitchEvent` to execute `RunnableEntity` [Using the first mechanism, an `AtomicSwComponentType` can define an `SwcModeSwitchEvent` to specify that a

particular `RunnableEntity` shall be started whenever a mode is entered, exited, or a transition between two specified modes occurs.](*RS_SWCT_03110*)

[constr_4003] Semantics of `SwcModeSwitchEvent` [If the value of `SwcModeSwitchEvent.activation` is `onTransition` then `SwcModeSwitchEvent` shall refer to two different `ModeDeclarations` belonging to the same instance of `ModeDeclarationGroup`.

Their order defines the direction of the transition from one mode into another. In all other cases `SwcModeSwitchEvent` shall refer to exactly one `ModeDeclaration`.]()

[constr_1195] `SwcModeSwitchEvent` and the definition of `ModeTransition` [For each pair of `ModeDeclarations` referenced by a `SwcModeSwitchEvent` with attribute `activation` set to `onTransition` a `ModeTransition` shall be defined in the corresponding direction (i.e. from `exitedMode` to `enteredMode`). This constraint shall only apply if the respective `ModeDeclarationGroup` defines at least one `modeTransition`.]()

[TPS_SWCT_01379] `AtomicSwComponentType` can indicate whether an `RTEEvent` that starts an associated `RunnableEntity` is disabled in a certain mode [Using the second mechanism, the `AtomicSwComponentType` can indicate whether an `RTEEvent` that starts an associated `RunnableEntity` is disabled in a certain mode.

That is, `RTEEvents` without an association in the role `disabledMode` are processed regularly according to their definition.

`RTEEvents` with the optional association `disabledMode` have the additional limitation that the associated `RunnableEntity` is *not* started when the `ModeDeclaration` referenced as `disabledMode` is active.](*RS_SWCT_03110*)

The mechanisms discussed so far have to be applied for the `SwcInternalBehavior` on the receiver side of mode switches. Since mode switches are received via `PortPrototypes` the following constraints apply:

[TPS_SWCT_01380] Mode management behavior on the sender side [On the sender side, a `RunnableEntity` shall have `ModeSwitchPoints` that eventually associate a `RunnableEntity` with the specific `ModeDeclarationGroups` which it manages.](*RS_SWCT_03110*)

For more information, please refer to Figure 9.5.

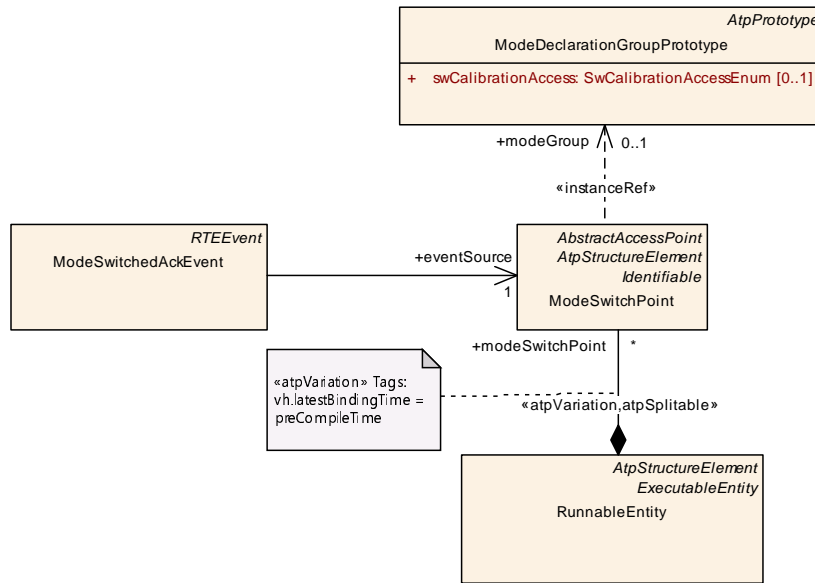

Figure 9.5: ModeSwitchPoint

Class	ModeSwitchPoint			
Package	M2::AUTOSARTemplates::SWComponentTemplate::SwcInternalBehavior::ModeDeclarationGroup			
Note	A ModeSwitchPoint is required by a RunnableEntity owned a Mode Manager. Its semantics implies the ability to initiate a mode switch.			
Base	ARObject, AbstractAccessPoint, AtpClassifier, AtpFeature, AtpStructureElement, Identifiable, MultilanguageReferrable, Referrable			
Attribute	Type	Mult.	Kind	Note
modeGroup	ModeDeclarationGroup Prototype	0..1	iref	The mode declaration group that is switched by this runnable.

Table 9.4: ModeSwitchPoint

[TPS_SWCT_01383] **ModeSwitchPoint** [The ModeSwitchPoint also allows for the definition of a ModeSwitchedAckEvent if this is requested by the definition of the PPortPrototype. This RTEEvent is eventually owned by a mode manager to allow for getting confirmation of a mode change.](RS_SWCT_03110)

[TPS_SWCT_01555] **ModeSwitchedAckEvent is triggered by the RTE regardless** [The ModeSwitchedAckEvent is triggered by the RTE (for more details please refer to [2]) regardless which RunnableEntity has requested the mode switch notification, even if the Meta Model implies a reference from ModeSwitchedAckEvent to a specific ModeSwitchPoint in the role eventSource.](RS_SWCT_03110)

[constr_4012] **Timeout of ModeSwitchedAckEvent** [The timeout value of a Wait-Point associated with a ModeSwitchedAckEvent shall be equal to the corresponding ModeSwitchedAckRequest.timeout.]()

[TPS_SWCT_01381] **Read the currently active mode** [For Mode Manager and Mode User it might additionally be required to read the currently active mode. For

that purpose, a `RunnableEntity` that requires read-access to the `ModeDeclarationGroupPrototype`'s current mode has to define a `ModeAccessPoint`.] ([RS_SWCT_03110](#))

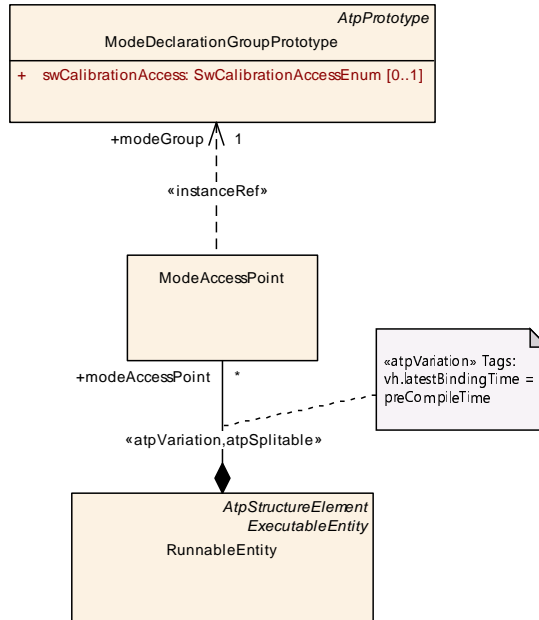

Figure 9.6: ModeAccessPoint

Class	ModeAccessPoint			
Package	M2::AUTOSARTemplates::SWComponentTemplate::SwcInternalBehavior::ModeDeclarationGroup			
Note	A ModeAccessPoint is required by a RunnableEntity owned by a Mode Manager or Mode User. Its semantics implies the ability to access the current mode (provided by the RTE) of a ModeDeclarationGroupPrototype's ModeDeclarationGroup.			
Base	ARObject			
Attribute	Type	Mult.	Kind	Note
ident	ModeAccessPointIdent	0..1	aggr	The aggregation in the role ident provides the ability to make the ModeAccessPoint identifiable. From the semantical point of view, the ModeAccessPoint is considered a first-class Identifiable and therefore the aggregation in the role ident shall always exist (until it may be possible to let ModeAccessPoint directly inherit from Identifiable). Tags: atp.Status=shallBecomeMandatory xml.sequenceOffset=-100
modeGroup	ModeDeclarationGroupPrototype	0..1	iref	The mode declaration group that is accessed by this runnable. Tags: xml.typeElement=true

Table 9.5: ModeAccessPoint

[TPS_SWCT_01382] Mode switch requests are handled asynchronously by the RTE [Mode switch requests are handled asynchronously by the RTE. Therefore, Mode

Managers implementation might require reading back the current active mode to synchronize internally to the RTE. A `ModeSwitchPoint` does **not** automatically provide read access to the `ModeDeclarationGroupPrototype`'s current mode. [\(RS_SWCT_03110\)](#)

[constr_1098] Mode switch and mode disabling [A `SwcModeSwitchEvent` shall not simultaneously reference to the same `ModeDeclaration` in both the roles `mode` and `disabledMode`.]()

If [\[constr_1098\]](#) would not apply it might happen that a `RunnableEntity` would be triggered by a `SwcModeSwitchEvent` and on the same time it would be suppressed by the mode disabling.

9.3 Initialization / Finalization

The AUTOSAR standard shall support the execution of initialization code for every `AtomicSwComponentType`.

[TPS_SWCT_01384] Execution of initialization code for software-components [Most `AtomicSwComponentTypes` will need to initialize by executing specific code; this code shall complete before any other code in the component is executed. Data will be initializing to specific values before the "normal" application software is running.] [\(RS_SWCT_03110\)](#)

[TPS_SWCT_01385] Execution of finalization code for software-components [Most `AtomicSwComponentTypes` will need to finalize by calling specific code; this code shall complete before the functionality of the application software shut down (e.g. a motor drive in a start or end position).] [\(RS_SWCT_03110\)](#)

[TPS_SWCT_01388] Initial modes of `AtomicSwComponentTypes` are defined by the `initialMode` [The initial modes of `AtomicSwComponentTypes` are defined by the `initialMode` references of the required `ModeDeclarationGroups`. These modes are activated before any other mode activation has occurred. It is the responsibility of the RTE to activate all initial modes on a certain ECU.] [\(RS_SWCT_03110\)](#)

For more details please refer to the specification of the SWS RTE [2].

9.4 Mode Error Behavior

With the advent of partitions in the AUTOSAR standard, it is important to consider the behavior of mode management with respect to the following scenarios:

- The partition of the mode manager is terminated.
- The partition of the mode user is terminated.

Whenever one of the two scenarios becomes reality, it is important to implement a stable reaction of both mode manager and mode user to the event. In addition, mode manager and mode user should be able to synchronize in terms of which mode shall apply as fast and seamless as possible.

For this purpose, additional modeling support has been defined such that the applicable `ModeDeclarationGroup` (which is part of the contract between mode manager and mode user) becomes the place where the policy towards a reaction to e.g. a partition restart is defined.

[TPS_SWCT_01530] Error behavior of mode manager and mode user [The behavior in response to a mode manager getting out of sync with a mode user (because the partition of the mode user has been terminated) or vice versa (because the partition of the mode manager has been terminated) can be defined for the mode manager by means of the attribute `ModeDeclarationGroup.modeManagerErrorBehavior` and for the mode user by means of the attribute `ModeDeclarationGroup.modeUserErrorBehavior`.] (*RS_SWCT_03110*)

[TPS_SWCT_01531] The semantics of `ModeErrorReactionPolicyEnum` [The attribute `ModeErrorBehavior.errorReactionPolicy` shall be used to specify the behavior in the event of a mode error:

`lastMode` The last mode applicable before the event shall be assumed.

`defaultMode` This represents the ability to specify a dedicated mode that shall be made applicable. The identified `ModeDeclaration` could be identical to the `ModeDeclarationGroup.initialMode` but it can just as well be any other `ModeDeclaration` defined in the context of the enclosing `ModeDeclarationGroup`.

] (*RS_SWCT_03110*)

[TPS_SWCT_01532] The role of `ModeErrorBehavior.defaultMode` [The attribute `ModeErrorBehavior.defaultMode` shall be used to identify the particular `ModeDeclaration` if `ModeErrorBehavior.errorReactionPolicy` is set to `defaultMode`.] (*RS_SWCT_03110*)

[constr_1263] Existence of `ModeErrorBehavior.defaultMode` [The optional attribute `ModeErrorBehavior.defaultMode` **shall exist** if the value of the attribute `ModeErrorBehavior.errorReactionPolicy` is set to `defaultMode`.] ()

[TPS_SWCT_01533] `ModeDeclarationGroup.initialMode` shall be assumed in the absence of `ModeDeclarationGroup.modeManagerErrorBehavior` [If the attribute `ModeDeclarationGroup.modeManagerErrorBehavior` is not defined it shall be assumed that the `ModeDeclarationGroup.initialMode` becomes applicable in case of the mode manager getting out of sync with a mode user (because the partition of the mode user has been terminated).] (*RS_SWCT_03110*)

[TPS_SWCT_01534] `ModeDeclarationGroup.initialMode` shall be assumed in the absence of `ModeDeclarationGroup.modeUserErrorBehavior` [If the attribute `ModeDeclarationGroup.modeUserErrorBehavior` is not defined it shall

be assumed that the `ModeDeclarationGroup.initialMode` becomes applicable in case of the mode user getting out of sync with a mode manager (because the partition of the mode manager has been terminated).] ([RS_SWCT_03110](#))

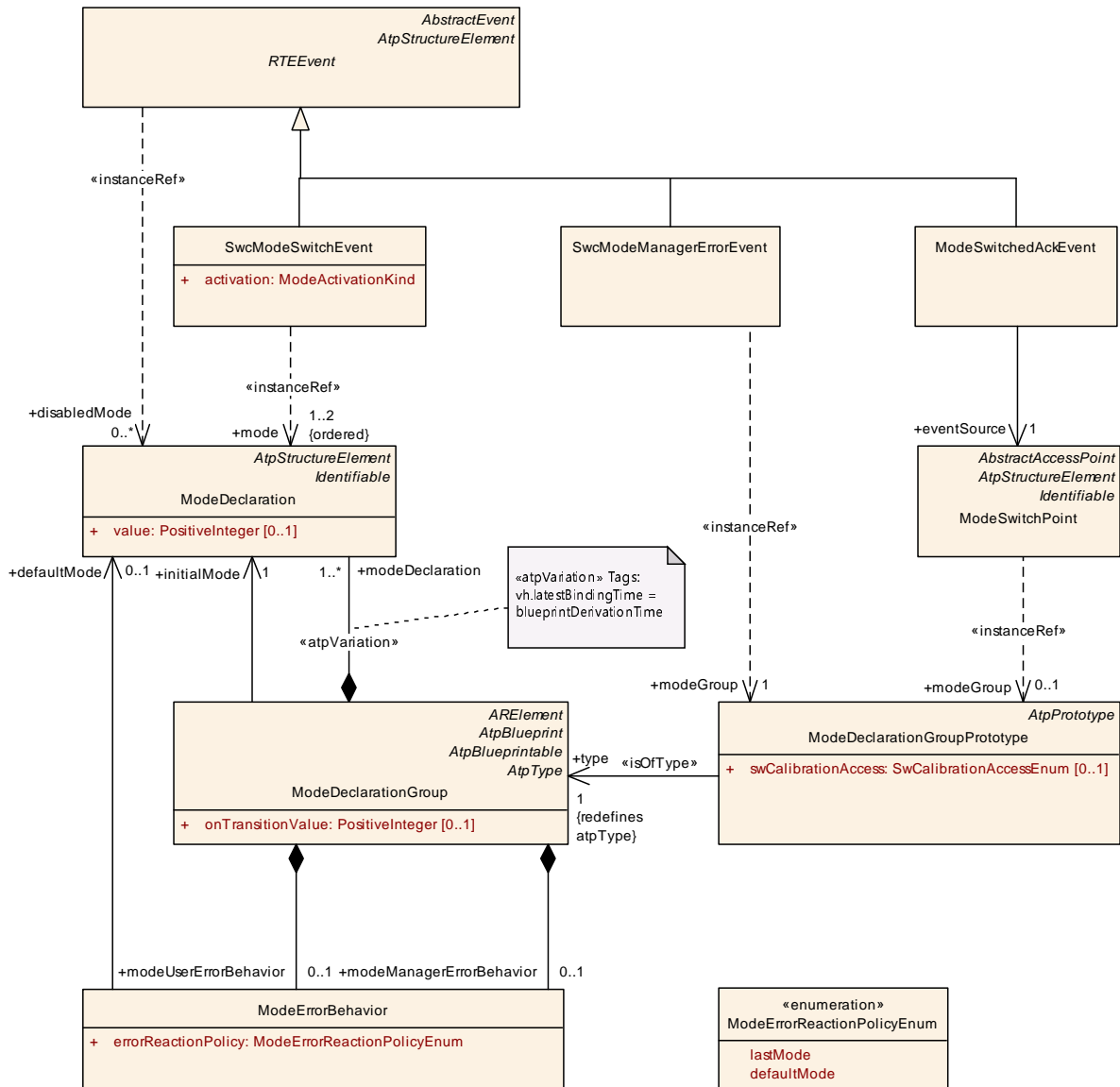

Figure 9.7: Mode Error Behavior

Class	ModeErrorBehavior			
Package	M2::AUTOSARTemplates::CommonStructure::ModeDeclaration			
Note	This represents the ability to define the error behavior in the context of mode handling.			
Base	ARObject			
Attribute	Type	Mult.	Kind	Note





Class	ModeErrorBehavior			
defaultMode	ModeDeclaration	0..1	ref	This represents the ModeDeclaration that is considered the error mode in the context of the enclosing Mode DeclarationGroup.
errorReaction Policy	ModeErrorReaction PolicyEnum	1	attr	This represents the ability to define the policy in terms of which default model shall apply in case an error occurs.

Table 9.6: ModeErrorBehavior

Enumeration	ModeErrorReactionPolicyEnum
Package	M2::AUTOSARTemplates::CommonStructure::ModeDeclaration
Note	This represents the ability to specify the reaction on a mode error.
Literal	Description
defaultMode	This represents the ability to switch to the defaultMode in case of a mode error. Tags: atp.EnumerationLiteralIndex=0
lastMode	This represents the ability to keep the last mode in case of a mode error. Tags: atp.EnumerationLiteralIndex=1

Table 9.7: ModeErrorReactionPolicyEnum

[TPS_SWCT_01535] Mode manager reacts on mode error [If the mode manager is getting out of sync with a mode user (because the partition of the mode user has been terminated) or vice versa (because the partition of the mode manager has been terminated) it shall be possible for the mode manager to react on such an event.

For this purpose the formal [SwcModeManagerErrorEvent](#) is defined that can be taken to e.g. trigger the execution of a [RunnableEntity](#) in response to an error with respect to mode switch communication.] ([RS_SWCT_03110](#))

Class	SwcModeManagerErrorEvent			
Package	M2::AUTOSARTemplates::SWComponentTemplate::SwcInternalBehavior::RTEEvents			
Note	This represents the ability to react on errors occurring during mode handling.			
Base	ARObject , AbstractEvent , AtpClassifier , AtpFeature , AtpStructureElement , Identifiable , Multilanguage Referrable , RTEEvent , Referrable			
Attribute	Type	Mult.	Kind	Note
modeGroup	ModeDeclarationGroup Prototype	1	iref	This represents the ModeDeclarationGroupPrototype for which the error behavior of the mode manager applies.

Table 9.8: SwcModeManagerErrorEvent

As mentioned in [\[constr_1075\]](#), it is possible to overrule the default compatibility rules by the definition of a [PortInterfaceMapping](#).

In this case the demand for having identical definitions of [ModeDeclarationGroup](#), [modeUserErrorBehavior](#) and [ModeDeclarationGroup.modeManagerError-Behavior](#) is no longer valid.

However, there is one additional caveat to observe in this case. This affects the implementation of error behavior in case that several mode users are connected to a mode manager.

[TPS_SWCT_01536] Coherent behavior of all mode users in case of errors in the mode switch communication [The behavior in case of errors with the communication of mode switches needs to be **coherent for all** connected mode users **especially** if the individual `SwConnectors` are legitimized by the existence of a `PortInterfaceMapping`.] ([RS_SWCT_03110](#))

[TPS_SWCT_01541] Preferential selection of `modeUserErrorBehavior` [The definition of mode error behavior on the provided side of shall be considered **dominant** over the definition of mode error behavior on the required side.

This means that a `ModeSwitchInterface.modeGroup.type.modeUserErrorBehavior` used to type an `AbstractProvidedPortPrototype` shall be considered **dominant** over the definition of a corresponding `modeUserErrorBehavior` and defined in the context of an `AbstractRequiredPortPrototype`.] ([RS_SWCT_03110](#))

[TPS_SWCT_01542] Preferential selection of `modeManagerErrorBehavior` [The definition of mode error behavior on the provided side of shall be considered **dominant** over the definition of mode error behavior on the required side.

This means that a `ModeSwitchInterface.modeGroup.type.modeManagerErrorBehavior` used to type an `AbstractProvidedPortPrototype` shall be considered **dominant** over the definition of a corresponding `modeManagerErrorBehavior` defined in the context of an `AbstractRequiredPortPrototype`.] ([RS_SWCT_03110](#))

The consequence of [\[TPS_SWCT_01541\]](#) and [\[TPS_SWCT_01542\]](#) is that the **mode manager shall be considered the master of the definition of mode error behavior**.

Please note that the statements made in [\[TPS_SWCT_01541\]](#) is further underlined by [\[SWS_Rte_06795\]](#) and the statement made by [\[TPS_SWCT_01542\]](#) is further underlined by [\[SWS_Rte_06795\]](#).

The details of how the run-time behavior of mode manager and mode user shall look like in the event of the mode manager getting out of sync with a mode user (because the partition of the mode user has been terminated) or vice versa (because the partition of the mode manager has been terminated) as well as the applicable RTE APIs are explained in [\[2\]](#).

9.5 Summary Meta-Model Excerpt Related to Modes

Figure [9.8](#) provides an overview of all meta-model elements that have a direct relationship to the meta-classes involved in the modeling of mode switches.

To get the complete picture, it should be noted that also the concepts of [PortGroups](#) (see [4.6](#)) and [ServiceProxySwComponentType](#) (see [11.4](#)) have a semantical relationship to mode management, though this is not expressed via relations in the meta-model.

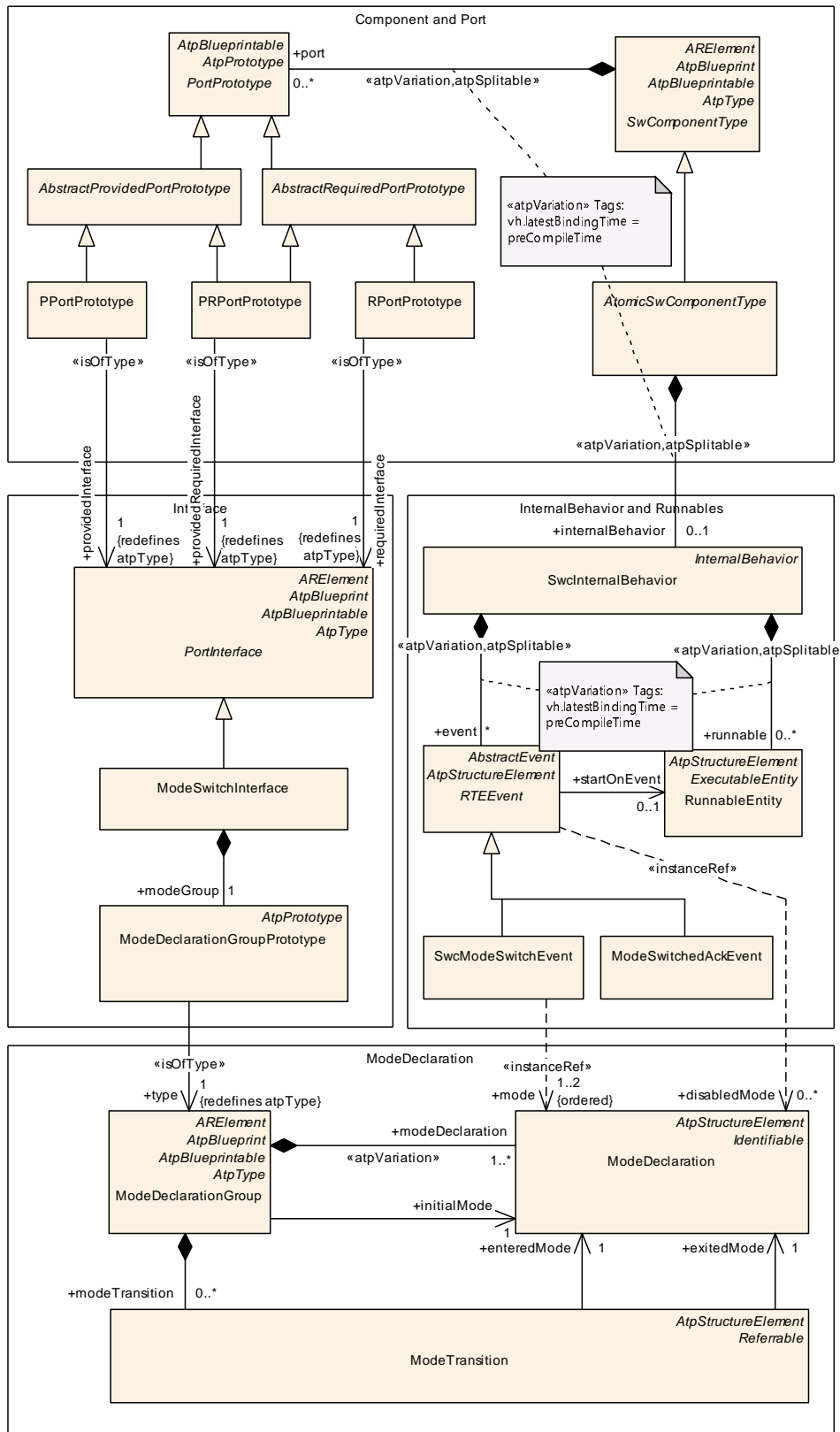

Figure 9.8: Summary meta-model excerpt related to modes

10 ECU Abstraction and Complex Drivers

10.1 Introduction

During the design of embedded systems there is one crucial point where the hardware and software have to be related. In AUTOSAR the `ECU Resource Template` describes the provided hardware resources.

On the other hand, the `Software Component Template` describes software generally without specific hardware in mind. But there are some places where both have to meet and fit.

One interface between hardware and software is discussed in the memory and execution time section of [6]. In this chapter the overall system view of the interface between sensors/actuators and software is described and the consequences for the `Software Component Template` are derived.

10.2 High Level Hardware and Software Architecture

The AUTOSAR concept defines a software architecture (see Figure 10.1) and within this layered architecture the interfaces between the hardware and the software are explicitly modeled.

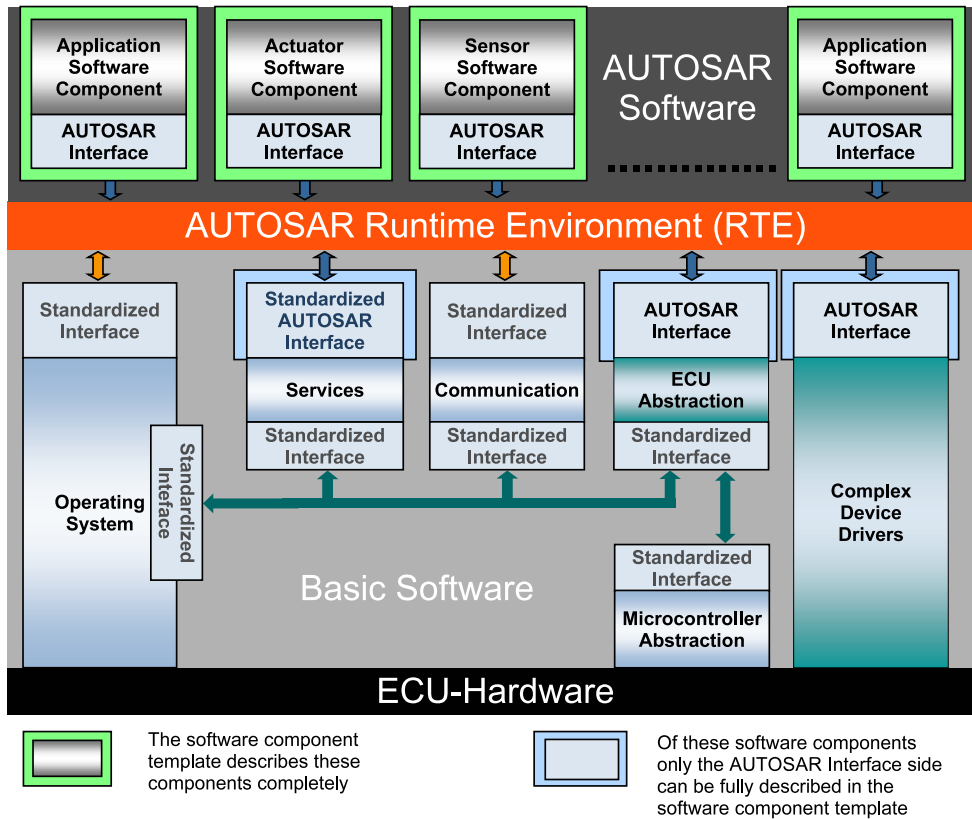

Figure 10.1: AUTOSAR ECU Software Architecture

The signal¹ flow from a hardware to software and vice versa will be described in the following sections.

A sensor² is converting a physical value (1) in Figure 10.2 (e.g. temperature, force, light intensity) into an electrical signal (2) which can be either a current or a voltage.

Inside the ECU generally there will be some electronics to enhance the electrical signal provided by the sensor. In AUTOSAR this is called ECU Electronics. This electronics device is also responsible for the conversion of the electrical signal into a microcontroller compatible form (3), usually a voltage.

After the electrical signal has been enhanced and converted it will be captured by the microcontroller. This can either be done by a simple digital input, an analogue to digital converter or maybe a pulse-width demodulation module. Now the electrical signal is available as a software data value (4).

This signal flow is sketched in the top part of Figure 10.2.

¹The term “signal” is not going to be used here at its own but more specific terms will be used for the different abstractions of signals at the different stages of the signal flow.

²For the sake of simplicity this discussion is limited to the sensor aspects. Nevertheless, the same applies also for actuators.

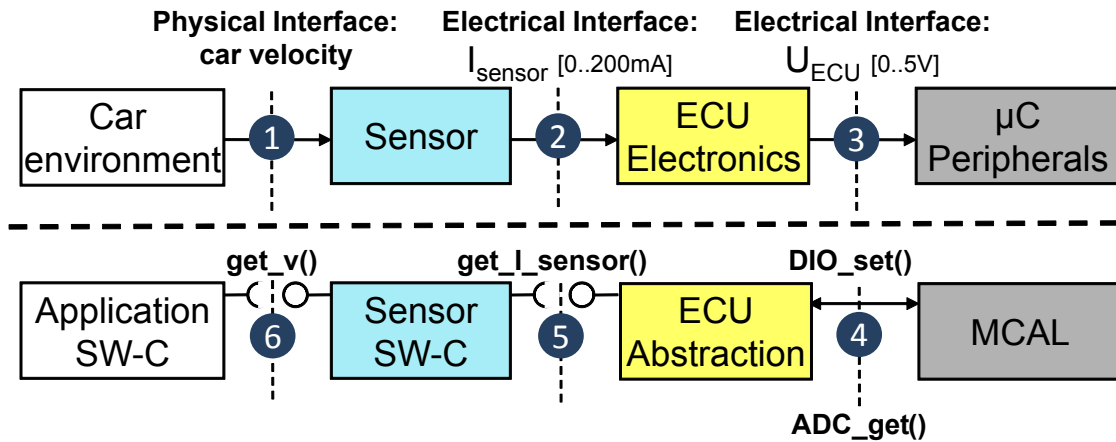

Figure 10.2: Interfaces between hardware and software

The interaction shown in Figure 10.2 shows an exemplary scenario. The usage of `ClientServerInterface` is just an example for the interaction pattern.

This signal chain is represented one-to-one in the AUTOSAR software architecture and depicted in the lower part of Figure 10.2.

In an implementation of AUTOSAR, only the Microcontroller Abstraction (MCAL) has direct access to the peripheral hardware. This layer is going to be standardized and all hardware access should go through this layer. The idea of the AUTOSAR signal flow is to map the hardware to the corresponding software modules.

So if an electrical current is the input to the microcontroller peripheral, the MCAL will deliver a data value that represents this current. As the ECU Electronics has enhanced and converted the electrical signal prior to the microcontroller, the corresponding software entity is reversing this conversion. This is performed in the ECU Abstraction layer.

So if the input to the ECU is an electrical current and the ECU Electronics has converted this current into a voltage (from 2 to 3), the ECU Abstraction will convert the data value voltage into an AUTOSAR signal representing a current (from 4 to 5). This AUTOSAR signal represents the actual current that was provided by the sensor (2).

Now the first step in the conversion has to be reversed: the sensor has converted a physical value into an electrical signal. And so the Sensor Software Component has to reverse this again. The Sensor Software Component will read the AUTOSAR signal representing the electrical value and transform it into an AUTOSAR signal representation of the physical value (from 5 to 6).

Now this physical value is available on the RTE and can be consumed or read by other SW-Components. Although the interface between the ECU Abstraction and the Sensor Software Component is also an AUTOSAR interface and could be routed through some communication-bus, it will not be practical to separate the ECU Abstraction and

the corresponding `SensorActuatorSwComponentType` due to potentially high communication effort.

In Figure 10.3 a complete signal flow from a sensor input to an actuator output is shown.

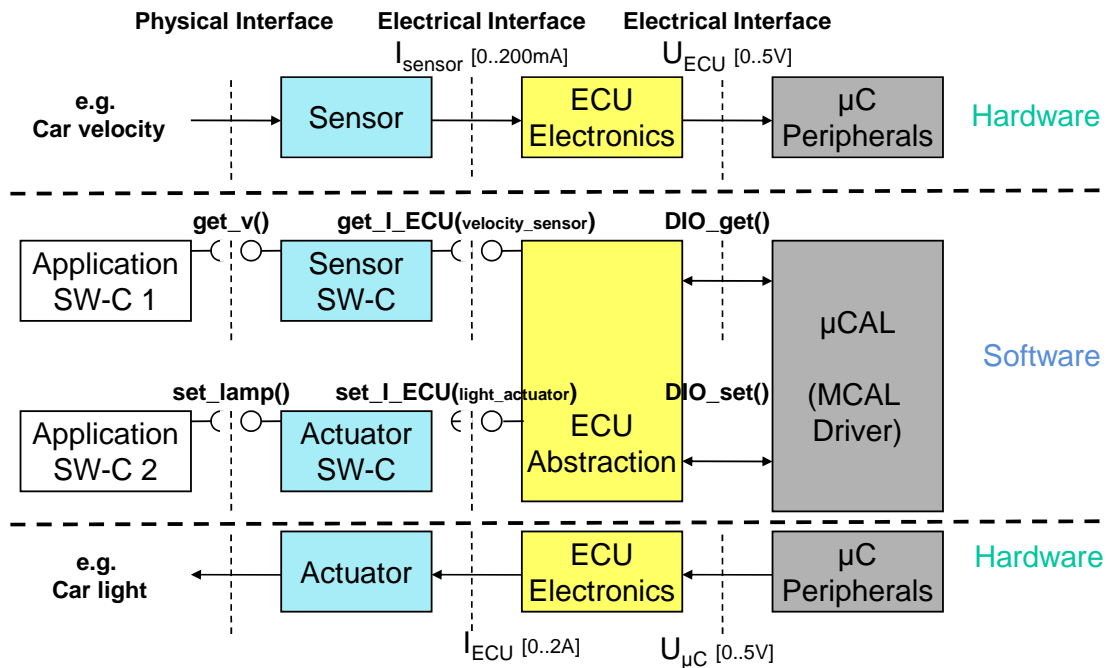

Figure 10.3: Sensor and Actuator Signal Flow

The interaction shown in Figure 10.3 shows an exemplary scenario. The usage of `ClientServerInterface` is just an example for the interaction pattern.

In the next section the interfaces between the involved software modules are discussed.

10.3 Interfaces and APIs

Two fundamentally different interfaces are involved when converting from sensors/actuators to software components, see markers “4” and “5” in Figure 10.2.

The interface between the Microcontroller Abstraction and the ECU Abstraction is a Standardized Interface (see AUTOSAR Glossary [32]). This interface is not visible on the Virtual Function Bus and therefore the MCAL and ECU Abstraction have to be present on the same ECU.

For further description of this interface please refer to the `ECU Resource Template` documentation.

The interface to the `SensorActuatorSwComponentTypes` is visible on the `VirtualFunction Bus`. In general the `SensorActuatorSwComponentType` should be on the same ECU as the ECU hardware abstraction.

Also, the interface between the `SensorActuatorSwComponentTypes` and the actual `AtomicSwComponentTypes` representing the application is visible on the VFB. To describe the data that is going to be exchanged via this interface the standard AUTOSAR Interface description mechanisms are used (see chapter 3.4).

10.3.1 ECU Abstraction and its AUTOSAR Interfaces

Since the AUTOSAR standard is designed with the focus on the integration of software-components coming from different contractors, the interfaces between the different software-components obviously have to be compatible.

In the case of the sensors and actuators the interface is gathered in the ECU Abstraction. For each sensor and actuator there is one AUTOSAR `PortPrototype` that represents the AUTOSAR Signal that is delivered by the sensor or the AUTOSAR Signal that is consumed by the actuator. This relationship is depicted in Figure 10.4

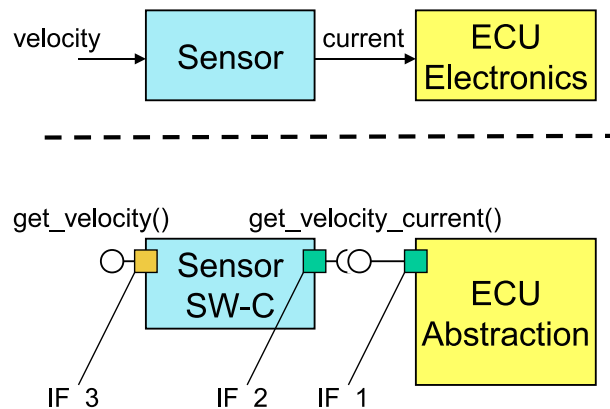

Figure 10.4: Interfaces of signals in software

The interaction shown in Figure 10.4 shows an exemplary scenario. The usage of `ClientServerInterface` is just an example for the interaction pattern.

Each sensor and actuator has an AUTOSAR `PortPrototype` at the ECU Abstraction. Connected to this port is the `SensorActuatorSwComponentType`. The `SensorActuatorSwComponentType` has one `PortPrototype` (i.e. `IF_2`) to the ECU Abstraction (which provides the values via `IF_1`) where it gets the AUTOSAR signals from the hardware, and one `PortPrototype` (i.e. `IF_3`) to `AtomicSwComponentTypes` where it provides the actual physical value to the rest of AUTOSAR on the RTE.

In addition, the Interfaces between the ECU Abstraction and the `SensorActuatorSwComponentType` have to be compatible like defined in chapter 6.

10.4 Sensors/Actuators

In the layered software architecture described in [5] each hardware sensor/actuator is coupled to a *SensorActuatorSwComponentType* (see Figure 10.5).

[TPS_SWCT_01047] Reference from the software representation of a sensor/actuator to the actual hardware element [Since the Software Component Template is going to be used to describe the *SensorActuatorSwComponentType* as well, there is also a reference needed from the software representation of a sensor/actuator to the actual hardware element described in the ECU Resource description.] (*RS_SWCT_02080, RS_SWCT_03090*)

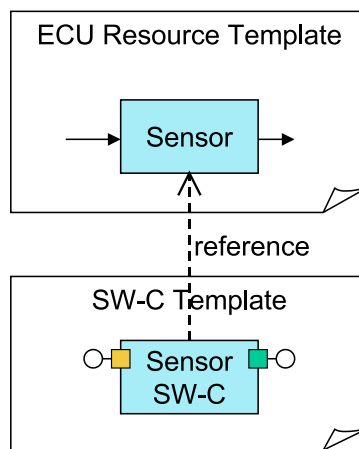

Figure 10.5: Shipment of a sensor

So each time a sensor/actuator is selected to be connected to an ECU also the corresponding *SensorActuatorSwComponentType* is available.

[constr_1144] *SensorActuatorSwComponentType*, *EcuAbstractionSwComponentType*, and *ComplexDeviceDriverSwComponentType* may only reference a *HwType* [The attribute *sensorActuator* of *SensorActuatorSwComponentType*, the attribute *hardwareElement* of *EcuAbstractionSwComponentType*, and the attribute *hardwareElement* of *ComplexDeviceDriverSwComponentType* may **only** reference a *HwType*. References to other subclasses of *HwDescriptionEntity* are not allowed.] ()

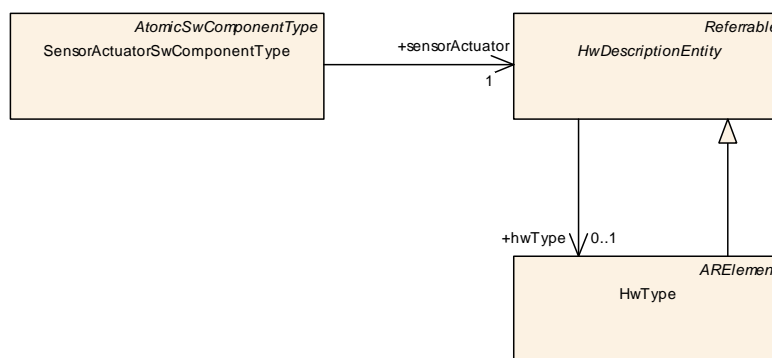

Figure 10.6: Sensor/actuator to Hardware Relationship

Figure 10.6 depicts the reference of `SensorActuatorSwComponentType` designed as a specialization of an `AtomicSwComponentType` with an additional reference to a `HwType`.

[constr_1109] Mapping of `SwComponentPrototypes` typed by a `SensorActuatorSwComponentType` [A `SwComponentPrototype` typed by a `SensorActuatorSwComponentType` needs to be mapped and run on exactly that ECU that contains the `HwElement` corresponding to the `HwType` that its `SensorActuatorSwComponentType` refers to in case it accesses the hardware via the I/O hardware abstraction layer.]()

[TPS_SWCT_01048] `SensorActuatorSwComponentType` may use the I/O hardware abstraction directly [In contrast to an `ApplicationSwComponentType`, a `SensorActuatorSwComponentType` may use the I/O hardware abstraction directly (via ports/connectors).] (*RS_SWCT_02080*, *RS_SWCT_03090*)

In case the sensor/actuator hardware is accessed via bus communication, e.g. is located on a LIN slave, no such mapping constraints apply (note that this is not handled via the IO hardware abstraction layer).

Class	<code>SensorActuatorSwComponentType</code>			
Package	M2::AUTOSARTemplates::SWComponentTemplate::Components			
Note	The <code>SensorActuatorSwComponentType</code> introduces the possibility to link from the software representation of a sensor/actuator to its hardware description provided by the ECU Resource Template. Tags: atp.recommendedPackage=SwComponentTypes			
Base	ARElement , ARObject , AtomicSwComponentType , AtpBlueprint , AtpBlueprintable , AtpClassifier , AtpType , CollectableElement , Identifiable , MultilanguageReferrable , PackageableElement , Referrable , SwComponentType			
Attribute	Type	Mult.	Kind	Note
sensorActuator	HwDescriptionEntity	1	ref	Reference from the Sensor Actuator Software Component Type to the description of the actual hardware.

Table 10.1: SensorActuatorSwComponentType

10.5 I/O Hardware Abstraction

[TPS_SWCT_01389] I/O Hardware Abstraction interfaces MCAL drivers [The I/O Hardware Abstraction interfaces on one side the MCAL drivers via `StandardizedInterfaces` and on the other side the Sensor Actuator Software Component via `AUTOSARInterfaces`. On the VFB[3] the I/O Hardware Abstraction is represented by the `EcuAbstractionSwComponentType`.]()

[TPS_SWCT_01390] I/O Hardware Abstraction might have sub-structures [Depending on the complexity of an ECU, the I/O Hardware Abstraction might have sub-structures. In this case the I/O Hardware Abstraction Layer is described by several `EcuAbstractionSwComponentTypes` on M1.]()

Class	EcuAbstractionSwComponentType			
Package	M2::AUTOSARTemplates::SWComponentTemplate::Components			
Note	The ECUAbstraction is a special AtomicSwComponentType that resides between a software-component that wants to access ECU periphery and the Microcontroller Abstraction. The EcuAbstractionSwComponentType introduces the possibility to link from the software representation to its hardware description provided by the ECU Resource Template. Tags: atp.recommendedPackage=SwComponentTypes			
Base	ARElement , ARObject , AtomicSwComponentType , AtpBlueprint , AtpBlueprintable , AtpClassifier , AtpType , CollectableElement , Identifiable , MultilanguageReferrable , PackageableElement , Referrable , SwComponentType			
Attribute	Type	Mult.	Kind	Note
hardware Element	HwDescriptionEntity	*	ref	Reference from the EcuAbstractionComponentType to the description of the used HwElements.

Table 10.2: EcuAbstractionSwComponentType

[TPS_SWCT_01391] I/O Hardware Abstraction abstracts from the location of peripheral I/O devices [The I/O Hardware Abstraction abstracts from the location of peripheral I/O devices (on-chip or on-board) and the ECU hardware layout and has therefore dependencies to ECU Hardware described by [HwElements](#). In addition, the [EcuAbstractionSwComponentType](#) is a hybrid concept sharing features of both software-components and basic software modules.]()

[TPS_SWCT_01392] Mapping between the EcuAbstractionSwComponentType and the corresponding BswModuleDescription [The BSW part is described by the means of the Basic Software Module Template. The mapping between the [EcuAbstractionSwComponentType](#) and the corresponding [BswModuleDescription](#) is provided by the class [SwcBswMapping](#) which in addition also maps the two corresponding [InternalBehaviors](#). This mechanism is further explained in [6].]()

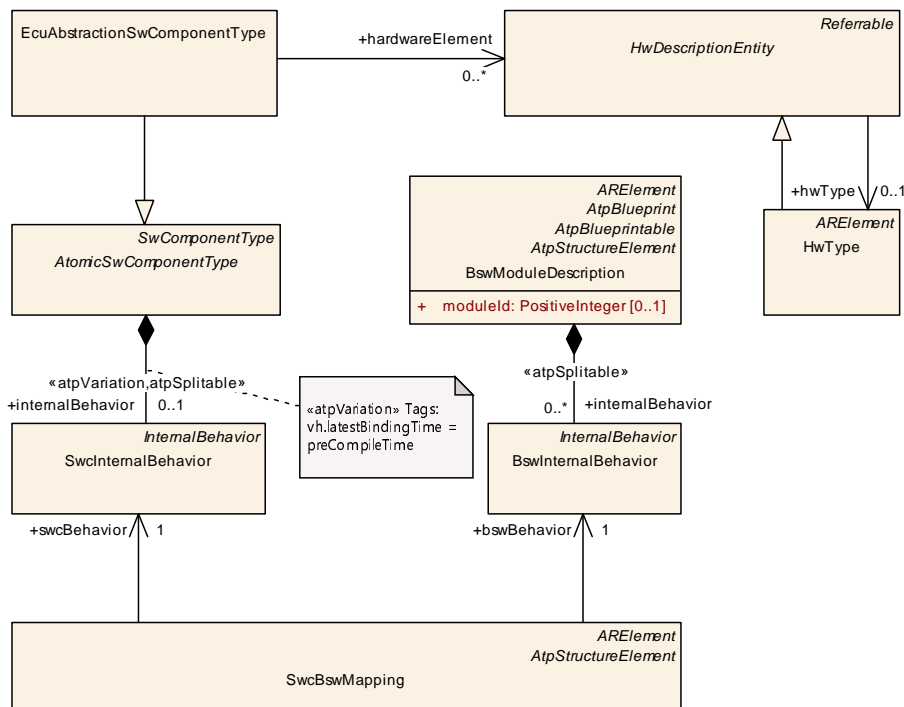

Figure 10.7: EcuAbstractionSwComponentType

10.6 Complex Driver

[TPS_SWCT_01393] Complex Driver [A Complex Driver implements complex sensor evaluation and actuator control with direct access to the Microcontroller using specific interrupts and/or complex Microcontroller peripherals to fulfill the special functional and timing requirements.]()

In addition, it might be used to implement enhanced services / protocols or encapsulates legacy functionality of a non-AUTOSAR system.]()

See also document [3].

[TPS_SWCT_01394] Complex Driver is represented by the ComplexDeviceDriverSwComponentType [On the VFB the Complex Driver is represented by the ComplexDeviceDriverSwComponentType. An ECU might have zero to many ComplexDeviceDriverSwComponentTypes.]()

Class	ComplexDeviceDriverSwComponentType			
Package	M2::AUTOSARTemplates::SWComponentTemplate::Components			
Note	The ComplexDeviceDriverSwComponentType is a special AtomicSwComponentType that has direct access to hardware on an ECU and which is therefore linked to a specific ECU or specific hardware. The ComplexDeviceDriverSwComponentType introduces the possibility to link from the software representation to its hardware description provided by the ECU Resource Template. Tags: atp.recommendedPackage=SwComponentTypes			
Base	ARElement , ARObject , AtomicSwComponentType , AtpBlueprint , AtpBlueprintable , AtpClassifier , AtpType , CollectableElement , Identifiable , MultilanguageReferrable , PackageableElement , Referrable , SwComponentType			
Attribute	Type	Mult.	Kind	Note
hardware Element	HwDescriptionEntity	*	ref	Reference from the ComplexDeviceDriverSwComponentType to the description of the used HwElements.

Table 10.3: ComplexDeviceDriverSwComponentType

[TPS_SWCT_01395] ComplexDeviceDriverSwComponentType has dependencies to ECU Hardware [Similar to [EcuAbstractionSwComponentType](#) the [ComplexDeviceDriverSwComponentType](#) has dependencies to ECU Hardware described by [HwElements](#) and is a hybrid between Software Component and Basic Software Module.]()

[TPS_SWCT_01396] Mapping between the ComplexDeviceDriverSwComponentType and the corresponding BswModuleDescription [The BSW part is described by the means of the Basic Software Module Template. The mapping between the [ComplexDeviceDriverSwComponentType](#) and the corresponding [BswModuleDescription](#) is provided by the class [SwcBswMapping](#) which in addition also maps the two corresponding [InternalBehaviors](#). This mechanism is further explained in [6].]()

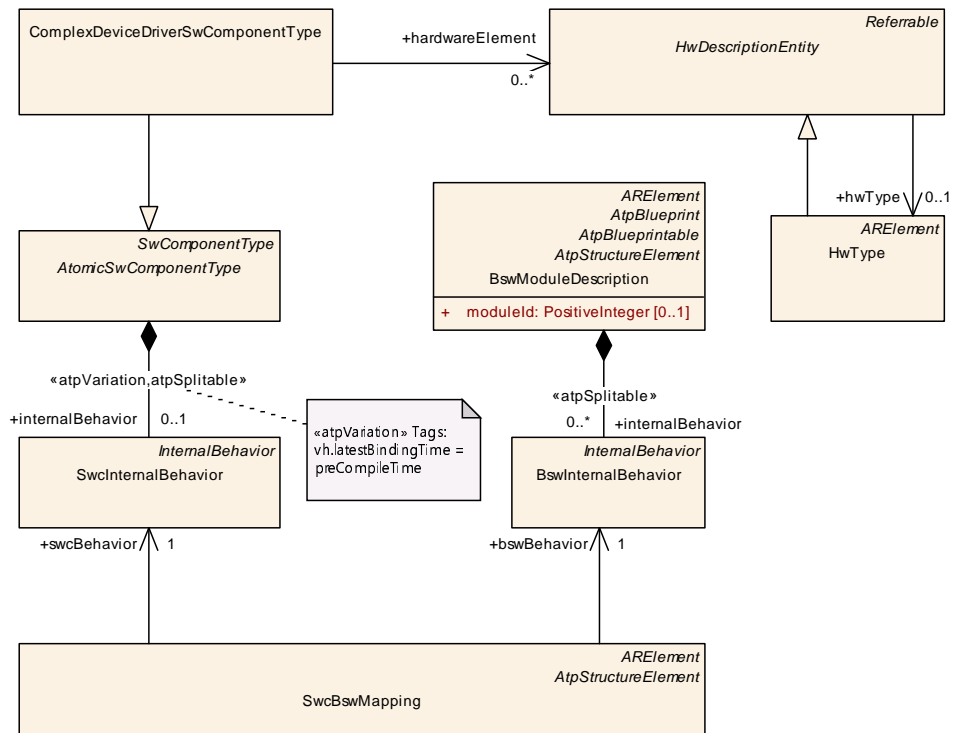

Figure 10.8: `ComplexDeviceDriverSwComponentType`

11 Services

11.1 Overview: Generation of Service-related Model Elements

This chapter covers the description and handling of AUTOSAR Service configuration.

[TPS_SWCT_01397] Hybrid concept between Basic Software Modules and a SwComponentType [AUTOSAR Services can be seen as a hybrid concept between Basic Software Modules and a SwComponentType. AUTOSAR Services actually provide access to low-level and ECU-wide “standard functionalities” commonly referred to as “service”.

AtomicSwComponentTypes that require AUTOSAR Services use Standardized AUTOSAR Interfaces to communicate with these. The connection of PortPrototypes of the ServiceSwComponentTypes and PortPrototypes of the AtomicSwComponentTypes implement several communication patterns.]()

I	II	III	IV
A	1..n	PPort:RPort	Distribution of data or modes to n software-components, e.g. used for ECU mode.
A*	1..n	RPort:PPort	Currently not used, not supported for client-server communication.
A**	1..n	PRPort:RPort	Distribution of data or modes to n software-components, e.g. used for ECU mode.
B	1..1	PPort:RPort	Software-component acts as Server, used for so called “call-backs”.
B	1..1	RPort:PPort	Service acts as Server, typical Service usage.
C*	n..1	PPort:RPort	Conceptually not used to support index abstraction via PortDefinedArgumentValues.
C	n..1	RPort:PPort	Software-component acts as Server, used for so called “call-backs” invoked by more than one Service.
D	1..1	PR-Port:PRPort	I/O control data.

Table 11.1: ServiceConnectorPattern

Legend for Table 11.1:

I Pattern name

II Communication pattern (client/server, sender/receiver)

III Kind of PortPrototype at service : software-component

IV Description, use case

[TPS_SWCT_01398] Communication patterns for AUTOSAR services [The communication patterns for AUTOSAR services are summarized in Table 11.1.]()

[TPS_SWCT_01403] Impact of AUTOSAR services on the methodology [Due to this special nature, such AUTOSAR Services need to be handled with particular attention in the methodology [4]. That is, a number of elements need to be generated during ECU integration.]()

The following list of paragraphs presents a short overview over the steps required for the configuration of AUTOSAR Services.

Note that most of these steps are performed by tools and the model elements being created in these steps are rather specific to `Service` configuration and are not to be modeled manually within AUTOSAR authoring tools.

In particular, the following requirements apply:

- **[TPS_SWCT_01399] Dependency is modeled by aggregating required and provided `PortPrototypes`** [The dependency of an `AtomicSwComponentType` (or more precisely, one of its non-abstract derived meta-classes) from an AUTOSAR `Service` is modeled by aggregating required and provided `PortPrototypes`.]()

[TPS_SWCT_01400] `PortInterface` selected from the set of standardized `Service Interfaces` [The `PortInterface` being implemented by the `PortPrototypes` needs to be one of a number of standardized `Service Interfaces` which is indicated by having its `isService` attribute set to `true` and is (via several levels of indirection) finally referenced by `ServiceNeeds`.]()

Additionally, the software components and `Basic Software Modules` shall specify `ServiceNeeds` containing further input information for the later `Service` configuration step.

- **[TPS_SWCT_01401] Form a top-level `RootSwCompositionPrototype`** [When defining a software system, the `AtomicSwComponentType` is used in the form of `SwComponentPrototypes` within a `CompositionSwComponentType`. In this step, the non-service ports of all required interfaces are being connected using `AssemblySwConnectors` and `DelegationSwConnectors` in order to eventually form a top-level `RootSwCompositionPrototype` which can be referenced in an AUTOSAR `System`.]()
- **[TPS_SWCT_01402] Mapping of all `AtomicSwComponentType` instances to `EcuInstances`** [In `System Configuration Phase`, the mapping of all `AtomicSwComponentType` instances to `EcuInstances` is done (for the specification of `EcuInstance` see [10]). The `ServiceNeeds` may be used by tools to check for available resources on the targeted ECUs.]()
- **[TPS_SWCT_01404] Creation of the `Ecu Extract`** [The `ECU Extract` is extracted from the `System Configuration` for each ECU. As explained in the AUTOSAR `System Template` [10], this contains an ECU-centric view onto the system description.

This includes a reduced version of the system's `RootSwCompositionPrototype` where `SwComponentPrototypes` not being mapped to the ECU are being left out and all `Compositions` are stripped off, so that in the `ECU Extract` only one instance of `CompositionSwComponentType` remains which aggregates all `SwComponentPrototypes` on the ECU in a flat manner.]()

- **[TPS_SWCT_01405] Creation of the `ServiceSwComponentTypes`** [In ECU Configuration, for each `Service` required on the ECU exactly one `ServiceSwComponentType` is created based on the needs from the `AtomicSwComponentTypes`: An adequate number of `PortPrototypes` are created on this `ServiceSwComponentType` for each needed port at the `AtomicSwComponentType`.

Thereby the specified communication pattern A, B, C or D for a specific kind of `ServicePort` has to be considered.]()

See also chapter 11.3 and table 11.1.

- **[TPS_SWCT_01406] Creation of `SwComponentPrototype` typed by a `ServiceSwComponentType`** [Per `Service` exactly one `SwComponentPrototype` typed by a `ServiceSwComponentType` is created based on the `ServiceSwComponentType`. Additionally, the connectors are constructed that connect the pairs of `PortPrototypes` belonging to the `SwComponentPrototypes` requiring services and those belonging to the actual services.]()
- **[TPS_SWCT_01407] Creation of `InternalBehavior` typed by a `ServiceSwComponentType`** [For each `ServiceSwComponentType` an `SwcInternalBehavior` is created or extended providing the information about `PortDefinedArgumentValues`, `RunnableEntitys` and `RTEEvents` necessary for RTE generation.]()

Further, detailing of the service ports by filling in these `PortDefinedArgumentValues` is also done in ECU Configuration phase. See also chapter 7.6.3.

- **[TPS_SWCT_01408] Creation of `SwcBswMapping`** [For the RTE module configuration an implementation of the AUTOSAR `Service` described by a `Basic Software Module Description` needs to be selected. The `SwcBswMapping` to the corresponding `SwComponentPrototype` needs to be created accordingly.

For each `SwcInternalBehavior` one `SwcImplementation` is being created. The information for `SwcImplementation` should be generated based on the available information of `BswImplementation`¹.]()

- **[TPS_SWCT_01409] Update of `PortDefinedArgumentValues`** [Depending on the configuration of the `Service` BSW it might be necessary to update the `ValueSpecifications` belonging to the `PortDefinedArgumentValues` generated in a previous step.]()

¹This step does in general not require copying any attributes or elements aggregated in `BswImplementation` into the generated instance of `SwcImplementation` since the only mandatory information for the RTE configuration is the reference from `SwcImplementation` to the selected `SwcInternalBehavior`.

11.2 Extending the ECU Software Composition

As explained in chapter 11.1, `Service Configuration` takes place in ECU Configuration phase. In the ECU extract of the `System`, the Software Components and their ECU-internal connectors are represented as a flat set aggregated by `RootSwCompositionPrototype` as indicated in Figure 11.1.

ECU Configuration extends this aggregation by adding `SwComponentPrototypes` (each typed by a specific `ServiceSwComponentType`) and the required `AssemblySwConnectors` to the `RootSwCompositionPrototype`. This is possible without changing the initial artifacts of the ECU extract, because these aggregations are stereotyped as `<<atpSplitable>>` in the meta-model.

After this step, the `RootSwCompositionPrototype` (denoted by `EcucValueCollection.ecuExtract.rootSoftwareComposition`) represents the whole Software Composition on the given ECU. This collection includes both the software components mapped to the ECU **and** the necessary service components represented as one `SwComponentPrototype` for each AUTOSAR `Service` utilized on the given ECU.

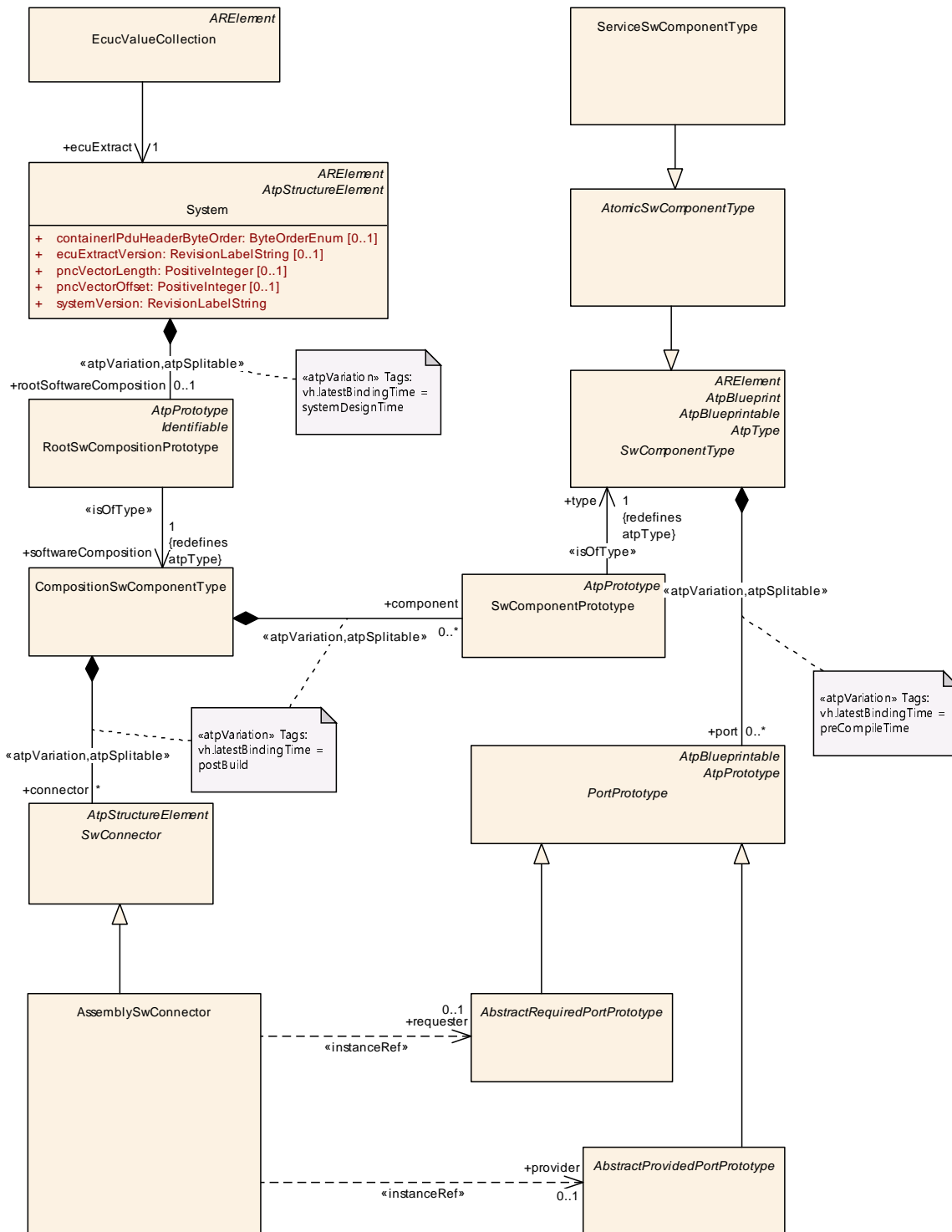

Figure 11.1: Usage of **RootSwCompositionPrototype** on an ECU

11.3 Service Software Component Type

As mentioned in [TPS_SWCT_01405], AUTOSAR Services are represented by a meta model class of their own, the **ServiceSwComponentType**. As can be seen

in Figure 11.2, `ServiceSwComponentType` is a specialization of `AtomicSwComponentType`.

Like any other `SwComponentType` they can aggregate `PortPrototypes`.

[constr_2019] `ServiceSwComponentType` shall have service ports only [In the case of `ServiceSwComponentType`, all aggregated `PortPrototypes` need to have an `<<isOfType>>` relationship to a `PortInterface` which has its `isService` attribute set to `true`. The exceptions described in [TPS_SWCT_01572], [TPS_SWCT_01579] and [TPS_SWCT_01580] apply.]()

[TPS_SWCT_01579] `Dcm` can directly access `dataElements` in `PPortPrototypes` typed by a `SenderReceiverInterface` [An exception to the rule described in [constr_2019] applies: the `Dcm` can directly access `dataElements` in `PortPrototypes` (that is both `AbstractProvidedPortPrototype` and `AbstractRequiredPortPrototype`) typed by a `SenderReceiverInterface`.

For this purpose, the `ServiceSwComponentType` that represents the `Dcm` functionality can have `AbstractProvidedPortPrototypes` and `AbstractRequiredPortPrototypes` typed by a compatible `SenderReceiverInterface` that may set `isService` to `FALSE`.]()

[TPS_SWCT_01580] `Dem` can directly access `dataElements` in `PPortPrototypes` typed by a `SenderReceiverInterface` [An exception to the rule described in [constr_2019] applies: the `Dem` can directly access `dataElements` in `AbstractProvidedPortPrototypes` typed by a `SenderReceiverInterface`.

For this purpose, the `ServiceSwComponentType` that represents the `Dem` functionality can have `RPortPrototypes` typed by a compatible `SenderReceiverInterface` that may set `isService` to `FALSE`.]()

[TPS_SWCT_01411] Use cases for a `ServiceSwComponentType` to express `ServiceNeeds` [There are valid use cases for a `ServiceSwComponentType` to express `ServiceNeeds`². This leads to a situation where `ServiceSwComponentTypes` are iteratively created in response to `ServiceNeeds` expressed by other `ServiceSwComponentTypes`. Please refer to the AUTOSAR methodology [4] for more details about how this shall be implemented into the workflow.]()

Similar to an `EcuAbstractionSwComponentType` and a `ComplexDeviceDriverSwComponentType`, the `ServiceSwComponentType` represents a hybrid concept between Software Component and Basic Software Module. The BSW part is described by the means of the BSW Module Description Template [6].

The mapping between the `ServiceSwComponentType` and the corresponding `BswModuleDescription` is provided by the class `SwcBswMapping` which in addition also maps the two corresponding `InternalBehaviors` (see [TPS_SWCT_01408]). This mechanism is further explained in [6].

²Thereby the previously existing constraint 1127 becomes invalid.

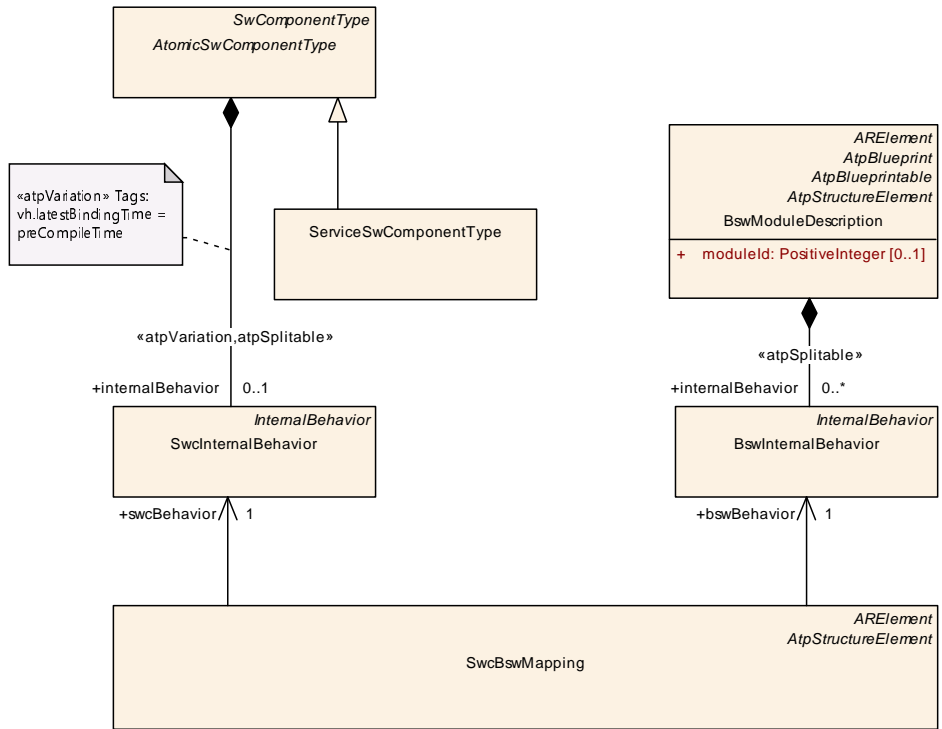

Figure 11.2: ServiceSwComponentType

Class	ServiceSwComponentType			
Package	M2::AUTOSARTemplates::SWComponentTemplate::Components			
Note	ServiceSwComponentType is used for configuring services for a given ECU. Instances of this class are only to be created in ECU Configuration phase for the specific purpose of the service configuration. Tags: atp.recommendedPackage=SwComponentTypes			
Base	ARElement, ARObject, AtomicSwComponentType, AtpBlueprint, AtpBlueprintable, AtpClassifier, AtpType, CollectableElement, Identifiable, MultilanguageReferrable, PackageableElement, Referrable, SwComponentType			
Attribute	Type	Mult.	Kind	Note
-	-	-	-	-

Table 11.2: ServiceSwComponentType

[TPS_SWCT_01412] **ServiceSwComponentType** shall be added in ECU Configuration phase [ServiceSwComponentType shall not be used when modeling application software using CompositionSwComponentType; they are only added in ECU Configuration phase where exactly one SwComponentPrototype per ServiceSwComponentType per ECU is added to the ECU Description model.

The Base ECU Config Generator tool needs to take care that for all service ports of SwComponentPrototypes mapped to the ECU service ports at the appropriate ServiceSwComponentTypes are created.

In case of pattern A for each different type of service port one port on the ServiceSwComponentType is created.

In case of pattern B and C for each service port of a SwComponentPrototype one port on the ServiceSwComponentType is created.

More explicitly, all instances of `AtomicSwComponentType` need to be checked for `PortPrototypes` of `PortInterfaces` with `isService` attribute set to `true` and referenced by `ServiceNeeds` and for each of these `PortInterface` instances belonging to the `AUTOSAR Service` to be configured one `PortPrototype` implementing the same or a compatible `PortInterface` needs to be created on the `ServiceSwComponentType`.]()

In the process of creating `PortPrototypes` the specified communication pattern A, B, or C for a specific kind of service port has to be considered, see table 11.1.

[TPS_SWCT_02500] Roles on Application/Service Components need to Match [The roles of the `PortPrototypes` (required/provided) on the Application Component and the Service Component side obviously need to match. For example an `RPortPrototype` attached to an application `AtomicSwComponentType` matches a `PPortPrototype` attached to a `ServiceSwComponentType`.]()

11.4 Service Proxy Component Type

[TPS_SWCT_01413] Local communication with services [Application software components may communicate with an instance of a `ServiceSwComponentType` only locally on an ECU.]()

[TPS_SWCT_01414] Mode manager needs to communicate with application software components located on other ECUs [There are however use cases for the application and vehicle mode management, where a mode manager (namely the `Basic Software Mode Manager`, see [14]) is part of the basic software but conceptually still needs to communicate with application software components located on other ECUs.

In order to make this communication possible, the `ServiceProxySwComponentType` is used.

For the application software and the RTE it behaves like a “normal” `AtomicSwComponentType`, but it is actually a proxy for an `AUTOSAR Service`.]()

The concept of mode requests across ECU boundaries is exemplified in Figure 11.3.

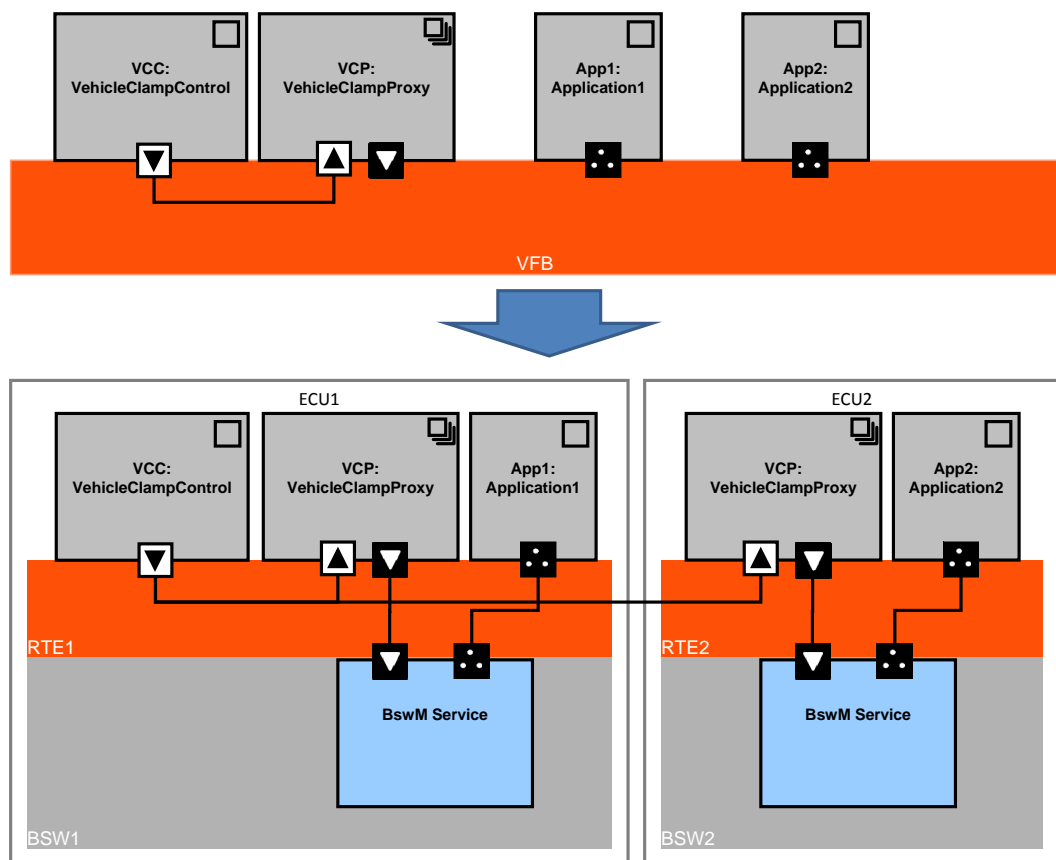

Figure 11.3: Mode request over the network [3]

[TPS_SWCT_01415] Interfaces of **ServiceProxySwComponentType** [This means that on the one side it has to communicate over service ports with the ECU-local **ServiceSwComponentType** it represents. On the other side it has to offer the corresponding **PortPrototypes** to the **ApplicationSwComponentTypes**.]()

In the meta-model, the **ServiceProxySwComponentType** does not differ from an **ApplicationSwComponentType** except by its class. It is up to the implementer to meet the restrictions imposed by the semantics as a proxy.

[TPS_SWCT_01416] Difference between a **ServiceProxySwComponentType** and an **ApplicationSwComponentType** [The main difference between a **ServiceProxySwComponentType** and an **ApplicationSwComponentType** is on system level:

A prototype of a **ServiceProxySwComponentType** can be mapped to several ECUs even if it appears only once in the VFB system, because such a prototype is required on each ECU, where it has to address a local **ServiceSwComponentType**.

As a result of this, a **ServiceProxySwComponentType** can only receive but not send signals over the network. More details are explained in the class table below.]()

Class	ServiceProxySwComponentType			
Package	M2::AUTOSARTemplates::SWComponentTemplate::Components			
Note	<p>This class provides the ability to express a software-component which provides access to an internal service for remote ECUs. It acts as a proxy for the service providing access to the service.</p> <p>An important use case is the request of vehicle mode switches: Such requests can be communicated via sender-receiver interfaces across ECU boundaries, but the mode manager being responsible to perform the mode switches is an AUTOSAR Service which is located in the Basic Software and is not visible in the VFB view. To handle this situation, a ServiceProxySwComponentType will act as proxy for the mode manager. It will have R-Ports to be connected with the mode requestors on VFB level and Service-Ports to be connected with the local mode manager at ECU integration time.</p> <p>Apart from the semantics, a ServiceProxySwComponentType has these specific properties:</p> <ul style="list-style-type: none"> • A prototype of it can be mapped to more than one ECUs in the system description. • Exactly one additional instance of it will be created in the ECU-Extract per ECU to which the prototype has been mapped. • For remote communication, it can have only R-Ports with sender-receiver interfaces and 1:n semantics. • There shall be no connectors between two prototypes of any ServiceProxySwComponentType. <p>Tags:atp.recommendedPackage=SwComponentTypes</p>			
Base	ARElement , ARObject , AtomicSwComponentType , AtpBlueprint , AtpBlueprintable , AtpClassifier , AtpType , CollectableElement , Identifiable , MultilanguageReferrable , PackageableElement , Referrable , SwComponentType			
Attribute	Type	Mult.	Kind	Note
–	–	–	–	–

Table 11.3: ServiceProxySwComponentType

[constr_2016] Connections between SwComponentPrototypes of type ServiceProxySwComponentType [A connection between PortPrototypes belonging to SwComponentPrototypes where both are typed by ServiceProxySwComponentType is not permitted.]()

[constr_2017] Ports of ServiceProxySwComponentTypes [ServiceProxySwComponentType is only permitted to define

- RPortPrototypes that are typed by SenderReceiverInterface or
- PortPrototypes that are typed by a PortInterface where the isService attribute is set to true.

]()

[constr_2018] Supported remote communication of a ServiceProxySwComponentType [For remote communication, ServiceProxySwComponentType can have only RPortPrototypes typed by SenderReceiverInterfaces in a 1:n communication scenario.]()

11.5 Non Volatile Memory

11.5.1 Introduction

The AUTOSAR Architecture defines two alternatives how a software component can access non-volatile memory.

- The first option is that the software component defines in its `InternalBehavior` a `PerInstanceMemory` and a `NvBlockNeeds` referring to the `PerInstanceMemory` via a `RoleBasedDataAssignment`.

In this case the `NVRAM Block` is exclusively accessed by this software component and the `NvM` [33]. Therefore, the *nv data* is encapsulated inside the software component and can not be accessed directly by other software components.

The `PerInstanceMemory` can be typed with `AutosarDataTypes` in the case of `arTypedPerInstanceMemory` or with C data types in the case of `perInstanceMemory`. For further information see section 7.7 and 13.

- The second option is that the software component uses communication based on `PortPrototypes` to access *nv data* provided by a `NvBlockSwComponentType`.

In this case it is possible that *nv data* used by different `AtomicSwComponentTypes` is packed in one larger `NVRAM Block` to reduce the `NVRAM Block` management overhead or that the same *nv data* used by several software components with a reduced RAM overhead. The *nv data* of a `NvBlockSwComponentType` is typed with `AutosarDataTypes`.

More details regarding particular scenarios of interacting with the `NvM` [33] can be found in section 13.2.

11.5.2 NvBlockComponent

[TPS_SWCT_01142] non-volatile data are provided by a specialized `AtomicSwComponentType` [On the VFB [3], the non-volatile data are provided by a specialized `AtomicSwComponentType`, the `NvBlockSwComponentType`.

An `NvBlockSwComponentType` can represent one or more `NVRAM Blocks` managed by the *NVRAM Manager*. The *nv data PortPrototypes* of the `NvBlockSwComponentType` are exclusively typed by `NvDataInterfaces`.] (*RS_SWCT_03225*)

[TPS_SWCT_01143] Non-volatile data represented by an `NvBlockSwComponentType` can be read and written [The non-volatile data represented by an `NvBlockSwComponentType` can be read and written. For this purpose the `NvBlockSwComponentType` is allowed to have `PPortPrototypes` and `RPortPrototypes`.] (*RS_SWCT_03225*)

Additionally, the `NvBlockSwComponentType` might have client server `PortPrototypes` to offer the block-related services, administrative services or notifications.

[constr_2009] Supported kinds of `PortPrototypes` of a `NvBlockSwComponentType` [With respect to external communication, `NvBlockSwComponentType` is limited to the definition of the following kinds of `PortPrototype`:

- `PortPrototypes` typed by either `NvDataInterfaces` or `ClientServerInterfaces`
- `RPortPrototypes` typed by `ModeSwitchInterfaces`

]()

[constr_2010] Connections between `SwComponentPrototypes` of type `NvBlockSwComponentType` [The existence of `SwConnectors` that refer to `PortPrototypes` belonging to `SwComponentPrototypes` where both are typed by `NvBlockSwComponentType` is not permitted.]()

Class	NvBlockSwComponentType			
Package	M2::AUTOSARTemplates::SWComponentTemplate::Components			
Note	The <code>NvBlockSwComponentType</code> defines non volatile data which data can be shared between <code>SwComponentPrototypes</code> . The non volatile data of the <code>NvBlockSwComponentType</code> are accessible via provided and required ports. Tags: atp.recommendedPackage=SwComponentTypes			
Base	ARElement , ARObject , AtomicSwComponentType , AtpBlueprint , AtpBlueprintable , AtpClassifier , AtpType , CollectableElement , Identifiable , MultilanguageReferrable , PackageableElement , Referrable , SwComponentType			
Attribute	Type	Mult.	Kind	Note
bulkNvDataDescriptor	BulkNvDataDescriptor	*	aggr	This aggregation formally defines the bulk Nv Blocks that are provided to the application software by the enclosing <code>NvBlockSwComponentType</code> . Stereotypes: atpSplitable; atpVariation Tags: atp.Splitkey=shortName, variationPoint.shortLabel atp.Status=draft vh.latestBindingTime=preCompileTime
nvBlockDescriptor	NvBlockDescriptor	*	aggr	Specification of the properties of exactly one NVRAM Block. Stereotypes: atpSplitable; atpVariation Tags: atp.Splitkey=shortName, variationPoint.shortLabel vh.latestBindingTime=preCompileTime

Table 11.4: NvBlockSwComponentType

Class	NvDataInterface
Package	M2::AUTOSARTemplates::SWComponentTemplate::PortInterface
Note	A non volatile data interface declares a number of <code>VariableDataPrototypes</code> to be exchanged between non volatile block components and atomic software components. Tags: atp.recommendedPackage=PortInterfaces





Class	NvDataInterface			
Base	ARElement , ARObject , AtpBlueprint , AtpBlueprintable , AtpClassifier , AtpType , CollectableElement , DataInterface , Identifiable , MultilanguageReferrable , PackageableElement , PortInterface , Referrable			
Attribute	Type	Mult.	Kind	Note
nvData	VariableDataPrototype	1..*	aggr	The VariableDataPrototype of this nv data interface.

Table 11.5: NvDataInterface

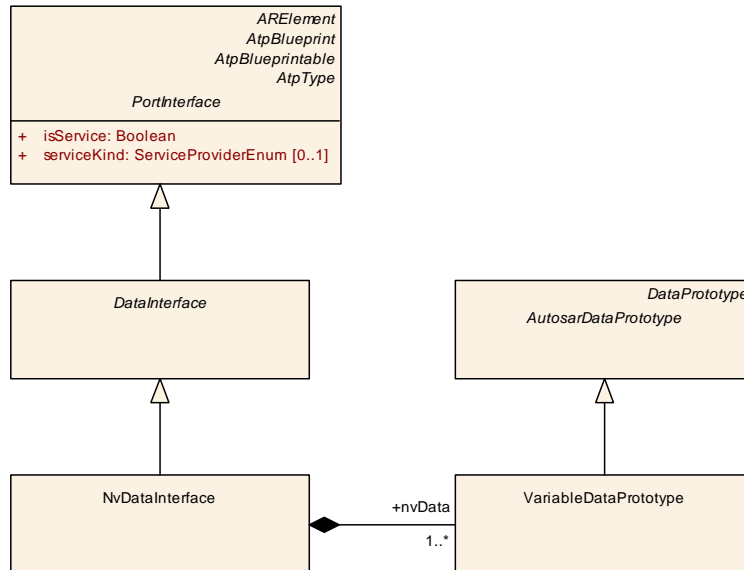

Figure 11.4: NvDataInterface

11.5.3 Software-Components using *NVRAM* data of NvBlockComponents

[constr_2011] Connections between SwComponentPrototypes typed by NvBlockSwComponentType and SwComponentPrototypes typed by other AtomicSwComponentTypes [The *nv data* PortPrototypes of the SwComponent-Prototype typed by an NvBlockSwComponentType are either connected with PortPrototypes typed by NvDataInterfaces or SenderReceiverInterfaces of other AtomicSwComponentType.]()

[constr_1148] PortInterfaces of PortPrototypes used to connect to NvBlockSwComponentTypes [PortInterfaces of PortPrototypes used to connect to NvBlockSwComponentTypes as well as the PortInterfaces used in the context of NvBlockSwComponentTypes shall **always** set the value of the attribute *isService* to false.]()

[constr_1149] PortPrototypes used for NV data management [A PortPrototype typed by a ClientServerInterface used for NV data management, i.e.

the interaction of `ApplicationSwComponentTypes` with `NvBlockSwComponentTypes`, shall be typed by `ClientServerInterfaces` that are compatible to the particular `ClientServerInterfaces` derived from `MOD_GeneralBlueprints` [26]. [`constr_1148`] applies.]()

For details see chapter 6.4.4.

Note: In case of *nv data* which is read and written and shared between several `SwComponentPrototypes` the `NvBlockSwComponentType` establishes a not directly obvious kind of communication.

Nevertheless, this is intentionally supported and it is under responsibility of the VFB designer to take care that only *nv data* is shared where the functionality of the software components is not impaired.

To determine for an VFB designer which *nv data* can be potentially by mapped into the same `NVRAM Block` a software-component can specify further attributes for its *nv data PortPrototypes* by the definition of `SwcServiceDependency(s)` with `NvBlockNeeds`.

In this case the role attribute of the `assignedPort` has to be set to the value `NvDataPort`. This aspect is also explained in section 13.2.4.

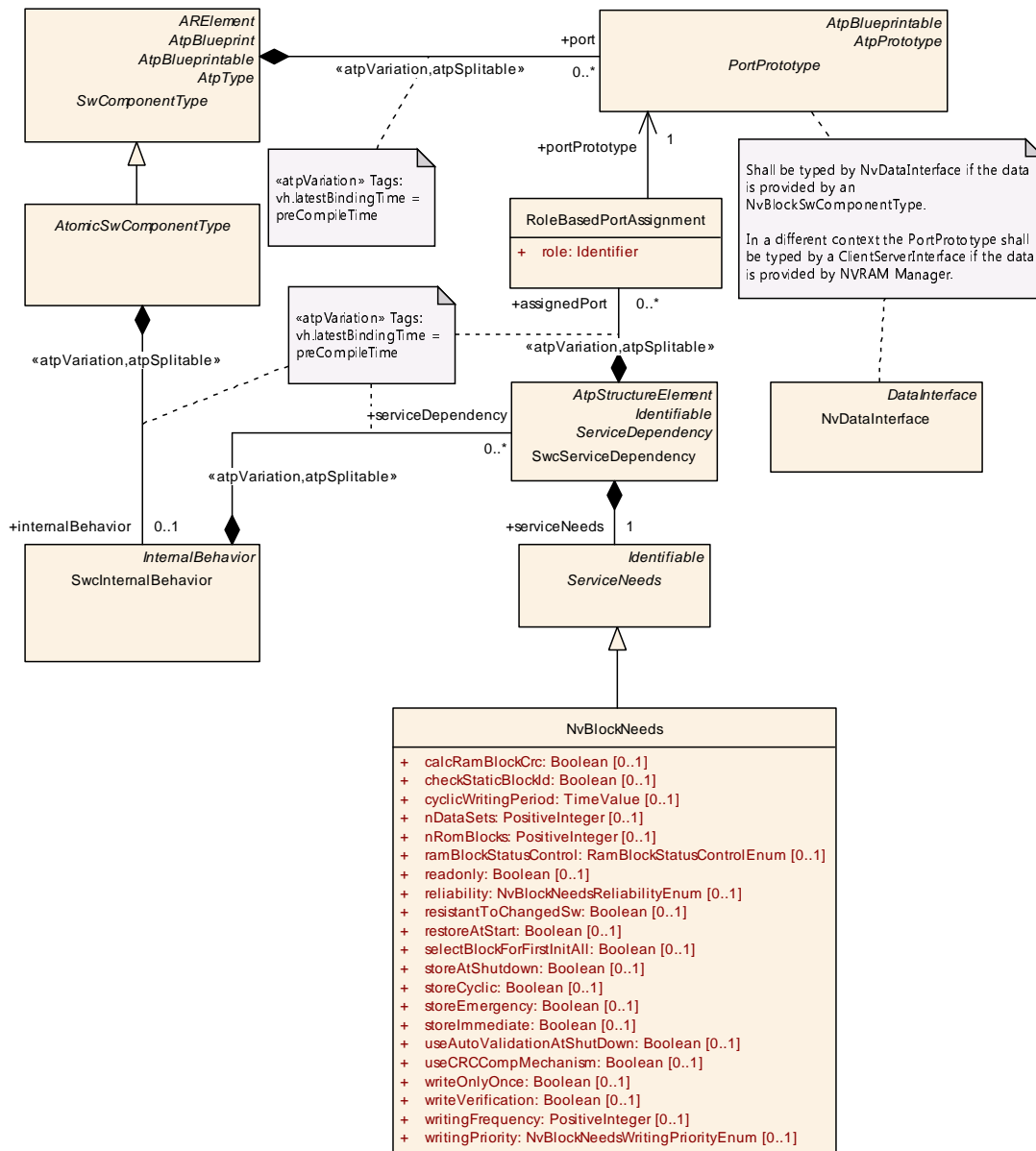

Figure 11.5: NvBlockNeeds for nv data PortPrototypes

In contrast to the **NvBlockNeeds** that describe the expected configuration of a whole NVRAM Block, the **NvBlockNeeds** for *nv data PortPrototypes* defines only the attributes which are required from the point of view of a software-component to ensure its functionality.

This means an empty attribute has the semantic of “don’t care”.

Further on the VFB designer has got the freedom to specify how the requested NVRAM Block attributes are fulfilled by the created **NvBlockDescriptor**.

For instance, *nv data* with different **writingFrequency** might be mapped to one NVRAM Block. In this case the **NvBlockNeeds** of the **NvBlockDescriptor** has to indicate the worst case which is the higher frequency.

[TPS_SWCT_01675] Recommendations for attributes of **NvBlockNeeds** or for **NvBlockDescriptor** [The formal modeling of a **NvBlockDescriptor** should follow the recommendations given in table 11.6.] (*RS_SWCT_03225*)

But please note that table 11.6 does not represent a binding constraint.

Attribute of NvBlockNeeds	NvBlockNeeds of different <i>nv data PortPrototypes</i> of software-components	NvBlockNeeds of NvBlockDescriptor
readonly	Recommended to match for all connected <i>nv data PortPrototypes</i> if specified.	Recommended to be identical as requested by <i>nv data PortPrototypes</i> .
reliability	Can be different.	Recommended to be set to the highest reliability class request by any mapped <i>nv data PortPrototypes</i> .
resistantToChangedSw	Recommended to match for all connected <i>nv data PortPrototypes</i> if specified.	Recommended to be identical as requested by <i>nv data PortPrototypes</i> .
restoreAtStart	Recommended to match for all connected <i>nv data PortPrototypes</i> if specified.	Recommended to be identical as requested by <i>nv data PortPrototypes</i> .
storeAtShutdown	Recommended to match for all connected <i>nv data PortPrototypes</i> if specified.	Recommended to be identical as requested by <i>nv data PortPrototypes</i> .
writeOnlyOnce	Recommended to match for all connected <i>nv data PortPrototypes</i> if specified.	Recommended to be identical as requested by <i>nv data PortPrototypes</i> .
writingFrequency	Can be different.	Recommended to be set to the highest requested frequency of the mapped <i>nv data PortPrototypes</i> .
writingPriority	Can be different.	Recommended to be set to the highest requested priority of the mapped <i>nv data PortPrototypes</i> .
writeVerification	Can be different.	Recommended to set to true if any of the <i>nv data PortPrototypes</i> requests a write verification.
calcRamBlockCrc	Can be different.	Recommended to set to true if any of the <i>nv data PortPrototypes</i> requests a CRC calculation.
checkStaticBlockId	Can be different.	Recommended to set to true if any of the <i>nv data PortPrototypes</i> requests a check of the static block ID.
ramBlockStatusControl	Can be different.	Recommended to set to <code>RamBlockStatusControlEnum.api</code> if any of the <i>nv data PortPrototypes</i> requests a use of the API for accessing the block.
storeCyclic	Can be different.	Recommended to set to true if any of the <i>nv data PortPrototypes</i> requests cyclic writing.
storeEmergency	Can be different.	Recommended to set to true if any of the <i>nv data PortPrototypes</i> requests emergency writing.
storeImmediate	Can be different.	Recommended to set to true if any of the <i>nv data PortPrototypes</i> requests immediate writing.
selectBlockForFirstInitAll	Recommended to match for all connected <i>nv data PortPrototypes</i> if specified.	Recommended to be identical as requested by <i>nv data PortPrototypes</i> .

Table 11.6: NvBlockNeeds dependencies

With respect to the completeness of table 11.6 (which intentionally doesn't contain a remark regarding the value of `cyclicWritingPeriod`), it should be noted that

(according to [TPS_SWCT_01585]) the value of `NvBlockDescriptor.nvBlockNeeds.cyclicWritingPeriod` shall be ignored in favor of `NvBlockDescriptor.timingEvent.period`.

Therefore, the missing statement for `cyclicWritingPeriod` in the spirit of table 11.6 is that the values of `SwcServiceDependency.serviceNeeds.cyclicWritingPeriod` can be different from the value of `NvBlockDescriptor.timingEvent.period`.

It is recommended that the value of `NvBlockDescriptor.timingEvent.period` shall be set to the lowest requested time value of the mapped *nv data* `PortPrototypes` (implemented by `SwcServiceDependency.serviceNeeds.cyclicWritingPeriod`).

11.5.4 Software-Components connected to NvBlockComponents

Please note that restrictions apply on the creation of `AssemblySwConnectors` between `NvBlockSwComponentType` and other `AtomicSwComponentTypes`.

In particular `ApplicationSwComponentTypes` communicating with each other used buffers generated and controlled by the RTE to exchange data. An `NvBlockSwComponentType`, however, maintains its own buffer in form of the `ramBlock`.

Thus, an `ApplicationSwComponentType` that reads a `dataElement` that may be provided by either another `ApplicationSwComponentType` or an `NvBlockSwComponentType` could not actually access the `dataElement` because it cannot decide whether it needs to access the buffer provided by the RTE or the `ramBlock`.

Therefore, scenarios like this are considered invalid by regulation of the AUTOSAR standard.

[constr_1417] Invalid connection between NvBlockSwComponentType and other AtomicSwComponentType (I) [A configuration where an `RPortPrototype` owned by an `AtomicSwComponentType` is simultaneously and directly connected to `AbstractProvidedPortPrototypes` of a collection of `AtomicSwComponentTypes` where at least one in the collection is an `NvBlockSwComponentType` for a matching set of `dataElements` in all these `PortPrototypes` shall be considered invalid.]()

The scenario covered by [constr_1417] is depicted in Figures 11.6 and 11.7.

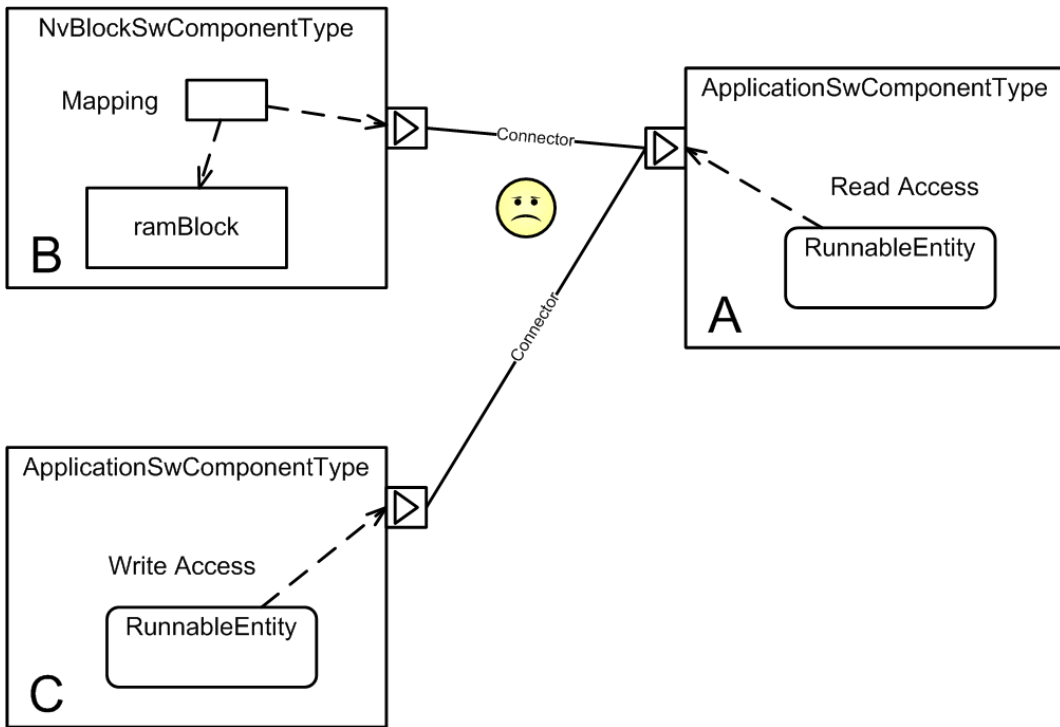

Figure 11.6: Example invalid connection between software-components (a)

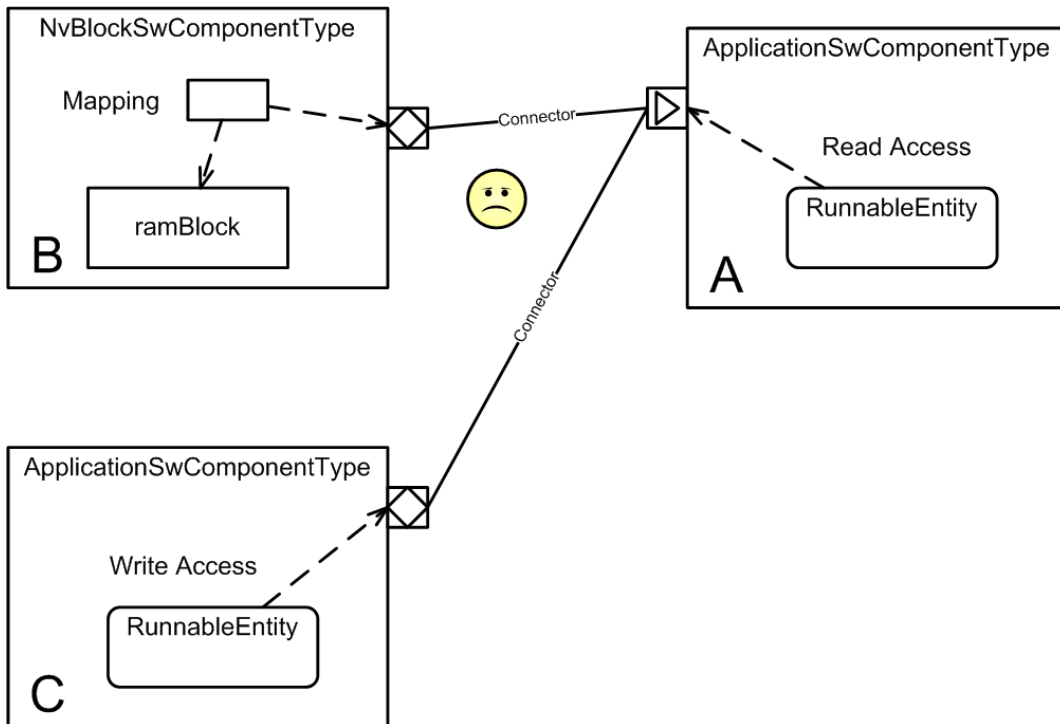

Figure 11.7: Example invalid connection between software-components (b)

[constr_1418] Invalid connection between *NvBlockSwComponentType* and other *AtomicSwComponentType* (II) [A configuration where a *PRPortPrototype* owned by an *AtomicSwComponentType* is connected to a *PPortPrototype* owned by an *NvBlockSwComponentType* for a matching set of *dataElements* in all these *Port-Prototypes* shall be considered invalid.]()

The scenario covered by [constr_1418] is depicted in Figure 11.8.

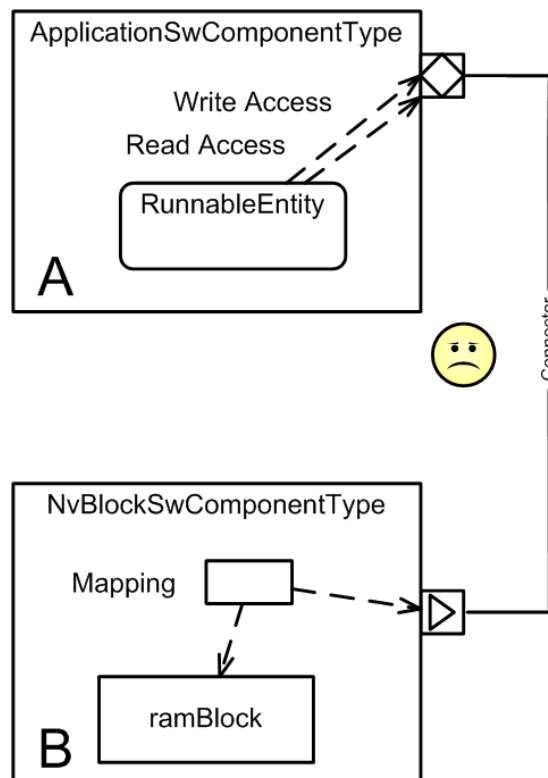

Figure 11.8: Example invalid connection between software-components (c)

11.5.5 NvBlockDescriptor

[TPS_SWCT_01144] *NvBlockDescriptor* specifies the properties of exactly one NVRAM Block [A *NvBlockDescriptor* specifies the properties of exactly one NVRAM Block of a *NvBlockSwComponentType*.

It contains information about the requested NVRAM Block configuration of the *NVRAM Manager*, *ramBlock* and *romBlock*, the mapping between the *PortPrototypes* of the *NvBlockSwComponentType* and the data inside a *ramBlock* as well as the role of the *clientServerPorts* expressed in terms of *RoleBasedPortAssignment*.]

()

Class	NvBlockDescriptor			
Package	M2::AUTOSARTemplates::SWComponentTemplate::NvBlockComponent			
Note	Specifies the properties of exactly on NVRAM Block.			
Base	ARObject, AtpClassifier, AtpFeature, AtpStructureElement, Identifiable , MultilanguageReferrable , Referrable			
Attribute	Type	Mult.	Kind	Note
clientServerPort	RoleBasedPortAssignment	*	aggr	<p>The RoleBasedPortAssignment defines which client server port of the NvBlockSwComponentType serves for which kind of service or notification. In case of notifications one common callback function is provided by the RTE for each individual kind of notification defined by the "role".</p> <p>The aggregation of RoleBasedPortAssignment is subject to variability with the purpose to support the conditional existence of ports.</p> <p>Stereotypes: atpVariation Tags:vh.latestBindingTime=preCompileTime</p>
constantValue Mapping	ConstantSpecificationMappingSet	*	ref	<p>Reference to the ConstanSpecificationMapping to be applied for the particular NVRAM Block</p> <p>Stereotypes: atpSplitable Tags:atp.Splitkey=constantValueMapping</p>
dataType Mapping	DataTypeMappingSet	*	ref	<p>Reference to the DataTypeMapping to be applied for the particular NVRAM Block.</p> <p>Stereotypes: atpSplitable Tags:atp.Splitkey=dataTypeMapping</p>
instantiation DataDefProps	InstantiationDataDefProps	*	aggr	<p>The purpose of InstantiationDataDefProps are the refinement of some data def properties of individual instantiations within the context of a NvBlockSw ComponentType.</p> <p>The aggregation of InstantiationDataDefProps is subject to variability with the purpose to support the conditional existence of ports, component internal memory objects and those attributes.</p> <p>Stereotypes: atpVariation Tags:vh.latestBindingTime=preCompileTime</p>
modeSwitch EventTriggered Activity	ModeSwitchEventTriggeredActivity	*	aggr	<p>This represents the collection of ModeSwitchEvent TriggeredActivities related to the enclosing NvBlock Descriptor.</p> <p>Stereotypes: atpSplitable; atpVariation Tags: atp.Splitkey=modeSwitchEventTriggeredActivity, variation Point.shortLabel vh.latestBindingTime=preCompileTime</p>
nvBlockData Mapping	NvBlockDataMapping	1..*	aggr	<p>Defines the mapping between the VariableData Prototypes in the NvBlockComponents ports and the VariableDataPrototypes of the RAM Block.</p> <p>The aggregation of NvBlockDataMapping is subject to variability with the purpose to support the conditional existence of nv data ports.</p> <p>Stereotypes: atpVariation Tags:vh.latestBindingTime=preCompileTime</p>





Class	NvBlockDescriptor			
nvBlockNeeds	NvBlockNeeds	1	aggr	<p>Specifies the abstract needs on the configuration of the NVRAM Manager for the single NVRAM Block described by this NvBlockDescriptor.</p> <p>In addition, it may define requirements for writing strategies in an implementation of an NvBlockSw ComponentType by the RTE.</p> <p>Please note that the attributes nDataSets and nRom Blocks are not relevant for this aggregation because the RTE will allocate just one block anyway. In a different context, however, they do make sense.</p>
ramBlock	VariableDataPrototype	1	aggr	Defines the RAM Block of the NVRAM Block provided by NvBlockSwComponentType.
romBlock	ParameterData Prototype	0..1	aggr	Defines the ROM Block of the NVRAM Block provided by NvBlockSwComponentType.
supportDirty Flag	Boolean	0..1	attr	Specifies whether calling of NvM functions for writing and/or status control of potentially modified RAM Blocks to NV memory shall be controlled by the RTE.
timingEvent	TimingEvent	0..1	ref	this reference can be taken to identify the TimingEvent to be used by the RTE for implementing a cyclic writing strategy for this block
writingStrategy Role	RoleBasedData Assignment	0..1	aggr	This attribute allows for assigning a specific writing strategy for an incoming AutosarDataPrototype.

Table 11.7: NvBlockDescriptor

For more explanation about the semantics of the attribute [NvBlockDescriptor.supportDirtyFlag](#) please refer to the SWS RTE [2].

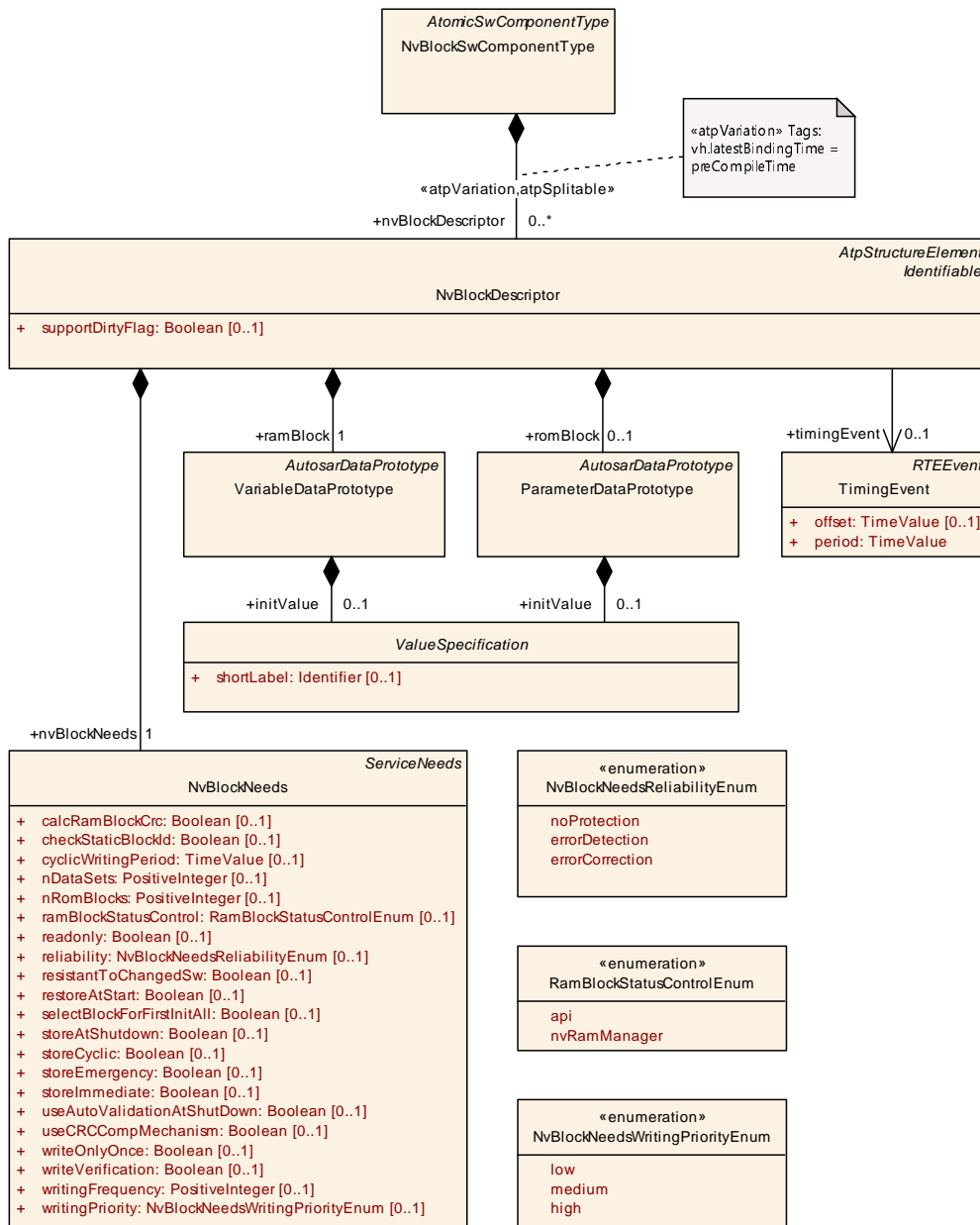

Figure 11.9: NvBlockSwComponentType and NvBlockDescriptor

[constr_1095] Values of nDataSets vs. reliability [If the value of nDataSets is greater than 0, the value of reliability shall not be set to errorCorrection.]
()

The reason for the existence of [constr_1095] is that the AUTOSAR NvM [33] does not support error correction for NV data sets.

If the value of nDataSets is equal to 0, the value of reliability can take any value out of NvBlockNeedsReliabilityEnum.

11.5.5.1 Writing Strategies

[TPS_SWCT_01586] Writing strategies for *nv data* [By setting certain attributes in the meta-class `NvBlockDescriptor` it is possible to configure different writing strategies for the values of an `RAM Block` to the NVRAM storage. [\[constr_1310\]](#) applies.

The following use cases are supported:

- Write data **cyclically**. This use case requires the existence of attribute `NvBlockDescriptor.nvBlockNeeds.storeCyclic` with the value `true` and also attribute `NvBlockDescriptor.nvBlockNeeds.cyclicWritingPeriod` needs to exist and have a reasonable value.

In the context of using the attribute `NvBlockDescriptor.nvBlockNeeds.cyclicWritingPeriod` the constraints [\[constr_1308\]](#) and [\[constr_1309\]](#) apply.

- Write data **immediately**. This means that data send to the `NvBlockSwComponentType` will be written immediately to NVRAM storage.

This use case corresponds to setting the value of attribute `NvBlockDescriptor.nvBlockNeeds.storeImmediate` to the value `true`.

- Write on **emergency**. With this setting, data shall be written to NVRAM storage if the ECU fails in some way.

This use case corresponds to setting the value of attribute `NvBlockDescriptor.nvBlockNeeds.storeEmergency` to `true`.

As explained in [\[TPS_SWCT_01589\]](#), setting the value of this attribute is not sufficient to achieve the intended semantics.

- Write at **shutdown**. Here, the data is written to NVRAM storage when the ECU shuts down.

This use case corresponds to setting the value of attribute `NvBlockDescriptor.nvBlockNeeds.storeAtShutdown` to `true`.

- Write on **mode switch**. Here, the data is written to NVRAM in response to a mode switch configured to trigger the writing.

This use case corresponds to the existence of attribute `NvBlockDescriptor.modeSwitchEventTriggeredActivity`.

]([RS_SWCT_03225](#))

Please refer to [\[TPS_SWCT_01587\]](#) and Figure 11.10 for more information about how the use case to write data cyclically can be configured.

Please refer to [\[TPS_SWCT_01588\]](#) and Figure 11.11 for more information about how the use case to write data immediately can be configured.

Of course, the actual implementation of the different writing strategies goes beyond setting the value of attributes and requires the existence of dedicated `RunnableEntities` in the `SwcInternalBehavior` of the enclosing `NvBlockSwComponentType` that are triggered in response to `RTEEvents` applicable for the particular use case.

[TPS_SWCT_01587] The cyclic writing of *nv data* requires the existence of a `TimingEvent` [The implementation of cyclic writing of *nv data* requires the existence of a `TimingEvent` that can be taken to trigger a corresponding `RunnableEntity` that in turn takes care of calling the respective APIs for writing the data.] (*RS_SWCT_03225*)

This aspect is depicted in Figure 11.10.

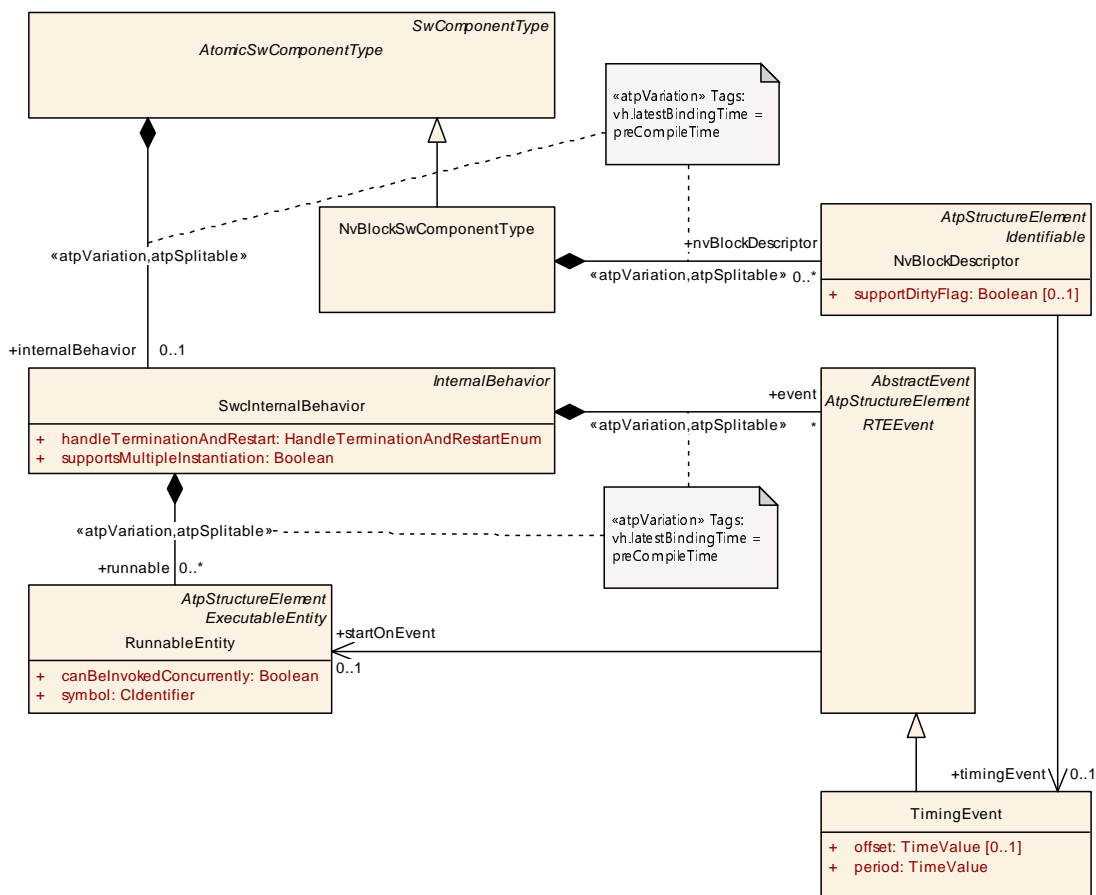

Figure 11.10: How to model a cyclic writing strategy for *nv data*

[TPS_SWCT_01588] `DataReceivedEvent` for storing *nv data* immediately [The approach to store data immediately after reception by an `NvBlockSwComponentType` requires the activation of a `RunnableEntity` by a `DataReceivedEvent`.] (*RS_SWCT_03225*)

This approach is depicted in Figure 11.11.

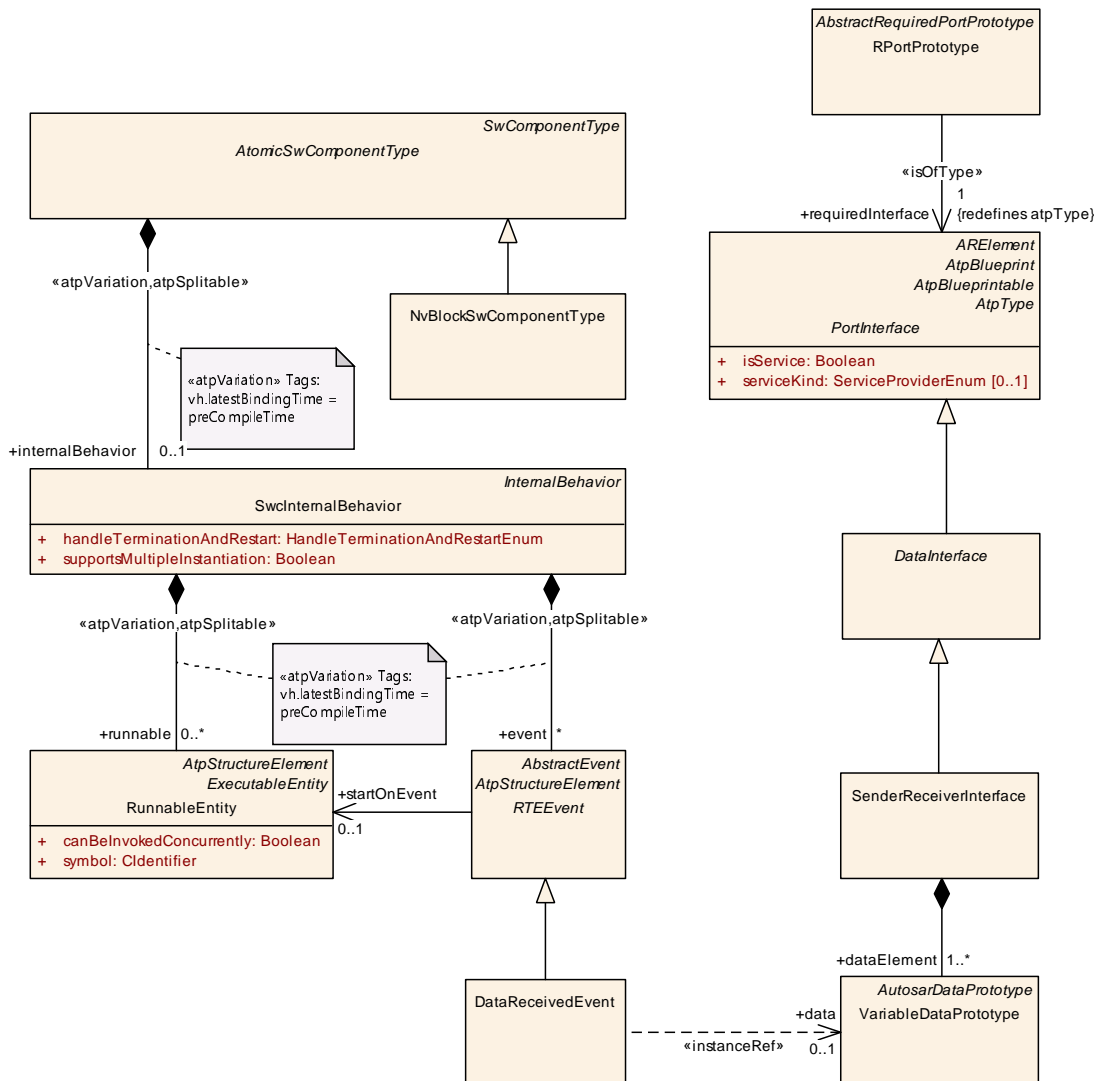

Figure 11.11: How to model an immediate writing strategy for *nv data*

[TPS_SWCT_01589] **Implementation of emergency storing of *nv data*** [The use case for [storeEmergency](#) can only be implemented by means of a Complex Driver.

In particular, the `Complex Driver` is responsible for the detection of an ECU failure. If a relevant error occurs the `Complex Driver` should call the `NvM` write block operation for the emergency blocks directly.] ([RS_SWCT_03225](#))

This consequently means that the `NvM` shall react to write operations coming from the `Complex Driver` by giving them the highest priority (re-queuing of `NvM` write block requests).

Please note that the behavior described in [TPS_SWCT_01587] in general is supported by AUTOSAR by requiring that `NVRAM Blocks` shall have to be configured with “immediate priority”. The technical implications are explained in the respective SWS [33], e.g. in [SWS_NvM_00182] and [SWS_NvM_00300].

[TPS_SWCT_01590] Combination of writing strategies for *nv data* is possible
 [AUTOSAR positively supports the configuration of a combination of writing strategies for *nv data*.] ([RS_SWCT_03225](#))

In other words, in consequence of [TPS_SWCT_01590] it is possible that (for example) both `NvBlockDescriptor.nvBlockNeeds.storeImmediate` and `NvBlockDescriptor.nvBlockNeeds.storeCyclic` may exist and set to `true` in the context of the same `NvBlockNeeds`.

[TPS_SWCT_01665] Usage of `SwcModeSwitchEvent` for triggering a write procedure of *nv data*
 [The approach to manage data of an `NvBlockSwComponentType` in response to a mode switch notification received from a mode manager requires the activation of a `RunnableEntity` by a `SwcModeSwitchEvent`.] ([RS_SWCT_03225](#))

[TPS_SWCT_01666] Semantics of `ModeSwitchEventTriggeredActivity.role`
 [If the role `ModeSwitchEventTriggeredActivity.role` is set to the value `WriteBlock` then NvM gets requested to write the *nv data* block after the corresponding `SwcModeSwitchEvents` occurs.] ([RS_SWCT_03225](#))

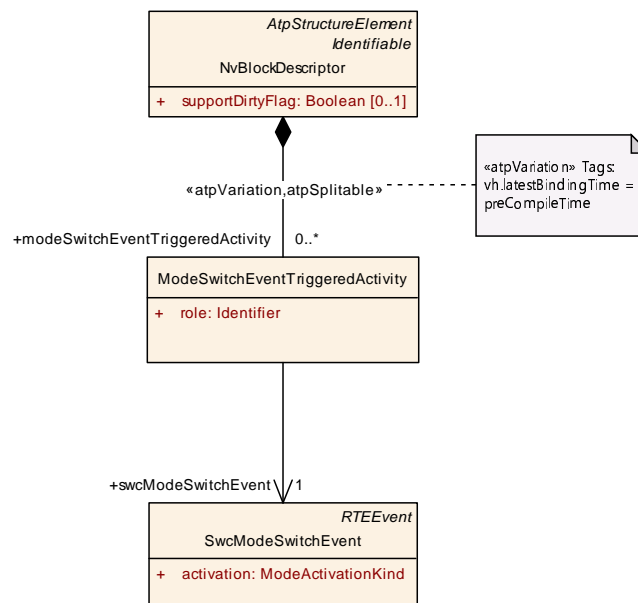

Figure 11.12: Usage of mode switch notification for the activation of a write-procedure of *nv data*

[constr_1415] Supported values of `ModeSwitchEventTriggeredActivity.role`
 [The only supported value of `ModeSwitchEventTriggeredActivity.role` is `WriteBlock`.] ()

Class	ModeSwitchEventTriggeredActivity			
Package	M2::AUTOSARTemplates::SWComponentTemplate::NvBlockComponent			
Note	This meta-class defines an activity of the NvBlockSwComponentType for a specific NvBlock which is triggered by a ModeSwitchEvent.			
Base	ARObject			
Attribute	Type	Mult.	Kind	Note
role	Identifier	1	attr	This attribute indicates which service of the NvM for the NvBlock shall be requested.
swcModeSwitchEvent	SwcModeSwitchEvent	1	ref	This reference identifies the SwcModeSwitchEvent that triggers the activity.

Table 11.8: ModeSwitchEventTriggeredActivity

11.5.5.1.1 Existence of multiple event-driven Writing Strategies

A use case might exist where (potentially in addition to a cyclic writing strategy) multiple event-based writing strategies to NvRam exist at the same time.

Writing strategies are typically implemented by means of different [RunnableEntities](#) that need to be triggered by the arrival of data at the [NvBlockSwComponentType](#). In this case, however, it is necessary to be able to assign the relation between incoming data and the [RunnableEntity](#) that applies the fitting writing strategy.

In the example scenario depicted in Figure 11.13, two [dataElements](#) are received by the [NvBlockSwComponentType](#). One [dataElement](#) shall be associated with the writing strategy to *store at shutdown* and the other [dataElement](#) shall be associated with an *immediate storage*.

Two [DataReceivedEvents](#) exist that can be taken to trigger [RunnableEntities](#). But without further formal specification, it is up to speculation which [DataReceivedEvent](#) shall be associated with which [RunnableEntity](#).

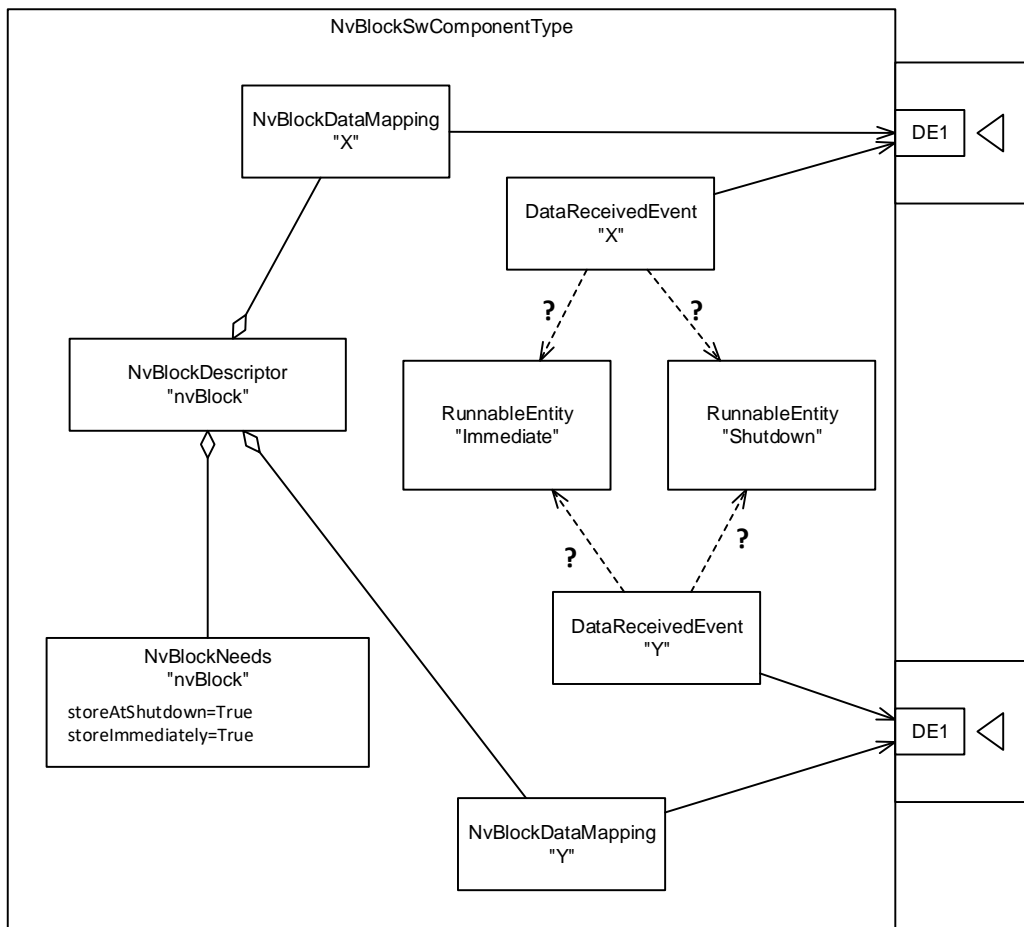

Figure 11.13: Existence of several event-based writing strategies for the same `NvBlockDescriptor`

To remove this degree of uncertainty, it is possible to use standardized values for the attribute `RoleBasedDataAssignment.role` and let the `RoleBasedDataAssignment` itself refer to the respective `dataElement`.

The approach is sketched in Figure 11.14 and its application to the depicted scenario is sketched in Figure 11.15.

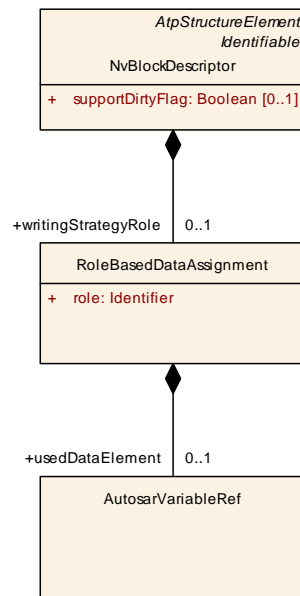

Figure 11.14: Modeling of `RoleBasedDataAssignment` in the context of `NvBlockDescriptor`

[TPS_SWCT_01795] Further specification to facilitate the association of writing strategies to the corresponding `RunnableEntity` [`NvBlockDescriptor` may aggregate `RoleBasedDataAssignment` in the role `writingStrategyRole` and the attribute `NvBlockDescriptor.writingStrategyRole.role` can be used to assign a writing strategy to an `AutosarDataPrototype` (referenced by means of `NvBlockDescriptor.writingStrategyRole.usedDataElement`) in the context of a `PortPrototype`.] (*RS_SWCT_03225*)

[constr_1713] `NvBlockDescriptor.writingStrategyRole.usedDataElement` shall refer to `AutosarDataPrototype` [The reference `NvBlockDescriptor.writingStrategyRole.usedDataElement` shall **only** refer to an `AutosarDataPrototype`.] ()

Rationale: the activation of a `RunnableEntity` that implements the respective writing strategy is triggered by the reception of an entire `AutosarDataPrototype`. The ability to refer to a `DataPrototype` inside the `AutosarDataPrototype` might give a false impression.

[constr_1714] `AutosarDataPrototype` shall only be referenced by a single `NvBlockDescriptor.writingStrategyRole` [If an `AutosarDataPrototype` in the context of a `PortPrototype` is referenced from a `NvBlockDescriptor.writingStrategyRole` then this `AutosarDataPrototype` shall not be referenced from any other `NvBlockDescriptor.writingStrategyRole`.] ()

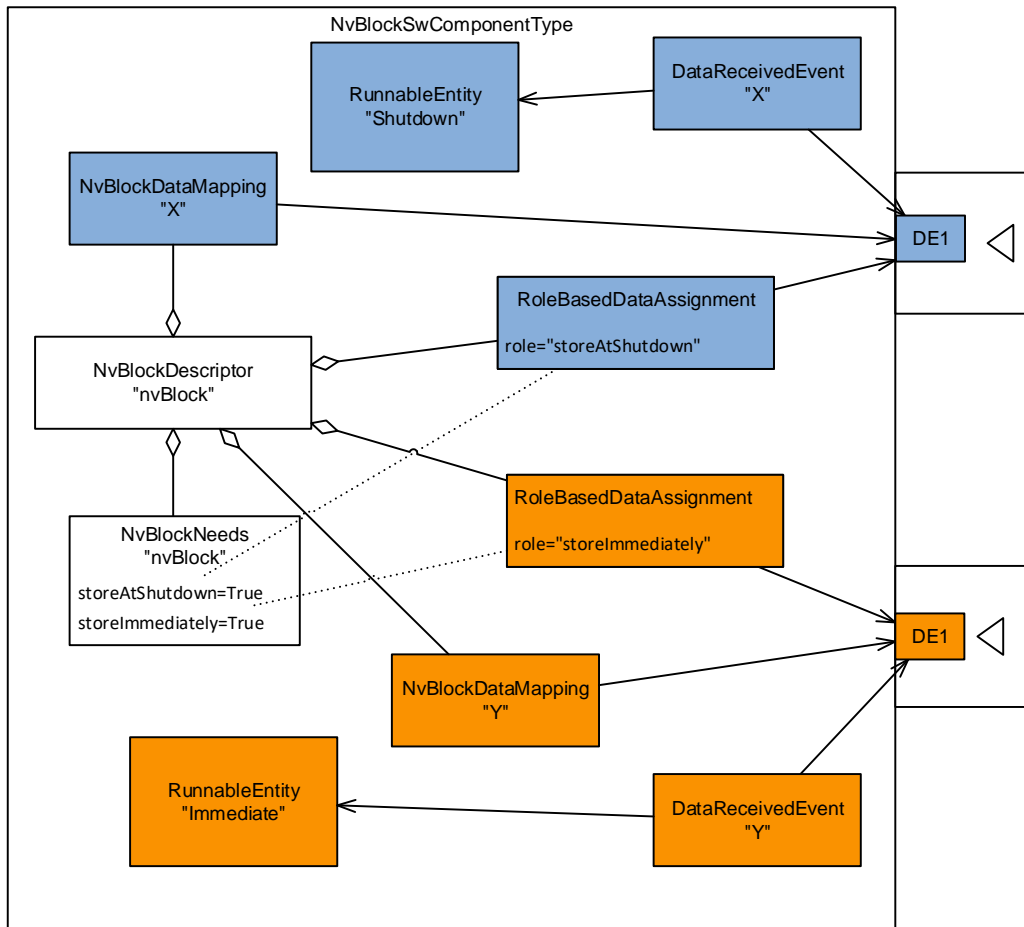

Figure 11.15: Solution for the existence of several event-based writing strategies for the same `NvBlockDescriptor`

[constr_1715] Possible values of attribute `NvBlockDescriptor.writingStrategyRole.role` [The attribute `NvBlockDescriptor.writingStrategyRole.role` shall only have one of the following values (see [TPS_SWCT_01586]):

- `storeAtShutdown`
- `storeImmediate`

]()

[constr_1716] Consistency of attribute `NvBlockDescriptor.writingStrategyRole.role` set to `storeAtShutdown` [The existence of `NvBlockDescriptor.writingStrategyRole` where attribute `role` is set to `storeAtShutdown` is only supported if `NvBlockDescriptor.nvBlockNeeds.storeAtShutdown` exists and is set to `True`.]()

[constr_1717] Consistency of attribute `NvBlockDescriptor.writingStrategyRole.role` set to `storeImmediate` [The existence of `NvBlockDescriptor.writingStrategyRole` where attribute `role` is set to `storeImmediate` is only

supported if `NvBlockDescriptor.nvBlockNeeds.storeImmediate` exists and is set to `True`.]()

11.5.5.2 NvBlockNeeds

The requested NVRAM Block configuration of the *NVRAM Manager* is described by the `NvBlockNeeds` of the `NvBlockDescriptor`.

This information can be evaluated during ECU configuration similar to the `NvBlockNeeds` of an atomic software component or a BSW module. For further details see section 13.

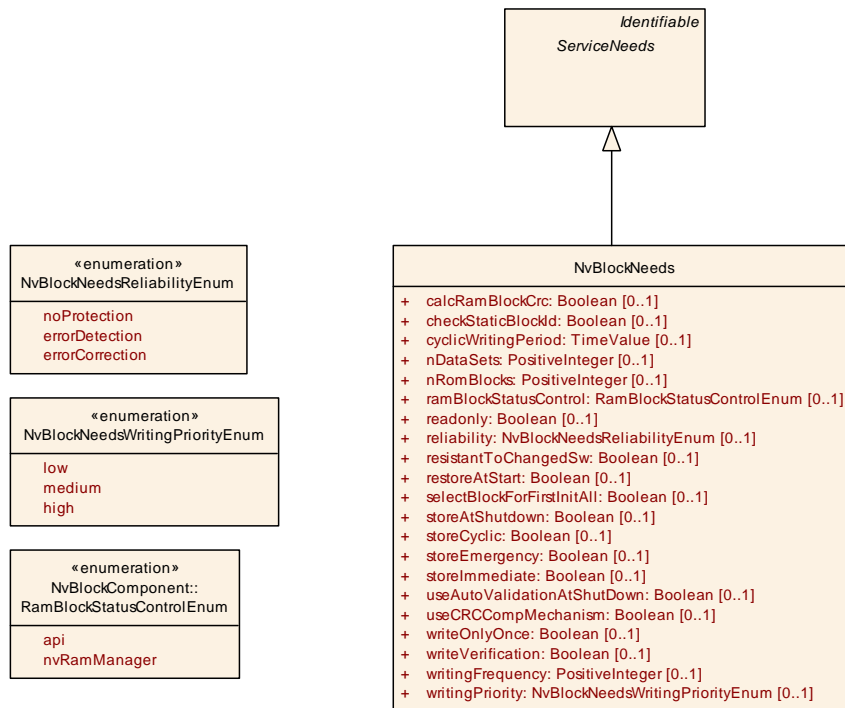

Figure 11.16: `NvBlockNeeds`

[constr_1308] Existence of `NvBlockNeeds.cyclicWritingPeriod` [The attribute `NvBlockNeeds.cyclicWritingPeriod` shall exist if and only if the attribute `NvBlockNeeds.storeCyclic` exists and its value is set to `true`.]()

Class	NvBlockNeeds			
Package	M2::AUTOSARTemplates::CommonStructure::ServiceNeeds			
Note	Specifies the abstract needs on the configuration of a single NVRAM Block.			
Base	<i>ARObject</i> , <i>Identifiable</i> , <i>MultilanguageReferrable</i> , <i>Referrable</i> , <i>ServiceNeeds</i>			
Attribute	Type	Mult.	Kind	Note





Class	NvBlockNeeds			
calcRamBlockCrc	Boolean	0..1	attr	Defines if CRC (re)calculation for the permanent RAM Block is required.
checkStaticBlockId	Boolean	0..1	attr	Defines if the Static Block Id check shall be enabled.
cyclicWritingPeriod	TimeValue	0..1	attr	This represents the period for cyclic writing of NvData to store the associated RAM Block.
nDataSets	PositiveInteger	0..1	attr	Number of data sets to be provided by the NVRAM manager for this block. This is the total number of ROM Blocks and RAM Blocks.
nRomBlocks	PositiveInteger	0..1	attr	Number of ROM Blocks to be provided by the NVRAM manager for this block. Please note that these multiple ROM Blocks are given in a contiguous area.
ramBlockStatusControl	RamBlockStatusControlEnum	0..1	attr	This attribute defines how the management of the RAM Block status is controlled.
readonly	Boolean	0..1	attr	True: data of this NVRAM Block are write protected for normal operation (but protection can be disabled) false: no restriction
reliability	NvBlockNeedsReliabilityEnum	0..1	attr	Reliability against data loss on the non-volatile medium.
resistantToChangedSw	Boolean	0..1	attr	Defines whether an NVRAM Block shall be treated resistant to configuration changes (true) or not (false). For details how to handle initialization in the latter case, please refer to the NVRAM specification.
restoreAtStart	Boolean	0..1	attr	Defines whether the associated RAM Block shall be implicitly restored during startup by the basic software.
selectBlockForFirstInitAll	Boolean	0..1	attr	If this attribute is set to true the NvM shall process this block in the NvM_FirstInitAll() function.
storeAtShutdown	Boolean	0..1	attr	Defines whether or not the associated RAM Block shall be implicitly stored during shutdown by the basic software.
storeCyclic	Boolean	0..1	attr	Defines whether or not the associated RAM Block shall be implicitly stored periodically by the basic software.
storeEmergency	Boolean	0..1	attr	Defines whether or not the associated RAM Block shall be implicitly stored in case of ECU failure (e.g. loss of power) by the basic software. If the attribute storeEmergency is set to true the associated RAM Block shall be configured to have immediate priority.
storeImmediate	Boolean	0..1	attr	Defines whether or not the associated RAM Block shall be implicitly stored immediately during or after execution of the according SW-C RunnableEntity by the basic software.
useAutoValidationAtShutDown	Boolean	0..1	attr	If set to true the RAM Block shall be auto validated during shutdown phase.
useCRCCompMechanism	Boolean	0..1	attr	If set to true the CRC of the RAM Block shall be compared during a write job with the CRC which was calculated during the last successful read or write job in order to skip unnecessary NVRAM writings.
writeOnlyOnce	Boolean	0..1	attr	Defines write protection after first write: true: This block is prevented from being changed/erased or being replaced with the default ROM data after first initialization by the software-component. false: No such restriction.
writeVerification	Boolean	0..1	attr	Defines if Write Verification shall be enabled for this NVRAM Block.





Class	NvBlockNeeds			
writingFrequency	PositiveInteger	0..1	attr	Provides the amount of updates to this block from the application point of view. It has to be provided in "number of write access per year".
writingPriority	NvBlockNeedsWritingPriorityEnum	0..1	attr	Requires the priority of writing this block in case of concurrent requests to write other blocks.

Table 11.9: NvBlockNeeds

Enumeration	NvBlockNeedsReliabilityEnum
Package	M2::AUTOSARTemplates::CommonStructure::ServiceNeeds
Note	Reliability against data loss on the non-volatile medium. These requirements give only a relative indication, for example on the required degree of redundancy for storage. They do, however, not specify by which means (e.g. software or hardware) the reliability is actually achieved.
Literal	Description
errorCorrection	Errors shall be corrected Tags: atp.EnumerationLiteralIndex=0
errorDetection	Errors shall be detected Tags: atp.EnumerationLiteralIndex=1
noProtection	Data need not to be handled with protection Tags: atp.EnumerationLiteralIndex=2

Table 11.10: NvBlockNeedsReliabilityEnum

[constr_1310] Existence of attributes of meta-class [NvBlockNeeds](#) [If in the context of an [ApplicationSwComponentType](#) the attribute [SwcServiceDependency.serviceNeeds](#) is implemented by an [NvBlockNeeds](#) then the following attributes

- [NvBlockNeeds.storeCyclic](#)
- [NvBlockNeeds.cyclicWritingPeriod](#)
- [NvBlockNeeds.storeEmergency](#)
- [NvBlockNeeds.storeImmediate](#)

shall only exist if in the context of the same [SwcServiceDependency](#) a [SwcServiceDependency.assignedPort](#) exists that has the attribute [role](#) set to the value [NvDataPort.](#)]()

11.5.5.3 RAM Block and ROM Block

[TPS_SWCT_01145] [ramBlock](#) and the [romBlock](#) are described by a [VariableDataPrototype](#) and a [ParameterDataPrototype](#) [The [ramBlock](#) and the [romBlock](#) are described by a [VariableDataPrototype](#) and a [ParameterDataPrototype](#) which are typed by an [AutosarDataType.](#)]()

[TPS_SWCT_01146] romBlock is optional [The `romBlock` is optional. If a `romBlock` is configured, the RTE copies the `romBlock` constants into the RAM Block in case of a block initialization notification (`NvMNotifyInitBlock`).]()

[TPS_SWCT_01147] No romBlock is configured [If there is no `romBlock` configured the connected software components are either required to offer this functionality by a proper implementation of block initialization notification or the NVRAM Block has to be configured, that no ROM Block is needed.]()

As a mitigation against a failed read operation from NV memory, it is recommended to always define a `romBlock` with suitable initial values to ensure the proper initialization of the corresponding `ramBlock`.

In particular, for software-components that don't define a `PortPrototype` typed by the `ClientServerInterface` with the standardized `shortName` `NotifyInitBlock` [33] it may happen that the `ramBlock` might not be properly initialized in case of failure.

[constr_2012] Compatibility of ImplementationDataTypes used for ramBlock and romBlock [

The `ramBlock` and the `romBlock` shall have compatible `ImplementationDataTypes` to ensure, that the NVRAM Block default values in the ROM Block can be copied into the RAM Block.

]()

Additionally, it is possible that RAM Block and ROM Block are defined to be able to calibrate or measurable. Preceding `SwDataDefProps` might be defined with the means of an `InstantiationDataDefProps`.

11.5.5.4 NvBlockDataMapping

[TPS_SWCT_01148] NvBlockDataMapping [The meta-class `NvBlockDataMapping` specifies the mapping of (bits of) `DataPrototypes` of the `NvBlockSwComponentType`'s `PPortPrototypes` resp. `RPortPrototypes` to (bits of) `DataPrototypes` inside the RAM Block.]()

This ensures a flexible but deterministic NVRAM Block memory structure given by the `ImplementationDataType` of the `ramBlock` and `romBlock` and its association to the `PortPrototypes` of the `NvBlockSwComponentType`.

[constr_2013] Compatibility of ImplementationDataTypes for NvBlockDataMapping [Unless both the attribute `bitfieldTextTableMaskNvBlockDescriptor` and attribute `bitfieldTextTableMaskPortPrototype` is defined in the context of a given `NvBlockDataMapping`, the `NvBlockDataMapping` is only valid if the `ImplementationDataType` of the referenced `VariableDataPrototype` or `ImplementationDataTypeElement` in the role `nvRamBlockElement` is

compatible to the `ImplementationDataType` used to type the `DataPrototype` aggregated by `NvBlockDataMapping` in the role `writtenNvData`, `writtenReadNvData`, or `readNvData`.`]()`

[constr_1285] Applicability of roles vs. PortPrototypes [The aggregation of `AutosarVariableRef` aggregated by `NvBlockDataMapping` in the roles `writtenNvData`, `writtenReadNvData`, or `readNvData` is subject to limitation depending on the applicable subclass of `PortPrototype`:

- The role `writtenNvData` shall only be used if the corresponding `PortPrototype` is a `RPortPrototype`
- The role `writtenReadNvData` shall only be used if the corresponding `PortPrototype` is a `PRPortPrototype`
- The role `readNvData` shall only be used if the corresponding `PortPrototype` is a `PPortPrototype`

`]()`

But nevertheless it is valid, that not all `ImplementationDataTypeElements` within the `VariableDataPrototype` aggregated by `NvBlockDescriptor` in the role `ramBlock` are mapped to a `VariableDataPrototype` located in a `PortPrototype`.

This enables to have fill elements or logistic data in the `NVRAM Block` which are not accessed by software components. This is exemplified by the element `x` in Figure 11.17.

Please note that the `VariableDataPrototype` located in the `PortPrototype`, in the vast majority of cases, will be typed by an `ApplicationDataType` which in turn (at least before the actual code generation starts) finally shall have a mapping to an `ImplementationDataType`. This aspect is explained in chapter 5.2.2.

[TPS_SWCT_01659] Mapping of VariableDataPrototype to a NvBlockDescriptor [There are three ways to map a `VariableDataPrototype` (i.e. `NvDataInterface.nvData` in the context of a specific `PortPrototype`) to either an `NvBlockDescriptor.ramBlock` or a *sub-element* thereof:

- `NvDataInterface.nvData` is directly and completely mapped, i.e. `AutosarVariableRef.autosarVariable` shall exist and `autosarVariable.targetDataPrototype` shall refer to the `NvDataInterface.nvData`.
- **Every leaf** element of `NvDataInterface.nvData` is mapped individually. This means that either
 - `AutosarVariableRef.autosarVariableInImplDatatype` shall exist and `autosarVariableInImplDatatype.targetDataPrototype` shall refer to the respective *leaf* element of `NvDataInterface.nvData`.

- `AutosarVariableRef.autosarVariable` shall exist and `autosarVariable.targetDataPrototype` shall refer to the respective *leaf* element of `NvDataInterface.nvData`.

In other words: the mapping shall be defined either via the used `ImplementationDataType` or else via the used `ApplicationDataType`.

- A *sub-element* of `NvDataInterface.nvData` - which is **not** a *leaf* element - may be directly mapped and consequently **all** the *leaf* elements of the respective *sub-element* of `NvDataInterface.nvData` are **indirectly mapped** as well. This means that

- `AutosarVariableRef.autosarVariableInImplDatatype` shall exist and `autosarVariableInImplDatatype.targetDataPrototype` shall refer to the *sub-element* element of `NvDataInterface.nvData`.
- `AutosarVariableRef.autosarVariable` shall exist and `autosarVariable.targetDataPrototype` shall refer to the *sub-element* element of `NvDataInterface.nvData`.

In other words: the mapping shall be defined either via the used `ImplementationDataType` or else via the used `ApplicationDataType`.

}]()

Please note that a mixing of **mutually exclusive** mappings for entire *sub-elements* or *leaf* elements as described by [TPS_SWCT_01659] is positively supported (see Figure 11.17).

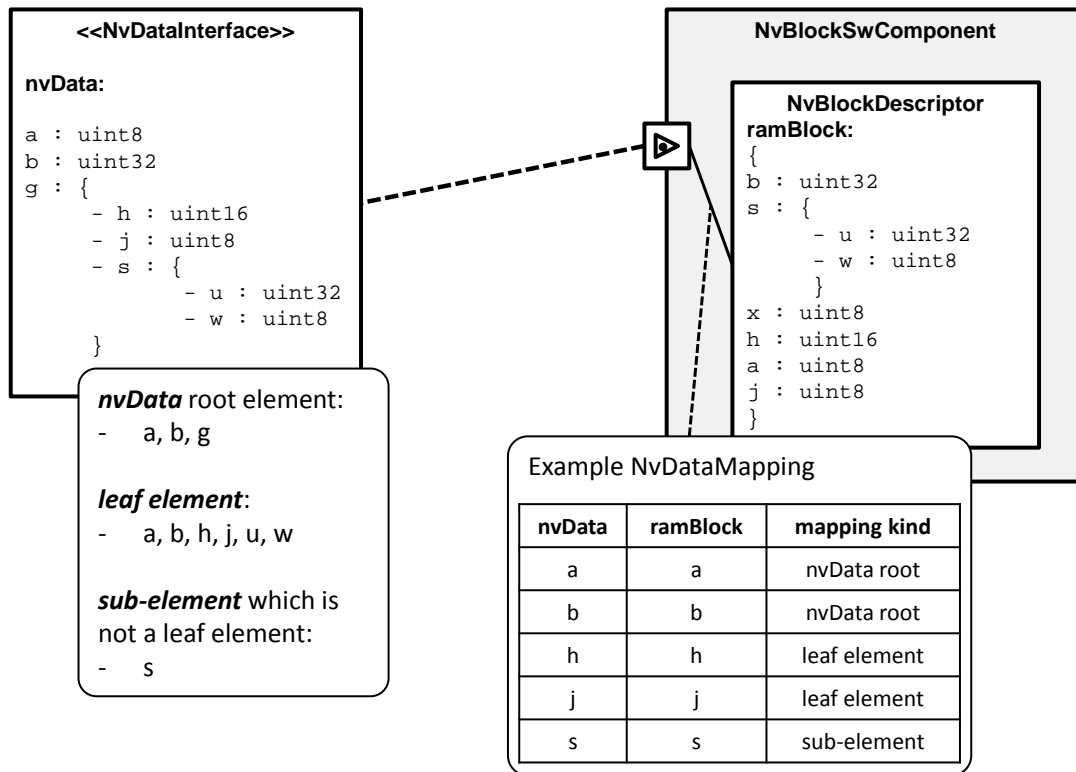

Figure 11.17: Example NvBlockDataMapping to explain the three ways to map a VariableDataPrototype to either an NvBlockDescriptor.ramBlock or a sub-element thereof

[constr_1395] NvBlockDataMapping shall be complete [If an NvBlockDataMapping refers to *sub-elements* or *leaf elements* of the NvDataInterface.nvData in the context of a particular PortPrototype then **all remaining sub-elements** or *leaf elements* shall effectively be mapped according to [TPS_SWCT_01659] by means of a collection of NvBlockDataMappings.]()

[constr_1403] NvBlockDataMappings to a given nvData shall be unambiguous [If an NvBlockDataMapping exists that **directly** and **completely** maps a specific NvDataInterface.nvData in the context of a particular PortPrototype then **no** other NvBlockDataMapping which maps sub-elements of the NvDataInterface.nvData shall exist.]()

The interaction with AUTOSAR services is centrally defined in the context of the Swc-ServiceDependency. The latter gathers a collection of PortPrototypes by means of RoleBasedPortAssignments that implement a closely related service functionality.

In the specific case of interaction between AtomicSwComponentType and NvBlock-SwComponentType (as described by [TPS_SWCT_02503]), there are PortPrototypes referenced by a RoleBasedPortAssignment with attribute RoleBasedPortAssignment.role set to NvDataPort. These PortPrototypes contain the collected Nv Data of the service use case.

Furthermore, there is the possibility to receive notifications when the writing of the mapped NV Block to the NvRam is finished.

In order to be able to properly assign such a notification to the content of the related *Nv Data PortPrototypes* in the scope of the same *SwcServiceDependency* it is necessary that the *Nv Data* of **all** these *PortPrototypes* is mapped to the **same** Nv Block (because the notifications are created **per block**).

This aspect represents one motivation for the existence of [constr_1404]:

[constr_1404] All NvDataInterface.nvData of PortPrototypes in the context of a specific SwcServiceDependency shall be mapped to the same NvBlock-Descriptor [In the context of a given *SwcServiceDependency* (which, in turn, is owned by an *AtomicSwComponentType*), **all** *NvDataInterface.nvData* of *PortPrototypes* referenced by a *RoleBasedPortAssignment* with attribute *RoleBasedPortAssignment.role* set to *NvDataPort* shall be connected (either directly or via the definition of suitable *PortInterfaceMappings*) to *NvDataInterface.nvData* (on the side of the *NvBlockSwComponentType*) that are **completely mapped** (via *NvBlockDataMappings*) to the identical *NvBlockDescriptor.ramBlock*.]

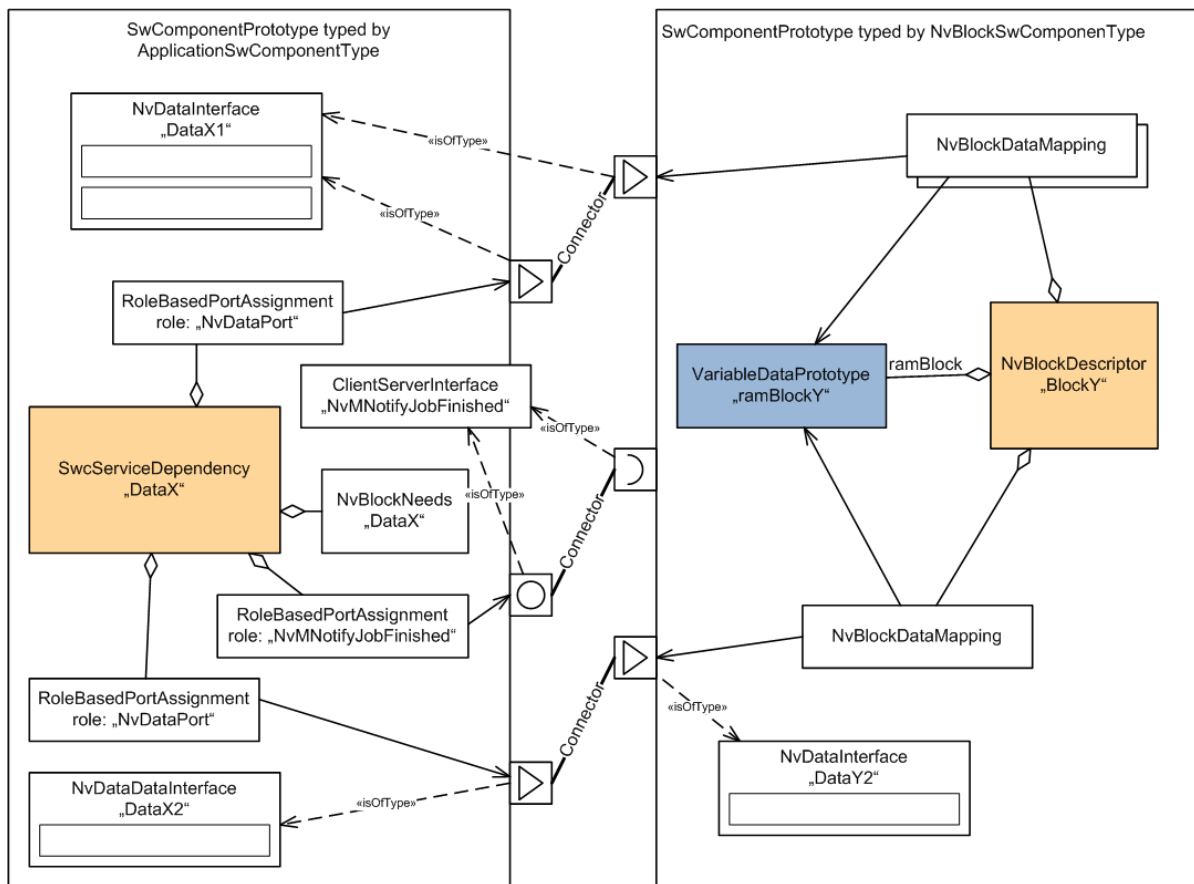

Figure 11.18: Visualization of the statement made by [constr_1404]

The statement made by [constr_1404] is visualized in Figure 11.18. The context-defining model elements, i.e. `SwcServiceDependency` owned by the `AtomicSwComponentType` as well as `NvBlockDescriptor` owned by the `NvBlockSwComponentType`, are colored in light orange.

The diagram is focused on the `NvBlockDescriptor.ramBlock`. As stressed by [constr_1404], all `Nv Data` provided by the `PortPrototypes` referenced by the specific `SwcServiceDependency` finally ends up in the one depicted `ramBlock` (colored in blue).

Please note that the graphical representation of the `NvBlockDataMapping` in Figure 11.18 has been simplified for the sake of clarity.

In summary, there is in fact a whole list of motivations that lead to the creation of [constr_1404]:

- The handling of the dirty-flag within the RTE is done in the context of a `PortPrototype`.
- The currently implemented approach allows for an easy understanding of the relation of data in the application to data in NV-RAM.
- All data in the context of one `SwcServiceDependency` have the identical storage life cycle.
- Jobs triggered in the NvM via operations in the `NvMService` (see [SWS_NvM_00734]) interface belong to exactly one `NvBlockDescriptor`.
- As already mentioned, notifications of the NvM towards software components (e.g. `NvMNotifyJobFinished` as described in [SWS_NvM_00735] or `NvMNotifyInitBlock`, see [SWS_NvM_00736]) belong to exactly one `NvBlockDescriptor`.

Class	NvBlockDataMapping			
Package	M2::AUTOSARTemplates::SWComponentTemplate::NvBlockComponent			
Note	<p>Defines the mapping between the <code>VariableDataPrototypes</code> in the <code>NvBlockComponents</code> ports and the <code>VariableDataPrototypes</code> of the RAM Block.</p> <p>The data types of the referenced <code>VariableDataPrototypes</code> in the ports and the referenced sub-element (inside a <code>CompositeDataType</code>) of the <code>VariableDataPrototype</code> representing the RAM Block shall be compatible.</p>			
Base	<code>ARObject</code>			
Attribute	Type	Mult.	Kind	Note
<code>bitfieldTextTableMaskNvBlockDescriptor</code>	<code>PositiveInteger</code>	0..1	attr	This attribute identifies the applicable bit mask on the side of the Nv Block.
<code>bitfieldTextTableMaskPortPrototype</code>	<code>PositiveInteger</code>	0..1	attr	This attribute identifies the applicable bit mask on the side of the <code>PortPrototype</code> .
<code>nvRamBlockElement</code>	AutosarVariableRef	1	aggr	Reference to a <code>VariableDataPrototype</code> of a RAM Block.





<i>Class</i>	NvBlockDataMapping			
readNvData	AutosarVariableRef	0..1	aggr	Reference to a VariableDataPrototype of a pPort of the NvBlockComponent providing read access to the RAM Block. If there is no PortPrototype providing read access (write-only) the reference can be omitted.
writtenNvData	AutosarVariableRef	0..1	aggr	Reference to a VariableDataPrototype of a rPort of the NvBlockComponent providing write access to the RAM Block. If there is no port providing write access (read-only) the reference can be omitted.
writtenReadNvData	AutosarVariableRef	0..1	aggr	Reference to a VariableDataPrototype of a PRPort Prototype of the NvBlockSwComponentType providing write and read access to the RAM Block.

Table 11.11: NvBlockDataMapping

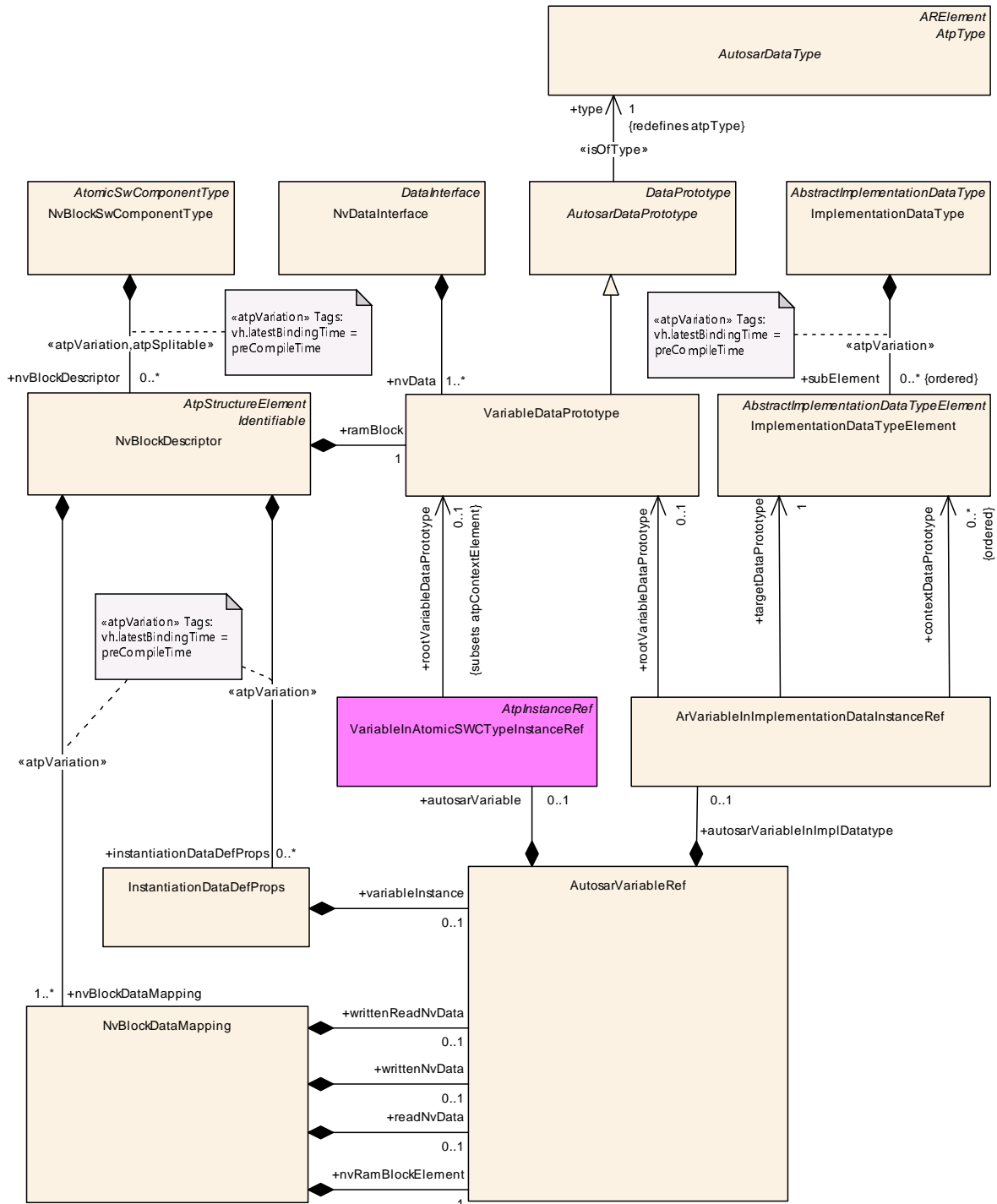

Figure 11.19: NvBlockDataMapping and InstantiationDataDefProps

Please note that are use cases for numerous fine-grained (e.g. single bits) data in non-volatile RAM. For this purpose, it would be very inefficient to copy the value of a whole [DataPrototype](#) that is at least 8 bits long into the non-volatile RAM.

A much better approach is to allow for the mapping of single bits or bit-fields inside a [DataPrototype](#) in a [PortPrototype](#) to the [ramBlock](#) of an [NvBlockDescriptor](#) directly.

For this purpose the `NvBlockDataMapping` provides the attributes `bitfieldTextTableMaskNvBlockDescriptor` and `bitfieldTextTableMaskPortPrototype`³

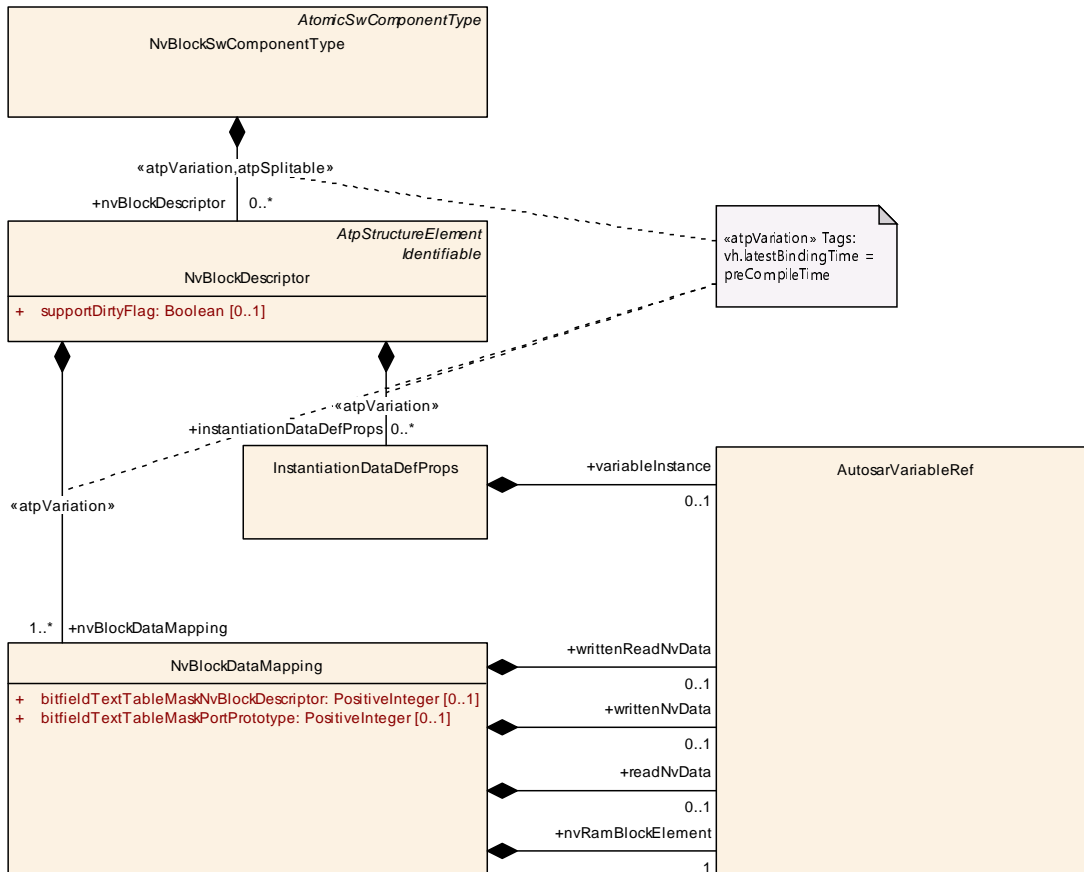

Figure 11.20: Attributes of `NvBlockDataMapping`

[TPS_SWCT_01799] Mapping of bitfields between `NvBlockDescriptor` and `PortPrototype` [It is possible to map a bitfield contained in the `DataPrototype` representing the `ramBlock` to a bitfield contained in a `DataPrototype` defined in the context of a `PortPrototype` on the surface of the enclosing `NvBlockSwComponentType` by means of the definition of attributes `NvBlockDataMapping.bitfieldTextTableMaskNvBlockDescriptor` and `NvBlockDataMapping.bitfieldTextTableMaskPortPrototype`.

In this case `[constr_2013]` is not applicable.]()

The general approach for mapping bitfields onto each other in the context of an `NvBlockSwComponentType` is sketched in Figure 11.21.

³The alternative to this approach would have been to shift this "distillation process" into the connection between e.g. an `ApplicationSwComponentType` and an `NvBlockSwComponentType`.

Such an approach comes with considerably heavier side effects and complexity (usage in `DelegationSwConnectors` or as part of a network connection) and is therefore not supported.

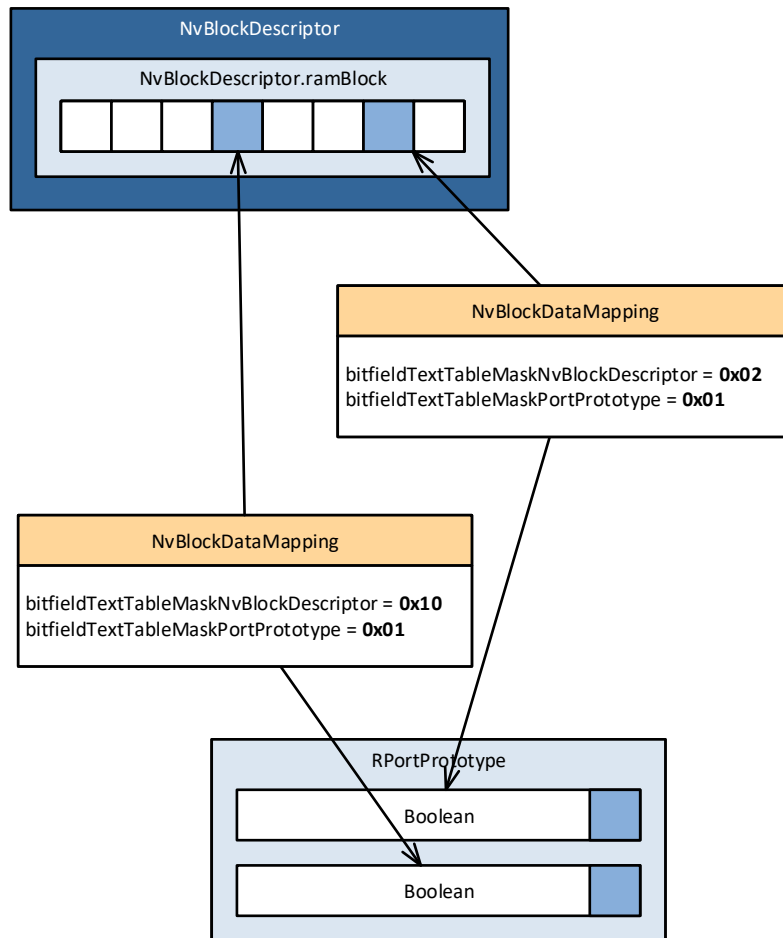

Figure 11.21: Visualization of the approach to map bitfields inside an `NvBlockSwComponentType`

11.5.5.5 Client Server Ports

[TPS_SWCT_01149] RoleBasedPortAssignment of NvBlockDescriptor [The `clientServerPort` of the `NvBlockDescriptor` describes which client/server `PortPrototype` of the `NvBlockSwComponentType` serves for which purpose. The `role` specifies if the port serves for block-related services, administrative services or notification.]()

[constr_2014] Limitation of RoleBasedPortAssignment.role in NvBlockDescriptors [The `role` has to be set to a valid name of the *Standardized AUTOSAR Interface* used for the *NVRAM Manager* e.g. `NvMNotifyJobFinished` or `NvMNotifyInitBlock`.]()

In case of notifications one common callback function is provided by the RTE for each individual kind of notification defined by the attribute `role`.

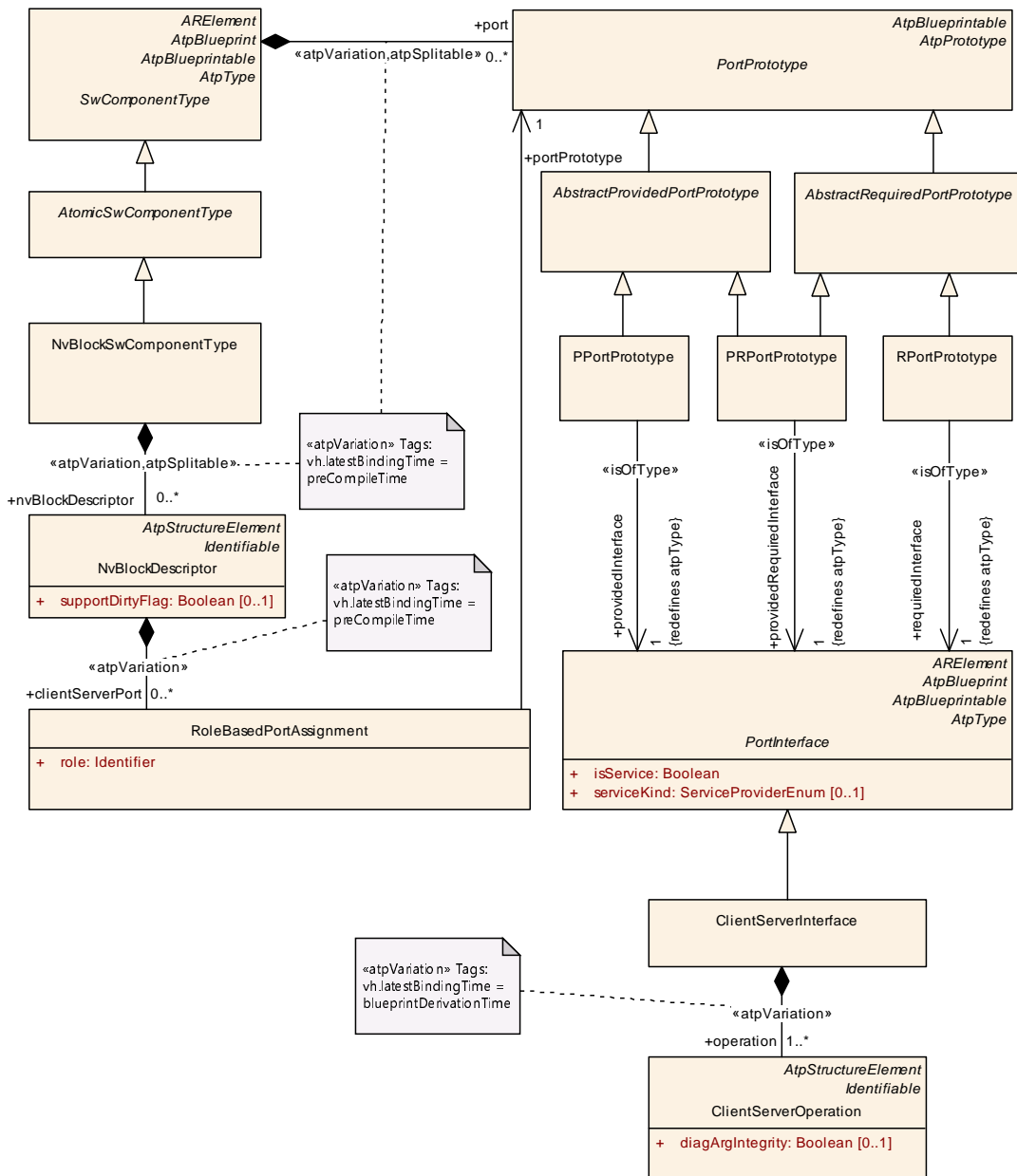

Figure 11.22: NvBlockNotification

The *PPortPrototypes* related to a given *NvBlockDescriptor* need to be provided with the same value for a *PortDefinedArgumentValue* in order to make the software work correctly. The provision of the *PortDefinedArgumentValue* is heuristic, but with a further “trick” the reliability of this operation can be much improved.

For all *NvBlockDescriptor.clientServerPort* of a given *NvBlockDescriptor* where attribute *role* is set to the value *NvMService* or *NvMAdmin* collect the *PortPrototype* if it is a *PPortPrototype*. The resulting collection of *PortPrototypes* need to be provided with the same value (of *PortDefinedArgumentValue*).

In this case it is no longer necessary to explicitly model the existence of *PortDefinedArgumentValues* for these *PortPrototypes* since the applicable id value of the NvM can be derived by RTE configuration.

To make this approach work the role value needs to be standardized, see [[constr_2014](#)].

11.5.6 BulkNvDataDescriptor

There is a strong use case where application software gets read-only access to data of significant size located in non-volatile memory. The actual data is created or updated e.g. at the end of the production line or maybe during maintenance in a garage.

If such a scenario were to be implemented using an [NvBlockDescriptor](#) then the creation of a RAM mirror of the data in the non-volatile memory would be obligatory. But as described before, the existence of **a RAM mirror would not be necessary at all** in this use case and would only waste a significant amount of precious resources.

It is therefore necessary to be clearly separate the use case for utilizing an [NvBlockDescriptor](#) from the direct read-only access to non-volatile memory in the meta-model.

For this purpose, model support is provided by the existence of meta-class [BulkNvDataDescriptor](#), aggregated at [NvBlockSwComponentType](#) in the role [bulkNvDataDescriptor](#). This modeling is depicted in [Figure 11.23](#).

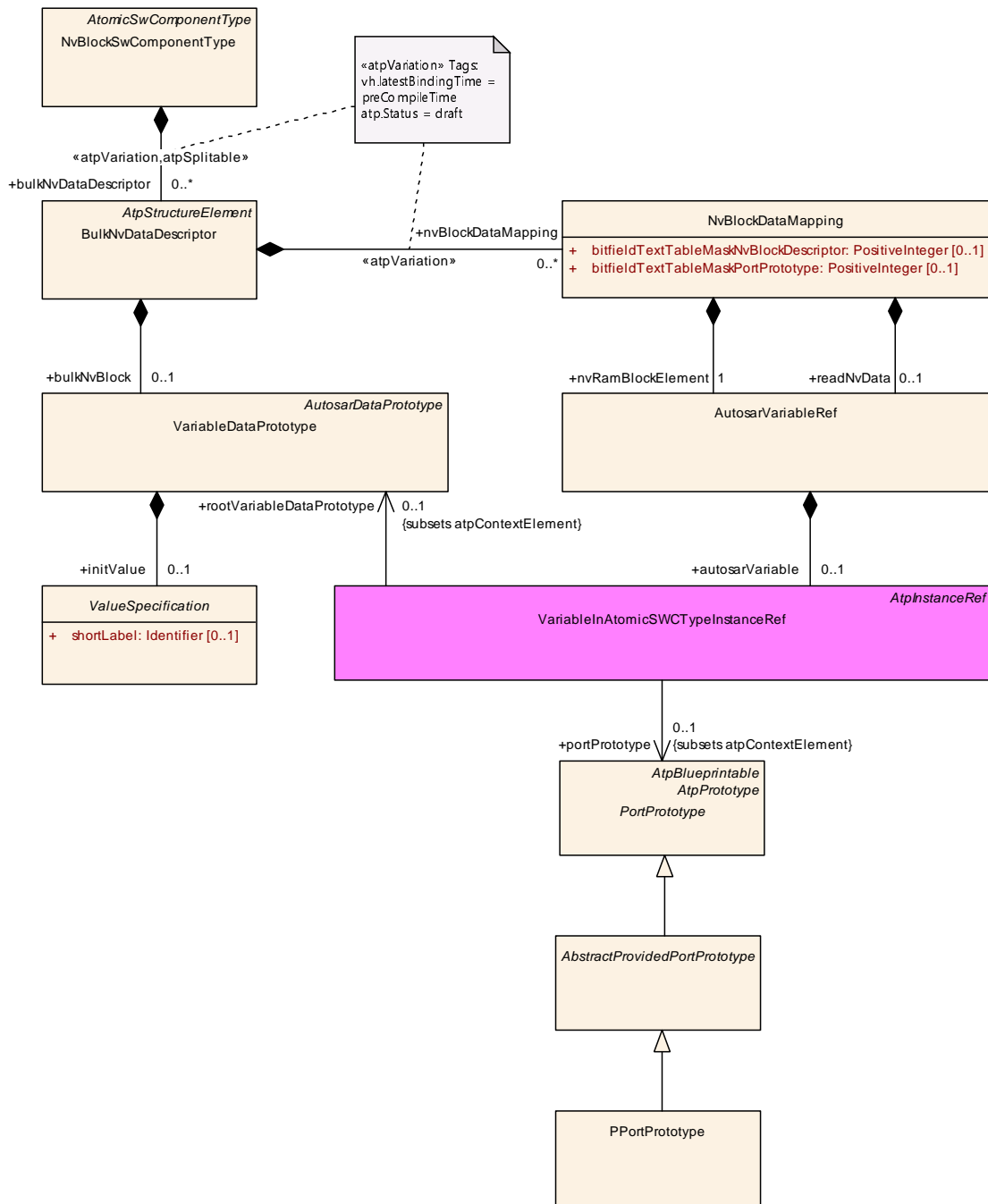

Figure 11.23: NvBlockSwComponentType and BulkNvDataDescriptor

[TPS_SWCT_01805]{DRAFT} **Semantics of the aggregation NvBlockSwComponentType.bulkNvDataDescriptor** [The existence of an aggregation at meta-class NvBlockSwComponentType in the role bulkNvDataDescriptor indicates that read-only access to a block of data in non-volatile memory shall be provided.

Access to this block of data is **provided directly from non-volatile memory** as opposed to via a RAM mirror.]()

[TPS_SWCT_01806]{DRAFT} **Simultaneous aggregation of `NvBlockSwComponentType.bulkNvDataDescriptor` and `NvBlockSwComponentType.nvBlockDescriptor`** [The simultaneous existence of aggregations in the roles `bulkNvDataDescriptor` and `nvBlockDescriptor` in the context of the same `NvBlockSwComponentType` is positively supported.]()

[TPS_SWCT_01807]{DRAFT} **Application of `NvBlockDataMapping` on `BulkNvDataDescriptor`** [Via the aggregation of `NvBlockDataMapping` in the role `nvBlockDataMapping` it is possible to make the content of the `BulkNvDataDescriptor` available to a `PPortPrototype` on the surface of the enclosing `NvBlockSwComponentType`.

It is also supported to make only a subset of the content of the `BulkNvDataDescriptor` available at the `PPortPrototype`.]()

[constr_1735]{DRAFT} **Limitation of the aggregation of `AutosarVariableRef` in the context of an `NvBlockDataMapping` owned by a `BulkNvDataDescriptor`** [Any `NvBlockDataMapping` owned by a `BulkNvDataDescriptor` shall only aggregate an `AutosarVariableRef` in the role `readNvData` and `nvRamBlockElement` (that in turn refers to the `BulkNvDataDescriptor.bulkNvBlock`).]()

Of course, [constr_1285] also applies for the usage of `BulkNvDataDescriptor`.

Class	BulkNvDataDescriptor			
Package	M2::AUTOSARTemplates::SWComponentTemplate::NvBlockComponent			
Note	This meta-class represents one bulk NV Data Block that is read-only for the application software. The purpose of a bulk NV Data Block is to provide access to information uploaded to the vehicle at e.g. the end of the production line. Tags: atp.Status=draft			
Base	<i>ARObject, AtpClassifier, AtpFeature, AtpStructureElement, Identifiable, MultilanguageReferrable, Referrable</i>			
Attribute	Type	Mult.	Kind	Note
bulkNvBlock	VariableDataPrototype	0..1	aggr	This aggregation represents the actual bulk NVBlock. Tags: atp.Status=draft
nvBlockData Mapping	NvBlockDataMapping	*	aggr	Defines the mapping between the VariableData Prototypes in the NvBlockComponents ports and the VariableDataPrototypes of the non-volatile memoryk. The aggregation of NvBlockDataMapping is subject to variability with the purpose to support the conditional existence of nv data ports. Stereotypes: atpVariation Tags: atp.Status=draft vh.latestBindingTime=preCompileTime

Table 11.12: BulkNvDataDescriptor

11.5.7 SwcInternalBehavior of an NvBlockSwComponentType

[TPS_SWCT_01150] InternalBehavior of a NvBlockSwComponentType to enable access to the NVRAM Block management API [In general, the `InternalBehavior` of a `NvBlockSwComponentType` is only used for a limited scope.

The main use case is that the `NvBlockSwComponentType` defines `PPortPrototypes` typed by a `ClientServerInterface` to enable access to the NVRAM Block management API.

To enable the configuration of the server invocation in the RTE's ECU configuration, the `NvBlockSwComponentType` needs to provide the following model elements:

- `OperationInvokedEvents`
- server `RunnableEntity`
- `PortDefinedArgumentValues` to define the NVRAM Block ID which has to be passed to the NvM

In addition to the above list further model elements may qualify; the details are explained in [\[TPS_SWCT_01584\]](#).⁽¹⁾

[TPS_SWCT_01584] InternalBehavior of a NvBlockSwComponentType for implementing a writing strategy [For the use case that `NvBlockDescriptors` exists that aggregate `NvBlockNeeds` which, in turn, define particular NV data writing strategies (by defining any of the attributes `storeAtShutdown`, `storeImmediate`, `storeEmergency`, or `storeCyclic`) the `InternalBehavior` of a `NvBlockSwComponentType` needs to support further model elements.

Particularly, In addition to the model elements listed in [\[TPS_SWCT_01150\]](#), the following list of model elements can be used in the `InternalBehavior` of a `NvBlockSwComponentType` for implementing writing strategies:

- `TimingEvents` (which may include references to `ModeDeclarations` in the role `disabledMode`)
- `DataReceivedEvents` (which may include references to `ModeDeclarations` in the role `disabledMode`)
- `SwcModeSwitchEvents`
- `RunnableEntitys`

⁽¹⁾[\(RS_SWCT_03225\)](#)

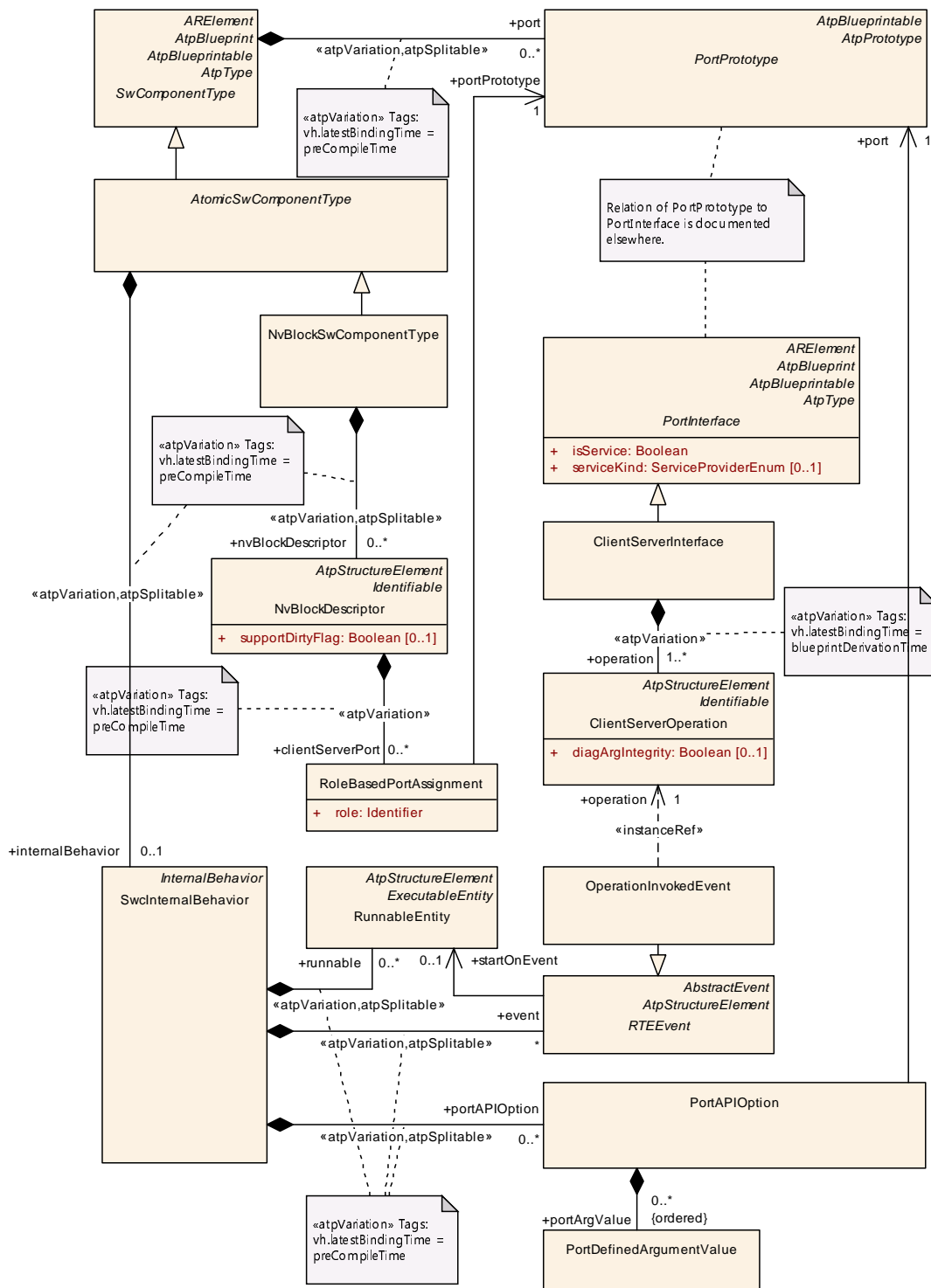

Figure 11.24: `NvBlockSwComponentType` and `SwcInternalBehavior`

[TPS_SWCT_01152] `InternalBehavior` does not have further attributes [It is not expected, that such `InternalBehavior` do have further attributes like `ExclusiveAreas`, per-instance memory or inter-runnable variables, etc.]()

[TPS_SWCT_01151] `RunnableEntity`s do not have further attributes [The same condition exists for the `RunnableEntity`s of such `InternalBehavior` which shall

not define further attributes, e.g. data access points (implemented by means of references from `SwcInternalBehavior` to `VariableAccess`) or `ServerCallPoints`.)()

[constr_1234] Value of `RunnableEntity.symbol` [The value of a `RunnableEntity.symbol` owned by an `NvBlockSwComponentType` that is triggered by an `OperationInvokedEvent` shall only be taken from the set of API names associated with the NvM.]()

For example, `RunnableEntity.symbol` owned by an `NvBlockSwComponentType` could rightfully be set to `NvM_ReadBlock` [33] but an arbitrary value like `ReadThisBlock` is not permitted.

The rationale for [constr_1234] is that the `RunnableEntities` that are triggered by an `OperationInvokedEvent` are not existing as such but are mapped to the respective function calls of the NvM. For more details of how this mapping can be achieved please refer to [6].

Please note that no restriction applies for the value of attribute `RunnableEntity.symbol` of any `RunnableEntity` owned by an `NvBlockSwComponentType` that is triggered by an `RTEEvent` other than `OperationInvokedEvent`.

[constr_2015] Limitation of `SwcInternalBehavior` of a `NvBlockSwComponentType` [The `SwcInternalBehavior` of a `NvBlockSwComponentType` is only permitted to define

- `OperationInvokedEvents`
- `RunnableEntities` triggered by `OperationInvokedEvents` (server `RunnableEntities`)
- `RunnableEntities` which defines only the mandatory attributes `symbol` and `canBeInvokedConcurrently`
- `PortAPIOptions` defining `PortDefinedArgumentValues`
- `TimingEvents` (which may include references to `ModeDeclarations` in the role `disabledMode`)
- `DataReceivedEvents` (which may include references to `ModeDeclarations` in the role `disabledMode`)
- `SwcModeSwitchEvents`
- `RunnableEntities` triggered by `TimingEvents`
- `RunnableEntities` triggered by `DataReceivedEvents`
- `RunnableEntities` triggered by `SwcModeSwitchEvents`
- `DataTypeMappingSet`

]()

[constr_1309] Existence of `NvBlockDescriptor.timingEvent` [The attribute `NvBlockDescriptor.timingEvent` shall exist if and only if the `NvBlockDescriptor.nvBlockNeeds.storeCyclic` exists and is set to the value `true`.]()

Note that there is a conceptual connection between the values of the two attributes `NvBlockDescriptor.timingEvent.period` and `SwcServiceDependency.serviceNeeds.cyclicWritingPeriod`.

Specifically, the `SwcServiceDependency.serviceNeeds.cyclicWritingPeriod` represents a requirement and the `NvBlockDescriptor.timingEvent.period` is supposed to fulfill the requirement.

[TPS_SWCT_01585] Relevance of `NvBlockDescriptor.timingEvent.period` [For any given `NvBlockDescriptor`, the value of the attribute `NvBlockDescriptor.nvBlockNeeds.cyclicWritingPeriod` shall be ignored and the value of `NvBlockDescriptor.timingEvent.period` shall be taken to specify the effective writing frequency for cyclic storage.](*RS_SWCT_03225*)

[TPS_SWCT_01662] Applicability of `DataTypeMappingSets` inside an `NvBlock-SwComponentType` [The `DataTypeMappingSets` to be applied for a given `NvBlockDescriptor` is the superset of `NvBlockDescriptor.dataTypeMapping` and `InternalBehavior.dataTypeMapping`.](*RS_SWCT_03225*)

12 Software Component Documentation

AUTOSAR supports documentation of software component types by adopting the principles of ASAM-FSX [34] Standard to AUTOSAR.

With AUTOSAR Release 4.0, the AUTOSAR XML schema provides support for integrated and well-structured documentation.

More details about the AUTOSAR Documentation Support Concept can be found in the AUTOSAR Generic Structure Template [11].

[TPS_SWCT_01062] Documentation of software-components [The documentation of a `SwComponentType` is composed of several `Chapters`.

Some `Chapters` are predefined, describing the component from the perspective of different activities performed on the component, like:

- testing it (`swTestDesc`)
- maintaining it (`swMaintenanceNotes`)
- calibrating it (`swCalibrationNotes`)
- performing diagnostic (`swDiagnosticsNotes`)

](`RS_SWCT_02110`, `RS_SWCT_03230`)

The documentation of a `SwComponentType` is shown in figure 12.1.

Two other predefined `Chapters` describe the component (`swFeatureDesc`) and define its physical functionality (`swFeatureDef`).

In order to describe additional aspects of a software component, an arbitrary number of free `Chapters` can be defined.

The predefined `Chapters` typically provide informal guideline (e.g., recommendation) or documentation.

Formal information can be captured using special data groups [11] or annotating documentation construct with semantic information. This could be used to extend the predefined `Chapters` or in separate free `Chapters`.

Note that the documentation of a software component can be stored in a different file than the component itself (i.e., it is `<<atpSplitable>>` from the component).

Each of the predefined and free `Chapters` follows the `<<atpVariation>>` stereotype to support variant handling (see [11]) on the documentation at the `Chapter` level.

These `VariationPoints` set the latest binding time to the value `AdditionalBindingTimeEnum.postBuild` because the decision to include or exclude a `Chapter` as well as the decision which variant of this `Chapter` should be included can be made when the component has been built.

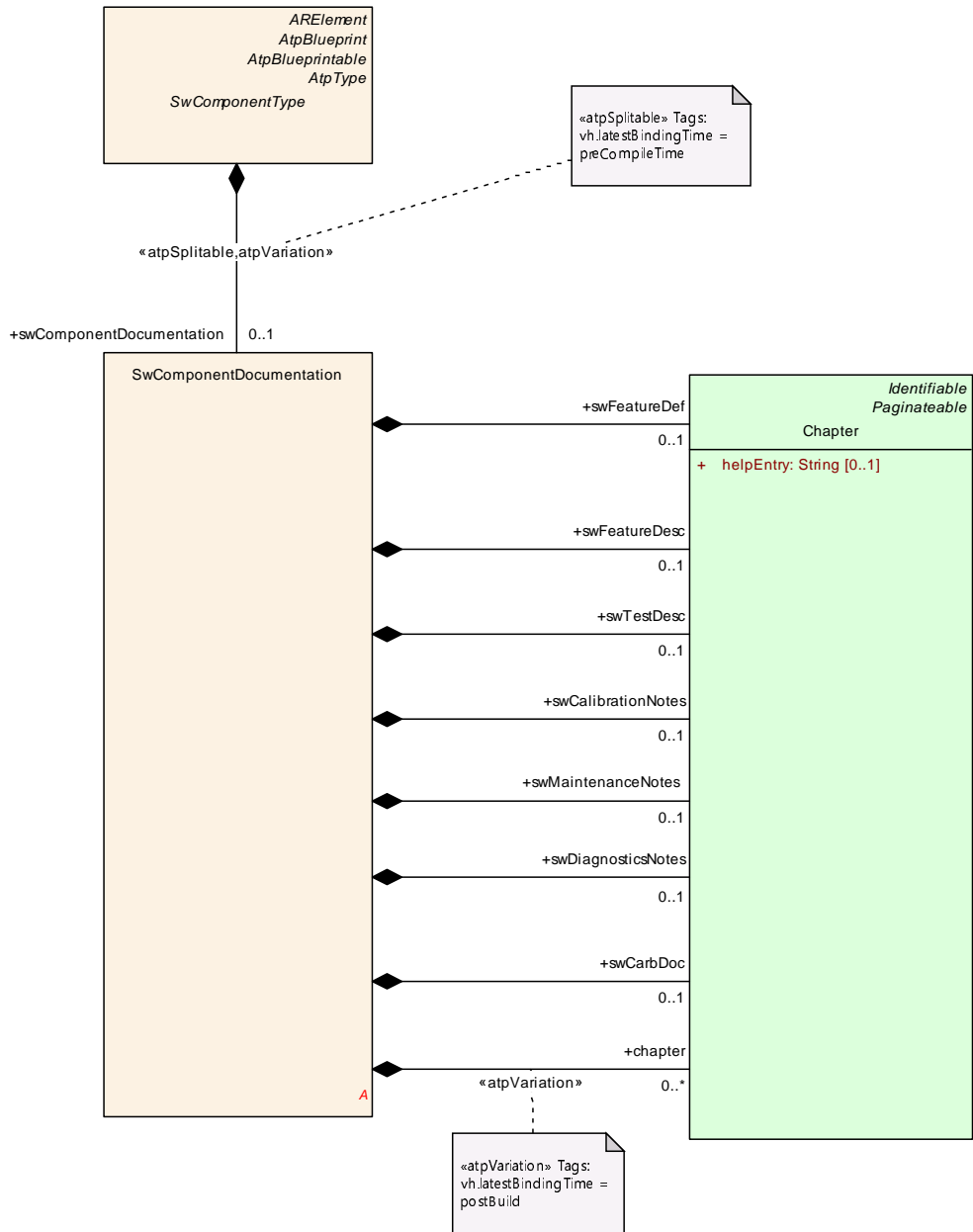

Figure 12.1: Software component documentation

Class	SwComponentDocumentation			
Package	M2::AUTOSARTemplates::SWComponentTemplate::SoftwareComponentDocumentation			
Note	This class specifies the ability to write dedicated documentation to a component type according to ASAM FSX.			
Base	ARObject			
Attribute	Type	Mult.	Kind	Note





Class	SwComponentDocumentation			
chapter	Chapter	*	aggr	<p>These chapters provide additional information about the software component that do not fit in the other chapters.</p> <p>Note that this is subject to variation because Chapter aggregations in the role chapter are variant within the documentation in general.</p> <p>Stereotypes: atpVariation Tags: vh.latestBindingTime=postBuild xml.roleElement=true xml.roleWrapperElement=false xml.sequenceOffset=100 xml.typeElement=false</p>
swCalibration Notes	Chapter	0..1	aggr	<p>This element contains calibration instructions and hints for a calibration engineer.</p> <p>Tags: xml.roleElement=true xml.sequenceOffset=60 xml.typeElement=false</p>
swCarbDoc	Chapter	0..1	aggr	<p>This element records the documentation requested by CARB.</p> <p>Tags: xml.roleElement=true xml.sequenceOffset=80 xml.typeElement=false</p>
swDiagnostics Notes	Chapter	0..1	aggr	<p>This element contains general information about diagnostics issues within the component.</p> <p>Tags: xml.roleElement=true xml.sequenceOffset=75 xml.typeElement=false</p>
swFeatureDef	Chapter	0..1	aggr	<p>This element contains the definition of the physical functionality of this software component. This definition is more or less formal and is intended to be delivered from modeling tools.</p> <p>Tags: xml.roleElement=true xml.sequenceOffset=20 xml.typeElement=false</p>
swFeatureDesc	Chapter	0..1	aggr	<p>This element contains the textual description of the software functionality of this software component. Expert should write this description.</p> <p>Tags: xml.roleElement=true xml.sequenceOffset=30 xml.typeElement=false</p>
swMaintenance Notes	Chapter	0..1	aggr	<p>This element contains information regarding the software maintenance of the component.</p> <p>Tags: xml.roleElement=true xml.sequenceOffset=70 xml.typeElement=false</p>





Class	SwComponentDocumentation			
swTestDesc	Chapter	0..1	aggr	<p>This element contains suggestions and hints for the test of the software functionality of this software component.</p> <p>Tags: xml.roleElement=true xml.sequenceOffset=50 xml.typeElement=false</p>

Table 12.1: SwComponentDocumentation

Class	Chapter			
Package	M2::MSR::Documentation::Chapters			
Note	This meta-class represents a chapter of a document. Chapters are the primary structuring element in documentation.			
Base	<i>ARObject</i> , <i>DocumentViewSelectable</i> , <i>Identifiable</i> , <i>MultilanguageReferrable</i> , <i>Paginateable</i> , <i>Referrable</i>			
Attribute	Type	Mult.	Kind	Note
chapterModel	ChapterModel	1	aggr	<p>This represents the overall contents of the chapter.</p> <p>Tags: xml.roleElement=false xml.roleWrapperElement=false xml.typeElement=false xml.typeWrapperElement=false</p>
helpEntry	String	0..1	attr	<p>This specifies an entry point in an online help system to be linked with the parent class. The syntax shall be defined by the applied help system respectively help system generator.</p> <p>Maybe it is a concatenated Identifier, but as of now we leave it as an arbitrary string.</p> <p>Tags:xml.attribute=true</p>

Table 12.2: Chapter

Enumeration	AdditionalBindingTimeEnum
Package	M2::AUTOSARTemplates::GenericStructure::VariantHandling
Note	This enumeration specifies the additional binding times applicable for vh.latestBindingTime of variation points.
Literal	Description
blueprintDerivationTime	<p>The point in time when an object is created from a blueprint.</p> <p>Tags:atp.EnumerationLiteralIndex=0</p>
postBuild	<p>After the executable has been built.</p> <p>Tags:atp.EnumerationLiteralIndex=1</p>

Table 12.3: AdditionalBindingTimeEnum

13 Service Dependencies and Service Use Cases

13.1 Overview

Meta-class `SwcServiceDependency` represents a powerful concept to describe the service-related capabilities of an `AtomicSwComponentType`.

It is still required to understand how to configure `SwcServiceDependency` and related meta-classes for specific service use cases.

This chapter contains a detailed description of the meta-classes related to `SwcServiceDependency` in the context of specific service use cases, as well as modeling hints for the configuration of the respective service use cases.

13.2 NvM Service Dependencies

The meta-class `NvBlockNeeds` is used to define requirements to configure the NVRAM Manager Service. In addition, it may define requirements how the RTE shall implement writing strategies of an `NvBlockSwComponentType`.

An `SwcInternalBehavior` may provide several `SwcServiceDependency`s that in turn aggregate an `NvBlockNeeds` element where each defines the requirements from one NVRAM Block (for more information on the AUTOSAR NVRAM Manager see [33]).

There are several use cases how a software-component can interact with the NVRAM Manager service. Each use case is discussed in a separate sub-chapter.

<i>Enumeration</i>	RamBlockStatusControlEnum
Package	M2::AUTOSARTemplates::SWComponentTemplate::NvBlockComponent
Note	This enumeration type defines options for how the management of the ramBlock status is controlled.
Literal	Description
api	The ramBlock status is controlled via service interface by usage of the SetRamBlockStatus operation. Tags: atp.EnumerationLiteralIndex=0
nvRamManager	The ramBlock status is controlled exclusively by the Nv Ram Manager. Tags: atp.EnumerationLiteralIndex=1

Table 13.1: RamBlockStatusControlEnum

13.2.1 Nvm Use Case: Permanent RAM Block

Scenario: a `AtomicSwComponentType` is using an NVRAM Block with a Permanent RAM Block implemented by a `PerInstanceMemory` section or a `VariableDataPrototype` in the role `arTypedPerInstanceMemory`. In either case, the required memory for the Permanent RAM Block is allocated by the RTE during ECU Configuration.

In this case the following rules apply:

[TPS_SWCT_02501] Setup for Nvm Use Case: Permanent RAM Block [

RoleBasedPortAssignment

For every used `ClientServerInterface` provided by the NvM it is necessary to create a `RoleBasedPortAssignment` and set the value of the attribute `role` of the `RoleBasedPortAssignment` to the name of the used standardized `ClientServerInterface`. The following `ClientServerInterfaces` shall (i.e. lower multiplicity > 0) or can (lower multiplicity = 0) be used in this context:

- `NvmService` [0 .. 1]
- `NvMNotifyJobFinished` [0 .. 1]
- `NvMNotifyInitBlock` [0 .. 1]
- `NvMAdmin` [0 .. 1]

RoleBasedDataAssignment

`RoleBasedDataAssignment` shall be created that refers to either the `PerInstanceMemory` in the role `usedPim` or to the `VariableDataPrototype` in the role `usedDataElement`. The value of the attribute `role` of the `RoleBasedDataAssignment` shall be set to `ramBlock`.

Optionally, it is possible to create an additional `RoleBasedDataAssignment` to a `ParameterDataPrototype` in the role `usedParameterElement`. The value of the `ParameterDataPrototype` is then taken as the initial or default value for the NVRAM Block. In this case the value of the attribute `role` of the `RoleBasedDataAssignment` shall be set to `defaultValue`.

Therefore, the following roles are applicable:

- `ramBlock` [1]
- `defaultValue` [0 .. 1]

RepresentedPortGroup

N/A

]([RS_SWCT_03225](#))

For more information please refer to [SWS_NvM_00734], [SWS_NvM_00735], [SWS_NvM_00736], and [SWS_NvM_00737].

The same mechanism (see description of scenario) applies also for an `NvBlock-SwComponentType`. For each NVRAM Block the NVRAM Manager can be configured (with the help of `SwcServiceDependency.assignedData`) to use the same Permanent RAM Block.

It is the responsibility of the NVRAM Manager to provide the content of the NVRAM Block in this Permanent RAM Block during startup or on explicit request and to write back the content to the storage medium during shut-down or on explicit request.

13.2.2 Nvm Use Case: Temporary RAM Block

Scenario: an `AtomicSwComponentType` is using some NVRAM Block with a Temporary RAM Block.

In this case the `AtomicSwComponentType` is responsible for allocating the allocation of sufficient memory. In other words, the `AtomicSwComponentType` shall provide a memory area that is available to the API call to the NVRAM Manager for storage of the NV data.

[TPS_SWCT_02502] Setup for Nvm Use Case: Temporary RAM Block [

RoleBasedPortAssignment

This is mandatory for the described scenario. For every used `ClientServerInterface` provided by the Nvm it is necessary to create a `RoleBasedPortAssignment` and set the value of the attribute `role` of the `RoleBasedPortAssignment` to the name of the used `ClientServerInterface`. The following `ClientServerInterfaces` shall (i.e. lower multiplicity > 0) or can (lower multiplicity = 0) be used in this context:

- `NvmService` [1]
- `NvMNotifyJobFinished` [0 .. 1]
- `NvMNotifyInitBlock` [0 .. 1]
- `NvMAdmin` [0 .. 1]

RoleBasedDataAssignment

The usage of a `RoleBasedDataAssignment` with attribute `role` set to `defaultValue` is optional and depends on whether an initial value is required.

- `defaultValue` [0..1]

RoleBasedDataTypeAssignment

By this means it is possible to define the data-type of a Temporary RAM Block. The data type information can be used to calculate the NVRAM Block size. [constr_1301] applies.

- `temporaryRamBlock` [0..1]

RepresentedPortGroup

N/A

|(RS_SWCT_03225)

[constr_1301] Existence of RoleBasedDataTypeAssignment.role vs. RoleBasedDataAssignment.role [The usage of a `RoleBasedDataTypeAssignment` with attribute `role` set to the value `temporaryRamBlock` is only allowed if no `RoleBasedDataAssignment` defined with attribute `role` set to value `defaultValue` exists in the owning `SwcServiceDependency`.]()

The rationale for [constr_1301] is that the existence of a `RoleBasedDataAssignment` would already provide sufficient information for the intended purpose. The parallel existence of a `RoleBasedDataTypeAssignment` is therefore fully redundant and could only lead to potential inconsistencies.

For more information please refer to [SWS_NvM_00734], [SWS_NvM_00735], [SWS_NvM_00736], and [SWS_NvM_00737].

13.2.3 Nvm Use Case: RAM Block with explicit synchronization using Mirror Interfaces

Scenario: an `AtomicSwComponentType` is using an `NVRAM Block` where the `RAM Block` uses explicit synchronization by means of mirror interfaces. In this case the `RAM Block` does not necessarily have to be formally described by means of a `PerInstanceMemory` or a `VariableDataPrototype` in the role `arTypedPerInstanceMemory`.

Consequently, the software-component itself is responsible for the allocation of memory. On the other hand, this can also mean that the software-component can use several `RAM Blocks` instead of just one `RAM Block`.

[TPS_SWCT_02504] Setup for Nvm Use Case: RAM Block with explicit synchronization using Mirror Interfaces [

RoleBasedPortAssignment

This is mandatory for the described scenario. For every used `ClientServerInterface` provided by the `Nvm` it is necessary to create a `RoleBasedPortAssignment` and set the value of the attribute `role` of the `RoleBasedPortAssignment` to the name of the used `ClientServerInterface`. The following `ClientServerInterfaces` shall (i.e. lower multiplicity > 0) or can (lower multiplicity = 0) be used in this context:

- `NvMService` [0..1]
- `NvMNotifyJobFinished` [0..1]
- `NvMNotifyInitBlock` [0..1]
- `NvMAdmin` [0..1]

- NvMMirror [1]

RoleBasedDataAssignment

In this scenario the existence of a `RoleBasedDataAssignment` is optional. The `RoleBasedDataAssignment` needs to reference a `ParameterDataPrototype` aggregated by the enclosing `SwcInternalBehavior` in the role `perInstanceParameter` or `sharedParameter`.

- defaultValue [0..1]

RoleBasedDataTypeAssignment

By this means it is possible to define the data-type of a temporary RAM Block and used internal data structure in case of explicit synchronization with NvMMirror interface respectively. The data type information can be used to calculate the NVRAM Block size and minimum Permanent RAM Block size. [\[constr_1301\]](#) applies.

- temporaryRamBlock [0..1]

RepresentedPortGroup

N/A

]([RS_SWCT_03225](#))

For more information please refer to [\[SWS_NvM_00734\]](#), [\[SWS_NvM_00735\]](#), [\[SWS_NvM_00736\]](#), [\[SWS_NvM_00737\]](#), and [\[SWS_NvM_00738\]](#).

13.2.4 NVM Use Case: Software-Components using Nv Data provided by NvBlockSwComponentType (not ServiceSwComponent of NvM)

Scenario: an `AtomicSwComponentType` is using an NVRAM Block managed by an `NvBlockSwComponentType` (see section 11.5.2, as opposed to an NVRAM Block provided by a `ServiceSwComponentType`). Constraints [\[constr_1148\]](#), [\[constr_1149\]](#), and [\[constr_2011\]](#) apply.

[TPS_SWCT_02503] Setup for NVM Use Case: Software-Components using Nv Data provided by NvBlockSwComponentType [

RoleBasedPortAssignment

This is mandatory for the described scenario. For every used `ClientServerInterface` provided by the NvM it is necessary to create a `RoleBasedPortAssignment` and set the value of the attribute `role` of the `RoleBasedPortAssignment` to the name of the used `ClientServerInterface`. The following `ClientServerInterfaces` shall (i.e. lower multiplicity > 0) or can (lower multiplicity = 0) be used in this context:

- NvMService [0..1]
- NvMNotifyJobFinished [0..1]

- NvMNotifyInitBlock [0..1]
- NvMAdmin [0..1]

For every `PortPrototype` of a software-component typed by an `NvDataInterface` defining a `SwcServiceDependency` it is necessary to create a `RoleBasedPortAssignment` and set the value of the attribute `role` of the attribute `assignedPort` to the value `NvDataPort`:

- NvDataPort [1..*]

RoleBasedDataAssignment

N/A

RepresentedPortGroup

N/A

For supporting this use case the value of attribute `SwcServiceDependency.category` shall be set to `NV_BLOCK_COMPONENT.`] ([RS_SWCT_03225](#))

For more information please refer to [SWS_NvM_00734], [SWS_NvM_00735], [SWS_NvM_00736], and [SWS_NvM_00737]. Note that `NvBlockNeeds` (described in Chapter 11.5.5) is not in the scope of this use case.

13.3 Watchdog Service Dependencies

The meta-class `SupervisedEntityNeeds` is used to define requirements to configure the Watchdog Service. For the terms related to the AUTOSAR Watchdog Manager see [35].

13.3.1 Watchdog Service use Case: Local Supervision

The service interaction with the *Watchdog Manager* consists of two aspects:

- supervised entity
- checkpoint

For each of the two aspects a separated `ServiceNeeds` is defined. However, the `SwcServiceDependencies` that own these `ServiceNeeds` are semantically bound and cannot be used independently of each other.

In other words, the usage of two kinds of `SwcServiceDependency` in concert creates a higher-level semantics. Of course, in order to express this higher-level semantics a reference between the `SwcServiceDependencies` has to be available.

However, since the `SwcServiceDependency` represents a generic concept the actual reference needs to be implemented on the level of specific subclass of `ServiceNeeds`, in this case the `SupervisedEntityNeeds` and the `SupervisedEntityCheckpointNeeds`.

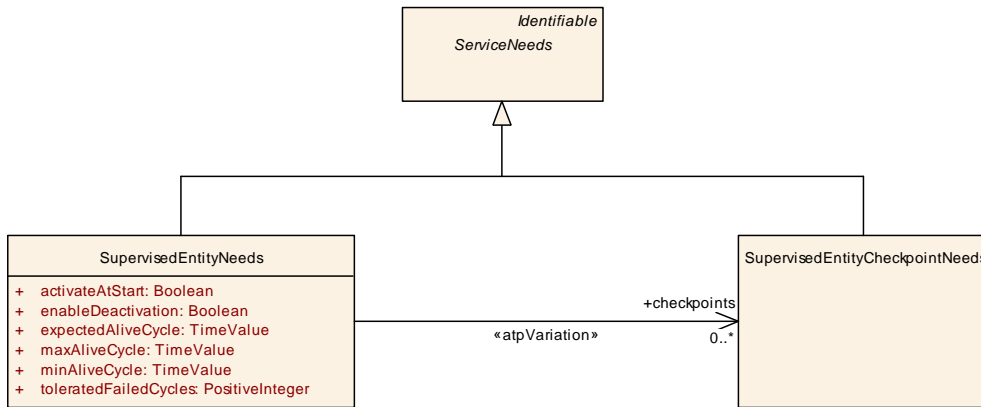

Figure 13.1: Modeling of `ServiceNeeds` for the watchdog

The former refers to the latter in order to express the relation of a supervised entity to its checkpoints.

Class	SupervisedEntityNeeds			
Package	M2::AUTOSARTemplates::CommonStructure::ServiceNeeds			
Note	Specifies the abstract needs on the configuration of the Watchdog Manager for one specific Supervised Entity.			
Base	<i>ARObject</i> , <i>Identifiable</i> , <i>MultilanguageReferrable</i> , <i>Referrable</i> , <i>ServiceNeeds</i>			
Attribute	Type	Mult.	Kind	Note
activateAtStart	Boolean	1	attr	True/false: supervision activation status of Supervised Entity shall be enabled/disabled at start.
checkpoints	SupervisedEntityCheckpointNeeds	*	ref	This reference indicates the checkpoints belonging to the Supervised Entity. Stereotypes: atpVariation Tags: vh.latestBindingTime=preCompileTime
enable Deactivation	Boolean	1	attr	True: software-component shall be allowed to deactivate supervision of this SupervisedEntity false: software-component shall be not allowed to deactivate supervision of this SupervisedEntity
expectedAlive Cycle	TimeValue	1	attr	Expected cycle time of alive trigger of this Supervised Entity (in seconds).
maxAliveCycle	TimeValue	1	attr	Maximum cycle time of alive trigger of this Supervised Entity (in seconds).
minAliveCycle	TimeValue	1	attr	Minimum cycle time of alive trigger of this Supervised Entity (in seconds).





Class	SupervisedEntityNeeds			
toleratedFailedCycles	PositiveInteger	1	attr	Number of consecutive failed alive cycles for this SupervisedEntity which shall be tolerated until the supervision status of the SupervisedEntity is set to WDG_M_ALIVE_EXPIRED (see SWS WdgM for more details). Note that this value has to be recalculated with respect to the WdgM's own cycle time for ECU configuration.

Table 13.2: SupervisedEntityNeeds

Class	SupervisedEntityCheckpointNeeds			
Package	M2::AUTOSARTemplates::CommonStructure::ServiceNeeds			
Note	Specifies the abstract needs on the configuration of the Watchdog Manager to support a Checkpoint for a Supervised Entity.			
Base	<i>ARObject</i> , <i>Identifiable</i> , <i>MultilanguageReferrable</i> , <i>Referrable</i> , <i>ServiceNeeds</i>			
Attribute	Type	Mult.	Kind	Note
–	–	–	–	–

Table 13.3: SupervisedEntityCheckpointNeeds

[TPS_SWCT_01704] Definition of supervised entity [

ServiceNeeds kind : [SupervisedEntityNeeds](#)

RoleBasedPortAssignment valid roles:

- `WdgM_LocalSupervisionStatus [1]`

RoleBasedDataAssignment

N/A

RepresentedPortGroups

N/A

]|()

Please note that an [SwcInternalBehavior](#) may provide several [SupervisedEntityNeeds](#) elements where each defines the requirements in relation to one supervised entity.

Note that in this situation an [AtomicSwComponentType](#) contains several *Checkpoints* that refer to a *Supervised Entity*.

In this case it is required that the *Supervised Entity* indicates to the *Watchdog Manager* the existence this *Checkpoint* for configuration and at runtime that the *Supervised Entity* has reached the *Checkpoint*.

[TPS_SWCT_01705] Definition of Checkpoints [

ServiceNeeds kind : [SupervisedEntityCheckpointNeeds](#)

RoleBasedPortAssignment valid roles:

- WdgM_LocalSupervision [1]

RoleBasedDataAssignment

N/A

RepresentedPortGroups

N/A

]()

For more information please refer to [SWS_WdgM_00333], and [SWS_WdgM_00335].

13.3.2 Watchdog Service use Case: *Global Supervision Status* notification

Scenario: an [AtomicSwComponentType](#) requires to receive the *Global Supervision Status* that is combined from all individual *Supervised Entities*. In this case the following setup applies:

[TPS_SWCT_02019] Setup for [AtomicSwComponentType](#) which requires *Global Supervision Status* notification [

RoleBasedPortAssignment valid roles:

- WdgM_GlobalMode [1]

RoleBasedDataAssignment

N/A

RepresentedPortGroups

N/A

]()

For more information please refer to [SWS_WdgM_00336].

13.3.3 Watchdog Service use Case: Control global supervision or get global supervision status

Scenario: an [AtomicSwComponentType](#) either controls the global operation of the watchdog manager or gets information about the current operation status, requiring at least one of the following use cases:

- Set the current mode of Watchdog Manager
- Get the current mode of the Watchdog Manager
- Get the global supervision status of the Watchdog Manager
- Identifier of the supervised entity that first reached the expired state
- Instruct the Watchdog Manager to cause a watchdog reset

For instance, the software-component sets the current mode of the Watchdog Manager according to the operational state of the ECU or polls the global supervision status.

In this case the following setup applies:

[TPS_SWCT_01703] Setup for `AtomicSwComponentType` which sets or gets the Global Supervision Status [

ServiceNeeds kind `GlobalSupervisionNeeds`

RoleBasedPortAssignment valid roles:

- `WdgM_GlobalSupervision` [1]

RoleBasedDataAssignment

N/A

RepresentedPortGroups

N/A

]()

Class	GlobalSupervisionNeeds			
Package	M2::AUTOSARTemplates::CommonStructure::ServiceNeeds			
Note	Specifies the abstract needs on the configuration of the Watchdog Manager to get access on the Global Supervision control and status interface.			
Base	<i>ARObject</i> , <i>Identifiable</i> , <i>MultilanguageReferrable</i> , <i>Referrable</i> , <i>ServiceNeeds</i>			
Attribute	Type	Mult.	Kind	Note
–	–	–	–	–

Table 13.4: GlobalSupervisionNeeds

13.4 COM Manager Service Needs

The meta-class `ComMgrUserNeeds` is used to define requirements to configure the ComM Service. An `SwcInternalBehavior` may provide several `ComMgrUserNeeds` elements where each defines the requirements from one “user” of the ComM Service. Especially, it defines which `PortGroup` is associated with this “user”.

Class	ComMgrUserNeeds			
Package	M2::AUTOSARTemplates::CommonStructure::ServiceNeeds			
Note	Specifies the abstract needs on the configuration of the Communication Manager for one "user".			
Base	<i>ARObject</i> , <i>Identifiable</i> , <i>MultilanguageReferrable</i> , <i>Referrable</i> , <i>ServiceNeeds</i>			
Attribute	Type	Mult.	Kind	Note
–	–	–	–	–





Class	ComMgrUserNeeds			
maxComm Mode	MaxCommModeEnum	1	attr	Maximum communication mode requested by this ComM user.

Table 13.5: ComMgrUserNeeds

13.4.1 ComM Use Case: read current ComM Mode

Scenario: a [AtomicSwComponentType](#) reads the current ComM mode.

In this case the following rules apply:

[TPS_SWCT_01019] [AtomicSwComponentType](#) reads the current ComM mode [

RoleBasedPortAssignment valid roles:

- ComM_CurrentMode [1]

RoleBasedDataAssignment

N/A

RepresentedPortGroup

N/A

]([RS_SWCT_03200](#))

For more information please refer to [SWS_ComM_00847].

13.4.2 ComM Use Case: request ComM Mode

Scenario: a [AtomicSwComponentType](#) requests a ComM mode. It may also check later whether the requested ComM mode has become effective.

In this case the following rules apply:

[TPS_SWCT_01020] [AtomicSwComponentType](#) requests a ComM mode. It may also check later whether the requested ComM mode has become effective [

RoleBasedPortAssignment valid roles:

- ComM_CurrentMode [1]
- ComM_UserRequest [1]

RoleBasedDataAssignment

N/A

RepresentedPortGroup

Reference to the applicable [PortGroup](#) [0..1]

](RS_SWCT_03200)

For more information please refer to [SWS_ComM_00848].

13.4.3 ComM Use Case: Software-Component acts as a Mode Manager that influences the ECU State

Scenario: a `AtomicSwComponentType` acts as a mode manager that influences the ECU state.

In this case the following rules apply:

[TPS_SWCT_01021] `AtomicSwComponentType` acts as a mode manager that influences the ECU state [

RoleBasedPortAssignment valid roles:

- `ComM_CurrentMode` [0..1]
- `ComM_UserRequest` [0..1]
- `ComM_ECUModeLimitation` [1]

RoleBasedDataAssignment

N/A

RepresentedPortGroup

N/A

](RS_SWCT_03200)

For more information please refer to [SWS_ComM_00741].

13.5 ECU State Manager Service Needs

The meta-class `EcuStateMgrUserNeeds` is used to define the requirements to configure the ECU State Manager Service. An `SwcInternalBehavior` may provide several `EcuStateMgrUserNeeds` elements where each defines the requirements from one “user” of the EcuM Service (for the terms related to the AUTOSAR ECU State Manager see [36]).

Class	<code>EcuStateMgrUserNeeds</code>
Package	<code>M2::AUTOSARTemplates::CommonStructure::ServiceNeeds</code>
Note	Specifies the abstract needs on the configuration of the ECU State Manager for one “user”. This class currently contains no attributes. Its name can be regarded as a symbol identifying the user from the viewpoint of the component or module which owns this class.





Class	EcuStateMgrUserNeeds			
Base	<i>ARObject, Identifiable, MultilanguageReferrable, Referrable, ServiceNeeds</i>			
Attribute	Type	Mult.	Kind	Note
–	–	–	–	–

Table 13.6: EcuStateMgrUserNeeds

13.5.1 EcuM Use Case: select Shutdown Target

Scenario: a *AtomicSwComponentType* wants to select a shutdown target. This corresponds to the “select shutdown target” use case of the fix EcuM.

In this case the following rules apply:

[TPS_SWCT_01016] *AtomicSwComponentType* wants to select a shutdown target [

RoleBasedPortAssignment valid roles:

- *EcuM_ShutdownTarget* [1]

RoleBasedDataAssignment

N/A

RepresentedPortGroup

N/A

](*RS_SWCT_03200*)

13.5.2 EcuM Use Case: select Boot Target

Scenario: a *AtomicSwComponentType* wants to select a boot target.

In this case the following rules apply:

[TPS_SWCT_01017] *AtomicSwComponentType* wants to select a boot target [

RoleBasedPortAssignment valid roles:

- *EcuM_BootTarget* [1]

RoleBasedDataAssignment

N/A

RepresentedPortGroup

N/A

](*RS_SWCT_03200*)

13.5.3 EcuM Use Case: use Alarm Clock

Scenario: a `AtomicSwComponentType` wants to use an alarm clock.

In this case the following rules apply:

[TPS_SWCT_01018] `AtomicSwComponentType` wants to use an alarm clock [

RoleBasedPortAssignment valid roles:

- `EcuM_AlarmClock` [1]

RoleBasedDataAssignment

N/A

RepresentedPortGroup

N/A

]([RS_SWCT_03200](#))

13.6 BswM

All use cases for interaction of an application software-component with the `BswM` require the aggregation in the role `serviceNeeds` of `BswMgrNeeds`, a subclass of `ServiceNeeds`, at `SwcServiceDependency`.

Class	BswMgrNeeds			
Package	M2::AUTOSARTemplates::CommonStructure::ServiceNeeds			
Note	Specifies the abstract needs on the configuration of the Basic Software Manager for one "user".			
Base	<code>ARObject</code> , <code>Identifiable</code> , <code>MultilanguageReferrable</code> , <code>Referrable</code> , <code>ServiceNeeds</code>			
Attribute	Type	Mult.	Kind	Note
–	–	–	–	–

Table 13.7: BswMgrNeeds

13.6.1 Partial Networking

One specific use case for the existence of a `SwcServiceDependency` with respect to the interaction with the `BswM` is the support for partial networking, in particular the association of a `PortGroup` and the associated `PortPrototypes` that act as *VFC control ports* and *VFC status ports*. For more details please refer to section 4.8.

In this case the following rules apply:

[TPS_SWCT_01126] Access to partial networking via BswM [

RoleBasedPortAssignment valid roles:

- `control` [0 .. 1]

- status [0 .. 1]

RoleBasedDataAssignment

N/A

RepresentedPortGroup

Reference to the applicable `PortGroup` associated with the particular partial network.

]([RS_SWCT_03200](#), [RS_SWCT_03201](#))

The multiplicities of the `RoleBasedPortAssignments` for this case have been defined under the assumption that a given software-component may or may not have a *VFC control port*. Also, it may have a *VFC status port*. Technically, there could be several *VFC status ports* per software-component but most likely there is only one *VFC status port*.

13.6.2 Mode Manager

A software-component that acts as a mode manager exposes a `PPortPrototype` typed by a `ModeSwitchInterface`. By this means the mode manager communicates changes of the particular mode to the connected mode users.

On the side of the `BswM`, an `RPortPrototype` typed by an `ModeSwitchInterface` used to receive notifications of mode switches will have to be established (for more details, please refer to [SWS_BswM_00200]).

In this case the following rules apply:

[TPS_SWCT_01552] Software-component acts as a mode manager [

ServiceNeeds kind `BswMgrNeeds`

RoleBasedPortAssignment valid roles:

- `AppModeInterface` [1]

RoleBasedDataAssignment

N/A

RepresentedPortGroup

none

]([RS_SWCT_03110](#), [RS_SWCT_03200](#), [RS_SWCT_03203](#))

A slight variation of this use case exists if the Application Mode Manager serves mode users that consist of both the `BswM` and other `ApplicationSwComponentTypes`.

[TPS_SWCT_01572] Application Mode Manager interacts with both `BswM` and other `ApplicationSwComponentTypes` [If an Application Mode Manager interacts with both `BswM` and other `ApplicationSwComponentTypes` the following requirements on the modeling of this scenario shall be taken into account:

Mode Request For the configuration of mode requests two separate `AbstractRequiredPortPrototypes` shall exist:

- One `AbstractRequiredPortPrototype` shall be typed by a `SenderReceiverInterface` with attribute `isService` set to `true`. This `AbstractRequiredPortPrototype` shall be connected to the `SwComponentPrototype` typed by a `ServiceSwComponentType` representing the `BswM`.
- One `AbstractRequiredPortPrototype` shall be typed by a `SenderReceiverInterface` with attribute `isService` set to `false`. This `AbstractRequiredPortPrototype` shall be connected to `SwComponentPrototypes` typed by `ApplicationSwComponentTypes` that request model changes.

Mode Switch Notification An Application Mode Manager that sends mode switch notifications to both `BswM` and other `ApplicationSwComponentTypes` shall expose a single `AbstractProvidedPortPrototype` for sending the mode switch notification to both the `BswM` and `ApplicationSwComponentTypes`.

The value of the attribute `ModeSwitchInterface.isService` shall be set to `false`).

|(RS_SWCT_03200, RS_SWCT_03202)

Rationale for [TPS_SWCT_01572]: technically, the existence of two separate `AbstractProvidedPortPrototype` for sending the mode switch notification to both the `BswM` and `ApplicationSwComponentTypes` would end up in two separate mode machines in the RTE and it would be a tough challenge to keep both mode machines perfectly synchronized.

Therefore, the exception regarding the usage of the attribute `isService` is justified to mitigate this effect.

On the mode request side, however, the situation is entirely different because the mode requests need arbitration by the Application Mode Manager anyway. This is completely in the scope of the implementation of the Application Mode Manager and AUTOSAR has no stakes in further standardizing this aspect.

Therefore, there is no motivation for a further exception with respect to the value of `isService`.

[TPS_SWCT_01664] BswM acts as a mode requester towards an application mode manager [The `SwcServiceDependency` that covers this use case shall refer to an `RPortPrototype` for the reception of the mode request and optionally to a `PPortPrototype` for the sending of the mode switch notification.

ServiceNeeds kind `BswMgrNeeds`

RoleBasedPortAssignment valid roles:

- `AppModeInterface` [0..1]

RoleBasedDataAssignment valid roles:

- AppModeRequestInterface [1]

RepresentedPortGroup

none

|(RS_SWCT_03110, RS_SWCT_03200, RS_SWCT_03203)

[constr_1680] Existence of attribute [RoleBasedDataAssignment.usedDataElement.localVariable](#) for [RoleBasedDataAssignment.role = AppModeRequestInterface](#) [If the attribute [RoleBasedDataAssignment.role](#) is set to the value [AppModeRequestInterface](#) then the reference [RoleBasedDataAssignment.usedDataElement.localVariable](#) shall not exist.]()

For explanation of the existence of [constr_1680], it is not intended to provide access to local variables inside the [SwcInternalBehavior](#).

13.6.3 Mode User

A software-component that acts as a mode user exposes an [RPortPrototype](#) typed by a [ModeSwitchInterface](#). By this means the software-component can be notified by mode switches executed at the mode manager (in this case the [BswM](#)).

On the side of the [BswM](#), an [PPortPrototype](#) typed by an [ModeSwitchInterface](#) used to send out notifications of mode switches will have to be established (for more details, please refer to [SWS_BswM_00202]).

In this case the following rules apply:

[TPS_SWCT_01553] Software-component acts as a mode user [

ServiceNeeds kind [BswMgrNeeds](#)

RoleBasedPortAssignment valid roles:

- AppModeInterface [1]

RoleBasedDataAssignment

N/A

RepresentedPortGroup

none

|(RS_SWCT_03110, RS_SWCT_03200, RS_SWCT_03203)

13.6.4 Mode Requester

A software-component that acts as a mode requester exposes an `PPortPrototype` typed by a `SenderReceiverInterface`. By this means the software-component can send mode requests towards the mode manager (in this case the `BswM`).

On the side of the `BswM`, an `RPortPrototype` typed by an `SenderReceiverInterface` used to requests for mode switches will have to be established (for more details, please refer to [SWS_BswM_00201]).

In this case the following rules apply:

[TPS_SWCT_01554] Software-component acts as a mode requester [

ServiceNeeds kind `BswMgrNeeds`

RoleBasedPortAssignment

N/A

RoleBasedDataAssignment valid roles:

- `AppModeRequestInterface` [1]

RepresentedPortGroup

none

]([RS_SWCT_03110](#), [RS_SWCT_03200](#), [RS_SWCT_03202](#))

Please note that [[constr_1680](#)] applies for this service use case.

13.7 Crypto Service Dependencies

13.7.1 Overview

The meta-classes `CryptoServiceNeeds` and `CryptoServiceJobNeeds` are used to define requirements for the configuration of the `CryptoServiceManager` respectively the crypto stack.

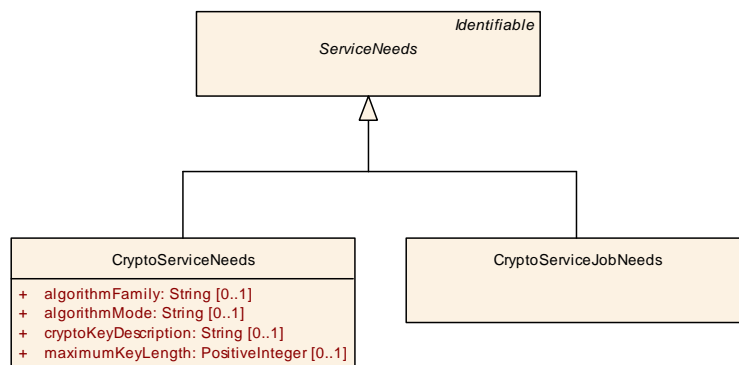

Figure 13.2: Modeling of subclasses of `ServiceNeeds` for cryptographic use cases

Please note that there are cryptographic APIs that build upon the creation of jobs that run asynchronously. The reason for this policy is that cryptographic operations - in many cases by design - tend to run for comparatively long time for each call. This behavior is visualized in Figure 13.3.

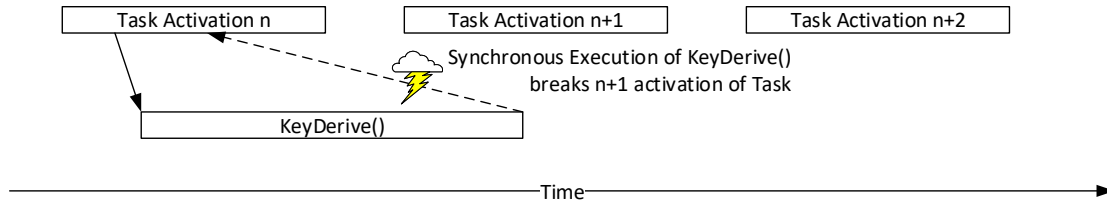

Figure 13.3: Cryptographic operation that requires a too-long execution time

Execution of these operations synchronously in the main function would block the respective module intolerably and therefore the job API is an important measure to keep the execution of software manageable. This behavior is visualized in Figure 13.4.

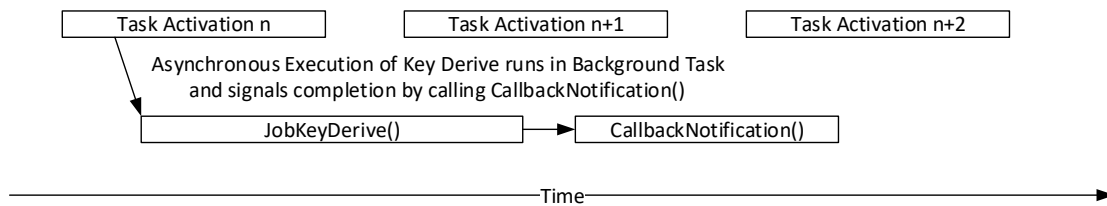

Figure 13.4: Execution of cryptographic operation using the job API

It is important to note that the asynchronous character of the execution is implemented on the server side and has nothing to do with asynchronous calling behavior on the client side (for more explanation about client-side calling behavior, please refer to section 7.5.2.1).

Class	CryptoServiceNeeds			
Package	M2::AUTOSARTemplates::CommonStructure::ServiceNeeds			
Note	Specifies the needs on the configuration of the CryptoServiceManager for one ConfigID (see Specification AUTOSAR_SWS_CSM.doc). An instance of this class is used to find out which ports of a software-component belong to this ConfigID.			
Base	ARObject, Identifiable, MultilanguageReferrable, Referrable, ServiceNeeds			
Attribute	Type	Mult.	Kind	Note
algorithmFamily	String	0..1	attr	This attribute represents a description of the family (e.g. AES) of crypto algorithm implemented by the crypto service use case.
algorithmMode	String	0..1	attr	This meta-class has the ability to represent a crypto service use case.





Class	CryptoServiceNeeds			
cryptoKey Description	String	0..1	attr	This attribute allows for a verbal description of the applicable cryptographic key. The goal is to pass a hint for the integrator about how to treat the corresponding service use case.
maximumKey Length	PositiveInteger	0..1	attr	The maximum length of a cryptographic key, that is used by the software-component or module for this configuration. Unit: bit.

Table 13.8: CryptoServiceNeeds

Class	CryptoServiceJobNeeds			
Package	M2::AUTOSARTemplates::CommonStructure::ServiceNeeds			
Note	This meta-class shall be taken to indicate that the service use case modeled with this kind of Service Needs assumes the usage of the crypto job API.			
Base	ARObject, Identifiable, MultilanguageReferrable, Referrable, ServiceNeeds			
Attribute	Type	Mult.	Kind	Note
–	–	–	–	–

Table 13.9: CryptoServiceJobNeeds

[TPS_SWCT_01727] Suffix used for the resulting name of the **PortInterface** for crypto **PortInterfaces** [The *_{Config}* or (where applicable) *_{Primitive}* suffix used for the resulting name of the **PortInterface** for the respective crypto service shall be taken from the *shortName* of the applicable *SwcServiceDependency*.]()

13.7.2 Crypto Service Use Cases

13.7.2.1 Crypto Service Use Case: Hash calculation

Scenario: a **AtomicSwComponentType** uses the hash calculation of the Crypto Service. In this case the following setup applies:

[TPS_SWCT_02020] **AtomicSwComponentType** uses the hash calculation of the **Crypto Service** [

ServiceNeeds kind : **CryptoServiceNeeds**

RoleBasedPortAssignment valid roles:

- **CsmHash** [0..1]
- **CsmHash_{Config}** [0..1]
- **CallbackNotification** [0..1]

RoleBasedDataAssignment

N/A

RepresentedPortGroups

N/A

]()

Please note that the resolution of the name fragment {Config} that appears in the `shortName` of the `ClientServerInterface CsmHash_{Config}` is regulated by [TPS_SWCT_01727].

13.7.2.2 Crypto Service Use Case: MAC calculation

Scenario: a `AtomicSwComponentType` uses the message authentication code (MAC) calculation of the Crypto Service. In this case the following setup applies:

[TPS_SWCT_02021] `AtomicSwComponentType` uses the message authentication code (MAC) calculation of the Crypto Service [

ServiceNeeds kind : `CryptoServiceNeeds`

RoleBasedPortAssignment valid roles:

- `CsmMacGenerate` [0..1]
- `CsmMacGenerate_{Config}` [0..1]
- `CallbackNotification` [0..1]

RoleBasedDataAssignment

N/A

RepresentedPortGroups

N/A

]()

Please note that the resolution of the name fragment {Config} that appears in the `shortName` of the `ClientServerInterface CsmMacGenerate_{Config}` is regulated by [TPS_SWCT_01727].

13.7.2.3 Crypto Service Use Case: MAC verification

Scenario: a `AtomicSwComponentType` uses the message authentication code (MAC) verification of the Crypto Service. In this case the following setup applies:

[TPS_SWCT_02022] `AtomicSwComponentType` uses the message authentication code (MAC) verification of the Crypto Service [

ServiceNeeds kind : `CryptoServiceNeeds`

RoleBasedPortAssignment valid roles:

- CsmMacVerify [0..1]
- CsmMacVerify_{Config} [0..1]
- CallbackNotification [0..1]

RoleBasedDataAssignment

N/A

RepresentedPortGroups

N/A

]()

Please note that the resolution of the name fragment {Config} that appears in the [shortName](#) of the [ClientServerInterface](#) CsmMacVerify_{Config} is regulated by [\[TPS_SWCT_01727\]](#).

13.7.2.4 Crypto Service Use Case: generation of random numbers

Scenario: a [AtomicSwComponentType](#) uses the generation of random numbers of the Crypto Service. In this case the following setup applies:

[TPS_SWCT_02024] [AtomicSwComponentType](#) uses the generation of random numbers of the Crypto Service [

ServiceNeeds kind : [CryptoServiceNeeds](#)

RoleBasedPortAssignment valid roles:

- CsmRandomGenerate [0..1]
- CsmRandomGenerate_{Config} [0..1]
- CallbackNotification [0..1]

RoleBasedDataAssignment

N/A

RepresentedPortGroups

N/A

]()

Please note that the resolution of the name fragment {Config} that appears in the [shortName](#) of the [ClientServerInterface](#) CsmRandomGenerate_{Config} is regulated by [\[TPS_SWCT_01727\]](#).

13.7.2.5 Crypto Service Use Case: Encryption with Authenticated Encryption with Associated Data (AEAD)

Scenario: a [AtomicSwComponentType](#) uses the Authenticated Encryption with Associated Data (AEAD) of the Crypto Service. In this case the following setup applies:

[TPS_SWCT_02025] [AtomicSwComponentType](#) uses the Authenticated Encryption with Associated Data (AEAD) of the Crypto Service [

ServiceNeeds kind : [CryptoServiceNeeds](#)

RoleBasedPortAssignment valid roles:

- [CsmAEADEncrypt](#) [0..1]
- [CsmAEADEncrypt_{Config}](#) [0..1]
- [CallbackNotification](#) [0..1]

RoleBasedDataAssignment

N/A

RepresentedPortGroups

N/A

]()

Please note that the resolution of the name fragment `{Config}` that appears in the [shortName](#) of the [ClientServerInterface](#) `CsmAEADEncrypt_{Config}` shall be resolved according to [\[TPS_SWCT_01727\]](#).

13.7.2.6 Crypto Service Use Case: Decryption with Authenticated Encryption with Associated Data (AEAD)

Scenario: a [AtomicSwComponentType](#) uses the Authenticated Encryption with Associated Data (AEAD) of the Crypto Service. In this case the following setup applies:

[TPS_SWCT_02026] [AtomicSwComponentType](#) uses the Authenticated Encryption with Associated Data (AEAD) of the Crypto Service [

ServiceNeeds kind : [CryptoServiceNeeds](#)

RoleBasedPortAssignment valid roles:

- [CsmAEADDecrypt](#) [0..1]
- [CsmAEADDecrypt_{Config}](#) [0..1]
- [CallbackNotification](#) [0..1]

RoleBasedDataAssignment

N/A

RepresentedPortGroups

N/A

]()

Please note that the resolution of the name fragment {Config} that appears in the `shortName` of the `ClientServerInterface CsmAEADDecrypt_{Config}` is regulated by [TPS_SWCT_01727].

13.7.2.7 Crypto Service Use Case: encryption

Scenario: a `AtomicSwComponentType` uses the encryption of the Crypto Service. In this case the following setup applies:

[TPS_SWCT_02027] `AtomicSwComponentType` uses the encryption of the Crypto Service [

ServiceNeeds kind : `CryptoServiceNeeds`

RoleBasedPortAssignment valid roles:

- `CsmEncrypt [0..1]`
- `CsmEncrypt_{Config} [0..1]`
- `CallbackNotification [0..1]`

RoleBasedDataAssignment

N/A

RepresentedPortGroups

N/A

]()

Please note that the resolution of the name fragment {Config} that appears in the `shortName` of the `ClientServerInterface CsmEncrypt_{Config}` is regulated by [TPS_SWCT_01727].

13.7.2.8 Crypto Service Use Case: decryption

Scenario: a `AtomicSwComponentType` uses the decryption of the Crypto Service. In this case the following setup applies:

[TPS_SWCT_02028] `AtomicSwComponentType` uses the decryption of the Crypto Service [

ServiceNeeds kind : `CryptoServiceNeeds`

RoleBasedPortAssignment valid roles:

- CsmDecrypt [0..1]
- CsmDecrypt_{Config} [0..1]
- CallbackNotification [0..1]

RoleBasedDataAssignment

N/A

RepresentedPortGroups

N/A

]()

Please note that the resolution of the name fragment {Config} that appears in the `shortName` of the `ClientServerInterface` `CsmDecrypt_{Config}` is regulated by [TPS_SWCT_01727].

13.7.2.9 Crypto Service Use Case: signature generation

Scenario: a `AtomicSwComponentType` uses the signature generation of the Crypto Service. In this case the following setup applies:

[TPS_SWCT_02031] `AtomicSwComponentType` uses the signature generation of the Crypto Service [

ServiceNeeds kind : `CryptoServiceNeeds`

RoleBasedPortAssignment valid roles:

- CsmSignatureGenerate [0..1]
- CsmSignatureGenerate_{Config} [0..1]
- CallbackNotification [0..1]

RoleBasedDataAssignment

N/A

RepresentedPortGroups

N/A

]()

Please note that the resolution of the name fragment {Config} that appears in the `shortName` of the `ClientServerInterface` `CsmSignatureGenerate_{Config}` is regulated by [TPS_SWCT_01727].

13.7.2.10 Crypto Service Use Case: signature verification

Scenario: a [AtomicSwComponentType](#) uses the signature verification of the Crypto Service. In this case the following setup applies:

[TPS_SWCT_02032] [AtomicSwComponentType](#) uses the signature verification of the Crypto Service [

ServiceNeeds kind : [CryptoServiceNeeds](#)

RoleBasedPortAssignment valid roles:

- [CsmSignatureVerify](#) [0..1]
- [CsmSignatureVerify_{Config}](#) [0..1]
- [CallbackNotification](#) [0..1]

RoleBasedDataAssignment

N/A

RepresentedPortGroups

N/A

]()

Please note that the resolution of the name fragment `{Config}` that appears in the [shortName](#) of the [ClientServerInterface](#) [CsmSignatureVerify_{Config}](#) is regulated by [\[TPS_SWCT_01727\]](#).

13.7.2.11 Crypto Service Use Case: usage of key management

Scenario: a [AtomicSwComponentType](#) uses the key management of the Crypto Service. In this case the following setup applies:

[TPS_SWCT_01726] [AtomicSwComponentType](#) uses the key management of the Crypto Service [

ServiceNeeds kind : [CryptoServiceNeeds](#)

RoleBasedPortAssignment valid roles:

- [CsmKeyManagement_{Config}](#) [1]
- [CallbackNotification](#) [0..1]

RoleBasedDataAssignment

N/A

RepresentedPortGroups

N/A

]()

Please note that the resolution of the name fragment {Config} that appears in the `shortName` of the `ClientServerInterface` `CsmKeyManagement_{Config}` is regulated by [TPS_SWCT_01727].

13.7.3 Crypto Service Job Use Cases

13.7.3.1 Crypto Service Use Case: usage of job API to set key valid

Scenario: a `AtomicSwComponentType` uses the **job API** of the Crypto Service to set a key valid. In this case the following setup applies:

[TPS_SWCT_01776] `AtomicSwComponentType` uses the API of the Crypto Service to set a key valid [

ServiceNeeds kind : `CryptoServiceJobNeeds`

RoleBasedPortAssignment valid roles:

- `CsmJobKeySetValid_{Primitive}` [1]
- `CallbackNotification` [1]

RoleBasedDataAssignment

N/A

RepresentedPortGroups

N/A

]()

Please note that the resolution of the name fragment {Primitive} that appears in the `shortName` of the `ClientServerInterface` `CsmJobKeySetValid_{Primitive}` is regulated by [TPS_SWCT_01727].

13.7.3.2 Crypto Service Use Case: usage of job API to create a random seed

Scenario: a `AtomicSwComponentType` uses the **job API** of the Crypto Service to create a random seed. In this case the following setup applies:

[TPS_SWCT_01777] `AtomicSwComponentType` uses the API of the Crypto Service to create a random seed [

ServiceNeeds kind : `CryptoServiceJobNeeds`

RoleBasedPortAssignment valid roles:

- `CsmJobRandomSeed_{Primitive}` [1]
- `CallbackNotification` [1]

RoleBasedDataAssignment

N/A

RepresentedPortGroups

N/A

]()

Please note that the resolution of the name fragment {Primitive} that appears in the `shortName` of the `ClientServerInterface` `CsmJobRandomSeed_{Primitive}` is regulated by [TPS_SWCT_01727].

13.7.3.3 Crypto Service Use Case: usage of job API to generate a key

Scenario: a `AtomicSwComponentType` uses the **job API** of the Crypto Service to generate a key. In this case the following setup applies:

[TPS_SWCT_01778] `AtomicSwComponentType` uses the API of the Crypto Service to generate a key [

ServiceNeeds kind : `CryptoServiceJobNeeds`

RoleBasedPortAssignment valid roles:

- `CsmJobKeyGenerate_{Primitive}` [1]
- `CallbackNotification` [1]

RoleBasedDataAssignment

N/A

RepresentedPortGroups

N/A

]()

Please note that the resolution of the name fragment {Primitive} that appears in the `shortName` of the `ClientServerInterface` `CsmJobKeyGenerate_{Primitive}` is regulated by [TPS_SWCT_01727].

13.7.3.4 Crypto Service Use Case: usage of job API to derive a key

Scenario: a `AtomicSwComponentType` uses the **job API** of the Crypto Service to derive a key. In this case the following setup applies:

[TPS_SWCT_01779] `AtomicSwComponentType` uses the API of the Crypto Service to derive a key [

ServiceNeeds kind : `CryptoServiceJobNeeds`

RoleBasedPortAssignment valid roles:

- CsmJobKeyDerive_{Primitive} [1]
- CallbackNotification [1]

RoleBasedDataAssignment

N/A

RepresentedPortGroups

N/A

]()

Please note that the resolution of the name fragment {Primitive} that appears in the `shortName` of the `ClientServerInterface` `CsmJobKeyDerive_{Primitive}` is regulated by [TPS_SWCT_01727].

13.7.3.5 Crypto Service Use Case: usage of job API to execute calculation of the public value for key exchange

Scenario: a `AtomicSwComponentType` uses the **job API** of the Crypto Service to execute calculation of the public value for key exchange. In this case the following setup applies:

[TPS_SWCT_01780] AtomicSwComponentType uses the API of the Crypto Service to execute calculation of the public value for key exchange [

ServiceNeeds kind : `CryptoServiceJobNeeds`

RoleBasedPortAssignment valid roles:

- CsmJobKeyExchangeCalcPubVal_{Primitive} [1]
- CallbackNotification [1]

RoleBasedDataAssignment

N/A

RepresentedPortGroups

N/A

]()

Please note that the resolution of the name fragment {Primitive} that appears in the `shortName` of the `ClientServerInterface` `CsmJobKeyExchangeCalcPubVal_{Primitive}` is regulated by [TPS_SWCT_01727].

13.7.3.6 Crypto Service Use Case: usage of job API to execute calculation of shared secret for key exchange

Scenario: a [AtomicSwComponentType](#) uses the **job API** of the Crypto Service to execute calculation of shared secret for key exchange. In this case the following setup applies:

[TPS_SWCT_01781] [AtomicSwComponentType](#) uses the API of the Crypto Service to execute calculation of shared secret for key exchange [

ServiceNeeds kind : [CryptoServiceJobNeeds](#)

RoleBasedPortAssignment valid roles:

- [CsmJobKeyExchangeCalcSecret_{Primitive}](#) [1]
- [CallbackNotification](#) [1]

RoleBasedDataAssignment

N/A

RepresentedPortGroups

N/A

]

Please note that the resolution of the name fragment `{Primitive}` that appears in the `shortName` of the [ClientServerInterface](#) `CsmJobKeyExchangeCalcSecret_{Primitive}` is regulated by [\[TPS_SWCT_01727\]](#).

13.7.3.7 Crypto Service Use Case: usage of job API to execute certificate parsing

Scenario: a [AtomicSwComponentType](#) uses the **job API** of the Crypto Service to execute certificate parsing. In this case the following setup applies:

[TPS_SWCT_01782] [AtomicSwComponentType](#) uses the API of the Crypto Service to execute certificate parsing [

ServiceNeeds kind : [CryptoServiceJobNeeds](#)

RoleBasedPortAssignment valid roles:

- [CsmJobCertificateParse_{Primitive}](#) [1]
- [CallbackNotification](#) [1]

RoleBasedDataAssignment

N/A

RepresentedPortGroups

N/A

|()

Please note that the resolution of the name fragment {Primitive} that appears in the `shortName` of the `ClientServerInterface CsmJobCertificateParse_{Primitive}` is regulated by [TPS_SWCT_01727].

13.7.3.8 Crypto Service Use Case: usage of job API to execute certificate verification

Scenario: a `AtomicSwComponentType` uses the **job API** of the Crypto Service to execute certificate verification. In this case the following setup applies:

[TPS_SWCT_01783] `AtomicSwComponentType` uses the API of the Crypto Service to execute certificate verification [

ServiceNeeds kind : `CryptoServiceJobNeeds`

RoleBasedPortAssignment valid roles:

- `CsmJobCertificateVerify_{Primitive}` [1]
- `CallbackNotification` [1]

RoleBasedDataAssignment

N/A

RepresentedPortGroups

N/A

|()

Please note that the resolution of the name fragment {Primitive} that appears in the `shortName` of the `ClientServerInterface CsmJobCertificateVerify_{Primitive}` is regulated by [TPS_SWCT_01727].

13.8 Diagnostic Service Dependency

This chapter describes the usage of the specific diagnostic meta-classes derived from `ServiceNeeds` within an atomic software-component. An overview of common diagnostic service needs has already been introduced in figure 7.37 and can be divided into four main parts:

- Function Inhibition Needs in chapter 13.8.2
- Diagnostic Event Needs in chapter 13.8.3
- Diagnostic Communication Needs in chapter 13.8.4
- Service Needs to fulfill the OBD related requirements in chapter 13.8.5

Please note that for the described use cases of the Diagnostic Services the following rule applies:

[TPS_SWCT_01129] Express diagnostic capabilities [For every used `ClientServerInterface` it is necessary to create a `RoleBasedPortAssignment`. Thereby the value of the attribute `role` of the `RoleBasedPortAssignment` has to be set to the name of the used standardized `ClientServerInterface`.

The possible role attribute values and the multiplicity of the related `PortPrototypes` are listed at the use case descriptions in the paragraph **RoleBasedPortAssignment.**] ([RS_SWCT_00170](#), [RS_SWCT_03190](#))

[constr_1640] No use of Optional Element Structure for interaction with the diagnostic stack [An `SwcServiceDependency` that aggregates a diagnostic-related subclass of `ServiceNeeds` shall not refer to any `PortPrototype` by means of either a `RoleBasedPortAssignment` or `RoleBasedDataAssignment` where the respective `PortInterface` contains any `DataPrototype` typed by an `Optional Element Structure`.]()

13.8.1 Development Approach

In combination with the definition of AUTOSAR diagnostic services, two different approaches for the development of an AUTOSAR software-component are possible (and can be found in actual development projects):

[TPS_SWCT_01697] Supported development approach for software-components that interact with AUTOSAR services [

Top-Down Approach A software-component is developed in a project alongside with a corresponding `Diagnostic Extract` [37].

In this case, it is more appropriate to formulate essential information that would otherwise be defined within the model of the application software, e.g. the `testId` by means of the `Diagnostic Extract`.

Bottom-Up Approach A software-component is developed as a *commercial-off-the-shelf* (COTS).

In other words, the software-component development is finished at the time the software-component is taken for being used in a specific ECU development project.

In this case, the developer can specify e.g. the applicable `testId` in the `ServiceNeeds` (because the corresponding `Diagnostic Extract` obviously does not yet exist at the time the software-component itself is developed).

] ([RS_SWCT_00170](#), [RS_SWCT_00190](#))

[TPS_SWCT_01698] Attributes that are subject to development approach [The following list of attributes has been defined as optional in order to support the approach described in [TPS_SWCT_01697]:

- `DiagnosticRoutineNeeds.diagRoutineType`
- `DiagnosticEnableConditionNeeds.initialStatus`
- `DiagnosticStorageConditionNeeds.initialStatus`
- `DtcStatusChangeNotificationNeeds.dtcFormatType`
- `DiagnosticOperationCycleNeeds.operationCycle`
- `DiagnosticOperationCycleNeeds.operationCycleAutomaticEnd`
- `DiagnosticOperationCycleNeeds.operationCycleAutostart`
- `ObdRatioServiceNeeds.connectionType`
- `ObdRatioServiceNeeds.iumpGroup`
- `ObdPidServiceNeeds.parameterId`
- `ObdPidServiceNeeds.standard`
- `ObdInfoServiceNeeds.infoType`
- `ObdMonitorServiceNeeds.onBoardMonitorId`
- `ObdMonitorServiceNeeds.testId`
- `ObdMonitorServiceNeeds.unitAndScalingId`
- `ObdMonitorServiceNeeds.applicationDataType`
- `ObdMonitorServiceNeeds.eventNeeds`
- `ObdMonitorServiceNeeds.updateKind`
- `ObdControlServiceNeeds.testId`

](*RS_SWCT_00170, RS_SWCT_00190*)

13.8.2 Function Inhibition Needs

The meta-class `FunctionInhibitionNeeds` is used to define requirements in order to configure the Diagnostic Event Manager Service.

An `SwcInternalBehavior` may provide `FunctionInhibitionNeeds` as well as `FunctionInhibitionAvailabilityNeeds` elements in the context of an `SwcServiceDependency`. Each `FunctionInhibitionNeeds` and `FunctionInhibitionAvailabilityNeeds` defines the requirements related to one function inhibition ID (for the terms related to the AUTOSAR Function Inhibition Manager, see [38]).

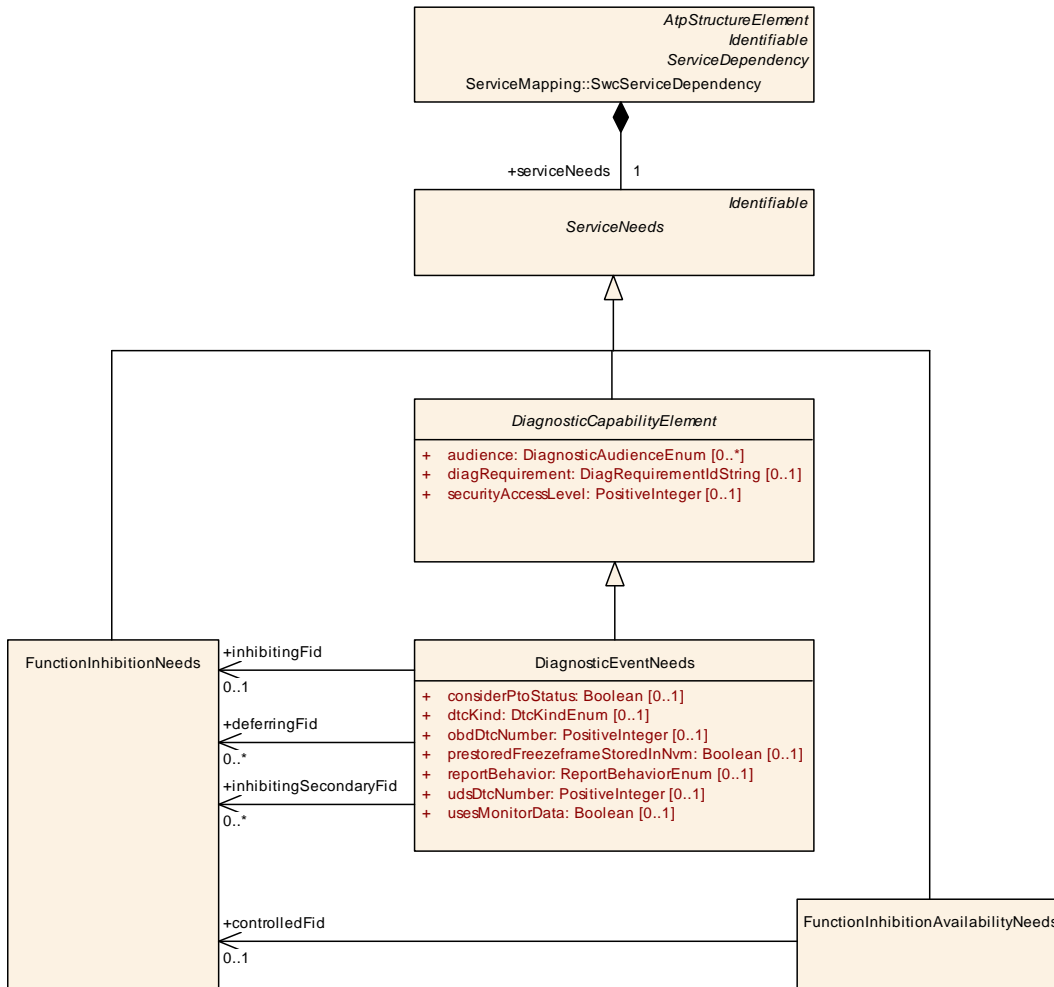

Figure 13.5: Modeling of FunctionInhibitionNeeds and FunctionInhibitionAvailabilityNeeds

Class	FunctionInhibitionNeeds			
Package	M2::AUTOSARTemplates::CommonStructure::ServiceNeeds			
Note	Specifies the abstract needs on the configuration of the Function Inhibition Manager for one Function Identifier (FID). This class currently contains no attributes. Its name can be regarded as a symbol identifying the FID from the viewpoint of the component or module which owns this class.			
Base	ARObject, Identifiable, MultilanguageReferrable, Referrable, ServiceNeeds			
Attribute	Type	Mult.	Kind	Note
–	–	–	–	–

Table 13.10: FunctionInhibitionNeeds

Class	FunctionInhibitionAvailabilityNeeds			
Package	M2::AUTOSARTemplates::CommonStructure::ServiceNeeds			
Note	Specifies the abstract needs on the configuration of the Function Inhibition Manager to provide the control function for one Function Identifier (FID).			
Base	<i>ARObject</i> , <i>Identifiable</i> , <i>MultilanguageReferrable</i> , <i>Referrable</i> , <i>ServiceNeeds</i>			
Attribute	Type	Mult.	Kind	Note
controlledFid	FunctionInhibitionNeeds	0..1	ref	This reference represents the controlled FID

Table 13.11: FunctionInhibitionAvailabilityNeeds

13.8.2.1 Function Inhibition Manager Service use Case: read function permission

[TPS_SWCT_02505] Setup for Function Inhibition Manager Service use Case: read function permission [Scenario: a [AtomicSwComponentType](#) read the function permission from FIM in order to enable or disable a functionality. In this case the following setup apply:

ServiceNeeds kind [FunctionInhibitionNeeds](#)

RoleBasedPortAssignment valid roles:

- `FunctionInhibition [1]`

RoleBasedDataAssignment

N/A

RepresentedPortGroups

N/A

]([RS_SWCT_00170](#), [RS_SWCT_03190](#))

For more information please refer to [SWS_Fim_00090].

13.8.2.2 Function Inhibition Manager Use Case: react on suppressed or unavailable events

[TPS_SWCT_01739] Function Inhibition Manager Use Case: react on suppressed or unavailable events [Scenario: an [AtomicSwComponentType](#) wants to react on suppressed or unavailable events and disable the permission to run for a FID. In this case, the following setup applies:

ServiceNeeds kind [FunctionInhibitionAvailabilityNeeds](#)

RoleBasedPortAssignment valid roles:

- `ControlFunctionAvailable [1]`

RoleBasedDataAssignment

N/A

RepresentedPortGroups

N/A

|(RS_SWCT_00170, RS_SWCT_03190)

Note: for variant coding `ClientServerInterface` `ControlFunctionAvailable` is used to deactivate a certain functionality (e.g. to set the FID to not available).

For more information, please refer to [SWS_Fim_00107].

13.8.3 Diagnostic Event Needs

The meta-classes `DiagnosticEventManagerNeeds` is used to define requirements in order to configure the Diagnostic Event Manager Service.

An `SwcInternalBehavior` may provide several `DiagnosticEventManagerNeeds` elements that define the mappings for the general diagnostic event manager behavior (for the terms related to the AUTOSAR Diagnostic Event Manager see [39]).

Class	DiagnosticEventManagerNeeds			
Package	M2::AUTOSARTemplates::CommonStructure::ServiceNeeds			
Note	Specifies the general needs on the configuration of the Diagnostic Event Manager (Dem) which are not related to a particular item.			
Base	<code>ARObject</code> , <code>DiagnosticCapabilityElement</code> , <code>Identifiable</code> , <code>MultilanguageReferrable</code> , <code>Referrable</code> , <code>ServiceNeeds</code>			
Attribute	Type	Mult.	Kind	Note
-	-	-	-	-

Table 13.12: DiagnosticEventManagerNeeds

The meta-class `DiagnosticCapabilityElement` is used to provide generic information about diagnostic capabilities. Further on, the usage of `DiagnosticCapabilityElement` indicates that all `ServiceNeeds` which inherit from `DiagnosticCapabilityElement` express the following intentions:

- Need to interact with AUTOSAR Service Dem or Dcm.
- Provide services for the on-board diagnostics.

Class	<i>DiagnosticCapabilityElement</i> (abstract)			
Package	M2::AUTOSARTemplates::CommonStructure::ServiceNeeds			
Note	This class identifies the capability to provide generic information about diagnostic capabilities			
Base	<i>ARObject</i> , <i>Identifiable</i> , <i>MultilanguageReferrable</i> , <i>Referrable</i> , <i>ServiceNeeds</i>			
Subclasses	DiagnosticCommunicationManagerNeeds , DiagnosticComponentNeeds , DiagnosticControlNeeds , DiagnosticEnableConditionNeeds , DiagnosticEventInfoNeeds , DiagnosticEventManagerNeeds , DiagnosticEventNeeds , DiagnosticIoControlNeeds , DiagnosticOperationCycleNeeds , DiagnosticRequestFileTransferNeeds , DiagnosticResponseOnEventNeeds , DiagnosticRoutineNeeds , DiagnosticStorageConditionNeeds , DiagnosticUploadDownloadNeeds , DiagnosticValueNeeds , DiagnosticsCommunicationSecurityNeeds , DtcStatusChangeNotificationNeeds , ObdControlServiceNeeds , ObdInfoServiceNeeds , ObdMonitorServiceNeeds , ObdPidServiceNeeds , ObdRatioDenominatorNeeds , ObdRatioServiceNeeds , WarningIndicatorRequestedBitNeeds			
Attribute	Type	Mult.	Kind	Note
audience	DiagnosticAudienceEnum	*	attr	This specifies the intended audience for the diagnostic object. Note that this is not only for the documentation but also subsequent audience specific implementation.
diag Requirement	DiagRequirementId String	0..1	attr	This denotes the requirement identifier to which the object can be linked to. Note that with the implementation of a generic tracing concept in AUTOSAR this attribute might become obsolete.
securityAccess Level	PositiveInteger	0..1	attr	This attribute denotes the level of security which is touched by the diagnostic object. The higher the level the more relevance for the security exists. This level shall be mapped to the security level in the ECU.

Table 13.13: DiagnosticCapabilityElement

Enumeration	DiagnosticAudienceEnum
Package	M2::AUTOSARTemplates::CommonStructure::ServiceNeeds
Note	The possible values of the intended audience for a diagnostic object.
Literal	Description
aftermarket	The object is for free aftermarket service organizations. Tags: atp.EnumerationLiteralIndex=1
afterSales	The object is relevant for the OEM after-sales organization. Tags: atp.EnumerationLiteralIndex=2
development	The object is relevant for engineering only. Tags: atp.EnumerationLiteralIndex=3
manufacturing	The object is relevant for manufacturing. Tags: atp.EnumerationLiteralIndex=4
supplier	The object is relevant for the ECU-supplier aftermarket organization. Tags: atp.EnumerationLiteralIndex=5

Table 13.14: DiagnosticAudienceEnum

The meta-classes [DiagnosticEventNeeds](#) is used to define requirements to configure the Diagnostic Event Manager Service. An [SwcInternalBehavior](#) may provide several [DiagnosticEventNeeds](#) elements where each defines all the requirements related to one diagnostic event (for the terms related to the AUTOSAR Diagnostic Event Manager see [39]).

In addition, `ObdPidServiceNeeds` and `ObdRatioServiceNeeds` are required in order to specify the needs for OBD diagnostic service calls.

[TPS_SWCT_01591] Existence of attribute `DiagnosticEventNeeds.reportBehavior` [The attribute `DiagnosticEventNeeds.reportBehavior` shall be ignored if it is specified in the context of a `SwcServiceDependency`.] (*RS_SWCT_00170*, *RS_SWCT_03190*)

The rationale for the existence of [TPS_SWCT_01591] is that a software-component can never report errors to the Dem **before** the Dem is fully initialized.

<i>Enumeration</i>	<i>DtcKindEnum</i>
Package	M2::AUTOSARTemplates::CommonStructure::ServiceNeeds
Note	This enumeration defines the possible kinds of diagnostic monitors regarding the OBD relevance.
Literal	Description
emissionRelatedDtc	This indicates that the monitor reports a OBD-relevant malfunction. Tags: atp.EnumerationLiteralIndex=0
nonEmissionRelatedDtc	This indicates that the monitor reports a non-OBD-relevant malfunction. Tags: atp.EnumerationLiteralIndex=1

Table 13.15: DtcKindEnum

The `diagEventDebounceAlgorithm` attribute defines the kind of expected debouncing by the Diagnostic Event Manager or defines that the debouncing is implemented by the software component.

The class `DiagEventDebounceAlgorithm` inherits from `Identifiable` in order to allow further documentation of the debouncing algorithm as well as non formalized description or non standardized description by the means of `Sdg` on expected configuration of the `DiagEventDebounceAlgorithm` in the Diagnostic Event Manager.

[constr_1138] `assignedPort` and `DiagEventDebounceMonitorInternal` [The existence of an `assignedPort` in combination with a `DiagEventDebounceAlgorithm` shall only be respected for the concrete subclass `DiagEventDebounceMonitorInternal`.] ()

[constr_1139] `assignedPort` of `DiagEventDebounceMonitorInternal` shall refer to an `RPortPrototype` [Concerning the debouncing, the software-component acts as a client and thus the `assignedPort` defined with respect to a `DiagEventDebounceMonitorInternal` may only refer to an `RPortPrototype`. The standardized value of the `role` identifier of the `assignedPort` shall be `DiagFaultDetectionCounterPort`.] ()

Class	DiagnosticEventNeeds			
Package	M2::AUTOSARTemplates::CommonStructure::ServiceNeeds			
Note	<p>Specifies the abstract needs on the configuration of the Diagnostic Event Manager for one diagnostic event. Its shortName can be regarded as a symbol identifying the diagnostic event from the viewpoint of the component or module which owns this element.</p> <p>In case the diagnostic event specifies a production error, the shortName shall be the name of the production error.</p>			
Base	ARObject, DiagnosticCapabilityElement , Identifiable , MultilanguageReferrable , Referrable , ServiceNeeds			
Attribute	Type	Mult.	Kind	Note
considerPtoStatus	Boolean	0..1	attr	PTO (Power Take Off) has an impact on the respective emission-related event (OBD). This information shall be provided by SW-C description in order to consider the PTO relevance e.g. for readiness (PID \$01) computation. For events with dtcKind set to 'nonEmmissionRelatedDtc' this attribute is typically false.
deferringFid	FunctionInhibitionNeeds	*	ref	This reference contains the link to a function identifier within the FiM which is used by the monitor before delivering a result.
diagEventDebounceAlgorithm	DiagEventDebounceAlgorithm	0..1	aggr	Specifies the abstract need on the Debounce Algorithm applied by the Diagnostic Event Manager.
dtcKind	DtcKindEnum	0..1	attr	This attribute indicates the kind of the diagnostic monitor according to the SWS Diagnostic Event Manger. This attribute applies for the UDS diagnostics use case.
inhibitingFid	FunctionInhibitionNeeds	0..1	ref	This represents the primary Function Inhibition Identifier used for inhibition of the diagnostic monitor. The FID might either inhibit the monitoring of a symptom or the reporting of detected faults.
inhibitingSecondaryFid	FunctionInhibitionNeeds	*	ref	This represents the secondary Function Inhibition Identifier used for inhibition of the diagnostic monitor. Any of the FID inhibitions leads to an inhibition of the monitoring of a symptom or the reporting of detected faults.
obdDtcNumber	PositiveInteger	0..1	attr	This represents a reasonable Diagnostic Trouble Code. This allows to predefine the Diagnostic Trouble Code, e.g. if the a function developer has received a particular requirement from the OEM or from a standardization body. This attribute applies for the OBD diagnostics use case.
prestoredFreezeFrameStoredInNvm	Boolean	0..1	attr	If the Event uses a prestored freeze-frame (using the operations PrestoreFreezeFrame and ClearPrestoredFreezeFrame of the service interface DiagnosticMonitor) this attribute indicates if the Event requires the data to be stored in non-volatile memory. TRUE = Dem shall store the prestored data in non-volatile memory, FALSE = Data can be lost at shutdown (not stored in Nvm).
reportBehavior	ReportBehaviorEnum	0..1	attr	This switch indicates whether or not the BSW module is allowed to report the related Events before Dem_Init().
udsDtcNumber	PositiveInteger	0..1	attr	This represents a reasonable Diagnostic Trouble Code. This allows to predefine the Diagnostic Trouble Code, e.g. if the a function developer has received a particular requirement from the OEM or from a standardization body. This attribute applies for the UDS diagnostics use case.





Class	DiagnosticEventNeeds			
usesMonitor Data	Boolean	0..1	attr	This attribute defines whether additional monitor data shall be added to the reporting of events.

Table 13.16: DiagnosticEventNeeds

Class	DiagEventDebounceAlgorithm (abstract)			
Package	M2::AUTOSARTemplates::CommonStructure::ServiceNeeds			
Note	<p>This class represents the ability to specify the pre-debounce algorithm which is selected and/or required by the particular monitor.</p> <p>This class inherits from Identifiable in order to allow further documentation of the expected or implemented debouncing and to use the category for the identification of the expected / implemented debouncing.</p>			
Base	ARObject, Identifiable, MultilanguageReferrable, Referrable			
Subclasses	DiagEventDebounceCounterBased, DiagEventDebounceMonitorInternal, DiagEventDebounceTimeBased			
Attribute	Type	Mult.	Kind	Note
–	–	–	–	–

Table 13.17: DiagEventDebounceAlgorithm

Class	DiagEventDebounceCounterBased			
Package	M2::AUTOSARTemplates::CommonStructure::ServiceNeeds			
Note	<p>This meta-class represents the ability to indicate that the counter-based debounce algorithm shall be used by the DEM for this diagnostic monitor.</p> <p>This is related to set the ECUC choice container DemDebounceAlgorithmClass to DemDebounceCounterBased.</p>			
Base	ARObject, DiagEventDebounceAlgorithm, Identifiable, MultilanguageReferrable, Referrable			
Attribute	Type	Mult.	Kind	Note
counterBased FdcThreshold StorageValue	Integer	0..1	attr	Threshold to allocate an event memory entry and to capture the Freeze Frame.
counter DecrementStep Size	Integer	1	attr	<p>This value shall be taken to decrement the internal debounce counter.</p> <p>Stereotypes: atpVariation Tags:vh.latestBindingTime=preCompileTime</p>
counterFailed Threshold	Integer	1	attr	<p>This value defines the event-specific limit that indicates the "failed" counter status.</p> <p>Stereotypes: atpVariation Tags:vh.latestBindingTime=preCompileTime</p>
counter IncrementStep Size	Integer	1	attr	<p>This value shall be taken to increment the internal debounce counter.</p> <p>Stereotypes: atpVariation Tags:vh.latestBindingTime=preCompileTime</p>
counterJump Down	Boolean	1	attr	<p>This value activates or deactivates the counter jump-down behavior.</p> <p>Stereotypes: atpVariation Tags:vh.latestBindingTime=preCompileTime</p>





Class		DiagEventDebounceCounterBased		
counterJumpDownValue	Integer	1	attr	This value represents the initial value of the internal debounce counter if the counting direction changes from incrementing to decrementing. Stereotypes: atpVariation Tags: vh.latestBindingTime=preCompileTime
counterJumpUp	Boolean	1	attr	This value activates or deactivates the counter jump-up behavior. Stereotypes: atpVariation Tags: vh.latestBindingTime=preCompileTime
counterJumpUpValue	Integer	1	attr	This value represents the initial value of the internal debounce counter if the counting direction changes from decrementing to incrementing. Stereotypes: atpVariation Tags: vh.latestBindingTime=preCompileTime
counterPassedThreshold	Integer	1	attr	This value defines the event-specific limit that indicates the "passed" counter status. Stereotypes: atpVariation Tags: vh.latestBindingTime=preCompileTime

Table 13.18: DiagEventDebounceCounterBased

Class		DiagEventDebounceTimeBased		
Package	M2::AUTOSARTemplates::CommonStructure::ServiceNeeds			
Note	This meta-class represents the ability to indicate that the time-based pre-debounce algorithm shall be used by the Dem for this diagnostic monitor. This is related to set the EcuC choice container DemDebounceAlgorithmClass to DemDebounceTimeBase.			
Base	ARObject, DiagEventDebounceAlgorithm , Identifiable , MultilanguageReferrable , Referrable			
Attribute	Type	Mult.	Kind	Note
timeBasedFdcThresholdStorageValue	TimeValue	0..1	attr	Threshold to allocate an event memory entry and to capture the Freeze Frame. Stereotypes: atpVariation Tags: vh.latestBindingTime=postBuild
timeFailedThreshold	TimeValue	1	attr	This value represents the event-specific delay indicating the "failed" status. Stereotypes: atpVariation Tags: vh.latestBindingTime=postBuild
timePassedThreshold	TimeValue	1	attr	This value represents the event-specific delay indicating the "passed" status. Stereotypes: atpVariation Tags: vh.latestBindingTime=postBuild

Table 13.19: DiagEventDebounceTimeBased

Class	DiagEventDebounceMonitorInternal			
Package	M2::AUTOSARTemplates::CommonStructure::ServiceNeeds			
Note	<p>This meta-class represents the ability to indicate that the pre-debounce algorithm shall be used by the Dem for this diagnostic monitor.</p> <p>This is related to setting the EcuC choice container DemDebounceAlgorithmClass to DemDebounceMonitorInternal.</p> <p>If the FaultDetectionAlogrithm is already known to be implemented by a specific BswModuleEntry the reference bswModuleEntry points to the function specification.</p> <p>If the FaultDetectionCounter value is accessible at a PortPrototype this PortPrototype shall be referenced by an assignedPort.</p>			
Base	<i>ARObject</i> , <i>DiagEventDebounceAlgorithm</i> , <i>Identifiable</i> , <i>MultilanguageReferrable</i> , <i>Referrable</i>			
Attribute	Type	Mult.	Kind	Note
–	–	–	–	–

Table 13.20: DiagEventDebounceMonitorInternal

The figure 13.6 shows the relationship of the class `DiagnosticEventNeeds`. The given M2 structure support to express following properties of a diagnostic monitor in addition to the basic set of attributes provided by `DiagnosticCapabilityElement`:

With the `inhibitingFid` reference to an `FunctionInhibitionNeeds` instance on M1 it is declared that either the monitoring of a symptom or the reporting of detected faults can be inhibited by the usage of the Function Inhibition Managers.

The used `PortPrototype` which has to be connected to the Function Inhibition Managers is determined by the `RoleBasedPortAssignment` of the related `FunctionInhibitionNeeds` instance on M1.

The reference from a M1 instance of an `ObdRatioServiceNeeds` to an M1 instance of a `DiagnosticEventNeeds` specifies that the related Diagnostic Monitor supports Rate Based Monitoring. For further details see 13.8.5

[TPS_SWCT_01582] Semantics of `DiagnosticEventNeeds.deferringFid`
[Diagnostic monitor implementations use *Function Identifiers* (FID) to acquire permission from `FIM` before executing the fault detection.

Typically, the permission is not granted by `FIM` if other *Events* have already been reported as *FAILED*, which would lead to a double-detection of the same failure.

In some cases (see [38]), diagnostic monitor implementations do not only shut down completely in case of “no permission”, but fully compute their result and do just not deliver it to `Dem` before further conditions are fulfilled.

Typically, such diagnostics can detect a coarse failure quickly. But it avoids reporting *FAIL* early to give other *Events* a chance to deliver a more precise *FAIL*.

In such cases, the delivery of the result is only allowed when `FIM` grants a permission, with inhibitions on `NOT_TESTED` of other *Events*. These *Function Inhibitions* are specified by means of the attribute `DiagnosticEventNeeds.deferringFid`.

|(RS_SWCT_00170, RS_SWCT_03190)

As a corresponding concept to `DiagnosticEventNeeds`, the `DiagnosticEventInfoNeeds` represents the needs to a given software-component that is interested to get information about specific DTCs.

Class	DiagnosticEventInfoNeeds			
Package	M2::AUTOSARTemplates::CommonStructure::ServiceNeeds			
Note	This meta-class represents the needs of a software-component interested to get information regarding specific DTCs.			
Base	<i>ARObject</i> , <i>DiagnosticCapabilityElement</i> , <i>Identifiable</i> , <i>MultilanguageReferrable</i> , <i>Referrable</i> , <i>ServiceNeeds</i>			
Attribute	Type	Mult.	Kind	Note





Class		DiagnosticEventInfoNeeds		
dtcKind	DtcKindEnum	0..1	attr	This attribute indicates the kind of the diagnostic event according to the SWS Diagnostic Event Manger for which the DiagnosticInfo is requested. This attribute applies for the UDS diagnostics use case.
obdDtcNumber	PositiveInteger	0..1	attr	This represents a reasonable Diagnostic Trouble Code. This allows to predefine the Diagnostic Trouble Code, e.g. if the function developer has received a particular requirement from the OEM or from a standardization body. This attribute applies for the OBD diagnostics use case.
udsDtcNumber	PositiveInteger	0..1	attr	This represents a reasonable Diagnostic Trouble Code. This allows to predefine the Diagnostic Trouble Code, e.g. if the function developer has received a particular requirement from the OEM or from a standardization body. This attribute applies for the UDS diagnostics use case.

Table 13.21: DiagnosticEventInfoNeeds

Class		DiagnosticOperationCycleNeeds		
Package	M2::AUTOSARTemplates::CommonStructure::ServiceNeeds			
Note	This meta-class represents the needs of a software-component to provide information regarding the operation cycle management to the Dem module.			
Base	ARObject, DiagnosticCapabilityElement, Identifiable, MultilanguageReferrable, Referrable, Service Needs			
Attribute	Type	Mult.	Kind	Note
operationCycle	OperationCycleType Enum	0..1	attr	Operation cycles types for the Dem to be supported by cycle-state APIs.
operationCycle AutomaticEnd	Boolean	0..1	attr	If this attribute is set to true the Dem shall automatically end the driving cycle at either Dem_Shutdown() or Dem_Init().
operationCycle Autostart	Boolean	0..1	attr	If this attribute is set to true the operation cycles is automatically (re-)started during Dem_PreInit().

Table 13.22: DiagnosticOperationCycleNeeds

Enumeration		OperationCycleTypeEnum
Package	M2::AUTOSARTemplates::CommonStructure::ServiceNeeds	
Note	The possible values of the operation cycles types for the Dem.	
Literal	Description	
ignition	Ignition ON / OFF cycle. Tags: atp.EnumerationLiteralIndex=0	
obdDcy	OBD Driving cycle. Tags: atp.EnumerationLiteralIndex=1	
other	Further operation cycle. Tags: atp.EnumerationLiteralIndex=2	





Enumeration	OperationCycleTypeEnum
power	Power ON / OFF cycle. Tags: atp.EnumerationLiteralIndex=3
time	Time based operation cycle. Tags: atp.EnumerationLiteralIndex=4
warmup	OBD Warm up cycle. Tags: atp.EnumerationLiteralIndex=5

Table 13.23: OperationCycleTypeEnum

Class	DiagnosticEnableConditionNeeds			
Package	M2::AUTOSARTemplates::CommonStructure::ServiceNeeds			
Note	This meta-class represents the needs of a software-component to provide the capability to set an enable condition.			
Base	<i>ARObject</i> , <i>DiagnosticCapabilityElement</i> , <i>Identifiable</i> , <i>MultilanguageReferrable</i> , <i>Referrable</i> , <i>Service Needs</i>			
Attribute	Type	Mult.	Kind	Note
initialStatus	EventAcceptanceStatus Enum	0..1	attr	Defines the initial status for enable or disable of acceptance of event reports of a diagnostic event.

Table 13.24: DiagnosticEnableConditionNeeds

Enumeration	EventAcceptanceStatusEnum
Package	M2::AUTOSARTemplates::CommonStructure::ServiceNeeds
Note	This enumerator specifies the initial status for enable or disable of acceptance of event reports of a diagnostic event.
Literal	Description
eventAcceptance Disabled	Acceptance of a diagnostic event is disabled. Tags: atp.EnumerationLiteralIndex=0
eventAcceptance Enabled	Acceptance of a diagnostic event is enabled. Tags: atp.EnumerationLiteralIndex=1

Table 13.25: EventAcceptanceStatusEnum

Class	DiagnosticStorageConditionNeeds			
Package	M2::AUTOSARTemplates::CommonStructure::ServiceNeeds			
Note	This meta-class represents the needs of a software-component to provide the capability to set a storage condition.			
Base	<i>ARObject</i> , <i>DiagnosticCapabilityElement</i> , <i>Identifiable</i> , <i>MultilanguageReferrable</i> , <i>Referrable</i> , <i>Service Needs</i>			
Attribute	Type	Mult.	Kind	Note
initialStatus	StorageConditionStatus Enum	0..1	attr	Defines the initial status for enable or disable of storage of a diagnostic event.

Table 13.26: DiagnosticStorageConditionNeeds

Enumeration	StorageConditionStatusEnum
Package	M2::AUTOSARTemplates::CommonStructure::ServiceNeeds
Note	This enumeration specifies the initial status for enable or disable of storage of a diagnostic event.
Literal	Description
eventStorage Disabled	Storage of a diagnostic event is disabled. Tags: atp.EnumerationLiteralIndex=0
eventStorage Enabled	Storage of a diagnostic event is enabled. Tags: atp.EnumerationLiteralIndex=1

Table 13.27: StorageConditionStatusEnum

Class	DtcStatusChangeNotificationNeeds			
Package	M2::AUTOSARTemplates::CommonStructure::ServiceNeeds			
Note	This meta-class represents the needs of a software-component interested to get information regarding any DTC status change.			
Base	<i>ARObject</i> , <i>DiagnosticCapabilityElement</i> , <i>Identifiable</i> , <i>MultilanguageReferrable</i> , <i>Referrable</i> , <i>ServiceNeeds</i>			
Attribute	Type	Mult.	Kind	Note
dtcFormatType	DtcFormatTypeEnum	0..1	attr	This attribute specifies the DTC format.

Table 13.28: DtcStatusChangeNotificationNeeds

Enumeration	DtcFormatTypeEnum
Package	M2::AUTOSARTemplates::CommonStructure::ServiceNeeds
Note	This enumeration specifies the DTC format.
Literal	Description
j1939	Defines the J1939 DTC format. Tags: atp.EnumerationLiteralIndex=0
obd	Defines the OBD DTC format. Tags: atp.EnumerationLiteralIndex=1
uds	Defines the UDS DTC format. Tags: atp.EnumerationLiteralIndex=2

Table 13.29: DtcFormatTypeEnum

13.8.3.1 Dem Service Use Case: diagnostic monitor, debouncing by Dem

Scenario: an [AtomicSwComponentType](#) implements a Diagnostic Monitor. The debouncing of the failure condition shall be configured and processed by the Dem. In this case the following setup apply:

[TPS_SWCT_01028] [AtomicSwComponentType](#) implements a Diagnostic Monitor [

ServiceNeeds kind [DiagnosticEventNeeds](#)

RoleBasedPortAssignment valid roles:

- DiagnosticMonitor [1]
- DiagnosticInfo [0..1]
- CallbackInitMonitorForEvent [0..1]
- CallbackEventUdsStatusChanged [0..1]
- CallbackClearEventAllowed [0..1]

RoleBasedDataAssignment

N/A

RepresentedPortGroups

N/A

]([RS_SWCT_00170](#), [RS_SWCT_03190](#))

Please note that for the implementation of this scenario [DiagEventDebounceCounterBased](#) or [DiagEventDebounceTimeBased](#) algorithm should be used as [diagEventDebounceAlgorithm](#).

13.8.3.2 Dem Service Use Case: diagnostic monitor, debouncing by SWC

Scenario: an [AtomicSwComponentType](#) implements a Diagnostic Monitor. The debouncing of the failure condition shall be processed by the software component. In this case the following setup applies:

[TPS_SWCT_01029] [AtomicSwComponentType](#) implements a Diagnostic Monitor [

ServiceNeeds kind [DiagnosticEventNeeds](#)

RoleBasedPortAssignment valid roles:

- DiagnosticMonitor [1]
- DiagnosticInfo [0..1]
- CallbackInitMonitorForEvent [0..1]
- CallbackEventUdsStatusChanged [0..1]
- CallbackClearEventAllowed [0..1]
- CallbackGetFaultDetectCounter [0..1]

RoleBasedDataAssignment

N/A

RepresentedPortGroups

N/A

]([RS_SWCT_00170](#), [RS_SWCT_03190](#))

Please note that for the implementation of this scenario `DiagEventDebounceMonitorInternal` algorithm should be used as `diagEventDebounceAlgorithm`.

13.8.3.3 Dem Service Use Case: software-component provides information about operation cycles

Scenario: an `AtomicSwComponentType` provides information about operating cycles, e.g. ignition cycle or driving cycle.

[TPS_SWCT_01132] `AtomicSwComponentType` provides information about operating cycles [

ServiceNeeds kind `DiagnosticOperationCycleNeeds`

RoleBasedPortAssignment valid roles:

- `OperationCycle` [1]

RoleBasedDataAssignment

N/A

RepresentedPortGroups

N/A

]([RS_SWCT_00170](#), [RS_SWCT_03190](#))

For more information please refer to [SWS_Dem_00601].

13.8.3.4 Dem Service Use Case: software-component enables reporting of DTCs in general

Scenario: a `AtomicSwComponentType` enables the reporting of DTCs in general.

[TPS_SWCT_01134] `AtomicSwComponentType` enables reporting of DTCs in general [

ServiceNeeds kind `DiagnosticEnableConditionNeeds`

RoleBasedPortAssignment valid roles:

- `EnableCondition` [1]

RoleBasedDataAssignment

N/A

RepresentedPortGroups

N/A

]([RS_SWCT_00170](#), [RS_SWCT_03190](#))

For more information please refer to [SWS_Dem_00604] and [ECUC_Dem_00656].

13.8.3.5 Dem Service Use Case: software-component enables storage of subsequent DTCs

Scenario: an `AtomicSwComponentType` enables the storage of subsequent DTCs.

[TPS_SWCT_01135] `AtomicSwComponentType` enables storage of subsequent DTCs [

ServiceNeeds kind `DiagnosticStorageConditionNeeds`

RoleBasedPortAssignment valid roles:

- `StorageCondition` [1]

RoleBasedDataAssignment

N/A

RepresentedPortGroups

N/A

](`RS_SWCT_00170`, `RS_SWCT_03190`)

For more information please refer to [SWS_Dem_00605].

The relevant DTCs shall be configured in ECUC because at the time the `AtomicSwComponentType` is designed the information about which DTCs are relevant is not fully available.

13.8.3.6 Dem Service Use Case: retrieve information of the lamp status

Scenario: an `AtomicSwComponentType` retrieves information of the lamp status.

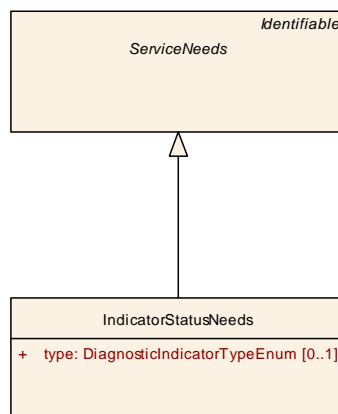

Figure 13.7: Modeling of `IndicatorStatusNeeds`

[TPS_SWCT_01136] `AtomicSwComponentType` retrieves information of the lamp status [

ServiceNeedsKind `IndicatorStatusNeeds`

RoleBasedPortAssignment valid roles:

- `IndicatorStatus` [1]

RoleBasedDataAssignment

N/A

RepresentedPortGroups

N/A

|(RS_SWCT_00170, RS_SWCT_03190)

For more information please refer to [SWS_Dem_00606].

Class	IndicatorStatusNeeds			
Package	M2::AUTOSARTemplates::CommonStructure::ServiceNeeds			
Note	This meta-class shall be taken to signal a service use case that affects the indicator status.			
Base	ARObject, Identifiable, MultilanguageReferrable, Referrable, ServiceNeeds			
Attribute	Type	Mult.	Kind	Note
type	DiagnosticIndicatorType Enum	0..1	attr	Defines the type of the indicator.

Table 13.30: IndicatorStatusNeeds

13.8.3.7 Dem Service Use Case: DEM provides information that the fault storage overflows

Please note that for this specific use case the application of a concrete *ServiceNeeds* is not yet clarified.

Scenario: the Dem provides information that the fault storage overflows.

[TPS_SWCT_01137] Dem provides information that the fault storage overflows [

RoleBasedPortAssignment valid roles:

- `EvMemOverflowIndication` [1]

RoleBasedDataAssignment

N/A

RepresentedPortGroups

N/A

|(RS_SWCT_00170, RS_SWCT_03190)

For more information please refer to [SWS_Dem_00607].

13.8.3.8 Dem Service Use Case: software-component suppresses the storage of DTCs

Scenario: an [AtomicSwComponentType](#) suppresses the storage of DTCs within the Dem.

[TPS_SWCT_01138] [AtomicSwComponentType](#) suppresses the storage of DTCs within the Dem [

ServiceNeeds kind [DiagnosticEventManagerNeeds](#)

RoleBasedPortAssignment valid roles:

- [DTCsuppression](#) [1]

RoleBasedDataAssignment

N/A

RepresentedPortGroups

N/A

]([RS_SWCT_00170](#), [RS_SWCT_03190](#))

For more information please refer to [SWS_Dem_00608].

13.8.3.9 Dem Service Use Case: software-component informs that the PTO is active

Scenario: an [AtomicSwComponentType](#) informs the Dem that the PTO is active.

[TPS_SWCT_01139] [AtomicSwComponentType](#) informs the Dem that the PTO is active [

ServiceNeeds kind [DiagnosticEventManagerNeeds](#)

RoleBasedPortAssignment

The following roles are applicable:

- [PowerTakeOff](#) [1]

RoleBasedDataAssignment

N/A

RepresentedPortGroups

N/A

]([RS_SWCT_00170](#), [RS_SWCT_03190](#))

For more information please refer to [SWS_Dem_00612].

13.8.3.10 Dem Service Use Case: software-component needs information about any DTC status change

Scenario: an `AtomicSwComponentType` needs information about any DTC status change. There is no limitation on the number of software-components requesting the information.

[TPS_SWCT_01140] `AtomicSwComponentType` needs information about specific DTC without being a diagnostic monitor [

ServiceNeeds kind `DtcStatusChangeNotificationNeeds`

RoleBasedPortAssignment valid roles:

- `CallbackDTCStatusChange` [1]

RoleBasedDataAssignment

N/A

RepresentedPortGroups

N/A

](`RS_SWCT_00170`, `RS_SWCT_03190`)

For more information please refer to [SWS_Dem_00617].

In the case the software-component needs notifications about different kinds of the DTC status change (formalized by `DtcFormatTypeEnum`) it is applicable to create a `SwcServiceDependency` for each kind of status change.

13.8.3.11 Dem Service Use Case: call operation if the data of a given diagnostic event changes (I)

Scenario: an `AtomicSwComponentType` provides a `PPortPrototype` typed by the `ClientServerInterface` `CallbackEventDataChanged`. The service component calls the `ClientServerOperation` `EventDataChanged` if the corresponding diagnostic event changes in terms of the underlying data.

For each diagnostic events to which the `AtomicSwComponentType` is conceptually connected it needs to provide one `PPortPrototype` towards the service component.

[TPS_SWCT_01425] `AtomicSwComponentType` provides one callback per event if diagnostic event data change [

ServiceNeeds kind `DiagnosticEventInfoNeeds`

RoleBasedPortAssignment valid roles:

- `CallbackEventDataChanged` [1]

RoleBasedDataAssignment

N/A

RepresentedPortGroups

N/A

|(RS_SWCT_00170, RS_SWCT_03190)

For more information please refer to [SWS_Dem_00618].

13.8.3.12 Dem Service Use Case: call operation if the data or status of any diagnostic event changes (II)

Scenario: an `AtomicSwComponentType` shall react on any diagnostic event status change and/or any diagnostic event data change. For instance this may be used to write a time stamp when any event status changes regardless of the event id.

In contrast to the scenario described in chapter 13.8.3.11 or 13.8.3.10 this case foresees the existence of a single `PPortPrototype` that covers all relevant diagnostic events.

[TPS_SWCT_01426] `AtomicSwComponentType` provides callback if any diagnostic event data and/or status changed [

ServiceNeeds kind `DiagnosticEventManagerNeeds`

RoleBasedPortAssignment valid roles:

- `GeneralCallbackEventDataChanged` [0..1]
- `GeneralCallbackEventUdsStatusChange` [0..1]
- `GeneralDiagnosticInfo` [0..1]

RoleBasedDataAssignment

N/A

RepresentedPortGroups

N/A

For more information please refer to [SWS_Dem_00616], [SWS_Dem_00619], and [SWS_Dem_00600].

In order to react on diagnostic event status changes the software component shall provide a single `PPortPrototype` typed as a client server interface compatible to `GeneralCallbackEventDataChanged`.

In order to react on diagnostic event data changes the software component shall provide a single `PPortPrototype` typed as a client server interface compatible to `GeneralCallbackEventDataChanged`.

If the software-component additionally has to read further information of the specific diagnostic event from Dem it shall provide a `RPortPrototype` typed as a client server interface compatible to `GeneralDiagnosticInfo`. It shall also specify `DiagnosticEventInfoNeeds`.|(RS_SWCT_00170, RS_SWCT_03190)

13.8.3.13 Dem Service Use Case: software-component provides data for diagnostic purposes

Please note that for this specific use case the application of a concrete *ServiceNeeds* is not yet clarified.

Scenario: an *AtomicSwComponentType* provides data to be used for diagnostic purposes. The provision of data can be done by means of *PPortPrototypes* typed by either *ClientServerInterfaces* or *SenderReceiverInterfaces*. The usage of the latter, however, is not further detailed in the applicable SWS [39] and therefore no more details are to be provided in this document.

[TPS_SWCT_01427] *AtomicSwComponentType* provides data for diagnostic purposes via *ClientServerInterface* [

RoleBasedPortAssignment valid roles:

- *DataServices* [1]

RoleBasedDataAssignment

N/A

RepresentedPortGroups

N/A

](*RS_SWCT_00170*, *RS_SWCT_03190*)

[TPS_SWCT_01634] Suffix used for the resulting name of the *PortInterface* for the Data Services [The *suffix* used for the resulting name of the *PortInterface* for the Data Services (*DataServices_{Data}*) shall be taken from the *shortName* of the applicable *SwcServiceDependency*.] (*RS_SWCT_00170*, *RS_SWCT_03190*)

For more information please refer to [SWS_Dem_00621].

13.8.3.14 Dem Service Use Case: software-component gets information about a specific DTC

Scenario: an *AtomicSwComponentType* specifies *DiagnosticEventInfoNeeds* in order to be able to get information about specific DTCs. This use case to some extent is similar to [TPS_SWCT_01426] but does not replace that use case.

[TPS_SWCT_01453] Software-component gets information about a specific DTC [

ServiceNeeds kind *DiagnosticEventInfoNeeds*

RoleBasedPortAssignment valid roles:

- *DiagnosticInfo* [1]

RoleBasedDataAssignment

N/A

RepresentedPortGroups

N/A

]([RS_SWCT_00170](#), [RS_SWCT_03190](#))

For more information please refer to [SWS_Dem_00609].

13.8.3.15 Dem Service Use Case: Software-Component wants to be triggered on Monitor Status Changes

Scenario: a software-component wants to be triggered on monitor status changes if this is supported for the specific monitor status. Events reported from basic-software modules cannot be considered in this service use case.

The Dem will not provide corresponding [PortPrototypes](#) for events reported by basic-software modules.

This way, the service use case cannot be used for events reported by the basic-software.

However, for the creator of the service use case there is no way to find out whether the event will be reported by basic software of application software-component.

[TPS_SWCT_01715] Software-Component wants to be triggered on Monitor Status Changes [

ServiceNeeds kind [DiagnosticEventManagerNeeds](#)

RoleBasedPortAssignment valid roles:

- `CallbackMonitorStatusChange [1]`

RoleBasedDataAssignment

N/A

RepresentedPortGroups

N/A

]([RS_SWCT_00170](#), [RS_SWCT_03190](#))

13.8.3.16 Dem Service Use Case: write parameter identifier by software-component

Scenario: A software-component computes the PIDs, and pushes them to Dem for storage and reporting to Dcm.

[TPS_SWCT_01766] Software-component computes the PIDs, and pushes them to Dem for storage and reporting to Dcm [

ServiceNeeds kind [ObdPidServiceNeeds](#)

RoleBasedPortAssignment valid roles:

- [SetDataOfPID21](#) [1]
- [SetDataOfPID4D](#) [1]
- [SetDataOfPID4E](#) [1]

RoleBasedDataAssignment

N/A

RepresentedPortGroups

N/A

[\]\(RS_SWCT_00170, RS_SWCT_03190\)](#)

13.8.3.17 Dem Service Use Case: read parameter identifier by software-component

Scenario: A software-component located on an OBD master ECU reads the PID 21, and sends the value around via “regular” sender-receiver communication to other software-components located on OBD primary ECUs with the obligation to push the PID value to their local Dem.

[TPS_SWCT_01767] Software-component located on an OBD master ECU reads the PID 21, and and sends the value around via “regular” sender-receiver communication [

ServiceNeeds kind [ObdPidServiceNeeds](#)

RoleBasedPortAssignment valid roles:

- [GetDataOfPID21](#) [1]

RoleBasedDataAssignment

N/A

RepresentedPortGroups

N/A

[\]\(RS_SWCT_00170, RS_SWCT_03190\)](#)

13.8.3.18 Dem Service Use Case: diagnostic monitor provides monitor data, debouncing by Dem

Scenario: an `AtomicSwComponentType` implements a Diagnostic Monitor that is able to provide monitor data. The debouncing of the failure condition shall be configured and processed by the Dem. In this case the following setup applies:

[TPS_SWCT_01789] `AtomicSwComponentType` implements a Diagnostic Monitor that provides monitor data, debouncing by Dem [

ServiceNeeds kind `DiagnosticEventNeeds` (with attribute `usesMonitorData` set to `TRUE`)

RoleBasedPortAssignment valid roles:

- `DiagnosticMonitor` [0..1]
- `DiagnosticMonitor_MonitorData` [1]
- `DiagnosticInfo` [0..1]
- `CallbackInitMonitorForEvent` [0..1]
- `CallbackEventStatusChange` [0..1]
- `CallbackClearEventAllowed` [0..1]

RoleBasedDataAssignment

N/A

RepresentedPortGroups

N/A

] ([RS_SWCT_00170](#), [RS_SWCT_03190](#))

Please note that for the implementation of this scenario the sub-class `DiagEventDebounceCounterBased` or `DiagEventDebounceTimeBased` algorithm should be used as the value for attribute `DiagnosticEventNeeds.diagEventDebounceAlgorithm`.

13.8.3.19 Dem Service Use Case: diagnostic monitor provides monitor data, debouncing by software-component

Scenario: an `AtomicSwComponentType` implements a Diagnostic Monitor that is able to provide monitor data. The debouncing of the failure condition shall be configured and processed by the software-component that implements the monitor. In this case the following setup applies:

[TPS_SWCT_01790] `AtomicSwComponentType` implements a Diagnostic Monitor that provides monitor data, debouncing by software-component [

ServiceNeeds kind `DiagnosticEventNeeds` (with attribute `usesMonitorData` set to `TRUE`)

RoleBasedPortAssignment valid roles:

- `DiagnosticMonitor` [0..1]
- `DiagnosticMonitor_MonitorData` [1]
- `DiagnosticInfo` [0..1]
- `CallbackInitMonitorForEvent` [0..1]
- `CallbackEventStatusChange` [0..1]
- `CallbackClearEventAllowed` [0..1]
- `CallbackGetFaultDetectCounter` [1]

RoleBasedDataAssignment

N/A

RepresentedPortGroups

N/A

|([RS_SWCT_00170](#), [RS_SWCT_03190](#))

Please note that for the implementation of this scenario the sub-class `DiagEventDebounceMonitorInternal` should be used as the value for attribute `DiagnosticEventNeeds.diagEventDebounceAlgorithm`.

13.8.4 Diagnostic Communication Needs

The meta-class `DiagnosticCommunicationManagerNeeds` is used to define requirements in order to configure the Diagnostic Communication Manager Service.

An `SwcInternalBehavior` may provide a `DiagnosticCommunicationManagerNeeds` element which defines the mappings for the general diagnostic communication (for the terms related to the AUTOSAR Diagnostic Communication Manager see [40]).

Class	DiagnosticCommunicationManagerNeeds
Package	M2::AUTOSARTemplates::CommonStructure::ServiceNeeds
Note	Specifies the general needs on the configuration of the Diagnostic Communication Manager (Dcm) which are not related to a particular item (e.g. a PID or <code>DiagnosticRoutineNeeds</code>). The main use case is the mapping of service ports to the Dcm which are not related to a particular item.
Base	<code>ARObject</code> , <code>DiagnosticCapabilityElement</code> , <code>Identifiable</code> , <code>MultilanguageReferrable</code> , <code>Referrable</code> , <code>ServiceNeeds</code>





Class		DiagnosticCommunicationManagerNeeds		
Attribute	Type	Mult.	Kind	Note
serviceRequestCallbackType	DiagnosticServiceRequestCallbackTypeEnum	0..1	attr	This represents the ability to define whether the usage of PortInterface ServiceRequestNotification has the characteristics of being initiated by a manufacturer or by a supplier.

Table 13.31: DiagnosticCommunicationManagerNeeds

Enumeration	DiagnosticServiceRequestCallbackTypeEnum
Package	M2::AUTOSARTemplates::CommonStructure::ServiceNeeds
Note	This represents the ability to define whether a Service Request Notification was used in the role of a manufacturer or a supplier.
Literal	Description
requestCallbackTypeManufacturer	This represents the case that the usage of PortInterface ServiceRequestNotification has the characteristics of being used by a manufacturer. Tags: atp.EnumerationLiteralIndex=0
requestCallbackTypeSupplier	This represents the case that the usage of PortInterface ServiceRequestNotification has the characteristics of being used by a supplier. Tags: atp.EnumerationLiteralIndex=1

Table 13.32: DiagnosticServiceRequestCallbackTypeEnum

The meta-class [DiagnosticRoutineNeeds](#) is used to define requirements to configure the Diagnostic Communication Manager Service. A [PPortPrototype](#) typed by a [ClientServerInterface](#)¹ may provide [ClientServerOperations](#) (for example, “start”, “stop”, and “RequestResults”).

The [PPortPrototype](#) corresponds to the diagnostic service [RoutineControl](#). Within the [SwcInternalBehavior](#) up to three [RunnableEntitys](#) are defined for implementing the [ClientServerOperations](#) mentioned before.

The enumeration parameter [DiagnosticRoutineTypeEnum](#) is used to define whether the diagnostic server or client is responsible for stopping the routine.

Please note that [constr_1340] and [constr_1341] apply for the application of [DiagnosticRoutineNeeds](#). These constraints are part of the specification of the [DiagnosticExtract](#) [37].

Class		DiagnosticRoutineNeeds
Package	M2::AUTOSARTemplates::CommonStructure::ServiceNeeds	
Note	Specifies the general needs on the configuration of the Diagnostic Communication Manager (Dcm) which are not related to a particular item (e.g. a PID). The main use case is the mapping of service ports to the Dcm which are not related to a particular item.	



¹where [isService](#) shall be set to true



Class	DiagnosticRoutineNeeds			
Base	<i>ARObject</i> , <i>DiagnosticCapabilityElement</i> , <i>Identifiable</i> , <i>MultilanguageReferrable</i> , <i>Referrable</i> , <i>ServiceNeeds</i>			
Attribute	Type	Mult.	Kind	Note
diagRoutineType	DiagnosticRoutineTypeEnum	1	attr	This denotes the type of diagnostic routine which is implemented by the referenced server port.
ridNumber	PositiveInteger	0..1	attr	This represents a routine identifier for the diagnostic routine. This allows to predefine the RID number if the a function developer has received a particular requirement from the OEM or from a standardization body.

Table 13.33: DiagnosticRoutineNeeds

Enumeration	DiagnosticRoutineTypeEnum
Package	M2::AUTOSARTemplates::CommonStructure::ServiceNeeds
Note	This enumerator specifies the different types of diagnostic routines.
Literal	Description
asynchronous	This indicates that the diagnostic server is not blocked while the diagnostic routine is running. Tags: atp.EnumerationLiteralIndex=0
synchronous	This indicates that the diagnostic routine blocks the diagnostic server in the ECU while the routine is running. Tags: atp.EnumerationLiteralIndex=1

Table 13.34: DiagnosticRoutineTypeEnum

The meta-class [DiagnosticIoControlNeeds](#) is used to define requirements to configure the Diagnostic Communication Manager Service. The [PPortPrototype](#) corresponds to the diagnostic service [InputOutputControlByIdentifier](#). Within the [SwcInternalBehavior](#) up to three [RunnableEntities](#) are defined for implementing the [ClientServerOperations](#) mentioned before.

Class	DiagnosticIoControlNeeds			
Package	M2::AUTOSARTemplates::CommonStructure::ServiceNeeds			
Note	Specifies the general needs on the configuration of the Diagnostic Communication Manager (DCM) which are not related to a particular item (e.g. a PID). The main use case is the mapping of service ports to the Dcm which are not related to a particular item.			
Base	<i>ARObject</i> , <i>DiagnosticCapabilityElement</i> , <i>Identifiable</i> , <i>MultilanguageReferrable</i> , <i>Referrable</i> , <i>ServiceNeeds</i>			
Attribute	Type	Mult.	Kind	Note
currentValue	DiagnosticValueNeeds	0..1	ref	Reference to the DiagnosticValueNeeds indicating the access to the current value via signalBasedDiagnostics .
didNumber	PositiveInteger	0..1	attr	This represents a Data identifier for the diagnostic value. This allows to predefine the DID number if the a function developer has received a particular requirement from the OEM or from a standardization body.
freezeCurrentStateSupported	Boolean	0..1	attr	This attribute determines, if the referenced port supports temporary freezing of I/O value.





Class	DiagnosticIoControlNeeds			
resetToDefaultSupported	Boolean	0..1	attr	This represents a flag for the existence of the ResetTo Default operation in the service interface.
shortTermAdjustmentSupported	Boolean	0..1	attr	This attribute determines, if the referenced port supports temporarily setting of I/O value to a specific value provided by the diagnostic tester.

Table 13.35: DiagnosticIoControlNeeds

The meta-class [DiagnosticValueNeeds](#) is used to define requirements in order to configure the Diagnostic Communication Manager Service as well as the Diagnostic Event Manager Service.

The DCM can access either local values via a [ClientServerInterface](#) or it may access [dataElements](#) in a [PPortPrototype](#) typed by a [SenderReceiverInterface](#). For this purpose, the [DiagnosticValueNeeds](#) require associations to local values (i.e. inside [InternalBehavior](#)) or respectively [dataElements](#).

The attribute [DiagnosticValueNeeds.diagnosticValueAccess](#) of type [DiagnosticValueAccessEnum](#) allows for distinguishing between current values to read diagnostic information (readOnly) and data elements which are additionally classified as configurable (readWrite).

[constr_1363] Existence of attributes of [DiagnosticValueNeeds](#) [if [DiagnosticValueNeeds](#) is aggregated by a [SwcServiceDependency](#) in the role [serviceNeeds](#) then the attributes

- [DiagnosticValueNeeds.diagnosticValueAccess](#)
- [DiagnosticValueNeeds.dataLength](#)

shall **not** exist.]()

[constr_1364] Existence of attributes of [DiagnosticIoControlNeeds](#) [if [DiagnosticIoControlNeeds](#) is aggregated by a [SwcServiceDependency](#) in the role [serviceNeeds](#) then the attributes

- [DiagnosticIoControlNeeds.freezeCurrentStateSupported](#)
- [DiagnosticIoControlNeeds.shortTermAdjustmentSupported](#)

shall **not** exist.]()

For all intents and purposes, the statement made by [\[constr_1363\]](#) and [\[constr_1364\]](#) boils down to the fact that these attributes can only be reasonably used in the context of a [BswServiceDependency](#).

Class	DiagnosticValueNeeds			
Package	M2::AUTOSARTemplates::CommonStructure::ServiceNeeds			
Note	<p>Specifies the general needs on the configuration of the Diagnostic Communication Manager (DCM) which are not related to a particular item (e.g. a PID). The main use case is the mapping of service ports to the DCM which are not related to a particular item.</p> <p>In the case of using a sender receiver communicated value, the related value shall be taken via assigned Data in the role "signalBasedDiagnostics".</p> <p>In case of using a client/server communicated value, the related value shall be communicated via the port referenced by assignedPort. The details of this communication (e.g. appropriate naming conventions) are specified in the related software specifications (SWS).</p>			
Base	<i>ARObject</i> , <i>DiagnosticCapabilityElement</i> , <i>Identifiable</i> , <i>MultilanguageReferrable</i> , <i>Referrable</i> , <i>ServiceNeeds</i>			
Attribute	Type	Mult.	Kind	Note
dataLength	PositiveInteger	0..1	attr	This attribute is applicable only if the ServiceNeed is aggregated within BswModuleDependency. This attribute represents the length of data (in bytes) provided for this particular PID signal.
diagnosticValueAccess	DiagnosticValueAccessEnum	0..1	attr	This attribute controls whether the data can be read and written or whether it is to be handled read-only.
didNumber	PositiveInteger	0..1	attr	This represents a Data identifier for the diagnostic value. This allows to predefine the DID number if the responsible function developer has received a particular requirement from the OEM or from a standardization body.
fixedLength	Boolean	0..1	attr	This attribute controls whether the data length of the data is fixed.
processingStyle	DiagnosticProcessingStyleEnum	0..1	attr	This attribute controls whether interaction requires the software-component to react synchronously on a request or whether it processes the request in background but still the DCM has to issue the call again to eventually obtain the result of the request.

Table 13.36: DiagnosticValueNeeds

Enumeration	DiagnosticValueAccessEnum
Package	M2::AUTOSARTemplates::CommonStructure::ServiceNeeds
Note	Defines the access of the configured diagnostic current values which will be used by the Dem or Dcm module.
Literal	Description
readOnly	The access to the data element is limited to read-only. This is typically used to read-out diagnostic information (e.g. current values). Tags: atp.EnumerationLiteralIndex=0
readWrite	The value of the diagnostic data element is classified as configurable (read and write access is possible). Tags: atp.EnumerationLiteralIndex=1
writeOnly	The access to the data element is limited to write-only. This supports the use case where the Dcm just writes data to the application software without the intention to read it back, Tags: atp.EnumerationLiteralIndex=2

Table 13.37: DiagnosticValueAccessEnum

Enumeration	DiagnosticProcessingStyleEnum
Package	M2::AUTOSARTemplates::CommonStructure::ServiceNeeds
Note	This meta-class represents the ability to define the processing style of diagnostic requests.
Literal	Description
processingStyle Asynchronous	The software-component processes the request in background but still the Dcm has to issue the call again to eventually obtain the result of the request. Tags: atp.EnumerationLiteralIndex=0
processingStyle AsynchronousWith Error	The software-component processes the request in background but still the Dcm has to issue the call again to eventually obtain the result of the request or handle error code. Tags: atp.EnumerationLiteralIndex=1
processingStyle Synchronous	The software-component is supposed to react synchronously on the request. Tags: atp.EnumerationLiteralIndex=2

Table 13.38: DiagnosticProcessingStyleEnum

Class	DiagnosticsCommunicationSecurityNeeds			
Package	M2::AUTOSARTemplates::CommonStructure::ServiceNeeds			
Note	This meta-class represents the needs of a software-component to verify the access to security level via diagnostic services.			
Base	ARObject , DiagnosticCapabilityElement , Identifiable , MultilanguageReferrable , Referrable , ServiceNeeds			
Attribute	Type	Mult.	Kind	Note
–	–	–	–	–

Table 13.39: DiagnosticsCommunicationSecurityNeeds

13.8.4.1 Dcm Service Use Case: read/write current values by Client Server Interface

Scenario: an [AtomicSwComponentType](#) offers a [PPortPrototype](#) typed by [ClientServerInterface](#) to read/write current value via diagnostic services (e.g. measurements, variant coding)

[TPS_SWCT_02002] [AtomicSwComponentType](#) offers a [PPortPrototype](#) typed by [ClientServerInterface](#) to read/write current value via diagnostic services

[

ServiceNeeds kind [DiagnosticValueNeeds](#)

RoleBasedPortAssignment valid roles:

- [DataServices](#) [1]

RoleBasedDataAssignment

N/A

RepresentedPortGroups

N/A

]([RS_SWCT_00170](#), [RS_SWCT_03190](#))

[TPS_SWCT_01628] Suffix used for the resulting name of the `PortInterface` for the Data Services [The *suffix* used for the resulting name of the `PortInterface` for the Data Services (`DataServices_{Data}`) shall be taken from the *shortName* of the applicable `SwcServiceDependency`.] ([RS_SWCT_00170](#), [RS_SWCT_03190](#))

For more information please refer to [SWS_Dcm_00686].

13.8.4.2 Dcm Service Use Case: read/write current values of specific DID by Client Server Interface

Scenario: an `AtomicSwComponentType` offers a `PPortPrototype` typed by `ClientServerInterface` to read/write current values via diagnostic services (e.g. measurements, variant coding) where the applicable DID is passed as an argument to the access functions. This use case applies mostly if the software-component provides the information related to more than one DID.

[TPS_SWCT_01639] `AtomicSwComponentType` offers a `PPortPrototype` typed by `ClientServerInterface` to read/write current value via diagnostic services where the applicable DID is passed as an argument to the access functions [

ServiceNeeds kind `DiagnosticValueNeeds`

RoleBasedPortAssignment valid roles:

- `DataServices_DIDRange` [1]

RoleBasedDataAssignment

N/A

RepresentedPortGroups

N/A

] ([RS_SWCT_00170](#), [RS_SWCT_03190](#))

[TPS_SWCT_01640] Suffix used for the resulting name of the `PortInterface` for the Data Services [The *suffix* used for the resulting name of the `PortInterface` for the Data Services (`DataServices_DIDRange_{Range}`) shall be taken from the *shortName* of the applicable `SwcServiceDependency`.] ([RS_SWCT_00170](#), [RS_SWCT_03190](#))

For more information please refer to [SWS_Dcm_00769].

13.8.4.3 Dcm Service Use Case: read/write current values by Sender Receiver Interface

Scenario: an `AtomicSwComponentType` offers `PortPrototypes` typed by `SenderReceiverInterfaces` to read/write current values via diagnostic services

(e.g. measurements, variant coding) This is mainly used for data which are available at ports anyhow used for other communication purpose.

Note: this scenario can be implemented as a regular sender/receiver communication without the necessity to use a `SwcServiceDependency`. The description of a `SwcServiceDependency` (even if it is technically not required) may help to advertise the special role of the corresponding `dataElement` with respect to diagnostics.

[TPS_SWCT_02003] `AtomicSwComponentType` offers `PortPrototypes` typed by `SenderReceiverInterfaces` to read/write current values via diagnostic services [

ServiceNeeds kind `DiagnosticValueNeeds`

RoleBasedPortAssignment

N/A

RoleBasedDataAssignment valid roles:

- `signalBasedDiagnostics` [1..2]

RepresentedPortGroups

N/A

To read the signal the `AtomicSwComponentType` shall offer an `AbstractProvidedPortPrototype`, to write the signal the `AtomicSwComponentType` shall offer an `AbstractRequiredPortPrototype`.] (`RS_SWCT_00170`, `RS_SWCT_03190`)

For more information please refer to `[TPS_SWCT_01579]` and `[SWS_Dcm_00687]`.

[constr_1679] Existence of attribute `RoleBasedDataAssignment.usedDataElement.localVariable` for `RoleBasedDataAssignment.role = signalBasedDiagnostics` [If the attribute `RoleBasedDataAssignment.role` is set to the value `signalBasedDiagnostics` then the reference `RoleBasedDataAssignment.usedDataElement.localVariable` shall not exist.]()

For explanation of the existence of `[constr_1679]`, it is not intended to provide diagnostic access to local variables inside the `SwcInternalBehavior`.

13.8.4.4 Dcm Service Use Case: start/stop or request routine results

Scenario: an `AtomicSwComponentType` offers a `PortPrototype` typed by a `ClientServerInterface` to start/stop or request routine results of diagnostic routines.

[TPS_SWCT_02004] `AtomicSwComponentType` offers a `PortPrototype` typed by a `ClientServerInterface` to start/stop or request routine results of diagnostic routines [

ServiceNeeds kind `DiagnosticRoutineNeeds`

RoleBasedPortAssignment valid roles:

- RoutineServices [1]

RoleBasedDataAssignment

N/A

RepresentedPortGroups

N/A

|(RS_SWCT_00170, RS_SWCT_03190)

[TPS_SWCT_01632] Suffix used for the resulting name of the PortInterface for the Routine Services [The *suffix* used for the resulting name of the `PortInterface` for the Routine Services (`RoutineServices_{RoutineName}`) shall be taken from the `shortName` of the applicable `SwcServiceDependency`.](RS_SWCT_00170, RS_SWCT_03190)

For more information please refer to [SWS_Dcm_00690].

[constr_1724] Usage of attribute ClientServerOperation.diagArgIntegrity

[The attribute `ClientServerOperation.diagArgIntegrity` shall only have the value `True` if the `ClientServerInterface` containing the respective `ClientServerOperation` is used to type a `PPortPrototype` that is referenced by a `RoleBasedPortAssignment` aggregated by a `SwcServiceDependency` that in turn aggregates `DiagnosticRoutineNeeds`.]()

13.8.4.5 Dcm Service Use Case: IO control by Client Server Interface

Scenario: an `AtomicSwComponentType` offers a `PortPrototype` typed by a `ClientServerInterface` to adjust the IO signal via diagnostic services.

[TPS_SWCT_02005] AtomicSwComponentType offers PortPrototypes typed by ClientServerInterfaces to adjust the IO signal via diagnostic services [

ServiceNeeds kind `DiagnosticIoControlNeeds`

RoleBasedPortAssignment valid roles:

- DataServices [1]

RoleBasedDataAssignment

N/A

RepresentedPortGroups

N/A

|(RS_SWCT_00170, RS_SWCT_03190)

[TPS_SWCT_01629] Suffix used for the resulting name of the PortInterface for the Data Services [The *suffix* used for the resulting name of the `PortInterface`

for the Data Services (DataServices_{Data}) shall be taken from the `shortName` of the applicable `SwcServiceDependency`.] ([RS_SWCT_00170](#), [RS_SWCT_03190](#))

For more information please refer to [SWS_Dcm_00686].

13.8.4.6 Dcm Service Use Case: IO control by Sender Receiver Interface

This use case represents an alternative to the use case described in chapter [13.8.4.5](#), i.e. for the same purpose it is also possible to utilize a `SenderReceiverInterface`.

The essential idea behind the existence of I/O `PortPrototypes` typed by `SenderReceiverInterface` is the possibility to have quick access to the `dataElements` currently under control.

Especially cases where access to `dataElements` is required from different partitions (for example in multi core systems) can benefit from this approach.

Scenario: an `AtomicSwComponentType` offers an `RPortPrototype` typed by a `SenderReceiverInterface` (in particular: `IOControlRequest`) to adjust the I/O signal via diagnostic services and offers a `PPortPrototype` typed by a `SenderReceiverInterface` (in particular: `IOControlResponse`) to provide the IO “operation response”.

In case of using `IOControlRequest` (which owns **three** `dataElements`) and `IOControlResponse` the whole `PortPrototype` is related to **exactly one** IO control and needs to be consistent.

Therefore, the usage of `RoleBasedPortAssignment` (instead of the `RoleBasedDataAssignment`, which would otherwise typically be used for a sender/receiver-based scenario) is required for avoiding modeling overhead.

[TPS_SWCT_01654] `AtomicSwComponentType` offers `PortPrototypes` typed by `SenderReceiverInterfaces` to adjust the IO signal via diagnostic services

[

ServiceNeeds kind `DiagnosticIoControlNeeds`

RoleBasedPortAssignment valid roles:

- `IOControlRequest` [1]
- `IOControlResponse` [1]
- `DataServices` [1]

RoleBasedDataAssignment

N/A

RepresentedPortGroups

N/A

] ([RS_SWCT_00170](#), [RS_SWCT_03190](#))

The IOControl service requires in its diagnostic response the current value of the IO-DID, which is identical to the current value represented by `DiagnosticValueNeeds` of the `ReadDataByIdentifier` response.

[TPS_SWCT_01655] Reference from `DiagnosticIoControlNeeds` to `DiagnosticValueNeeds` [In the scenario described by [TPS_SWCT_01654], the `DiagnosticIoControlNeeds` shall reference the `DiagnosticValueNeeds` which relates to the access of the current value via diagnostic services (see [TPS_SWCT_02003]).] (*RS_SWCT_00170, RS_SWCT_03190*)

[TPS_SWCT_01656] Suffix used for the resulting name of the `PortInterface` for `DataServices`, `IOControlRequest`, and `IOControlResponse` [The *suffix* used for the resulting name of the `PortInterface` for the `DataServices_{Data}`, `IOControlRequest_{Data}`, and `IOControlResponse_{Data}` shall be taken from the `shortName` of the applicable `SwcServiceDependency`.] (*RS_SWCT_00170, RS_SWCT_03190*)

The service use case is visualized in Figure 13.8. The `SwComponentPrototype` contains two `SwcServiceDependency`s, one for the I/O Control, and one for the access of the `dataElement` with the `shortName` “IOx” by the Dcm.

Please note that, in this example, the `SenderReceiverInterface` used on the `PPortPrototype` of the `ApplicationSwComponentType` has several `dataElements` (where the `dataElement` with the `shortName` “IOx” is one of them). This is a perfectly valid configuration.

On the other hand, the `SenderReceiverInterface` used on the `RPortPrototype` of the `ServiceSwComponentType` representing the Dcm can only have **one** `dataElement`. This single `dataElement` shall (as far as the example is concerned) be given the `shortName` “IOx”.

Note the reference from the `DiagnosticIoControlNeeds` to the `DiagnosticValueNeeds`. this reference explicitly expresses that access to a DID is combined with the usage of I/O control.

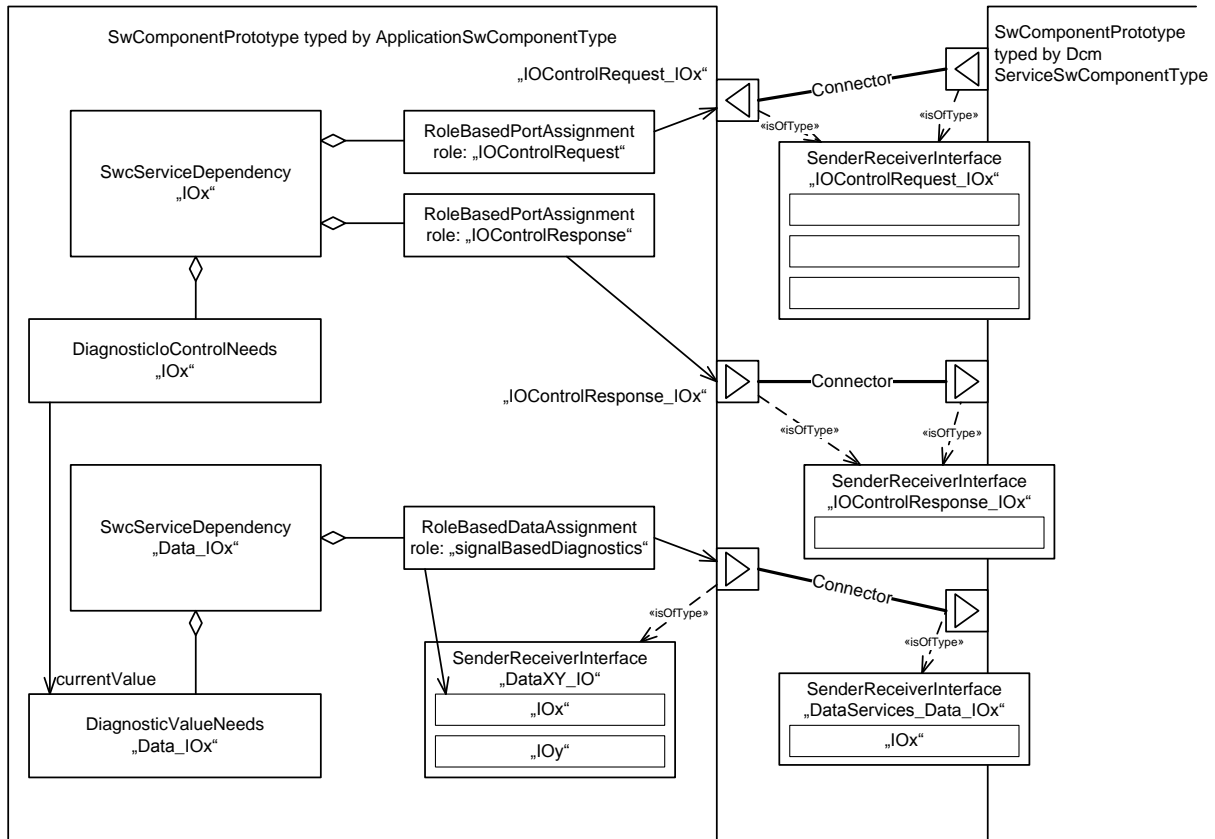

Figure 13.8: Visualization of the service use case

[TPS_SWCT_01657] NamingRule for **RPortPrototype** referenced by a **RoleBasedPortAssignment** with attribute **role** set to “IOControlRequest” [The **shortName** of a **RPortPrototype** referenced by a **RoleBasedPortAssignment** with attribute **role** set to “IOControlRequest” shall be created by concatenating the prefix “IOControlRequest” and the **SwcServiceDependency.shortName**, separated by a single underscore character (i.e. “_”).] (*RS_SWCT_00170, RS_SWCT_03190*)

For more information please refer to [SWS_Dcm_01308] and [SWS_Dcm_01309].

[constr_1741] Restriction to explicit sending semantics for the usage of **DataServices** in the context of a **SwcServiceDependency** that aggregates **DiagnosticValueNeeds** that in turn is referenced by a **DiagnosticIoControlNeeds** [A **dataElement**

- that is referenced by a **RoleBasedDataAssignment** (where the attribute **role** is set to **signalBasedDiagnostics**) owned by a **SwcServiceDependency** that aggregates **DiagnosticValueNeeds** that in turn is referenced by a **DiagnosticIoControlNeeds**
- **shall also be referenced** by a **VariableAccess** aggregated in the role **dataSendPoint** by a given **RunnableEntity** that in turn belongs to the enclosing **SwcInternalBehavior**.

]0

In other words, the data handled by the diagnostics transformer shall only be sent explicitly. The usage of **implicit sending of these data is not supported**.

13.8.4.7 Dcm Service Use Case: Access to protocol, session and security information

Scenario: an [AtomicSwComponentType](#) offers a server port to get protocol, session and security information or to request a Reset to Default Session.

[TPS_SWCT_02013] [AtomicSwComponentType](#) offers a server port to get protocol, session and security information or to request a Reset to Default Session

[

ServiceNeeds kind [DiagnosticCommunicationManagerNeeds](#)

RoleBasedPortAssignment valid roles:

- [DCMServices](#) [1]

RoleBasedDataAssignment

N/A

RepresentedPortGroups

N/A

]([RS_SWCT_00170](#), [RS_SWCT_03190](#))

For more information please refer to [SWS_Dcm_00698]

13.8.4.8 Dcm Service Use Case: Verify the access to security level

Scenario: an [AtomicSwComponentType](#) provides a server port to verify the access to security level via diagnostic services.

[TPS_SWCT_02015] [AtomicSwComponentType](#) verifies the access to security level via diagnostic services

[

ServiceNeeds kind [DiagnosticsCommunicationSecurityNeeds](#)

RoleBasedPortAssignment valid roles:

- [SecurityAccess](#) [1]

RoleBasedDataAssignment

N/A

RepresentedPortGroups

N/A

](RS_SWCT_00170, RS_SWCT_03190)

[TPS_SWCT_01627] Suffix used for the resulting name of the `PortInterface` for the Security Access [The *suffix* used for the resulting name of the `PortInterface` for the Security Access (`SecurityAccess_{SecurityLevel}`) shall be taken from the `shortName` of the applicable `SwcServiceDependency`.](RS_SWCT_00170, RS_SWCT_03190)

For more information please refer to [SWS_Dcm_00685]

13.8.4.9 Dcm Service Use Case: multiple testers access one ECU

Scenario: an `AtomicSwComponentType` provides a server port to get information on the status of the protocol communication. Further on the `AtomicSwComponentType` may disallow a protocol.

[TPS_SWCT_02016] `AtomicSwComponentType` requires information on the status of the protocol communication and may disallow a protocol [

ServiceNeeds kind `DiagnosticCommunicationManagerNeeds`

RoleBasedPortAssignment valid roles:

- `CallbackDCMRequestServices` [1]

RoleBasedDataAssignment

N/A

RepresentedPortGroups

N/A

](RS_SWCT_00170, RS_SWCT_03190)

For more information please refer to [SWS_Dcm_00692]

13.8.4.10 Dcm Service Use Case: Service Request Notification

Scenario: an `AtomicSwComponentType` provides a server port to get notified about a Service Request via diagnostic services. This indicates the successful reception of a new request to application.

Within this Service Request Notification this function application can examine the permission of the diagnostic service / environment.

Please note that the Service Request Notification can be used in two characteristics, i.e. as *manufacturer* ([TPS_SWCT_01577] applies) or as a *supplier* ([TPS_SWCT_01578] applies).

[TPS_SWCT_01577] `AtomicSwComponentType` requires the notification about a Service Request via diagnostic services with *manufacturer* characteristics [

The attribute `DiagnosticCommunicationManagerNeeds.serviceRequest-CallbackType` shall be set to the value `requestCallbackTypeManufacturer`.

ServiceNeeds kind `DiagnosticCommunicationManagerNeeds`

RoleBasedPortAssignment valid roles:

- `ServiceRequestNotification` [1]

RoleBasedDataAssignment

N/A

RepresentedPortGroups

N/A

]([RS_SWCT_03190](#))

[TPS_SWCT_01578] AtomicSwComponentType requires the notification about a Service Request via diagnostic services with *supplier* characteristics [

The attribute `DiagnosticCommunicationManagerNeeds.serviceRequest-CallbackType` shall be set to the value `requestCallbackTypeSupplier`.

ServiceNeeds kind `DiagnosticCommunicationManagerNeeds`

RoleBasedPortAssignment valid roles:

- `ServiceRequestNotification` [1]

RoleBasedDataAssignment

N/A

RepresentedPortGroups

N/A

]([RS_SWCT_03190](#))

For more information please refer to [SWS_Dcm_00694]

13.8.4.11 Dcm Service Use Case: read/write and IOCtrl current values by Client Server Interface

Scenario: an `AtomicSwComponentType` offers a `PPortPrototype` typed by `ClientServerInterface` to read/write and IOCtrl current value via diagnostic services (e.g. measurements, variant coding)

[TPS_SWCT_01690] AtomicSwComponentType offers a `PPortPrototype` typed by `ClientServerInterface` to read/write and IOCtrl current value via diagnostic services [

ServiceNeeds kind `DiagnosticValueNeeds, DiagnosticIoControlNeeds`

RoleBasedPortAssignment valid roles:

- DataServices [1]

RoleBasedDataAssignment

N/A

RepresentedPortGroups

N/A

](RS_SWCT_00170, RS_SWCT_03190)

[TPS_SWCT_01691] Suffix used for the resulting name of the **PortInterface** for the **Data Services** [The suffix used for the resulting name of the **PortInterface** for the Data Services (DataServices_{Data}) shall be taken from the **shortName** of the **SwcServiceDependency** that aggregates the **DiagnosticIoControlNeeds**.] (RS_SWCT_00170, RS_SWCT_03190)

13.8.4.12 Dcm Service Use Case: A software-component acts as a "file server" to a diagnostic tester

Scenario: an **AtomicSwComponentType** acts as a "file server" to a diagnostic tester.

[TPS_SWCT_01791] **AtomicSwComponentType** acts as a "file server" to a diagnostic tester [

ServiceNeeds kind **DiagnosticRequestFileTransferNeeds**

RoleBasedPortAssignment valid roles:

- RequestFileTransfer [1]

RoleBasedDataAssignment

N/A

RepresentedPortGroups

N/A

](RS_SWCT_00170, RS_SWCT_03190)

Class	DiagnosticRequestFileTransferNeeds			
Package	M2::AUTOSARTemplates::CommonStructure::ServiceNeeds			
Note	This meta-class indicates the existence of a service use case that involves UDS service 0x38, Request File Transfer.			
Base	ARObject, DiagnosticCapabilityElement, Identifiable, MultilanguageReferrable, Referrable, ServiceNeeds			
Attribute	Type	Mult.	Kind	Note
-	-	-	-	-

Table 13.40: DiagnosticRequestFileTransferNeeds

13.8.5 OBD related Needs

The `ObdRatioServiceNeeds` describes further properties of the implementation of the Rate Based Monitoring (e.g. `connectionType`) as well as the logical dependencies relevant for the ECU configuration (e.g. `iumpGroup`)

Class	ObdRatioServiceNeeds			
Package	M2::AUTOSARTemplates::CommonStructure::ServiceNeeds			
Note	Specifies the abstract needs of a component or module on the configuration of OBD Services in relation to a particular "ratio monitoring" which is supported by this component or module.			
Base	<i>ARObject</i> , <i>DiagnosticCapabilityElement</i> , <i>Identifiable</i> , <i>MultilanguageReferrable</i> , <i>Referrable</i> , <i>ServiceNeeds</i>			
Attribute	Type	Mult.	Kind	Note
connectionType	ObdRatioConnectionKindEnum	1	attr	Defines how the DEM is connected to the component or module to perform the IUMPR (In use monitor performance ratio) service.
denominatorGroup	DiagnosticDenominatorConditionEnum	0..1	attr	The denominator Dem shall use to compute the ratio.
iumpGroup	NameToken	0..1	attr	Defines the IUMPR (In use monitor performance ratio) Group of the SAE standard. Note that possible values are not predefined by an enumeration meta-type in order to make the meta-model independent of the details of the SAE standard.
rateBasedMonitoredEvent	DiagnosticEventNeeds	1	ref	The rate based monitored Diagnostic Event.
usedFid	FunctionInhibitionNeeds	0..1	ref	This represents the primary Function Inhibition Identifier used for the rate based monitor. This is an optional attribute.
usedSecondaryFid	FunctionInhibitionNeeds	*	ref	This represents the secondary Function Inhibition Identifier used for the rate based monitor. This is an optional attribute. Any of the FID inhibitions leads to an inhibition of the IUMPR calculation

Table 13.41: ObdRatioServiceNeeds

The possible values for the attribute `ObdRatioServiceNeeds.iumpGroup` are:

- CAT1
- CAT2
- OXS1
- OXS2
- EGR
- SAIR
- EVAP
- SECOXS1
- SECOXS2
- NMHCCAT
- NOXCAT

- NOXADSORB
- PMFILTER
- EGSENSOR
- BOOSTPRS
- NOGROUP
- NONE

Enumeration	ObdRatioConnectionKindEnum
Package	M2::AUTOSARTemplates::CommonStructure::ServiceNeeds
Note	Defines the way how the IUMPR service connection between the Dem and the client component or module is handled (for details see the DEM Specification).
Literal	Description
apiUse	The IUMPR service (of the DEM) uses an explicit API to connect to the component or module. Tags: atp.EnumerationLiteralIndex=0
observer	The IUMPR service (of the Dem) uses no API but "observes" the associated diagnostic event. Tags: atp.EnumerationLiteralIndex=1

Table 13.42: ObdRatioConnectionKindEnum

In addition, [ObdPidServiceNeeds](#), [ObdInfoServiceNeeds](#), [ObdMonitorServiceNeeds](#) and [ObdControlServiceNeeds](#) are required in order to specify the specific needs for OBD diagnostic service calls. Note that [ObdPidServiceNeeds](#) is used for the Diagnostic Event Manager as well.

[constr_1520] Semantics of [ObdRatioServiceNeeds.rateBasedMonitoredEvent](#) [In the context of an [SwcServiceDependency](#), each [DiagnosticEventNeeds](#) referenced in the role [rateBasedMonitoredEvent](#) shall only be referenced by at most a single [ObdRatioServiceNeeds.](#)]()

Class	ObdControlServiceNeeds			
Package	M2::AUTOSARTemplates::CommonStructure::ServiceNeeds			
Note	Specifies the abstract needs of a component or module on the configuration of OBD Service 08 (request control of on-board system) in relation to a particular test-Identifier (TID) supported by this component or module.			
Base	ARObject , DiagnosticCapabilityElement , Identifiable , MultilanguageReferrable , Referrable , ServiceNeeds			
Attribute	Type	Mult.	Kind	Note
testId	PositiveInteger	0..1	attr	Test Identifier (TID) according to ISO 15031-5.

Table 13.43: ObdControlServiceNeeds

Class	ObdPidServiceNeeds			
Package	M2::AUTOSARTemplates::CommonStructure::ServiceNeeds			
Note	Specifies the abstract needs of a component or module on the configuration of OBD Services in relation to a particular PID (parameter identifier) which is supported by this component or module. In case of using a client/server communicated value, the related value shall be communicated via the port referenced by assignedPort. The details of this communication (e.g. appropriate naming conventions) are specified in the related software specifications (SWS).			
Base	ARObject, DiagnosticCapabilityElement , Identifiable , MultilanguageReferrable , Referrable , ServiceNeeds			
Attribute	Type	Mult.	Kind	Note
dataLength	PositiveInteger	0..1	attr	This attribute is applicable only if the ServiceNeeds is aggregated within BswModuleDependency. This attribute represents the length of data (in bytes) provided for this particular PID signal.
parameterId	PositiveInteger	0..1	attr	Standardized parameter identifier (PID) according to the OBD standard specified in attribute "standard".
standard	String	0..1	attr	Annotates the standard according to which the PID is given, e.g. "ISO15031-5" or "SAE J1979 Rev May 2007".

Table 13.44: ObdPidServiceNeeds

Class	ObdInfoServiceNeeds			
Package	M2::AUTOSARTemplates::CommonStructure::ServiceNeeds			
Note	Specifies the abstract needs of a component or module on the configuration of OBD Services in relation to a given InfoType (OBD Service 09) which is supported by this component or module.			
Base	ARObject, DiagnosticCapabilityElement , Identifiable , MultilanguageReferrable , Referrable , ServiceNeeds			
Attribute	Type	Mult.	Kind	Note
dataLength	PositiveInteger	0..1	attr	This attribute is applicable only if the ServiceNeeds is aggregated within BswModuleDependency. This attribute represents the length of data (in bytes) provided for this InfoType.
infoType	PositiveInteger	0..1	attr	The InfoType according to ISO 15031-5

Table 13.45: ObdInfoServiceNeeds

Class	ObdMonitorServiceNeeds			
Package	M2::AUTOSARTemplates::CommonStructure::ServiceNeeds			
Note	Specifies the abstract needs of a component or module on the configuration of OBD Services in relation to a particular on-board monitoring test supported by this component or module. (OBD Service 06).			
Base	ARObject, DiagnosticCapabilityElement , Identifiable , MultilanguageReferrable , Referrable , ServiceNeeds			
Attribute	Type	Mult.	Kind	Note
applicationDataType	ApplicationDataType	0..1	ref	reference to an ApplicationDataType that describes the scaling of the data reported by the software-component to the Dem.
eventNeeds	DiagnosticEventNeeds	0..1	ref	This reference identifies the corresponding diagnostic event.
onBoardMonitorId	PositiveInteger	0..1	attr	On-board monitor ID according to ISO 15031-5.





Class	ObdMonitorServiceNeeds			
testId	PositiveInteger	0..1	attr	Test Identifier (TID) according to ISO 15031-5.
unitAndScalingId	PositiveInteger	0..1	attr	Unit and scaling ID according to ISO 15031-5.
updateKind	DiagnosticMonitorUpdateKindEnum	0..1	attr	This attribute indicates the settings for the acceptance of updates.

Table 13.46: ObdMonitorServiceNeeds

Enumeration	DiagnosticMonitorUpdateKindEnum
Package	M2::AUTOSARTemplates::CommonStructure::ServiceNeeds
Note	This enumeration indicates the acceptance criteria for a diagnostic monitor.
Literal	Description
always	Dem shall accept every update. Tags: atp.EnumerationLiteralIndex=0
steady	Dem shall only accept if debouncing is at the limit. Tags: atp.EnumerationLiteralIndex=1

Table 13.47: DiagnosticMonitorUpdateKindEnum

13.8.5.1 Dem Service Use Case: In-Use-Monitor Performance Ratio calculation

Scenario: an [AtomicSwComponentType](#) implements a OBD system monitor with In-Use-Monitor Performance Ratio (IUMPR) and offers client ports to provide the capability to define the number of times a fault could have been found.

[TPS_SWCT_02007] [AtomicSwComponentType](#) implements a OBD system monitor with In-Use-Monitor Performance Ratio [

ServiceNeeds kind [ObdRatioServiceNeeds](#)

RoleBasedPortAssignment valid roles:

- IUMPRNumerator [0..1]
- IUMPRDenominator [0..1]

RoleBasedDataAssignment

N/A

RepresentedPortGroups

N/A

]([RS_SWCT_00170](#), [RS_SWCT_03190](#))

For more information please refer to [SWS_Dem_00610] and [SWS_Dem_00611].

[constr_2053] Consistency between role IUMPRNumerator and ObdRatioServiceNeeds.connectionType [If a `SwcServiceDependency` with a `ObdRatioServiceNeeds` is defined and the attribute `connectionType` of the contained `ObdRatioServiceNeeds` is set to `ObdRatioConnectionKindEnum.apiUse`, a `RoleBasedPortAssignment` with the `role` value `IUMPRNumerator` shall be defined.

If the attribute `connectionType` of the contained `ObdRatioServiceNeeds` is set to `ObdRatioConnectionKindEnum.observer`, the `role` value `IUMPRNumerator` is not applicable.]()

13.8.5.2 Dcm Service Use Case: read parameter identifier via diagnostic services by Client Server Interface

Scenario: an `AtomicSwComponentType` offers a server port to read/write current value via OBD services.

[TPS_SWCT_02008] AtomicSwComponentType offers a server port to read/write current value via OBD services [

ServiceNeeds kind `ObdPidServiceNeeds`

RoleBasedPortAssignment

The following roles are applicable:

- `DataServices` [1]

RoleBasedDataAssignment

N/A

RepresentedPortGroups

N/A

] ([RS_SWCT_00170](#), [RS_SWCT_03190](#))

[TPS_SWCT_01630] Suffix used for the resulting name of the PortInterface for the Data Services [The *suffix* used for the resulting name of the `PortInterface` for the Data Services (`DataServices_{Data}`) shall be taken from the `shortName` of the applicable `SwcServiceDependency`.] ([RS_SWCT_00170](#), [RS_SWCT_03190](#))

For more information please refer to [SWS_Dcm_00686].

13.8.5.3 Dcm Service Use Case: read parameter identifier via diagnostic services by Sender Receiver Interface

Scenario: an `AtomicSwComponentType` offers sender receiver ports to read/write current values via OBD services.

[TPS_SWCT_02009] **AtomicSwComponentType** offers sender receiver ports to read/write current values via OBD services [

ServiceNeeds kind `ObdPidServiceNeeds`

RoleBasedPortAssignment

N/A

RoleBasedDataAssignment

The following roles are applicable:

- `signalBasedDiagnostics` [1..2]

RepresentedPortGroups

N/A

To read the signal the `AtomicSwComponentType` shall offer an `AbstractProvidedPortPrototype`, to write the signal the `AtomicSwComponentType` shall offer an `AbstractRequiredPortPrototype`.] ([RS_SWCT_00170](#), [RS_SWCT_03190](#))

For more information please refer to [SWS_Dcm_00687].

Please note that [[constr_1679](#)] applies for this service use case.

13.8.5.4 Dcm Service Use Case: Request vehicle information

Scenario: an `AtomicSwComponentType` offers a server port to read vehicle information values via OBD services.

[TPS_SWCT_02010] **AtomicSwComponentType** offers a server port to read vehicle information values via OBD services [

ServiceNeeds kind `ObdInfoServiceNeeds`

RoleBasedPortAssignment valid roles:

- `InfotypeServices` [1]

RoleBasedDataAssignment

N/A

RepresentedPortGroups

N/A

] ([RS_SWCT_00170](#), [RS_SWCT_03190](#))

[TPS_SWCT_01631] **Suffix used for the resulting name of the PortInterface for the Infotype Services** [The *suffix* used for the resulting name of the `PortInterface` for the Infotype Services (`InfotypeServices_{VehInfoData}`) shall be taken from the `shortName` of the applicable `SwcServiceDependency`.] ([RS_SWCT_00170](#), [RS_SWCT_03190](#))

For more information please refer to [SWS_Dcm_00688].

13.8.5.5 Dem Service Use Case: Read DTR data from SW-C for OBD Service \$06

Scenario: an `AtomicSwComponentType` offers a server ports to read DTR value via OBD services.

[TPS_SWCT_02011] `AtomicSwComponentType` offers a server port to read DTR value via OBD services [

`ServiceNeeds` kind `ObdMonitorServiceNeeds`

`RoleBasedPortAssignment` valid roles:

- `DTRCentralReport` [1]

`RoleBasedDataAssignment`

N/A

`RepresentedPortGroups`

N/A

](`RS_SWCT_00170`, `RS_SWCT_03190`)

For more information please refer to [SWS_Dcm_00689].

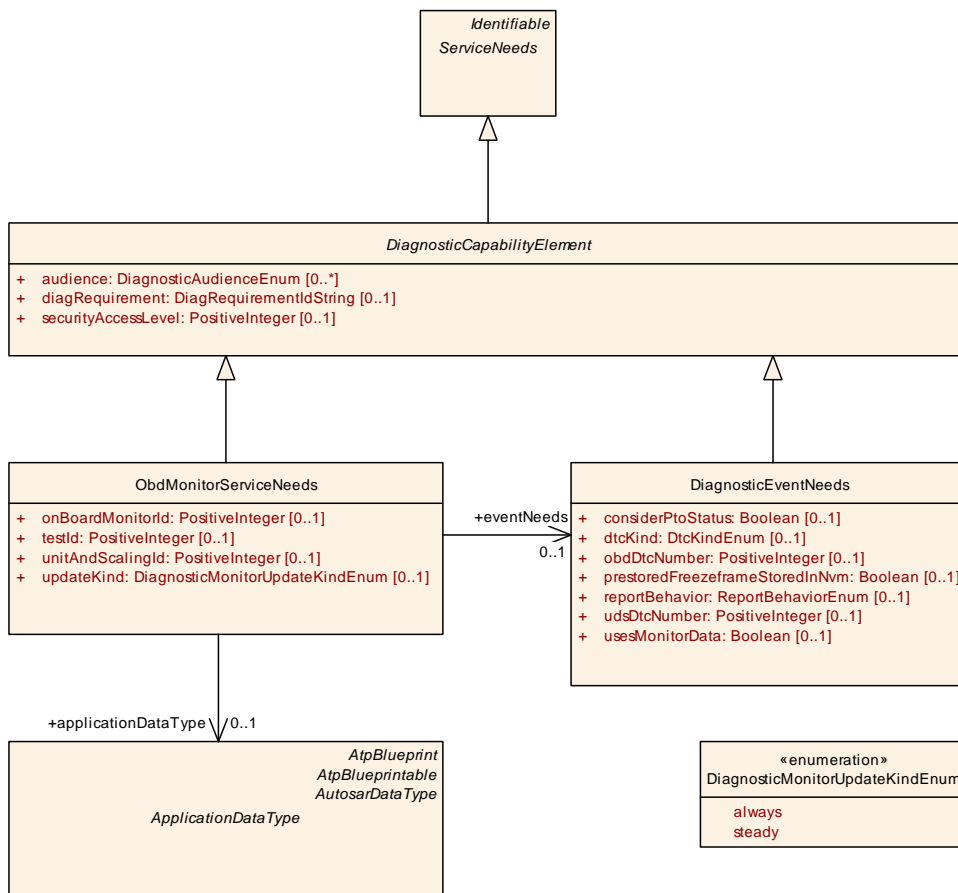

Figure 13.9: Modeling of `ObdMonitorServiceNeeds`

13.8.5.6 Dcm Service Use Case: request control of on-board system, test or component

Scenario: an [AtomicSwComponentType](#) offers a server port for request control of on-board system, test or component via OBD services.

[TPS_SWCT_02012] [AtomicSwComponentType](#) offers a server port for request control of on-board system, test or component via OBD services [

ServiceNeeds kind [ObdControlServiceNeeds](#)

RoleBasedPortAssignment

The following roles are applicable:

- [RequestControlServices](#) [1]

RoleBasedDataAssignment

N/A

RepresentedPortGroups

N/A

] ([RS_SWCT_00170](#), [RS_SWCT_03190](#))

[TPS_SWCT_01633] Suffix used for the resulting name of the [PortInterface](#) for the Request Control Services [The *suffix* used for the resulting name of the [PortInterface](#) for the Request Control Services ([RequestControlServices_{Tid}](#)) shall be taken from the *shortName* of the applicable [SwcServiceDependency](#).] ([RS_SWCT_00170](#), [RS_SWCT_03190](#))

For more information please refer to [SWS_Dcm_00691].

13.8.5.7 Dem Service Use Case: In-Use-Monitoring Performance Ratio Denominator interface

Scenario: an [AtomicSwComponentType](#) implements a denominator (or accesses a ratio for transmission to other control units).

[TPS_SWCT_01765] Dem Service Use Case: In-Use-Monitoring Performance Ratio Denominator interface [

ServiceNeeds kind [ObdRatioDenominatorNeeds](#)

RoleBasedPortAssignment

The following roles are applicable:

- [IUMPRDenominatorCondition](#) [1]

RoleBasedDataAssignment

N/A

RepresentedPortGroups

N/A

|(RS_SWCT_00170, RS_SWCT_03190)

For more information please refer to [SWS_Dem_00742].

Class	ObdRatioDenominatorNeeds			
Package	M2::AUTOSARTemplates::CommonStructure::ServiceNeeds			
Note	This meta-class shall be used to indicate that a software-component wants to access the in-use-monitoring performance ration denominator.			
Base	ARObject, DiagnosticCapabilityElement , Identifiable , MultilanguageReferrable , Referrable , ServiceNeeds			
Attribute	Type	Mult.	Kind	Note
denominator Condition	DiagnosticDenominatorConditionEnum	0..1	attr	This attribute indicates the applicable denominator condition.

Table 13.48: ObdRatioDenominatorNeeds

Enumeration	DiagnosticDenominatorConditionEnum
Package	M2::AUTOSARTemplates::CommonStructure::ServiceNeeds
Note	This enumeration contains valid denominator types.
Literal	Description
_500miles	Condition based on definition of 500miles conditions as defined for OBD2. Tags: atp.EnumerationLiteralIndex=2
coldstart	Condition based on definition of "cold start" as defined for EU5+ Tags: atp.EnumerationLiteralIndex=0
evap	Condition based on definition of "EVAP" conditions as defined for OBD2. Tags: atp.EnumerationLiteralIndex=1
individual	condition based on definition of individual requirements. Tags: atp.EnumerationLiteralIndex=3
obd	Condition based on definition of OBD requirements. Tags: atp.EnumerationLiteralIndex=4

Table 13.49: DiagnosticDenominatorConditionEnum

13.8.6 Diagnostics over IP

This chapter describes the usage of specific meta-classes to support the specification of diagnostics over IP. For more details, please refer to ISO 13400 [41].

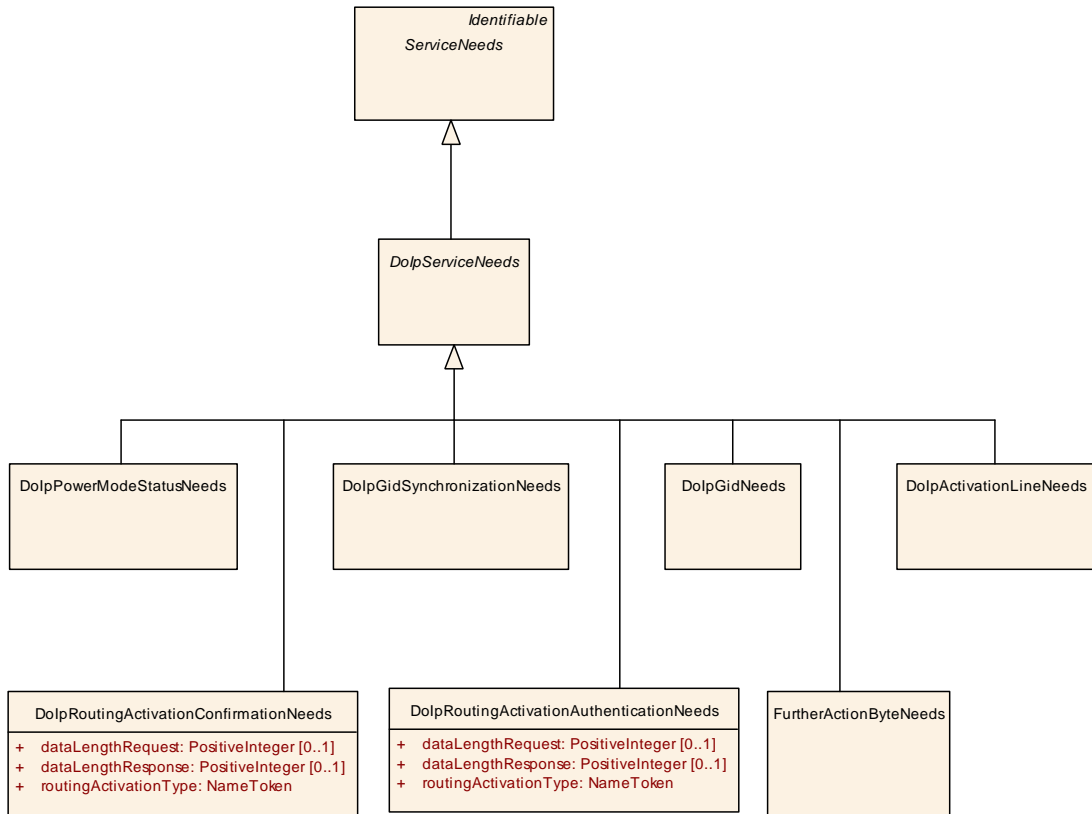

Figure 13.10: Subclasses of **ServiceNeeds** for implementing diagnostics over IP

Class	<i>DolpServiceNeeds</i> (abstract)			
Package	M2::AUTOSARTemplates::CommonStructure::ServiceNeeds			
Note	This represents an abstract base class for ServiceNeeds related to DoIP.			
Base	<i>ARObject</i> , <i>Identifiable</i> , <i>MultilanguageReferrable</i> , <i>Referrable</i> , <i>ServiceNeeds</i>			
Subclasses	<i>DolpActivationLineNeeds</i> , <i>DolpGidNeeds</i> , <i>DolpGidSynchronizationNeeds</i> , <i>DolpPowerModeStatusNeeds</i> , <i>DolpRoutingActivationAuthenticationNeeds</i> , <i>DolpRoutingActivationConfirmationNeeds</i> , <i>FurtherActionByteNeeds</i>			
Attribute	Type	Mult.	Kind	Note
–	–	–	–	–

Table 13.50: **DolpServiceNeeds**

Class	DolpGidNeeds			
Package	M2::AUTOSARTemplates::CommonStructure::ServiceNeeds			
Note	The DolpGidNeeds indicates that the software-component owning this ServiceNeeds is providing the GID number either after a GID Synchronisation or by other means like e.g. flashed EEPROM parameter. This need can be used independent from DolpGidSynchronizationNeeds and is necessary if the GID can not be provided out of the DoIP configuration options.			
Base	<i>ARObject</i> , <i>DolpServiceNeeds</i> , <i>Identifiable</i> , <i>MultilanguageReferrable</i> , <i>Referrable</i> , <i>ServiceNeeds</i>			
Attribute	Type	Mult.	Kind	Note
–	–	–	–	–





Class	DolpGidNeeds			
–	–	–	–	–

Table 13.51: DolpGidNeeds

Class	DolpGidSynchronizationNeeds			
Package	M2::AUTOSARTemplates::CommonStructure::ServiceNeeds			
Note	The DolpGidSynchronizationNeeds indicates that the software-component owning this ServiceNeeds is triggered by the DoIP entity to start a synchronization of the GID (Group Identification) on the DoIP service 0x0001, 0x0002, 0x0003 or before announcement via service 0x0004 according to ISO 13400-2:2012 if necessary. Note that this need is only relevant for DoIP synchronization masters.			
Base	<i>ARObject, DolpServiceNeeds, Identifiable, MultilanguageReferrable, Referrable, ServiceNeeds</i>			
Attribute	Type	Mult.	Kind	Note
–	–	–	–	–

Table 13.52: DolpGidSynchronizationNeeds

Class	DolpPowerModeStatusNeeds			
Package	M2::AUTOSARTemplates::CommonStructure::ServiceNeeds			
Note	The DolpPowerModeStatusNeeds indicates that the software-component owning this ServiceNeeds is providing the PowerModeStatus for the DoIP service 0x4003 according to ISO 13400-2:2012.			
Base	<i>ARObject, DolpServiceNeeds, Identifiable, MultilanguageReferrable, Referrable, ServiceNeeds</i>			
Attribute	Type	Mult.	Kind	Note
–	–	–	–	–

Table 13.53: DolpPowerModeStatusNeeds

Class	DolpRoutingActivationAuthenticationNeeds			
Package	M2::AUTOSARTemplates::CommonStructure::ServiceNeeds			
Note	DoIPRoutingActivationAuthenticationNeeds indicates that the software-component owning this Service Needs will have an authentication required for a DoIP routing activation service (0x0005) according to ISO 13400-2:2012.			
Base	<i>ARObject, DolpServiceNeeds, Identifiable, MultilanguageReferrable, Referrable, ServiceNeeds</i>			
Attribute	Type	Mult.	Kind	Note
dataLength Request	PositiveInteger	0..1	attr	Describes the length in byte of the additional information for RA authentication that is needed by the software entity. If the software entity is a software-component the attribute does not need to exist as the information is available via the length of the uint8 Array type. Otherwise (i.e the software entity is a Complex Driver) this attribute needs to be filled out if additional information is needed.
dataLength Response	PositiveInteger	0..1	attr	Describes the length in byte of the additional information for RA authentication that is provided by the software entity. If the software entity is a software-component the attribute does not need to exist as the information is available via the length of the uint8 Array type. Otherwise (i.e the software entity is a Complex Driver) this attribute needs to be filled in if additional information is provided.





Class		DolpRoutingActivationAuthenticationNeeds		
routing ActivationType	NameToken	1	attr	Describes the ISO 13400-2:2012 "routing activation request activation type" which is received via DoIP service 0x0005. 0x00 is DEFAULT, 0x01 is WWH-OBD. If neither of the specified values (0x00 or 0x01) is needed the token shall contain RA_ + hex value representation of the integer value shall be used (i.e: RA_0xE1).

Table 13.54: DolpRoutingActivationAuthenticationNeeds

Class		DolpRoutingActivationConfirmationNeeds		
Package		M2::AUTOSARTemplates::CommonStructure::ServiceNeeds		
Note		DolpRoutingActivationConfirmationNeeds indicates that the software-component that owns this Service Needs will have a confirmation required for a DoIP routing activation service (0x0005) according to ISO 13400-2:2012.		
Base		<i>ARObject, DolpServiceNeeds, Identifiable, MultilanguageReferrable, Referrable, ServiceNeeds</i>		
Attribute	Type	Mult.	Kind	Note
dataLength Request	PositiveInteger	0..1	attr	Describes the length in byte of the additional information for RA confirmation that is needed by the software entity. If the software entity is a software-component the attribute does not need to exist as the information is available via the length of the uint8 Array type. Otherwise (i.e the software entity is a Complex Driver) this attribute needs to be filled out if additional information is needed.
dataLength Response	PositiveInteger	0..1	attr	Describes the length in byte of the additional information for RA confirmation that is provided by the software entity. If the software entity is a software-component the attribute does not need to exist as the information is available via the length of the uint8 Array type. Otherwise (i.e the software entity is a Complex Driver) this attribute needs to be filled out if additional information is provided.
routing ActivationType	NameToken	1	attr	Describes the ISO 13400-2:2012 "routing activation request activation type" which is received via DoIP service 0x0005. 0x00 is DEFAULT, 0x01 is WWH-OBD. If neither of the specified values (0x00 or 0x01) is needed the token shall contain RA_ + hex value representation of the integer value shall be used (i.e: RA_0xE1).

Table 13.55: DolpRoutingActivationConfirmationNeeds

Class		DolpActivationLineNeeds		
Package		M2::AUTOSARTemplates::CommonStructure::ServiceNeeds		
Note		A DoIP entity needs to be informed when an external tester is attached or activated. The DolpActivation ServiceNeeds specifies the trigger for such an event. Examples would be a Pdu via a regular communication bus, a PWM signal, or an I/O. For details please refer to the ISO 13400.		
Base		<i>ARObject, DolpServiceNeeds, Identifiable, MultilanguageReferrable, Referrable, ServiceNeeds</i>		
Attribute	Type	Mult.	Kind	Note
–	–	–	–	–

Table 13.56: DolpActivationLineNeeds

13.8.6.1 DoIP Service Use Case: GID synchronization can be necessary if the ECU is DoIP Gid synchronization master

Scenario: on the event of connecting a tester to an ECU a GID synchronization can be necessary if the ECU is DoIP Gid synchronization master. In this case, it is necessary to define a [DoIpGidSynchronizationNeeds](#).

[TPS_SWCT_01537] GID synchronization can be necessary if the ECU is DoIP Gid synchronization master [

ServiceNeeds kind [DoIpGidSynchronizationNeeds](#)

RoleBasedPortAssignment valid roles:

- [CallbackTriggerGIDSynchronization](#) [1]

RoleBasedDataAssignment

N/A

RepresentedPortGroups

N/A

]([RS_SWCT_03310](#), [RS_SWCT_03190](#))

13.8.6.2 DoIP Service Use Case: Vehicle information is broadcast or can be requested by the tester

Scenario: vehicle information is broadcast or can be requested by the tester. In this case, it is necessary to define a [DoIpGidNeeds](#).

[TPS_SWCT_01538] Vehicle information is broadcast or can be requested by the tester [

ServiceNeeds kind [DoIpGidNeeds](#)

RoleBasedPortAssignment valid roles:

- [CallbackGetGID](#) [1]

RoleBasedDataAssignment

N/A

RepresentedPortGroups

N/A

]([RS_SWCT_03310](#), [RS_SWCT_03190](#))

13.8.6.3 DoIP Service Use Case: Tester could also request the power status with respect to diagnostics

Scenario: before starting the diagnostics processing for the DoIP entity or sub-networks connected via DoIP, the tester could also request the power status with respect to diagnostics. To support this option it will be necessary to define a `DoIpPowerModeStatusNeeds`.

[TPS_SWCT_01539] Tester can also request before starting diagnostic processing for the DoIP entity or sub-networks connected via DoIP the power status with respect to diagnostics [

ServiceNeeds kind `DoIpPowerModeStatusNeeds`

RoleBasedPortAssignment valid roles:

- `CallbackGetPowerMode` [1]

RoleBasedDataAssignment

N/A

RepresentedPortGroups

N/A

]([RS_SWCT_03310](#), [RS_SWCT_03190](#))

13.8.6.4 DoIP Service Use Case: Routing activation mechanism is used which can lead to additional impact regarding authentication or confirmation

Scenario: to enable diagnostics of the tester to a different target address, the routing activation mechanism is used which can lead to additional impact regarding authentication or confirmation. Here, the definition of `DoIpRoutingActivationAuthenticationNeeds` and/or `DoIpRoutingActivationConfirmationNeeds` would be applicable.

[TPS_SWCT_01544] *prefix* used for the actual name of the used `PortInterface` for the routing activation [The *prefix* used for the actual name of the used `PortInterface` for the routing activation shall be taken from the `shortName` of the enclosing `SwcServiceDependency`.]([RS_SWCT_03310](#), [RS_SWCT_03190](#))

[TPS_SWCT_01540] Routing activation mechanism is used which can lead to additional impact regarding authentication or confirmation [

ServiceNeeds kind

- `DoIpRoutingActivationAuthenticationNeeds` [0..1]
- `DoIpRoutingActivationConfirmationNeeds` [0..1]

RoleBasedPortAssignment valid roles:

- RoutingActivation [1]

RoleBasedDataAssignment

N/A

RepresentedPortGroups

N/A

|(RS_SWCT_03190)

13.8.6.5 DoIP Service Use Case: a DoIP entity needs to be informed when an external tester is attached or activated.

Scenario: to enable diagnostics by connecting a tester to an ECU it is necessary that the application software becomes aware of the tester's presence.

For this purpose, the applicable `ServiceSwComponentType` is supposed to provide a `PPortPrototype` typed by the `ModeSwitchInterface` named `DoIPActivationLineStatus` towards the application.

To trigger the existence of the `PPortPrototype`, `DoIpActivationLineNeeds` shall be defined.

[TPS_SWCT_01546] Notification when an external tester is attached or activated

|

ServiceNeeds kind `DoIpActivationLineNeeds`

RoleBasedPortAssignment valid roles:

- DoIPActivationLineStatus [1]

RoleBasedDataAssignment

N/A

RepresentedPortGroups

N/A

|(RS_SWCT_03310, RS_SWCT_03190)

13.8.6.6 Service Use Case: Set and reset Warning Indicator Request bit

Scenario: In some cases (e.g. controlling a failsafe reaction in application) the "Warning Indicator Request"-bit of a corresponding event in Dem shall be set/reset by a special "failsafe software-component".

The failsafe software-component has to ensure a proper status of the "Warning Indicator Request"-bit (e.g. regarding ISO14229-1 or manufacture specific requirements).

Therefore, the failsafe SW-C can use existing Dem mechanism to get the information about status changes of events in Dem (e.g. Callback EventStatusChanged).

For this purpose, the applicable `ServiceSwComponentType` is supposed to provide a `PPortPrototype` typed by the `ClientServerInterface` named `EventStatus` towards the application.

To trigger the existence of the `PPortPrototype`, `WarningIndicatorRequestedBitNeeds` shall be defined.

[TPS_SWCT_01547] Ability to set and reset the Warning Indicator Request bit [

ServiceNeeds kind `WarningIndicatorRequestedBitNeeds`

RoleBasedPortAssignment valid roles:

- `EventStatus` [1]

RoleBasedDataAssignment

N/A

RepresentedPortGroups

N/A

]([RS_SWCT_03310](#), [RS_SWCT_03190](#))

Class	<code>WarningIndicatorRequestedBitNeeds</code>			
Package	M2::AUTOSARTemplates::CommonStructure::ServiceNeeds			
Note	This meta-class represents the ability to explicitly request the existence of the WarningIndicatorRequestedBit.			
Base	<code>ARObject</code> , <code>DiagnosticCapabilityElement</code> , <code>Identifiable</code> , <code>MultilanguageReferrable</code> , <code>Referrable</code> , <code>ServiceNeeds</code>			
Attribute	Type	Mult.	Kind	Note
-	-	-	-	-

Table 13.57: WarningIndicatorRequestedBitNeeds

13.8.6.7 DoIP Service Use Case: Atomic Software-Component provides the further action byte to the DoIP Service Component

Scenario: An `AtomicSwComponentType` provides the "further action byte" used in vehicle identification/announcement message.

[TPS_SWCT_01746] Atomic Software-Component provides the further action byte to the DoIP Service Component [

ServiceNeeds kind `FurtherActionByteNeeds`

RoleBasedPortAssignment valid roles:

- `CallbackGetFurtherActionByte` [1]

RoleBasedDataAssignment

N/A

RepresentedPortGroups

N/A

|(RS_SWCT_03310, RS_SWCT_03190)

Class	FurtherActionByteNeeds			
Package	M2::AUTOSARTemplates::CommonStructure::ServiceNeeds			
Note	The FurtherActionByteNeeds indicates that the software-component is able to provide the "further action byte" to the Dolp Service Component.			
Base	ARObject, DolpServiceNeeds, Identifiable, MultilanguageReferrable, Referrable, ServiceNeeds			
Attribute	Type	Mult.	Kind	Note
-	-	-	-	-

Table 13.58: FurtherActionByteNeeds

13.8.7 Miscellaneous Diagnostic Service Use-Cases

13.8.7.1 Dcm Service Use Case: DiagnosticSessionControl

Scenario: an AtomicSwComponentType offers an RPortPrototype typed by a ModeSwitchInterface to get informed about the diagnostic session.

[TPS_SWCT_01706] AtomicSwComponentType supports DiagnosticSessionControl to get informed about the diagnostic session [

ServiceNeeds kind DiagnosticControlNeeds

RoleBasedPortAssignment valid roles:

- Dcm_DiagnosticSessionControlModeSwitchInterface [1]

RoleBasedDataAssignment

N/A

RepresentedPortGroups

N/A

The role Dcm_DiagnosticSessionControlModeSwitchInterface is applicable for an RPortPrototype typed by a ModeSwitchInterface. |(RS_SWCT_00170, RS_SWCT_03190)

Class	DiagnosticControlNeeds			
Package	M2::AUTOSARTemplates::CommonStructure::ServiceNeeds			
Note	This meta-class indicates a service use-case for reporting the controlled status by diagnostic services.			
Base	<i>ARObject</i> , <i>DiagnosticCapabilityElement</i> , <i>Identifiable</i> , <i>MultilanguageReferrable</i> , <i>Referrable</i> , <i>ServiceNeeds</i>			
Attribute	Type	Mult.	Kind	Note
–	–	–	–	–

Table 13.59: DiagnosticControlNeeds

13.8.7.2 Dcm Service Use Case: EcuReset

Scenario: an *AtomicSwComponentType* offers an *RPortPrototype* typed by a *ModeSwitchInterface* to get informed about the current status of *EcuReset* service.

[TPS_SWCT_01707] *AtomicSwComponentType* supports *EcuReset* service via diagnostic services [

ServiceNeeds kind *DiagnosticControlNeeds*

RoleBasedPortAssignment valid roles:

- *Dcm_EcuResetModeSwitchInterface* [1]

RoleBasedDataAssignment

N/A

RepresentedPortGroups

N/A

The role *Dcm_EcuResetModeSwitchInterface* is applicable for an *RPortPrototype* typed by a *ModeSwitchInterface*.] (*RS_SWCT_00170*, *RS_SWCT_03190*)

13.8.7.3 Dcm Service Use Case: EcuReset ModeRapidPowerShutDown

Scenario: an *AtomicSwComponentType* offers an *RPortPrototype* typed by a *ModeSwitchInterface* to get informed about the current status of the *EcuReset ModeRapidPowerShutDown* service.

[TPS_SWCT_01708] *AtomicSwComponentType* supports *EcuReset ModeRapidPowerShutDown* service via diagnostic services [

ServiceNeeds kind *DiagnosticControlNeeds*

RoleBasedPortAssignment valid roles:

- *Dcm_ModeRapidPowerShutDownModeSwitchInterface* [1]

RoleBasedDataAssignment

N/A

RepresentedPortGroups

N/A

The role `Dcm_ModeRapidPowerShutDownModeSwitchInterface` is applicable for an `RPortPrototype` typed by a `ModeSwitchInterface`.] ([RS_SWCT_00170](#), [RS_SWCT_03190](#))

13.8.7.4 Dcm Service Use Case: CommunicationControl

Scenario: an `AtomicSwComponentType` offers an `RPortPrototype` typed by a `ModeSwitchInterface` to get informed about the current status of the *CommunicationControl* service per ComM Channel.

[TPS_SWCT_01709] `AtomicSwComponentType` supports *CommunicationControl* service via diagnostic services [

ServiceNeeds kind `DiagnosticControlNeeds`

RoleBasedPortAssignment valid roles:

- `Dcm_CommunicationControlModeSwitchInterface` [1]

RoleBasedDataAssignment

N/A

RepresentedPortGroups

N/A

The role `Dcm_CommunicationControl` is applicable for an `RPortPrototype` typed by a `ModeSwitchInterface`.] ([RS_SWCT_00170](#), [RS_SWCT_03190](#))

13.8.7.5 Dcm Service Use Case: ControlDTCSetting

Scenario: an `AtomicSwComponentType` offers an `RPortPrototype` typed by a `ModeSwitchInterface` to get informed about the current status of the *ControlDTCSetting* service.

[TPS_SWCT_01711] `AtomicSwComponentType` supports *ControlDTCSetting* service via diagnostic services [

ServiceNeeds kind `DiagnosticControlNeeds`

RoleBasedPortAssignment valid roles:

- `Dcm_ControlDTCSettingModeSwitchInterface` [1]

RoleBasedDataAssignment

N/A

RepresentedPortGroups

N/A

The role `Dcm_ControlDTCSettingModeSwitchInterface` is applicable for an `RPortPrototype` typed by a `ModeSwitchInterface`.] ([RS_SWCT_00170](#), [RS_SWCT_03190](#))

13.8.7.6 Dcm Service Use Case: Response On Event via diagnostic services

Scenario: an `AtomicSwComponentType` offers a `PPortPrototype` typed by a `ClientServerInterface` as well as an `RPortPrototype` typed by a `ModeSwitchInterface` to support `onChangeOfDataIdentifier Response On Event` (ROE) via diagnostic services.

[TPS_SWCT_02014] `AtomicSwComponentType` supports Response On Event (ROE) via diagnostic services [

ServiceNeeds kind `DiagnosticResponseOnEventNeeds`

RoleBasedPortAssignment valid roles:

- `Dcm_Roe` [1]
- `Dcm_ResponseOnEventModeSwitchInterface` [1]

RoleBasedDataAssignment

N/A

RepresentedPortGroups

N/A

The role `Dcm_ResponseOnEventModeSwitchInterface` is applicable for an `RPortPrototype` typed by a `ModeSwitchInterface` and the role `Dcm_Roe` is applicable for an `PPortPrototype` typed by a `ClientServerInterface`.] ([RS_SWCT_00170](#), [RS_SWCT_03190](#))

Class	DiagnosticResponseOnEventNeeds			
Package	M2::AUTOSARTemplates::CommonStructure::ServiceNeeds			
Note	This meta-class indicates a service use-case for the diagnostic service ResponseOnEvent.			
Base	<code>ARObject</code> , <code>DiagnosticCapabilityElement</code> , <code>Identifiable</code> , <code>MultilanguageReferrable</code> , <code>Referrable</code> , <code>ServiceNeeds</code>			
Attribute	Type	Mult.	Kind	Note
-	-	-	-	-

Table 13.60: DiagnosticResponseOnEventNeeds

13.8.7.7 Dcm Service Use Case: SecurityAccess

Scenario: an [AtomicSwComponentType](#) offers an [RPortPrototype](#) typed by a [ModeSwitchInterface](#) to get informed about the current diagnostic security level.

[TPS_SWCT_01712] [AtomicSwComponentType](#) supports **SecurityAccess** to get informed about the security level [

ServiceNeeds kind [DiagnosticControlNeeds](#)

RoleBasedPortAssignment valid roles:

- [Dcm_SecurityAccessModeSwitchInterface](#) [1]

RoleBasedDataAssignment

N/A

RepresentedPortGroups

N/A

The role [Dcm_SecurityAccessModeSwitchInterface](#) is applicable for an [RPortPrototype](#) typed by a [ModeSwitchInterface](#).]([RS_SWCT_00170](#), [RS_SWCT_03190](#))

13.8.7.8 Service Use Case: Atomic Software-Component implements a Hardware Shutdown

Scenario: if a hardware component is detected as being defective, the Dem shall inform the [SwComponentPrototype](#) typed by an [AtomicSwComponentType](#) which is responsible for executing a hardware-shutdown.

[TPS_SWCT_01680] Dem Use Case: Atomic Software-Component implements a Hardware Shutdown [

ServiceNeeds kind [DiagnosticComponentNeeds](#)

RoleBasedPortAssignment valid roles:

- [CallbackComponentStatusChanged](#) [1]

RoleBasedDataAssignment

N/A

RepresentedPortGroups

N/A

] ([RS_SWCT_03190](#))

Class	DiagnosticComponentNeeds			
Package	M2::AUTOSARTemplates::CommonStructure::ServiceNeeds			
Note	This meta-class represents the ability to specify the service needs for the configuration of component events.			
Base	<i>ARObject</i> , <i>DiagnosticCapabilityElement</i> , <i>Identifiable</i> , <i>MultilanguageReferrable</i> , <i>Referrable</i> , <i>ServiceNeeds</i>			
Attribute	Type	Mult.	Kind	Note
–	–	–	–	–

Table 13.61: DiagnosticComponentNeeds

13.8.7.9 Service Use Case: Upload and download of data

Scenario: a software-component implements the ability to accept data for upload and/or provide data for download. For this purpose the software-component provides a *PPortPrototype* that is supposed to be connected to the Dcm service component.

[TPS_SWCT_01769] Dcm Use Case: Upload and download of data [

ServiceNeeds kind *DiagnosticUploadDownloadNeeds*

RoleBasedPortAssignment valid roles:

- *UploadDownloadServices* [1]

RoleBasedDataAssignment

N/A

RepresentedPortGroups

N/A

](*RS_SWCT_03190*)

Class	DiagnosticUploadDownloadNeeds			
Package	M2::AUTOSARTemplates::CommonStructure::ServiceNeeds			
Note	This meta-class represents the ability to specify needs regarding upload and download by means of diagnostic services.			
Base	<i>ARObject</i> , <i>DiagnosticCapabilityElement</i> , <i>Identifiable</i> , <i>MultilanguageReferrable</i> , <i>Referrable</i> , <i>ServiceNeeds</i>			
Attribute	Type	Mult.	Kind	Note
–	–	–	–	–

Table 13.62: DiagnosticUploadDownloadNeeds

13.9 Diagnostic Log and Trace Dependency

The meta-class [DltUserNeeds](#) is used together with the [SwcServiceDependency](#) to define requirements in order to configure the Diagnostic Log and Trace module (for the terms related to the AUTOSAR Specification of Module DLT see [42]).

Class	DltUserNeeds			
Package	M2::AUTOSARTemplates::CommonStructure::ServiceNeeds			
Note	<p>This meta-class specifies the needs on the configuration of the Diagnostic Log and Trace module for one SessionId.</p> <p>This class currently contains no attributes.</p> <p>An instance of this class is used to find out which PortPrototypes of an AtomicSwComponentType belong to this SessionId in order to group the request and response PortPrototypes of the same SessionId.</p> <p>The actual SessionId value is stored in the PortDefinedArgumentValue of the respective PortPrototype specification.</p>			
Base	<i>ARObject</i> , <i>Identifiable</i> , <i>MultilanguageReferrable</i> , <i>Referrable</i> , <i>ServiceNeeds</i>			
Attribute	Type	Mult.	Kind	Note
–	–	–	–	–

Table 13.63: DltUserNeeds

Please note that for the described use case of the Dlt Service the following rule applies: For every used [ClientServerInterface](#) it is necessary to create a [RoleBasedPortAssignment](#).

Thereby the value of the attribute [role](#) of the [RoleBasedPortAssignment](#) has to be set to the name of the used standardized [ClientServerInterface](#).

The possible role attribute values and the multiplicity of the related [PortPrototypes](#) are listed at the use case descriptions in the paragraph **RoleBasedPortAssignment**.

13.9.1 Dlt use Case:Application software component transmits debug information

Scenario: [AtomicSwComponentType](#) sends log messages. In this case the following setup applies:

[TPS_SWCT_02506] Setup for Dlt use Case: Application software component accesses the Dlt module [

ServiceNeeds kind : [DltUserNeeds](#)

RoleBasedPortAssignment valid roles:

- [DltControlService](#) [1]
- [LogTraceSessionControl](#) [1]
- [InjectionCallback](#) [0..1]
- [DltSwcMessageService](#) [0..1]

RoleBasedDataAssignment

N/A

RepresentedPortGroups

N/A

]()

For more information please refer to [SWS_DIt_00495], [SWS_DIt_00496], and [SWS_DIt_00498].

In this case the software-component has to provide one Client Port (DLTService) in order to register and unregister the context and to send log or trace messages.

13.10 Synchronized Time-Base Manager Dependency

The meta-class `SyncTimeBaseMgrUserNeeds` is used together with the `SwcServiceDependency` to define requirements in order to configure the Synchronized Time-Base Manager module (for the terms related to the AUTOSAR Specification of Module `StbM` see [43]).

Class	SyncTimeBaseMgrUserNeeds			
Package	M2::AUTOSARTemplates::CommonStructure::ServiceNeeds			
Note	Specifies the needs on the configuration of the Synchronized Time-base Manager for one time-base. This class currently contains no attributes. An instance of this class is used to find out which ports of a software-component belong to this time-base in order to group the request and response ports of the same time-base. The actual time-base value is stored in the <code>PortDefinedArgumentValue</code> of the respective port specification.			
Base	<code>ARObject</code> , <code>Identifiable</code> , <code>MultilanguageReferrable</code> , <code>Referrable</code> , <code>ServiceNeeds</code>			
Attribute	Type	Mult.	Kind	Note
-	-	-	-	-

Table 13.64: SyncTimeBaseMgrUserNeeds

Please note that for the described use cases of the `StbM` Service following rule applies:

For every used `ClientServerInterface` it is necessary to create a `RoleBasedPortAssignment`.

Thereby the value of the attribute `role` of the `RoleBasedPortAssignment` has to be set to the name of the used standardized `ClientServerInterface`.

The possible role attribute values and the multiplicity of the related `PortPrototypes` are listed at the use case descriptions in the paragraph **RoleBasedPortAssignment**.

The general idea behind the time synchronization concept is that the role of global time master and global time slave are partly implemented in the application software.

For this purpose, the application software provides `PortPrototypes` typed by the standardized `PortInterfaces` `GlobalTime_Master` and `GlobalTime_Slave`.

In many cases both `PortInterfaces` `GlobalTime_Master` and `GlobalTime_Slave` will be used by the application software of one ECU. This means that the ECU is a global time slave on one domain and a global time master on another domain.

In terms of modeling, a given global time domain is represented by a `SwcServiceDependency`.

If one software-component has to deal with different global time domains (e.g. because it represents a slave in one domain and a master in another) then the corresponding `SwcInternalBehavior` needs to define one `SwcServiceDependency` per global time domain.

13.10.1 StbM Use Case: start timer and potentially get notified about its expiration

Scenario: a software-component wants to wind up a timer in the `StbM` with a given expiration time. The software-component may want to receive a notification when the timer expires. In this case the following setup applies:

[TPS_SWCT_01678] StbM use Case: start timer and potentially get notified about its expiration [

ServiceNeeds Kind : `SyncTimeBaseMgrUserNeeds`

RoleBasedPortAssignment valid roles:

- `StartTimer` [1]
- `TimeNotification` [0..1]

RoleBasedDataAssignment

N/A

RoleBasedDataTypeAssignment

N/A

RepresentedPortGroups

N/A

]()

In this case the software-component needs to have an `RPortPrototype` typed by the `ClientServerInterface` `StartTimer` and (if applicable) a `PPortPrototype` typed by the `ClientServerInterface` `TimeNotification`.

13.10.2 StbM Use Case: Software-Components wants to get notifications of status changes

Scenario: a software-component wants to receive events whenever the status of the `StbM` changes. For this purpose, the software-component sports a sender/receiver `RPortPrototype`. In this case the following setup applies:

[TPS_SWCT_01679] StbM use Case: Software-Components wants to get notifications of status changes [

ServiceNeeds Kind : `SyncTimeBaseMgrUserNeeds`

RoleBasedPortAssignment valid roles:

- `StatusNotification` [1]

RoleBasedDataAssignment

N/A

RoleBasedDataTypeAssignment

N/A

RepresentedPortGroups

N/A

]()

The events received from the `StbM` have a fixed structure. For more details, please refer to [SWS_StbM_00284].

13.10.3 StbM Use Case: Process time snapshot obtained from global time slave for diagnostics purposes

Scenario: a software-component provides a `PPortPrototype` onto which the global time slave pushes snapshots of time synchronization records. This data is typically used for diagnostic purposes.

[TPS_SWCT_01740] StbM use Case: Process time snapshot obtained from global time slave for diagnostics purposes [

ServiceNeeds Kind : `SyncTimeBaseMgrUserNeeds`

RoleBasedPortAssignment valid roles:

- `MeasurementNotification` [1]

RoleBasedDataAssignment

N/A

RoleBasedDataTypeAssignment

N/A

RepresentedPortGroups

N/A

]()

Note that in this case the software-components acts as a server, the `StbM` implements a client role!

[TPS_SWCT_01741] Suffix used for the resulting name of the `PortInterface` for measurement notification [The suffix used for the resulting name of the `PortInterface` for the measurement notification `MeasurementNotification_{TB_Name}` shall be taken from the `shortName` of the applicable `SwcServiceDependency`.]()

13.10.4 StbM Use Case: Software-component represents a global time master

Scenario: a software-component implements the application-software part of the global time master role. For this purpose the software-component exposes an `RPortPrototype` that is supposed to be connected to the `StbM` service component.

[TPS_SWCT_01742] StbM use Case: Software-component represents a global time master [

ServiceNeeds Kind : `SyncTimeBaseMgrUserNeeds`

RoleBasedPortAssignment valid roles:

- `GlobalTime_Master` [1]
- `StatusNotification` [0..1]
- `MeasurementNotification` [0..1]

RoleBasedDataAssignment

N/A

RoleBasedDataTypeAssignment

N/A

RepresentedPortGroups

N/A

]()

[TPS_SWCT_01743] Suffix used for the resulting name of the `PortInterface` for the global time master role [The suffix used for the resulting name of the `PortInterface` for the global time master role `GlobalTime_Master_{Name}` shall be taken from the `shortName` of the applicable `SwcServiceDependency`.]()

13.10.5 StbM Use Case: Software-component represents a global time slave

Scenario: a software-component implements the application-software part of the global time slave role. For this purpose the software-component exposes an `RPortPrototype` that is supposed to be connected to the `StbM` service component.

[TPS_SWCT_01744] StbM use Case: Software-component represents a global time slave [

ServiceNeeds Kind : `SyncTimeBaseMgrUserNeeds`

RoleBasedPortAssignment valid roles:

- `GlobalTime_Slave` [1]
- `StatusNotification` [0..1]
- `MeasurementNotification` [0..1]

RoleBasedDataAssignment

N/A

RoleBasedDataTypeAssignment

N/A

RepresentedPortGroups

N/A

]()

[TPS_SWCT_01745] Suffix used for the resulting name of the `PortInterface` for the global time slave role [The suffix used for the resulting name of the `PortInterface` for the global time slave role `GlobalTime_Slave_{Name}` shall be taken from the `shortName` of the applicable `SwcServiceDependency`.]()

13.11 Secure On-Board Communication

The meta-class `SecureOnBoardCommunicationNeeds` is used together with the `SwcServiceDependency` to define requirements in order to configure the Secure On-Board Communication module (for the terms related to the AUTOSAR Specification of Module `SecOc`, see [44]).

Class	<code>SecureOnBoardCommunicationNeeds</code>
Package	<code>M2::AUTOSARTemplates::CommonStructure::ServiceNeeds</code>
Note	Specifies the need for the existence of the <code>SecOc</code> module on the respective ECU. This class currently contains no attributes. An instance of this class is used to find out which ports of a software-component deal with the administration of secure communication in order to group the request and response ports.





Class	SecureOnBoardCommunicationNeeds			
Base	<i>ARObject, Identifiable, MultilanguageReferrable, Referrable, ServiceNeeds</i>			
Attribute	Type	Mult.	Kind	Note
–	–	–	–	–

Table 13.65: SecureOnBoardCommunicationNeeds

13.11.1 SecOc Use Case: obtain the verification status of secure communication

In this scenario, the `ApplicationSwComponentType` wants to obtain the status of secure communication.

It is not interested in the details (and would not be able to help anyway even if the details were available).

The `SwcServiceDependency` shall aggregate a `SecureOnBoardCommunicationNeeds`.

[TPS_SWCT_01668] SecOc Use Case: obtain the verification status of secure communication [

RoleBasedPortAssignment valid roles:
n/a

RoleBasedDataAssignment valid roles:

- `VerificationStatus` [1]

RepresentedPortGroups

n/a

]()

[constr_1681] Existence of attribute `RoleBasedDataAssignment.usedDataElement.localVariable` for `RoleBasedDataAssignment.role = VerificationStatus` [If the attribute `RoleBasedDataAssignment.role` is set to the value `VerificationStatus` then the reference `RoleBasedDataAssignment.usedDataElement.localVariable` shall not exist.]()

For explanation of the existence of `[constr_1681]`, it is not intended to provide access to local variables inside the `SwcInternalBehavior`.

13.11.2 SecOc Use Case: software component retires from secure communication for a given period

In this scenario, the [ApplicationSwComponentType](#) undergoes a reconfiguration period in which it is not able to process any security-related data. During this period, the verification status shall always be set to “failed”.

The [SwcServiceDependency](#) shall aggregate a [SecureOnBoardCommunicationNeeds](#).

[TPS_SWCT_01672] SecOc Use Case: software component retires from secure communication for a given period [

RoleBasedPortAssignment valid roles:

- [VerifyStatusConfiguration](#) [1]

RoleBasedDataAssignment valid roles:

n/a

RepresentedPortGroups

n/a

]()

13.11.3 SecOc Use Case: deliver freshness to SecOC I

Scenario: a dedicated software-component computes and delivers the freshness to SecOc. The freshness can optionally be truncated by the software-component.

For this purpose, the software-component exposes a [PPortPrototype](#) to SecOc. This is used for sending a secured message by using the [ClientServerOperation](#) [GetTxFreshness](#) or [GetTxFreshnessTruncData](#).

[TPS_SWCT_01716] SecOc Use Case: deliver freshness to SecOC I [

ServiceNeeds kind [SecureOnBoardCommunicationNeeds](#)

RoleBasedPortAssignment valid roles:

- [FreshnessManagement](#) [1]

RoleBasedDataAssignment valid roles:

n/a

RepresentedPortGroups

n/a

]()

13.11.4 SecOc Use Case: deliver freshness to SecOC II

Scenario: SecOc invokes transmit notification (`SPduTxConfirmation`) at freshness manager. This information can be vital for the computation of the freshness.

[TPS_SWCT_01717] [SecOc Use Case: deliver freshness to SecOC II](#) [

ServiceNeeds kind [SecureOnBoardCommunicationNeeds](#)

RoleBasedPortAssignment valid roles:

- `FreshnessManagement` [1]

RoleBasedDataAssignment valid roles:

n/a

RepresentedPortGroups

n/a

]()

13.11.5 SecOc Use Case: deliver freshness to SecOC III

Scenario: caused by out-of-sync freshness, SecOC cannot verify a MAC, and contacts the freshness manager (software-component) again to obtain a recalculated freshness value.

Each recalculation of the freshness inside the freshness manager is counted. After a given threshold of retries, SecOC has to drop the received message. For this purpose, the `ClientServerOperation` `GetRxFreshness` or `GetRxFreshnessAuthData` is used.

[TPS_SWCT_01718] [SecOc Use Case: deliver freshness to SecOC III](#) [

ServiceNeeds kind [SecureOnBoardCommunicationNeeds](#)

RoleBasedPortAssignment valid roles:

- `FreshnessManagement` [1]

RoleBasedDataAssignment valid roles:

n/a

RepresentedPortGroups

n/a

]()

13.11.6 SecOc Use Case: enable the sending of Pdus even if computation of the MAC is not possible

Scenario: there are cases where the ability to send authenticated messages associated with a given freshness id using a default-MAC is required, e.g. if an ECU has been replaced but was not yet provided with cryptographic keys.

Receivers can distinguish this case from the regular authenticated data exchange by looking at the MAC, i.e. a (configurable) default MAC is used in the described case.

[TPS_SWCT_01784] SecOc Use Case: enable the sending of Pdus even if computation of the MAC is not possible [

ServiceNeeds kind [SecureOnBoardCommunicationNeeds](#)

RoleBasedPortAssignment valid roles:

- `SendDefaultAuthenticationInformation` [1]

RoleBasedDataAssignment valid roles:

n/a

RepresentedPortGroups

n/a

]()

13.12 J1939 Communication

The J1939-specific meta-classes [J1939RmOutgoingRequestServiceNeeds](#) and [J1939RmIncomingRequestServiceNeeds](#) are used together with the [SwcServiceDependency](#) to define requirements in order to configure the J1939 request manager (for the terms related to the AUTOSAR Specification of Module **J1939RM**, see [45]).

Class	J1939RmOutgoingRequestServiceNeeds			
Package	M2::AUTOSARTemplates::CommonStructure::ServiceNeeds			
Note	This meta-class shall be used to specify needs with respect to the configuration of the J1939Rm, in particular for the case where an ApplicationSwComponentType needs to send a request to another J1939 node.			
Base	ARObject , Identifiable , MultilanguageReferrable , Referrable , ServiceNeeds			
Attribute	Type	Mult.	Kind	Note
–	–	–	–	–

Table 13.66: J1939RmOutgoingRequestServiceNeeds

Class	J1939RmIncomingRequestServiceNeeds			
Package	M2::AUTOSARTemplates::CommonStructure::ServiceNeeds			
Note	"This meta-class shall be used to specify needs with respect to the configuration of the J1939Rm, in particular for the case where an ApplicationSwComponentType needs to accept a request from another J1939 node.			
Base	ARObject, Identifiable , MultilanguageReferrable , Referrable , ServiceNeeds			
Attribute	Type	Mult.	Kind	Note
-	-	-	-	-

Table 13.67: J1939RmIncomingRequestServiceNeeds

13.12.1 J1939RM Use Case: AtomicSwComponentType sends requests to the bus

Scenario: An [AtomicSwComponentType](#) sends requests to the bus. In this case the following setup applies:

To indicate the scenario described in this use case the [SwcServiceDependency](#) shall aggregate a [J1939RmOutgoingRequestServiceNeeds](#).

[TPS_SWCT_01673] Application Software Component sends requests using the J1939Rm [

RoleBasedPortAssignment valid roles:

- AppSendRequest [1]
- AppAckIndication [1]
- AppRequestTimeoutIndication [0..1]
- AppCancelRequestTimeout [0..1]

RoleBasedDataAssignment valid roles:

n/a

RepresentedPortGroups

n/a

]([RS_SWCT_03180](#))

For more information please refer to the following specification items: [SWS_-J1939Rm_00104], [SWS_J1939Rm_00106], [SWS_J1939Rm_00108], and [SWS_-J1939Rm_00105].

13.12.2 J1939RM Use Case: AtomicSwComponentType accepts requests from the bus

Scenario: An [AtomicSwComponentType](#) accepts requests from the bus. In this case the following setup applies:

To indicate the scenario described in this use case the [SwcServiceDependency](#) shall aggregate a [J1939RmIncomingRequestServiceNeeds](#).

[TPS_SWCT_01674] Application Software Component accepts requests using the J1939Rm [

RoleBasedPortAssignment valid roles:

- [AppRequestIndication](#) [1]
- [AppSendAck](#) [1]

RoleBasedDataAssignment valid roles:

n/a

RepresentedPortGroups

n/a

]([RS_SWCT_03180](#))

For more information please refer to the following specification items: [SWS_J1939Rm_00103] and [SWS_J1939Rm_00107].

13.13 Error Tracer

The meta-class [ErrorTracerNeeds](#) is used to define requirements in order to configure the Default Error Tracer.

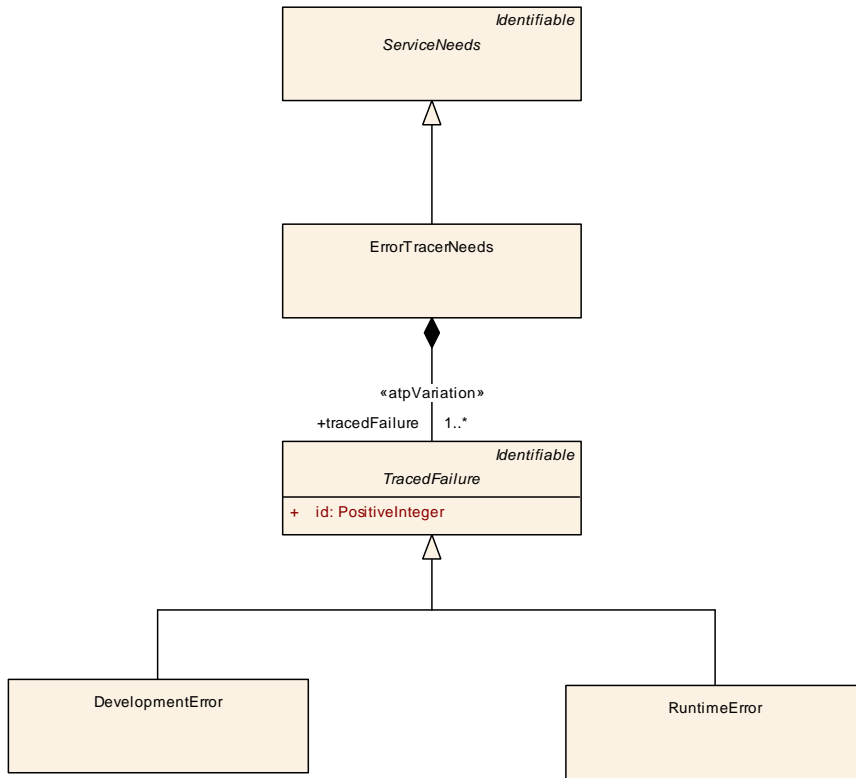

Figure 13.11: Modeling of ErrorTracerNeeds

In particular, `ErrorTracerNeeds` provides the exhaustive list of all `tracedFailure` implemented in the enclosing software-component and reported via the `PortPrototype` referenced via `RoleBasedPortAssignment`.

Each `tracedFailure` relates to one ID, represented by attribute `TracedFailure.id`.

For more explanation, please consult with the specification of Default Error Tracer [46].

Class	ErrorTracerNeeds			
Package	M2::AUTOSARTemplates::CommonStructure::ServiceNeeds			
Note	Specifies the need to report failures to the error tracer.			
Base	<i>ARObject</i> , <i>Identifiable</i> , <i>MultilanguageReferrable</i> , <i>Referrable</i> , <i>ServiceNeeds</i>			
Attribute	Type	Mult.	Kind	Note
tracedFailure	<code>TracedFailure</code>	1..*	aggr	list of traced failures Stereotypes: <code>atpVariation</code> Tags: <code>vh.latestBindingTime=preCompileTime</code>

Table 13.68: ErrorTracerNeeds

Class	<i>TracedFailure</i> (abstract)			
Package	M2::AUTOSARTemplates::CommonStructure::ServiceNeeds			
Note	Specifies the ability to report a specific failure to the error tracer. The short name specifies the literal applicable for the Default Error Tracer.			
Base	<i>ARObject</i> , <i>Identifiable</i> , <i>MultilanguageReferrable</i> , <i>Referrable</i>			
Subclasses	<i>DevelopmentError</i> , <i>RuntimeError</i> , <i>TransientFault</i>			
Attribute	Type	Mult.	Kind	Note
id	PositiveInteger	1	attr	ID of detected failure used in reporting API as error or fault id.

Table 13.69: TracedFailure

Class	DevelopmentError			
Package	M2::AUTOSARTemplates::CommonStructure::ServiceNeeds			
Note	The reported failure is classified as development error.			
Base	<i>ARObject</i> , <i>Identifiable</i> , <i>MultilanguageReferrable</i> , <i>Referrable</i> , <i>TracedFailure</i>			
Attribute	Type	Mult.	Kind	Note
–	–	–	–	–

Table 13.70: DevelopmentError

Class	RuntimeError			
Package	M2::AUTOSARTemplates::CommonStructure::ServiceNeeds			
Note	The reported failure is classified as runtime error.			
Base	<i>ARObject</i> , <i>Identifiable</i> , <i>MultilanguageReferrable</i> , <i>Referrable</i> , <i>TracedFailure</i>			
Attribute	Type	Mult.	Kind	Note
–	–	–	–	–

Table 13.71: RuntimeError

13.13.1 Error Tracer Use Case: Default Error Tracer Service use Case: report failure

[TPS_SWCT_01694] Setup for Default Error Tracer Service use Case: development errors or runtime error [

Scenario: a software-component reports development errors or runtime error to the Default Error Tracer. In this case the following setup applies

ServiceNeeds kind [ErrorTracerNeeds](#)

RoleBasedPortAssignment valid roles:

- DETService[1]

RoleBasedDataAssignment valid roles:

n/a

RoleBasedDataTypeAssignment valid roles:

n/a

RepresentedPortGroups

n/a

]()

[constr_1433] Transient faults are not applicable to software-components [An [ErrorTracerNeeds](#) aggregated in the context of a [SwcInternalBehavior](#) is not allowed to own a [TransientFault](#) in the role [ErrorTracerNeeds.tracedFailure](#).]()

13.14 Vehicle-2-X Facilities

The meta-class [V2xFacUserNeeds](#) is used together with the [SwcServiceDependency](#) to define requirements in order to configure the V2xFac module (for the terms related to the AUTOSAR Specification of Module V2xFac see [47]).

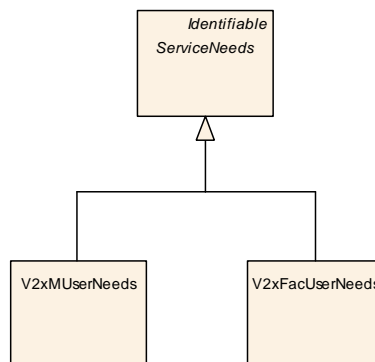

Figure 13.12: Modeling of [V2xFacUserNeeds](#)

Class	V2xFacUserNeeds			
Package	M2::AUTOSARTemplates::CommonStructure::ServiceNeeds			
Note	This meta-class represents the ability to define service needs for V2x facilities.			
Base	ARObject , Identifiable , MultilanguageReferrable , Referrable , ServiceNeeds			
Attribute	Type	Mult.	Kind	Note
-	-	-	-	-

Table 13.72: [V2xFacUserNeeds](#)

Please note that for the described use cases of the V2xFac Service following rule applies:

For every used [SenderReceiverInterface](#) it is necessary to create a [RoleBasedDataAssignment](#).

13.14.1 V2xFac Use Case: Application software component provides Vehicle specific data to the V2X-Stack for CAM transmission

Scenario: an [AtomicSwComponentType](#) autonomously calls the V2xFac, providing vehicle data collected via the in-vehicle networks in the module. In this case the following setup applies:

[TPS_SWCT_01728] V2xFac Use Case: Application software component provides Vehicle specific data to the V2X-Stack for CAM transmission [

RoleBasedPortAssignment

N/A

RoleBasedDataAssignment valid roles:

- V2xFacVdp [1]

RoleBasedDataTypeAssignment

N/A

RepresentedPortGroups

N/A

]()

In this case the software component has to provide one Sender Port (V2xFacVdp) to

- provide the Vehicle Data

[constr_1682] Existence of attribute [RoleBasedDataAssignment.usedDataElement.localVariable](#) for [RoleBasedDataAssignment.role = V2xFacVdp](#) [If the attribute [RoleBasedDataAssignment.role](#) is set to the value V2xFacVdp then the reference [RoleBasedDataAssignment.usedDataElement.localVariable](#) shall not exist.]()

For explanation of the existence of [\[constr_1682\]](#), it is not intended to provide access to local variables inside the [SwcInternalBehavior](#).

13.14.2 V2xFac Use Case: V2xFac notifies application software component about received messages

Scenario: an [AtomicSwComponentType](#) shall be informed by the V2xFac about received CAM or DENM messages. In this case the following setup applies:

[TPS_SWCT_01729] V2xFac Use Case: V2xFac notifies application software component about received messages [

RoleBasedPortAssignment

N/A

RoleBasedDataAssignment valid roles:

- V2xApplRxIndicationCam [0..1]
- V2xApplRxIndicationDenm [0..1]

RoleBasedDataTypeAssignment

N/A

RepresentedPortGroups

N/A

]()

In this case the software-component has to provide one Receiver Port (V2xApplRxIndicationCam) to receive the current value of the CAM message and / or one Receiver Port (V2xApplRxIndicationDenm) to receive the current DENM message.

Please note that at least one of the two possible [RoleBasedDataAssignments](#) shall exist for this use case.

[constr_1683] Existence of attribute [RoleBasedDataAssignment.usedDataElement.localVariable](#) for [RoleBasedDataAssignment.role](#) = V2xApplRxIndicationCam [If the attribute [RoleBasedDataAssignment.role](#) is set to the value V2xApplRxIndicationCam then the reference [RoleBasedDataAssignment.usedDataElement.localVariable](#) shall not exist.]
()

For explanation of the existence of [\[constr_1683\]](#), it is not intended to provide access to local variables inside the [SwcInternalBehavior](#).

13.14.3 V2xFac Use Case: Application software component triggers transmission of DENM message

Scenario: an [AtomicSwComponentType](#) shall be able to trigger the transmission of different DENM types. In this case the following setup applies:

[TPS_SWCT_01730] V2xFac Use Case: Application software component triggers transmission of DENM message [

RoleBasedPortAssignment valid roles:

- V2xFacDenBs [1]

RoleBasedDataAssignment

N/A

RoleBasedDataTypeAssignment

N/A

RepresentedPortGroups

N/A

]()

In this case the software component has to provide one `ClientPortPrototype` (typed by the standardized `ClientServerInterface V2xFacDenBs`) to

- trigger new DENM message
- trigger updated DENM message
- trigger a cancellation of a DENM message

13.14.4 V2xFac Use Case: Application software component processes the *MAP (topology) Extended Message*

Scenario: an `AtomicSwComponentType` shall be able to process the *MAP (topology) Extended Message*. In this case the following setup applies:

[TPS_SWCT_01764] V2xFac Use Case: Application software component shall be able to process the *MAP (topology) Extended Message* [

RoleBasedPortAssignment

N/A

RoleBasedDataAssignment valid roles:

- `V2xApplRxIndicationMapem [1]`

RoleBasedDataTypeAssignment

N/A

RepresentedPortGroups

N/A

]()

In this case the software component has to provide one `RPortPrototype` (typed by the standardized `SenderReceiverInterface V2xApplRxIndicationMapem`) to process the *MAP (topology) Extended Message (MAPEM)*.

[constr_1684] Existence of attribute `RoleBasedDataAssignment.usedDataElement.localVariable` for `RoleBasedDataAssignment.role = V2xApplRxIndicationMapem` [If the attribute `RoleBasedDataAssignment.role` is set to the value `V2xApplRxIndicationMapem` then the reference `RoleBasedDataAssignment.usedDataElement.localVariable` shall not exist.]

()

For explanation of the existence of `[constr_1684]`, it is not intended to provide access to local variables inside the `SwcInternalBehavior`.

13.14.5 V2xFac Use Case: Application software component processes Infrastructure to Vehicle Information Message

Scenario: an `AtomicSwComponentType` shall be able to process the *Infrastructure to Vehicle Information Message* (IVIM). In this case the following setup applies:

[TPS_SWCT_01770] V2xFac Use Case: Application software component processes Infrastructure to Vehicle Information Message [

RoleBasedPortAssignment

N/A

RoleBasedDataAssignment valid roles:

- `V2xApplRxIndicationIvim` [1]

RoleBasedDataTypeAssignment

N/A

RepresentedPortGroups

N/A

]()

In this case the software component has to provide one `RPortPrototype` (typed by the standardized `SenderReceiverInterface` `V2xApplRxIndicationIvim`) to process the *Infrastructure to Vehicle Information Message* (IVIM).

[constr_1685] Existence of attribute `RoleBasedDataAssignment.usedDataElement.localVariable` for `RoleBasedDataAssignment.role = V2xApplRxIndicationIvim` [If the attribute `RoleBasedDataAssignment.role` is set to the value `V2xApplRxIndicationIvim` then the reference `RoleBasedDataAssignment.usedDataElement.localVariable` shall not exist.]
()

For explanation of the existence of `[constr_1685]`, it is not intended to provide access to local variables inside the `SwcInternalBehavior`.

13.14.6 V2xFac Use Case: Application software component processes Signal Phase And Timing Extended Message

Scenario: an `AtomicSwComponentType` shall be able to process the *Signal Phase And Timing Extended Message* (SPATEM). In this case the following setup applies:

[TPS_SWCT_01788] V2xFac Use Case: Application software component processes Signal Phase And Timing Extended Message [

RoleBasedPortAssignment

N/A

RoleBasedDataAssignment valid roles:

- V2xApplRxIndicationSpatem [1]

RoleBasedDataAssignment

N/A

RepresentedPortGroups

N/A

]()

In this case the software component has to provide one [RPortPrototype](#) (typed by the standardized [SenderReceiverInterface](#) V2xApplRxIndicationSpatem) to process the *Signal Phase And Timing Extended Message* (SPATEM).

[constr_1686] Existence of attribute [RoleBasedDataAssignment.usedDataElement.localVariable](#) for [RoleBasedDataAssignment.role = V2xApplRxIndicationSpatem](#) [If the attribute [RoleBasedDataAssignment.role](#) is set to the value V2xApplRxIndicationSpatem then the reference [RoleBasedDataAssignment.usedDataElement.localVariable](#) shall not exist.]
()

For explanation of the existence of [constr_1686], it is not intended to provide access to local variables inside the [SwcInternalBehavior](#).

13.15 Vehicle-2-X Management

The meta-class [V2xMUserNeeds](#) is used together with the [SwcServiceDependency](#) to define requirements in order to configure the V2X Manager module (for the terms related to the AUTOSAR Specification of Module V2xM see [48]).

Class	V2xMUserNeeds			
Package	M2::AUTOSARTemplates::CommonStructure::ServiceNeeds			
Note	This meta-class represents the ability to express service needs for the V2x management.			
Base	ARObject , Identifiable , MultilanguageReferrable , Referrable , ServiceNeeds			
Attribute	Type	Mult.	Kind	Note
-	-	-	-	-

Table 13.73: V2xMUserNeeds

Please note that for the described use cases of the V2xFac Service following rule applies:

For every used [ClientServerInterface](#) it is necessary to create a [RoleBasedPortAssignment](#).

Thereby the value of the attribute [role](#) of the [RoleBasedPortAssignment](#) has to be set to the name of the used standardized [ClientServerInterface](#).

The possible role attribute values and the multiplicity of the related [PortPrototypes](#) are listed at the use case descriptions in the paragraph **RoleBasedPortAssignment**.

13.15.1 V2xM Use Case: Application software component provides Vehicle specific data to the V2X-Stack for Position and Time information

Scenario: an [AtomicSwComponentType](#) autonomously calls the V2X Manager, providing vehicle data collected via the in-vehicle networks in the module. In this case the following setup applies:

[TPS_SWCT_01731] V2xM Use Case: Application software component provides Vehicle specific data to the V2X-Stack for Position and Time information [

RoleBasedPortAssignment valid roles:

- V2xM_Vdp [1]

RoleBasedDataAssignment

N/A

RoleBasedDataTypeAssignment

N/A

RepresentedPortGroups

N/A

]()

In this case the software component has to provide one Client [PortPrototype](#) (typed by the standardized [ClientServerInterface](#) V2xM_Vdp) to

- set the current time and position

13.15.2 V2xM Use Case: Application software component needs V2X specific data from the V2X Manager

Scenario: an [AtomicSwComponentType](#) autonomously calls the V2X Manager, getting information of V2X specific data in the module. In this case the following setup applies:

[TPS_SWCT_01732] V2xM Use Case: Application software component needs V2X specific data from the V2X Manager [

RoleBasedPortAssignment valid roles:

- V2xM_Vdp [1]

RoleBasedDataAssignment

N/A

RoleBasedDataTypeAssignment

N/A

RepresentedPortGroups

N/A

]()

In this case the software component has to provide one Client `PortPrototype` (typed by the standardized `ClientServerInterface V2xM_Vdp`) to

- access the current time of the V2X-Stack, based on the system clock
- access the earliest date of expiration of a Long Term Certificate
- access the earliest date of expiration of a Pseudonym Certificate

13.15.3 V2xM Use Case: Application software component has soft-control over Pseudonym-Change within V2X Manager

Scenario: an `AtomicSwComponentType` autonomously calls the V2X Manager, setting the locked or unlocked state for pseudonym change. In this case the following setup applies:

[TPS_SWCT_01733] V2xM Use Case: Application software component has soft-control over Pseudonym-Change within V2X Manager [

RoleBasedPortAssignment valid roles:

- `V2xM_PseudonymChange [1]`

RoleBasedDataAssignment

N/A

RoleBasedDataTypeAssignment

N/A

RepresentedPortGroups

N/A

]()

In this case the software component has to provide one Client `PortPrototype` (typed by the standardized `ClientServerInterface V2xM_PseudonymChange`) to

- set the state of the pseudonym change to locked
- set the state of the pseudonym change to unlocked

13.15.4 V2xM Use Case: Application software component has the ability to do Verification-on-Demand

Scenario: an `AtomicSwComponentType` autonomously calls the V2X Manager, authenticating a previously received message. In this case the following setup applies:

[TPS_SWCT_01734] V2xM Use Case: Application software component has the ability to do Verification-on-Demand [

RoleBasedPortAssignment valid roles:

- V2xM_Sec [1]

RoleBasedDataAssignment

N/A

RoleBasedDataTypeAssignment

N/A

RepresentedPortGroups

N/A

]()

In this case the software component has to provide one Client [PortPrototype](#) (typed by the standardized [ClientServerInterface](#) V2xM_Sec) to

- verify a previously received message

13.15.5 V2xM Use Case: Application software component do location based calculations

Scenario: an [AtomicSwComponentType](#) autonomously calls the V2X Manager, getting results for geographical calculations. In this case the following setup applies:

[TPS_SWCT_01735] V2xM Use Case: Application software component do location based calculations [

RoleBasedPortAssignment valid roles:

- V2xM_GeoMath [1]

RoleBasedDataAssignment

N/A

RoleBasedDataTypeAssignment

N/A

RepresentedPortGroups

N/A

]()

In this case the software component has to provide one Client [PortPrototype](#) (typed by the standardized [ClientServerInterface](#) V2xM_GeoMath) to

- calculate the distance between two location tuples (latitude, longitude)
- calculate an allowed tolerance value between two heading values

13.16 Hardware Test Manager

The service use cases for the *Hardware Test Manager* are indicated by the usage of meta-class `HardwareTestNeeds` in the role `SwcServiceDependency.serviceNeeds`.

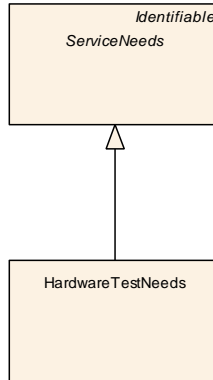

Figure 13.13: Modeling of `HardwareTestNeeds`

Class	HardwareTestNeeds			
Package	M2::AUTOSARTemplates::CommonStructure::ServiceNeeds			
Note	This meta-class represents the ability to indicate that a software-component is interested in the results of the hardware test and will establish a PortPrototype to query the hardware test manager.			
Base	<i>ARObject</i> , <i>Identifiable</i> , <i>MultilanguageReferrable</i> , <i>Referrable</i> , <i>ServiceNeeds</i>			
Attribute	Type	Mult.	Kind	Note
-	-	-	-	-

Table 13.74: HardwareTestNeeds

13.16.1 HtssM Service Use Case: Query results of hardware tests

Scenario: A software-component wants to query the results of hardware tests conducted by the `HtssM`. For this purpose, the software-component exposes an `RPortPrototype` that shall be connected to the `HtssM`.

[TPS_SWCT_01763] HtssM Service Use Case: Query results of hardware tests [

ServiceNeeds kind : `HardwareTestNeeds`

RoleBasedPortAssignment valid roles:

- `GetTestStatus [1]`

RoleBasedDataAssignment

N/A

RepresentedPortGroups

N/A

10

14 Rapid Prototyping Scenarios

14.1 Definition of Rapid Prototyping Scenario

A Rapid Prototyping Scenario consist out of two main aspects: The description of the `byPassPoints` (see Figure 14.1) and the relation to a `rptHook` (see Figure 14.2).

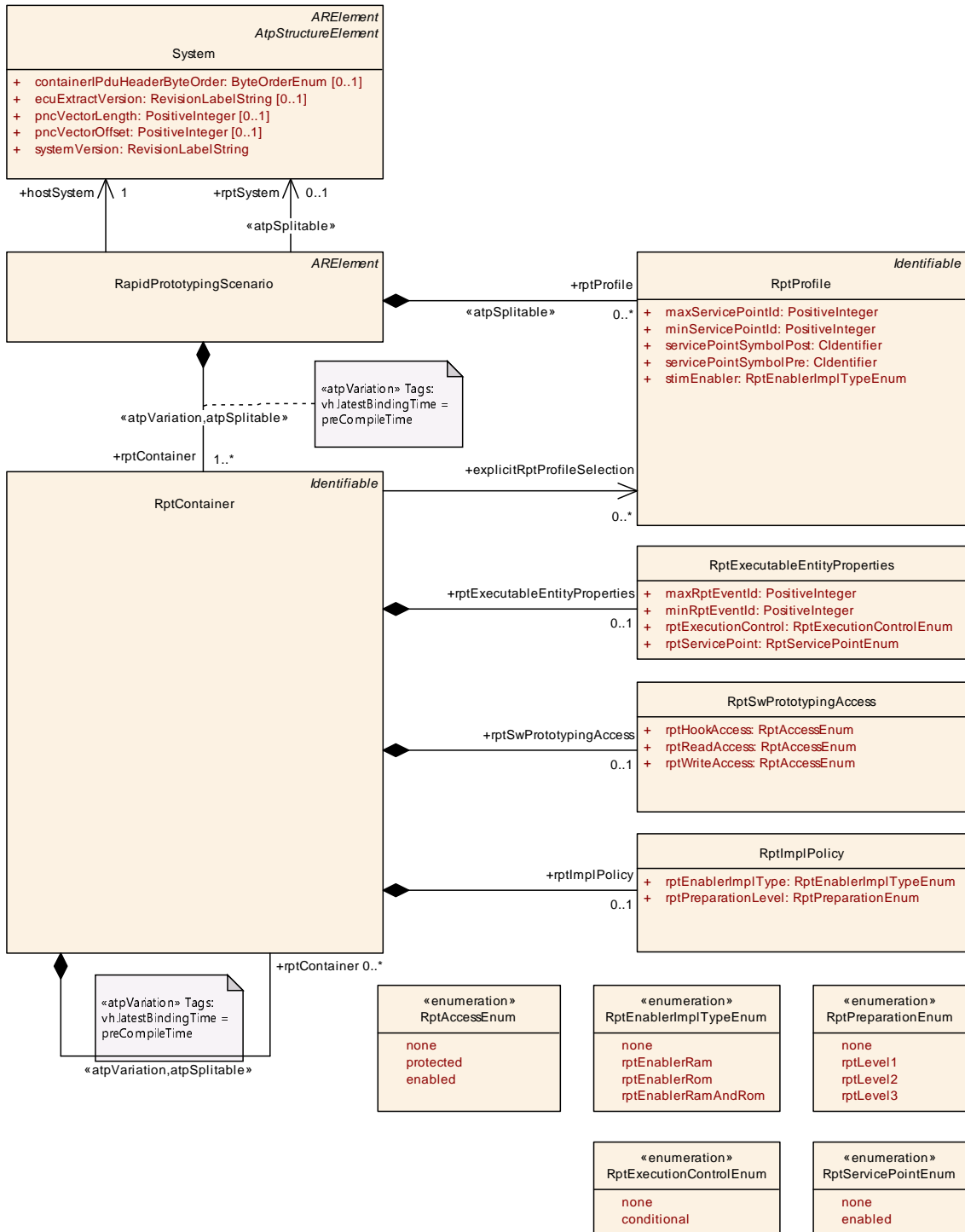

Figure 14.1: Rapid Prototyping Scenario

A Rapid Prototyping Scenario is structured by means of `RptContainers`. The correct usage of `RptContainer` structure is described in 14.2.

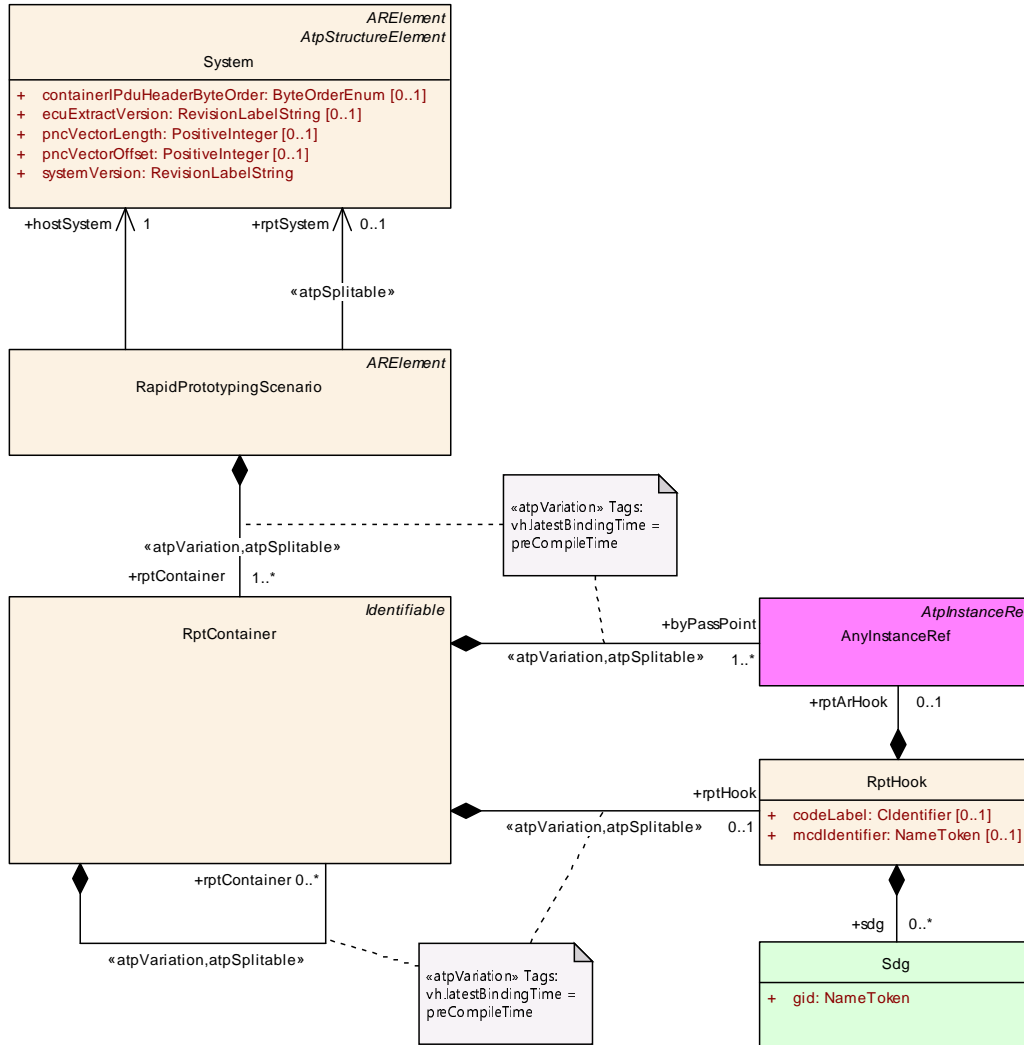

Figure 14.2: Rapid Prototyping Hooks

Class	RapidPrototypingScenario			
Package	M2::AUTOSARTemplates::SWComponentTemplate::RPTScenario			
Note	This meta class provides the ability to describe a Rapid Prototyping Scenario. Such a Rapid Prototyping Scenario consist out of two main aspects, the description of the byPassPoints and the relation to an rpt Hook. Tags: atp.recommendedPackage=RapidPrototypingScenarios			
Base	ARElement , ARObject , CollectableElement , Identifiable , MultilanguageReferrable , PackageableElement , Referrable			
Attribute	Type	Mult.	Kind	Note
hostSystem	System	1	ref	System which describes the software components of the host ECU.





Class	RapidPrototypingScenario			
rptContainer	RptContainer	1..*	aggr	<p>Top-level rptContainer definitions of this specific rapid prototyping scenario.</p> <p>Stereotypes: atpSplitable; atpVariation Tags: atp.Splitkey=shortName, variationPoint.shortLabel vh.latestBindingTime=preCompileTime</p>
rptProfile	RptProfile	*	aggr	<p>Defiens the applicable Rapid Prototyping profls which are especially defining the smbol of the service functions and the valid id range. The order of the RptProfiles determines the order of the service function invocation by RTE.</p> <p>Stereotypes: atpSplitable Tags:atp.Splitkey=shortName</p>
rptSystem	System	0..1	ref	<p>System which describes the rapid prototyping algorithm in the format of AUTOSAR Software Components.</p> <p>Stereotypes: atpSplitable Tags:atp.Splitkey=rptSystem</p>

Table 14.1: RapidPrototypingScenario

Class	RptContainer			
Package	M2::AUTOSARTemplates::SWComponentTemplate::RPTScenario			
Note	<p>This meta class defines a byPassPoint and the relation to a rptHook.</p> <p>Additionally it may contain further rptContainers if the byPassPoint is not atomic. For example a byPass Point refereing to a RunnableEntity may contain rptContainers referring to the data access points of the RunnableEntity.</p> <p>The RptContainer structure on M1 shall follow the M1 structure of the Software Component Descriptions. The category attribute denotes which level of the Software Component Description is annotated.</p>			
Base	<i>ARObject, Identifiable, MultilanguageReferrable, Referrable</i>			
Attribute	Type	Mult.	Kind	Note
byPassPoint	AtpFeature	1..*	iref	<p>byPassPoint describes the required preparation of the host ECU. At a byPassPoint the host ECU shall be capable to communicate with a RPT System in order to support the execution of the rapid prototyping algorithms with the original data calculated by the host system and to replace dedicated results of the host system by the results of the rapid prototyping algorithm.</p> <p>Stereotypes: atpSplitable; atpVariation Tags: atp.Splitkey=byPassPoint, contextElement, target, variationPoint.shortLabel vh.latestBindingTime=preCompileTime</p>
explicitRptProfileSelection	RptProfile	*	ref	<p>This attribute defines the applicable RptProfiles for the specific RptContainer. If not any references to a specific RptProfile is defined, all RptProfiles defined in the Rapid PrototypingScenario are applicable.</p> <p>Tags:atp.Splitkey=explicitRptProfileSelection</p>





Class	RptContainer			
rptContainer	RptContainer	*	aggr	Sub-level rptContainer definitions of this specific rapid prototyping scenario. Stereotypes: atpSplitable; atpVariation Tags: atp.Splitkey=shortName, variationPoint.shortLabel vh.latestBindingTime=preCompileTime
rptExecutable EntityProperties	RptExecutableEntity Properties	0..1	aggr	Describes the required code preparation for rapid prototyping at ExecutableEntity invocation.
rptHook	RptHook	0..1	aggr	The rptHook describes the link between a byPassPoint and the rapid prototyping algorithm. Stereotypes: atpSplitable; atpVariation Tags: atp.Splitkey=rptHook, variationPoint.shortLabel vh.latestBindingTime=preCompileTime
rptImplPolicy	RptImplPolicy	0..1	aggr	Describes the required code preparation for rapid prototyping at data accesses.
rptSw Prototyping Access	RptSwPrototyping Access	0..1	aggr	Describes the required accessibility of data and modes by the rapid prototyping tooling.

Table 14.2: RptContainer

Class	RptHook			
Package	M2::AUTOSARTemplates::SWComponentTemplate::RPTScenario			
Note	This meta class provide the ability to describe a rapid prototyping hook. This can either be described by an other AUTOSAR system with the category RPT_SYSTEM or as a non AUTOSAR software.			
Base	<i>ARObject</i>			
Attribute	Type	Mult.	Kind	Note
codeLabel	CIdentifier	0..1	attr	This attribute provides a code label which is used in the implementation of the hook. For example this can be an C function name or the name of data definition.
mcdIdentifier	NameToken	0..1	attr	This attribute provides an identifier which shall be used in a MCD System to display the Rpt Hook.
rptArHook	AtpFeature	0..1	iref	This describes the hook with the means of another AUTOSAR system.
sdg	Sdg	*	aggr	This property allows to keep special data which is not represented by the standard model. It can be utilized to keep e.g. tool specific data.

Table 14.3: RptHook

[TPS_SWCT_02046] [byPassPoint](#) specifies the rapid prototyping capability

[The [byPassPoints](#) are used to describe the preparation of the host ECU. At the [byPassPoints](#) the host ECU shall be capable to communicate with an RPT System in order to support the execution of the rapid prototyping algorithms with the original data calculated by the host system and to replace dedicated results of the host system by the results of the rapid prototyping algorithm.] ([RS_SWCT_03280](#), [RS_SWCT_03282](#))

[TPS_SWCT_02047] [RptHook](#) specifies the link to rapid prototyping algorithm

[The [rptHook](#) describes the link between the [byPassPoint](#) and the rapid prototyping algorithm. If the rapid prototyping algorithm is described as an AUTOSAR Software Component the [rptArHook](#) reference is applicable. Otherwise, the definition of a

`codeLabel` and optionally `mcdIdentifier` shall be used.](*RS_SWCT_03280*, *RS_SWCT_03281*, *RS_SWCT_03282*)

In order to describe an RPT system as AUTOSAR software component a `System` with the `category` `RPT_SYSTEM` shall be defined.

[constr_2054] Valid targets of `rptSystem` [The `System` referenced in the role `rptSystem` shall be of `category` `RPT_SYSTEM`.]()

14.2 Usage of RptContainers on M1

The `RptContainer` structure on M1 shall follow the M1 structure of the Software Component Descriptions. The `category` attribute denotes which level of the Software Component Description is annotated.

The following values of the attribute `category` are predefined by the AUTOSAR standard:

Category	Meaning	Specific properties
<code>SW_COMPONENT_PROTOTYPE</code>	Adds one <code>SwComponentPrototype</code> to an Rapid Prototyping Scenario.	The <code>byPassPoint</code> and <code>rptArHook</code> shall reference a <code>SwComponentPrototypes</code> .
<code>DATA_PROTOTYPE</code>	Adds one instance of a <code>DataPrototype</code> to an Rapid Prototyping Scenario.	The <code>byPassPoint</code> and <code>rptArHook</code> shall reference a <code>DataPrototype</code> instances in <code>Port-Prototypes</code> .
<code>RUNNABLE_ENTITY</code>	Adds one <code>RunnableEntity</code> to an Rapid Prototyping Scenario.	The <code>byPassPoint</code> and <code>rptArHook</code> shall reference a <code>RunnableEntity</code> instances.
<code>ACCESS_POINTS</code>	Adds one <code>VariableAccess</code> , <code>ParameterAccess</code> , <code>ServerCallPoint</code> , <code>AsynchronousServerCallResultPoint</code> , <code>InternalTriggeringPoint</code> , <code>ModeSwitchPoint</code> or <code>ExternalTriggeringPoint</code> to a Rapid Prototyping Scenario.	The <code>byPassPoint</code> and <code>rptArHook</code> shall reference a <code>VariableAccess</code> , <code>ParameterAccess</code> , <code>ServerCallPoint</code> , <code>AsynchronousServerCallResultPoint</code> , <code>InternalTriggeringPoint</code> , <code>ModeSwitchPoint</code> , <code>ModeAccessPoint</code> or <code>ExternalTriggeringPoint</code> instances.

Table 14.4: Category of RptContainers

[constr_2055] Valid targets of `byPassPoint` and `rptHook` reference [Depending on the `category` value the targets of `byPassPoint` and `rptHook` references are restricted according table 14.4.]()

Hereby, the following semantic applies:

[TPS_SWCT_02048] Implicit `SwComponentPrototype` selection for Rapid Prototyping Scenario [If a `SwComponentPrototype` is referenced in the role `byPassPoint` by a `RptContainer` without further “Sub” `rptContainer`, all RTE Interfaces of the `AtomicSwComponentType` shall be able to support a connection to a `rptHook`.](*RS_SWCT_03280*)

[TPS_SWCT_02049] Implicit `RunnableEntity` selection for Rapid Prototyping Scenario [If a `RunnableEntity` is referenced in the role `byPassPoint` by a `RptContainer` without further “Sub” `rptContainer`, all RTE Interfaces of the

RunnableEntity shall be able to support a connection to a `rptHook`.] (*RS_SWCT_03280*)

[TPS_SWCT_02050] Explicit selection of access points for Rapid Prototyping Scenario [If a `VariableAccess`, `ParameterAccess`, `ServerCallPoint`, `AsynchronousServerCallResultPoint`, `InternalTriggeringPoint`, `ModeSwitchPoint`, `ModeAccessPoint` or `ExternalTriggeringPoint` is referenced in the role `byPassPoint` by a `RptContainer`, only RTE Interfaces related to the specific access point are required be able to support a connection to a `rptHook`.] (*RS_SWCT_03280*)

[TPS_SWCT_02051] Explicit DataPrototype selection for Rapid Prototyping Scenario [If a `DataPrototype` instances in a `PortPrototypes` is referenced in the role `byPassPoint` by a `RptContainer`, only RTE Interfaces related to the specific `DataPrototype` are required be able to support a connection to a `rptHook`.] (*RS_SWCT_03280*)

[constr_2056] Consistency of RapidPrototypingScenario with respect to rptSystem and rptArHook references [Within one `RapidPrototypingScenario` all `rptSystem` references shall point to instances in one and only one `System` and if existent all `rptArHook` shall point to instances in one other and only one other `System`.]()

14.3 Usage of `atpSplittable` for `RptContainers` on M1

In order to support the later definition of the `RptHooks`, which may require as well the detailed specification `byPassPoints`, the aggregation of `RptContainer` and `RptHook` is `<<atpSplittable>>`.

[TPS_SWCT_02052] Definition of Rapid Prototyping Scenario is splittable [Aggregation of `RptContainer`, `byPassPoint` and `rptHook` using stereotype `<<atpSplittable>>`. By this means it is possible to generally specify the definition the `RptHooks` in a later process step.] (*RS_SWCT_03280*)

Please note that the later specification of `RptHooks` may require additional `byPassPoints` as well to show their relation ship to lower level elements in a component description, such as `VariableAccess` where in contrast the `byPassPoints` may only specified on higher level elements such as `SwComponentPrototypes` in a first step.

14.4 Modifications of the Meta-Model for supporting the RPT scenario

The implementation of the rapid-pro typing scenario implies the definition of *access points* (see table 14.4). To be able to fulfill this role, the *access points* shall be represented by meta-classes derived from [Referrable](#).

Most candidates for becoming *access points* are already inheriting from [Referrable](#) and therefore do not require further treatment (see Figure 14.3). Two meta-classes in this collection, however, are not derived from [Referrable](#):

- [ExternalTriggeringPoint](#)
- [ModeAccessPoint](#)

It is not feasible to fix this issue by simply letting the two meta-classes inherit from [Referrable](#) because this would break the backwards compatibility of the AUTOSAR XML Schema¹. Therefore, a different approach (as sketched in Figure 14.3) has been implemented.

¹Because in this case the [shortName](#) becomes mandatory.

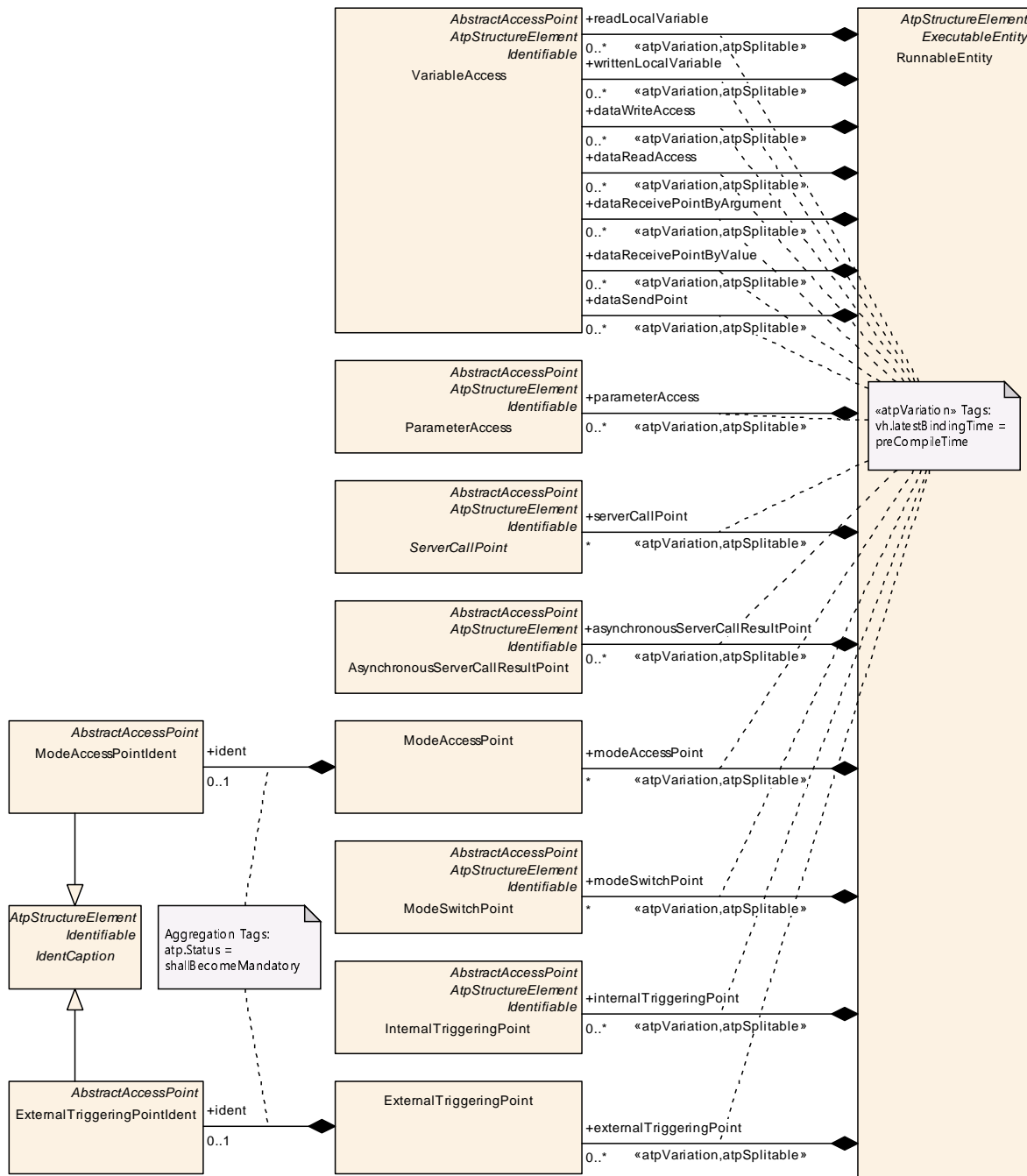

Figure 14.3: Access Points used in the context of the Rapid Prototyping Scenario

A new meta-class `IdentCaption` is created that introduces the capabilities of the meta-class `Identifiable` (that, in turn, inherits from `Referrable`) to its subclasses, `ModeAccessPointIdent` and `ExternalTriggeringPointIdent`.

These, in turn, are **optionally**² aggregated in the role `ident` by `ModeAccessPoint`, or in the role `ident` by meta-class `ExternalTriggeringPoint`.

²Again, this is necessary to not break the backwards compatibility

Class	<i>IdentCaption</i> (abstract)			
Package	M2::AUTOSARTemplates::SWComponentTemplate::RPTScenario			
Note	This meta-class represents the caption. This allows having some meta classes optionally identifiable.			
Base	<i>ARObject</i> , <i>AtpClassifier</i> , <i>AtpFeature</i> , <i>AtpStructureElement</i> , <i>Identifiable</i> , <i>MultilanguageReferrable</i> , <i>Referrable</i>			
Subclasses	BswServiceDependencyIdent, <i>ExternalTriggeringPointIdent</i> , <i>ModeAccessPointIdent</i>			
Attribute	Type	Mult.	Kind	Note
–	–	–	–	–

Table 14.5: IdentCaption

Class	ModeAccessPointIdent			
Package	M2::AUTOSARTemplates::SWComponentTemplate::RPTScenario			
Note	This meta-class has been created to introduce the ability to become referenced into the meta-class Mode AccessPoint without breaking backwards compatibility.			
Base	<i>ARObject</i> , <i>AbstractAccessPoint</i> , <i>AtpClassifier</i> , <i>AtpFeature</i> , <i>AtpStructureElement</i> , <i>IdentCaption</i> , <i>Identifiable</i> , <i>MultilanguageReferrable</i> , <i>Referrable</i>			
Attribute	Type	Mult.	Kind	Note
–	–	–	–	–

Table 14.6: ModeAccessPointIdent

Class	ExternalTriggeringPointIdent			
Package	M2::AUTOSARTemplates::SWComponentTemplate::RPTScenario			
Note	This meta-class has been created to introduce the ability to become referenced into the meta-class ExternalTriggeringPoint without breaking backwards compatibility.			
Base	<i>ARObject</i> , <i>AbstractAccessPoint</i> , <i>AtpClassifier</i> , <i>AtpFeature</i> , <i>AtpStructureElement</i> , <i>IdentCaption</i> , <i>Identifiable</i> , <i>MultilanguageReferrable</i> , <i>Referrable</i>			
Attribute	Type	Mult.	Kind	Note
–	–	–	–	–

Table 14.7: ExternalTriggeringPointIdent

The following (simplified) listing 14.1 sketches the usage of the meta-class *IdentCaption* for the purpose of effectively allowing references to a *ModeAccessPoint*.

Listing 14.1: Example for the definition of an RPT scenario

```

<AR-PACKAGE>
  <SHORT-NAME>IC_Example</SHORT-NAME>
  <ELEMENTS>
    <APPLICATION-SW-COMPONENT-TYPE>
      <SHORT-NAME>ASCT</SHORT-NAME>
      <INTERNAL-BEHAVIORS>
        <SWC-INTERNAL-BEHAVIOR>
          <SHORT-NAME>IB</SHORT-NAME>
          <RUNNABLES>
            <RUNNABLE-ENTITY>
              <SHORT-NAME>RE</SHORT-NAME>
            <MODE-ACCESS-POINTS>
              <MODE-ACCESS-POINT>
                <IDENT>

```

```

    <SHORT-NAME>ident</SHORT-NAME>
  </IDENT>
</MODE-ACCESS-POINT>
</MODE-ACCESS-POINTS>
</RUNNABLE-ENTITY>
</RUNNABLES>
</SWC-INTERNAL-BEHAVIOR>
</INTERNAL-BEHAVIORS>
</APPLICATION-SW-COMPONENT-TYPE>
<COMPOSITION-SW-COMPONENT-TYPE>
  <SHORT-NAME>CSCT</SHORT-NAME>
  <COMPONENTS>
    <SW-COMPONENT-PROTOTYPE>
      <SHORT-NAME>SCP</SHORT-NAME>
      <TYPE-TREF DEST="APPLICATION-SW-COMPONENT-TYPE"/>/IC_Example
        /ASCT</TYPE-TREF>
    </SW-COMPONENT-PROTOTYPE>
  </COMPONENTS>
</COMPOSITION-SW-COMPONENT-TYPE>
<RAPID-PROTOTYPING-SCENARIO>
  <SHORT-NAME>rptScenario</SHORT-NAME>
  <RPT-CONTAINERS>
    <RPT-CONTAINER>
      <SHORT-NAME>rptContainer</SHORT-NAME>
      <BY-PASS-POINT-IREFS>
        <BY-PASS-POINT-IREF>
          <CONTEXT-ELEMENT-REF DEST="SW-COMPONENT-PROTOTYPE"/>/
            IC_Example/CSCT/SCP</CONTEXT-ELEMENT-REF>
          <TARGET-REF DEST="MODE-ACCESS-POINT-IDENT"/>/IC_Example/
            ASCT/IB/RE/ident</TARGET-REF>
        </BY-PASS-POINT-IREF>
      </BY-PASS-POINT-IREFS>
    </RPT-CONTAINER>
  </RPT-CONTAINERS>
</RAPID-PROTOTYPING-SCENARIO>
</ELEMENTS>
</AR-PACKAGE>

```

14.5 Extended Buffer Access Method

The Extended Buffer Access method enhances the support for rapid prototyping (RP) to support the bypass use case where the RTE cannot be regenerated by the bypass user.

The goal is to ensure that all `VariableDataPrototypes` that are communicated via RTE APIs are written to and read back from an RP `global buffer` that can be modified by rapid prototyping tools (RPT).

The method applies to all RTE APIs and not just those for implicit access and hence is termed the *extended* buffer access method.

Within the Extended buffer access method, a `VariableDataPrototype` can be flagged for rapid prototyping at one of three levels depending on whether post-build hooking is used. “Level 1” is intended for use by post-build hooking tools and “Level 2” and “Level 3” by non post-build hooking.

Additional RP buffers and RP flags are created when using “Level 2” and “Level 3” and the Extended Buffer Access method includes mechanisms for describing their creation and use to RP tooling.

- RP global buffer – A buffer read/written by RP. The `RP global buffer` is conceptually separated from the RTE managed buffer holding the variable data prototype value.
- RP global measurement buffer – A buffer used by RP to store the original variable data prototype value for subsequent measurement purposes before replacement by the RP generated value.
- RP enabler flag – A Boolean flag to permit run-time enabling/disabling bypass.

14.5.1 RP Preparation

The Extended Buffer Access method of Rapid Prototyping requires the definition of *preparation level* (see table 14.4) to enable RPT-related code generation.

The `RptProfile` of category `EXTENDED_BUFFER_ACCESS` provides the common attributes to implement the RPT support in the code.

An ECU may have to support multiple `RptProfiles` in parallel – for example, to support in one ECU the RPT tools of different suppliers.

Nevertheless, not all components might need to support all possible methods, for instance an XCP based RPT method might not be applicable for hard real-time critical functions, and therefore the `RptProfile` can be selected.

[TPS_SWCT_01719] Selection of applicable `RptProfiles` [The reference `RptContainer.explicitRptProfileSelection` provides a list of `RptProfiles` which needs to be applied when the RPT support is implemented.

If the `explicitRptProfileSelection` is not defined, all `RptProfiles` defined in the owing `RapidPrototypingScenario` are applicable.] (*RS_SWCT_03280*)

Class	RptProfile
Package	M2::AUTOSARTemplates::SWComponentTemplate::RPTScenario
Note	The RptProfile describes the common properties of a Rapid Prototyping method.
Base	<i>ARObject</i> , <i>Identifiable</i> , <i>MultilanguageReferrable</i> , <i>Referrable</i>





Class	RptProfile			
Attribute	Type	Mult.	Kind	Note
maxServicePointId	PositiveInteger	1	attr	Highest service point id useable for RTE generated service points.
minServicePointId	PositiveInteger	1	attr	Lowest service point id useable for RTE generated service points.
servicePointSymbolPost	CIdentifier	1	attr	Complete symbol of the function implementing the post service point. This symbol is used for post-build hooking purposes.
servicePointSymbolPre	CIdentifier	1	attr	Complete symbol of the function implementing the pre service point. This symbol is used for post-build hooking purposes.
stimEnabler	RptEnablerImplType Enum	1	attr	Defines if the service points support the stimulation enabler. If RptProfile.stimEnabler is "none" then no stimulation enabler is passed to the service function. Otherwise the stimulation enabler will be passed as a parameter.

Table 14.8: RptProfile

Class	RptImplPolicy			
Package	M2::AUTOSARTemplates::SWComponentTemplate::RPTScenario			
Note	Describes the code preparation for rapid prototyping at data accesses.			
Base	ARObject			
Attribute	Type	Mult.	Kind	Note
rptEnablerImplType	RptEnablerImplType Enum	1	attr	For Level 2 or Level3 this property determines how the RTE implements the additional "RP enabler" flag.
rptPreparationLevel	RptPreparationEnum	1	attr	Mandates RP preparation level for access to VariableData Prototype within generated RTE implementation.

Table 14.9: RptImplPolicy

Enumeration	RptEnablerImplTypeEnum
Package	M2::AUTOSARTemplates::CommonStructure::MeasurementCalibrationSupport::RptSupport
Note	Describes the required / implemented usage of enabler flags for data access in the code.
Literal	Description
none	No "RP enabler" is implemented. Tags: atp.EnumerationLiteralIndex=0
rptEnablerRam	"RP enabler" is implemented as a RAM variable Tags: atp.EnumerationLiteralIndex=1
rptEnablerRamAndRom	The RTE generator implements both the RAM and ROM "RP enabler". Tags: atp.EnumerationLiteralIndex=3
rptEnablerRom	"RP enabler" is implemented as a calibrateable ROM variable. Tags: atp.EnumerationLiteralIndex=2

Table 14.10: RptEnablerImplTypeEnum

<i>Enumeration</i>	<i>RptPreparationEnum</i>
Package	M2::AUTOSARTemplates::CommonStructure::MeasurementCalibrationSupport::RptSupport
Note	Determines the RP preparation level for access to VariableDataPrototypes within the generated RTE implementation.
Literal	Description
none	No RP preparation for VariableDataPrototype. Tags: atp.EnumerationLiteralIndex=0
rptLevel1	The RTE implementation uses an "RP global buffer" for measurement and post-build hooking purposes. Tags: atp.EnumerationLiteralIndex=1
rptLevel2	As rptLevel1 but the RTE implementation also uses both "RP enabler flag" to permit RP overwrite at run-time. Tags: atp.EnumerationLiteralIndex=2
rptLevel3	As rptLevel2 but the RTE implementation also uses "RP global measurement buffer" to record the original ECU-generated value in addition to the RP value. Tags: atp.EnumerationLiteralIndex=3

Table 14.11: RptPreparationEnum

[TPS_SWCT_01720] **Preparation Levels** [[RptImplPolicy.rptPreparationLevel](#)] supports three preparation levels:

- **Level 1** – If [RptImplPolicy.rptPreparationLevel](#) is set to [rptLevel1](#) then the generated RTE uses a specific memory access pattern (a write-read cycle within accessing code created by the RTE generator) suitable for access by post-build hooking tools patch writes to buffers.
- **Level 2** – If [RptImplPolicy.rptPreparationLevel](#) is set to [rptLevel2](#) then in addition to the use of an RP global buffer (as for [rptLevel1](#)) the generated code also includes an RP enabler flag that is used to make update of the RP global buffer conditional.

The RP enabler flag can be in either (calibratable) ROM or RAM based on [RptContainer.rptEnablerImplType](#).

- **Level 3** – If [RptImplPolicy.rptPreparationLevel](#) is set to [rptLevel3](#) then in addition to the requirements of [rptLevel2](#), the generated code also records the original ECU-generated value as well as the RP replacement value.

]([RS_SWCT_03280](#))

[TPS_SWCT_01721] **References from [RptContainer](#)** [If [rptImplPolicy](#) of a [RptContainer](#) is used the [RptContainer](#) can reference:

- [VariableDataPrototype](#) – the preparation level applies to a single data item.
- [ArgumentDataPrototype](#) – the preparation level applies to a single operation argument.
- [ModeDeclarationGroupPrototype](#) – the preparation level applies to a single mode.

- `operation` – the preparation level applies to all operation `ArgumentDataPrototype`.
- `RunnableEntity` – the preparation level applies to all data items / arguments accessed by the `RunnableEntity`.
- `SwComponentPrototype` – the preparation level applies to all `RunnableEntity`s (and hence all accessed data items and arguments) in the software component.

|(RS_SWCT_03280)

The generated RTE includes appropriate descriptions to enable RP tools to access the generated RP buffers and RP enabler flags.

Class	RptSwPrototypingAccess			
Package	M2::AUTOSARTemplates::CommonStructure::MeasurementCalibrationSupport::RptSupport			
Note	Describes the accessibility of data and modes by the rapid prototyping tooling.			
Base	<i>ARObject</i>			
Attribute	Type	Mult.	Kind	Note
rptHookAccess	RptAccessEnum	1	attr	The related data element can be modified using a post-build hooking tool. An ENABLED VariableData Prototype is implicitly READABLE/WRITABLE.
rptReadAccess	RptAccessEnum	1	attr	The related data element can be used as input for bypass functionality by RP tool. If rptImplPolicy is not specified then RTE generation shall ensure at least suitable MC read points are created.
rptWriteAccess	RptAccessEnum	1	attr	The related data element can be used as output for bypass functionality by RP tool. The data element shall be prepared to rptLevel2 and related write service points are present.

Table 14.12: RptSwPrototypingAccess

Enumeration	RptAccessEnum
Package	M2::AUTOSARTemplates::CommonStructure::MeasurementCalibrationSupport::RptSupport
Note	Determines the access rights to a data object with respect to rapid prototyping.
Literal	Description
enabled	The related data element is accessible by RP tool. Tags: atp.EnumerationLiteralIndex=0
none	The related data element is not accessible by RP tool. Tags: atp.EnumerationLiteralIndex=1
protected	The data element is known to the RP tool however its usage for RP can be restricted. Use case: limitation based on access rights Tags: atp.EnumerationLiteralIndex=2

Table 14.13: RptAccessEnum

14.5.2 Service Points

Access to the `RP global buffers` and `RP global measurement buffers` can be implemented by using a service based ECU interface in which an additional `RP Service Component`, such as an “XCP on CAN” or “XCP on Ethernet” service, is added to the ECU application.

An `RP Service Component` is an AUTOSAR or vendor specific BSW module providing an RP service, e.g. “XCP on CAN” or “XCP on Ethernet”.

It provides one or more `RP Service Function` where data is sampled and/or stimulated at an `RP Service Point`. Each `RP Service Function` call is passed an `RP Service Point ID` to identify the service point and enable different invocations to be distinguished.

The integration of the service can be performed pre-build by means of source code based integration, for example, by adding an XCP or custom BSW component, or post-build by patching the binary code of an already compiled ECU image.

In a service based scenario data is sampled and/or stimulated at `RP Service Points`. During either sampling or stimulation the data is read and/or written from the memory associated with the `VariableDataPrototype` to/from a local buffer during the execution of the `RP Service Point` and hence transferred to/from the RP tool.

Within the context of the RTE the data stimulated by the `RP Service Points` are the `RP global buffers` and `RP global measurement buffers` however any data that is measurable is potentially subject to reading.

[TPS_SWCT_01722] Semantics of `RP Service Point` [An `RP Service Point` is simply a call of an `RP Service Function` that is provided by the `RP Service Component`.] (*RS_SWCT_03280*)

[TPS_SWCT_01723] Semantics of `RP Service Function` [The `RP Service Function` is responsible for sampling (reading) and stimulating (writing) the bypass data. The action of sampling may then trigger the RP system to perform the bypass (this may involve the communication of the sampled data to an external system for computation) ready for reading when the stimulation occurs.] (*RS_SWCT_03280*)

Service points can be either “SWC Internal” (i.e. inserted by the SWC developer) or “RTE assigned”. SWC Internal service points are included in the SWC description (using `RapidPrototypingScenario`, see below) whereas RTE assigned are created by the RTE generator based on the specification of the SWC.

14.5.2.1 Service Functions

The `RP Service Function` is responsible for sampling the required data. The sampled data is not passed as parameters – the invocation of the `RP Service Function` passes an `RP Service Point ID` as the first parameter of the `RP Service Point` which is used by the `RP Service Component` to identify the service point.

[TPS_SWCT_01724] Semantics of [RapidPrototypingScenario](#) [A [RapidPrototypingScenario](#) aggregates one or more [RptContainers](#) and one or more [RptProfiles](#):

- Each [RptContainer](#) instance specifies, by reference, one or more element(s) applicable to the service-based access.
- Each [RptProfile](#) instance specifies both the name of the [RP Service Function](#) (attributes [servicePointSymbolPre](#) and [servicePointSymbolPost](#)) and the applicable [RP Service Point IDs](#) (attributes [minServicePointId](#) and [maxServicePointId](#)).

]([RS_SWCT_03280](#))

The cross-product of the information from the [RptContainer](#) and [RptProfile](#) within a rapid prototyping scenario is used to construct the service function invocations.

Example: An [RapidPrototypingScenario](#) contains a single [RptContainer](#) that references an [RTEEvent](#) instance, and a single [RptProfile](#) with service point symbol attribute [MyServiceFunction](#). As a result, the RTE generator then wraps invocations of the [RunnableEntity](#) started by the event with calls to service function [MyServiceFunction](#).

Class	RptExecutableEntityProperties			
Package	M2::AUTOSARTemplates::SWComponentTemplate::RPTScenario			
Note	Describes the code preparation for rapid prototyping at ExecutableEntity invocation.			
Base	ARObject			
Attribute	Type	Mult.	Kind	Note
maxRptEventId	PositiveInteger	1	attr	Highest RPT event id useable for RTE generated service points. This attribute is relevant, if dedicated id range shall be applied to the ExecutableEntitys of a software component or specific ExecutableEntitys.
minRptEventId	PositiveInteger	1	attr	Lowest RPT event id useable for RTE generated service points. This attribute is relevant, if dedicated id range shall be applied to the ExecutableEntitys of a software component or specific ExecutableEntitys.
rptExecutionControl	RptExecutionControlEnum	1	attr	This attribute specifies the rapid prototyping control of the executable
rptServicePoint	RptServicePointEnum	1	attr	Enables generation of service points by the RTE generator.

Table 14.14: RptExecutableEntityProperties

Enumeration	RptExecutionControlEnum
Package	M2::AUTOSARTemplates::CommonStructure::MeasurementCalibrationSupport::RptSupport
Note	Determines rapid prototyping preparation of an ExecutableEntity.
Literal	Description
conditional	The ExecutableEntity is only executed when the rapid prototyping disable flag is NOT set. Tags: atp.EnumerationLiteralIndex=0





<i>Enumeration</i>	RptExecutionControlEnum
none	The ExecutableEntity is executed without specific rapid prototyping condition. Tags: atp.EnumerationLiteralIndex=1

Table 14.15: RptExecutionControlEnum

<i>Enumeration</i>	RptServicePointEnum
Package	M2::AUTOSARTemplates::SWComponentTemplate::RPTScenario
Note	Specifies whether the invocation of ExecutableEntitys due to activation of specific RteEvents/Bsw Events requires the insertion of Service Points.
Literal	Description
enabled	Enables generation of service points by the RTE generator. Tags: atp.EnumerationLiteralIndex=0
none	No Service Points are requested. Tags: atp.EnumerationLiteralIndex=1

Table 14.16: RptServicePointEnum

A Glossary

Artifact This is a Work Product Definition that provides a description and definition for tangible work product types. Artifacts may be composed of other artifacts ([49]).

At a high level, an artifact is represented as a single conceptual file.

AUTOSAR Tool This is a software tool which supports one or more tasks defined as AUTOSAR tasks in the methodology. Depending on the supported tasks, an AUTOSAR tool can act as an authoring tool, a converter tool, a processor tool or as a combination of those (see separate definitions).

AUTOSAR Authoring Tool An AUTOSAR Tool used to create and modify AUTOSAR XML Descriptions. Example: System Description Editor.

AUTOSAR Converter Tool An AUTOSAR Tool used to create AUTOSAR XML files by converting information from other AUTOSAR XML files. Example: ECU Flattener

AUTOSAR Definition This is the definition of parameters which can have values. One could say that the parameter values are Instances of the definitions. But in the meta model hierarchy of AUTOSAR, definitions are also instances of the meta model and therefore considered as a description. Examples for AUTOSAR definitions are: `EcucParameterDef`, `PostBuildVariantCriterion`, `SwSystemconst`.

AUTOSAR XML Description In AUTOSAR this means "filled Template". In fact an AUTOSAR XML description is the XML representation of an AUTOSAR model.

The AUTOSAR XML description can consist of several files. Each individual file represents an AUTOSAR partial model and shall validate successfully against the AUTOSAR XML schema.

AUTOSAR Meta-Model This is an UML2.0 model that defines the language for describing AUTOSAR systems. The AUTOSAR meta-model is an UML representation of the AUTOSAR templates. UML2.0 class diagrams are used to describe the attributes and their interrelationships. Stereotypes, UML tags and OCL expressions (object constraint language) are used for defining specific semantics and constraints.

AUTOSAR Meta-Model Tool The AUTOSAR Meta-Model Tool is the tool that generates different views (class tables, list of constraints, diagrams, XML Schema etc.) on the AUTOSAR meta-model.

AUTOSAR Model This is a representation of an AUTOSAR product. The AUTOSAR model represents aspects suitable to the intended use according to the AUTOSAR methodology.

Strictly speaking, this is an instance of the AUTOSAR meta-model. The information contained in the AUTOSAR model can be anything that is representable according to the AUTOSAR meta-model.

AUTOSAR Partial Model In AUTOSAR, the possible partitioning of models is marked in the meta-model by `<<atpSplittable>>`. One partial model is represented in an AUTOSAR XML description by one file. The partial model does not need to fulfill all semantic constraints applicable to an AUTOSAR model.

AUTOSAR Processor Tool An AUTOSAR Tool used to create non-AUTOSAR files by processing information from AUTOSAR XML files. Example: RTE Generator

AUTOSAR Specification Element An AUTOSAR Specification Element is a named element that is part of an AUTOSAR specification. Examples: requirement, constraint, specification item, class or attribute in the meta model, methodology, deliverable, methodology activity, model element, bsw module etc.

AUTOSAR Template The term "Template" is used in AUTOSAR to describe the format different kinds of descriptions. The term template comes from the idea, that AUTOSAR defines a kind of form which shall be filled out in order to describe a model. The filled form is then called the description.

In fact the AUTOSAR templates are now defined as a meta-model.

AUTOSAR Validation Tool A specialized `AUTOSAR Tool` which is able to check an AUTOSAR model against the rules defined by a profile.

AUTOSAR XML Schema This is a W3C XML schema that defines the language for exchanging AUTOSAR models. This Schema is derived from the AUTOSAR meta-model. The AUTOSAR XML Schema defines the AUTOSAR data exchange format.

Blueprint This is a model from which other models can be derived by copy and refinement. Note that in contrast to meta model resp. types, this process is *not* an instantiation.

Instance Generally this is a particular exemplar of a model or of a type.

Life Cycle Life Cycle is the course of development/evolutionary stages of a model element during its life time.

Meta-Model This defines the building blocks of a model. In that sense, a Meta-Model represents the language for building models.

Meta-Data This includes pertinent information about data, including information about the authorship, versioning, access-rights, timestamps etc.

Model A Model is an simplified representation of reality. The model represents the aspects suitable for an intended purpose.

Partial Model This is a part of a model which is intended to be persisted in one particular artifact.

Pattern in GST This is an approach to simplify the definition of the meta model by applying a model transformation. This transformation creates an enhanced model out of an annotated model.

Profile Authoring Support Data Data that is used for efficient authoring of a profile. E.g. list of referable constraints, meta-classes, meta-attributes or other reusable model assets (blueprints)

Profile Authoring Tool A specialized AUTOSAR Tool which focuses on the authoring of profiles for data exchange points. It e.g. provides support for the creation of profiles from scratch, modification of existing profiles or composition of existing profiles.

Profile Compatibility Checker Tool A specialized AUTOSAR Tool which focuses on checking the compatibility of profiles for data exchange. Note that this compatibility check includes manual compatibility checks by engineers and automated assistance using more formal algorithms.

Profile Consistency Checker Tool A specialized AUTOSAR Tool which focuses on checking the consistency of profiles.

Property A property is a structural feature of an object. As an example a “connector” has the properties “receive port” and “send port”

Properties are made variant by the `<<atpVariation>>`.

Prototype This is the implementation of a role of a type within the definition of another type. In other words a type may contain Prototypes that in turn are typed by “Types”. Each one of these prototypes becomes an instance when this type is instantiated.

Type A type provides features that can appear in various roles of this type.

Value This is a particular value assigned to a “Definition”.

Variability Variability of a system is its quality to describe a set of variants. These variants are characterized by variant specific property settings and / or selections. As an example, such a system property selection manifests itself in a particular “receive port” for a connection.

This is implemented using the `<<atpVariation>>`.

Variant A system variant is a concrete realization of a system, so that all its properties have been set respectively selected. The software system has no variability anymore with respect to the binding time.

This is implemented using `EvaluatedVariantSet`.

Variation Binding A variant is the result of a variation binding process that resolves the variability of the system by assigning particular values/selections to all the system’s properties.

This is implemented by `VariationPoint`.

Variation Binding Time The variation binding time determines the step in the methodology at which the variability given by a set of variable properties is resolved.

This is implemented by `vh.LatestBindingtime` at the related properties.

Variation Definition Time The variation definition time determines the step in the methodology at which the variation points are defined.

Variation Point A variation point indicates that a property is subject to variation. Furthermore, it is associated with a condition and a binding time which define the system context for the selection / setting of a concrete variant.

This is implemented by `VariationPoint`.

B Supported Special Use Cases

B.1 Asymmetric Data Transformation between a Software-Component and a Complex Driver

B.1.1 Overview

In this scenario, a `SwComponentPrototype` typed by an `ApplicationSwComponentType` needs to communicate with a `SwComponentPrototype` typed by a `ComplexDeviceDriverSwComponentType`.

The communication itself is special insofar as it ends in an arbitrary structured data type on the side of the `ApplicationSwComponentType` and in a flat byte array on the side of the `ComplexDeviceDriverSwComponentType`.

The communication itself has a client-server nature, where the `ApplicationSwComponentType` mostly acts as the client and the `ComplexDeviceDriverSwComponentType` acts as the server.

As a consequence of this set-up, the structured data type somehow has to be serialized into a flat byte array for the call and from flat byte array to structure data type for the returning of the *out* and *inout* arguments as well as the return value.

For a justification of the use case, let's assume that the `ComplexDeviceDriverSwComponentType` implements an endpoint of a custom communication protocol that needs to interact with the "AUTOSAR world".

This is also the reason why the server implements `ClientServerOperations` with a flat byte array as the argument. The server (in this case, the `ComplexDeviceDriverSwComponentType`) itself is completely agnostic of the data, it just represents the endpoint that has to be able to deal with any given data structure.

This means that the `ComplexDeviceDriverSwComponentType` does not have to be updated and redeployed if the data structures on the side of the `ApplicationSwComponentType` undergo any changes.

For the `ApplicationSwComponentType`, on the other hand, there is little motivation to also model the respective data structures as a flat byte array. Usually, the respective data comes from a mixture of internal processing and communication with other software-components.

In other words, using a flat byte array on the side of the `ApplicationSwComponentType` would mean that the serialization has to be done anyway, potentially inside the implementation of the `ApplicationSwComponentType` itself.

Specifically, the conversion from the (structured) data type to a flat byte array and back needs to be implemented by a piece of software that is typically generated according to the structure of the data type. This software, however, is **very specific** and only fits to the corresponding data types.

One approach for data serialization in AUTOSAR is the generic concept of data transformation, in the specific case of this scenario a data transformer is needed that does a depth-first serialization over a complex data structure.

This approach is already supported in AUTOSAR by means of the so-called SOME/IP Transformer [50].

This existing concept can be taken over for the implementation of the scenario described in this chapter, albeit with some customizations. For example, the SOME/IP-specific protocol header generated by the SOME/IP Transformer is obviously not relevant for the scenario.

B.1.2 Modeling Aspects

The modeling of this use case shall be explained along a simple example sketched in Figure B.1:

- It is necessary to define two individual `ClientServerOperationMappings`.
 - One of these (in this example: CSOM1) shall reference a `DataTransformation` where attribute `dataTransformationKind` is set to the value `DataTransformationKindEnum.asymmetricToByteArray`.
 - The other (in this example: CSOM2) shall reference a `DataTransformation` where attribute `dataTransformationKind` is set to the value `DataTransformationKindEnum.asymmetricFromByteArray`.
- CSOM1 shall reference the `ClientServerOperation` Op1 (on the end of the `ApplicationSwComponentType`) in the role `firstOperation`.
- CSOM1 shall reference the `ClientServerOperation` Op2 (on the end of the `ComplexDeviceDriverSwComponentType`) in the role `secondOperation`.
- CSOM2 shall reference the `ClientServerOperation` Op1 (on the end of the `ApplicationSwComponentType`) in the role `secondOperation`.
- CSOM2 shall reference the `ClientServerOperation` Op2 (on the end of the `ComplexDeviceDriverSwComponentType`) in the role `firstOperation`.
- CSOM1 shall aggregate two `DataPrototypeMappings` in the role `argumentMapping`
 - The first `DataPrototypeMapping` shall reference (in the role `firstDataPrototype`) the `ArgumentDataPrototype` named `In1` of `ClientServerOperation` OP1 and (in the role `secondDataPrototype`) the `ArgumentDataPrototype` named `In` of `ClientServerOperation` OP2.
 - The second `DataPrototypeMapping` shall reference (in the role `firstDataPrototype`) the `ArgumentDataPrototype` named `In2` of

ClientServerOperation OP1 and (in the role secondDataPrototype) the ArgumentDataPrototype named In of ClientServerOperation OP2.

- CSOM2 shall aggregate two DataPrototypeMappings in the role argumentMapping
 - The first DataPrototypeMapping shall reference (in the role firstDataPrototype) the ArgumentDataPrototype named Out1 of ClientServerOperation OP1 and (in the role secondDataPrototype) the ArgumentDataPrototype named Out of ClientServerOperation OP2.
 - The second DataPrototypeMapping shall reference (in the role firstDataPrototype) the ArgumentDataPrototype named Out2 of ClientServerOperation OP1 and (in the role secondDataPrototype) the ArgumentDataPrototype named Out of ClientServerOperation OP2.

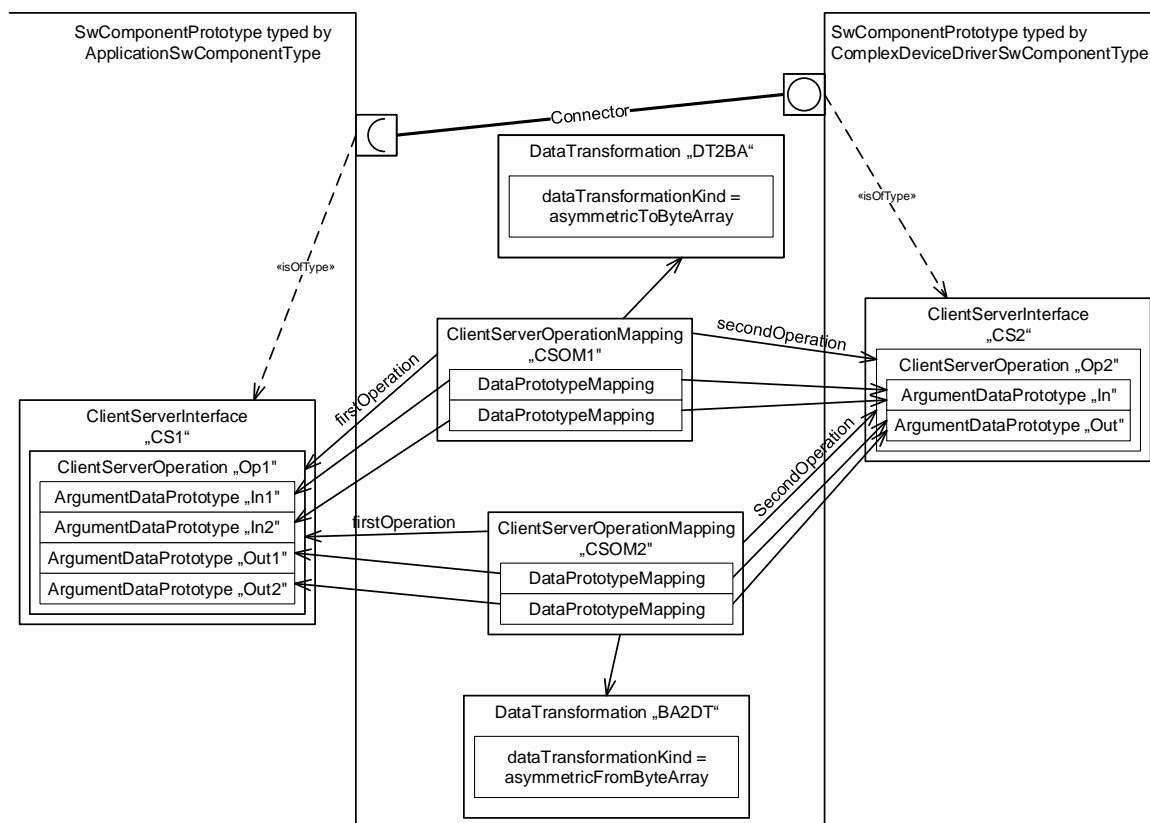

Figure B.1: Modeling of the data transformation use case

Please note that in Figure B.1 the role names of references from DataPrototypeMapping have been left out of the picture for reasons of simplicity.

C History of Constraints and Specification Items

Please note that the lists in this chapter also include constraints and specification items that have been removed from the specification in a later version. These constraints and specification items do not appear as hyperlinks in the document.

C.1 Constraint History of this Document according to AUTOSAR R4.0.1

C.1.1 Changed Constraints in R4.0.1

N/A

C.1.2 Added Constraints in R4.0.1

Number	Heading
[constr_1000]	End-to-end protection is limited to sender/receive communication
[constr_1001]	Value of <code>dataId</code> shall be unique
[constr_1002]	End-to-end protection does not support n:1 communication
[constr_1004]	Mapping of <code>ApplicationDataTypes</code>
[constr_1005]	Compatibility of <code>ImplementationDataTypes</code> mapped to the same <code>Application-DataType</code>
[constr_1006]	applicable data <code>categorys</code>
[constr_1007]	Allowed attributes of <code>SwDataDefProps</code> for <code>ApplicationDataTypes</code>
[constr_1008]	Applicability of <code>categorys</code> STRUCTURE and ARRAY
[constr_1009]	<code>SwDataDefProps</code> applicable to <code>ImplementationDataTypes</code>
[constr_1010]	If <code>nativeDeclaration</code> does not exist
[constr_1011]	<code>category</code> of <code>SwBaseType</code>
[constr_1012]	Value of <code>category</code> is <code>FIXED_LENGTH</code>
[constr_1013]	Value of <code>category</code> is <code>VARIABLE_LENGTH</code>
[constr_1014]	Supported value encodings for <code>SwBaseType</code>
[constr_1015]	Prioritization of <code>SwDataDefProps</code>
[constr_1016]	<code>invalidValue</code> is restricted
[constr_1017]	Supported combinations of <code>swImplPolicy</code> and <code>swCalibrationAccess</code>
[constr_1018]	<code>measurementPoint</code> shall not be referenced by a <code>VariableAccess</code> aggregated by <code>RunnableEntity</code> in the role <code>dataReadAccess</code>
[constr_1019]	Compatibility of input value and axis





Number	Heading
[constr_1020]	<code>ParameterDataPrototype</code> needs to be of compatible data type as referenced in <code>sharedAxisType</code>
[constr_1021]	A <code>CompuMethod</code> shall specify instructions for both directions
[constr_1022]	Limits shall be defined for each direction of <code>CompuMethod</code>
[constr_1023]	Specification of <code>Units</code> in <code>CompuMethods</code>
[constr_1024]	Stepwise definition of <code>CompuMethods</code>
[constr_1025]	Avoid division by zero in rational formula
[constr_1026]	Compatibility of <code>Units</code>
[constr_1027]	Types for record layouts
[constr_1029]	<code>ConstantSpecificationMapping</code> and <code>ConstantSpecification</code>
[constr_1030]	<code>ParameterSwComponentType</code> references <code>ConstantSpecificationMappingSet</code>
[constr_1031]	<code>NvBlockSwComponentType</code> references <code>ConstantSpecificationMappingSet</code>
[constr_1032]	<code>DelegationSwConnector</code> can only connect <code>PortPrototypes</code> of the same kind
[constr_1033]	Communication scenarios for sender/receiver communication
[constr_1035]	Recursive definition of <code>CompositionSwComponentType</code>
[constr_1036]	Connect kinds of <code>PortInterfaces</code>
[constr_1037]	Client may not connect to multiple servers
[constr_1038]	Reference to <code>ApplicationError</code>
[constr_1039]	Relevance of <code>swImplPolicy</code>
[constr_1040]	Conversion of <code>SenderReceiverInterfaces</code>
[constr_1041]	Conversion of <code>ClientServerInterfaces</code>
[constr_1042]	Definition of a linear data scaling
[constr_1043]	<code>PortInterface</code> vs. <code>ComSpec</code>
[constr_1044]	Applicability of <code>DataFilter</code>
[constr_1045]	Supported value encodings for <code>SwBaseType</code> in the context of <code>PortInterfaces</code>
[constr_1046]	Applicability of [constr_1045]
[constr_1047]	Compatibility of <code>ApplicationPrimitiveDataTypes</code>
[constr_1048]	Compatibility of <code>ApplicationRecordDataTypes</code>
[constr_1049]	Compatibility of <code>ApplicationArrayDataTypes</code>
[constr_1050]	Compatibility of <code>ImplementationDataTypes</code>
[constr_1051]	Compatibility of <code>SwDataDefProps</code>
[constr_1052]	Compatibility of <code>Units</code>
[constr_1053]	Compatibility of <code>PhysicalDimensions</code>
[constr_1054]	No <code>DataConstr</code> available at the provider
[constr_1055]	<code>ImplementationDataType</code> has <code>category</code> VALUE
[constr_1056]	<code>ImplementationDataType</code> has <code>category</code> TYPE_REFERENCE
[constr_1057]	<code>ImplementationDataType</code> has <code>category</code> DATA_REFERENCE





Number	Heading
[constr_1058]	ImplementationDataType has category FUNCTION_REFERENCE
[constr_1059]	Compatibility of data types with category VALUE
[constr_1060]	Compatibility of data types with category ARRAY, VAL_BLK, or STRING
[constr_1061]	Compatibility of data types with category STRUCTURE
[constr_1062]	Compatibility of data types with category BIT
[constr_1063]	Compatibility of data types with category BOOLEAN
[constr_1064]	Compatibility of data types with category COM_AXIS, RES_AXIS, CURVE or MAP
[constr_1066]	ApplicationDataType is or is not compatible to specific Implementation-DataType
[constr_1067]	ApplicationDataType is or is not compatible to specific Implementation-DataType
[constr_1068]	Compatibility of VariableDataPrototypes or ParameterDataPrototypes typed by primitive data types
[constr_1069]	Compatibility of PortPrototypes of different DataInterfaces in the context of AssemblySwConnectors
[constr_1070]	Compatibility of PortPrototypes of different DataInterfaces in the context of DelegationSwConnectors
[constr_1071]	compatibility of compatibility of ParameterDataPrototype and VariableDataPrototype
[constr_1072]	Compatibility of ModeSwitchInterfaces in the context of an AssemblySwConnector
[constr_1073]	Compatibility of ModeSwitchInterfaces in the context of an DelegationSwConnector
[constr_1074]	Compatibility of ModeDeclarationGroupPrototypes
[constr_1075]	Compatibility of ModeDeclarationGroups
[constr_1076]	Compatibility of ArgumentDataPrototypes
[constr_1077]	Compatibility of ApplicationErrors
[constr_1078]	Compatibility of ClientServerOperations
[constr_1079]	Compatibility of ClientServerInterfaces in the context of an AssemblySwConnector
[constr_1080]	Compatibility of ClientServerInterfaces in the context of an DelegationSwConnector
[constr_1081]	Compatibility of TriggerInterfaces in the context of an AssemblySwConnector
[constr_1082]	Compatibility of TriggerInterfaces in the context of an DelegationSwConnector
[constr_1083]	Compatibility of Triggers
[constr_1084]	delegation of an provided outer PortPrototype
[constr_1085]	Compatibility in the case of a flat ECU extract
[constr_1086]	SwConnector between two specific PortPrototypes
[constr_1087]	AssemblySwConnector inside CompositionSwComponentType
[constr_1088]	DelegationSwConnector inside CompositionSwComponentType





Number	Heading
[constr_1090]	WaitPoint and RunnableEntity
[constr_1091]	RTEEvents that can unblock a WaitPoint
[constr_1092]	ParameterSwComponentType
[constr_1093]	Definition of textual strings
[constr_1094]	Usage of symbol of RunnableEntity
[constr_1095]	Values of nDataSets vs. reliability
[constr_1096]	SwcModeSwitchEvent and WaitPoint
[constr_1097]	RunnableEntity that has a WaitPoint
[constr_1098]	Mode switch and mode disabling
[constr_1099]	Data type of inter-runnable variables
[constr_1100]	Unconnected RPortPrototype typed by a DataInterface
[constr_1101]	Mode-related communication
[constr_1102]	ApplicationError in the scope of one SwComponentType
[constr_1103]	NonqueuedReceiverComSpec and enableUpdate
[constr_1104]	Trigger sink and trigger source
[constr_1105]	Value of arraySize
[constr_1106]	Structure shall have at least one element
[constr_1107]	Union shall have at least one element
[constr_1108]	Value of ApplicationError.errorCode
[constr_1109]	Mapping of SwComponentPrototypes typed by a SensorActuatorSwComponentType
[constr_1110]	Value of category in EndToEndDescription
[constr_1111]	Constraints of dataId in PROFILE_01
[constr_1112]	Constraints of dataIdMode in PROFILE_01
[constr_1113]	Existence of attributes in PROFILE_01
[constr_1114]	Constraints of crcOffset in PROFILE_01
[constr_1115]	Constraints of counterOffset in PROFILE_01
[constr_1116]	Constraints of dataLength in PROFILE_01
[constr_1117]	Constraints of maxDeltaCounterInit in PROFILE_01
[constr_1118]	Existence of attributes in PROFILE_02
[constr_1119]	Constraints of dataLength in PROFILE_02
[constr_1120]	Constraints of dataId in PROFILE_02
[constr_1121]	Constraints of maxDeltaCounterInit in PROFILE_02
[constr_1122]	Existence of attributes in PROFILE_03
[constr_1123]	Constraints of dataLength in PROFILE_03
[constr_1124]	Constraints of dataId in PROFILE_03
[constr_1125]	Constraints of maxDeltaCounterInit in PROFILE_03
[constr_1126]	Compatibility of DataConstrs





Number	Heading
[constr_2000]	Compatibility of <code>ClientServerOperations</code> triggering the same <code>RunnableEntity</code>
[constr_2001]	Initial value for a specific <code>implicitInterRunnableVariable</code> or <code>explicitInterRunnableVariable</code>
[constr_2002]	Referenced <code>VariableDataPrototype</code> from <code>AutosarVariableRef</code> of <code>VariableAccess</code> in role <code>dataReadAccess</code>
[constr_2003]	Referenced <code>VariableDataPrototype</code> from <code>AutosarVariableRef</code> of <code>VariableAccess</code> in role <code>dataWriteAccess</code>
[constr_2004]	Referenced <code>VariableDataPrototype</code> from <code>AutosarVariableRef</code> of <code>VariableAccess</code> in role <code>dataSendPoint</code>
[constr_2005]	Referenced <code>VariableDataPrototype</code> from <code>AutosarVariableRef</code> of <code>VariableAccess</code> in role <code>dataReceivePointByValue</code> or <code>dataReceivePointByArgument</code>
[constr_2006]	Number of <code>AsynchronousServerCallResultPoint</code> referencing to one <code>AsynchronousServerCallPoint</code>
[constr_2007]	Consistency of <code>typeDefinition</code> attribute
[constr_2009]	Supported kinds of ports of a <code>NvBlockSwComponentType</code>
[constr_2010]	Connections between <code>SwComponentPrototypes</code> of type <code>NvBlockSwComponentType</code>
[constr_2011]	Connections between <code>SwComponentPrototypes</code> typed by <code>NvBlockSwComponentType</code> and <code>SwComponentPrototypes</code> typed by other <code>AtomicSwComponentTypes</code>
[constr_2012]	Compatibility of <code>ImplementationDataTypes</code> used for <code>ramBlock</code> and <code>romBlock</code>
[constr_2013]	Compatibility of <code>ImplementationDataTypes</code> for <code>NvBlockDataMapping</code>
[constr_2014]	Limitation of <code>RoleBasedPortAssignment.role</code> in <code>NvBlockDescriptors</code>
[constr_2015]	Limitation of <code>SwcInternalBehavior</code> of a <code>NvBlockSwComponentType</code>
[constr_2016]	Connections between <code>SwComponentPrototypes</code> of type <code>ServiceProxySwComponentType</code>
[constr_2017]	Ports of <code>ServiceProxySwComponentTypes</code>
[constr_2018]	Supported remote communication of a <code>ServiceProxySwComponentType</code>
[constr_2019]	<code>ServiceSwComponentType</code> shall have service ports only
[constr_2020]	<code>dataReadAccess</code> can not be used for queued communication
[constr_2021]	<code>WaitPoint</code> referencing a <code>DataReceivedEvent</code> can not be used for non-queued communication
[constr_2022]	Mutually exclusive use of <code>SynchronousServerCallPoints</code> and <code>AsynchronousServerCallPoints</code>
[constr_2023]	Consistency of <code>timeout</code> values
[constr_2024]	<code>enableTakeAddress</code> is restricted to single instantiation
[constr_2025]	Uniqueness of <code>symbol</code> attributes
[constr_2026]	Referenced <code>VariableDataPrototype</code> from <code>AutosarVariableRef</code> of <code>VariableAccess</code> in role <code>writtenLocalVariable</code> and <code>readLocalVariable</code>
[constr_2027]	<code>SwcServiceDependency</code> shall be defined for service ports only



△

Number	Heading
[constr_2028]	<code>staticMemory</code> is restricted to single instantiation
[constr_2029]	<code>shortName</code> of <code>constantMemory</code> and <code>staticMemory</code>
[constr_2030]	<code>AsynchronousServerCallResultPoint</code> combined with <code>WaitPoint</code> shall belong to the same <code>RunnableEntity</code>
[constr_2031]	Period of <code>TimingEvent</code> shall be greater than 0
[constr_2032]	<code>transmissionAcknowledge</code> requires a <code>DataSendCompletedEvent</code>
[constr_2033]	Timeout of <code>DataSendCompletedEvent</code>
[constr_2500]	<code>PortInterfaces</code> shall be of same kind
[constr_2526]	<code>PortInterfaces</code> need to be compatible to the blueprints
[constr_2527]	Blueprints shall live in package of a proper category
[constr_2528]	<code>PortPrototypes</code> shall not refer to blueprints of <code>PortInterfaces</code>
[constr_2529]	Blueprints of ports and interfaces shall be compatible
[constr_2533]	Iteration along output axis is only supported for VALUE and VAL_BLK
[constr_4000]	Local communication of mode switches
[constr_4001]	Content of <code>ModeRequestTypeMap</code>
[constr_4002]	Unambiguous mapping of modes to data types
[constr_4003]	Semantics of <code>SwcModeSwitchEvent</code>
[constr_4004]	Context of <code>SenderReceiverAnnotation</code>
[constr_4005]	Context of <code>ClientServerAnnotation</code>
[constr_4006]	Context of <code>ParameterPortAnnotation</code>
[constr_4007]	Context of <code>ModePortAnnotation</code>
[constr_4008]	Context of <code>TriggerPortAnnotation</code>
[constr_4009]	Context of <code>NvDataPortAnnotation</code>
[constr_4010]	Context of <code>DelegatedPortAnnotation</code>
[constr_4011]	<code>ComSpec</code> and <code>ModeSwitchedAckEvent</code>
[constr_4012]	Timeout of <code>ModeSwitchedAckEvent</code>
[constr_4035]	<code>ValueSpecification</code> shall fit into data type

Table C.1: Added Constraints in R4.0.1

C.1.3 Deleted Constraints

N/A

C.2 Constraint History of this Document according to AUTOSAR R4.0.2

C.2.1 Changed Constraints in R4.0.2

Number	Heading
[constr_1007]	Allowed attributes of <code>SwDataDefProps</code> for <code>ApplicationDataTypes</code>
[constr_1061]	Compatibility of data types with <code>category</code> STRUCTURE
[constr_2001]	Initial value for a specific <code>implicitInterRunnableVariable</code> or <code>explicitInterRunnableVariable</code>

Table C.2: Changed Constraints in R4.0.2

C.2.2 Added Constraints in R4.0.2

Number	Heading
[constr_1127]	<code>ServiceSwComponentType</code> shall not have <code>ServiceNeeds</code>
[constr_1128]	Queue length of <code>ClientServerOperations</code> associated with the same <code>RunnableEntity</code>
[constr_1129]	<code>swImplPolicy</code> and <code>NonqueuedReceiverComSpec</code>
[constr_1130]	<code>swImplPolicy</code> and <code>NonqueuedReceiverComSpec</code>
[constr_1131]	<code>swImplPolicy</code> and <code>NonqueuedSenderComSpec</code>
[constr_1132]	<code>swImplPolicy</code> and <code>NonqueuedSenderComSpec</code>
[constr_1133]	Identical <code>CompuScale</code> Symbolic Names shall have the same range
[constr_1134]	Allowed structure of <code>TEXTTABLE</code>
[constr_1135]	Limit of <code>vt</code> in <code>BITFIELD_TEXTTABLE</code>
[constr_1136]	Compatibility of introduction of blueprint and blueprinted element
[constr_1137]	Applicability of <code>ParameterInterface</code>
[constr_1138]	<code>assignedPort</code> and <code>DiagEventDebounceMonitorInternal</code>
[constr_1139]	<code>assignedPort</code> of <code>DiagEventDebounceMonitorInternal</code> shall refer to an <code>RPortPrototype</code>
[constr_2034]	<code>SwAddrMethod</code> referenced by <code>RunnableEntity</code> s or <code>BswSchedulableEntity</code> s
[constr_2035]	<code>swImplPolicy</code> for <code>VariableDataPrototype</code> in <code>SenderReceiverInterface</code>
[constr_2036]	<code>swImplPolicy</code> for <code>VariableDataPrototype</code> in <code>NvDataInterface</code>
[constr_2037]	<code>swImplPolicy</code> for <code>VariableDataPrototype</code> in the role <code>ramBlock</code>
[constr_2038]	<code>swImplPolicy</code> for <code>VariableDataPrototype</code> in the role <code>implicitInterRunnableVariable</code>
[constr_2039]	<code>swImplPolicy</code> for <code>VariableDataPrototype</code> in the role <code>explicitInterRunnableVariable</code>
[constr_2040]	<code>swImplPolicy</code> for <code>VariableDataPrototype</code> in the role <code>arTypedPerInstanceMemory</code>
[constr_2041]	<code>swImplPolicy</code> for <code>VariableDataPrototype</code> in the role <code>staticMemory</code>





Number	Heading
[constr_2042]	swImplPolicy for ParameterDataPrototype in ParameterInterface
[constr_2043]	swImplPolicy for ParameterDataPrototype in the role staticMemory
[constr_2044]	swImplPolicy for ParameterDataPrototype in the role sharedParameter
[constr_2045]	swImplPolicy for ParameterDataPrototype in the role perInstanceParameter
[constr_2046]	swImplPolicy for ParameterDataPrototype in the role constantMemory
[constr_2047]	swImplPolicy for ArgumentDataPrototype
[constr_2048]	swImplPolicy for SwServiceArg
[constr_2535]	Target of an autosarParameter in AutosarParameterRef shall refer to a parameter
[constr_2536]	Target of an autosarVariable in AutosarVariableRef shall refer to a variable

Table C.3: Added Constraints in R4.0.2

C.2.3 Deleted Constraints in R4.0.2

Number	Heading
[constr_1099]	Data type of inter-runnable variables

Table C.4: Deleted Constraints in R4.0.2

C.3 Constraint History of this Document according to AUTOSAR R4.0.3

C.3.1 Changed Constraints in R4.0.3

Number	Heading
[constr_1006]	applicable data categorys
[constr_1009]	SwDataDefProps applicable to ImplementationDataTypes
[constr_1014]	Supported value encodings for SwBaseType
[constr_1015]	Prioritization of SwDataDefProps
[constr_1043]	PortInterface vs. ComSpec
[constr_1051]	Compatibility of SwDataDefProps
[constr_1053]	Compatibility of PhysicalDimensions
[constr_1063]	Compatibility of data types with category BOOLEAN
[constr_1110]	Value of category in EndToEndDescription
[constr_1113]	Existence of attributes in PROFILE_01
[constr_1118]	Existence of attributes in PROFILE_02





Number	Heading
[constr_1134]	Allowed structure of <code>TEXTTABLE</code>
[constr_2000]	Compatibility of <code>ClientServerOperations</code> triggering the same <code>RunnableEntity</code>
[constr_2027]	<code>SwcServiceDependency</code> shall be defined for service ports only

Table C.5: Changed Constraints in R4.0.3

C.3.2 Added Constraints in R4.0.3

Number	Heading
[constr_1140]	Combination of <code>invalidValue</code> with the attribute <code>handleInvalid</code>
[constr_1141]	Applicability of the <code>scope</code> attribute
[constr_1142]	<code>category</code> of <code>CompuMethod</code> shall not be extended
[constr_1143]	<code>category</code> of <code>AutosarDataType</code> shall not be extended
[constr_1144]	<code>SensorActuatorSwComponentType</code> , <code>EcuAbstractionSwComponentType</code> , and <code>ComplexDeviceDriverSwComponentType</code> may only reference a <code>HwType</code>
[constr_1145]	Finding the symbol for the representation of a <code>CompuScale</code> in C code
[constr_1146]	Applicability of a symbol for a <code>CompuScale</code> in C code
[constr_1147]	Standardized values for the attribute <code>category</code> of meta-class <code>PortGroup</code>
[constr_1148]	<code>PortInterfaces</code> of <code>PortPrototypes</code> used to connect to <code>NvBlockSwComponentTypes</code>
[constr_1149]	<code>PortPrototypes</code> used for NV data management
[constr_1150]	Usage of <code>valueType</code> for <code>PortDefinedArgumentValue</code>
[constr_1151]	Applicability of <code>PortInterfaceMapping</code>
[constr_1151]	<code>category</code> of <code>ApplicationArrayElement</code> and <code>AutosarDataType</code> referenced in the role <code>type</code> shall be kept in sync
[constr_1153]	Applicability of compatibility requirements for <code>CompuScales</code>
[constr_1154]	Compatibility of <code>CompuScales</code> for sender-receiver communication and similar use cases
[constr_1155]	Compatibility of <code>CompuScales</code> for client-server communication
[constr_1156]	Relevance of “names” of <code>CompuScales</code>
[constr_1157]	Applicability of constraints of <code>CompuScales</code>
[constr_1158]	Applicable <code>categorys</code> for attribute <code>compuMethod</code>
[constr_1159]	Consistency of <code>VariableAndParameterInterfaceMapping</code> with respect to the referenced <code>DataInterfaces</code>
[constr_1160]	Size of Compound Primitive Data Type is variant
[constr_1161]	Applicability of the <code>index</code> attribute of <code>Ref</code>
[constr_1162]	Compatibility of <code>SwRecordLayouts</code>
[constr_1163]	Compatibility of <code>CompuMethods</code>
[constr_1164]	Number of <code>arguments</code> owned by a <code>RunnableEntity</code>





Number	Heading
[constr_1165]	Applicability of <code>RunnableEntityArgument</code>
[constr_1166]	Restrictions of <code>ModeRequestTypeMap</code>
[constr_1167]	<code>ImplementationDataTypes</code> used as <code>ModeRequestTypeMap.implementationDataType</code>
[constr_1168]	Compatibility of <code>ImplementationDataTypes</code> used used in the <code>ModeRequestTypeMap</code>
[constr_1169]	Allowed values for <code>Trigger.swImplPolicy</code>
[constr_1170]	Interpretation of attribute <code>maxDeltaCounterInit</code> owned by <code>EndToEndDescription</code>
[constr_1171]	Interpretation of attribute <code>maxDeltaCounterInit</code> of <code>EndToEndDescription</code>
[constr_1172]	Allowed values of <code>SwCalibrationAccessEnum</code> for <code>ModeDeclarationGroupPrototype</code>
[constr_1173]	Applicability of <code>AutosarParameterRef</code> referencing a <code>VariableDataPrototype</code>
[constr_1174]	<code>PortInterfaces</code> used in the context of <code>CompositionSwComponentTypes</code> cannot refer to AUTOSAR services
[constr_1175]	Depending on its <code>category</code> , <code>CompuMethod</code> shall refer to a unit
[constr_1176]	Compatibility of <code>CompuScales</code> of <code>category</code> <code>LINEAR</code> and <code>RAT_FUNC</code>
[constr_1177]	Allowed <code>category</code> for <code>SwPointerTargetProps</code>
[constr_1178]	Existence of attributes of <code>SwDataDefProps</code> in the context of <code>ImplementationDataType</code>
[constr_1179]	Existence of <code>ModeDeclaration.value</code> within a <code>ModeDeclarationGroup</code>
[constr_1180]	Existence of <code>ModeDeclarationGroup.onTransitionValue</code>
[constr_1181]	Numerical values used in <code>ModeDeclaration.value</code> and <code>ModeDeclarationGroup.onTransitionValue</code>
[constr_1182]	Allowed values for <code>InternalTriggeringPoint.swImplPolicy</code>
[constr_1183]	<code>EndToEndProtectionVariablePrototypes</code> aggregated by <code>EndToEndProtection</code>
[constr_1184]	Consistency of <code>rootDataPrototype</code> and <code>base</code> in the context of <code>ApplicationCompositeElementInPortInterfaceInstanceRef</code>
[constr_1185]	Consistency of data types in the context of <code>ApplicationCompositeElementInPortInterfaceInstanceRef</code>
[constr_1186]	Consistency of data types in the context of <code>ArVariableInImplementationDataInstanceRef</code>
[constr_1187]	Compatibility of <code>VariableDataPrototypes</code> or <code>ParameterDataPrototypes</code> typed by composite data types
[constr_1188]	Existence of <code>ReceiverComSpec.replaceWith</code>
[constr_1189]	Allowed targets of <code>externalReplacement</code>
[constr_1190]	Only one mapping for composite to primitive use case
[constr_2049]	Different <code>ModeDeclarationGroups</code> shall have different <code>shortNames</code> .
[constr_2050]	Mandatory information of a <code>SwAxisCont</code>
[constr_2051]	Mandatory information of a <code>SwValueCont</code>





Number	Heading
[constr_2052]	Values of <code>swArraysizes</code> and the number of values provided by <code>swValuesPhys</code> shall be consistent.
[constr_2053]	Consistency between <code>role</code> <code>IUMPRNumerator</code> and <code>ObdRatioServiceNeeds.connectionType</code>
[constr_2544]	Limits need to be consistent
[constr_2545]	<code>invalidValue</code> shall fit in the specified ranges
[constr_2548]	Data constraint of value axis shall match
[constr_2549]	Units of input axis shall be consistent
[constr_2550]	Units of value axis shall be consistent
[constr_2551]	<code>SwCalprmAxis.baseType</code> shall be ignored
[constr_2561]	Application of <code>DataConstrRule.constrLevel</code>

Table C.6: Added Constraints in R4.0.3

C.3.3 Added Specification Items in R4.0.3

Number	Heading
[TPS_SWCT_01000]	Usage of attribute <code>symbol</code> of the <code>symbolProps</code>
[TPS_SWCT_01001]	Prefix symbols generated for the <code>RunnableEntity</code>
[TPS_SWCT_01002]	<code>SwComponentTypes</code> may only interact by means of their <code>PortPrototypes</code>
[TPS_SWCT_01003]	Inconsistencies regarding the value of <code>serviceKind</code> and the actual implementation of the <code>PortInterface</code>
[TPS_SWCT_01004]	Default value if <code>serviceKind</code> is not defined
[TPS_SWCT_01005]	Usage of <code>SwcServiceDependencies</code> for vendor-specific services
[TPS_SWCT_01006]	<code>arraySize</code> of <code>ImplementationDataType</code> shall be used to define the size of the array
[TPS_SWCT_01007]	Semantics of array index
[TPS_SWCT_01008]	Definition of positive integer values that are directly taken over by the RTE generator for creating the programmatic representations of the <code>ModeDeclaration</code>
[TPS_SWCT_01009]	The numerical values used to define the values of <code>ModeDeclaration.value</code> and <code>ModeDeclarationGroup.onTransitionValue</code> can be arbitrarily defined
[TPS_SWCT_01010]	<code>categorys</code> for the definition of a <code>ModeDeclarationGroup</code>
[TPS_SWCT_01011]	Default <code>category</code> of a <code>ModeDeclarationGroup</code>
[TPS_SWCT_01012]	<code>AtomicSwComponentType</code> reads the current ECU mode (fixed variant)
[TPS_SWCT_01013]	<code>AtomicSwComponentType</code> shall keep the ECU alive (fixed variant)
[TPS_SWCT_01014]	<code>AtomicSwComponentType</code> wants to select a shutdown target (fixed variant)
[TPS_SWCT_01015]	<code>AtomicSwComponentType</code> wants to select a boot target (fixed variant)





Number	Heading
[TPS_SWCT_01016]	<code>AtomicSwComponentType</code> wants to select a shutdown target (flexible variant)
[TPS_SWCT_01017]	<code>AtomicSwComponentType</code> wants to select a boot target (flexible variant)
[TPS_SWCT_01018]	<code>AtomicSwComponentType</code> wants to use an alarm clock (flexible variant)
[TPS_SWCT_01019]	<code>AtomicSwComponentType</code> reads the current ComM mode
[TPS_SWCT_01020]	<code>AtomicSwComponentType</code> requests a ComM mode. It may also check later whether the requested ComM mode has become effective
[TPS_SWCT_01021]	<code>AtomicSwComponentType</code> acts as a mode manager that influences the ECU state
[TPS_SWCT_01022]	Queued processing of internal trigger
[TPS_SWCT_01023]	Mapping of elements of composite data types
[TPS_SWCT_01024]	Combination of <code>ApplicationCompositeDataType</code> and nested <code>ImplementationDataType</code>
[TPS_SWCT_01025]	The role of <code>PortPrototypes</code> in the AUTOSAR architecture
[TPS_SWCT_01026]	The role of <code>PortInterfaces</code> in the AUTOSAR architecture
[TPS_SWCT_01027]	Different flavors of <code>PortInterfaces</code>
[TPS_SWCT_01028]	<code>AtomicSwComponentType</code> implements a Diagnostic Monitor
[TPS_SWCT_01029]	<code>AtomicSwComponentType</code> implements a Diagnostic Monitor
[TPS_SWCT_01030]	<code>RunnableEntity</code>
[TPS_SWCT_01031]	<code>ExclusiveArea</code>
[TPS_SWCT_01032]	<code>CompositionSwComponentType</code>
[TPS_SWCT_01033]	Nested definition of <code>CompositionSwComponentTypes</code>
[TPS_SWCT_01034]	<code>CompositionSwComponentTypes</code> do not have any binary footprint
[TPS_SWCT_01035]	<code>CompositionSwComponentType</code> aggregates <code>SwComponentPrototypes</code>
[TPS_SWCT_01036]	<code>SwComponentPrototype</code> implements a specific role
[TPS_SWCT_01037]	arbitrary numbers of <code>SwComponentPrototypes</code> can be created
[TPS_SWCT_01038]	Support for Variant Handling in the in Software Component Template
[TPS_SWCT_01039]	Purpose of variant handling
[TPS_SWCT_01040]	<code>SwConnector</code> exists depending on a <code>PostBuild</code> condition
[TPS_SWCT_01041]	API functions of not existing <code>SwConnector</code> are still part of the software-component's implementation
[TPS_SWCT_01042]	Four types of locations in the meta-model which may exhibit variability
[TPS_SWCT_01043]	<code>ApplicationSwComponentTypes</code> are independent from actual ECU Hardware
[TPS_SWCT_01044]	<code>ServiceNeeds</code>
[TPS_SWCT_01045]	Actual values of ECU configuration parameters fulfill the requirements given by the <code>ServiceNeeds</code>
[TPS_SWCT_01046]	<code>ServiceNeeds</code> are defined in the scope of the <code>SwcInternalBehavior</code>





Number	Heading
[TPS_SWCT_01047]	Reference from the software representation of a sensor/actuator to the actual hardware element
[TPS_SWCT_01048]	<code>SensorActuatorSwComponentType</code> may use the I/O hardware abstraction directly
[TPS_SWCT_01049]	Two ways to use the <code>ExclusiveAreas</code>
[TPS_SWCT_01050]	<code>RunnableEntity</code> always runs inside an <code>ExclusiveArea</code>
[TPS_SWCT_01051]	<code>RunnableEntity</code> explicitly enters and leaves a specific <code>ExclusiveArea</code>
[TPS_SWCT_01052]	Inter-runnable variable
[TPS_SWCT_01053]	Relationship of interchanged data with <code>RunnableEntities</code>
[TPS_SWCT_01054]	Semantics of the <code>explicitInterRunnableVariable</code>
[TPS_SWCT_01055]	Semantics of <code>implicitInterRunnableVariable</code>
[TPS_SWCT_01056]	Physical dimension
[TPS_SWCT_01057]	Unit references one physical dimension
[TPS_SWCT_01058]	<code>UnitGroup</code>
[TPS_SWCT_01059]	Exponent for each of the seven fundamental dimensions
[TPS_SWCT_01060]	Negative exponents
[TPS_SWCT_01061]	Conversion of units
[TPS_SWCT_01062]	Documentation of software-components
[TPS_SWCT_01063]	<code>PortGroup</code>
[TPS_SWCT_01064]	<code>PortGroups</code> have to be defined on the VFB level
[TPS_SWCT_01065]	<code>PortPrototype</code> may belong to more than one <code>PortGroups</code>
[TPS_SWCT_01066]	<code>PortGroups</code> can be associated with certain <code>ServiceNeeds</code>
[TPS_SWCT_01067]	Initial mode
[TPS_SWCT_01068]	<code>Units</code> can be grouped with the help of <code>UnitGroup</code>
[TPS_SWCT_01069]	<code>DataInterface</code> is defined as abstract base class
[TPS_SWCT_01070]	<code>PortInterface</code> acts as a <i>type</i> for a <code>PortPrototype</code>
[TPS_SWCT_01071]	<code>ModeDeclaration</code>
[TPS_SWCT_01072]	<code>ApplicationDataType</code> and <code>ImplementationDataType</code>
[TPS_SWCT_01073]	Composite <code>ApplicationDataType</code>
[TPS_SWCT_01074]	Composite <code>ImplementationDataType</code>
[TPS_SWCT_01075]	<code>SwcInternalBehavior</code>
[TPS_SWCT_01076]	Number of elements of a specific <code>ApplicationArrayDataType</code> might vary at run-time
[TPS_SWCT_01077]	Configure the response to mode changes
[TPS_SWCT_01078]	Configurable array size
[TPS_SWCT_01079]	<code>SwConnector</code>
[TPS_SWCT_01080]	Delegation ports
[TPS_SWCT_01081]	Implications of being a delegation port





Number	Heading
[TPS_SWCT_01082]	AssemblySwConnector
[TPS_SWCT_01083]	DelegationSwConnector
[TPS_SWCT_01084]	Outer PortPrototype is referenced by multiple DelegationSwConnectors
[TPS_SWCT_01085]	Variation on the behavior level
[TPS_SWCT_01086]	Request mode change
[TPS_SWCT_01087]	Propagation of mode information
[TPS_SWCT_01088]	ComSpecs defined by CompositionSwComponentTypes
[TPS_SWCT_01089]	end-to-end communication protection
[TPS_SWCT_01090]	EndToEndProtection
[TPS_SWCT_01091]	Two cases for end-to-end protection
[TPS_SWCT_01092]	EndToEndProtectionSet
[TPS_SWCT_01093]	Definition of end-to-end protection is splittable
[TPS_SWCT_01094]	category of EndToEndDescription
[TPS_SWCT_01095]	category set to NONE
[TPS_SWCT_01096]	PortGroup
[TPS_SWCT_01097]	CompositionSwComponentType cannot have RunnableEntitys
[TPS_SWCT_01098]	Only AtomicSwComponentType can have RunnableEntitys
[TPS_SWCT_01099]	PortInterfaceMapping
[TPS_SWCT_01100]	Precedence of PortInterfaceMapping
[TPS_SWCT_01101]	Unmapped elements of PortInterfaces
[TPS_SWCT_01102]	VariableAndParameterInterfaceMapping
[TPS_SWCT_01103]	Mapping between different kinds of PortInterfaces
[TPS_SWCT_01104]	Possible mappings are restricted by the swImplPolicy
[TPS_SWCT_01105]	ClientServerInterfaceMapping
[TPS_SWCT_01106]	ClientServerOperation
[TPS_SWCT_01107]	swMinAxisPoints and swMaxAxisPoints represent variation points
[TPS_SWCT_01108]	Added value of an AtomicSwComponentType
[TPS_SWCT_01109]	Adding the SwcInternalBehavior in a later process step
[TPS_SWCT_01110]	Symbolic name of a software-component
[TPS_SWCT_01111]	PortPrototypes need an additional model artifact, the PortInterface
[TPS_SWCT_01112]	PortPrototypes are either <i>require-</i> or <i>provide-</i> ports.
[TPS_SWCT_01113]	Connecting two PortPrototypes
[TPS_SWCT_01114]	SenderReceiverInterface
[TPS_SWCT_01115]	invalidationPolicy
[TPS_SWCT_01116]	swImplPolicy
[TPS_SWCT_01117]	Communication patterns for sender-receiver communication





Number	Heading
[TPS_SWCT_01118]	ClientServerInterface
[TPS_SWCT_01119]	Direction of ArgumentDataPrototypes
[TPS_SWCT_01120]	Client needs to provide ArgumentDataPrototypes
[TPS_SWCT_01121]	Pass correct data type
[TPS_SWCT_01122]	Synchronous call of ClientServerOperation
[TPS_SWCT_01123]	No default values for ArgumentDataPrototypes
[TPS_SWCT_01124]	Definition of ArgumentDataPrototypes within the context of a ClientServerOperation is ordered
[TPS_SWCT_01125]	serverArgumentImplPolicy
[TPS_SWCT_01126]	Access to partial networking via BswM
[TPS_SWCT_01127]	Byte array with variable size
[TPS_SWCT_01128]	SwRecordLayout needed
[TPS_SWCT_01129]	Express diagnostic capabilities
[TPS_SWCT_01130]	Measurement and calibration access to model elements is defined by swCalibrationAccess
[TPS_SWCT_01131]	AtomicSwComponentType accepts a request to restart an entire function
[TPS_SWCT_01132]	AtomicSwComponentType provides information about operating cycles
[TPS_SWCT_01133]	AtomicSwComponentType provides information about aging cycles
[TPS_SWCT_01134]	AtomicSwComponentType enables storage of DTCs in general
[TPS_SWCT_01135]	AtomicSwComponentType enables storage of subsequent DTCs
[TPS_SWCT_01136]	AtomicSwComponentType retrieves information from the fault storage
[TPS_SWCT_01137]	Dem provides information that the fault storage overflows
[TPS_SWCT_01138]	AtomicSwComponentType suppresses the storage of DTCs within the Dem
[TPS_SWCT_01139]	AtomicSwComponentType informs the Dem that the PTO is active
[TPS_SWCT_01140]	AtomicSwComponentType needs information about specific DTC without being a diagnostic monitor
[TPS_SWCT_01141]	AtomicSwComponentType may have RPortPrototypes typed by an NvDataInterface
[TPS_SWCT_01142]	non-volatile data are provided by a specialized AtomicSwComponentType
[TPS_SWCT_01143]	Non-volatile data represented by an NvBlockComponent can be read and written
[TPS_SWCT_01144]	NvBlockDescriptor specifies the properties of exactly one NvBlock
[TPS_SWCT_01145]	ramBlock and the romBlock are described by a VariableDataPrototype and a ParameterDataPrototype
[TPS_SWCT_01146]	romBlock is optional
[TPS_SWCT_01147]	No romBlock is configured
[TPS_SWCT_01148]	NvBlockDataMapping
[TPS_SWCT_01149]	RoleBasedPortAssignment of NvBlockDescriptor
[TPS_SWCT_01150]	InternalBehavior of a NvBlockSwComponentType





Number	Heading
[TPS_SWCT_01151]	<code>RunnableEntity</code> s do not have further attributes
[TPS_SWCT_01152]	<code>InternalBehavior</code> does not have further attributes
[TPS_SWCT_01153]	<code>IncludedModeDeclarationGroupSet</code>
[TPS_SWCT_01154]	Attribute <code>prefix</code> of <code>IncludedModeDeclarationGroupSet</code>
[TPS_SWCT_01155]	<code>IncludedDataTypeSet</code>
[TPS_SWCT_01156]	Required if the <code>AutosarDataType</code> is not used for any <code>DataPrototype</code>
[TPS_SWCT_01157]	Attribute <code>literalPrefix</code> of <code>IncludedDataTypeSet</code>
[TPS_SWCT_01158]	Three cases for <code>PortInterfaceMapping</code>
[TPS_SWCT_01159]	Mapping is described separately from the <code>SwConnector</code> as reusable <code>ARElement</code>
[TPS_SWCT_01160]	<code>ModeInterfaceMapping</code>
[TPS_SWCT_01161]	<code>TriggerInterfaceMapping</code>
[TPS_SWCT_01162]	Conditional existence of <code>TextTableMapping</code>
[TPS_SWCT_01163]	Conversion from <code>firstValue</code> to <code>secondValue</code>
[TPS_SWCT_01164]	Conversion from <code>secondValue</code> to <code>firstValue</code>
[TPS_SWCT_01165]	Invertible mapping
[TPS_SWCT_01166]	Non-invertible mapping
[TPS_SWCT_01167]	Validity of <code>ModeInterfaceMapping</code>
[TPS_SWCT_01168]	Linear conversion factor can be calculated
[TPS_SWCT_01169]	Support for partial networking
[TPS_SWCT_01170]	Purpose of Virtual Function Cluster
[TPS_SWCT_01171]	Purpose of a control port
[TPS_SWCT_01172]	Requesting and releasing partial networks
[TPS_SWCT_01173]	Control port shall not become a part of the <code>PortGroup</code>
[TPS_SWCT_01174]	Status port shall not become a member of the <code>PortGroup</code>
[TPS_SWCT_01175]	Actively query the status of a partial network
[TPS_SWCT_01176]	last-is-best semantics for sender-receiver communication
[TPS_SWCT_01177]	Assignment of constant values
[TPS_SWCT_01178]	Specialized subclasses of <code>ValueSpecification</code>
[TPS_SWCT_01179]	Compound Primitive Data Type
[TPS_SWCT_01180]	Maximum possible size of Compound Primitive Data Type
[TPS_SWCT_01181]	Bound model specifies a primitive which is smaller than the maximum defined by the range of the involved <code>SwSystemconst</code>
[TPS_SWCT_01182]	Conceptual levels for the definition of initial values
[TPS_SWCT_01183]	Actual value of an <code>initValue</code> shall be interpreted according to the <code>Autosar-DataType</code>
[TPS_SWCT_01184]	<code>ApplicationPrimitiveDataTypes</code> with <code>category</code> VALUE
[TPS_SWCT_01185]	<code>initValues</code> for Compound Primitive Data Types





Number	Heading
[TPS_SWCT_01186]	ConstantSpecificationMapping
[TPS_SWCT_01187]	ConstantSpecificationMappingSet referenced by the InternalBehavior
[TPS_SWCT_01188]	Definition of calibration data sets through RTE-generator and compiler
[TPS_SWCT_01189]	DataTypeMap
[TPS_SWCT_01190]	ModeRequestTypeMap
[TPS_SWCT_01191]	mapped ApplicationDataType and ImplementationDataType shall be compatible
[TPS_SWCT_01192]	Meta-classes that have an association to a DataTypeMappingSet
[TPS_SWCT_01193]	Mappings between application and implementation types do not necessarily have to form a 1:1 relation
[TPS_SWCT_01194]	Symbolic name of an ImplementationDataType
[TPS_SWCT_01195]	Mapping of composite element to primitive DataPrototype
[TPS_SWCT_01196]	Semantics of an external trigger event communication
[TPS_SWCT_01197]	TriggerInterface
[TPS_SWCT_01198]	Period for periodic triggering
[TPS_SWCT_01199]	Queued processing of Triggers
[TPS_SWCT_01200]	ModeDeclarationGroupPrototype per ModeSwitchInterface
[TPS_SWCT_01201]	CompositionSwComponentType requires and provides the modes that are required or provided by its contained SwComponentPrototypes
[TPS_SWCT_01202]	ApplicationDataType defines a subset of the values used in the ModeDeclarationGroup
[TPS_SWCT_01203]	PortPrototype may own port annotations
[TPS_SWCT_01204]	GeneralAnnotation
[TPS_SWCT_01205]	Typical annotations for sender/receiver communication
[TPS_SWCT_01206]	Min and Max annotations are valid for a certain amount of time
[TPS_SWCT_01207]	VariableDataPrototypes use the same application-level SenderReceiverAnnotation
[TPS_SWCT_01208]	Grouping for SenderReceiverAnnotation
[TPS_SWCT_01209]	ClientServerAnnotation
[TPS_SWCT_01210]	IoHwAbstractionServerAnnotation
[TPS_SWCT_01211]	Assign several annotations to ArgumentDataPrototype
[TPS_SWCT_01212]	ParameterPortAnnotation
[TPS_SWCT_01213]	ModePortAnnotation
[TPS_SWCT_01214]	TriggerPortAnnotation
[TPS_SWCT_01215]	NvDataPortAnnotation
[TPS_SWCT_01216]	DelegatedPortAnnotation
[TPS_SWCT_01217]	Semantics of DelegatedPortAnnotation.signalFan
[TPS_SWCT_01218]	Big picture of ComSpec





Number	Heading
[TPS_SWCT_01219]	ComSpec for queued and non-queued sender-receiver communication
[TPS_SWCT_01220]	initValue defines an initial value that shall be taken if the corresponding dataElement has not yet been received
[TPS_SWCT_01221]	DataFilter
[TPS_SWCT_01222]	Applicability of DataFilter
[TPS_SWCT_01223]	networkRepresentation defines how a specific dataElement is represented on a communication bus
[TPS_SWCT_01224]	CompuMethods of dataElement and the networkRepresentation are used for conversion purposes
[TPS_SWCT_01225]	RunnableEntity implements the functionality of two or more ClientServerOperations
[TPS_SWCT_01226]	initValue on the level of a ComSpec is relevant for connections to the corresponding PortPrototype
[TPS_SWCT_01227]	Unconnected RPortPrototype typed by NvDataInterface
[TPS_SWCT_01228]	NvProvideComSpec
[TPS_SWCT_01229]	Three different levels of abstraction regarding the definition of data types
[TPS_SWCT_01230]	Application Data Level
[TPS_SWCT_01231]	Application level may impose strong requirements on the design of the corresponding implementation level
[TPS_SWCT_01232]	Implementation Data Level
[TPS_SWCT_01233]	Use case for the Implementation Data Level
[TPS_SWCT_01234]	Base Level
[TPS_SWCT_01235]	Mapping of data defined on the <i>Application</i> level to the <i>Implementation</i> and <i>Base Type</i> level
[TPS_SWCT_01236]	Big picture of data types
[TPS_SWCT_01237]	SwDataDefProps
[TPS_SWCT_01238]	Attribute category used in the context of AutosarDataType
[TPS_SWCT_01239]	default value for attribute category used in the context of AutosarDataType
[TPS_SWCT_01240]	Subclasses of ApplicationDataType
[TPS_SWCT_01241]	Applicable categorys for subclasses ApplicationDataType
[TPS_SWCT_01242]	category characterizes the nature of a data type on application level
[TPS_SWCT_01243]	Definition of enumeration types
[TPS_SWCT_01244]	Data types for calibration parameters are also described as primitive types
[TPS_SWCT_01245]	SwDataDefProps control the structure of calibration parameters
[TPS_SWCT_01246]	SwRecordLayout may be required for A2L generation
[TPS_SWCT_01247]	ApplicationArrayDataType and ApplicationRecordDataType
[TPS_SWCT_01248]	Nested definition of ImplementationDataType
[TPS_SWCT_01249]	ApplicationRecordDataType





Number	Heading
[TPS_SWCT_01250]	<code>ImplementationDataType</code> has been introduced to optimize the formal support for data type handling on the implementation level
[TPS_SWCT_01251]	Limited set of values for <code>category</code> are applicable for <code>ImplementationDataType</code>
[TPS_SWCT_01252]	<code>ImplementationDataType</code> can express concepts not available on application level
[TPS_SWCT_01253]	Rules apply for the usage of the attribute <code>ImplementationDataType.typeEmitter</code>
[TPS_SWCT_01254]	<code>ImplementationDataType</code> with array semantics
[TPS_SWCT_01255]	Indicate whether the array is supposed to have a fixed size or whether the actual size might change during run-time
[TPS_SWCT_01256]	Definition of multi-dimensional array data types
[TPS_SWCT_01257]	<code>ImplementationDataType</code> or the aggregated <code>ImplementationDataTypeElements</code> do not form closed sets
[TPS_SWCT_01258]	Definition of a pointer to data
[TPS_SWCT_01259]	Definition of a pointer to a function
[TPS_SWCT_01260]	<code>SwBaseType</code>
[TPS_SWCT_01261]	Use case for <code>SwBaseType</code>
[TPS_SWCT_01262]	<code>memAlignment</code> and <code>byteOrder</code> are platform specific
[TPS_SWCT_01263]	Further use cases for <code>SwBaseType</code>
[TPS_SWCT_01264]	Data prototypes implement a role of a data type
[TPS_SWCT_01265]	<code>DataPrototype</code> aggregates an own set of <code>SwDataDefProps</code>
[TPS_SWCT_01266]	Three non-abstract classes derived from <code>AutosarDataPrototype</code>
[TPS_SWCT_01267]	<code>DataPrototype</code> can be aggregated in different roles
[TPS_SWCT_01268]	Definition of <code>initValue</code> for a <code>VariableDataPrototype</code> or a <code>ParameterDataPrototype</code>
[TPS_SWCT_01269]	In <code>PortInterfaces</code> , initial values defined for <code>DataPrototypes</code> are ignored
[TPS_SWCT_01270]	<code>AutosarVariableRef</code>
[TPS_SWCT_01271]	<code>AutosarParameterRef</code>
[TPS_SWCT_01272]	Semantics of <code>swComparisonVariable</code>
[TPS_SWCT_01273]	Precedence rules for the application of <code>SwDataDefProps</code>
[TPS_SWCT_01274]	<code>SwDataDefProps</code> used to support calibration and measurement
[TPS_SWCT_01275]	values of the attribute <code>swImplPolicy</code> are restricted depending on the context
[TPS_SWCT_01276]	Computation methods
[TPS_SWCT_01277]	Computation methods are used for the conversion of <i>internal</i> values into their <i>physical</i> representation and vice versa
[TPS_SWCT_01278]	<code>CompuMethods</code> can also be used to assign symbolic names to internal values
[TPS_SWCT_01279]	Preferred conversion direction depends on the use case
[TPS_SWCT_01280]	<code>CompuMethod</code> applied to values outside of its limits





Number	Heading
[TPS_SWCT_01281]	<code>Unit</code> associated with a <code>PhysicalDimension</code>
[TPS_SWCT_01283]	Rational function
[TPS_SWCT_01284]	<code>CompuScale</code> might require a representation in the generated RTE C code
[TPS_SWCT_01285]	Physical dimension
[TPS_SWCT_01286]	<code>DataConstr</code>
[TPS_SWCT_01287]	Standard limits and extended limits in the ASAM-MCD2 (ASAP2) specification
[TPS_SWCT_01288]	Interpretation of <code>PhysConstrs</code> and <code>InternalConstrs</code> by tools
[TPS_SWCT_01289]	Semantics of <code>Limit</code>
[TPS_SWCT_01290]	<code>SwAddrMethod</code>
[TPS_SWCT_01291]	Association of <code>MemorySection</code> with <code>SwAddrMethod</code>
[TPS_SWCT_01292]	Usage of <code>SwAddrMethod</code> in the context of a <code>DataPrototype</code>
[TPS_SWCT_01293]	RTE Generator has to derive the Memory Allocation Keyword
[TPS_SWCT_01294]	Missing <code>SwDataDefProps.swAddrMethod</code>
[TPS_SWCT_01295]	<code>SwRecordLayout</code>
[TPS_SWCT_01296]	Different approaches of ASAM MCD-2MC and AUTOSAR with respect to <code>SwRecordLayout</code>
[TPS_SWCT_01297]	Compliance of <code>ApplicationDataTypes</code> or <code>ImplementationDataTypes</code> to <code>swDataDefProps</code>
[TPS_SWCT_01298]	Computing <code>SwRecordLayout</code> from <code>ImplementationDataTypes</code> is not possible
[TPS_SWCT_01299]	Relation of <code>swRecordLayoutGroup</code> to <code>subElement</code>
[TPS_SWCT_01300]	Relationship between record layouts and interpolation routines
[TPS_SWCT_01301]	Importance of initial values
[TPS_SWCT_01302]	Semantics of <code>minimumStartInterval</code>
[TPS_SWCT_01303]	<code>symbol</code> attribute describes the <code>RunnableEntity</code> 's entry point
[TPS_SWCT_01304]	Cat. 1A and 1B <code>RunnableEntities</code> will eventually terminate
[TPS_SWCT_01305]	<code>RunnableEntity</code> as one that cannot be invoked concurrently
[TPS_SWCT_01306]	Software-component description itself does not put any bounds on the number of concurrent invocations of a <code>RunnableEntity</code>
[TPS_SWCT_01307]	<code>supportsMultipleInstantiation</code> vs. <code>canBeInvokedConcurrently</code>
[TPS_SWCT_01308]	Combination of <code>supportsMultipleInstantiation=false</code> and <code>canBeInvokedConcurrently=false</code>
[TPS_SWCT_01309]	signature of a <code>RunnableEntity</code> depends on the connected <code>RTEEvent</code>
[TPS_SWCT_01310]	Categories of <code>RunnableEntities</code>
[TPS_SWCT_01311]	Name of an operation argument
[TPS_SWCT_01312]	<code>RunnableEntity</code> has a mapping to <code>BswModuleEntry</code>
[TPS_SWCT_01313]	Conditions for a transition from suspended to to be started
[TPS_SWCT_01314]	<code>RTEEvent</code>





Number	Heading
[TPS_SWCT_01315]	Interaction of RunnableEntity with RTEEvent
[TPS_SWCT_01316]	Abstract base class RTEEvent
[TPS_SWCT_01317]	RTE triggers RunnableEntity in response to occurring RTEEvent
[TPS_SWCT_01318]	RunnableEntity and WaitPoint
[TPS_SWCT_01319]	RTEEvent can be used to trigger WaitPoints in different RunnableEntities
[TPS_SWCT_01320]	RunnableEntities of category 2
[TPS_SWCT_01321]	Communication among RunnableEntities
[TPS_SWCT_01322]	Interaction patterns for the application of the sender-receiver paradigm
[TPS_SWCT_01323]	Read and write access to a dataElement
[TPS_SWCT_01324]	Mode switches need to be completed in finite time
[TPS_SWCT_01325]	Read and write access is only applicable for RunnableEntities of category 1
[TPS_SWCT_01326]	Constrain the scope of a specific communication
[TPS_SWCT_01327]	RTE generator can omit the creation of checks at run-time
[TPS_SWCT_01328]	Default value of attribute scope
[TPS_SWCT_01329]	Access to specific data is implemented by means of aggregating the meta-class VariableAccess in specific roles
[TPS_SWCT_01330]	RunnableEntity can also have dataSendPoints
[TPS_SWCT_01331]	dataWriteAccess vs. dataSendPoint
[TPS_SWCT_01332]	dataReceivePointByValue vs. dataReceivePointByArgument
[TPS_SWCT_01333]	dataReceivePointByValue/dataReceivePointByArgument vs. dataReadAccess
[TPS_SWCT_01334]	RunnableEntities of category 1 may have dataReceivePointByValues/dataReceivePointByArguments
[TPS_SWCT_01335]	Combine dataReceivePointByValue or dataReceivePointByArgument with a WaitPoint
[TPS_SWCT_01336]	dataSendPoint also allows for the definition of a DataSendCompletedEvent
[TPS_SWCT_01337]	DataReceivedEvent
[TPS_SWCT_01338]	DataReceiveErrorEvent
[TPS_SWCT_01339]	RTE activates RunnableEntity in response to DataReceiveErrorEvent
[TPS_SWCT_01340]	DataReceiveErrorEvent cannot be combined with a WaitPoint
[TPS_SWCT_01341]	DataReceiveErrorEvent is directly associated with the corresponding VariableDataPrototype
[TPS_SWCT_01342]	Invocation of a server operation
[TPS_SWCT_01343]	Synchronous vs. asynchronous invocation
[TPS_SWCT_01344]	Consistency of values of timeout
[TPS_SWCT_01345]	Synchronous operation invocation





Number	Heading
[TPS_SWCT_01346]	Asynchronous operation invocation
[TPS_SWCT_01347]	Blocking access to operation result in an asynchronous operation invocation
[TPS_SWCT_01348]	Trigger source
[TPS_SWCT_01349]	Trigger sink
[TPS_SWCT_01350]	Calibration Parameters shared among several <code>SwComponentTypes</code>
[TPS_SWCT_01351]	Access to a <code>ParameterDataPrototype</code>
[TPS_SWCT_01352]	Requested mode is just sent and received as an ordinary data value
[TPS_SWCT_01353]	<code>RunnableEntity</code> s react on a mode request via a corresponding <code>RTEEvent</code>
[TPS_SWCT_01354]	<code>PortAPIOption</code>
[TPS_SWCT_01355]	<code>enableTakeAddress = true</code>
[TPS_SWCT_01356]	<code>indirectAPI</code> option switches the generation of the RTE's indirect API functionality
[TPS_SWCT_01357]	Definition of implicit values that are passed by the RTE to the server's entry point
[TPS_SWCT_01358]	Values are hidden from the client components
[TPS_SWCT_01359]	Private memory per instance
[TPS_SWCT_01360]	Arbitrary number of per-instance memory blocks
[TPS_SWCT_01361]	attribute <code>supportsMultipleInstantiation == false</code>
[TPS_SWCT_01362]	Initialization of <code>PerInstanceMemory</code>
[TPS_SWCT_01363]	<code>PerInstanceMemory</code> typed by 'C' Data Types
[TPS_SWCT_01364]	Initial value of a <code>PerInstanceMemory</code> typed by 'C' Data Types
[TPS_SWCT_01365]	<code>PerInstanceMemory</code> typed by AUTOSAR Data Types
[TPS_SWCT_01366]	Initial value of a <code>PerInstanceMemory</code> typed by AUTOSAR Data Types
[TPS_SWCT_01367]	Typed by AUTOSAR data type vs. typed by C data type
[TPS_SWCT_01368]	Describe static and constant memory
[TPS_SWCT_01369]	Static and constant memory is not instantiated by the RTE
[TPS_SWCT_01370]	<code>VariationPointProxy</code>
[TPS_SWCT_01371]	<code>VariationPointProxy</code> vs. <code>VariationPoint</code>
[TPS_SWCT_01372]	<code>bindingTime = preCompileTime</code>
[TPS_SWCT_01373]	RTE generator shall evaluate the <code>SwSystemconstDependentFormula</code>
[TPS_SWCT_01374]	Implementation of <code>AutosarParameterRef</code>
[TPS_SWCT_01375]	Implementation of <code>AutosarVariableRef</code>
[TPS_SWCT_01376]	Software-components need to be capable of reacting to state changes
[TPS_SWCT_01377]	Two mechanisms to define how <code>SwcInternalBehavior</code> should interact with the mode management
[TPS_SWCT_01378]	<code>AtomicSwComponentType</code> can define an <code>SwcModeSwitchEvent</code> to execute <code>RunnableEntity</code>





Number	Heading
[TPS_SWCT_01379]	<code>AtomicSwComponentType</code> can indicate whether an <code>RTEEvent</code> that starts an associated <code>RunnableEntity</code> is disabled in a certain mode
[TPS_SWCT_01380]	Mode management behavior on the sender side
[TPS_SWCT_01381]	Read the currently active mode
[TPS_SWCT_01382]	Mode switch requests are handled asynchronously by the RTE
[TPS_SWCT_01383]	<code>ModeSwitchPoint</code>
[TPS_SWCT_01384]	Execution of initialization code for software-components
[TPS_SWCT_01385]	Execution of initialization code for software-components
[TPS_SWCT_01386]	Initialization by mode management
[TPS_SWCT_01387]	Finalization by mode management
[TPS_SWCT_01388]	Initial modes of <code>AtomicSwComponentTypes</code> are defined by the <code>initialMode</code>
[TPS_SWCT_01389]	I/O Hardware Abstraction interfaces MCAL drivers
[TPS_SWCT_01390]	I/O Hardware Abstraction might have sub-structures
[TPS_SWCT_01391]	I/O Hardware Abstraction abstracts from the location of peripheral I/O devices
[TPS_SWCT_01392]	Mapping between the <code>EcuAbstractionSwComponentType</code> and the corresponding <code>BswModuleDescription</code>
[TPS_SWCT_01393]	Complex Driver
[TPS_SWCT_01394]	Complex Driver is represented by the <code>ComplexDeviceDriverSwComponentType</code>
[TPS_SWCT_01395]	<code>ComplexDeviceDriverSwComponentType</code> has dependencies to ECU Hardware
[TPS_SWCT_01396]	Mapping between the <code>ComplexDeviceDriverSwComponentType</code> and the corresponding <code>BswModuleDescription</code>
[TPS_SWCT_01397]	Hybrid concept between Basic Software Modules and a <code>SwComponentType</code>
[TPS_SWCT_01398]	Communication patterns for AUTOSAR services
[TPS_SWCT_01399]	Dependency is modeled by aggregating required and provided <code>PortPrototypes</code>
[TPS_SWCT_01400]	<code>PortInterface</code> selected from the set of standardized Service Interfaces
[TPS_SWCT_01401]	Form a top-level <code>RootSwCompositionPrototype</code>
[TPS_SWCT_01402]	Mapping of all <code>AtomicSwComponentType</code> instances to <code>EcuInstances</code>
[TPS_SWCT_01403]	Impact of AUTOSAR services on the methodology
[TPS_SWCT_01404]	Creation of the <code>EcuExtract</code>
[TPS_SWCT_01405]	Creation of the <code>ServiceSwComponentTypes</code>
[TPS_SWCT_01406]	Creation of <code>SwComponentPrototype</code> typed by a <code>ServiceSwComponentType</code>
[TPS_SWCT_01407]	Creation of <code>InternalBehavior</code> typed by a <code>ServiceSwComponentType</code>





Number	Heading
[TPS_SWCT_01408]	Creation of SwcBswMapping
[TPS_SWCT_01409]	Update of PortDefinedArgumentValues
[TPS_SWCT_01410]	Dcm and Dem can directly access dataElements in PPortPrototypes typed by a SenderReceiverInterface
[TPS_SWCT_01411]	Use cases for a ServiceSwComponentType to express ServiceNeeds
[TPS_SWCT_01412]	ServiceSwComponentType shall be added in ECU Configuration phase
[TPS_SWCT_01413]	Local communication with services
[TPS_SWCT_01414]	Mode manager needs to communicate with application software components located on other ECUs
[TPS_SWCT_01415]	Interfaces of ServiceProxySwComponentType
[TPS_SWCT_01416]	Difference between a ServiceProxySwComponentType and an ApplicationSwComponentType
[TPS_SWCT_01417]	Define calibration parameters common to all SwComponentPrototypes of the same SwComponentType
[TPS_SWCT_01418]	Ways to define a calibration parameter
[TPS_SWCT_01419]	ParameterSwComponentType shall never aggregate a SwcInternalBehavior
[TPS_SWCT_01420]	SwComponentType requiring access to shared calibration parameters needs RPortPrototype typed by a ParameterInterface
[TPS_SWCT_01421]	ParameterInterface is not restricted to parameters which can actually be calibrated
[TPS_SWCT_01422]	Delegation of PortPrototypes typed by a ParameterInterface
[TPS_SWCT_01423]	ParameterDataPrototype aggregated in the role constantMemory
[TPS_SWCT_01424]	ParameterDataPrototype aggregated in the role perInstanceParameter
[TPS_SWCT_01425]	AtomicSwComponentType provides one callback per event if diagnostic event data change
[TPS_SWCT_01426]	AtomicSwComponentType provides callback if any diagnostic event data and/or status changed
[TPS_SWCT_01427]	AtomicSwComponentType provides data for diagnostic purposes via ClientServerInterface
[TPS_SWCT_01428]	ServiceSwComponentType representing the Dem provides a PPortPrototype for the Dcm
[TPS_SWCT_01429]	[constr_1135] only applies for BITFIELD_TEXTTABLE
[TPS_SWCT_01430]	Conversion specification from internal to physical values as well as the reverse conversion
[TPS_SWCT_01431]	Finding the symbol for the representation of a CompuScale in C code
[TPS_SWCT_01432]	Keep the invalidValue transparent to the sending and receiving software components
[TPS_SWCT_01433]	Invalid values outside the range limits
[TPS_SWCT_01434]	Sender and receiver have knowledge of invalid value





Number	Heading
[TPS_SWCT_01435]	Invalid values outside the range limits
[TPS_SWCT_01436]	Different receivers require different handling of data invalidation
[TPS_SWCT_01437]	<code>invalidValue</code> can also be specified without setting a <code>compuMethod</code>
[TPS_SWCT_01438]	Handling of invalidation in the sending RTE
[TPS_SWCT_01439]	Handling of invalidation in the receiving RTE
[TPS_SWCT_01440]	Measurement is not limited to primitive objects
[TPS_SWCT_01441]	Nature of a <code>TYPE_REFERENCE</code>
[TPS_SWCT_01442]	<code>ImplementationDataType</code> of category <code>TYPE_REFERENCE</code> does not define own properties
[TPS_SWCT_01443]	<code>ImplementationDataType</code> of category <code>TYPE_REFERENCE</code> overwrites properties of refined <code>ImplementationDataType</code>
[TPS_SWCT_01444]	Size of <code>SwBaseType</code> is specified in bits
[TPS_SWCT_01445]	Applicability of <code>SwDataDefProps</code> for <code>DataPrototypes</code>
[TPS_SWCT_01446]	References to a <code>DataPrototype</code> may or may not imply the necessity for using an <code>instanceRef</code>
[TPS_SWCT_01447]	Applicable binding times for model elements in the scope of the Software Component Template
[TPS_SWCT_01448]	Pre-defined values for the category of <code>VariationPointProxy</code>
[TPS_SWCT_02000]	Default value for attribute <code>swImplPolicy</code>
[TPS_SWCT_02001]	Values of <code>SwAxisCont</code> with the category <code>COM_AXIS</code> , <code>RES_AXIS</code> are for display only
[TPS_SWCT_02002]	<code>AtomicSwComponentType</code> offers a <code>PPortPrototypes</code> typed by <code>ClientServerInterface</code> to read/write current value via diagnostic services
[TPS_SWCT_02003]	<code>AtomicSwComponentType</code> offers <code>PortPrototypes</code> typed by <code>SenderReceiverInterfaces</code> to read/write current values via diagnostic services
[TPS_SWCT_02004]	<code>AtomicSwComponentType</code> offers a <code>PortPrototype</code> typed by a <code>ClientServerInterface</code> to start/stop or request routine results of diagnostic routines
[TPS_SWCT_02005]	<code>AtomicSwComponentType</code> offers <code>PortPrototypes</code> typed by <code>ClientServerInterfaces</code> to adjust the IO signal via diagnostic services
[TPS_SWCT_02006]	<code>AtomicSwComponentType</code> offers sender receiver ports to adjust the IO signal via diagnostic services
[TPS_SWCT_02007]	<code>AtomicSwComponentType</code> implements a OBD system monitor with In-Use-Monitor Performance Ratio
[TPS_SWCT_02008]	<code>AtomicSwComponentType</code> offers a server port to read/write current value via OBD services
[TPS_SWCT_02009]	<code>AtomicSwComponentType</code> offers sender receiver ports to read/write current values via OBD services
[TPS_SWCT_02010]	<code>AtomicSwComponentType</code> offers a server port to read vehicle information values via OBD services





Number	Heading
[TPS_SWCT_02011]	<i>AtomicSwComponentType</i> offers a server port to read DTR value via OBD services
[TPS_SWCT_02012]	<i>AtomicSwComponentType</i> offers a server port for request control of on-board system, test or component via OBD services
[TPS_SWCT_02013]	<i>AtomicSwComponentType</i> offers a server port to get protocol, session and security information or to request a Reset to Default Session
[TPS_SWCT_02014]	<i>AtomicSwComponentType</i> supports Response On Event (ROE) via diagnostic services
[TPS_SWCT_02015]	<i>AtomicSwComponentType</i> verifies the access to security level via diagnostic services
[TPS_SWCT_02016]	<i>AtomicSwComponentType</i> requires information on the status of the protocol communication and may disallow a protocol
[TPS_SWCT_02017]	<i>AtomicSwComponentType</i> requires the notification about a Service Request via diagnostic services
[TPS_SWCT_02018]	Setup for <i>AtomicSwComponentType</i> which contains a Supervised Entity
[TPS_SWCT_02019]	Setup for <i>AtomicSwComponentType</i> which requires <i>Global Supervision Status</i> notification
[TPS_SWCT_02020]	<i>AtomicSwComponentType</i> uses the hash calculation of the Crypto Service
[TPS_SWCT_02021]	<i>AtomicSwComponentType</i> uses the message authentication code (MAC) calculation of the Crypto Service
[TPS_SWCT_02022]	<i>AtomicSwComponentType</i> uses the message authentication code (MAC) verification of the Crypto Service
[TPS_SWCT_02023]	<i>AtomicSwComponentType</i> uses the generation of random seed of the Crypto Service
[TPS_SWCT_02024]	<i>AtomicSwComponentType</i> uses the generation of random numbers of the Crypto Service
[TPS_SWCT_02025]	<i>AtomicSwComponentType</i> uses the symmetrical block encryption of the Crypto Service
[TPS_SWCT_02026]	<i>AtomicSwComponentType</i> uses the symmetrical block decryption of the Crypto Service
[TPS_SWCT_02027]	<i>AtomicSwComponentType</i> uses the symmetrical encryption of the Crypto Service
[TPS_SWCT_02028]	<i>AtomicSwComponentType</i> uses the symmetrical decryption of the Crypto Service
[TPS_SWCT_02029]	<i>AtomicSwComponentType</i> uses the asymmetrical encryption of the Crypto Service
[TPS_SWCT_02030]	<i>AtomicSwComponentType</i> uses the asymmetrical decryption of the Crypto Service
[TPS_SWCT_02031]	<i>AtomicSwComponentType</i> uses the signature generation of the Crypto Service
[TPS_SWCT_02032]	<i>AtomicSwComponentType</i> uses the signature verification of the Crypto Service





Number	Heading
[TPS_SWCT_02033]	AtomicSwComponentType uses the checksum calculation of the Crypto Service
[TPS_SWCT_02034]	AtomicSwComponentType uses the key derivation of the Crypto Service
[TPS_SWCT_02035]	AtomicSwComponentType uses the symmetric key derivation of the Crypto Service
[TPS_SWCT_02036]	AtomicSwComponentType uses the key exchange interface for public value calculation of the Crypto Service
[TPS_SWCT_02037]	AtomicSwComponentType uses the key exchange interface for secret value calculation of the Crypto Service
[TPS_SWCT_02038]	AtomicSwComponentType uses the key exchange interface to calculate symmetric key with the Crypto Service
[TPS_SWCT_02039]	AtomicSwComponentType uses the symmetrical key extraction of the Crypto Service
[TPS_SWCT_02040]	AtomicSwComponentType uses the symmetrical key wrapping of the Crypto Service to export a symmetrical key structure with a symmetric key
[TPS_SWCT_02041]	AtomicSwComponentType uses the asymmetrical key wrapping of the Crypto Service to export a symmetrical key structure with a asymmetric key
[TPS_SWCT_02042]	AtomicSwComponentType uses the asymmetrical public key extraction of the Crypto Service
[TPS_SWCT_02043]	AtomicSwComponentType uses the asymmetrical private key extraction of the Crypto Service
[TPS_SWCT_02044]	AtomicSwComponentType uses the asymmetrical key wrapping of the Crypto Service to export a (asymmetric) private key structure with a symmetrical wrapping key
[TPS_SWCT_02045]	AtomicSwComponentType uses the asymmetrical key wrapping of the Crypto Service to export a (asymmetric) private key structure with a asymmetrical wrapping key

Table C.7: Added Specification Items in 4.0.3

C.3.4 Deleted Constraints in R4.0.3

Number	Heading
[constr_1023]	Specification of Units in CompuMethods (the text is still there but it does no longer represent a constraint)
[constr_1062]	Compatibility of data types with category BIT
[constr_1122]	Existence of attributes in PROFILE_03
[constr_1123]	Constraints of dataLength in PROFILE_03
[constr_1124]	Constraints of dataId in PROFILE_03
[constr_1125]	Constraints of maxDeltaCounterInit in PROFILE_03
[constr_1127]	ServiceSwComponentType shall not have ServiceNeeds





Number	Heading
[constr_1136]	Compatibility of introduction of blueprint and blueprinted element
	The following constraints are moved to [1]
[constr_2500]	PortInterfaces shall be of same kind
[constr_2526]	PortInterfaces need to be compatible to the blueprints
[constr_2527]	Blueprints shall live in package of a proper category
[constr_2528]	PortPrototypes shall not refer to blueprints of PortInterfaces
[constr_2529]	Blueprints of ports and interfaces shall be compatible
[constr_4001]	Content of ModeRequestTypeMap

Table C.8: Deleted Constraints in R4.0.3

C.3.5 Deleted Specification Items

N/A

C.4 Constraint History of this Document according to AUTOSAR R4.1.1

C.4.1 Changed Constraints in R4.1.1

Number	Heading
[constr_1012]	Value of category is FIXED_LENGTH
[constr_1013]	Value of category is VARIABLE_LENGTH
[constr_1016]	Restriction of invalidValue for ImplementationDataType and ImplementationDataTypeElement
[constr_1026]	Compatibility of Units
[constr_1047]	Compatibility of ApplicationPrimitiveDataTypes
[constr_1048]	Compatibility of ApplicationRecordDataTypes
[constr_1049]	Compatibility of ApplicationArrayDataTypes
[constr_1050]	Compatibility of ImplementationDataTypes
[constr_1060]	Compatibility of data types with category ARRAY, VAL_BLK
[constr_1072]	Compatibility of ModeSwitchInterfaces in the context of an AssemblySwConnector
[constr_1073]	Compatibility of ModeSwitchInterfaces in the context of an DelegationSwConnector
[constr_1074]	Compatibility of ModeDeclarationGroupPrototypes
[constr_1075]	Compatibility of ModeDeclarationGroups





Number	Heading
[constr_1079]	Compatibility of <code>ClientServerInterfaces</code> in the context of an <code>AssemblySwConnector</code>
[constr_1080]	Compatibility of <code>ClientServerInterfaces</code> in the context of an <code>DelegationSwConnector</code>
[constr_1081]	Compatibility of <code>TriggerInterfaces</code> in the context of an <code>AssemblySwConnector</code>
[constr_1082]	Compatibility of <code>TriggerInterfaces</code> in the context of an <code>DelegationSwConnector</code>
[constr_1068]	Compatibility of <code>VariableDataPrototypes</code> or <code>ParameterDataPrototypes</code> typed by primitive data types
[constr_1069]	Compatibility of <code>PortPrototypes</code> of different <code>DataInterfaces</code> in the context of <code>AssemblySwConnectors</code>
[constr_1070]	Compatibility of <code>PortPrototypes</code> of different <code>DataInterfaces</code> in the context of <code>DelegationSwConnectors</code>
[constr_1072]	Compatibility of <code>ModeSwitchInterfaces</code> in the context of an <code>AssemblySwConnector</code>
[constr_1073]	Compatibility of <code>ModeSwitchInterfaces</code> in the context of an <code>DelegationSwConnector</code>
[constr_1074]	Compatibility of <code>ModeDeclarationGroupPrototypes</code>
[constr_1079]	Compatibility of <code>ClientServerInterfaces</code> in the context of an <code>AssemblySwConnector</code>
[constr_1080]	Compatibility of <code>ClientServerInterfaces</code> in the context of an <code>DelegationSwConnector</code>
[constr_1081]	Compatibility of <code>TriggerInterfaces</code> in the context of an <code>AssemblySwConnector</code>
[constr_1082]	Compatibility of <code>TriggerInterfaces</code> in the context of an <code>DelegationSwConnector</code>
[constr_1108]	Value of <code>ApplicationError.errorCode</code>
[constr_1177]	Allowed <code>targetCategory</code> for <code>SwPointerTargetProps</code>
[constr_1187]	Compatibility of <code>VariableDataPrototypes</code> or <code>ParameterDataPrototypes</code> typed by composite data types

Table C.9: Changed Constraints in R4.1.1

C.4.2 Added Constraints in R4.1.1

Number	Heading
[constr_1191]	Value of <code>Limit</code> shall yield a numerical value
[constr_1192]	Compatibility of “IDENTICAL” to “RAT_FUNC” or “LINEAR”
[constr_1193]	<code>ModeDeclaration</code> shall be referenced by at least one <code>ModeTransition</code> in the role <code>enteredMode</code>
[constr_1194]	Identical <code>ModeTransitions</code>
[constr_1195]	<code>SwcModeSwitchEvent</code> and the definition of <code>ModeTransition</code>





Number	Heading
[constr_1196]	Existence of <code>networkRepresentation</code> vs. <code>compositeNetworkRepresentation</code>
[constr_1197]	Existence of <code>compositeNetworkRepresentation</code> shall be comprehensive
[constr_1200]	Queued communication is not applicable for <code>dataElements</code> owned by <code>RPortPrototype</code>
[constr_1201]	<code>initValue</code> shall exist in an <code>RPortPrototype</code>
[constr_1202]	Supported connections by <code>AssemblySwConnector</code> for <code>PortPrototypes</code> typed by a <code>SenderReceiverInterface</code> or <code>NvDataInterface</code>
[constr_1203]	Supported connections by <code>DelegationSwConnector</code> for <code>PortPrototypes</code> typed by a <code>SenderReceiverInterface</code> or <code>NvDataInterface</code>
[constr_1204]	Supported connections by <code>AssemblySwConnector</code> for <code>PortPrototypes</code> typed by a <code>ClientServerInterface</code> , <code>ModeSwitchInterface</code> , or <code>TriggerInterface</code>
[constr_1205]	Supported connections by <code>DelegationSwConnector</code> for <code>PortPrototypes</code> typed by a <code>ClientServerInterface</code> , <code>ModeSwitchInterface</code> , or <code>TriggerInterface</code>
[constr_1209]	Mapping of <code>ModeDeclarations</code> of mode user to <code>ModeDeclaration</code> of mode manager
[constr_1210]	Mapping of <code>ModeDeclarations</code> of mode user to all <code>ModeDeclarations</code> of mode manager
[constr_1211]	Constraints of <code>maxNoNewOrRepeatedData</code> in PROFILE_01
[constr_1212]	Constraints of <code>syncCounterInit</code> in PROFILE_01
[constr_1213]	Constraints of <code>maxNoNewOrRepeatedData</code> in PROFILE_02
[constr_1214]	Constraints of <code>syncCounterInit</code> in PROFILE_02
[constr_1215]	Interpretation of attribute <code>maxNoNewOrRepeatedData</code> owned by <code>EndToEndDescription</code> in PROFILE_01
[constr_1216]	Interpretation of attribute <code>syncCounterInit</code> owned by <code>EndToEndDescription</code> in PROFILE_01
[constr_1217]	Interpretation of attribute <code>maxNoNewOrRepeatedData</code> owned by <code>EndToEndDescription</code> in PROFILE_02
[constr_1218]	Interpretation of attribute <code>syncCounterInit</code> owned by <code>EndToEndDescription</code> in PROFILE_02
[constr_1219]	Invalidation depends on the value of <code>swImplPolicy</code>
[constr_1220]	Compatibility of <code>SwBaseType</code>
[constr_1221]	<code>DataPrototype</code> is typed by an <code>ApplicationPrimitiveDataType</code>
[constr_1222]	<code>category</code> of an <code>AutosarDataType</code> used to type a <code>DataPrototype</code> is set to <code>STRING</code>
[constr_1223]	<code>DataPrototype</code> is typed by an <code>ApplicationRecordDataType</code>
[constr_1224]	<code>DataPrototype</code> is typed by an <code>ApplicationArrayDataType</code>
[constr_1225]	<code>DataPrototype</code> is typed by an <code>ImplementationDataType</code> that references a <code>CompuMethod</code> of category <code>TEXTTABLE</code> or <code>BITFIELD_TEXTTABLE</code>
[constr_1226]	Applicable range for <code>ExecutableEntityActivationReason.bitPosition</code>





Number	Heading
[constr_1227]	Value of attribute <code>ExecutableEntityActivationReason.bitPosition</code> shall be unique
[constr_1228]	<code>RTEEvent</code> that is referenced by a <code>WaitPoint</code> in the role <code>trigger</code> shall not reference <code>ExecutableEntityActivationReason</code>
[constr_1229]	<code>category</code> of <code>ImplementationDataType</code> boils down to <code>VALUE</code>
[constr_1230]	<code>ApplicationDataType</code> that qualifies for <code>Integral Primitive Type</code>
[constr_1231]	<code>ConsistencyNeeds</code> aggregated by <code>CompositionSwComponentType</code>
[constr_1232]	<code>ConsistencyNeeds</code> aggregated by <code>AtomicSwComponentType</code>
[constr_1233]	<code>InstantiationTimingEventProps</code> shall only reference <code>TimingEvent</code>
[constr_1234]	Value of <code>RunnableEntity.symbol</code>
[constr_1237]	Scope of mapped <code>ClientServerOperations</code> in the context of a <code>ClientServerOperationMapping</code>
[constr_1238]	Scope of mapped <code>ApplicationErrors</code> in the context of a <code>ClientServerOperationMapping</code>
[constr_1239]	<code>RuleBasedValueSpecification</code> shall not exceed the number of values required
[constr_1240]	Consistency of <code>ArgumentDataPrototypes</code> within the context of a <code>ClientServerOperationMapping</code>
[constr_1241]	Compound Primitive Data Types and <code>invalidValue</code>
[constr_1242]	Restriction of <code>invalidValue</code> for <code>ApplicationPrimitiveDataType</code>
[constr_1243]	<code>NumericalOrText</code> shall either define <code>vf</code> or <code>vt</code>
[constr_1244]	<code>DataPrototypes</code> used in application software shall not be typed by C enums
[constr_1245]	Consideration of <code>ModeTransitions</code> for the compatibility of <code>ModeDeclarationGroups</code>
[constr_1246]	Consistency of <code>firstMode</code> and <code>secondMode</code> in the scope of one <code>ModeDeclarationMappingSet</code>
[constr_1247]	Consistency of <code>ModeDeclarationMappingSet</code> with respect to the referenced <code>firstModeGroup</code> and <code>secondModeGroup</code>
[constr_1248]	Compatibility of <code>PortPrototypes</code> of different <code>DataInterfaces</code> in the context of a <code>PassThroughSwConnector</code>
[constr_1249]	Compatibility of <code>ModeSwitchInterfaces</code> in the context of a <code>PassThroughSwConnector</code>
[constr_1250]	Compatibility of <code>ClientServerInterfaces</code> in the context of a <code>PassThroughSwConnector</code>
[constr_1251]	Compatibility of <code>PortPrototypes</code> of <code>TriggerInterfaces</code> in the context of a <code>PassThroughSwConnector</code>
[constr_1252]	Creation of a loop involving a <code>PassThroughSwConnector</code> is not allowed
[constr_1253]	Supported usage of <code>VariationPointProxy</code>
[constr_1254]	Definition of a pointer to a pointer
[constr_1255]	<code>ApplicationPrimitiveDataTypes</code> of <code>category</code> <code>BOOLEAN</code> and <code>STRING</code>
[constr_1256]	Acknowledgement feedback in n:1 writer case
[constr_1257]	No <code>WaitPoints</code> allowed



△

Number	Heading
[constr_1258]	Value of <code>minimumStartInterval</code> for <code>RunnableEntity</code> s triggered by an <code>InitEvent</code>
[constr_1259]	Aggregation of <code>AsynchronousServerCallPoint</code> and <code>AsynchronousServerCallResultPoint</code>
[constr_1260]	No mode disabling for <code>InitEvents</code>
[constr_1261]	Applicability for <code>EndToEndDescription.dataIdNibbleOffset</code>
[constr_1263]	Existence of <code>ModeErrorBehavior.defaultMode</code>
[constr_1264]	Iteration along output axis is only supported for VALUE and VAL_BLK
[constr_1268]	<code>ArgumentDataPrototype.direction</code> shall be preserved in a <code>ClientServerOperationMapping</code>
[constr_1269]	Number of <code>arguments</code> shall be preserved in a <code>ClientServerOperationMapping</code>
[constr_1270]	<code>ArgumentDataPrototype</code> shall be mapped only once in a <code>ClientServerOperationMapping</code>
[constr_1271]	<code>ArrayValueSpecification.elements</code> shall be identical to the number of <code>ApplicationRecordDataType.element</code>
[constr_1272]	<code>ArrayValueSpecification.elements</code> shall be identical to the number of <code>subElements</code> of <code>ImplementationDataType</code> of category STRUCTURE
[constr_1273]	<code>ArrayValueSpecification.elements</code> shall be identical to the value of <code>ApplicationArrayDataType.element.maxNumberOfElements</code>
[constr_1274]	<code>ArrayValueSpecification.elements</code> shall be identical to the value of <code>ImplementationDataType.subElement.arraySize</code> of category ARRAY
[constr_2054]	Valid targets of <code>rptSystem</code>
[constr_2055]	Valid targets of <code>byPassPoint</code> and <code>rptHook</code> reference
[constr_2056]	Consistency of <code>RapidPrototypingScenario</code> with respect to <code>rptSystem</code> and <code>rptArHook</code> references
[constr_2057]	Mandatory information of a <code>RuleBasedAxisCont</code>
[constr_2058]	Mandatory information of a <code>RuleBasedValueCont</code>
[constr_4082]	<code>RunnableEntity.reentrancyLevel</code> shall not be set.

Table C.10: Added Constraints in R4.1.1

Please note that [constr_2533] has been retagged to [constr_1264] to fix a duplicate constraint ID.

C.4.3 Changed Specification Items in R4.1.1

Number	Heading
[TPS_SWCT_01000]	Usage of attribute <code>symbol</code> of the <code>symbolProps</code>
[TPS_SWCT_01001]	Prefix symbols generated for the <code>RunnableEntity</code>
[TPS_SWCT_01085]	Variation on the behavior level
[TPS_SWCT_01112]	Semantics of <code>PortPrototypes</code>
[TPS_SWCT_01113]	Connecting two <code>PortPrototypes</code>
[TPS_SWCT_01128]	<code>SwRecordLayout</code> needed for <code>ApplicationPrimitiveDataType</code> of category <code>STRING</code>
[TPS_SWCT_01179]	Compound Primitive Data Type
[TPS_SWCT_01368]	Describe static and constant memory

Table C.11: Changed Specification Items in R4.1.1

C.4.4 Added Specification Items in R4.1.1

Number	Heading
[TPS_SWCT_01448]	Pre-defined values for the <code>category</code> of <code>VariationPointProxy</code>
[TPS_SWCT_01449]	Semantics of a <code>ModeDeclarationGroupPrototypeMapping</code>
[TPS_SWCT_01450]	Semantics of a <code>ModeTransition</code>
[TPS_SWCT_01451]	Relations between <code>ModeTransition</code> and <code>ModeDeclaration</code>
[TPS_SWCT_01452]	Applicability of <code>networkRepresentation</code> for <code>ApplicationCompositeDataType</code>
[TPS_SWCT_01454]	<code>PRPortPrototype</code> can own both <code>RPortComSpecs</code> and <code>PPortComSpecs</code>
[TPS_SWCT_01455]	Duplicate existence of <code>initValue</code> in the context of a <code>PRPortPrototype</code>
[TPS_SWCT_01456]	Predefined values for <code>MemorySection.option</code> and <code>SwAddrMethod.option</code>
[TPS_SWCT_01457]	<code>ExclusiveAreaNestingOrder</code>
[TPS_SWCT_01458]	Indicate that the locking behavior is fully described for <code>RunnableEntity</code>
[TPS_SWCT_01459]	Locking behavior is not described for this <code>RunnableEntity</code>
[TPS_SWCT_01460]	Relation of <code>SynchronousServerCallPoint</code> to <code>ExclusiveAreaNestingOrder</code>
[TPS_SWCT_01461]	Existence of <code>ImplementationDataType</code>
[TPS_SWCT_01462]	<code>ModeDeclarationMapping</code> defines the explicit correlation of <code>ModeDeclarations</code>
[TPS_SWCT_01463]	<code>ModeDeclarationGroupPrototypeMapping.modeDeclarationMappingSet</code> defines the applicable set of <code>ModeDeclarationMappings</code>
[TPS_SWCT_01464]	<code>ModeDeclaration</code> of a mode user is mapped to exactly one <code>ModeDeclaration</code> of a mode manager
[TPS_SWCT_01465]	<code>ModeDeclaration</code> of a mode user is mapped to several <code>ModeDeclarations</code> of a mode manager





Number	Heading
[TPS_SWCT_01466]	<code>ConsistencyNeeds</code> applied on <code>RunnableEntities</code> that do not use implicit communication
[TPS_SWCT_01467]	<code>ImplementationDataType</code> references an <code>SwBaseType</code> with a string encoding
[TPS_SWCT_01469]	RTE API for retrieving the current activation reason
[TPS_SWCT_01470]	<code>RunnableEntityGroup</code>
[TPS_SWCT_01471]	<code>DataPrototypeGroup</code>
[TPS_SWCT_01472]	Receiving <code>SwComponentType</code> owns a <code>DataPrototypeGroup</code> in the role <code>regRequiresStability</code>
[TPS_SWCT_01473]	Receiving <code>SwComponentType</code> owns a <code>RunnableEntityGroup</code> in the role <code>regRequiresStability</code>
[TPS_SWCT_01474]	Receiving <code>SwComponentType</code> owns a <code>RunnableEntityGroup</code> in the role <code>regRequiresStability</code> and also owns one or several <code>DataPrototypeGroups</code> in the role <code>regRequiresStability</code>
[TPS_SWCT_01475]	Sending <code>SwComponentType</code> owns a <code>DataPrototypeGroup</code> in the role <code>regRequiresStability</code>
[TPS_SWCT_01476]	Sender and receiver of the same implicitly communicated <code>VariableDataPrototypes</code> are associated with the same <code>RunnableEntityGroup</code>
[TPS_SWCT_01477]	Integral Primitive Types
[TPS_SWCT_01478]	Array size is defined as an attribute of the <code>ImplementationDataTypeElement</code>
[TPS_SWCT_01479]	Applicability of <code>ConsistencyNeeds</code>
[TPS_SWCT_01480]	<i>Stability</i> and/or <i>coherence</i> is not required
[TPS_SWCT_01481]	The meaning of the term <i>stability</i> with respect to <code>ConsistencyNeeds</code>
[TPS_SWCT_01482]	The meaning of the term <i>coherence</i> with respect to <code>ConsistencyNeeds</code>
[TPS_SWCT_01483]	Use static and constant memory to support Measurement and Calibration
[TPS_SWCT_01484]	Meaning of <code>ApplicationRuleBasedValueSpecification</code>
[TPS_SWCT_01485]	<code>RuleBasedValueSpecification</code> shall initialize first elements in an array
[TPS_SWCT_01486]	<code>ApplicationPrimitiveDataType</code> of category <code>STRING</code> may have <code>invalidValue</code>
[TPS_SWCT_01487]	Correspondence of <code>invalidValue</code> for <code>ApplicationPrimitiveDataType</code> and <code>ImplementationDataType</code>
[TPS_SWCT_01488]	<code>ApplicationPrimitiveDataType</code> shall be interpreted as a string of a particular encoding
[TPS_SWCT_01489]	Standardized values of <code>SwRecordLayoutV.swRecordLayoutVProp</code>
[TPS_SWCT_01490]	AUTOSAR supports <code>ApplicationErrors</code> only for <code>ClientServerInterfaces</code>
[TPS_SWCT_01491]	AUTOSAR system does not need to explicitly describe infrastructure errors
[TPS_SWCT_01492]	Default values for <code>factorSiToUnit</code> and <code>offsetSiToUnit</code>
[TPS_SWCT_01493]	The number of <code>RuleArguments.arguments</code> shall not exceed the array size





Number	Heading
[TPS_SWCT_01494]	A RuleBasedValueSpecification of rule <code>FILL_UNITIL_END</code> shall fill the value of the last RuleArguments .argument until the last element of the array
[TPS_SWCT_01495]	Standardized value of RuleBasedValueSpecification.category
[TPS_SWCT_01496]	General precedence rule for attributes of SwDataDefProps
[TPS_SWCT_01497]	Precedence of the <code>unit</code> of value axis
[TPS_SWCT_01498]	Precedence of the <code>DataConstr</code> of value axis
[TPS_SWCT_01499]	Precedence of the <code>CompuMethod</code> of value axis
[TPS_SWCT_01500]	Precedence of the display format of value axis
[TPS_SWCT_01501]	Precedence of the calibration access of value axis
[TPS_SWCT_01502]	Precedence of the <code>Unit</code> of the input axis
[TPS_SWCT_01503]	Precedence of the <code>DataConstr</code> of the input axis
[TPS_SWCT_01504]	Precedence of the display format of the input axis
[TPS_SWCT_01505]	Precedence of calibration access along structure hierarchies in complex types
[TPS_SWCT_01506]	Precedence of the calibration access of input axis
[TPS_SWCT_01507]	The role of PassThroughSwConnector
[TPS_SWCT_01508]	Scope of end-to-end protection
[TPS_SWCT_01509]	Implicit communication behavior
[TPS_SWCT_01510]	The role of pretended networking
[TPS_SWCT_01511]	Configuration option is encoded into ModeDeclaration
[TPS_SWCT_01512]	Request change of <code>Pretended Networking mode</code>
[TPS_SWCT_01513]	React on the change of <code>Pretended Networking mode</code>
[TPS_SWCT_01514]	Duplicate existence of <code>initValue</code> in the context of a PRPortPrototype
[TPS_SWCT_01515]	PPortInCompositionInstanceRef shall be used for attaching DelegationSwConnector to an inner PRPortPrototype
[TPS_SWCT_01516]	PortInterface describes the static structure of information interchange
[TPS_SWCT_01517]	ClientServerOperation cannot be passed as a reference
[TPS_SWCT_01518]	Priority of initial value definition with respect to conceptual levels
[TPS_SWCT_01519]	RTE executes certain RunnableEntity periodically
[TPS_SWCT_01520]	Implication of the existence of <code>possibleError</code> on compatibility of ClientServerOperations
[TPS_SWCT_01521]	Use AutosarVariableRef.localVariable for referencing inter-runnable variables
[TPS_SWCT_01522]	No initial value is specified for implicitInterRunnableVariable or explicitInterRunnableVariable
[TPS_SWCT_01523]	Internal trigger event
[TPS_SWCT_01524]	Usage of IoHwAbstractionServerAnnotation
[TPS_SWCT_01525]	InitEvent references a RunnableEntity in the role <code>startOnEvent</code>
[TPS_SWCT_01528]	Meaning of NumericalRuleBasedValueSpecification



△

Number	Heading
[TPS_SWCT_01529]	Default value for <code>EndToEndDescription.dataIdNibbleOffset</code>
[TPS_SWCT_01530]	Error behavior of mode manager and mode user
[TPS_SWCT_01531]	The semantics of <code>ModeErrorReactionPolicyEnum</code>
[TPS_SWCT_01532]	The role of <code>ModeErrorBehavior.defaultMode</code>
[TPS_SWCT_01533]	<code>ModeDeclarationGroup.initialMode</code> shall be assumed in the absence of <code>ModeDeclarationGroup.modeManagerErrorBehavior</code>
[TPS_SWCT_01534]	<code>ModeDeclarationGroup.initialMode</code> shall be assumed in the absence of <code>ModeDeclarationGroup.modeUserErrorBehavior</code>
[TPS_SWCT_01535]	Mode manager reacts on mode error
[TPS_SWCT_01536]	Coherent behavior of all mode users in case of errors in the mode switch communication
[TPS_SWCT_01541]	Preferential selection of <code>modeUserErrorBehavior</code>
[TPS_SWCT_01542]	Preferential selection of <code>modeManagerErrorBehavior</code>
[TPS_SWCT_01543]	<code>PortInterfaceMapping</code> overrides all other compatibility rules
[TPS_SWCT_01544]	<i>prefix</i> used for the actual name of the used <code>PortInterface</code> for the routing activation
[TPS_SWCT_01545]	<code>ModeDeclaration</code> of a <i>mode user</i> that is not mapped to a <code>ModeDeclaration</code> of a <i>mode manager</i>
[TPS_SWCT_01546]	Notification when an external tester is attached or activated
[TPS_SWCT_01547]	Ability to set and reset the Warning Indicator Status bit
[TPS_SWCT_02046]	<code>byPassPoint</code> specifies the rapid prototyping capability
[TPS_SWCT_02047]	<code>RptHook</code> specifies the link to rapid prototyping algorithm
[TPS_SWCT_02048]	Implicit <code>SwComponentPrototype</code> selection for Rapid Prototyping Scenario
[TPS_SWCT_02049]	Implicit <code>RunnableEntity</code> selection for Rapid Prototyping Scenario
[TPS_SWCT_02050]	Explicit access point selection for Rapid Prototyping Scenario
[TPS_SWCT_02051]	Explicit <code>DataPrototype</code> selection for Rapid Prototyping Scenario
[TPS_SWCT_02052]	Definition of Rapid Prototyping Scenario is splittable
[TPS_SWCT_02053]	Values of <code>RuleBasedAxisCont</code> with the <i>category</i> <code>COM_AXIS</code> , <code>RES_AXIS</code> are for display only
[TPS_SWCT_02507]	Instantiation-specific <code>RTEEvents</code>

Table C.12: Added Specification Items in 4.1.1

C.4.5 Deleted Constraints in R4.1.1

Number	Heading
[constr_1239]	RuleBasedValueSpecification shall not exceed the number of values required
[constr_1145]	Finding the symbol for the representation of a CompuScale in C code
[constr_2533]	Iteration along output axis is only supported for VALUE and VAL_BLK

Table C.13: Deleted Constraints in R4.1.1

Please note that [constr_2533] has been retagged to [[constr_1264](#)] to fix a duplicate constraint ID.

C.4.6 Deleted Specification Items in R4.1.1

Number	Heading
[TPS_SWCT_01210]	IoHwAbstractionServerAnnotation

Table C.14: Deleted Specification Items in R4.1.1

C.5 Constraint History of this Document according to AUTOSAR R4.1.2

C.5.1 Changed Constraints in R4.1.2

Number	Heading
[constr_1006]	applicable data categories
[constr_1007]	Allowed attributes of SwDataDefProps for ApplicationDataTypes
[constr_1009]	SwDataDefProps applicable to ImplementationDataTypes
[constr_1015]	Prioritization of SwDataDefProps
[constr_1043]	PortInterface vs. ComSpec
[constr_1058]	ImplementationDataType has category FUNCTION_REFERENCE
[constr_1102]	ApplicationError in the scope of one SwComponentType
[constr_1146]	Applicability of a symbol for a CompuScale in C code
[constr_1163]	Compatibility of CompuMethods
[constr_1133]	Identical CompuScale Symbolic Names shall have the same range
[constr_1158]	Applicable categorys for attribute ImplementationDataType.swDataDef-Props.compuMethod
[constr_1225]	DataPrototype is typed by an ImplementationDataType that references a CompuMethod of category TEXTTABLE or BITFIELD_TEXTTABLE



△

Number	Heading
[constr_2013]	Compatibility of <code>ImplementationDataTypes</code> for <code>NvBlockDataMapping</code>
[constr_2051]	Mandatory information of a <code>SwValueCont</code>

Table C.15: Changed Constraints in R4.1.2

C.5.2 Added Constraints in R4.1.2

Number	Heading
[constr_1277]	<code>SwDataDefProps.swImplPolicy</code> of a <code>VariableDataPrototype</code> referenced by a <code>VariableAccess</code> aggregated in the role <code>dataReceivePointByValue</code>
[constr_1278]	<code>PhysConstrs</code> references a <code>Unit</code>
[constr_1279]	Unmapped elements of <code>ApplicationCompositeDataTypes</code> or <code>ImplementationDataTypes</code> and the attribute <code>swImplPolicy</code>
[constr_1280]	Unmapped <code>dataElement</code> on the receiver side shall have an <code>initValue</code>
[constr_1281]	<code>invalidValue</code> shall be inside the scope of the <code>compuMethod</code>
[constr_1282]	Restriction concerning the usage of <code>RuleBasedValueSpecification</code> or a <code>ReferenceValueSpecification</code> for the specification of an <code>invalidValue</code>
[constr_1283]	<code>invalidValue</code> is outside the scope of the <code>compuMethod</code>
[constr_1284]	Limitation of the use of <code>TextValueSpecification</code>
[constr_1285]	Applicability of roles vs. <code>PortPrototypes</code>
[constr_1286]	<code>serverArgumentImplPolicy</code> and <code>ArgumentDataPrototype</code> typed by primitive data types
[constr_1287]	Compatibility of <code>SenderReceiverInterfaces</code> with respect to <code>invalidationPolicy</code>
[constr_1288]	Allowed Attributes vs. <code>category</code> for <code>DataPrototypes</code> typed by <code>ImplementationDataTypes</code>
[constr_1289]	Allowed Attributes vs. <code>category</code> for <code>DataPrototypes</code> typed by <code>ApplicationDataTypes</code>
[constr_1290]	Limitation on the number of <code>PPortComSpecs</code> in the context of one <code>PPortPrototype</code>
[constr_1291]	Limitation on the number of <code>RPortComSpecs</code> in the context of one <code>PPortPrototype</code>
[constr_1292]	Limitation on the number of <code>RPortComSpecs/PPortComSpecs</code> in the context of one <code>PRPortPrototype</code>
[constr_1293]	Existence of <code>DiagnosticEventNeeds.dtcNumber</code>
[constr_1294]	Existence of <code>DiagnosticEventInfoNeeds.dtcNumber</code>
[constr_1295]	<code>PortInterfaces</code> and <code>category</code> DATA_REFERENCE
[constr_1296]	<code>DataPrototypes</code> used as <code>explicitInterRunnableVariable</code> or <code>implicitInterRunnableVariable</code> and <code>category</code> DATA_REFERENCE

Table C.16: Added Constraints in R4.1.2

C.5.3 Changed Specification Items in R4.1.2

Number	Heading
[TPS_SWCT_01006]	<code>ImplementationDataType.subElement.arraySize</code> shall be used to define the size of the array
[TPS_SWCT_01175]	Actively query the status of a partial network
[TPS_SWCT_01219]	ComSpec for queued and non-queued sender-receiver communication
[TPS_SWCT_01154]	Attribute <code>prefix</code> of <code>IncludedModeDeclarationGroupSet</code>
[TPS_SWCT_02011]	<code>AtomicSwComponentType</code> offers a server port to read DTR value via OBD services

Table C.17: Changed Specification Items in R4.1.2

C.5.4 Added Specification Items in R4.1.2

Number	Heading
[TPS_SWCT_01549]	Definition of linear data scaling
[TPS_SWCT_01550]	Definition of reciprocal linear data scaling
[TPS_SWCT_01551]	Mapping of elements on the sender side to elements on the receiver side
[TPS_SWCT_01552]	Software-component acts as a mode manager
[TPS_SWCT_01553]	Software-component acts as a mode user
[TPS_SWCT_01554]	Software-component acts as a mode requester
[TPS_SWCT_01555]	<code>ModeSwitchedAckEvent</code> is triggered by the RTE regardless
[TPS_SWCT_01556]	Rule for setting <code>RoleBasedPortAssignment.role</code>
[TPS_SWCT_01557]	<code>dataWriteAccess</code> also allows for the definition of a <code>DataWriteCompletedEvent</code>
[TPS_SWCT_01558]	<code>DataWriteCompletedEvent</code> cannot be combined with a <code>WaitPoint</code>
[TPS_SWCT_01559]	Default value for attribute <code>SwDataDefProps.swCalibrationAccess</code>
[TPS_SWCT_01560]	Supported <code>categorys</code> of <code>CompuMethods</code> for data conversion
[TPS_SWCT_01561]	Application of data conversion to composite <code>AutosarDataTypes</code>
[TPS_SWCT_01562]	Specification of values of an enumeration
[TPS_SWCT_01563]	Applicable values for <code>nativeDeclaration</code>
[TPS_SWCT_01564]	Non-recursive definition of a primitive data type
[TPS_SWCT_01565]	Recursive definition of a primitive data type
[TPS_SWCT_01566]	Define literals for an MCD system in the context of a <code>FlatInstanceDescriptor</code>
[TPS_SWCT_01567]	Default behavior for <code>invalidationPolicy</code>
[TPS_SWCT_01568]	Consideration of <code>RPortComSpec</code> or <code>PPortComSpec</code> depending on the ownership
[TPS_SWCT_01569]	Definition of <code>CompuScale</code> Symbolic Name





Number	Heading
[TPS_SWCT_01570]	DataTypeMap is mandatory in the presence of ApplicationPrimitive-DataType.swDataDefProps.swRecordLayout

Table C.18: Added Specification Items in 4.1.2

C.5.5 Deleted Constraints in R4.1.2

Number	Heading
[constr_1042]	Definition of a linear data scaling
[constr_1094]	Usage of symbol of RunnableEntity
[constr_2025]	Uniqueness of symbol attributes (This constraint has been relocated to [10])
[constr_2032]	transmissionAcknowledge requires a DataSendCompletedEvent
[constr_4011]	ComSpec and ModeSwitchedAckEvent

Table C.19: Deleted Constraints in R4.1.2

C.5.6 Deleted Specification Items in R4.1.2

Number	Heading
[TPS_SWCT_01327]	RTE generator can omit the creation of checks at run-time

Table C.20: Deleted Specification Items in R4.1.2

C.6 Constraint History of this Document according to AUTOSAR R4.1.3

C.6.1 Added Traceables in R4.1.3

Number	Heading
[TPS_SWCT_01573]	A PRPortPrototype is never considered unconnected
[TPS_SWCT_01574]	PerInstanceMemory.typeDefinition shall not contain a function pointer

Table C.21: Added Traceables in 4.1.3

C.6.2 Changed Traceables in R4.1.3

Number	Heading
[TPS_SWCT_01009]	The numerical values used to define the values of <code>ModeDeclaration.value</code> and <code>ModeDeclarationGroup.onTransitionValue</code> can be arbitrarily defined
[TPS_SWCT_01049]	Two ways to use the <code>ExclusiveAreas</code>

Table C.22: Changed Traceables in R4.1.3

C.6.3 Deleted Traceables in R4.1.3

Number	Heading
[TPS_SWCT_01417]	Define calibration parameters common to all <code>SwComponentPrototypes</code> of the same <code>SwComponentType</code>
[TPS_SWCT_01419]	<code>ParameterSwComponentType</code> shall never aggregate a <code>SwcInternalBehavior</code>
[TPS_SWCT_02006]	<code>AtomicSwComponentType</code> offers sender receiver ports to adjust the IO signal via diagnostic services

Table C.23: Deleted Traceables in R4.1.3

C.6.4 Added Constraints in R4.1.3

Number	Heading
[constr_1297]	Applicability of <code>serverArgumentImplPolicy</code> set to [useArrayBaseType]
[constr_1298]	Existence of attributes if <code>category</code> of a <code>ModeDeclarationGroup</code> is set to <code>EXPLICIT_ORDER</code>
[constr_1299]	Existence of attributes if <code>category</code> of a <code>ModeDeclarationGroup</code> is set to other than <code>EXPLICIT_ORDER</code>

Table C.24: Added Constraints in R4.1.3

C.6.5 Changed Constraints in R4.1.3

Number	Heading
[constr_1006]	applicable data categories
[constr_1007]	Allowed attributes of <code>SwDataDefProps</code> for <code>ApplicationDataTypes</code>
[constr_1230]	<code>ApplicationDataType</code> that qualifies for Integral Primitive Type

Table C.25: Changed Constraints in R4.1.3

C.6.6 Deleted Constraints in R4.1.3

Number	Heading
[constr_1179]	Existence of <code>ModeDeclaration.value</code> within a <code>ModeDeclarationGroup</code>
[constr_1180]	Existence of <code>ModeDeclarationGroup.onTransitionValue</code>

Table C.26: Deleted Constraints in R4.1.3

C.7 Constraint History of this Document according to AUTOSAR R4.2.1

C.7.1 Added Traceables in R4.2.1

Number	Heading
[TPS_SWCT_01572]	Application Mode Manager interacts with both <code>BswM</code> and other <code>ApplicationSwComponentTypes</code>
[TPS_SWCT_01577]	<code>AtomicSwComponentType</code> requires the notification about a Service Request via diagnostic services with <i>manufacturer</i> characteristics
[TPS_SWCT_01578]	<code>AtomicSwComponentType</code> requires the notification about a Service Request via diagnostic services with <i>supplier</i> characteristics
[TPS_SWCT_01579]	<code>Dcm</code> can directly access <code>dataElements</code> in <code>PPortPrototypes</code> typed by a <code>SenderReceiverInterface</code>
[TPS_SWCT_01580]	<code>Dem</code> can directly access <code>dataElements</code> in <code>PPortPrototypes</code> typed by a <code>SenderReceiverInterface</code>
[TPS_SWCT_01581]	Communication patterns for mode-related communication
[TPS_SWCT_01582]	Semantics of <code>DiagnosticEventNeeds.deferringFid</code>
[TPS_SWCT_01583]	Completeness of <code>TextTableMapping</code> is not a requirement
[TPS_SWCT_01584]	<code>InternalBehavior</code> of a <code>NvBlockSwComponentType</code> for implementing a writing strategy
[TPS_SWCT_01585]	Relevance of <code>NvBlockDescriptor.timingEvent.period</code>
[TPS_SWCT_01586]	Writing strategies for <i>nv data</i>
[TPS_SWCT_01587]	The cyclic writing of <i>nv data</i> requires the existence of a <code>TimingEvent</code>
[TPS_SWCT_01588]	<code>DataReceivedEvent</code> for storing <i>nv data</i> immediately
[TPS_SWCT_01589]	Implementation of emergency storing of <i>nv data</i>
[TPS_SWCT_01590]	Combination of writing strategies for <i>nv data</i> is possible
[TPS_SWCT_01591]	Existence of attribute <code>DiagnosticEventNeeds.reportBehavior</code>
[TPS_SWCT_01592]	Communication among <code>RunnableEntities</code> of different instances of the same <code>AtomicSwComponentType</code>
[TPS_SWCT_01593]	Semantics of attribute <code>ReceiverComSpec.transformationComSpecProps</code>
[TPS_SWCT_01594]	Semantics of <code>TransformationComSpecProps</code>
[TPS_SWCT_01595]	Semantics of attribute <code>ClientComSpec.transformationComSpecProps</code>





Number	Heading
[TPS_SWCT_01596]	Semantics of attribute <code>ServerComSpec.transformationComSpecProps</code>
[TPS_SWCT_01597]	<code>PortPrototype</code> -specific data transformation configuration
[TPS_SWCT_01598]	More than one user-defined transformer is used within one transformer chain
[TPS_SWCT_01599]	<code>PortPrototype</code> -specific configuration for custom transformers
[TPS_SWCT_01600]	<code>PortPrototype</code> -specific configuration for data transformers related to end-to-end protection
[TPS_SWCT_01601]	<code>Size Indicator</code> shall be updated by software-component
[TPS_SWCT_01602]	<code>Size Indicator</code> shall be read by the software-component
[TPS_SWCT_01603]	Variable size array with <code>Size Indicator</code>
[TPS_SWCT_01604]	Enable <code>Size Indicator</code>
[TPS_SWCT_01605]	Semantics of <code>ApplicationArrayElement.arraySizeHandling</code>
[TPS_SWCT_01606]	Internal structure of mapped <code>ImplementationDataType</code>
[TPS_SWCT_01607]	Profiles for internal structure of mapped <code>ImplementationDataType</code>
[TPS_SWCT_01608]	Custom profiles for internal structure of mapped <code>ImplementationDataType</code>
[TPS_SWCT_01609]	A <code>RuleBasedValueSpecification</code> of rule <code>FILL_UNTIL_MAX_SIZE</code> shall fill the value of the last <code>RuleArguments.argument</code> until the number of elements specified in <code>maxSizeToFill</code>
[TPS_SWCT_01610]	Modeling of a <code>Variable-Size Array Data Type</code> with <code>Size Indicator</code> enabled
[TPS_SWCT_01611]	Enable <code>Size Indicator</code>
[TPS_SWCT_01612]	<code>arraySizeHandling</code> specifies how the size is determined
[TPS_SWCT_01613]	Internal structure of mapped <code>ImplementationDataType</code>
[TPS_SWCT_01614]	Profiles for internal structure of mapped <code>ImplementationDataType</code>
[TPS_SWCT_01615]	Custom profiles for internal structure of mapped <code>ImplementationDataType</code>
[TPS_SWCT_01616]	Semantics of <code>TransformerHardErrorEvent</code>
[TPS_SWCT_01617]	Structure of an <code>ImplementationDataType</code> that represents a variable-sized array data type
[TPS_SWCT_01618]	<code>Size Indicator</code> for <code>dynamicArraySizeProfile</code> set to <code>VSA_LINEAR</code> , <code>VSA_SQUARE</code> , or <code>VSA_FULLY_FLEXIBLE</code>
[TPS_SWCT_01619]	<code>Size Indicator</code> for <code>dynamicArraySizeProfile</code> set to <code>VSA_RECTANGULAR</code>
[TPS_SWCT_01620]	<code>Size Indicator</code> for <code>dynamicArraySizeProfile</code> set to <code>VSA_RECTANGULAR</code>
[TPS_SWCT_01621]	Payload for <code>dynamicArraySizeProfile</code>
[TPS_SWCT_01622]	Modeling of a <code>Variable-Size Array Data Type</code> only with <code>ImplementationDataType</code>
[TPS_SWCT_01623]	Justification for the existence of attributes <code>ApplicationArrayDataType</code> , <code>dynamicArraySizeProfile</code> and <code>ApplicationArrayElement.arraySizeHandling</code>
[TPS_SWCT_01624]	Hard error occurs during the execution of a transformer chain





Number	Heading
[TPS_SWCT_01625]	Sending <code>SwComponentType</code> owns a <code>DataPrototypeGroup</code> in the role <code>dp-gRequiresCoherency</code> and also <code>RunnableEntityGroups</code>
[TPS_SWCT_01626]	Error notification of data transformer errors
[TPS_SWCT_01627]	Suffix used for the resulting name of the <code>PortInterface</code> for the Security Access
[TPS_SWCT_01628]	Suffix used for the resulting name of the <code>PortInterface</code> for the Data Services
[TPS_SWCT_01629]	Suffix used for the resulting name of the <code>PortInterface</code> for the Data Services
[TPS_SWCT_01630]	Suffix used for the resulting name of the <code>PortInterface</code> for the Data Services
[TPS_SWCT_01631]	Suffix used for the resulting name of the <code>PortInterface</code> for the Infotype Services
[TPS_SWCT_01632]	Suffix used for the resulting name of the <code>PortInterface</code> for the Routine Services
[TPS_SWCT_01633]	Suffix used for the resulting name of the <code>PortInterface</code> for the Request Control Services
[TPS_SWCT_01634]	Suffix used for the resulting name of the <code>PortInterface</code> for the Data Services
[TPS_SWCT_01635]	Naming conventions may support the effectiveness of <code>SymbolProps</code>
[TPS_SWCT_01636]	Definition of profiles for the definition of <code>Variable-Size Array Data Types</code>

Table C.27: Added Traceables in 4.2.1

C.7.2 Changed Traceables in R4.2.1

Number	Heading
[TPS_SWCT_01044]	<code>ServiceNeeds</code>
[TPS_SWCT_01053]	Relationship of interchanged data with <code>RunnableEntitys</code>
[TPS_SWCT_01141]	<code>AtomicSwComponentType</code> may have <code>AbstractRequiredPortPrototypes</code> typed by an <code>NvDataInterface</code>
[TPS_SWCT_01150]	<code>InternalBehavior</code> of a <code>NvBlockSwComponentType</code> to enable access to the NVRAM Block management API
[TPS_SWCT_01162]	Existence of <code>TextTableMapping</code>
[TPS_SWCT_01180]	Maximum possible size of Compound Primitive Data Type
[TPS_SWCT_01227]	Unconnected <code>AbstractRequiredPortPrototype</code> typed by <code>NvDataInterface</code>
[TPS_SWCT_01228]	<code>NvProvideComSpec</code>
[TPS_SWCT_01239]	default value for attribute <code>category</code> used in the context of <code>SwSystemconst</code>
[TPS_SWCT_01274]	<code>SwDataDefProps</code> used to support calibration and measurement





Number	Heading
[TPS_SWCT_01321]	Communication among RunnableEntity s
[TPS_SWCT_01330]	RunnableEntity can also have dataSendPoints
[TPS_SWCT_01335]	Combine dataReceivePointByValue or dataReceivePointByArgument with a WaitPoint
[TPS_SWCT_01348]	Trigger source
[TPS_SWCT_01385]	Execution of finalization code for software-components
[TPS_SWCT_01456]	Predefined values for MemorySection.option and SwAddrMethod.option
[TPS_SWCT_01475]	Sending SwComponentType owns a DataPrototypeGroup in the role dp-gRequiresCoherency
[TPS_SWCT_01494]	A RuleBasedValueSpecification of rule <code>FILL_UNTIL_END</code> shall fill the value of the last RuleArguments.argument until the last element of the array
[TPS_SWCT_01495]	Standardized value of RuleBasedValueSpecification.rule
[TPS_SWCT_01549]	Definition of linear data scaling
[TPS_SWCT_01560]	Supported categorys of CompuMethods for data conversion
[TPS_SWCT_02501]	Setup for Nvm Use Case: Permanent RAM Block
[TPS_SWCT_02502]	Setup for Nvm Use Case: Temporary RAM Block
[TPS_SWCT_02503]	Setup for NVM Use Case: Software-Components using Nv Data provided by NvBlockSwComponentType
[TPS_SWCT_02504]	Setup for Nvm Use Case: RAM Block with explicit synchronization using Mirror Interfaces

Table C.28: Changed Traceables in R4.2.1

C.7.3 Deleted Traceables in R4.2.1

Number	Heading
Id	Heading
[TPS_SWCT_01131]	AtomicSwComponentType accepts a request to restart an entire function
[TPS_SWCT_01386]	Initialization by mode management
[TPS_SWCT_01387]	Finalization by mode management
[TPS_SWCT_01410]	Dcm and Dem can directly access dataElements in PPortPrototypes typed by a SenderReceiverInterface
[TPS_SWCT_01438]	Handling of invalidation in the sending RTE
[TPS_SWCT_01439]	Handling of invalidation in the receiving RTE
[TPS_SWCT_02017]	AtomicSwComponentType requires the notification about a Service Request via diagnostic services

Table C.29: Deleted Traceables in R4.2.1

C.7.4 Added Constraints in R4.2.1

Number	Heading
[constr_1300]	Primitive <code>DataPrototype</code> on the provider side shall not be mapped to element of a composite data type on the requester side
[constr_1301]	Existence of <code>RoleBasedDataTypeAssignment.role</code> vs. <code>RoleBasedDataAssignment.role</code>
[constr_1302]	Restriction of data invalidation
[constr_1303]	Applicability of <code>TextTableMapping</code> depending on the value of <code>CompuMethod.category</code>
[constr_1304]	Existence of attribute <code>bitfieldTextTableMaskFirst</code>
[constr_1305]	Existence of attribute <code>bitfieldTextTableMaskSecond</code>
[constr_1306]	Limitation of <code>TextTableMapping</code> for <code>CompuMethods</code> that have the value of <code>category</code> set to <code>BITFIELD_TEXTTABLE</code>
[constr_1307]	Consistency of values and masks in <code>TextTableMapping</code>
[constr_1308]	Existence of <code>NvBlockNeeds.cyclicWritingPeriod</code>
[constr_1309]	Existence of <code>NvBlockDescriptor.timingEvent</code>
[constr_1310]	Existence of attributes of meta-class <code>NvBlockNeeds</code>
[constr_1311]	Appearance of safety-related possible values of <code>MemorySection.option</code> or <code>SwAddrMethod.option</code> according to [TPS_SWCT_01456]
[constr_1312]	<code>PortPrototypes</code> typed by a <code>ParameterInterface</code>
[constr_1313]	Completeness of <code>TextTableMapping</code> for the values of a given bit mask on the sender side
[constr_1314]	Profile <code>VSA_LINEAR</code> for <code>ApplicationArrayDataType</code>
[constr_1315]	Profile <code>VSA_SQUARE</code> for <code>ApplicationArrayDataType</code>
[constr_1316]	Profile <code>VSA_RECTANGULAR</code> for <code>ApplicationArrayDataType</code>
[constr_1317]	Profile <code>VSA_FULLY_FLEXIBLE</code> for <code>ApplicationArrayDataType</code>
[constr_1318]	Profile <code>VSA_LINEAR</code> for <code>ImplementationDataType</code>
[constr_1319]	Profile <code>VSA_SQUARE</code> for <code>ImplementationDataType</code>
[constr_1320]	Profile <code>VSA_RECTANGULAR</code> for <code>ImplementationDataType</code>
[constr_1321]	Profile <code>VSA_FULLY_FLEXIBLE</code> for <code>ImplementationDataType</code>
[constr_1322]	<code>Size Indicator</code> for undefined <code>dynamicArraySizeProfile</code>
[constr_1323]	Applicability of attribute <code>ReceiverComSpec.usesEndToEndProtection</code>
[constr_1363]	Existence of attributes of <code>DiagnosticValueNeeds</code>
[constr_1364]	Existence of attributes of <code>DiagnosticIoControlNeeds</code>
[constr_1375]	Existence of attributes of <code>CompuMethod</code> and related meta-classes

Table C.30: Added Constraints in R4.2.1

C.7.5 Changed Constraints in R4.2.1

Number	Heading
[constr_1006]	applicable data categories
[constr_1007]	Allowed attributes of <code>SwDataDefProps</code> for <code>ApplicationDataTypes</code>
[constr_1009]	<code>SwDataDefProps</code> applicable to <code>ImplementationDataTypes</code>
[constr_1014]	Supported value encodings for <code>SwBaseType</code>
[constr_1015]	Prioritization of <code>SwDataDefProps</code>
[constr_1037]	Client shall not be connected to multiple servers
[constr_1072]	Compatibility of <code>ModeSwitchInterfaces</code> in the context of an <code>AssemblySwConnector</code>
[constr_1073]	Compatibility of <code>ModeSwitchInterfaces</code> in the context of an <code>DelegationSwConnector</code>
[constr_1074]	Compatibility of <code>ModeDeclarationGroupPrototypes</code>
[constr_1101]	Mode-related communication
[constr_1112]	Constraints of <code>dataIdMode</code> in <code>PROFILE_01</code>
[constr_1149]	<code>PortPrototypes</code> used for NV data management
[constr_1188]	Existence of <code>ReceiverComSpec.replaceWith</code>
[constr_1288]	Allowed Attributes vs. <code>category</code> for <code>DataPrototypes</code> typed by <code>ImplementationDataTypes</code>
[constr_1289]	Allowed Attributes vs. <code>category</code> for <code>DataPrototypes</code> typed by <code>ApplicationDataTypes</code>
[constr_2009]	Supported kinds of <code>PortPrototypes</code> of a <code>NvBlockSwComponentType</code>
[constr_2015]	Limitation of <code>SwcInternalBehavior</code> of a <code>NvBlockSwComponentType</code>
[constr_2019]	<code>ServiceSwComponentType</code> shall have service ports only
[constr_2022]	Mutually exclusive use of <code>SynchronousServerCallPoints</code> and <code>AsynchronousServerCallPoints</code>
[constr_2051]	Mandatory information of a <code>SwValueCont</code>

Table C.31: Changed Constraints in R4.2.1

C.7.6 Deleted Constraints in R4.2.1

Number	Heading
[constr_1189]	Allowed targets of <code>externalReplacement</code>
[constr_1293]	Existence of <code>DiagnosticEventNeeds.dtcNumber</code>
[constr_1294]	Existence of <code>DiagnosticEventInfoNeeds.dtcNumber</code>
[constr_2551]	<code>SwCalprmAxis.baseType</code> shall be ignored

Table C.32: Deleted Constraints in R4.2.1

C.8 Constraint History of this Document according to AUTOSAR R4.2.2

C.8.1 Added Traceables in R4.2.2

Number	Heading
[TPS_SWCT_01637]	Initial value for a specific <code>implicitInterRunnableVariable</code> or <code>explicitInterRunnableVariable</code>
[TPS_SWCT_01638]	Existence of <code>SwConnector</code> between two <code>PRPortPrototypes</code>
[TPS_SWCT_01639]	<code>AtomicSwComponentType</code> offers a <code>PPortPrototype</code> typed by <code>ClientServerInterface</code> to read/write current value via diagnostic services where the applicable DID is passed as an argument to the access functions
[TPS_SWCT_01640]	Suffix used for the resulting name of the <code>PortInterface</code> for the Data Services
[TPS_SWCT_01641]	Definition of an “old-world” dynamic-size array data type by means of an <code>ApplicationArrayDataType</code>
[TPS_SWCT_01642]	Definition of an “old-world” dynamic-size array data type by means of an <code>ImplementationDataType</code>
[TPS_SWCT_01644]	Definition of a “new-world” variable-size array data type by means of an <code>ApplicationArrayDataType</code>
[TPS_SWCT_01645]	Definition of a “new-world” variable-size array data type by means of an <code>ImplementationDataType</code>
[TPS_SWCT_01646]	Sending <code>invalidValue</code> without invalidation applied by RTE/Com
[TPS_SWCT_01647]	<code>Size Indicator</code> for <code>dynamicArraySizeProfile</code> set to <code>VSA_LINEAR</code> , <code>VSA_SQUARE</code> , or <code>VSA_FULLY_FLEXIBLE</code> if only <code>ImplementationDataType</code> is present
[TPS_SWCT_01648]	<code>Size Indicator</code> for <code>dynamicArraySizeProfile</code> set to <code>VSA_RECTANGULAR</code> if only <code>ImplementationDataType</code> is present
[TPS_SWCT_01649]	Payload for <code>dynamicArraySizeProfile</code> if only <code>ImplementationDataType</code> is present
[TPS_SWCT_01650]	Structure of the <code>VSA ImplementationDataType</code>
[TPS_SWCT_01651]	UTF-16BE
[TPS_SWCT_01652]	UTF-16LE
[TPS_SWCT_01653]	UTF-16-encoded strings are not allowed to start with a BOM
[TPS_SWCT_01654]	<code>AtomicSwComponentType</code> offers <code>PortPrototypes</code> typed by <code>SenderReceiverInterfaces</code> to adjust the IO signal via diagnostic services
[TPS_SWCT_01655]	Reference from <code>DiagnosticIoControlNeeds</code> to <code>DiagnosticValueNeeds</code>
[TPS_SWCT_01656]	Suffix used for the resulting name of the <code>PortInterface</code> for <code>IOControlRequest</code> and <code>IOControlResponse</code>
[TPS_SWCT_01657]	NamingRule for <code>RPortPrototype</code> referenced by a <code>RoleBasedPortAssignment</code> with attribute <code>role</code> set to “IOControlRequest”
[TPS_SWCT_01658]	NamingRule for <code>PPortPrototype</code> referenced by a <code>RoleBasedPortAssignment</code> with attribute <code>role</code> set to “IOControlResponse”





Number	Heading
[TPS_SWCT_01659]	Mapping of <code>VariableDataPrototype</code> to a <code>NvBlockDescriptor</code>

Table C.33: Added Traceables in 4.2.2

C.8.2 Changed Traceables in R4.2.2

Number	Heading
[TPS_SWCT_01133]	<code>AtomicSwComponentType</code> provides information about aging cycles
[TPS_SWCT_01158]	Three cases for <code>PortInterfaceMapping</code>
[TPS_SWCT_01179]	Compound Primitive Data Type
[TPS_SWCT_01244]	Data types for calibration parameters are also described as primitive types
[TPS_SWCT_01370]	<code>VariationPointProxy</code>
[TPS_SWCT_01431]	Finding the symbol for the representation of a <code>CompuScale</code> with a point-range in C code
[TPS_SWCT_01432]	Keep the <code>invalidValue</code> transparent to the sending and receiving software components
[TPS_SWCT_01434]	Sender and receiver have knowledge of invalid value
[TPS_SWCT_01610]	Modeling of a <code>Variable-Size Array Data Type</code> with <code>Size Indicator</code> enabled
[TPS_SWCT_01616]	Semantics of <code>TransformerHardErrorEvent</code>
[TPS_SWCT_01617]	Structure of an <code>ImplementationDataType</code> that represents a variable-sized array data type
[TPS_SWCT_01624]	Hard error occurs during the execution of a transformer chain
[TPS_SWCT_02001]	Values of <code>SwAxisCont</code> with the <code>category</code> , <code>COM_AXIS</code> , <code>RES_AXIS</code> are for display only
[TPS_SWCT_02053]	Values of <code>RuleBasedAxisCont</code> with the <code>category</code> <code>COM_AXIS</code> , <code>RES_AXIS</code> are for display only

Table C.34: Changed Traceables in R4.2.2

C.8.3 Deleted Traceables in R4.2.2

Number	Heading
[TPS_SWCT_01308]	Combination of <code>supportsMultipleInstantiation=false</code> and <code>canBeInvokedConcurrently=false</code>
[TPS_SWCT_01433]	Invalid values outside the range limits
[TPS_SWCT_01435]	Invalid values outside the range limits
[TPS_SWCT_01603]	Variable size array with <code>Size Indicator</code>
[TPS_SWCT_01611]	Enable <code>Size Indicator</code>

Table C.35: Deleted Traceables in R4.2.2

C.8.4 Added Constraints in R4.2.2

Number	Heading
[constr_1381]	Appearance of core-related possible values of <code>MemorySection.option</code> or <code>SwAddrMethod.option</code> according to [TPS_SWCT_01456]
[constr_1382]	Mutually exclusive existence of attributes <code>SwVariableRefProxy.autosarVariable</code> vs. <code>SwVariableRefProxy.mcDataInstanceVar</code>
[constr_1383]	Existence of <code>CompuMethod</code> and <code>DataConstr</code> for <code>ImplementationDataTypes</code> of category <code>TYPE_REFERENCE</code>
[constr_1384]	Definition of <code>invalidValue</code> for <code>DataPrototype</code> typed by <code>ApplicationPrimitiveDataType</code> of category <code>CURVE</code> , <code>MAP</code> , <code>CUBOID</code> , <code>CUBE_4</code> , <code>CUBE_5</code> , <code>COM_AXIS</code> , <code>RES_AXIS</code> , and <code>VAL_BLK</code>
[constr_1385]	<code>DataPrototype</code> is typed by an <code>ImplementationDataType</code>
[constr_1386]	<code>PortDefinedArgumentValue</code> shall only be defined for <code>AbstractProvidedPortPrototype</code>
[constr_1388]	<code>VariationPointProxy</code> of category <code>VALUE</code> shall not mix “pre-build” and “post-build” use-cases
[constr_1389]	Restriction regarding the value of <code>category</code> of <code>VariationPointProxy.implementationDataType</code>
[constr_1390]	Restriction to the value of <code>SenderReceiverInterface.invalidationPolicy.handleInvalid</code>
[constr_1391]	Compatibility of <code>Units</code> in the context of assignment using an <code>ApplicationValueSpecification</code>
[constr_1392]	Compatibility of <code>Units</code> in the context of assignment using an <code>ApplicationRuleBasedValueSpecification</code>
[constr_1393]	Existence of <code>RuleBasedValueCont.unit</code>
[constr_1395]	<code>NvBlockDataMapping</code> shall be complete
[constr_1396]	Restriction for the value of attribute <code>category</code> for non-terminating <code>ImplementationDataTypeElements</code> taken to model a <code>Variable-Size Array Data Type</code>
[constr_1397]	Existence of attributes of <code>TransformerHardErrorEvent</code>
[constr_1398]	Existence of attributes of <code>BaseTypeDirectDefinition</code>
[constr_1399]	Standardized values of <code>ModeDeclarationGroup.category</code>
[constr_1400]	Reference to a specific <code>DataTransformation</code>
[constr_1401]	Restrictions on the relation between <code>DataPrototypeMapping</code> and <code>DataTransformation</code>
[constr_1402]	Applicability of core-related possible values of <code>MemorySection.option</code> or <code>SwAddrMethod.option</code> related to <code>SwAddrMethod.sectionInitializationPolicy</code>
[constr_1403]	<code>NvBlockDataMappings</code> to a given <code>nvData</code> shall be unambiguous
[constr_1404]	All <code>NvDataInterface.nvData</code> of <code>PortPrototypes</code> in the context of a specific <code>SwcServiceDependency</code> shall be mapped to the same <code>NvBlockDescriptor</code>

Table C.36: Added Constraints in R4.2.2

C.8.5 Changed Constraints in R4.2.2

Number	Heading
[constr_1006]	applicable data categories
[constr_1007]	Allowed attributes of <code>SwDataDefProps</code> for <code>ApplicationDataTypes</code>
[constr_1040]	Conversion of <code>SenderReceiverInterfaces</code>
[constr_1045]	Supported value encodings for <code>SwBaseType</code> in the context of <code>PortInterfaces</code>
[constr_1060]	Compatibility of data types with <code>category ARRAY, VAL_BLK</code>
[constr_1064]	Compatibility of data types with <code>category COM_AXIS, RES_AXIS, CURVE, MAP, CUBOID, CUBE_4, or CUBE_5</code>
[constr_1066]	Forbidden mappings to <code>ImplementationDataType</code>
[constr_1075]	Compatibility of <code>ModeDeclarationGroups</code>
[constr_1164]	Number of <code>arguments</code> owned by a <code>RunnableEntity</code>
[constr_1234]	Value of <code>RunnableEntity.symbol</code>
[constr_1318]	Profile <code>VSA_LINEAR</code> for <code>ImplementationDataType</code>
[constr_1319]	Profile <code>VSA_SQUARE</code> for <code>ImplementationDataType</code>
[constr_1320]	Profile <code>VSA_RECTANGULAR</code> for <code>ImplementationDataType</code>
[constr_1321]	Profile <code>VSA_FULLY_FLEXIBLE</code> for <code>ImplementationDataType</code>
[constr_1322]	<code>Size Indicator</code> for undefined <code>dynamicArraySizeProfile</code>
[constr_2051]	Mandatory information of a <code>SwValueCont</code>
[constr_2058]	Mandatory information of a <code>RuleBasedValueCont</code>

Table C.37: Changed Constraints in R4.2.2

C.8.6 Deleted Constraints in R4.2.2

Number	Heading
[constr_1002]	End-to-end protection does not support n:1 communication
[constr_1067]	<code>ApplicationDataType</code> is or is not compatible to specific <code>Implementation-DataType</code>
[constr_2001]	Initial value for a specific <code>implicitInterRunnableVariable</code> or <code>explicitInterRunnableVariable</code>

Table C.38: Deleted Constraints in R4.2.2

C.9 Constraint History of this Document according to AUTOSAR R4.3.0

C.9.1 Added Traceables in R4.3.0

Number	Heading
[TPS_SWCT_01660]	Values of <code>SwcServiceDependency.category</code> reserved by the standard
[TPS_SWCT_01661]	Default value of <code>SwcServiceDependency.category</code>
[TPS_SWCT_01662]	Applicability of <code>DataTypeMappingSets</code> inside an <code>NvBlockSwComponentType</code>
[TPS_SWCT_01663]	<code>dataReadAccess</code> vs. <code>dataReceivePointByValue</code> or <code>dataReceivePointByArgument</code>
[TPS_SWCT_01664]	BswM acts as a mode requester towards an application mode manager
[TPS_SWCT_01665]	Usage of <code>SwcModeSwitchEvent</code> for triggering a write procedure of <code>nv data</code>
[TPS_SWCT_01666]	Semantics of <code>ModeSwitchEventTriggeredActivity.role</code>
[TPS_SWCT_01667]	Avoidance of overlapping of directly adjacent intervals within <code>CompuMethods</code>
[TPS_SWCT_01668]	<code>SecOc</code> Use Case: obtain the verification status of secure communication
[TPS_SWCT_01672]	<code>SecOc</code> Use Case: software component retires from secure communication for a given period
[TPS_SWCT_01673]	Application Software Component sends requests using the J1939Rm
[TPS_SWCT_01674]	Application Software Component accepts requests using the J1939Rm
[TPS_SWCT_01675]	Recommendations for attributes of <code>NvBlockNeeds</code> or for <code>NvBlockDescriptor</code>
[TPS_SWCT_01676]	Preferred approach to checking the compatibility of input value and axis
[TPS_SWCT_01677]	Fall-back approach to checking the compatibility of input value and axis
[TPS_SWCT_01678]	StbM use Case: Application software component accesses the Synchronized Time-Base Manager
[TPS_SWCT_01679]	StbM use Case: Synchronized Time-Base Manager notifies application software component
[TPS_SWCT_01680]	Dem Use Case: Atomic Software-Component implements a Hardware Shutdown
[TPS_SWCT_01681]	Context path in <code>ArVariableInImplementationDataInstanceRef</code>
[TPS_SWCT_01682]	The meaning of E2E-related attributes in a <code>ReceiverComSpec</code> if a <code>TransformationComSpecProps</code> of type <code>EndToEndTransformationComSpecProps</code> is defined.
[TPS_SWCT_01683]	Specification of an array of input variable for an array of axes
[TPS_SWCT_01684]	Specification of a single input variable for an array of axes
[TPS_SWCT_01685]	Specification of an array of group axes for an array of <code>category</code> <code>CURVE</code> , <code>MAP</code> , <code>CUBOID</code> , <code>CUBE_4</code> , or <code>CUBE_5</code>
[TPS_SWCT_01686]	Specification of a single group axis for an array of elements of <code>category</code> <code>CURVE</code> , <code>MAP</code> , <code>CUBOID</code> , <code>CUBE_4</code> , or <code>CUBE_5</code>
[TPS_SWCT_01687]	Support of locked communication buffers





Number	Heading
[TPS_SWCT_01688]	<code>initValue</code> should exist in an <code>RPortPrototype</code>
[TPS_SWCT_01689]	Relation between <code>SwcServiceDependency</code> s and <code>PortPrototypes</code>
[TPS_SWCT_01690]	<code>AtomicSwComponentType</code> offers a <code>PPortPrototype</code> typed by <code>ClientServerInterface</code> to read/write and <code>IOCtrl</code> current value via diagnostic services
[TPS_SWCT_01691]	Suffix used for the resulting name of the <code>PortInterface</code> for the Data Services
[TPS_SWCT_01692]	Meaning of <code>CompositeRuleBasedValueSpecification</code>
[TPS_SWCT_01693]	Usage of <code>VendorSpecificServiceNeeds</code>
[TPS_SWCT_01694]	Setup for Default Error Tracer Service use Case: development errors or runtime error
[TPS_SWCT_01695]	Relation between <code>ValueSpecification</code> and the definition of <code>CompuScales</code>
[TPS_SWCT_01696]	<code>CompuScale</code> Value Symbolic Name
[TPS_SWCT_01697]	Supported development approach for software-components that interact with AUTOSAR services
[TPS_SWCT_01698]	Attributes that are subject to development approach
[TPS_SWCT_01699]	Usage of <code>ApplicationArrayElement.indexDataType</code>
[TPS_SWCT_01700]	Definition of unions that can be transmitted over a communication network
[TPS_SWCT_01701]	Wrapped Union Data Type
[TPS_SWCT_01702]	Initialization of the “payload” of a <code>Wrapped Union Data Type</code>
[TPS_SWCT_01703]	Setup for <code>AtomicSwComponentType</code> which sets or gets the Global Supervision Status
[TPS_SWCT_01704]	Definition of supervised entity
[TPS_SWCT_01705]	Definition of Checkpoints
[TPS_SWCT_01706]	<code>AtomicSwComponentType</code> supports <code>DiagnosticSessionControl</code> to get informed about the diagnostic session
[TPS_SWCT_01707]	<code>AtomicSwComponentType</code> supports <code>EcuReset</code> service via diagnostic services
[TPS_SWCT_01708]	<code>AtomicSwComponentType</code> supports <code>EcuReset ModeRapidPowerShutDown</code> service via diagnostic services
[TPS_SWCT_01709]	<code>AtomicSwComponentType</code> supports <code>CommunicationControl</code> service via diagnostic services
[TPS_SWCT_01710]	Suffix used for the resulting name of the <code>PortInterface</code> for the Communication Control
[TPS_SWCT_01711]	<code>AtomicSwComponentType</code> supports <code>ControlDTCSetting</code> service via diagnostic services
[TPS_SWCT_01712]	<code>AtomicSwComponentType</code> supports <code>SecurityAccess</code> to get informed about the security level
[TPS_SWCT_01713]	<code>ExclusiveArea</code> is entered and exited by a common set of APIs
[TPS_SWCT_01714]	<code>ExclusiveArea</code> is entered and exited by an individual set of APIs
[TPS_SWCT_01715]	Software-Component wants to be triggered on Monitor Status Changes





Number	Heading
[TPS_SWCT_01716]	<i>SecOc</i> Use Case: deliver freshness to SecOC I
[TPS_SWCT_01717]	<i>SecOc</i> Use Case: deliver freshness to SecOC II
[TPS_SWCT_01718]	<i>SecOc</i> Use Case: deliver freshness to SecOC III
[TPS_SWCT_01719]	Selection of applicable <i>RptProfiles</i>
[TPS_SWCT_01720]	Preparation Levels
[TPS_SWCT_01721]	References from <i>RptContainer</i>
[TPS_SWCT_01722]	Semantics of <i>RP Service Point</i>
[TPS_SWCT_01723]	Semantics of <i>RP Service Function</i>
[TPS_SWCT_01724]	Semantics of <i>RapidPrototypingScenario</i>
[TPS_SWCT_01725]	<i>AtomicSwComponentType</i> uses the secure counter of the Crypto Service
[TPS_SWCT_01726]	<i>AtomicSwComponentType</i> uses the key management of the Crypto Service
[TPS_SWCT_01727]	Suffix used for the resulting name of the <i>PortInterface</i> for crypto <i>PortInterfaces</i>
[TPS_SWCT_01728]	V2xFac Use Case: Application software component provides Vehicle specific data to the V2X-Stack for CAM transmission
[TPS_SWCT_01729]	V2xFac Use Case: V2xFac notifies application software component about received messages
[TPS_SWCT_01730]	V2xFac Use Case: Application software component triggers transmission of DENM message
[TPS_SWCT_01731]	V2xM Use Case: Application software component provides Vehicle specific data to the V2X-Stack for Position and Time information
[TPS_SWCT_01732]	V2xM Use Case: Application software component needs V2X specific data from the V2X Manager
[TPS_SWCT_01733]	V2xM Use Case: Application software component has soft-control over Pseudonym-Change within V2X Manager
[TPS_SWCT_01734]	V2xM Use Case: Application software component has the ability to do Verification-on-Demand
[TPS_SWCT_01735]	V2xM Use Case: Application software component do location based calculations

Table C.39: Added Traceables in 4.3.0

C.9.2 Changed Traceables in R4.3.0

Number	Heading
[TPS_SWCT_01005]	Usage of <i>SwcServiceDependency</i> s for vendor-specific services
[TPS_SWCT_01054]	Semantics of the <i>explicitInterRunnableVariable</i>
[TPS_SWCT_01134]	<i>AtomicSwComponentType</i> enables reporting of DTCs in general
[TPS_SWCT_01158]	Cases for <i>PortInterfaceMapping</i>
[TPS_SWCT_01173]	Control port shall not become a part of the <i>PortGroup</i>





Number	Heading
[TPS_SWCT_01174]	Status port shall not become a member of the <code>PortGroup</code>
[TPS_SWCT_01182]	Conceptual levels for the definition of initial values
[TPS_SWCT_01275]	values of the attribute <code>swImplPolicy</code> are restricted depending on the context
[TPS_SWCT_01331]	<code>dataWriteAccess</code> vs. <code>dataSendPoint</code>
[TPS_SWCT_01355]	<code>enableTakeAddress = true</code>
[TPS_SWCT_01463]	<code>ModeDeclarationGroupPrototypeMapping.modeDeclarationMappingSet</code> defines the applicable set of <code>ModeDeclarationMappings</code>
[TPS_SWCT_01493]	The number of <code>RuleBasedValueSpecification.arguments</code> shall not exceed the array size
[TPS_SWCT_01494]	A <code>RuleBasedValueSpecification</code> of rule <code>FILL_UNTIL_END</code> shall fill the value of the last <code>RuleBasedValueSpecification.arguments</code> until the last element of the array
[TPS_SWCT_01552]	Software-component acts as a mode manager
[TPS_SWCT_01553]	Software-component acts as a mode user
[TPS_SWCT_01554]	Software-component acts as a mode requester
[TPS_SWCT_01569]	Definition of <code>CompuScale Code Symbolic Name</code>
[TPS_SWCT_01586]	Writing strategies for <code>nv data</code>
[TPS_SWCT_01609]	A <code>RuleBasedValueSpecification</code> of rule <code>FILL_UNTIL_MAX_SIZE</code> shall fill the value of the last <code>RuleBasedValueSpecification.arguments</code> until the number of elements specified in <code>maxSizeToFill</code>
[TPS_SWCT_01635]	Naming conventions may support the effectiveness of <code>SymbolProps</code>
[TPS_SWCT_02001]	Values of <code>SwAxisCont</code> with the <code>category COM_AXIS, RES_AXIS</code> are for display only
[TPS_SWCT_02014]	<code>AtomicSwComponentType</code> supports Response On Event (ROE) via diagnostic services
[TPS_SWCT_02020]	<code>AtomicSwComponentType</code> uses the hash calculation of the Crypto Service
[TPS_SWCT_02021]	<code>AtomicSwComponentType</code> uses the message authentication code (MAC) calculation of the Crypto Service
[TPS_SWCT_02022]	<code>AtomicSwComponentType</code> uses the message authentication code (MAC) verification of the Crypto Service
[TPS_SWCT_02024]	<code>AtomicSwComponentType</code> uses the generation of random numbers of the Crypto Service
[TPS_SWCT_02025]	<code>AtomicSwComponentType</code> uses the Authenticated Encryption with Associated Data (AEAD) of the Crypto Service
[TPS_SWCT_02026]	<code>AtomicSwComponentType</code> uses the Authenticated Encryption with Associated Data (AEAD) of the Crypto Service
[TPS_SWCT_02027]	<code>AtomicSwComponentType</code> uses the encryption of the Crypto Service
[TPS_SWCT_02028]	<code>AtomicSwComponentType</code> uses the decryption of the Crypto Service
[TPS_SWCT_02031]	<code>AtomicSwComponentType</code> uses the signature generation of the Crypto Service





Number	Heading
[TPS_SWCT_02032]	<code>AtomicSwComponentType</code> uses the signature verification of the Crypto Service
[TPS_SWCT_02053]	Values of <code>RuleBasedAxisCont</code> with the <code>category</code> <code>COM_AXIS</code> , <code>RES_AXIS</code> are for display only
[TPS_SWCT_02503]	Setup for NVM Use Case: Software-Components using Nv Data provided by <code>NvBlockSwComponentType</code>
[TPS_SWCT_02506]	Setup for Dlt use Case: Application software component accesses the Dlt module

Table C.40: Changed Traceables in R4.3.0

C.9.3 Deleted Traceables in R4.3.0

Number	Heading
[TPS_SWCT_01279]	Preferred conversion direction depends on the use case
[TPS_SWCT_01428]	<code>ServiceSwComponentType</code> representing the <code>Dem</code> provides a <code>PPortPrototype</code> for the <code>Dcm</code>
[TPS_SWCT_02018]	Setup for <code>AtomicSwComponentType</code> which contains a Supervised Entity
[TPS_SWCT_02023]	<code>AtomicSwComponentType</code> uses the generation of random seed of the Crypto Service
[TPS_SWCT_02029]	<code>AtomicSwComponentType</code> uses the asymmetrical encryption of the Crypto Service
[TPS_SWCT_02030]	<code>AtomicSwComponentType</code> uses the asymmetrical decryption of the Crypto Service
[TPS_SWCT_02033]	<code>AtomicSwComponentType</code> uses the checksum calculation of the Crypto Service
[TPS_SWCT_02034]	<code>AtomicSwComponentType</code> uses the key derivation of the Crypto Service
[TPS_SWCT_02035]	<code>AtomicSwComponentType</code> uses the symmetric key derivation of the Crypto Service
[TPS_SWCT_02036]	<code>AtomicSwComponentType</code> uses the key exchange interface for public value calculation of the Crypto Service
[TPS_SWCT_02037]	<code>AtomicSwComponentType</code> uses the key exchange interface for secret value calculation of the Crypto Service
[TPS_SWCT_02038]	<code>AtomicSwComponentType</code> uses the key exchange interface to calculate symmetric key with the Crypto Service
[TPS_SWCT_02039]	<code>AtomicSwComponentType</code> uses the symmetrical key extraction of the Crypto Service
[TPS_SWCT_02040]	<code>AtomicSwComponentType</code> uses the symmetrical key wrapping of the Crypto Service to export a symmetrical key structure with a symmetric key
[TPS_SWCT_02041]	<code>AtomicSwComponentType</code> uses the asymmetrical key wrapping of the Crypto Service to export a symmetrical key structure with a asymmetric key
[TPS_SWCT_02042]	<code>AtomicSwComponentType</code> uses the asymmetrical public key extraction of the Crypto Service





Number	Heading
[TPS_SWCT_02043]	AtomicSwComponentType uses the asymmetrical private key extraction of the Crypto Service
[TPS_SWCT_02044]	AtomicSwComponentType uses the asymmetrical key wrapping of the Crypto Service to export a (asymmetric) private key structure with a symmetrical wrapping key
[TPS_SWCT_02045]	AtomicSwComponentType uses the asymmetrical key wrapping of the Crypto Service to export a (asymmetric) private key structure with a asymmetrical wrapping key

Table C.41: Deleted Traceables in R4.3.0

C.9.4 Added Constraints in R4.3.0

Number	Heading
[constr_1407]	Definition of SwDataDefProps.dataConstr depending on the capabilities of the data type
[constr_1408]	Definition of SwDataDefProps.displayFormat depending on the capabilities of the data type
[constr_1409]	Definition of SwDataDefProps.dataConstr depending on the capabilities of the element data type
[constr_1410]	Definition of SwDataDefProps.displayFormat depending on the capabilities of the element data type
[constr_1413]	Definition of SwDataDefProps.stepSize depending on the capabilities of the data type
[constr_1414]	Definition of SwDataDefProps.stepSize depending on the capabilities of the element data type
[constr_1415]	Supported values of ModeSwitchEventTriggeredActivity.role
[constr_1416]	Existence of ApplicationArrayElement.maxNumberOfElements
[constr_1417]	Invalid connection between NvBlockSwComponentType and other AtomicSwComponentType (I)
[constr_1418]	Invalid connection between NvBlockSwComponentType and other AtomicSwComponentType (II)
[constr_1420]	Existence of SwAxisIndividual.inputVariableType
[constr_1422]	Value of category is VOID
[constr_1423]	Completeness of references ArVariableInImplementationDataInstanceRef.contextDataPrototype
[constr_1424]	Existence of ArVariableInImplementationDataInstanceRef.contextDataPrototype
[constr_1425]	Definition of swCalprmAxisSet.swCalprmAxis/ SwAxisIndividual.swVariableRef depending on the capabilities of the data type
[constr_1426]	Consistency of array sizes for axes and input variable array





Number	Heading
[constr_1427]	Definition of <code>swCalprmAxisSet.swCalprmAxis/ SwAxisGrouped.swCalprmRef</code> depending on the capabilities of the data type
[constr_1428]	Consistency of array sizes for arrays of elements of <code>category CURVE, MAP, CUBOID, CUBE_4, or CUBE_5</code> arrays and used group axes arrays
[constr_1429]	Access to data within <code>PortPrototypes</code> from within <code>RunnableEntities</code>
[constr_1430]	Access to local data from within <code>RunnableEntities</code>
[constr_1431]	Access to parameters from within <code>RunnableEntities</code>
[constr_1432]	Multiplicity of <code>CommunicationBufferLocking</code>
[constr_1433]	Transient faults are not applicable to software-components
[constr_1434]	<code>CompuScales</code> shall not have identical <code>CompuScale Value Symbolic Names</code>
[constr_1436]	<code>DiagnosticCommunicationManagerNeeds.serviceRequestCallbackType</code> is set to <code>requestCallbackTypeSupplier</code>
[constr_1437]	<code>DiagnosticCommunicationManagerNeeds.serviceRequestCallbackType</code> is set to <code>requestCallbackTypeManufacturer</code>
[constr_1438]	<code>ApplicationArrayElement.indexDataType</code> needs to refer to a <code>CompuMethod</code> of <code>category TEXTTABLE</code>
[constr_1439]	Requirements on <code>ApplicationArrayElement</code> if attribute <code>indexDataType</code> exists
[constr_1440]	Size of the <code>CompuMethod</code> of <code>category TEXTTABLE</code> referenced by <code>Application-ArrayElement.indexDataType</code>
[constr_1442]	<code>category TYPE_REFERENCE</code> shall not be used for modeling the “payload” of a <code>Wrapped Union Data Type</code>
[constr_1443]	<code>category UNION</code> shall not be used for <code>ImplementationDataType</code>
[constr_1444]	Limited applicability of <code>Wrapped Union Data Type</code>
[constr_1445]	Initialization of the <code>Member Selector</code> of a <code>Wrapped Union Data Type</code>
[constr_1446]	No definition of <code>invalidValue</code> for a <code>Wrapped Union Data Type</code>
[constr_1468]	Limitation on the number of <code>SwcExclusiveAreaPolicys</code>
[constr_1469]	Applicability of constraints depending on the existence of a data transformation

Table C.42: Added Constraints in R4.3.0

C.9.5 Changed Constraints in R4.3.0

Number	Heading
[constr_1006]	applicable data categories
[constr_1007]	Allowed attributes of <code>SwDataDefProps</code> for <code>ApplicationDataTypes</code>
[constr_1009]	<code>SwDataDefProps</code> applicable to <code>ImplementationDataTypes</code>
[constr_1011]	<code>category</code> of <code>SwBaseType</code>
[constr_1014]	Supported value encodings for <code>SwBaseType</code>
[constr_1015]	Prioritization of <code>SwDataDefProps</code>





Number	Heading
[constr_1024]	Stepwise definition of CompuMethods
[constr_1045]	Supported value encodings for SwBaseType in the context of PortInterfaces
[constr_1105]	Value of arraySize
[constr_1240]	Consistency of ArgumentDataPrototypes within the context of a ClientServer-OperationMapping
[constr_1271]	RecordValueSpecification.fields shall be identical to the number of ApplicationRecordDataType.elements
[constr_1272]	RecordValueSpecification.fields shall be identical to the number of subElements of ImplementationDataType of category STRUCTURE
[constr_1284]	Limitation of the use of TextValueSpecification
[constr_1288]	Allowed Attributes vs. category for DataPrototypes typed by Implementation-DataTypes
[constr_1289]	Allowed Attributes vs. category for DataPrototypes typed by Application-DataTypes
[constr_1302]	Restriction of data invalidation
[constr_1375]	Existence of attributes of CompuMethod and related meta-classes
[constr_1400]	Reference to a specific DataTransformation
[constr_2006]	Number of AsynchronousServerCallResultPoint referencing to one AsynchronousServerCallPoint
[constr_2015]	Limitation of SwcInternalBehavior of a NvBlockSwComponentType
[constr_2041]	swImplPolicy for VariableDataPrototype in the role staticMemory
[constr_2051]	Mandatory information of a SwValueCont
[constr_2058]	Mandatory information of a RuleBasedValueCont

Table C.43: Changed Constraints in R4.3.0

C.9.6 Deleted Constraints in R4.3.0

Number	Heading
[constr_1019]	Compatibility of input value and axis
[constr_1021]	A CompuMethod shall specify instructions for both directions
[constr_1133]	Identical CompuScale Symbolic Names shall have the same range
[constr_1201]	initValue shall exist in an RPortPrototype
[constr_1323]	Applicability of attribute ReceiverComSpec.usesEndToEndProtection

Table C.44: Deleted Constraints in R4.3.0

C.10 Constraint History of this Document according to AUTOSAR R4.3.1

C.10.1 Added Traceables in 4.3.1

Number	Heading
[TPS_SWCT_01736]	Default values for Unit.physicalDimension
[TPS_SWCT_01737]	Default values for physical exponents
[TPS_SWCT_01738]	Context path in ArParameterInImplementationDataInstanceRef
[TPS_SWCT_01739]	Function Inhibition Manager Use Case: react on suppressed or unavailable events
[TPS_SWCT_01740]	StbM use Case: Process time snapshot obtained from global time slave for diagnostics purposes
[TPS_SWCT_01741]	Suffix used for the resulting name of the PortInterface for measurement notification
[TPS_SWCT_01742]	StbM use Case: Software-component represents a global time master
[TPS_SWCT_01743]	Suffix used for the resulting name of the PortInterface for the global time master role
[TPS_SWCT_01744]	StbM use Case: Software-component represents a global time slave
[TPS_SWCT_01745]	Suffix used for the resulting name of the PortInterface for the global time slave role
[TPS_SWCT_01746]	Atomic Software-Component provides the further action byte to the DoIP Service Component
[TPS_SWCT_01747]	Value of category for fix axis
[TPS_SWCT_01748]	Sub-categories of fix axes
[TPS_SWCT_01749]	Semantics of SwAxisGeneric.swAxisType in the definition of a fix axis
[TPS_SWCT_01750]	Semantics of SwAxisGeneric.swGenericAxisParam in the definition of a fix axis

Table C.45: Added Traceables in 4.3.1

C.10.2 Changed Traceables in 4.3.1

Number	Heading
[TPS_SWCT_01193]	Mappings between application and implementation types do not necessarily have to form a 1:1 relation
[TPS_SWCT_01222]	Applicability of DataFilter
[TPS_SWCT_01225]	RunnableEntity implements the functionality of more than one ClientServerOperations
[TPS_SWCT_01288]	Interpretation of PhysConstrs and InternalConstrs by tools
[TPS_SWCT_01444]	Size of SwBaseType is specified in bits
[TPS_SWCT_01560]	Supported categorys of CompuMethods for data conversion





Number	Heading
[TPS_SWCT_01675]	Recommendations for attributes of <code>NvBlockNeeds</code> or for <code>NvBlockDescriptor</code>
[TPS_SWCT_01678]	StbM use Case: start timer and potentially get notified about its expiration
[TPS_SWCT_01679]	StbM use Case: Software-Components wants to get notifications of status changes
[TPS_SWCT_01714]	<code>ExclusiveArea</code> is entered and exited by an individual set of APIs
[TPS_SWCT_02506]	Setup for Dlt use Case: Application software component accesses the Dlt module

Table C.46: Changed Traceables in 4.3.1

C.10.3 Deleted Traceables in 4.3.1

Number	Heading
[TPS_SWCT_01490]	AUTOSAR supports <code>ApplicationErrors</code> only for <code>ClientServerInterfaces</code>

Table C.47: Deleted Traceables in 4.3.1

C.10.4 Added Constraints in 4.3.1

Number	Heading
[constr_1515]	Existence of <code>ImplementationDataTypeSubElementRef.implementationDataTypeElement</code> as opposed to <code>ImplementationDataTypeSubElementRef.parameterImplementationDataTypeElement</code>
[constr_1516]	Completeness of references <code>ArParameterInImplementationDataInstanceRef.contextDataPrototype</code>
[constr_1517]	Existence of <code>ArParameterInImplementationDataInstanceRef.contextDataPrototype</code>
[constr_1518]	Consistency of data types in the context of <code>ArParameterInImplementationDataInstanceRef</code>
[constr_1519]	Existence of attributes vs. category of <code>ApplicationValueSpecification</code>
[constr_1520]	Semantics of <code>ObdRatioServiceNeeds.rateBasedMonitoredEvent</code>
[constr_1521]	Reference from <code>AsynchronousServerCallReturnsEvent</code> to <code>AsynchronousServerCallResultPoint</code>
[constr_1523]	No mode disabling for <code>OperationInvokedEvents</code>
[constr_1538]	Restriction for <code>ReceiverComSpec.dataElement</code>
[constr_1539]	Restriction for <code>SenderComSpec.dataElement</code>
[constr_1540]	Existence of <code>ClientComSpec.operation</code>
[constr_1541]	Existence of <code>ServerComSpec.operation</code>
[constr_1544]	Modeling of <code>SwAxisGeneric</code> for the definition of a fix axis



△

Number	Heading
[constr_1545]	No initialization for fix axis

Table C.48: Added Constraints in 4.3.1

C.10.5 Changed Constraints in 4.3.1

Number	Heading
[constr_1004]	Mapping of <code>ApplicationDataTypes</code> in the scope of single <code>AtomicSwComponentTypes</code>
[constr_1007]	Allowed attributes of <code>SwDataDefProps</code> for <code>ApplicationDataTypes</code>
[constr_1009]	<code>SwDataDefProps</code> applicable to <code>ImplementationDataTypes</code>
[constr_1011]	<code>category</code> of <code>SwBaseType</code>
[constr_1012]	Value of <code>category</code> is <code>FIXED_LENGTH</code>
[constr_1015]	Prioritization of <code>SwDataDefProps</code>
[constr_1038]	Reference to <code>ApplicationError</code>
[constr_1044]	Applicability of <code>DataFilter</code>
[constr_1090]	<code>WaitPoint</code> and <code>RunnableEntity</code>
[constr_1102]	<code>ApplicationError</code> in the scope of one <code>SwComponentType</code>
[constr_1126]	Compatibility of <code>DataConstrs</code>
[constr_1220]	Compatibility of <code>SwBaseType</code>
[constr_1229]	<code>category</code> of <code>ImplementationDataType</code> boils down to <code>VALUE</code>
[constr_1288]	Allowed Attributes vs. <code>category</code> for <code>DataPrototypes</code> typed by <code>ImplementationDataTypes</code>
[constr_1289]	Allowed Attributes vs. <code>category</code> for <code>DataPrototypes</code> typed by <code>ApplicationDataTypes</code>
[constr_1422]	Value of <code>category</code> is <code>VOID</code>
[constr_2027]	<code>SwcServiceDependency</code> shall be defined for service ports only
[constr_2043]	<code>swImplPolicy</code> for <code>ParameterDataPrototype</code> in the role <code>romBlock</code>
[constr_2044]	<code>swImplPolicy</code> for <code>ParameterDataPrototype</code> in the role <code>sharedParameter</code>
[constr_2045]	<code>swImplPolicy</code> for <code>ParameterDataPrototype</code> in the role <code>perInstanceParameter</code>
[constr_2046]	<code>swImplPolicy</code> for <code>ParameterDataPrototype</code> in the role <code>constantMemory</code>

Table C.49: Changed Constraints in 4.3.1

C.10.6 Deleted Constraints in 4.3.1

Number	Heading
[constr_1013]	Value of <code>category</code> is <code>VARIABLE_LENGTH</code>
[constr_1436]	<code>DiagnosticCommunicationManagerNeeds.serviceRequestCallbackType</code> is set to <code>requestCallbackTypeSupplier</code>
[constr_1437]	<code>DiagnosticCommunicationManagerNeeds.serviceRequestCallbackType</code> is set to <code>requestCallbackTypeManufacturer</code>

Table C.50: Deleted Constraints in 4.3.1

C.11 Constraint History of this Document according to AUTOSAR R4.4.0

C.11.1 Added Traceables in 4.4.0

Number	Heading
[TPS_SWCT_01751]	The meaning of E2E-related attributes in a <code>SenderComSpec</code> if a <code>TransformationComSpecProps</code> of type <code>EndToEndTransformationComSpecProps</code> is defined
[TPS_SWCT_01752]	Initialization of a variable-size array
[TPS_SWCT_01753]	Application of compatibility rules for <code>ReceiverComSpec.replaceWith</code>
[TPS_SWCT_01754]	<code>initValue</code> defined in the context of a <code>ComSpec</code>
[TPS_SWCT_01755]	Duplicate existence of <code>initValue</code> in the context of a <code>PRPortPrototype</code> typed by an <code>NvDataInterface</code>
[TPS_SWCT_01756]	Semantics of <code>SwDataDefProps.displayPresentation</code>
[TPS_SWCT_01757]	Not-applicable scenario for <code>presentationContinuous</code>
[TPS_SWCT_01758]	Applicable value range of <code>SwDataDefProps.displayPresentation</code>
[TPS_SWCT_01759]	Use cases for unions
[TPS_SWCT_01760]	Defining the dimension of an <code>ApplicationPrimitiveDataType</code> of <code>category VAL_BLK</code>
[TPS_SWCT_01761]	Physical limits of pure textual conversions
[TPS_SWCT_01762]	Physical limits of mixed textual conversions
[TPS_SWCT_01763]	HtssM Service Use Case: Query results of hardware tests
[TPS_SWCT_01764]	V2xFac Use Case: Application software component shall be able to process the <i>MAP (topology) Extended Message</i>
[TPS_SWCT_01765]	Dem Service Use Case: In-Use-Monitoring Performance Ratio Denominator interface
[TPS_SWCT_01766]	Software-component computes the PIDs, and pushes them to Dem for storage and reporting to Dcm
[TPS_SWCT_01767]	Software-component located on an OBD master ECU reads the PID 21, and and sends the value around via “regular” sender-receiver communication





Number	Heading
[TPS_SWCT_01768]	Semantics of <code>DataPrototypeMapping.secondToFirstDataTransformation</code>
[TPS_SWCT_01769]	Dcm Use Case: Upload and download of data
[TPS_SWCT_01770]	V2xFac Use Case: Application software component processes Infrastructure to Vehicle Information Message
[TPS_SWCT_01771]	Definition of optional elements on the level of <code>ApplicationDataType</code>
[TPS_SWCT_01772]	Semantics of attribute <code>ImplementationDataType.isStructWithOptionalElement</code>
[TPS_SWCT_01773]	Definition of <code>Optional Element Structure</code> on the level of <code>ImplementationDataType</code>
[TPS_SWCT_01774]	Modeling of <code>ImplementationDataType</code> with optional elements
[TPS_SWCT_01775]	Structured data types with optional elements
[TPS_SWCT_01776]	<code>AtomicSwComponentType</code> uses the API of the Crypto Service to set a key valid
[TPS_SWCT_01777]	<code>AtomicSwComponentType</code> uses the API of the Crypto Service to create a random seed
[TPS_SWCT_01778]	<code>AtomicSwComponentType</code> uses the API of the Crypto Service to generate a key
[TPS_SWCT_01779]	<code>AtomicSwComponentType</code> uses the API of the Crypto Service to derive a key
[TPS_SWCT_01780]	<code>AtomicSwComponentType</code> uses the API of the Crypto Service to execute calculation of the public value for key exchange
[TPS_SWCT_01781]	<code>AtomicSwComponentType</code> uses the API of the Crypto Service to execute calculation of shared secret for key exchange
[TPS_SWCT_01782]	<code>AtomicSwComponentType</code> uses the API of the Crypto Service to execute certificate parsing
[TPS_SWCT_01783]	<code>AtomicSwComponentType</code> uses the API of the Crypto Service to execute certificate verification
[TPS_SWCT_01784]	<code>SecOc</code> Use Case: enable the sending of Pdus even if computation of the MAC is not possible
[TPS_SWCT_01785]	Initial value for <code>ImplementationDataType</code> of category <code>STRUCTURE</code> where attribute <code>isStructWithOptionalElement</code> set to the value <code>True</code>
[TPS_SWCT_01786]	Initial value for the <code>ImplementationDataTypeElement</code> where the <code>short-Name</code> is set to the value <code>availabilityBitfield</code>
[TPS_SWCT_01787]	Initialization of not-available <code>ImplementationDataTypeElement</code>
[TPS_SWCT_01788]	V2xFac Use Case: Application software component processes Signal Phase And Timing Extended Message
[TPS_SWCT_01789]	<code>AtomicSwComponentType</code> implements a Diagnostic Monitor that provides monitor data, debouncing by Dem
[TPS_SWCT_01790]	<code>AtomicSwComponentType</code> implements a Diagnostic Monitor that provides monitor data, debouncing by software-component





Number	Heading
[TPS_SWCT_01791]	<code>AtomicSwComponentType</code> acts as a "file server" to a diagnostic tester

Table C.51: Added Traceables in 4.4.0

C.11.2 Changed Traceables in 4.4.0

Number	Heading
[TPS_SWCT_01016]	<code>AtomicSwComponentType</code> wants to select a shutdown target
[TPS_SWCT_01017]	<code>AtomicSwComponentType</code> wants to select a boot target
[TPS_SWCT_01018]	<code>AtomicSwComponentType</code> wants to use an alarm clock
[TPS_SWCT_01028]	<code>AtomicSwComponentType</code> implements a Diagnostic Monitor
[TPS_SWCT_01029]	<code>AtomicSwComponentType</code> implements a Diagnostic Monitor
[TPS_SWCT_01132]	<code>AtomicSwComponentType</code> provides information about operating cycles
[TPS_SWCT_01136]	<code>AtomicSwComponentType</code> retrieves information of the lamp status
[TPS_SWCT_01180]	Maximum possible size of <code>Compound Primitive Data Type</code>
[TPS_SWCT_01275]	values of the attribute <code>swImplPolicy</code> are restricted depending on the context
[TPS_SWCT_01374]	Implementation of <code>AutosarParameterRef</code>
[TPS_SWCT_01375]	Implementation of <code>AutosarVariableRef</code>
[TPS_SWCT_01398]	Communication patterns for AUTOSAR services
[TPS_SWCT_01405]	Creation of the <code>ServiceSwComponentTypes</code>
[TPS_SWCT_01426]	<code>AtomicSwComponentType</code> provides callback if any diagnostic event data and/or status changed
[TPS_SWCT_01456]	Predefined values for <code>MemorySection.option</code> and <code>SwAddrMethod.option</code>
[TPS_SWCT_01678]	StbM use Case: start timer and potentially get notified about its expiration
[TPS_SWCT_01698]	Attributes that are subject to development approach
[TPS_SWCT_01706]	<code>AtomicSwComponentType</code> supports <code>DiagnosticSessionControl</code> to get informed about the diagnostic session
[TPS_SWCT_01707]	<code>AtomicSwComponentType</code> supports <code>EcuReset</code> service via diagnostic services
[TPS_SWCT_01708]	<code>AtomicSwComponentType</code> supports <code>EcuReset ModeRapidPowerShutdown</code> service via diagnostic services
[TPS_SWCT_01709]	<code>AtomicSwComponentType</code> supports <code>CommunicationControl</code> service via diagnostic services
[TPS_SWCT_01711]	<code>AtomicSwComponentType</code> supports <code>ControlDTCSetting</code> service via diagnostic services
[TPS_SWCT_01712]	<code>AtomicSwComponentType</code> supports <code>SecurityAccess</code> to get informed about the security level
[TPS_SWCT_01715]	Software-Component wants to be triggered on Monitor Status Changes





Number	Heading
[TPS_SWCT_01727]	Suffix used for the resulting name of the <code>PortInterface</code> for crypto <code>Port-Interfaces</code>
[TPS_SWCT_01728]	V2xFac Use Case: Application software component provides Vehicle specific data to the V2X-Stack for CAM transmission
[TPS_SWCT_01729]	V2xFac Use Case: V2xFac notifies application software component about received messages
[TPS_SWCT_01730]	V2xFac Use Case: Application software component triggers transmission of DENM message
[TPS_SWCT_02000]	Default value for attribute <code>swImplPolicy</code>
[TPS_SWCT_02014]	<code>AtomicSwComponentType</code> supports Response On Event (ROE) via diagnostic services
[TPS_SWCT_02020]	<code>AtomicSwComponentType</code> uses the hash calculation of the Crypto Service
[TPS_SWCT_02021]	<code>AtomicSwComponentType</code> uses the message authentication code (MAC) calculation of the Crypto Service
[TPS_SWCT_02022]	<code>AtomicSwComponentType</code> uses the message authentication code (MAC) verification of the Crypto Service
[TPS_SWCT_02024]	<code>AtomicSwComponentType</code> uses the generation of random numbers of the Crypto Service
[TPS_SWCT_02025]	<code>AtomicSwComponentType</code> uses the Authenticated Encryption with Associated Data (AEAD) of the Crypto Service
[TPS_SWCT_02026]	<code>AtomicSwComponentType</code> uses the Authenticated Encryption with Associated Data (AEAD) of the Crypto Service
[TPS_SWCT_02027]	<code>AtomicSwComponentType</code> uses the encryption of the Crypto Service
[TPS_SWCT_02028]	<code>AtomicSwComponentType</code> uses the decryption of the Crypto Service
[TPS_SWCT_02031]	<code>AtomicSwComponentType</code> uses the signature generation of the Crypto Service
[TPS_SWCT_02032]	<code>AtomicSwComponentType</code> uses the signature verification of the Crypto Service
[TPS_SWCT_02506]	Setup for Dlt use Case: Application software component accesses the Dlt module

Table C.52: Changed Traceables in 4.4.0

C.11.3 Deleted Traceables in 4.4.0

Number	Heading
[TPS_SWCT_01012]	<code>AtomicSwComponentType</code> reads the current ECU mode (fixed variant)
[TPS_SWCT_01013]	<code>AtomicSwComponentType</code> shall keep the ECU alive (fixed variant)
[TPS_SWCT_01014]	<code>AtomicSwComponentType</code> wants to select a shutdown target (fixed variant)
[TPS_SWCT_01015]	<code>AtomicSwComponentType</code> wants to select a boot target (fixed variant)
[TPS_SWCT_01125]	<code>serverArgumentImplPolicy</code>





Number	Heading
[TPS_SWCT_01133]	AtomicSwComponentType provides information about aging cycles
[TPS_SWCT_01658]	NamingRule for PPortPrototype referenced by a RoleBasedPortAssignment with attribute role set to “IOControlResponse”
[TPS_SWCT_01710]	Suffix used for the resulting name of the PortInterface for the Communication Control
[TPS_SWCT_01725]	AtomicSwComponentType uses the secure counter of the Crypto Service

Table C.53: Deleted Traceables in 4.4.0

C.11.4 Added Constraints in 4.4.0

Number	Heading
[constr_1583]	PortInterfaceMapping for DataPrototype typed by Compound Primitive Data Type
[constr_1592]	Definition of SwDataDefProps.displayPresentation depending on the capabilities of the data type
[constr_1602]	Definition of SwDataDefProps.displayPresentation depending on the capabilities of the element
[constr_1607]	Only Wrapped Union Data Types in PortInterface
[constr_1608]	Existence of rootParameterDataPrototype
[constr_1609]	Existence of rootVariableDataPrototype
[constr_1610]	Existence of SwDataDefProps.swValueBlockSize and SwDataDefProps.swValueBlockSizeMult
[constr_1611]	Existence of ImplementationDataTypeSubElementRef.implementationDataTypeElement as opposed to ImplementationDataTypeSubElementRef.parameterImplementationDataTypeElement
[constr_1622]	Value of TimingEvent.offset vs. TimingEvent.period
[constr_1631]	Applicability of DataPrototypeMapping.secondToFirstDataTransformation
[constr_1632]	Restriction for firstToSecondDataTransformation and secondToFirstDataTransformation
[constr_1634]	Allowed combinations of ApplicationDataType.category vs. CompuMethod.category
[constr_1635]	Relevance of attribute isOptional
[constr_1636]	Mapping of data types that represent an Optional Element Structure
[constr_1637]	Existence of ImplementationDataTypeElement.isOptional vs. ImplementationDataType.isStructWithOptionalElement
[constr_1638]	First ImplementationDataTypeElement of ImplementationDataType that represents an Optional Element Structure
[constr_1639]	ImplementationDataTypeElement with attribute isOptional set to True
[constr_1640]	No use of Optional Element Structure for interaction with the diagnostic stack





Number	Heading
[constr_1662]	Compatibility of <code>ApplicationRecordDataType</code> and <code>ImplementationDataType</code> that both represent an <code>Optional Element Structure</code>

Table C.54: Added Constraints in 4.4.0

C.11.5 Changed Constraints in 4.4.0

Number	Heading
[constr_1006]	applicable data categories
[constr_1007]	Allowed attributes of <code>SwDataDefProps</code> for <code>ApplicationDataTypes</code>
[constr_1009]	<code>SwDataDefProps</code> applicable to <code>ImplementationDataTypes</code>
[constr_1015]	Prioritization of <code>SwDataDefProps</code>
[constr_1024]	Stepwise definition of <code>CompuMethods</code>
[constr_1048]	Compatibility of <code>ApplicationRecordDataTypes</code>
[constr_1050]	Compatibility of <code>ImplementationDataTypes</code>
[constr_1273]	Rules for the initialization of <code>ApplicationArrayDataType</code> by means of <code>ArrayValueSpecification</code>
[constr_1274]	Rules for the initialization of array-shaped <code>ImplementationDataType</code> by means of <code>ArrayValueSpecification</code>
[constr_1288]	Allowed Attributes vs. <code>category</code> for <code>DataPrototypes</code> typed by <code>ImplementationDataTypes</code>
[constr_1289]	Allowed Attributes vs. <code>category</code> for <code>DataPrototypes</code> typed by <code>ApplicationDataTypes</code>
[constr_1400]	Reference to a specific <code>DataTransformation</code>
[constr_1444]	Limited applicability of <code>Wrapped Union Data Type</code>
[constr_1519]	Existence of attributes vs. <code>category</code> of <code>ApplicationValueSpecification</code>
[constr_2000]	Compatibility of <code>ClientServerOperations</code> triggering the same <code>RunnableEntity</code>

Table C.55: Changed Constraints in 4.4.0

C.11.6 Deleted Constraints in 4.4.0

Number	Heading
[constr_1032]	<code>DelegationSwConnector</code> can only connect <code>PortPrototypes</code> of the same kind
[constr_1297]	Applicability of <code>serverArgumentImplPolicy</code> set to <code>useArrayBaseType</code>
[constr_1443]	<code>category UNION</code> shall not be used for <code>ImplementationDataType</code>



△

Number	Heading
[constr_1515]	Existence of <code>ImplementationDataTypeSubElementRef.implementation-DataTypeElement</code> as opposed to <code>ImplementationDataTypeSubElementRef.parameterImplementationDataTypeElement</code>

Table C.56: Deleted Constraints in 4.4.0

C.12 Constraint History of this Document according to AUTOSAR R19-11

C.12.1 Added Traceables in 19-11

Number	Heading
[TPS_SWCT_01792]	Initialization of a <code>DataPrototype</code> associated with a <code>CompuMethod</code> of category <code>BITFIELD_TEXTTABLE</code>
[TPS_SWCT_01793]	Initialization of a <i>variable-size array</i> typed by an <code>ImplementationDataType</code>
[TPS_SWCT_01794]	Initialization of a <i>variable-size array</i> typed by an <code>ApplicationArrayDataType</code>
[TPS_SWCT_01795]	Further specification to facilitate the association of writing strategies to the corresponding <code>RunnableEntity</code>
[TPS_SWCT_01796]	Prioritization of <code>SwDataDefProps.dataConstr</code> for a <code>DataPrototype</code> of category <code>ARRAY</code>
[TPS_SWCT_01797]	Prioritization of <code>SwDataDefProps.displayFormat</code> for a <code>DataPrototype</code> of category <code>ARRAY</code>
[TPS_SWCT_01798]	Prioritization of <code>SwDataDefProps.stepSize</code> for a <code>DataPrototype</code> of category <code>ARRAY</code>
[TPS_SWCT_01799]	Mapping of bitfields between <code>NvBlockDescriptor</code> and <code>PortPrototype</code>
[TPS_SWCT_01801]	Support for Meta-Data
[TPS_SWCT_01802]	Definition of meta-data in the context of a <code>SenderReceiverInterface</code>
[TPS_SWCT_01803]	<code>MetaDataItems</code> define the same value of attribute <code>length</code>
[TPS_SWCT_01804]	Standardized values of attribute <code>MetaDataItem.metaDataType.value</code>
[TPS_SWCT_01805]	Semantics of the aggregation <code>NvBlockSwComponentType.bulkNvDataDescriptor</code>
[TPS_SWCT_01806]	Simultaneous aggregation of <code>NvBlockSwComponentType.bulkNvDataDescriptor</code> and <code>NvBlockSwComponentType.nvBlockDescriptor</code>
[TPS_SWCT_01807]	Application of <code>NvBlockDataMapping</code> on <code>BulkNvDataDescriptor</code>
[TPS_SWCT_03500]	Status forwarding to data transformer
[TPS_SWCT_03501]	Applicability of status forwarding to data transformer

Table C.57: Added Traceables in 19-11

C.12.2 Changed Traceables in 19-11

Number	Heading
[TPS_SWCT_01029]	<code>AtomicSwComponentType</code> implements a Diagnostic Monitor
[TPS_SWCT_01030]	<code>RunnableEntity</code>
[TPS_SWCT_01132]	<code>AtomicSwComponentType</code> provides information about operating cycles
[TPS_SWCT_01148]	<code>NvBlockDataMapping</code>
[TPS_SWCT_01182]	Conceptual levels for the definition of initial values
[TPS_SWCT_01220]	<code>initValue</code> defines an initial value that shall be taken if the corresponding <code>dataElement</code> has not yet been received
[TPS_SWCT_01243]	Definition of enumeration types
[TPS_SWCT_01309]	signature of a <code>RunnableEntity</code> depends on the connected <code>RTEEvent</code>
[TPS_SWCT_01310]	Categories of <code>RunnableEntity</code> s
[TPS_SWCT_01654]	<code>AtomicSwComponentType</code> offers <code>PortPrototypes</code> typed by <code>Sender-ReceiverInterfaces</code> to adjust the IO signal via diagnostic services
[TPS_SWCT_01656]	Suffix used for the resulting name of the <code>PortInterface</code> for <code>DataServices</code> , <code>IOControlRequest</code> , and <code>IOControlResponse</code>
[TPS_SWCT_01789]	<code>AtomicSwComponentType</code> implements a Diagnostic Monitor that provides monitor data, debouncing by Dem
[TPS_SWCT_01790]	<code>AtomicSwComponentType</code> implements a Diagnostic Monitor that provides monitor data, debouncing by software-component

Table C.58: Changed Traceables in 19-11

C.12.3 Deleted Traceables in 19-11

Number	Heading
[TPS_SWCT_01344]	Consistency of values of <code>timeout</code>
[TPS_SWCT_01429]	[<code>constr_1135</code>] only applies for <code>BITFIELD_TEXTTABLE</code>
[TPS_SWCT_01752]	Initialization of a variable-size array

Table C.59: Deleted Traceables in 19-11

C.12.4 Added Constraints in 19-11

Number	Heading
[<code>constr_1679</code>]	Existence of attribute <code>RoleBasedDataAssignment.usedDataElement.localVariable</code> for <code>RoleBasedDataAssignment.role = signalBasedDiagnostics</code>
[<code>constr_1680</code>]	Existence of attribute <code>RoleBasedDataAssignment.usedDataElement.localVariable</code> for <code>RoleBasedDataAssignment.role = AppModeRequestInterface</code>



△

Number	Heading
[constr_1681]	Existence of attribute <code>RoleBasedDataAssignment.usedDataElement.localVariable</code> for <code>RoleBasedDataAssignment.role = VerificationStatus</code>
[constr_1682]	Existence of attribute <code>RoleBasedDataAssignment.usedDataElement.localVariable</code> for <code>RoleBasedDataAssignment.role = V2xFacVdp</code>
[constr_1683]	Existence of attribute <code>RoleBasedDataAssignment.usedDataElement.localVariable</code> for <code>RoleBasedDataAssignment.role = V2xApplRxIndicationCam</code>
[constr_1684]	Existence of attribute <code>RoleBasedDataAssignment.usedDataElement.localVariable</code> for <code>RoleBasedDataAssignment.role = V2xApplRxIndicationMapem</code>
[constr_1685]	Existence of attribute <code>RoleBasedDataAssignment.usedDataElement.localVariable</code> for <code>RoleBasedDataAssignment.role = V2xApplRxIndicationIvim</code>
[constr_1686]	Existence of attribute <code>RoleBasedDataAssignment.usedDataElement.localVariable</code> for <code>RoleBasedDataAssignment.role = V2xApplRxIndicationSpatem</code>
[constr_1694]	Allowed target of <code>SwDataDefProps.implementationDataType</code>
[constr_1706]	Definition of initial value for data transmission
[constr_1712]	Existence of attribute <code>ArrayValueSpecification.intendedPartialInitializationCount</code>
[constr_1713]	<code>NvBlockDescriptor.writingStrategyRole.usedDataElement</code> shall refer to <code>AutosarDataPrototype</code>
[constr_1714]	<code>AutosarDataPrototype</code> shall only be referenced by a single <code>NvBlockDescriptor.writingStrategyRole</code>
[constr_1715]	Possible values of attribute <code>NvBlockDescriptor.writingStrategyRole.role</code>
[constr_1716]	Consistency of attribute <code>NvBlockDescriptor.writingStrategyRole.role</code> set to <code>storeAtShutdown</code>
[constr_1717]	Consistency of attribute <code>NvBlockDescriptor.writingStrategyRole.role</code> set to <code>storeImmediate</code>
[constr_1718]	Inheritance of <code>SwDataDefProps.dataConstr</code> from an array data type to the array elements
[constr_1719]	Inheritance of <code>SwDataDefProps.displayFormat</code> from an array data type to the array elements
[constr_1720]	Inheritance of <code>SwDataDefProps.stepSize</code> from an array data type to the array elements
[constr_1724]	Usage of attribute <code>ClientServerOperation.diagArgIntegrity</code>
[constr_1726]	Ordering of <code>MetaDataItemSet.metaDataItem</code>
[constr_1735]	Limitation of the aggregation of <code>AutosarVariableRef</code> in the context of an <code>NvBlockDataMapping</code> owned by a <code>BulkNvDataDescriptor</code>
[constr_1741]	Restriction to explicit sending semantics for the usage of <code>DataServices</code> in the context of a <code>SwcServiceDependency</code> that aggregates <code>DiagnosticValueNeeds</code> that in turn is referenced by a <code>DiagnosticIoControlNeeds</code>

Table C.60: Added Constraints in 19-11

C.12.5 Changed Constraints in 19-11

Number	Heading
[constr_1051]	Compatibility of <code>SwDataDefProps</code>
[constr_1059]	Compatibility of data types with <code>category VALUE</code>
[constr_1060]	Compatibility of data types with <code>category ARRAY, VAL_BLK</code>
[constr_1061]	Compatibility of data types with <code>category STRUCTURE</code>
[constr_1063]	Compatibility of data types with <code>category BOOLEAN</code>
[constr_1064]	Compatibility of data types with <code>category COM_AXIS, RES_AXIS, CURVE, MAP, CUBOID, CUBE_4, or CUBE_5</code>
[constr_1078]	Compatibility of <code>ClientServerOperations</code>
[constr_1137]	Applicability of <code>ParameterInterface</code>
[constr_1273]	Rules for the initialization of <code>ApplicationArrayDataType</code> by means of <code>ArrayValueSpecification</code>
[constr_1274]	Rules for the initialization of array-shaped <code>ImplementationDataType</code> by means of <code>ArrayValueSpecification</code>
[constr_1607]	Only <code>Wrapped Union Data Types</code> in <code>PortInterface</code>
[constr_1662]	Compatibility of <code>ApplicationRecordDataType</code> and <code>ImplementationDataType</code> that both represent an <code>Optional Element Structure</code>
[constr_2000]	Compatibility of <code>ClientServerOperations</code> triggering the same <code>RunnableEntity</code>
[constr_2013]	Compatibility of <code>ImplementationDataTypes</code> for <code>NvBlockDataMapping</code>

Table C.61: Changed Constraints in 19-11

C.12.6 Deleted Constraints in 19-11

none

D Modeling of InstanceRef

D.1 Introduction

The existence of so-called `InstanceRefs` is a direct consequence of the usage of the `type-prototype` pattern for modeling within AUTOSAR. When referencing a `prototype`, it is also necessary to include a reference to the `prototypes` typed by their corresponding `types` that in turn aggregate further `prototypes` to set up the context.

In other words, `InstanceRefs` are representing **structured references** that, on the one hand, consist of references to context `prototypes` (indicated by a subsetting or redefinition of `atpContextElement`) and finally a reference to the applicable target `prototype` (indicated by a redefinition of `atpTarget`).

Note that it is not uncommon to have more than a single context in the modeling of particular `InstanceRefs`.

For the reader of specifications, the modeling of `InstanceRefs` manifests as a UML dependency stereotyped `<<instanceRef>>` drawn from one meta-class to another. This is a simplified indication that the source of the dependency implements an `InstanceRef` to the meta-class at the target of the dependency. Again, in most cases this is everything a reader needs to understand in order to figure out the modeling. The formal modeling of `InstanceRefs` is done by creating subclasses of the abstract meta-class `AtpInstanceRef`.

Wherever a more detailed understanding of the modeling is advised in the context of the specific chapter of this document, the modeling of a specific subclass of `AtpInstanceRef` is explained directly in the context of the corresponding chapter. In all other cases, a deeper understanding of the modeling of particular subclasses of `AtpInstanceRefs` can be obtained from reading this chapter.

Class tables included in this chapter are not fully filled out in the sense that most of the notes inside the class tables are missing. The **primary** purpose of these class tables is to **provide information about the intended order in which `InstanceRefs` are serialized in M1 AUTOSAR models**.

In particular, the information about the order in serialized M1 models can be obtained from the value of the tag `xml.sequenceOffset` of each attribute of an `InstanceRef` meta-class.

For more information about the general concept of modeling `AtpInstanceRef` (e.g. the conceptual background of redefining or subsetting an association from a subclass of `AtpInstanceRef` to other meta-classes) please refer to [11].

D.2 Modeling

D.2.1 Components and Compositions

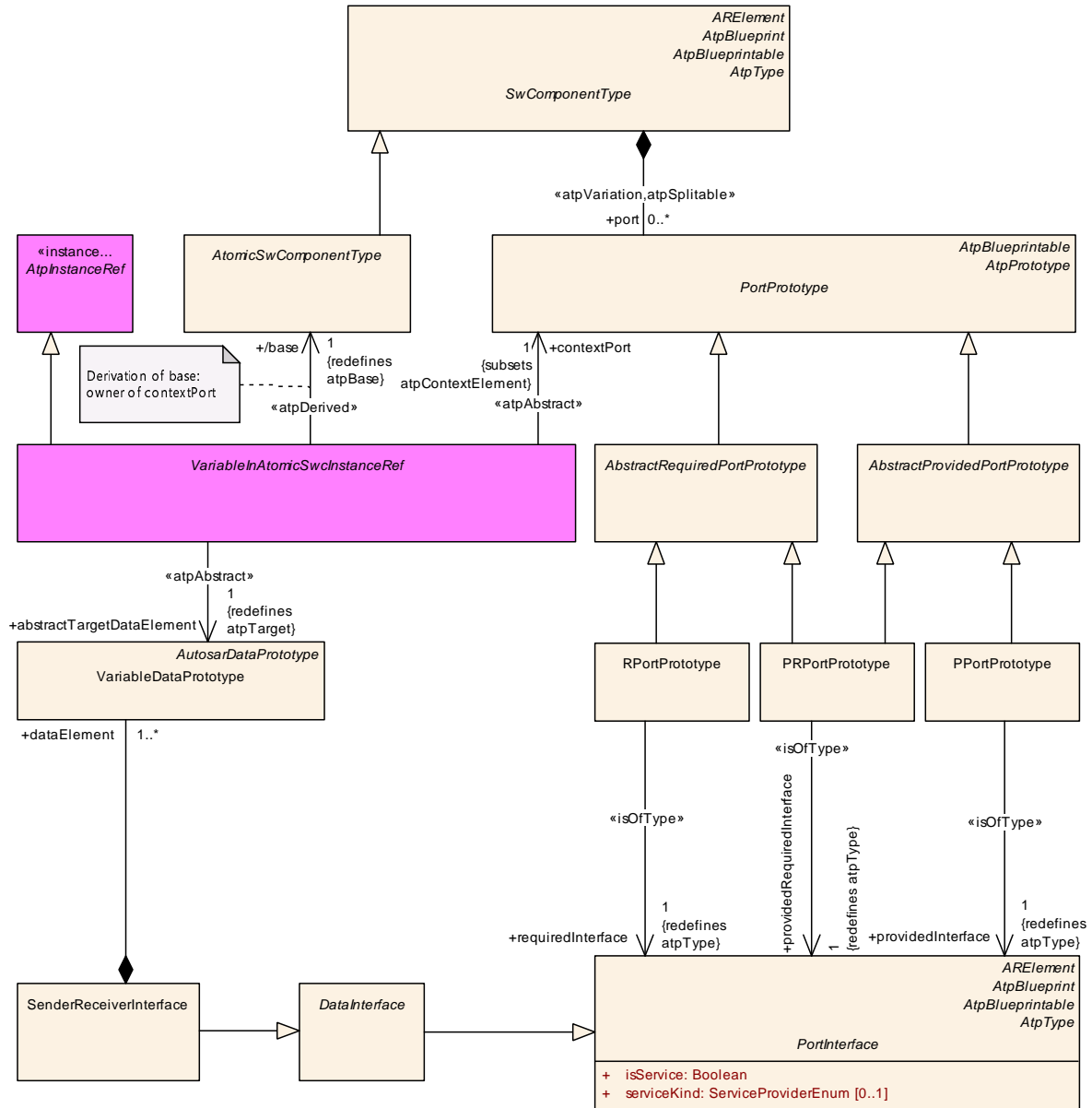

Figure D.1: Abstract modeling of references to `VariableDataPrototype` in the context of a `AtomicSwComponentType`

Class	<i>VariableInAtomicSwcInstanceRef</i> (abstract)			
Package	M2::AUTOSARTemplates::SWComponentTemplate::Components::InstanceRefs			
Note				
Base	<i>ARObject</i> , <i>AtpInstanceRef</i>			
Subclasses	<i>RVariableInAtomicSwcInstanceRef</i>			
Attribute	Type	Mult.	Kind	Note
abstractTarget DataElement	VariableDataPrototype	1	ref	Stereotypes: atpAbstract Tags: xml.sequenceOffset=30
base	AtomicSwComponent Type	1	ref	Stereotypes: atpDerived Tags: xml.sequenceOffset=10
contextPort	PortPrototype	1	ref	Stereotypes: atpAbstract Tags: xml.sequenceOffset=20

Table D.1: VariableInAtomicSwcInstanceRef

Please note the example of how the redefinition of the context association works, i.e. the association from [VariableInAtomicSwcInstanceRef](#) to [PortPrototype](#) in the role `contextPort` is **redefined** by the subclass [RVariableInAtomicSwcInstanceRef](#) by means of an association to [RPortPrototype](#) in the role `contextR-Port`.

The effect of this modeling is that the general relationship to [PortPrototype](#) is already established by [VariableInAtomicSwcInstanceRef](#) on an abstract level but actually it never makes the generated XML Schema because it is **redefined** by a subclass. In other words, the redefinition replaces the original association as far as the generation algorithm for the XML Schema is concerned.

For clarification, the interpretation of the values of `xml.sequenceOffset` in this particular case is that in the generated XML Schema the attribute `base` comes first, followed by `contextPort`, and then `abstractTargetDataElement` concludes the definition of the `InstanceRef` in the XML Schema.

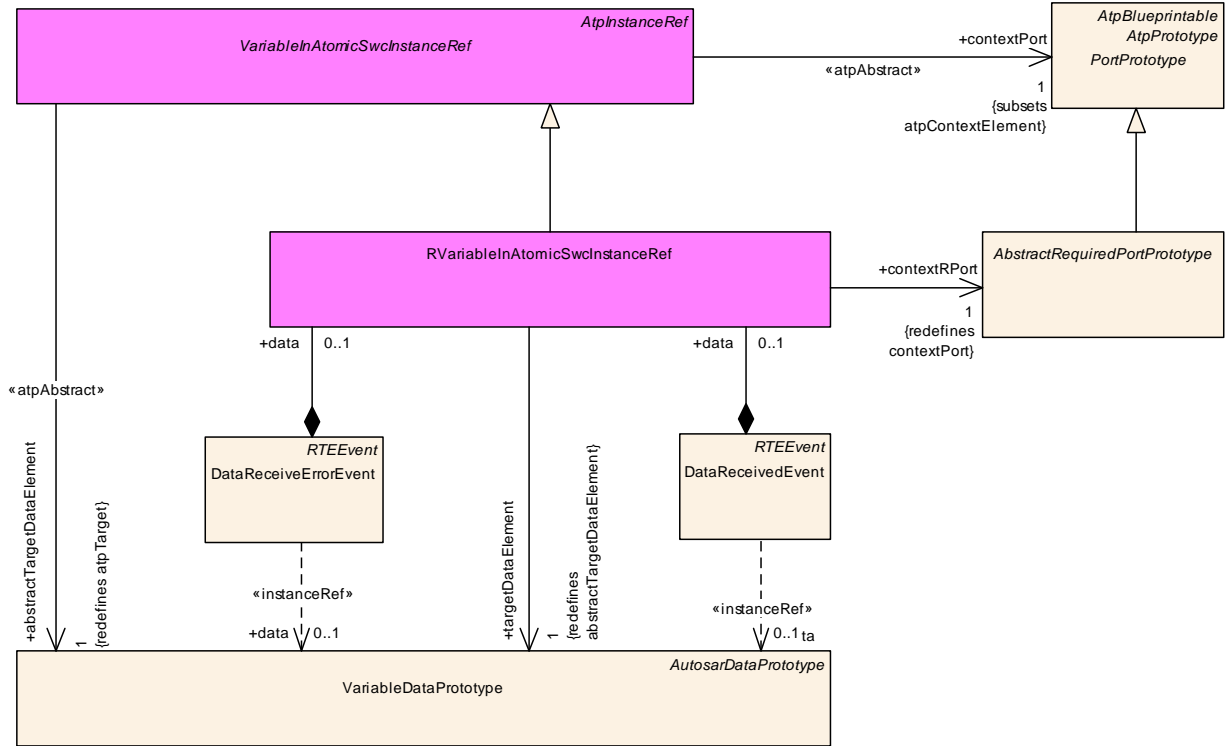

Figure D.2: Concrete modeling of references to `VariableDataPrototype` in the context of an `RPortPrototype`

Class	<code>RVariableInAtomicSwcInstanceRef</code>			
Package	M2::AUTOSARTemplates::SWComponentTemplate::Components::InstanceRefs			
Note				
Base	<code>ARObject</code> , <code>AtpInstanceRef</code> , <code>VariableInAtomicSwcInstanceRef</code>			
Attribute	Type	Mult.	Kind	Note
contextRPort	<code>AbstractRequiredPortPrototype</code>	1	ref	Tags: xml.sequenceOffset=20
targetDataElement	<code>VariableDataPrototype</code>	1	ref	Tags: xml.sequenceOffset=30

Table D.2: RVariableInAtomicSwcInstanceRef

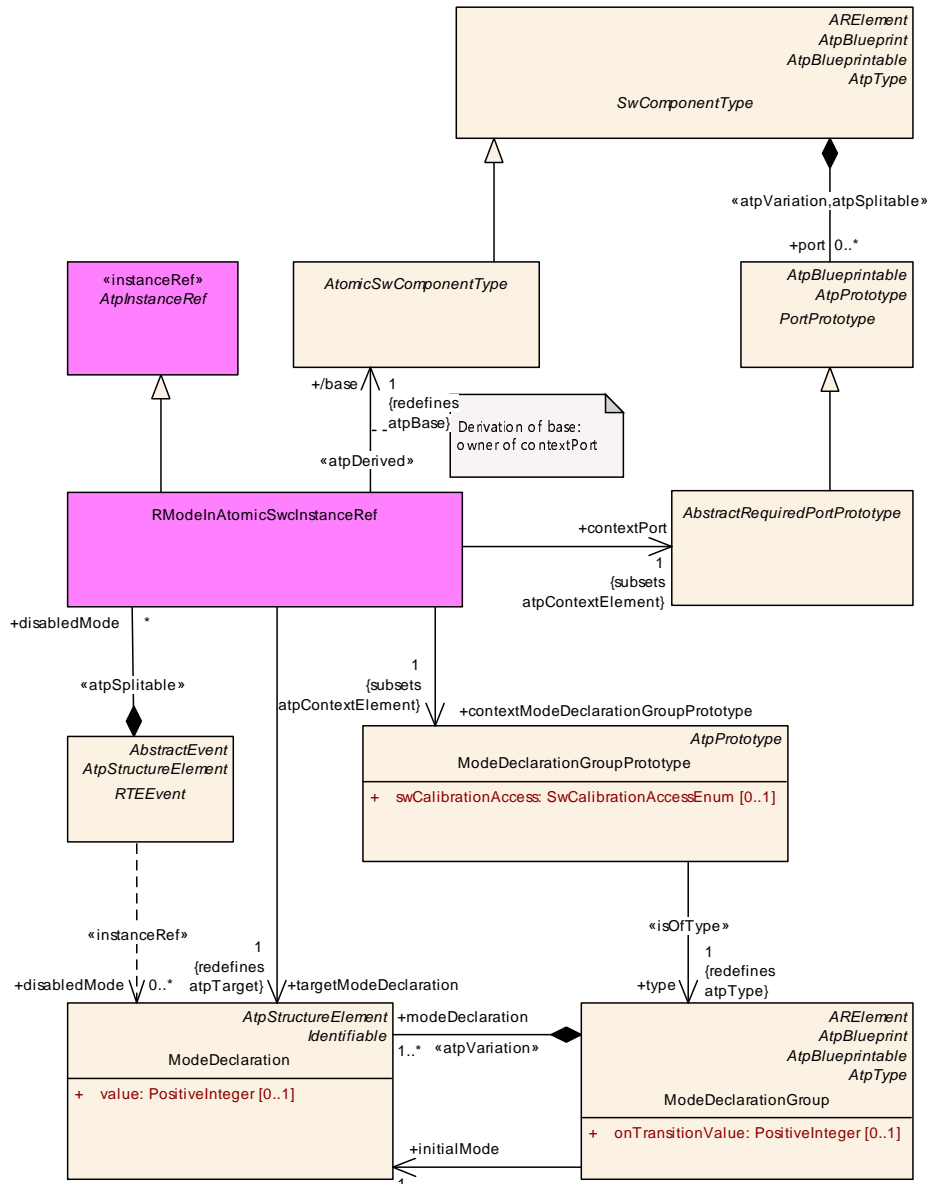

Figure D.3: Modeling of references to **ModeDeclarationGroupPrototype** in the context of an **RPortPrototype**

Class	RModelInAtomicSwcInstanceRef			
Package	M2::AUTOSARTemplates::SWComponentTemplate::Components::InstanceRefs			
Note				
Base	<i>ARObject</i> , <i>AtpInstanceRef</i>			
Attribute	Type	Mult.	Kind	Note
base	AtomicSwComponentType	1	ref	Stereotypes: <i>atpDerived</i> Tags: xml.sequenceOffset=10
contextMode Declaration GroupPrototype	ModeDeclarationGroupPrototype	1	ref	Tags: xml.sequenceOffset=30





Class	RModelAtomicSwcInstanceRef			
contextPort	AbstractRequiredPort Prototype	1	ref	Tags: xml.sequenceOffset=20
targetMode Declaration	ModeDeclaration	1	ref	Tags: xml.sequenceOffset=40

Table D.3: RModelAtomicSwcInstanceRef

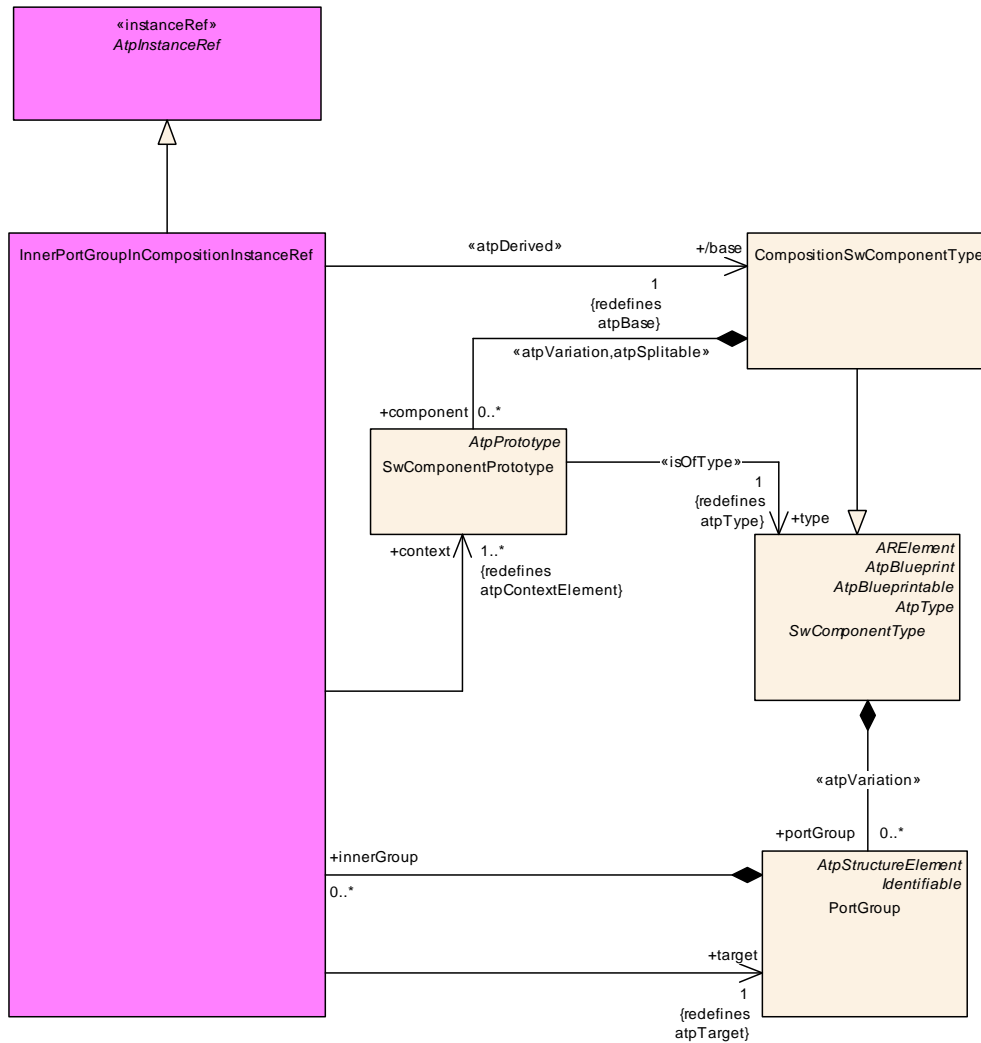

Figure D.4: Modeling of references to [PortGroup](#) in the context of a [CompositionSwComponentType](#)

Class	InnerPortGroupInCompositionInstanceRef
Package	M2::AUTOSARTemplates::SWComponentTemplate::Components::InstanceRefs
Note	
Base	<i>ARObject</i> , AtpInstanceRef





Class	InnerPortGroupInCompositionInstanceRef			
Attribute	Type	Mult.	Kind	Note
base	CompositionSw ComponentType	1	ref	Stereotypes: atpDerived Tags: xml.sequenceOffset=10
context	SwComponent Prototype	1..*	ref	Tags: xml.sequenceOffset=20
target	PortGroup	1	ref	Links a PortGroup in a composition to another PortGroup, that is defined in a component which is part of this CompositionSwComponentType. There shall be at most one innerGroup per contained SwComponentPrototype. Tags: xml.sequenceOffset=30

Table D.4: InnerPortGroupInCompositionInstanceRef

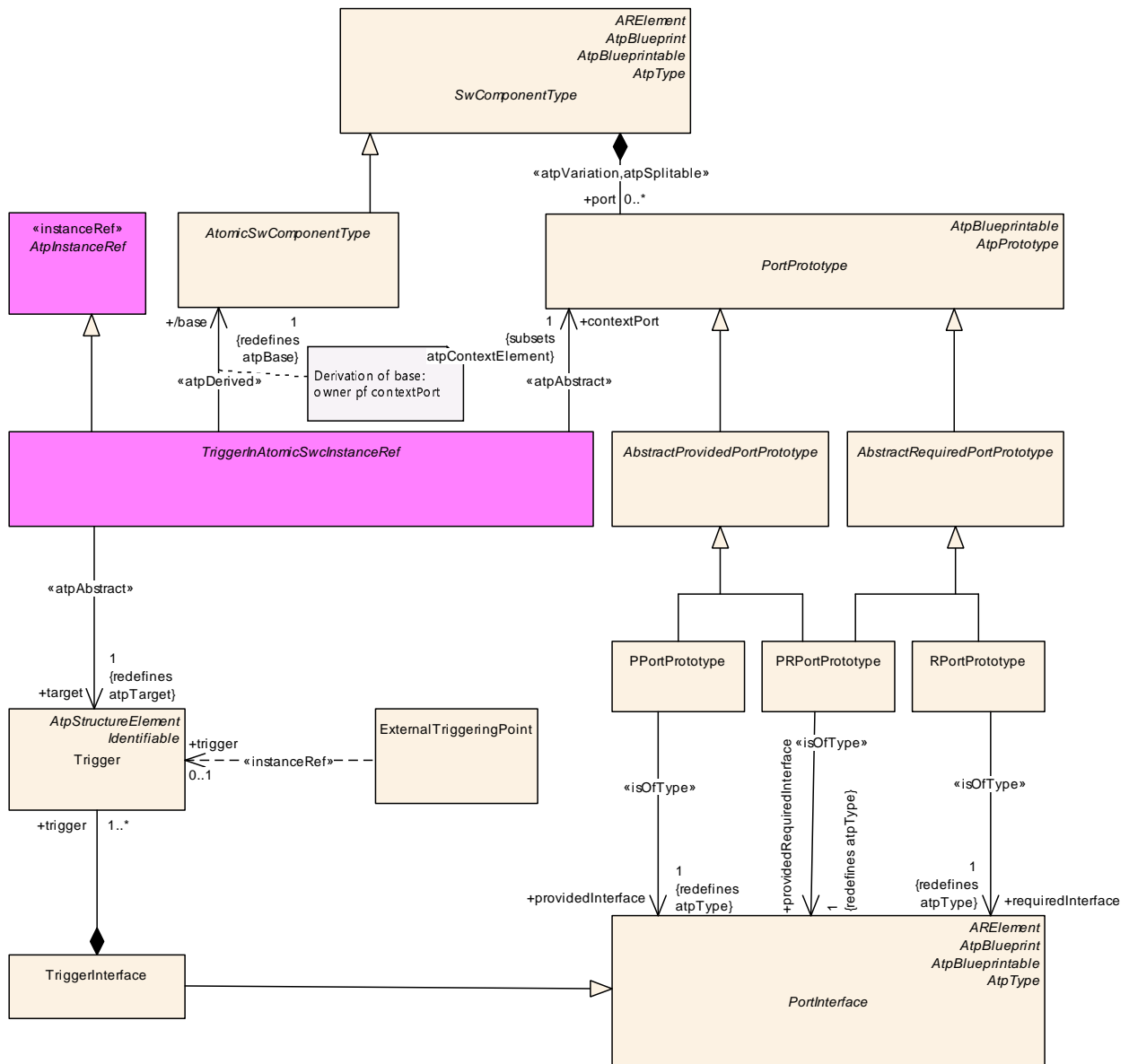

Figure D.5: Abstract modeling of references to **Trigger in the context of a **Atomic-SwComponentType****

Class	<i>TriggerInAtomicSwcInstanceRef</i> (abstract)			
Package	M2::AUTOSARTemplates::SWComponentTemplate::Components::InstanceRefs			
Note				
Base	<i>ARObject</i> , <i>AtpInstanceRef</i>			
Subclasses	<i>PTriggerInAtomicSwcTypeInstanceRef</i> , <i>RTriggerInAtomicSwcInstanceRef</i>			
Attribute	Type	Mult.	Kind	Note
base	AtomicSwComponentType	1	ref	Stereotypes: atpDerived Tags: xml.sequenceOffset=10
contextPort	PortPrototype	1	ref	Stereotypes: atpAbstract Tags: xml.sequenceOffset=20
target	Trigger	1	ref	Stereotypes: atpAbstract Tags: xml.sequenceOffset=30

Table D.5: TriggerInAtomicSwcInstanceRef

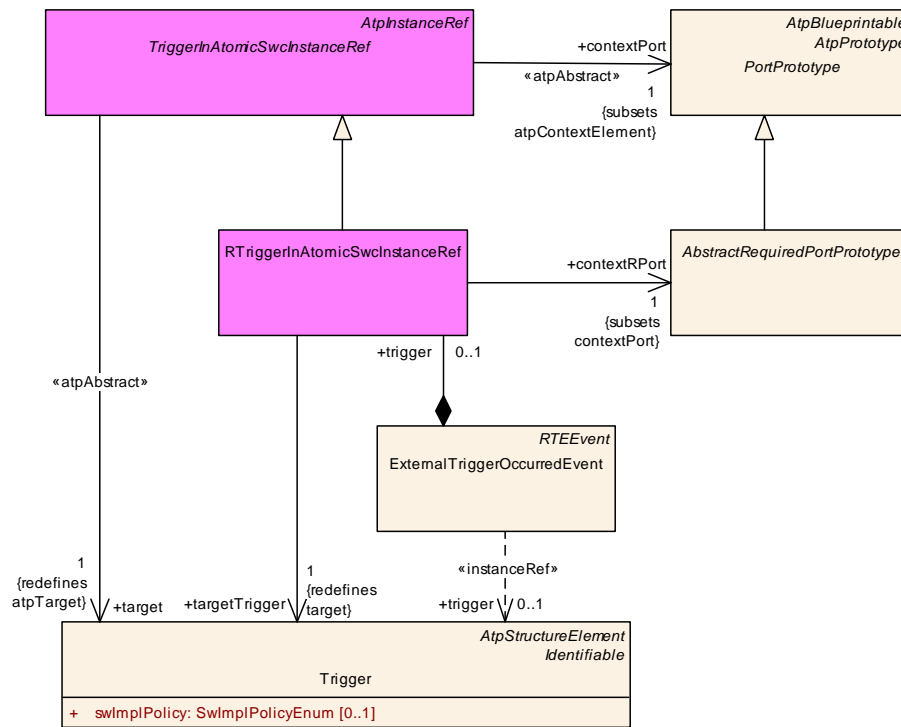

Figure D.6: Concrete modeling of references to [Trigger](#) in the context of an [RPortPrototype](#)

Class	<i>RTriggerInAtomicSwcInstanceRef</i>			
Package	M2::AUTOSARTemplates::SWComponentTemplate::Components::InstanceRefs			
Note				
Base	<i>ARObject</i> , <i>AtpInstanceRef</i> , <i>TriggerInAtomicSwcInstanceRef</i>			
Attribute	Type	Mult.	Kind	Note
contextRPort	AbstractRequiredPortPrototype	1	ref	Tags: xml.sequenceOffset=20





Class	RTriggerInAtomicSwcInstanceRef			
targetTrigger	Trigger	1	ref	Tags:xml.sequenceOffset=30

Table D.6: RTriggerInAtomicSwcInstanceRef

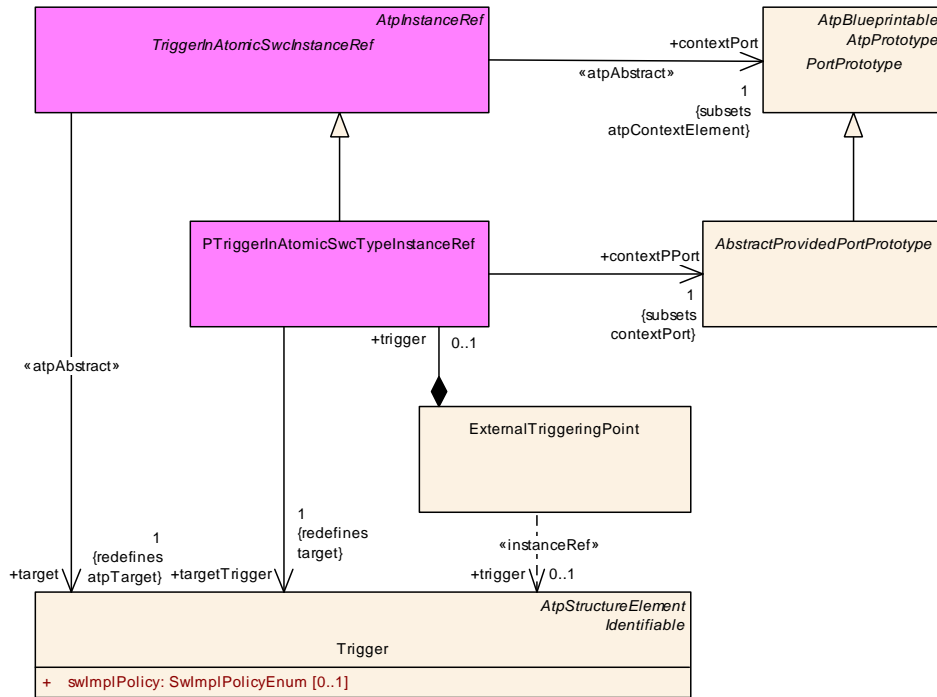

Figure D.7: Concrete modeling of references to **Trigger in the context of a **PPortPrototype****

Class	PTriggerInAtomicSwcTypeInstanceRef			
Package	M2::AUTOSARTemplates::SWComponentTemplate::Components::InstanceRefs			
Note				
Base	ARObject, AtpInstanceRef, TriggerInAtomicSwcInstanceRef			
Attribute	Type	Mult.	Kind	Note
contextPPort	AbstractProvidedPort Prototype	1	ref	Tags:xml.sequenceOffset=20
targetTrigger	Trigger	1	ref	Tags:xml.sequenceOffset=30

Table D.7: PTriggerInAtomicSwcTypeInstanceRef

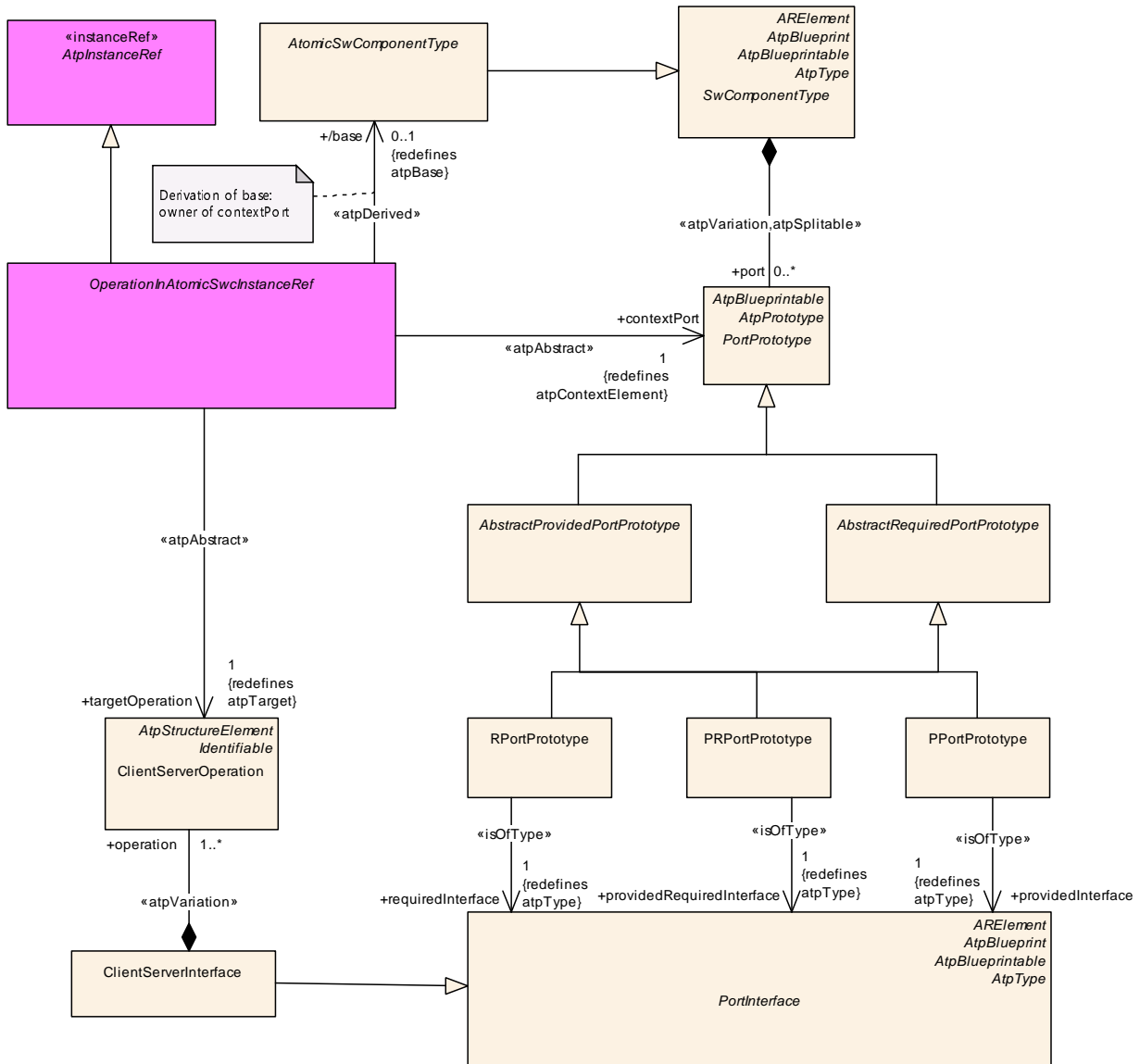
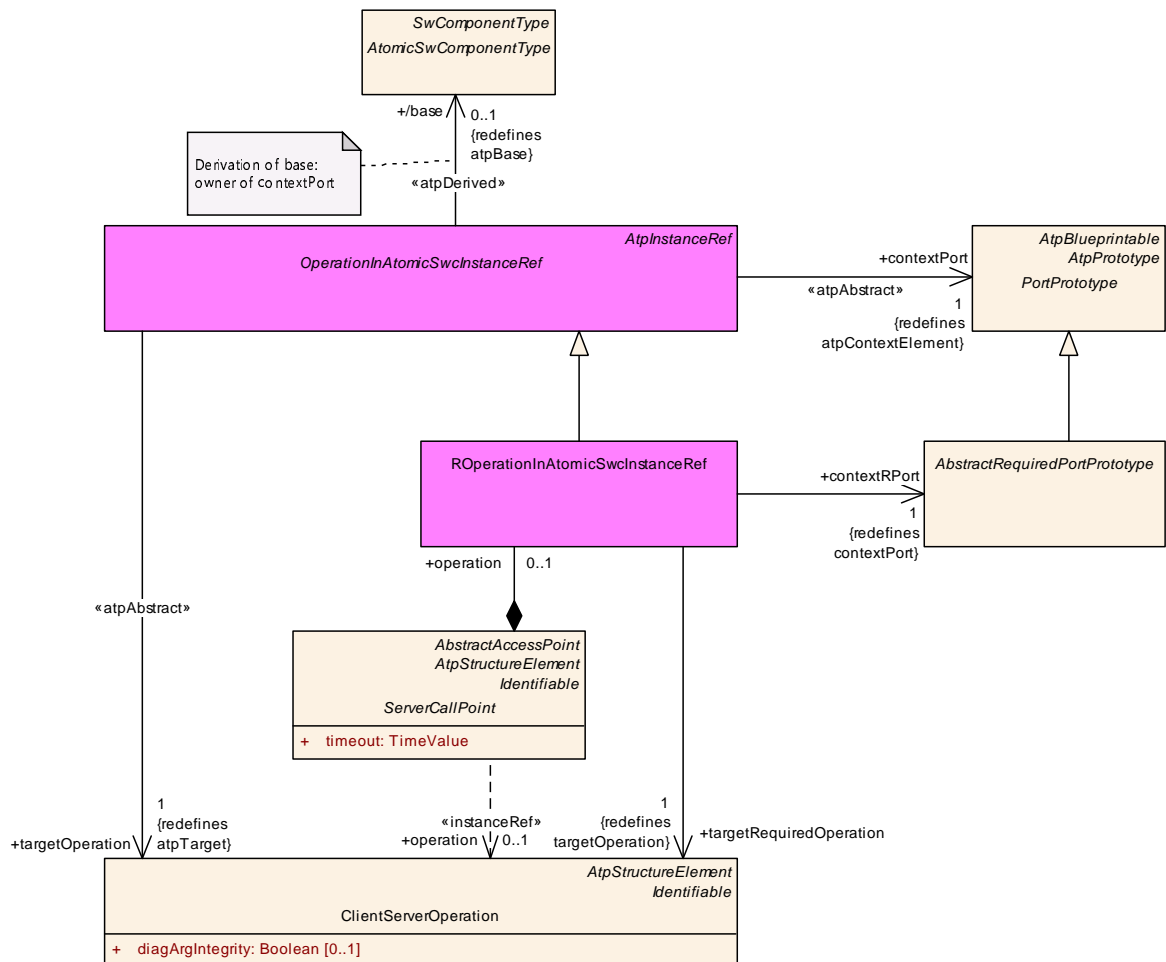

Figure D.8: Abstract modeling of references to `ClientServerOperation` in the context of a `AtomicSwComponentType`

Class	<code>OperationInAtomicSwcInstanceRef</code> (abstract)			
Package	M2::AUTOSARTemplates::SWComponentTemplate::Components::InstanceRefs			
Note				
Base	<code>ARObject</code> , <code>AtpInstanceRef</code>			
Subclasses	<code>POperationInAtomicSwcInstanceRef</code> , <code>ROperationInAtomicSwcInstanceRef</code>			
Attribute	Type	Mult.	Kind	Note
base	<code>AtomicSwComponentType</code>	0..1	ref	Stereotypes: <code>atpDerived</code> Tags: <code>xml.sequenceOffset=10</code>
contextPort	<code>PortPrototype</code>	1	ref	Stereotypes: <code>atpAbstract</code> Tags: <code>xml.sequenceOffset=20</code>



Class	OperationInAtomicSwcInstanceRef (abstract)			
targetOperation	ClientServerOperation	1	ref	Stereotypes: atpAbstract Tags: xml.sequenceOffset=30

Table D.8: OperationInAtomicSwcInstanceRef

Figure D.9: Concrete modeling of references to `ClientServerOperation` in the context of an `RPortPrototype`

Class	ROperationInAtomicSwcInstanceRef			
Package	M2::AUTOSARTemplates::SWComponentTemplate::Components::InstanceRefs			
Note				
Base	<code>ARObject</code> , <code>AtpInstanceRef</code> , <code>OperationInAtomicSwcInstanceRef</code>			
Attribute	Type	Mult.	Kind	Note
contextRPort	AbstractRequiredPortPrototype	1	ref	Tags: xml.sequenceOffset=20

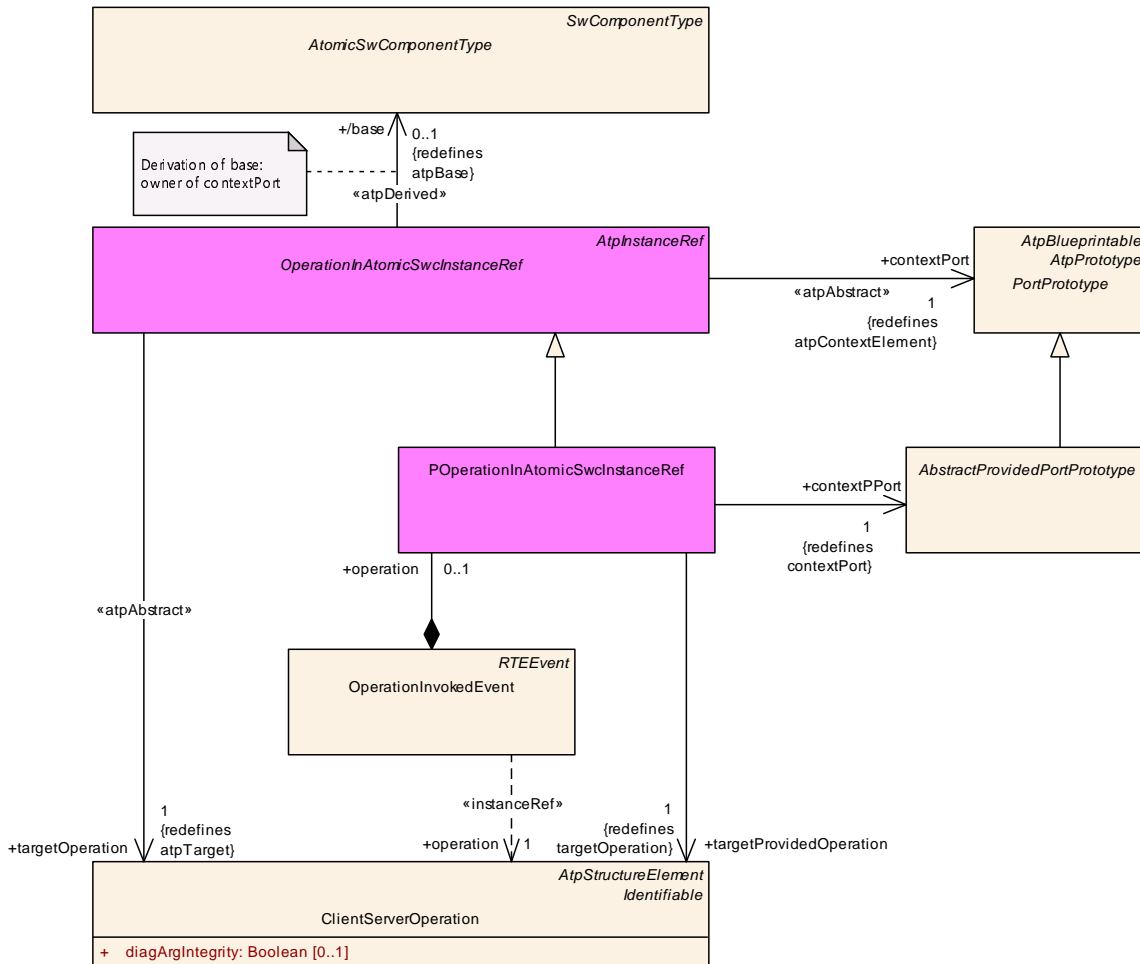

Class	ROperationInAtomicSwcInstanceRef			
targetRequired Operation	ClientServerOperation	1	ref	Tags: xml.sequenceOffset=30

Table D.9: ROperationInAtomicSwcInstanceRef

Figure D.10: Concrete modeling of references to [ClientServerOperation](#) in the context of a [PPortPrototype](#)

Class	POperationInAtomicSwcInstanceRef			
Package	M2::AUTOSARTemplates::SWComponentTemplate::Components::InstanceRefs			
Note				
Base	<i>ARObject</i> , AtpInstanceRef , OperationInAtomicSwcInstanceRef			
Attribute	Type	Mult.	Kind	Note
contextPPort	AbstractProvidedPortPrototype	1	ref	Tags: xml.sequenceOffset=20



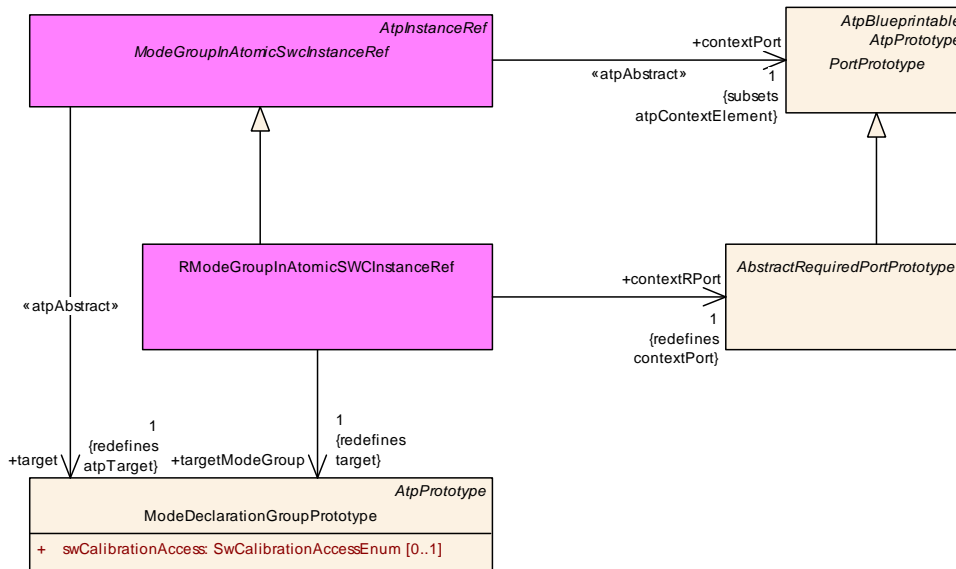

Class	POperationInAtomicSwcInstanceRef			
targetProvided Operation	ClientServerOperation	1	ref	Tags: xml.sequenceOffset=30

Table D.10: POperationInAtomicSwcInstanceRef

Figure D.11: Concrete modeling of references to ModeDeclarationGroupPrototype in the context of an RPortPrototype

Class	RModeGroupInAtomicSWCInstanceRef			
Package	M2::AUTOSARTemplates::SWComponentTemplate::Components::InstanceRefs			
Note				
Base	<i>ARObject, AtpInstanceRef, ModeGroupInAtomicSwcInstanceRef</i>			
Attribute	Type	Mult.	Kind	Note
contextRPort	AbstractRequiredPortPrototype	1	ref	Tags: xml.sequenceOffset=20
targetMode Group	ModeDeclarationGroupPrototype	1	ref	Tags: xml.sequenceOffset=30

Table D.11: RModeGroupInAtomicSWCInstanceRef

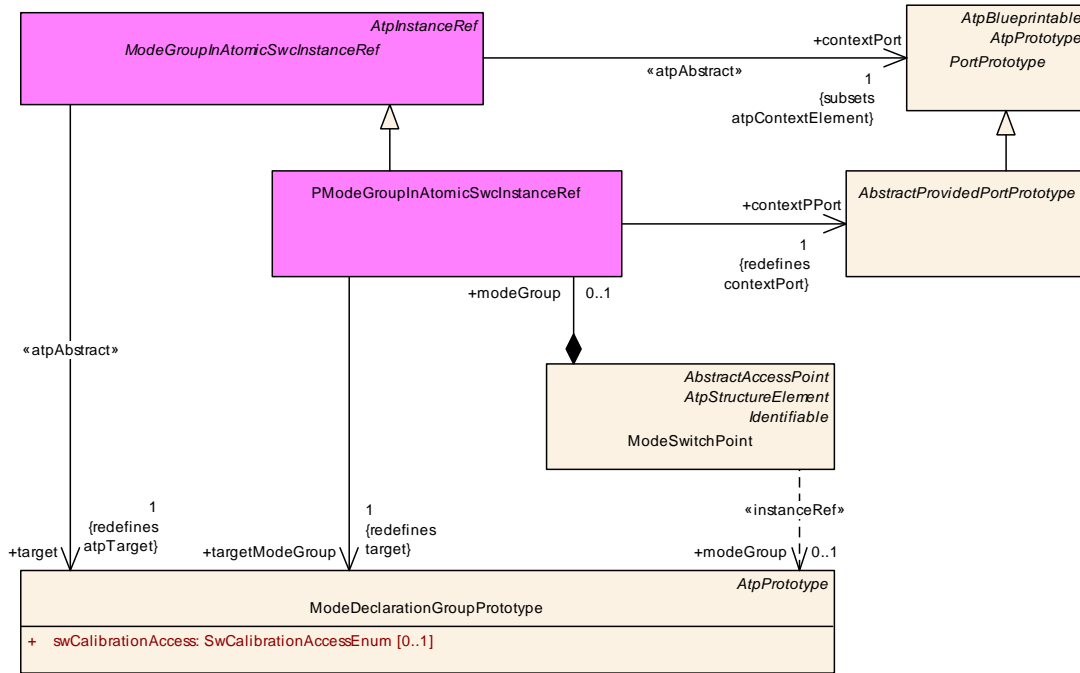

Figure D.12: Concrete modeling of references to **ModeDeclarationGroupPrototype** in the context of a **PPortPrototype**

Class	PModeGroupInAtomicSwcInstanceRef			
Package	M2::AUTOSARTemplates::SWComponentTemplate::Components::InstanceRefs			
Note				
Base	ARObject, AtpInstanceRef, ModeGroupInAtomicSwcInstanceRef			
Attribute	Type	Mult.	Kind	Note
contextPPort	AbstractProvidedPortPrototype	1	ref	Tags:xml.sequenceOffset=20
targetModeGroup	ModeDeclarationGroupPrototype	1	ref	Tags:xml.sequenceOffset=30

Table D.12: PModeGroupInAtomicSwcInstanceRef

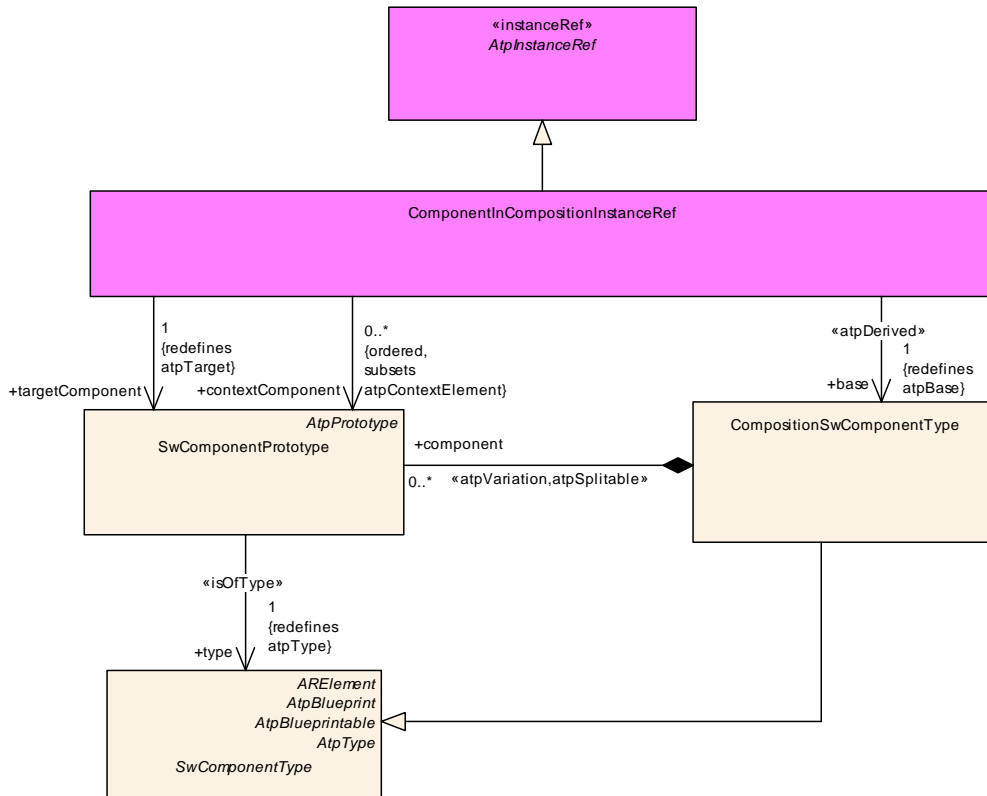

Figure D.13: Concrete modeling of references to *SwComponentPrototype* in the context of a *CompositionSwComponentType*

Class	ComponentInCompositionInstanceRef			
Package	M2::AUTOSARTemplates::SWComponentTemplate::Composition::InstanceRefs			
Note	The ComponentInCompositionInstanceRef points to a concrete SwComponentPrototype within a CompositionSwComponentType.			
Base	ARObject, AtpInstanceRef			
Attribute	Type	Mult.	Kind	Note
base	CompositionSwComponentType	1	ref	Stereotypes: atpDerived Tags: xml.sequenceOffset=10
context Component (ordered)	SwComponentPrototype	*	ref	The context for the scope of this timing event. Tags: xml.sequenceOffset=20
target Component	SwComponentPrototype	1	ref	Tags: xml.sequenceOffset=30

Table D.13: ComponentInCompositionInstanceRef

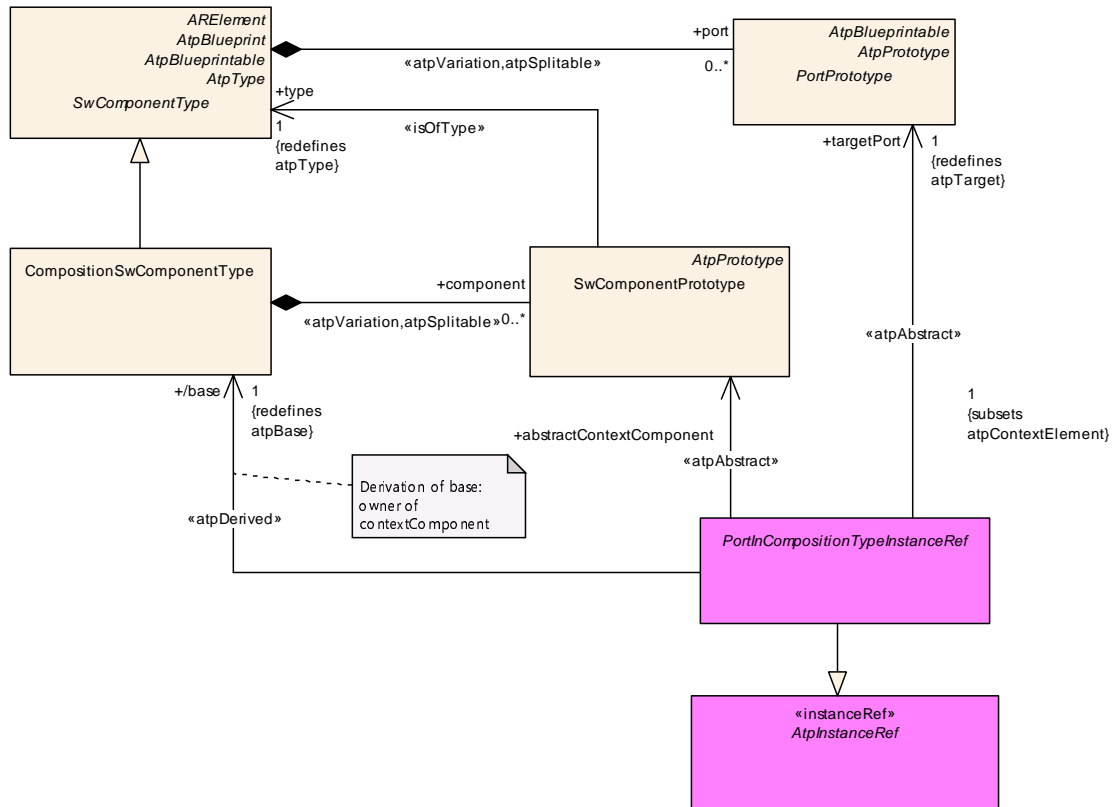

Figure D.14: Abstract modeling of references to **PortPrototype** in the context of a **CompositionSwComponentType**

Class	<i>PortInCompositionTypeInstanceRef</i> (abstract)			
Package	M2::AUTOSARTemplates::SWComponentTemplate::Composition::InstanceRefs			
Note				
Base	<i>ARObject</i> , <i>AtpInstanceRef</i>			
Subclasses	<i>PPortInCompositionInstanceRef</i> , <i>RPortInCompositionInstanceRef</i>			
Attribute	Type	Mult.	Kind	Note
abstractContextComponent	SwComponentPrototype	1	ref	Stereotypes: atpAbstract Tags: xml.sequenceOffset=20
base	CompositionSwComponentType	1	ref	Stereotypes: atpDerived Tags: xml.sequenceOffset=10
targetPort	PortPrototype	1	ref	Stereotypes: atpAbstract Tags: xml.sequenceOffset=30

Table D.14: **PortInCompositionTypeInstanceRef**

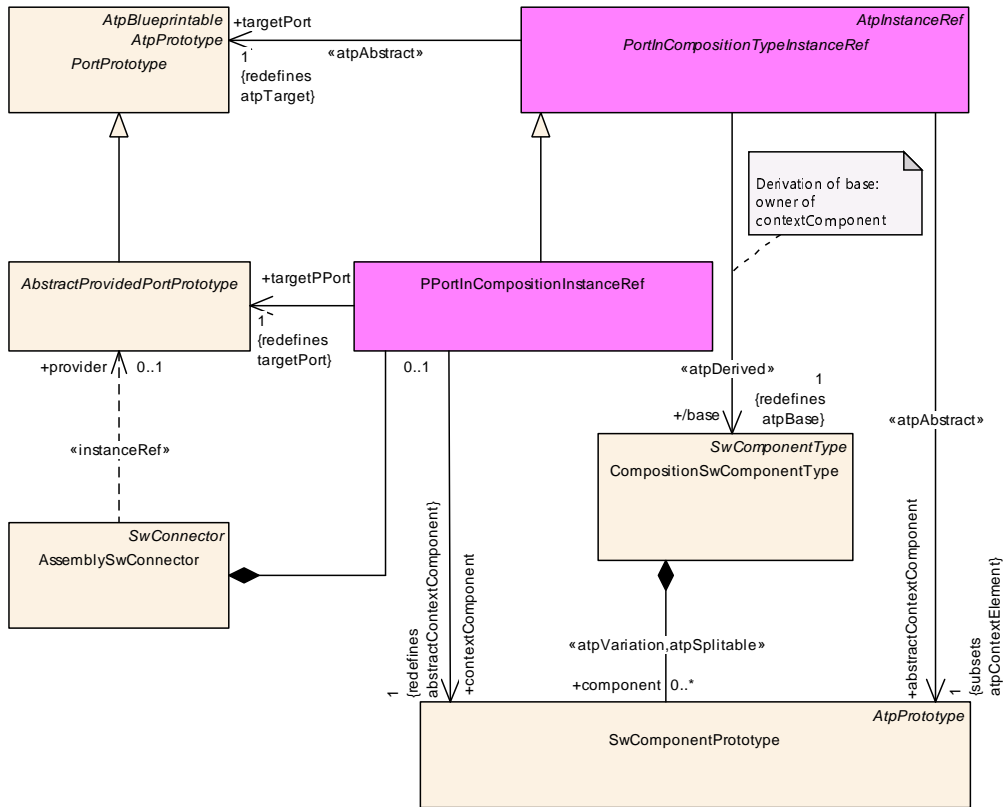

Figure D.15: Concrete modeling of references to PPortPrototype in the context of a CompositionSwComponentType

Class	PPortInCompositionInstanceRef			
Package	M2::AUTOSARTemplates::SWComponentTemplate::Composition::InstanceRefs			
Note				
Base	ARObject, AtpInstanceRef, PortInCompositionTypeInstanceRef			
Attribute	Type	Mult.	Kind	Note
contextComponent	SwComponentPrototype	1	ref	Tags:xml.sequenceOffset=20
targetPPort	AbstractProvidedPortPrototype	1	ref	Tags:xml.sequenceOffset=30

Table D.15: PPortInCompositionInstanceRef

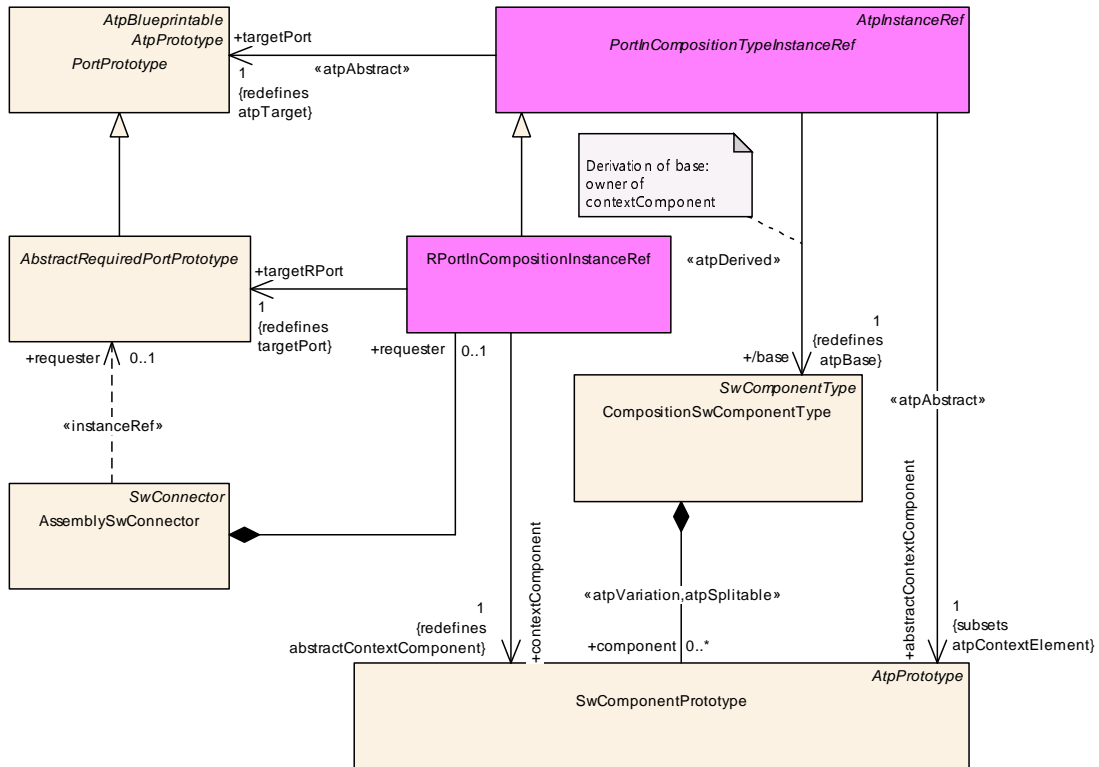

Figure D.16: Concrete modeling of references to RPortPrototype in the context of a CompositionSwComponentType

Class	RPortInCompositionInstanceRef			
Package	M2::AUTOSARTemplates::SWComponentTemplate::Composition::InstanceRefs			
Note				
Base	ARObject, AtpInstanceRef, PortInCompositionTypeInstanceRef			
Attribute	Type	Mult.	Kind	Note
contextComponent	SwComponentPrototype	1	ref	Tags:xml.sequenceOffset=20
targetRPort	AbstractRequiredPortPrototype	1	ref	Tags:xml.sequenceOffset=30

Table D.16: RPortInCompositionInstanceRef

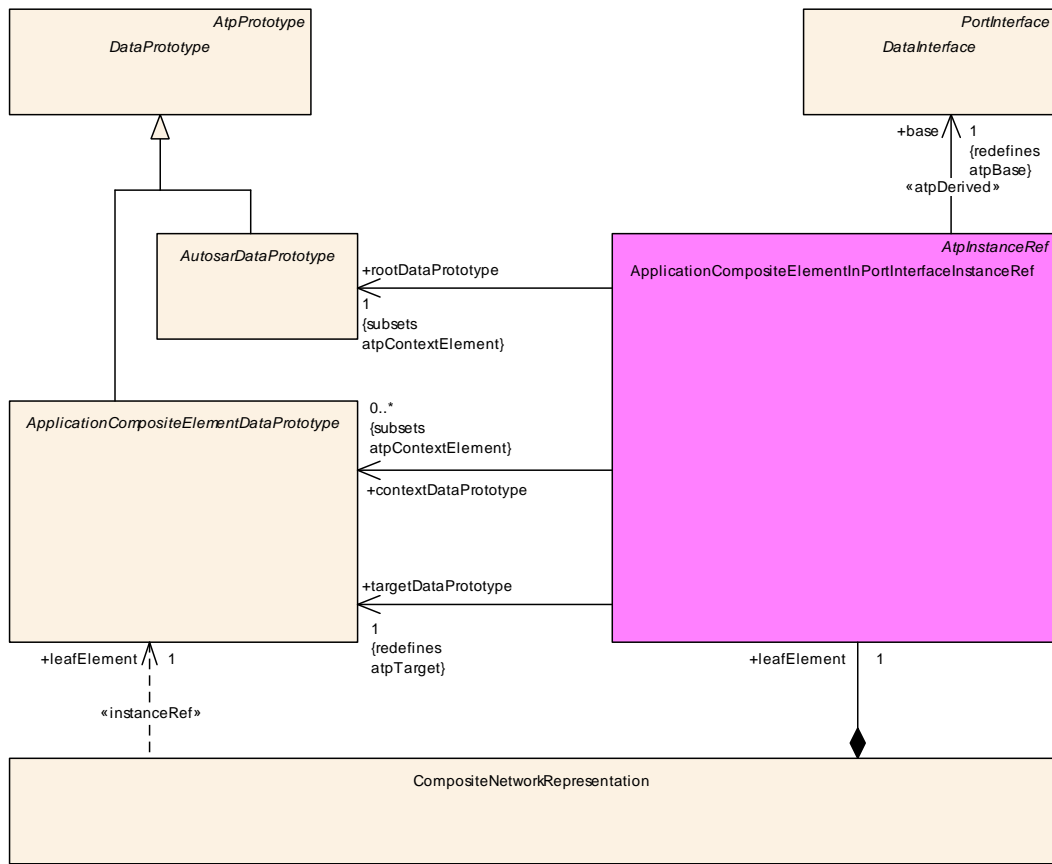

Figure D.17: Modeling of references to `ApplicationCompositeElementDataPrototype` for the purpose of defining a network representation

Class	InnerDataPrototypeGroupInCompositionInstanceRef			
Package	M2::AUTOSARTemplates::SWComponentTemplate::ImplicitCommunicationBehavior::InstanceRef			
Note	This meta-class represents the ability to define an InstanceRef to a nested DataPrototypeGroup			
Base	<i>ARObject, AtpInstanceRef</i>			
Attribute	Type	Mult.	Kind	Note
base	CompositionSw ComponentType	1	ref	This represents the base of the instanceRef. Stereotypes: atpDerived Tags: xml.sequenceOffset=10
contextSw Component Prototype	SwComponent Prototype	1..*	ref	This represents the nested structure of SwComponent Prototypes. Tags: xml.sequenceOffset=20
targetData PrototypeGroup	DataPrototypeGroup	1	ref	This represents the target of the InstanceRef Tags: xml.sequenceOffset=30

Table D.17: InnerDataPrototypeGroupInCompositionInstanceRef

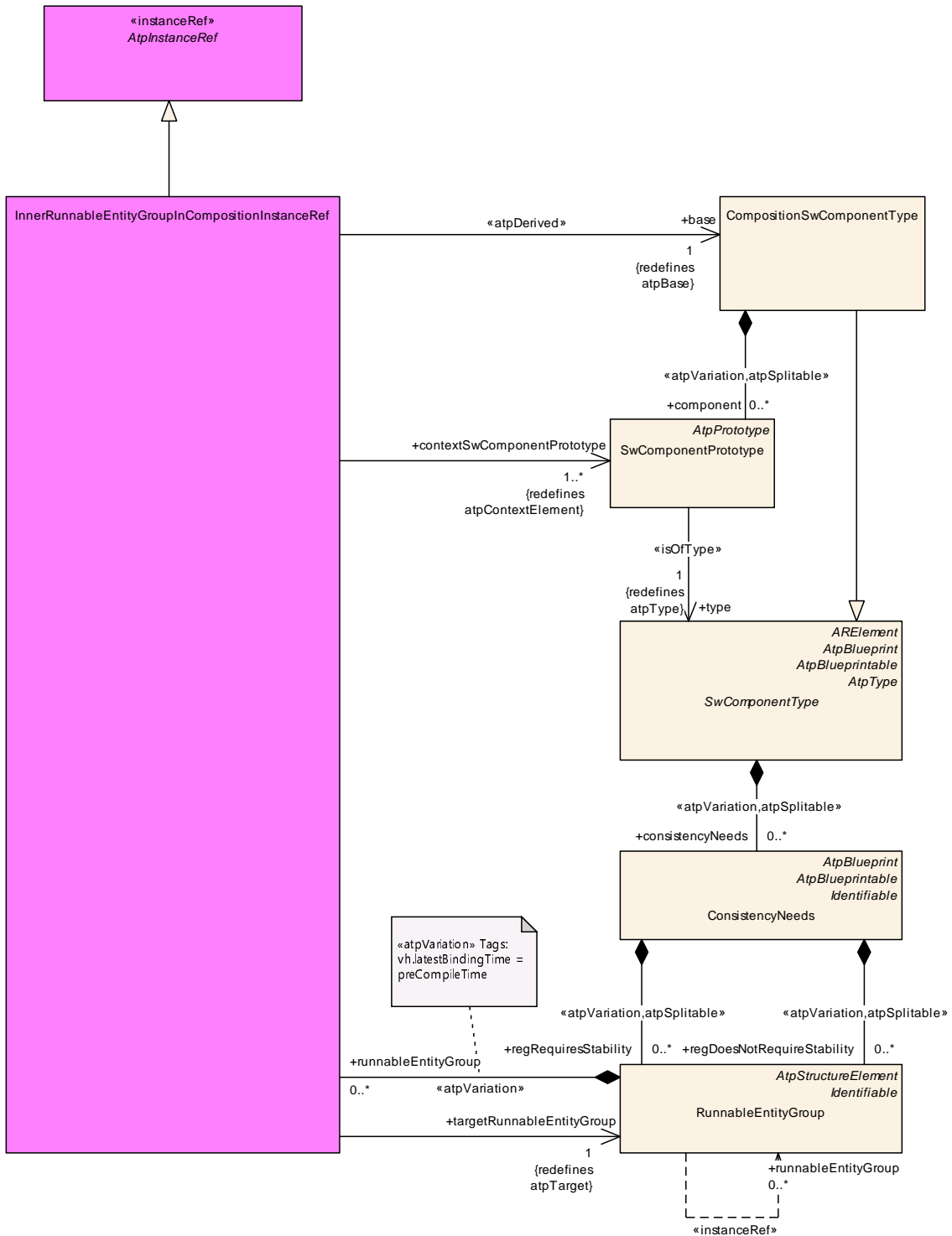

Figure D.19: Modeling of references to `RunnableEntityGroup` in the context of a `CompositionSwComponentType`

Class	InnerRunnableEntityGroupInCompositionInstanceRef			
Package	M2::AUTOSARTemplates::SWComponentTemplate::ImplicitCommunicationBehavior::InstanceRef			
Note	This meta-class represents the ability to define an InstanceRef to a nested RunnableEntityGroup.			
Base	<i>ARObject, AtpInstanceRef</i>			
Attribute	Type	Mult.	Kind	Note
base	CompositionSw ComponentType	1	ref	This represents the base of the InstanceRef. Stereotypes: atpDerived Tags: xml.sequenceOffset=10
contextSw Component Prototype	SwComponent Prototype	1..*	ref	This represents the nested structure of SwComponent Prototypes. Tags: xml.sequenceOffset=20
targetRunnable EntityGroup	RunnableEntityGroup	1	ref	This represents the target association of the InstanceRef. Tags: xml.sequenceOffset=30

Table D.18: InnerRunnableEntityGroupInCompositionInstanceRef

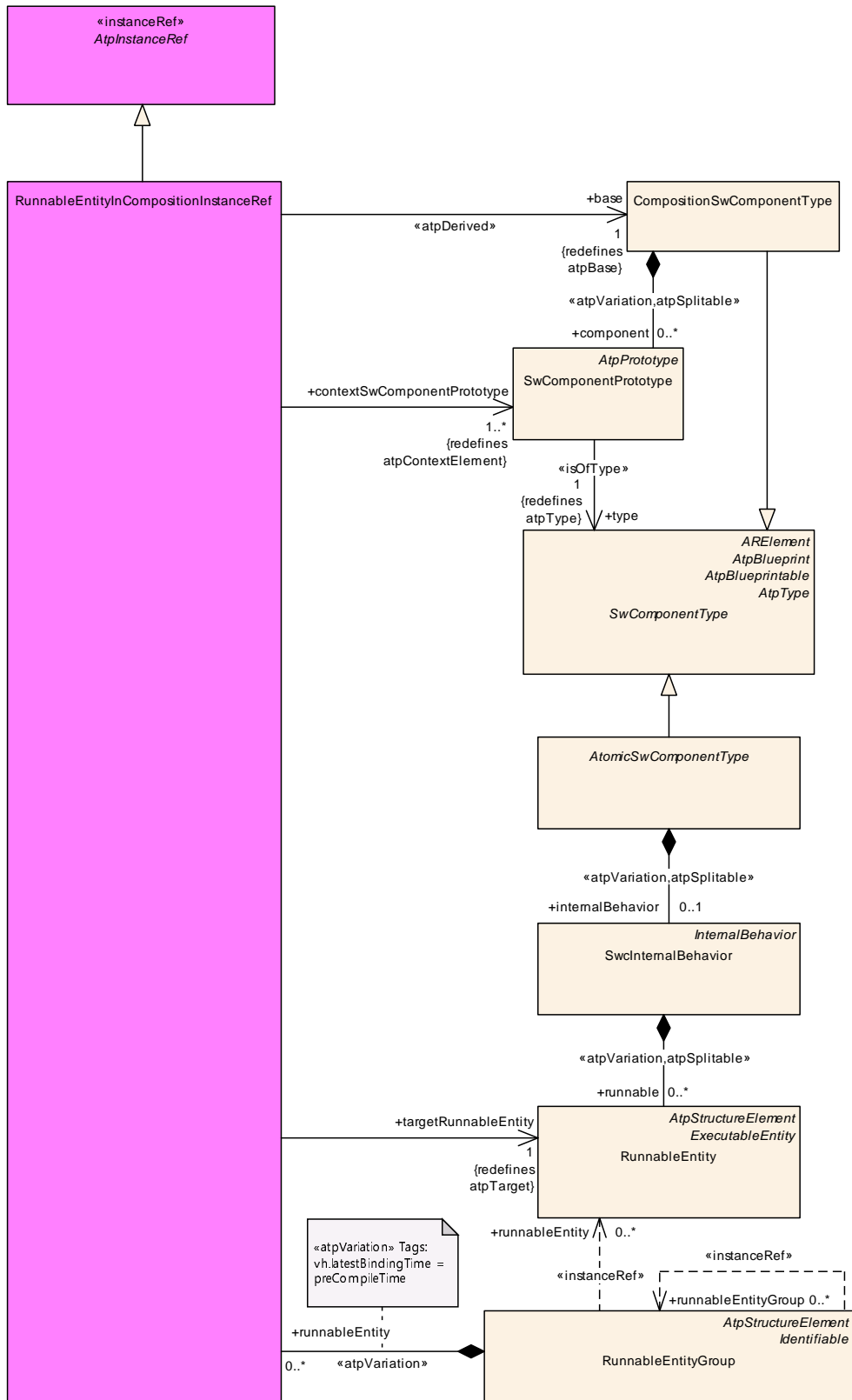

Figure D.20: Modeling of references to `RunnableEntity` in the context of a `CompositionSwComponentType` from the point of view of a `RunnableEntityGroup`

Class	RunnableEntityInCompositionInstanceRef			
Package	M2::AUTOSARTemplates::SWComponentTemplate::ImplicitCommunicationBehavior::InstanceRef			
Note	This meta-class represents the ability to define an InstanceRef to a RunnableEntity in the context of a CompositionSwComponentType.			
Base	<i>ARObject</i> , <i>AtpInstanceRef</i>			
Attribute	Type	Mult.	Kind	Note
base	CompositionSwComponentType	1	ref	This represents the base of the InstanceRef. Stereotypes: atpDerived Tags: xml.sequenceOffset=10
contextSwComponentPrototype	SwComponentPrototype	1..*	ref	This represents the nested structure of SwComponent Prototypes. Tags: xml.sequenceOffset=20
targetRunnableEntity	RunnableEntity	1	ref	This represents the target RunnableEntity. Tags: xml.sequenceOffset=30

Table D.19: RunnableEntityInCompositionInstanceRef

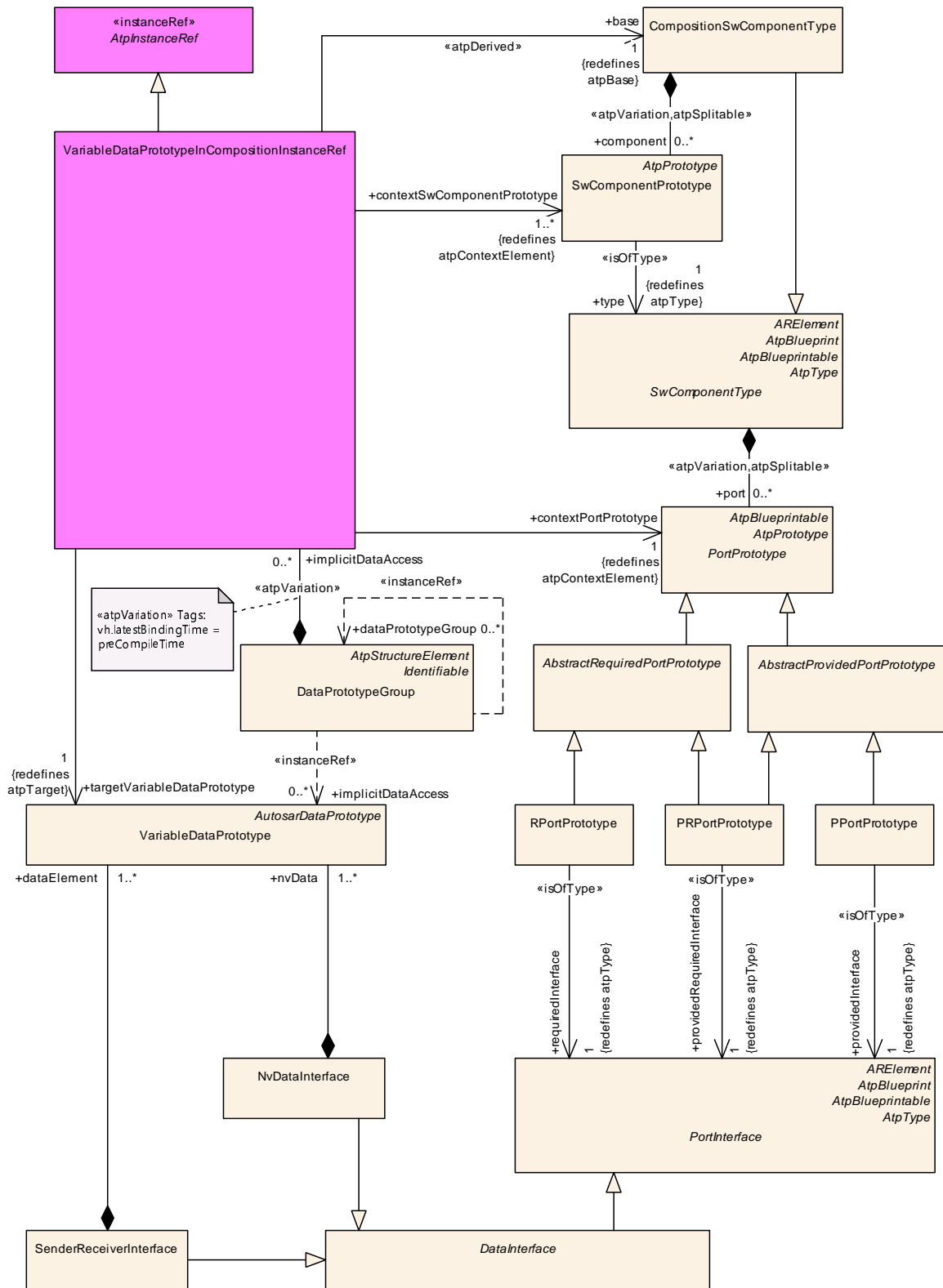

Figure D.21: Modeling of references to **VariableDataPrototype in the context of a **CompositionSwComponentType** from the point of view of a **RunnableEntityGroup****

Class	VariableDataPrototypeInCompositionInstanceRef			
Package	M2::AUTOSARTemplates::SWComponentTemplate::ImplicitCommunicationBehavior::InstanceRef			
Note	This meta-class represents the ability to define an InstanceRef to a VariableDataPrototype in the context of a CompositionSwComponentType.			
Base	<i>ARObject</i> , <i>AtpInstanceRef</i>			
Attribute	Type	Mult.	Kind	Note
base	CompositionSwComponentType	1	ref	This represents the base of the InstanceRef. Stereotypes: atpDerived Tags: xml.sequenceOffset=10
contextPortPrototype	PortPrototype	1	ref	This represents a reference to a context PortPrototype. Tags: xml.sequenceOffset=30
contextSwComponentPrototype	SwComponentPrototype	1..*	ref	This represents the nested structure of SwComponentPrototypes. Tags: xml.sequenceOffset=20
targetVariableDataPrototype	VariableDataPrototype	1	ref	This represents the target VariableDataPrototype. Tags: xml.sequenceOffset=40

Table D.20: VariableDataPrototypeInCompositionInstanceRef

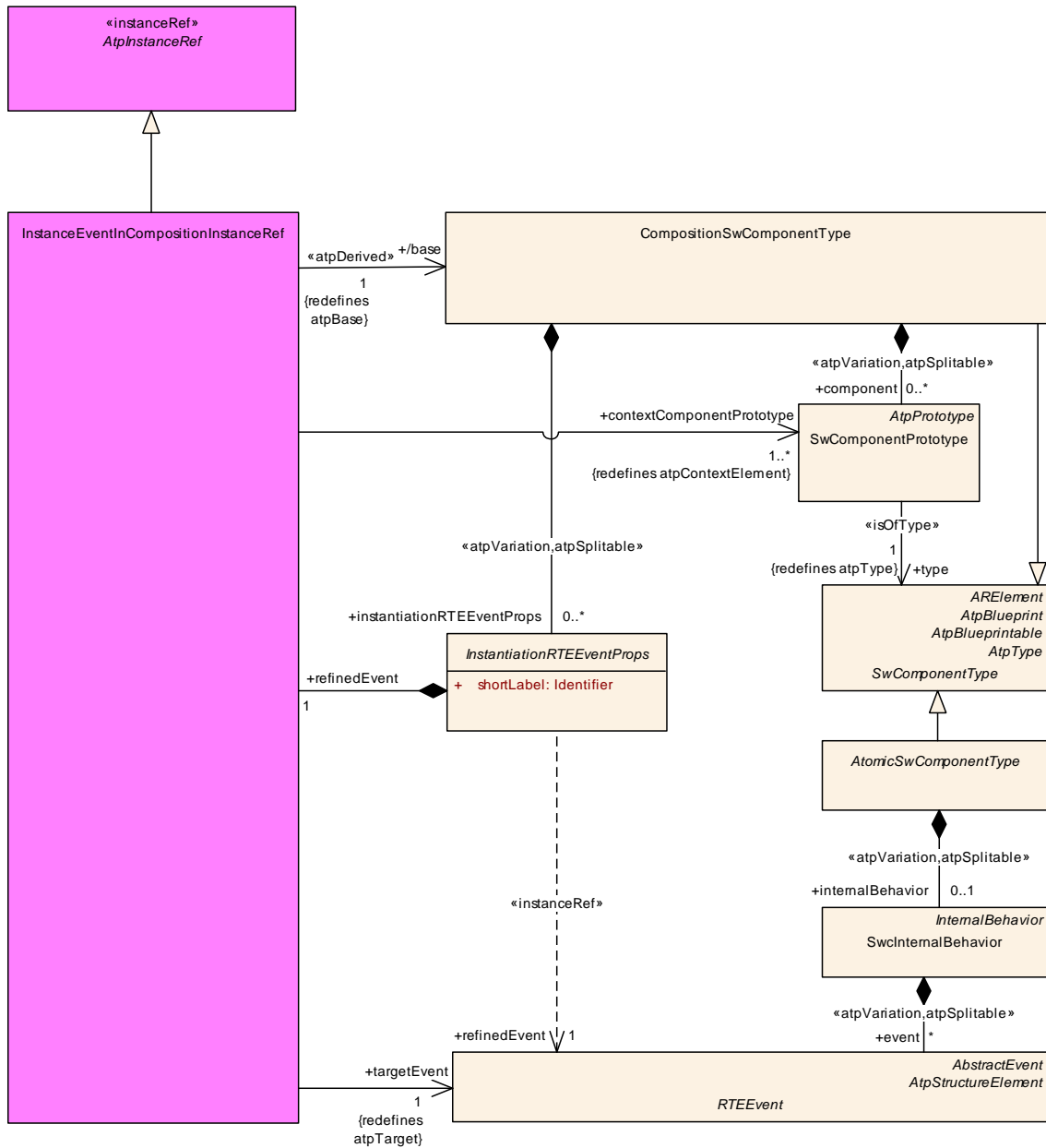

Figure D.22: Modeling of references to RTEEvent in the context of an InstantiationRTEEventProps from the point of view of a CompositionSwComponentType

Class	InstanceEventInCompositionInstanceRef			
Package	M2::AUTOSARTemplates::SWComponentTemplate::Composition::InstanceRefs			
Note				
Base	ARObject, AtpInstanceRef			
Attribute	Type	Mult.	Kind	Note
base	CompositionSwComponentType	1	ref	Stereotypes: atpDerived Tags: xml.sequenceOffset=10





<i>Class</i>	InstanceEventInCompositionInstanceRef			
context Component Prototype	SwComponent Prototype	1..*	ref	Tags: xml.sequenceOffset=20
targetEvent	RTEEvent	1	ref	Tags: xml.sequenceOffset=30

Table D.21: InstanceEventInCompositionInstanceRef

D.2.3 Internal Behavior

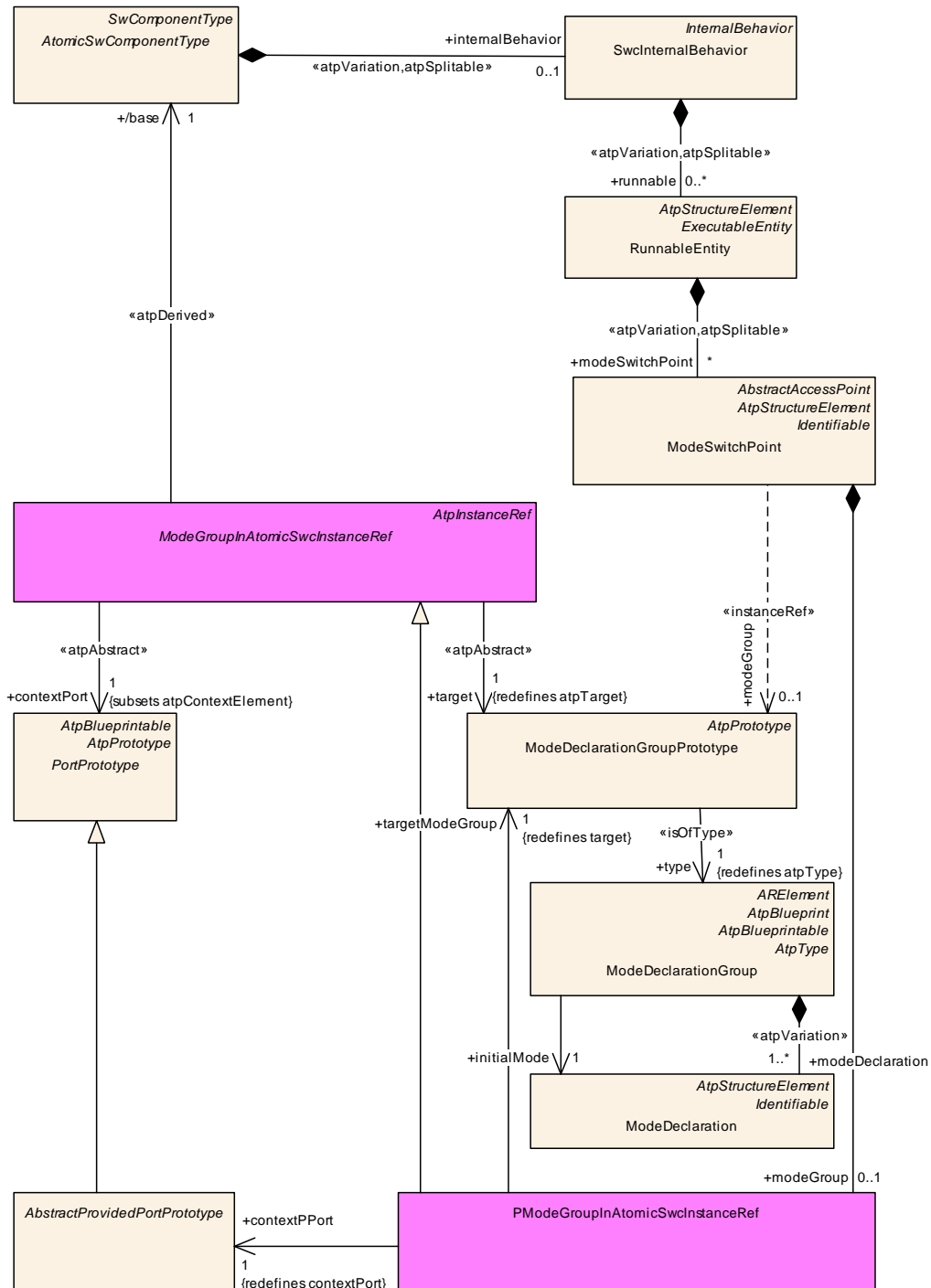

Figure D.23: Modeling of references to provided **ModeDeclarationGroupPrototype** in the context of an **AtomicSwComponentType**

Class	<i>ModeGroupInAtomicSwcInstanceRef</i> (abstract)			
Package	M2::AUTOSARTemplates::SWComponentTemplate::Components::InstanceRefs			
Note				
Base	<i>ARObject</i> , <i>AtpInstanceRef</i>			
Subclasses	<i>PModeGroupInAtomicSwcInstanceRef</i> , <i>RModeGroupInAtomicSWCInstanceRef</i>			
Attribute	Type	Mult.	Kind	Note
base	AtomicSwComponentType	1	ref	Stereotypes: atpDerived Tags: xml.sequenceOffset=10
contextPort	PortPrototype	1	ref	Stereotypes: atpAbstract Tags: xml.sequenceOffset=20
target	ModeDeclarationGroupPrototype	1	ref	Stereotypes: atpAbstract Tags: xml.sequenceOffset=30

Table D.22: ModeGroupInAtomicSwcInstanceRef

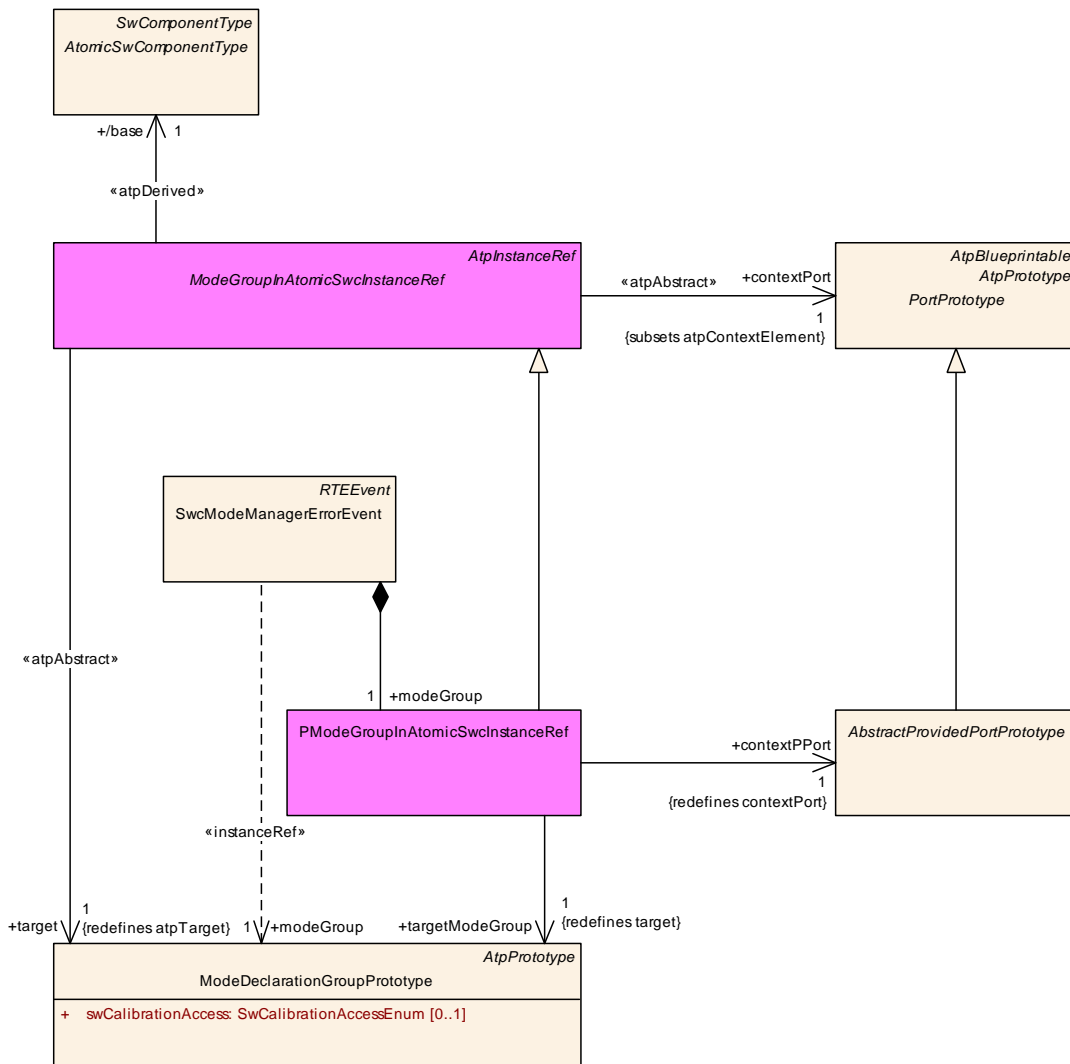

Figure D.24: Modeling of references to provided ModeDeclarationGroupPrototype to be used by SwcModeManagerErrorEvent

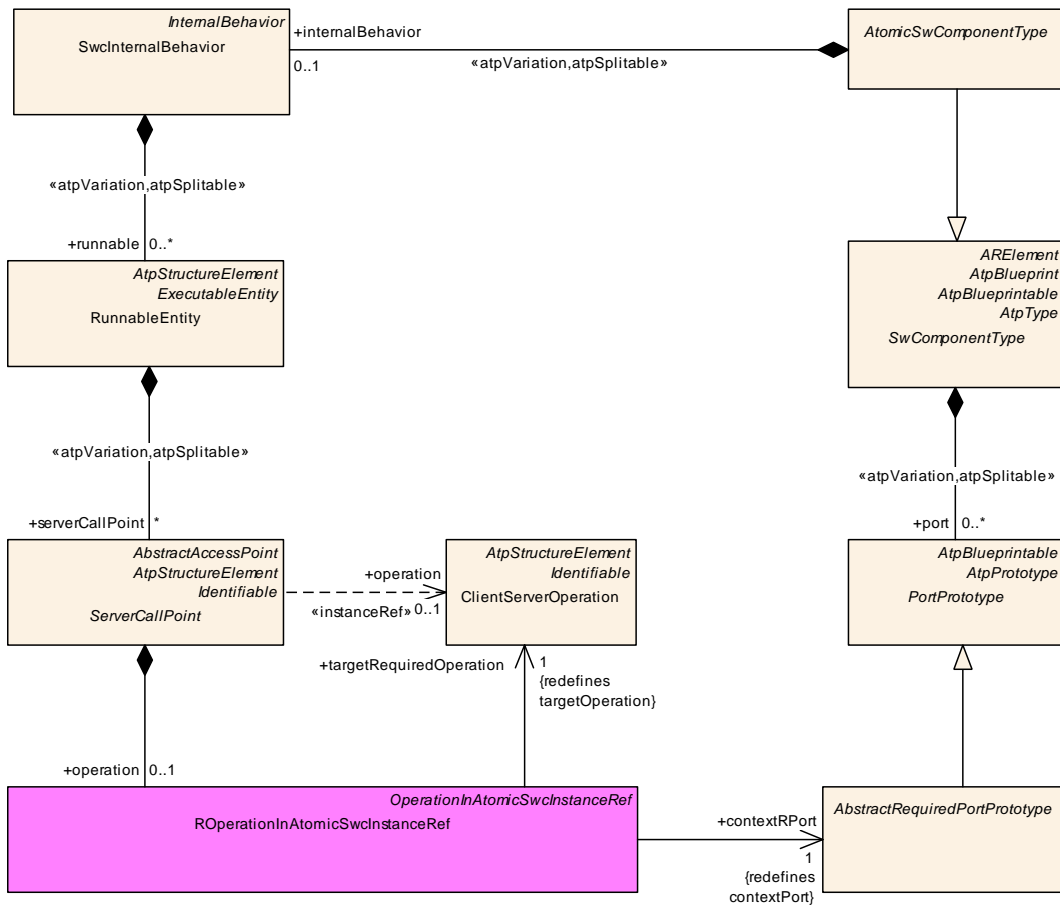

Figure D.26: Modeling of references to required **ClientServerOperation** in the context of a **SwComponentType**

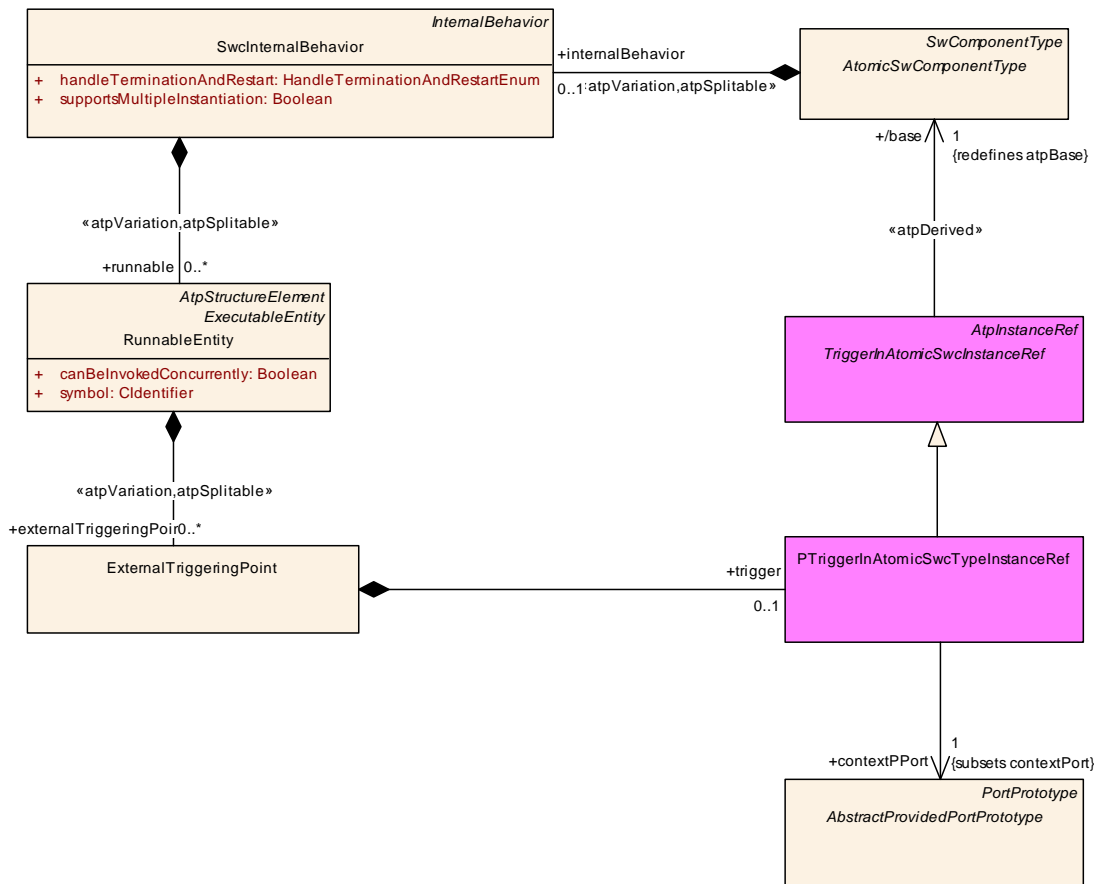

Figure D.27: Modeling of references to a **Trigger** in the context of a **SwComponentType**

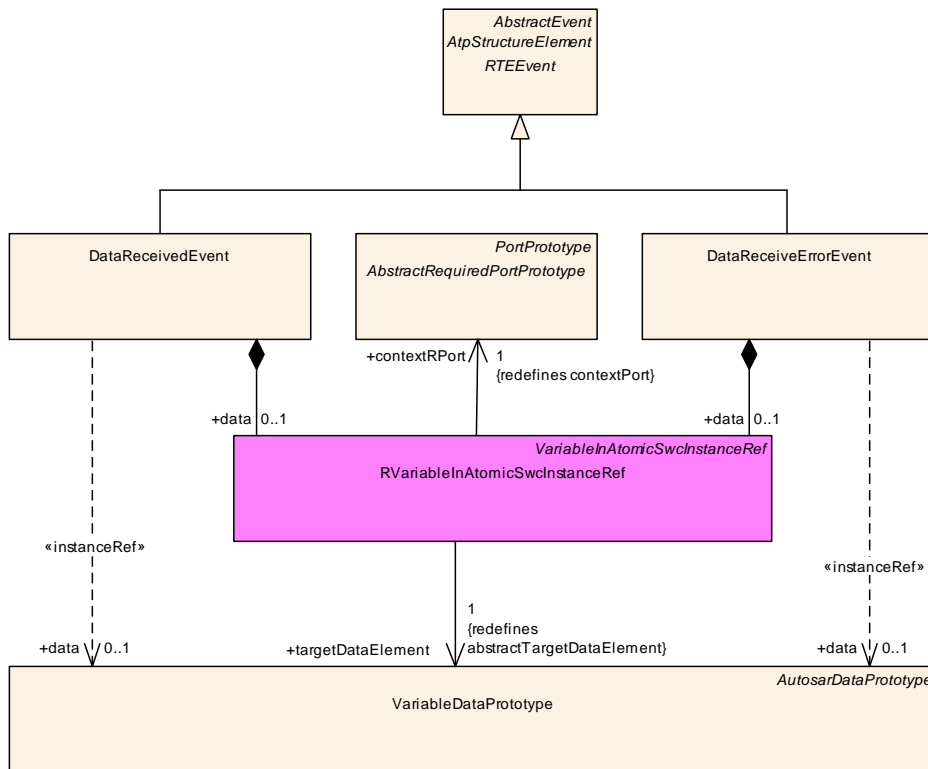

Figure D.28: Modeling of references to a *VariableDataPrototype* used in the context of an *RTEEvent*

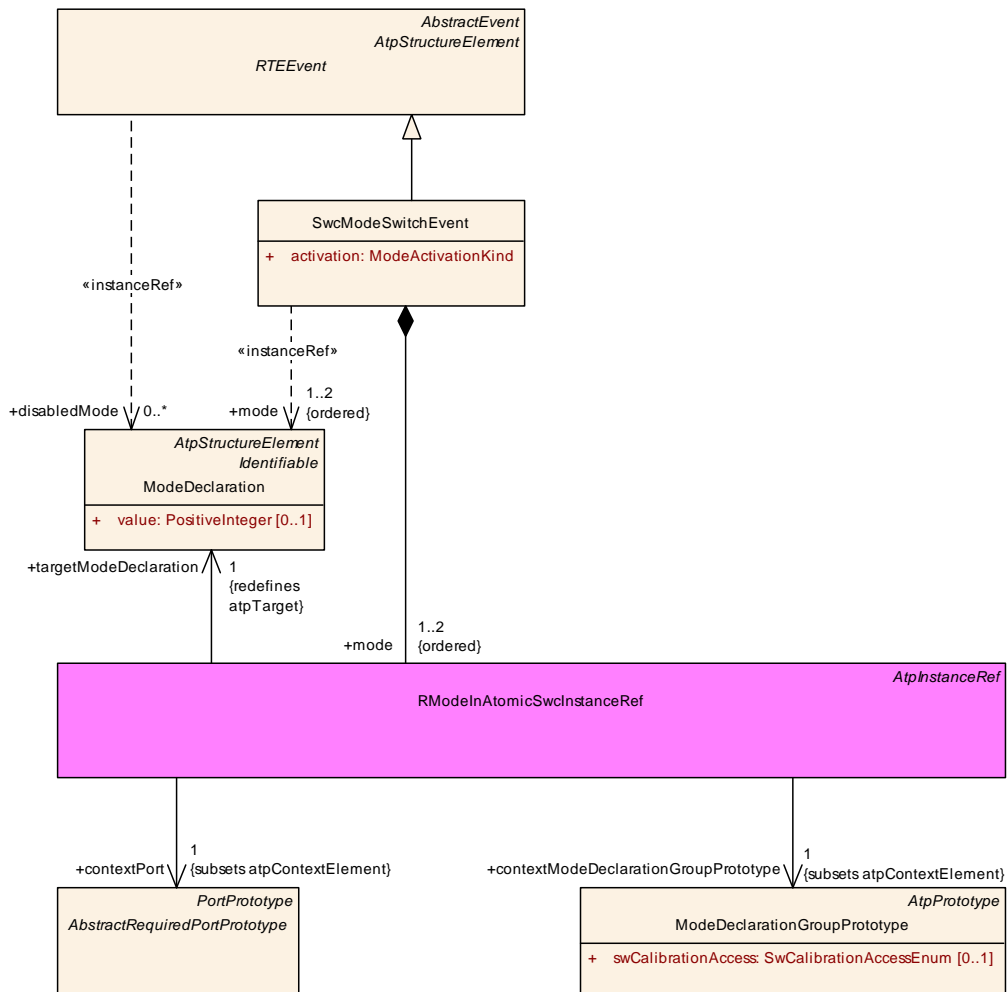

Figure D.29: Modeling of references to a **ModeDeclaration used in the context of an **RTEEvent****

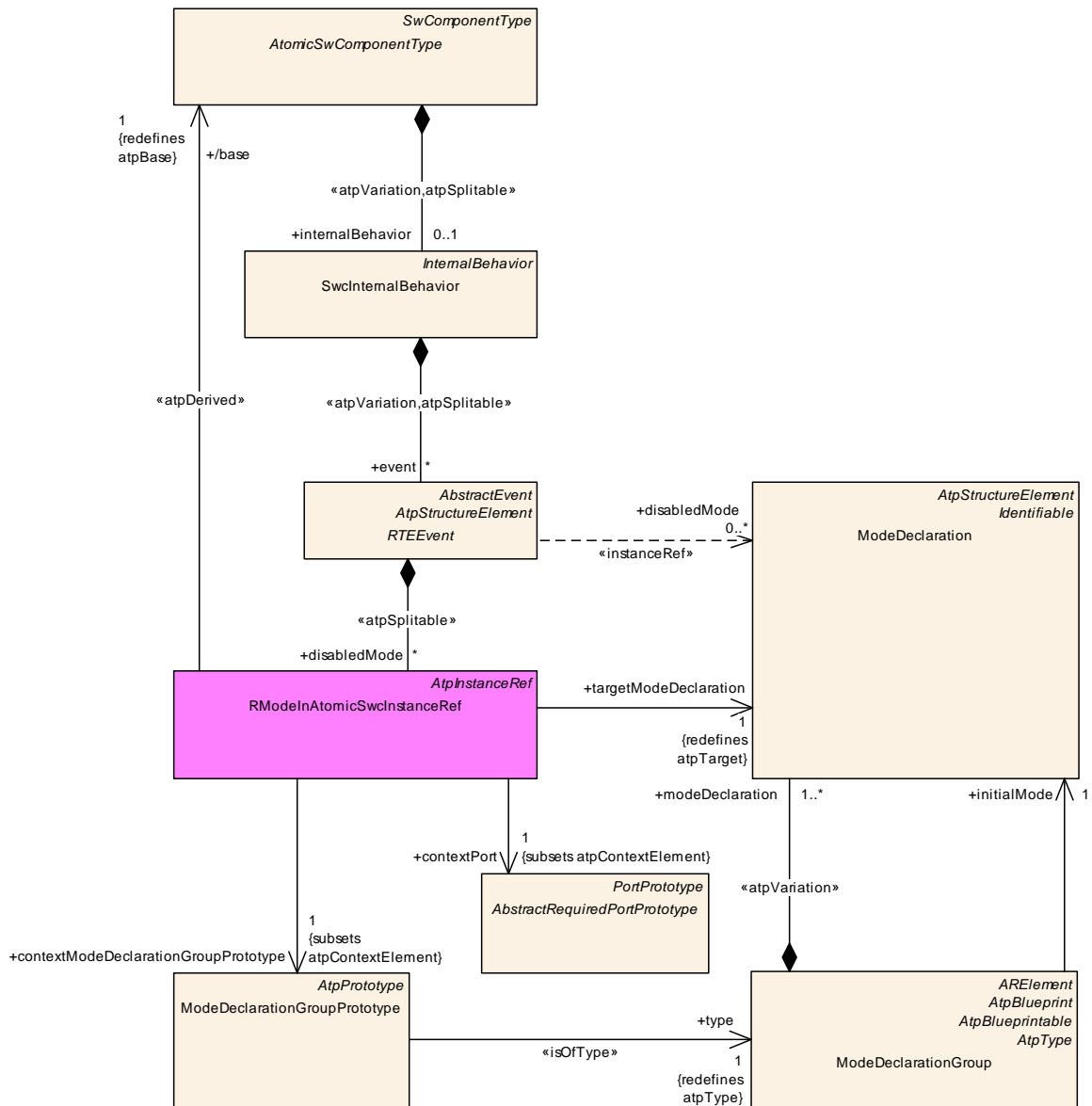

Figure D.30: Modeling of mode disabling

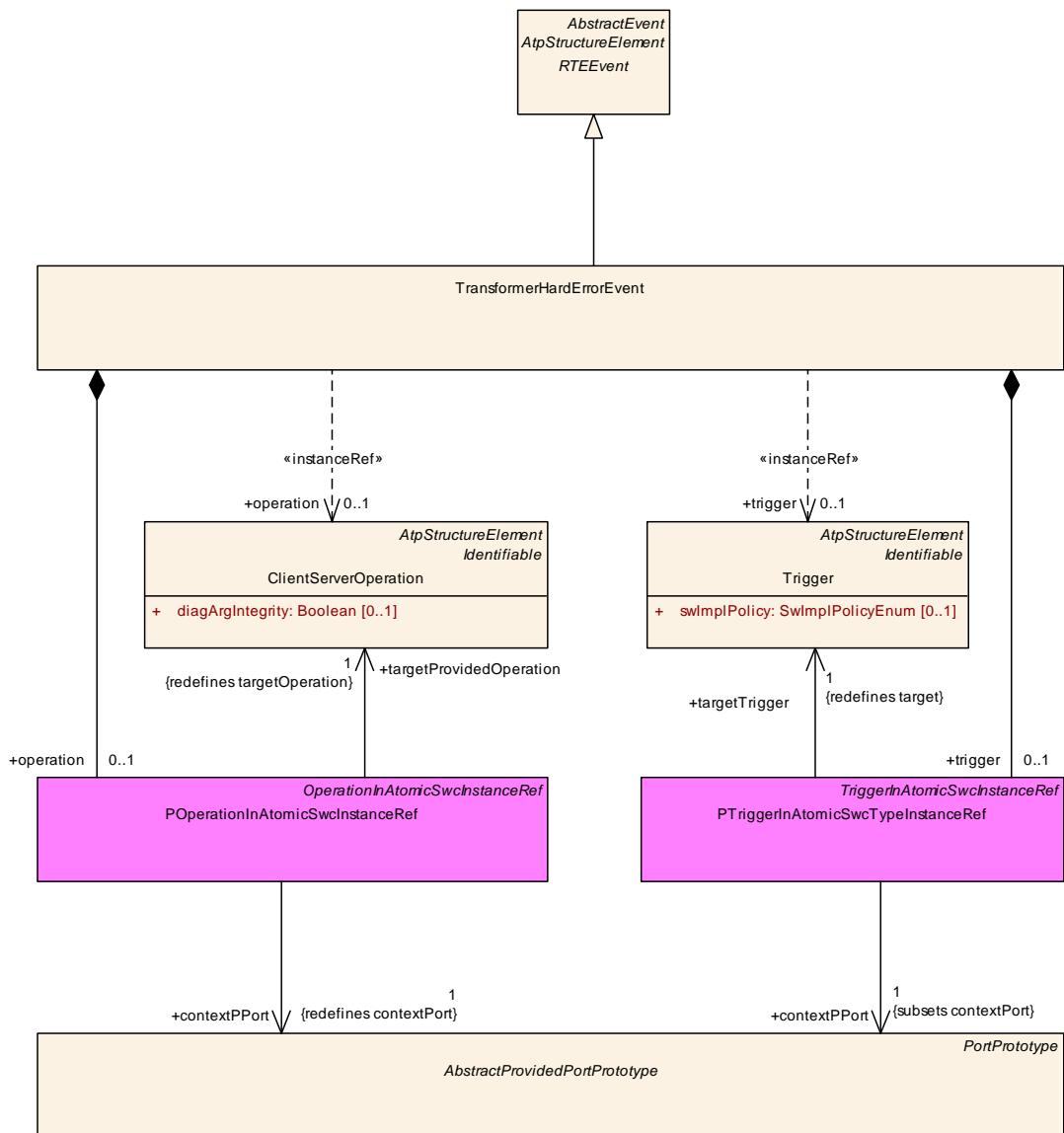

Figure D.31: Modeling of transformer error response

E Examples

E.1 Examples for the Definition of variable-size Arrays

This chapter contains some examples for the usage of variable-size arrays and its four defined use cases: Linear, square, rectangular and fully flexible.

All of these examples can be realized only using `ImplementationDataTypes` or, as shown here, starting with the definition of `ApplicationDataTypes` with corresponding `ImplementationDataTypes`.

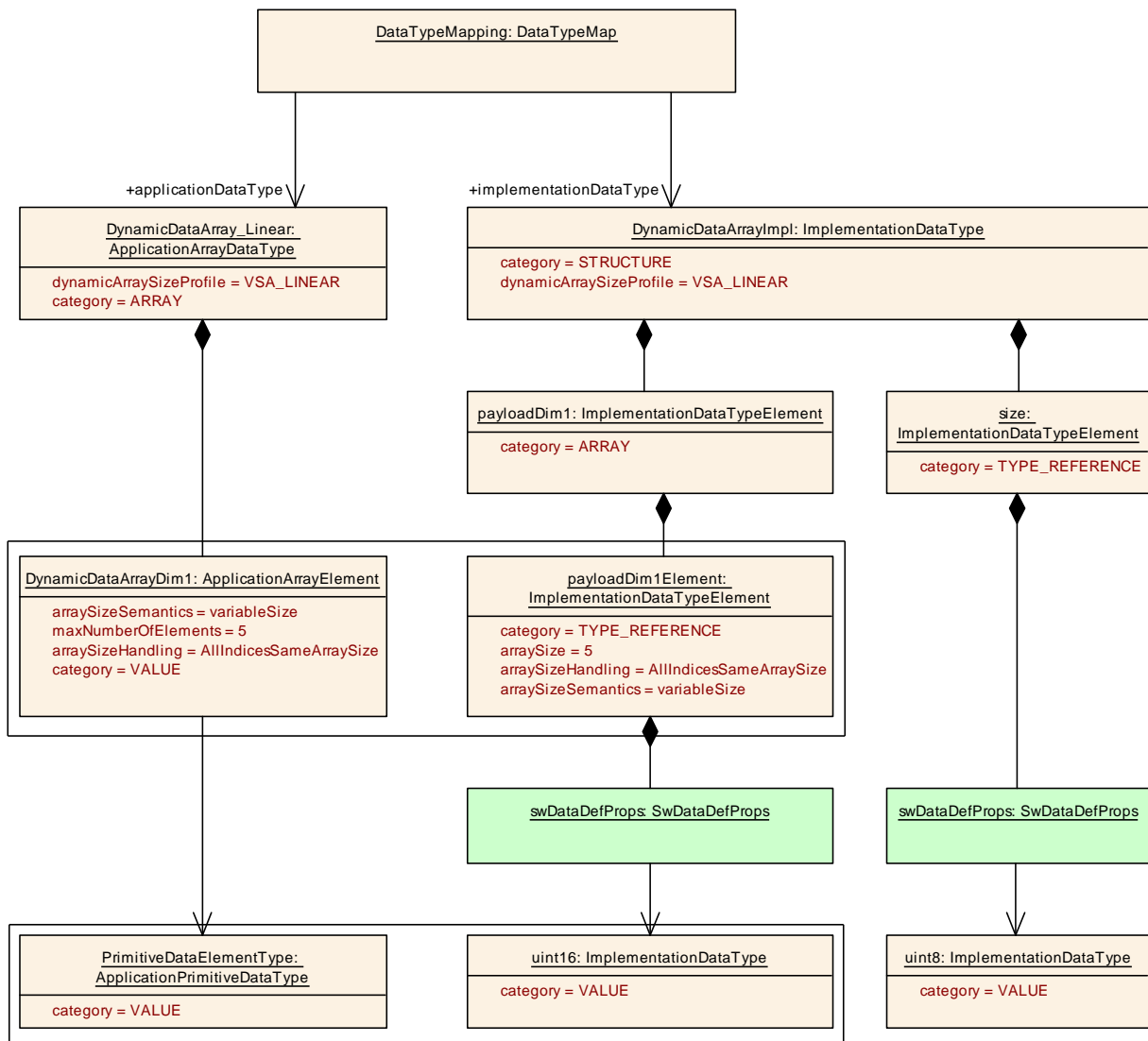

Figure E.1: Example of a linear variable size array

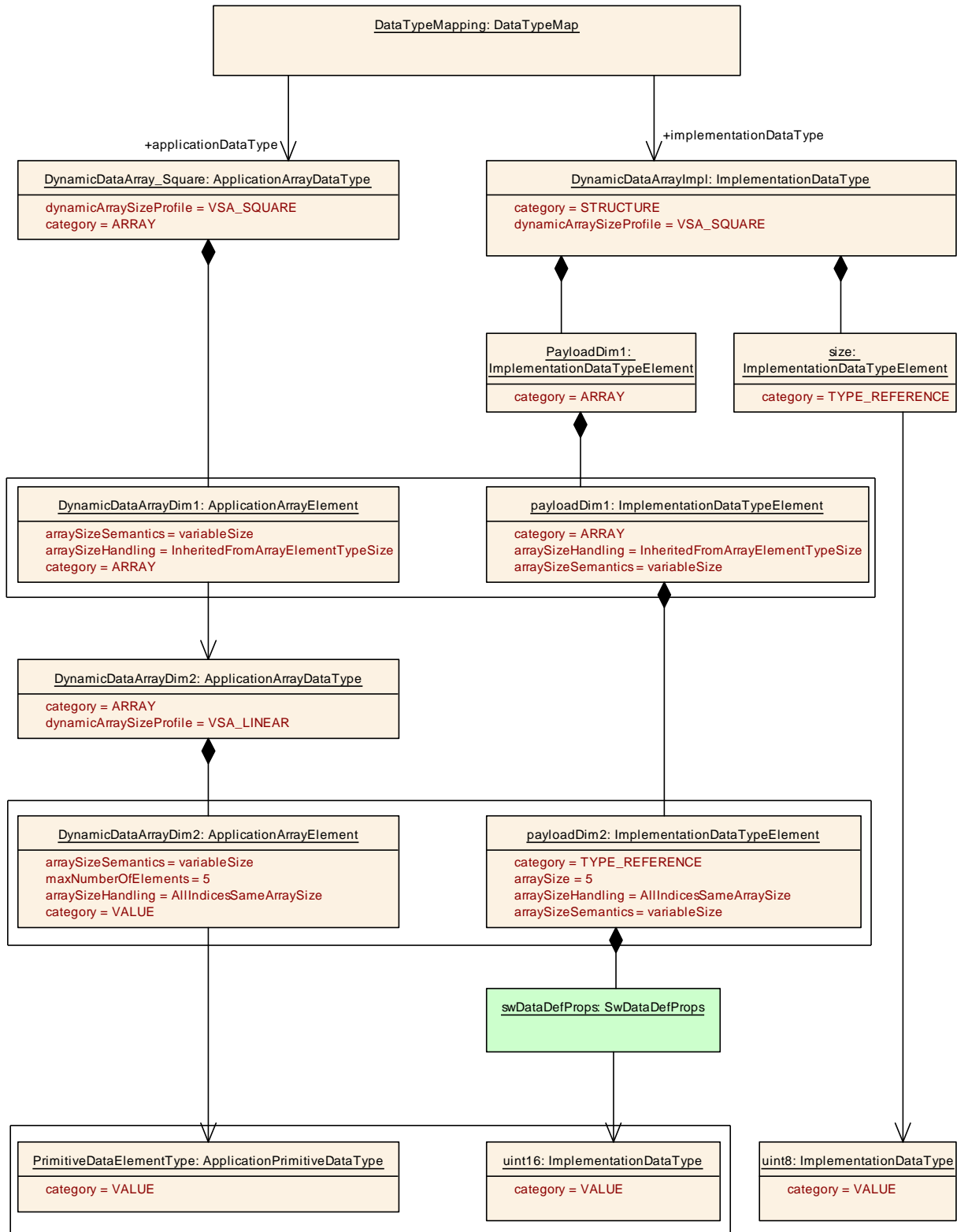

Figure E.2: Example of a square variable size array

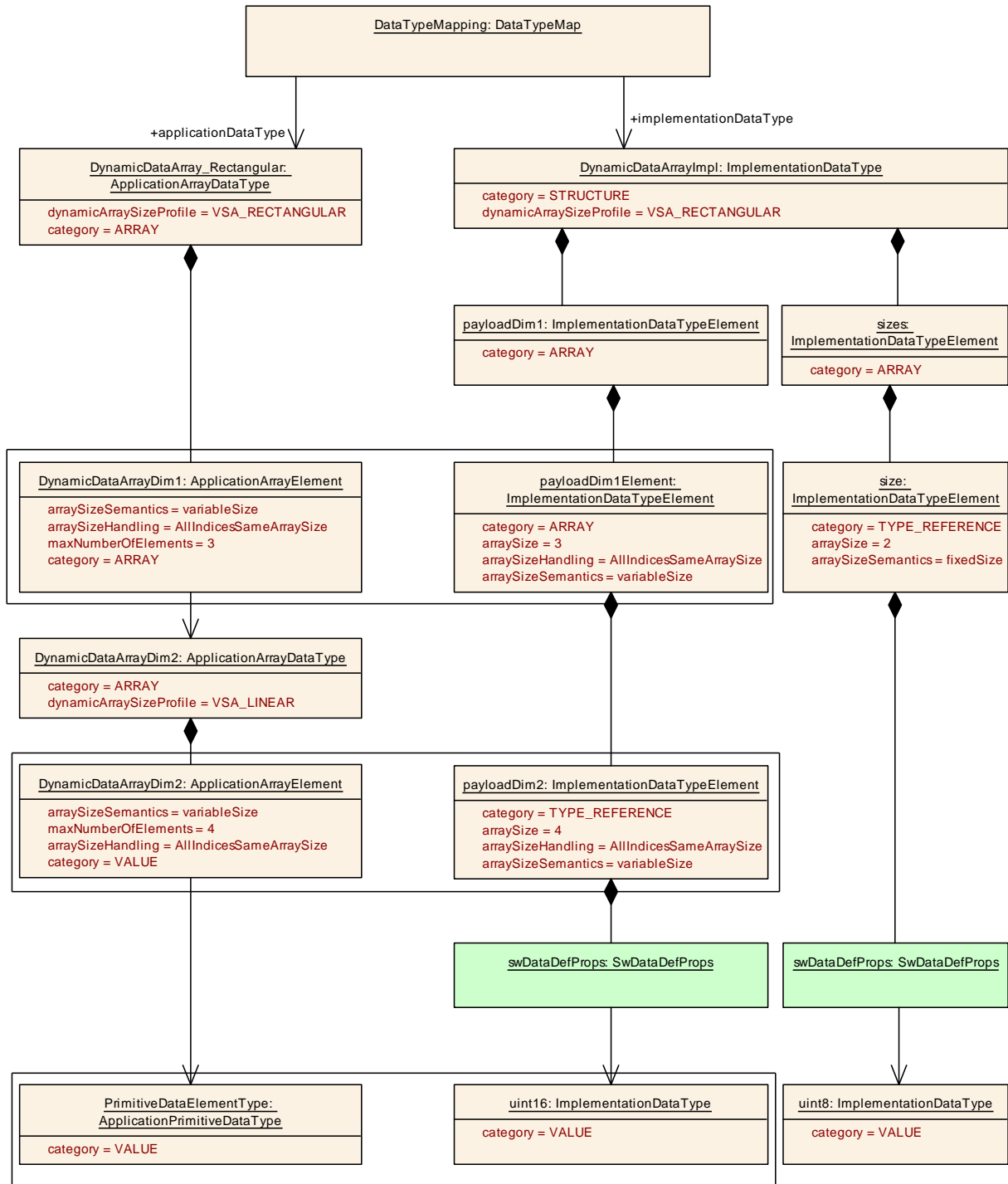

Figure E.3: Example of a rectangular variable size array

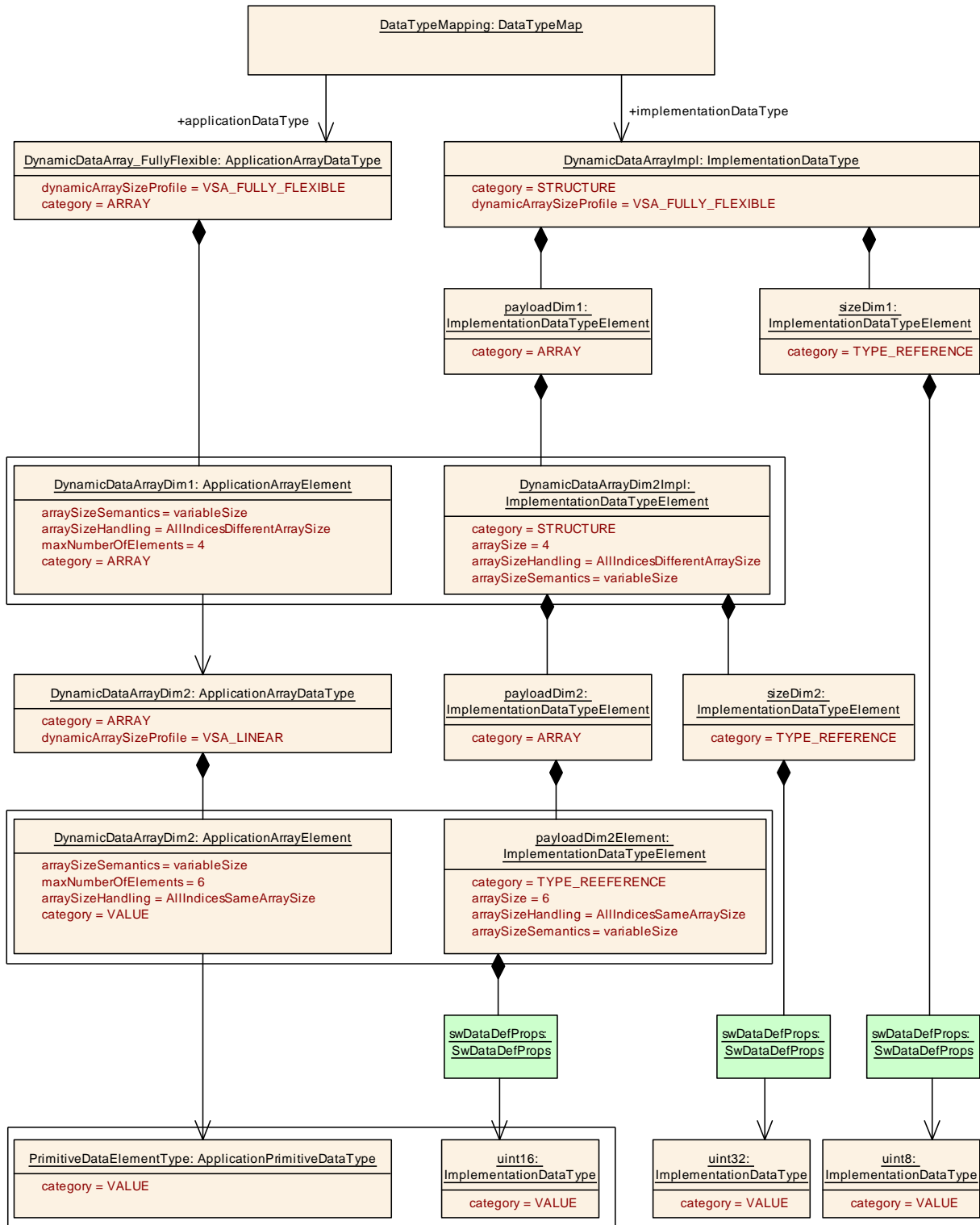

Figure E.4: Example of a fully flexible variable size array

F Mentioned Class Tables

For the sake of completeness, this chapter contains a set of class tables representing meta-classes mentioned in the context of this document but which are not contained directly in the scope of describing specific meta-model semantics.

Class	ARElement (abstract)			
Package	M2::AUTOSARTemplates::GenericStructure::GeneralTemplateClasses::ARPackage			
Note	An element that can be defined stand-alone, i.e. without being part of another element (except for packages of course).			
Base	<i>ARObject</i> , <i>CollectableElement</i> , <i>Identifiable</i> , <i>MultilanguageReferrable</i> , <i>PackageableElement</i> , <i>Referrable</i>			
Subclasses	AclObjectSet, AclOperation, AclPermission, AclRole, AliasNameSet, ApplicationPartition, <i>AutosarData Type</i> , <i>Base Type</i> , BlueprintMappingSet, BswEntryRelationshipSet, <i>BswModuleDescription</i> , <i>BswModule Entry</i> , BuildActionManifest, <i>CalibrationParameterValueSet</i> , ClientIdDefinitionSet, ClientServerInterfaceTo BswModuleEntryBlueprintMapping, Collection, <i>CompuMethod</i> , ConsistencyNeedsBlueprintSet, <i>Constant Specification</i> , <i>ConstantSpecificationMappingSet</i> , CryptoServiceCertificate, CryptoServiceKey, Crypto ServicePrimitive, CryptoServiceQueue, <i>DataConstr</i> , DataExchangePoint, DataTransformationSet, <i>Data TypeMappingSet</i> , <i>DiagnosticCommonElement</i> , DiagnosticConnection, DiagnosticContributionSet, DiagnosticMasterToSlaveEventMappingSet, Documentation, EcucDefinitionCollection, EcucDestination UriDefSet, EcucModuleConfigurationValues, EcucModuleDef, <i>EcucValueCollection</i> , <i>EndToEndProtection Set</i> , EvaluatedVariantSet, FMFeature, FMFeatureMap, FMFeatureModel, FMFeatureSelectionSet, Flat Map, GeneralPurposeConnection, HwCategory, <i>HwElement</i> , <i>HwType</i> , IPsecConfigProps, IPv6Ext HeaderFilterSet, <i>Implementation</i> , <i>InterpolationRoutineMappingSet</i> , J1939ControllerApplication, Keyword Set, LifeCycleInfoSet, LifeCycleStateDefinitionGroup, McFunction, McGroup, <i>ModeDeclarationGroup</i> , <i>ModeDeclarationMappingSet</i> , <i>PhysicalDimension</i> , <i>PhysicalDimensionMappingSet</i> , <i>PortInterface</i> , <i>Port InterfaceMappingSet</i> , PortPrototypeBlueprint, <i>PostBuildVariantCriterion</i> , <i>PostBuildVariantCriterionValue Set</i> , PredefinedVariant, <i>RapidPrototypingScenario</i> , SdgDef, SignalServiceTranslationPropsSet, Someip SdClientEventGroupTimingConfig, SomeipSdClientServiceInstanceConfig, SomeipSdServerEventGroup TimingConfig, SomeipSdServerServiceInstanceConfig, <i>SwAddrMethod</i> , <i>SwAxisType</i> , <i>SwComponent Type</i> , <i>SwRecordLayout</i> , <i>SwSystemconst</i> , <i>SwSystemconstantValueSet</i> , <i>SwcBswMapping</i> , <i>System</i> , <i>SystemSignal</i> , SystemSignalGroup, TcpOptionFilterSet, <i>TimingExtension</i> , TlvDataIdDefinitionSet, TransformationPropsSet, <i>Unit</i> , <i>UnitGroup</i> , ViewMapSet			
Attribute	Type	Mult.	Kind	Note
–	–	–	–	–

Table F.1: ARElement

Class	ARPackage			
Package	M2::AUTOSARTemplates::GenericStructure::GeneralTemplateClasses::ARPackage			
Note	AUTOSAR package, allowing to create top level packages to structure the contained ARElements. ARPackages are open sets. This means that in a file based description system multiple files can be used to partially describe the contents of a package. This is an extended version of MSR's SW-SYSTEM.			
Base	<i>ARObject</i> , <i>AtpBlueprint</i> , <i>AtpBlueprintable</i> , <i>CollectableElement</i> , <i>Identifiable</i> , <i>MultilanguageReferrable</i> , <i>Referrable</i>			
Attribute	Type	Mult.	Kind	Note
–	–	–	–	–





Class	ARPackage			
arPackage	ARPackage	*	aggr	This represents a sub package within an ARPackage, thus allowing for an unlimited package hierarchy. Stereotypes: atpSplittable; atpVariation Tags: atp.Splitkey=shortName, variationPoint.shortLabel vh.latestBindingTime=blueprintDerivationTime xml.sequenceOffset=30
element	PackageableElement	*	aggr	Elements that are part of this package Stereotypes: atpSplittable; atpVariation Tags: atp.Splitkey=shortName, variationPoint.shortLabel vh.latestBindingTime=systemDesignTime xml.sequenceOffset=20
referenceBase	ReferenceBase	*	aggr	This denotes the reference bases for the package. This is the basis for all relative references within the package. The base needs to be selected according to the base attribute within the references. Stereotypes: atpSplittable Tags: atp.Splitkey=shortLabel xml.sequenceOffset=10

Table F.2: ARPackage

Class	<<atpMixedString>> AbstractNumericalVariationPoint (abstract)			
Package	M2::AUTOSARTemplates::GenericStructure::VariantHandling::AttributeValueVariationPoints			
Note	This is an abstract NumericalValueVariationPoint. It is introduced to support the case that additional attributes are required for particular purposes.			
Base	<i>ARObject</i> , AttributeValueVariationPoint , <i>FormulaExpression</i> , SwSystemconstDependentFormula			
Subclasses	LimitValueVariationPoint, NumericalValueVariationPoint			
Attribute	Type	Mult.	Kind	Note
–	–	–	–	–

Table F.3: AbstractNumericalVariationPoint

Class	AdminData			
Package	M2::MSR::AsamHdo::AdminData			
Note	AdminData represents the ability to express administrative information for an element. This administration information is to be treated as meta-data such as revision id or state of the file. There are basically four kinds of meta-data <ul style="list-style-type: none"> • The language and/or used languages. • Revision information covering e.g. revision number, state, release date, changes. Note that this information can be given in general as well as related to a particular company. • Document meta-data specific for a company 			
Base	<i>ARObject</i>			
Attribute	Type	Mult.	Kind	Note





Class	AdminData			
docRevision (ordered)	DocRevision	*	aggr	<p>This allows to denote information about the current revision of the object.</p> <p>Note that information about previous revisions can also be logged here. The entries shall be sorted descendant by date in order to reflect the history. Therefore the most recent entry representing the current version is denoted first.</p> <p>Tags: xml.roleElement=true xml.roleWrapperElement=true xml.sequenceOffset=50 xml.typeElement=false xml.typeWrapperElement=false</p>
language	LEnum	0..1	attr	<p>This attribute specifies the master language of the document or the document fragment. The master language is the one in which the document is maintained and from which the other languages are derived from. In particular in case of inconsistencies, the information in the master language is priority.</p> <p>Tags:xml.sequenceOffset=20</p>
sdg	Sdg	*	aggr	<p>This property allows to keep special data which is not represented by the standard model. It can be utilized to keep e.g. tool specific data.</p> <p>Stereotypes: atpSplitable Tags: atp.Splitkey=sdg xml.roleElement=true xml.roleWrapperElement=true xml.sequenceOffset=60 xml.typeElement=false xml.typeWrapperElement=false</p>
usedLanguages	MultiLanguagePlainText	0..1	aggr	<p>This property specifies the languages which are provided in the document. Therefore it should only be specified in the top level admin data. For each language provided in the document there is one entry in MultiLanguagePlainText. The content of each entry can be used for illustration of the language. The used language itself depends on the language attribute in the entry.</p> <p>Tags:xml.sequenceOffset=30</p>

Table F.4: AdminData

Class	AnyInstanceRef			
Package	M2::AUTOSARTemplates::GenericStructure::GeneralTemplateClasses::AnyInstanceRef			
Note	Describes a reference to any instance in an AUTOSAR model. This is the most generic form of an instance ref. Refer to the superclass notes for more details.			
Base	ARObject , AtpInstanceRef			
Attribute	Type	Mult.	Kind	Note
base	AtpClassifier	1	ref	<p>This is the base from which navigation path begins.</p> <p>Stereotypes: atpDerived</p>
contextElement	AtpFeature	*	ref	<p>This is one step in the navigation path specified by the instance ref.</p>





Class	AnyInstanceRef			
target	AtpFeature	1	ref	This is the target of the instance ref.

Table F.5: AnyInstanceRef

Class	ApplicationCompositeElementInPortInterfaceInstanceRef			
Package	M2::AUTOSARTemplates::SWComponentTemplate::PortInterface::InstanceRefs			
Note				
Base	ARObject, AtpInstanceRef			
Attribute	Type	Mult.	Kind	Note
base	DataInterface	1	ref	This represents the SenderReceiverInterface that acts as the base in this InstanceRef definition Stereotypes: atpDerived Tags: xml.sequenceOffset=10
contextData Prototype	ApplicationCompositeElementDataPrototype	*	ref	This represents a context ApplicationCompositeData Prototype Tags: xml.sequenceOffset=20
rootData Prototype	AutosarDataPrototype	1	ref	This refers to the dataPrototype which is typed by the ApplicationDatatype in which which the target can be found. Tags: xml.sequenceOffset=15
targetData Prototype	ApplicationCompositeElementDataPrototype	1	ref	This represents the referenced ApplicationComposite DataPrototype. Tags: xml.sequenceOffset=30

Table F.6: ApplicationCompositeElementInPortInterfaceInstanceRef

Class	AtpInstanceRef (abstract)			
Package	M2::AUTOSARTemplates::GenericStructure::AbstractStructure			
Note	An M0 instance of a classifier may be represented as a tree rooted at that instance, where under each node come the sub-trees representing the instances which act as features under that node. An instance ref specifies a navigation path from any M0 tree-instance of the base (which is a classifier) to a leaf (which is an instance of the target).			
Base	ARObject			
Subclasses	AnyInstanceRef , ApplicationCompositeElementInPortInterfaceInstanceRef , ComponentInCompositionInstanceRef , ComponentInSystemInstanceRef , DataPrototypeInPortInterfaceInstanceRef , DataPrototypeInSystemInstanceRef , InnerDataPrototypeGroupInCompositionInstanceRef , InnerPortGroupInCompositionInstanceRef , InnerRunnableEntityGroupInCompositionInstanceRef , InstanceEventInCompositionInstanceRef , ModeGroupInAtomicSwcInstanceRef , ModelInBswModuleDescriptionInstanceRef , ModelInSwcInstanceRef , OperationArgumentInComponentInstanceRef , OperationInAtomicSwcInstanceRef , OperationInSystemInstanceRef , PModelInSystemInstanceRef , ParameterInAtomicSWCTypeInstanceRef , PortGroupInSystemInstanceRef , PortInCompositionTypeInstanceRef , RModelInAtomicSwcInstanceRef , RteEventInEcuInstanceRef , RunnableEntityInCompositionInstanceRef , SwcServiceDependencyInSystemInstanceRef , TriggerInAtomicSwcInstanceRef , TriggerInSystemInstanceRef , VariableAccessInEcuInstanceRef , VariableDataPrototypeInCompositionInstanceRef , VariableDataPrototypeInSystemInstanceRef , VariableInAtomicSWCTypeInstanceRef , VariableInAtomicSwcInstanceRef , VariableInComponentInstanceRef			
Attribute	Type	Mult.	Kind	Note





Class	AtpInstanceRef (abstract)			
atpBase	AtpClassifier	1	ref	This is the base from which the navigation path starts. Stereotypes: atpAbstract; atpDerived
atpContext Element (ordered)	AtpPrototype	*	ref	This is one particular step in the navigation path. Stereotypes: atpAbstract
atpTarget	AtpFeature	1	ref	This is the target of the instance ref. In other words it is the terminal of the navigation path. Stereotypes: atpAbstract

Table F.7: AtpInstanceRef

Enumeration	BindingTimeEnum
Package	M2::AUTOSARTemplates::GenericStructure::VariantHandling
Note	This enumerator specifies the applicable binding times for the pre build variation points.
Literal	Description
codeGeneration Time	<ul style="list-style-type: none"> Coding by hand, based on requirements document. Tool based code generation, e.g. from a model. The model may contain variants. Only code for the selected variant(s) is actually generated. Tags: atp.EnumerationLiteralIndex=0
linkTime	Configure what is included in object code, and what is omitted Based on which variant(s) are selected E.g. for modules that are delivered as object code (as opposed to those that are delivered as source code) Tags: atp.EnumerationLiteralIndex=1
preCompileTime	This is typically the C-Preprocessor. Exclude parts of the code from the compilation process, e.g., because they are not required for the selected variant, because they are incompatible with the selected variant, because they require resources that are not present in the selected variant. Object code is only generated for the selected variant(s). The code that is excluded at this stage code will not be available at later stages. Tags: atp.EnumerationLiteralIndex=2
systemDesignTime	<ul style="list-style-type: none"> Designing the VFB. Software Component types (PortInterfaces). SWC Prototypes and the Connections between SWCprototypes. Designing the Topology ECUs and interconnecting Networks Designing the Communication Matrix and Data Mapping Tags: atp.EnumerationLiteralIndex=3

Table F.8: BindingTimeEnum

Class	BswImplementation
Package	M2::AUTOSARTemplates::BswModuleTemplate::BswImplementation





Class		BswImplementation		
Note	<p>Contains the implementation specific information in addition to the generic specification (BswModule Description and BswBehavior). It is possible to have several different BswImplementations referring to the same BswBehavior.</p> <p>Tags:atp.recommendedPackage=BswImplementations</p>			
Base	<p>ARElement, ARObject, CollectableElement, Identifiable, Implementation, MultilanguageReferrable, PackageableElement, Referrable</p>			
Attribute	Type	Mult.	Kind	Note
arReleaseVersion	RevisionLabelString	1	attr	Version of the AUTOSAR Release on which this implementation is based. The numbering contains three levels (major, minor, revision) which are defined by AUTOSAR.
behavior	BswInternalBehavior	1	ref	<p>The behavior of this implementation.</p> <p>This relation is made as an association because</p> <ul style="list-style-type: none"> it follows the pattern of the SWCT since ARElement cannot be splitted, but we want supply the implementation later, the BswImplementation is not aggregated in BswBehavior
preconfiguredConfiguration	EcucModuleConfigurationValues	*	ref	<p>Reference to the set of preconfigured (i.e. fixed) configuration values for this BswImplementation.</p> <p>If the BswImplementation represents a cluster of several modules, more than one EcucModuleConfigurationValues element can be referred (at most one per module), otherwise at most one such element can be referred.</p> <p>Tags:xml.roleWrapperElement=true</p>
recommendedConfiguration	EcucModuleConfigurationValues	*	ref	Reference to one or more sets of recommended configuration values for this module or module cluster.
vendorApiInfix	Identifier	0..1	attr	<p>In driver modules which can be instantiated several times on a single ECU, SRS_BSW_00347 requires that the names of files, APIs, published parameters and memory allocation keywords are extended by the vendorId and a vendor specific name. This parameter is used to specify the vendor specific name. In total, the implementation specific API name is generated as follows: <Module Name>_<vendorId>_<vendorApiInfix>_<API name from SWS>.</p> <p>E.g. assuming that the vendorId of the implementer is 123 and the implementer chose a vendorApiInfix of "v11r456" an API name Can_Write defined in the SWS will translate to Can_123_v11r456_Write.</p> <p>This attribute is mandatory for all modules with upper multiplicity > 1. It shall not be used for modules with upper multiplicity =1.</p> <p>See also SWS_BSW_00102.</p>
vendorSpecificModuleDef	EcucModuleDef	*	ref	<p>Reference to</p> <ul style="list-style-type: none"> the vendor specific EcucModuleDef used in this BswImplementation if it represents a single module





Class	BswImplementation			
				<p style="text-align: center;">△</p> <ul style="list-style-type: none"> several EcucModuleDefs used in this Bsw Implementation if it represents a cluster of modules one or no EcucModuleDefs used in this Bsw Implementation if it represents a library <p>Tags:xml.roleWrapperElement=true</p>

Table F.9: BswImplementation

Class	BswModuleDescription			
Package	M2::AUTOSARTemplates::BswModuleTemplate::BswOverview			
Note	Root element for the description of a single BSW module or BSW cluster. In case it describes a BSW module, the short name of this element equals the name of the BSW module. Tags: atp.recommendedPackage=BswModuleDescriptions			
Base	ARElement , ARObject , AtpBlueprint , AtpBlueprintable , AtpClassifier , AtpFeature , AtpStructureElement , CollectableElement , Identifiable , MultilanguageReferrable , PackageableElement , Referrable			
Attribute	Type	Mult.	Kind	Note
bswModule Dependency	BswModuleDependency	*	aggr	Describes the dependency to another BSW module. Stereotypes: atpSplitable; atpVariation Tags: atp.Splitkey=shortName, variationPoint.shortLabel vh.latestBindingTime=preCompileTime xml.sequenceOffset=20
bswModule Documentation	SwComponent Documentation	0..1	aggr	This adds a documentation to the BSW module. Stereotypes: atpSplitable; atpVariation Tags: atp.Splitkey=bswModuleDocumentation, variationPoint.shortLabel vh.latestBindingTime=preCompileTime xml.sequenceOffset=6
expectedEntry	BswModuleEntry	*	ref	Indicates an entry which is required by this module. Replacement of outgoingCallback / requiredEntry. Stereotypes: atpSplitable; atpVariation Tags: atp.Splitkey=expectedEntry, variationPoint.shortLabel vh.latestBindingTime=preCompileTime
implemented Entry	BswModuleEntry	*	ref	Specifies an entry provided by this module which can be called by other modules. This includes "main" functions, interrupt routines, and callbacks. Replacement of providedEntry / expectedCallback. Stereotypes: atpSplitable; atpVariation Tags: atp.Splitkey=implementedEntry, variationPoint.shortLabel vh.latestBindingTime=preCompileTime





Class	BswModuleDescription			
internalBehavior	BswInternalBehavior	*	aggr	<p>The various BswInternalBehaviors associated with a BswModuleDescription can be distributed over several physical files. Therefore the aggregation is <<atp Splitable>>.</p> <p>Stereotypes: atpSplitable Tags: atp.Splitkey=shortName xml.sequenceOffset=65</p>
moduleId	PositiveInteger	0..1	attr	<p>Refers to the BSW Module Identifier defined by the AUTOSAR standard. For non-standardized modules, a proprietary identifier can be optionally chosen.</p> <p>Tags:xml.sequenceOffset=5</p>
providedClientServerEntry	BswModuleClientServerEntry	*	aggr	<p>Specifies that this module provides a client server entry which can be called from another partition or core. This entry is declared locally to this context and will be connected to the requiredClientServerEntry of another or the same module via the configuration of the BSW Scheduler.</p> <p>Stereotypes: atpSplitable; atpVariation Tags: atp.Splitkey=shortName, variationPoint.shortLabel vh.latestBindingTime=preCompileTime xml.sequenceOffset=45</p>
providedData	VariableDataPrototype	*	aggr	<p>Specifies a data prototype provided by this module in order to be read from another partition or core. The providedData is declared locally to this context and will be connected to the requiredData of another or the same module via the configuration of the BSW Scheduler.</p> <p>Stereotypes: atpSplitable; atpVariation Tags: atp.Splitkey=shortName, variationPoint.shortLabel vh.latestBindingTime=preCompileTime xml.sequenceOffset=55</p>
providedModeGroup	ModeDeclarationGroupPrototype	*	aggr	<p>A set of modes which is owned and provided by this module or cluster. It can be connected to the required ModeGroups of other modules or clusters via the configuration of the BswScheduler. It can also be synchronized with modes provided via ports by an associated ServiceSwComponentType, EcuAbstractionSwComponentType or ComplexDeviceDriverSwComponentType.</p> <p>Stereotypes: atpSplitable; atpVariation Tags: atp.Splitkey=shortName, variationPoint.shortLabel vh.latestBindingTime=preCompileTime xml.sequenceOffset=25</p>
releasedTrigger	Trigger	*	aggr	<p>A Trigger released by this module or cluster. It can be connected to the requiredTriggers of other modules or clusters via the configuration of the BswScheduler. It can also be synchronized with Triggers provided via ports by an associated ServiceSwComponentType, EcuAbstractionSwComponentType or ComplexDeviceDriverSwComponentType.</p>





Class	BswModuleDescription			
				<p style="text-align: center;">△</p> Stereotypes: atpSplitable; atpVariation Tags: atp.Splitkey=shortName, variationPoint.shortLabel vh.latestBindingTime=preCompileTime xml.sequenceOffset=35
requiredClientServerEntry	BswModuleClientServerEntry	*	aggr	Specifies that this module requires a client server entry which can be implemented on another partition or core. This entry is declared locally to this context and will be connected to the providedClientServerEntry of another or the same module via the configuration of the BSW Scheduler. Stereotypes: atpSplitable; atpVariation Tags: atp.Splitkey=shortName, variationPoint.shortLabel vh.latestBindingTime=preCompileTime xml.sequenceOffset=50
requiredData	VariableDataPrototype	*	aggr	Specifies a data prototype required by this module in order to be provided from another partition or core. The required Data is declared locally to this context and will be connected to the providedData of another or the same module via the configuration of the BswScheduler. Stereotypes: atpSplitable; atpVariation Tags: atp.Splitkey=shortName, variationPoint.shortLabel vh.latestBindingTime=preCompileTime xml.sequenceOffset=60
requiredModeGroup	ModeDeclarationGroupPrototype	*	aggr	Specifies that this module or cluster depends on a certain mode group. The requiredModeGroup is local to this context and will be connected to the providedModeGroup of another module or cluster via the configuration of the BswScheduler. Stereotypes: atpSplitable; atpVariation Tags: atp.Splitkey=shortName, variationPoint.shortLabel vh.latestBindingTime=preCompileTime xml.sequenceOffset=30
requiredTrigger	Trigger	*	aggr	Specifies that this module or cluster reacts upon an external trigger. This requiredTrigger is declared locally to this context and will be connected to the providedTrigger of another module or cluster via the configuration of the BswScheduler. Stereotypes: atpSplitable; atpVariation Tags: atp.Splitkey=shortName, variationPoint.shortLabel vh.latestBindingTime=preCompileTime xml.sequenceOffset=40

Table F.10: BswModuleDescription

Class	BswModuleEntry
Package	M2::AUTOSARTemplates::BswModuleTemplate::BswInterfaces





Class	BswModuleEntry			
Note	This class represents a single API entry (C-function prototype) into the BSW module or cluster. The name of the C-function is equal to the short name of this element with one exception: In case of multiple instances of a module on the same CPU, special rules for "infixes" apply, see description of class BswImplementation. Tags: atp.recommendedPackage=BswModuleEntries			
Base	ARElement , ARObject , AtpBlueprint , AtpBlueprintable , CollectableElement , Identifiable , MultilanguageReferrable , PackageableElement , Referrable			
Attribute	Type	Mult.	Kind	Note
argument (ordered)	SwServiceArg	*	aggr	An argument belonging to this BswModuleEntry. Stereotypes: atpVariation Tags: vh.latestBindingTime=blueprintDerivationTime xml.sequenceOffset=45
bswEntryKind	BswEntryKindEnum	0..1	attr	This describes whether the entry is concrete or abstract. If the attribute is missing the entry is considered as concrete. Tags: xml.sequenceOffset=40
callType	BswCallType	1	attr	The type of call associated with this service. Tags: xml.sequenceOffset=25
execution Context	BswExecutionContext	1	attr	Specifies the execution context which is required (in case of entries into this module) or guaranteed (in case of entries called from this module) for this service. Tags: xml.sequenceOffset=30
function Prototype Emitter	NameToken	0..1	attr	This attribute is used to control the generation of function prototypes. If set to "RTE", the RTE generates the function prototypes in the Module Interlink Header File.
isReentrant	Boolean	1	attr	Reentrancy from the viewpoint of function callers: <ul style="list-style-type: none"> • True: Enables the service to be invoked again, before the service has finished. • False: It is prohibited to invoke the service again before is has finished. Tags: xml.sequenceOffset=15
isSynchronous	Boolean	1	attr	Synchronicity from the viewpoint of function callers: <ul style="list-style-type: none"> • True: This calls a synchronous service, i.e. the service is completed when the call returns. • False: The service (on semantical level) may not be complete when the call returns. Tags: xml.sequenceOffset=20
returnType	SwServiceArg	0..1	aggr	The return type belonging to this bswModuleEntry. Tags: xml.sequenceOffset=40
role	Identifier	0..1	attr	Specifies the role of the entry in the given context. It shall be equal to the standardized name of the service call, especially in cases where no ServiceIdentifier is specified, e.g. for callbacks. Note that the ShortName is not always sufficient because it maybe vendor specific (e.g. for callbacks which can have more than one instance). Tags: xml.sequenceOffset=10





Class		BswModuleEntry		
serviceId	PositiveInteger	0..1	attr	Refers to the service identifier of the Standardized Interfaces of AUTOSAR basic software. For non-standardized interfaces, it can optionally be used for proprietary identification. Tags: xml.sequenceOffset=5
swServiceImplPolicy	SwServiceImplPolicyEnum	1	attr	Denotes the implementation policy as a standard function call, inline function or macro. This has to be specified on interface level because it determines the signature of the call. Tags: xml.sequenceOffset=35

Table F.11: BswModuleEntry

Class		BswSchedulableEntity		
Package	M2::AUTOSARTemplates::BswModuleTemplate::BswBehavior			
Note	BSW module entity, which is designed for control by the BSW Scheduler. It may for example implement a so-called "main" function.			
Base	<i>ARObject</i> , <i>BswModuleEntry</i> , <i>ExecutableEntity</i> , <i>Identifiable</i> , <i>MultilanguageReferrable</i> , <i>Referrable</i>			
Attribute	Type	Mult.	Kind	Note
–	–	–	–	–

Table F.12: BswSchedulableEntity

Class		BswServiceDependency		
Package	M2::AUTOSARTemplates::BswModuleTemplate::BswBehavior			
Note	Specialization of ServiceDependency in the context of an BswInternalBehavior. It allows to associate BswModuleEntries and data defined for a BSW module or cluster to a given ServiceNeeds element.			
Base	<i>ARObject</i> , <i>ServiceDependency</i>			
Attribute	Type	Mult.	Kind	Note
assignedData	RoleBasedDataAssignment	*	aggr	Defines the role of an associated data object (owned by this module or cluster) in the context of the ServiceNeeds element. Stereotypes: atpVariation Tags: vh.latestBindingTime=preCompileTime
assignedEntryRole	RoleBasedBswModuleEntryAssignment	*	aggr	Defines the role of an associated BswModuleEntry in the context of the ServiceNeeds element. Stereotypes: atpSplittable; atpVariation Tags: atp.Splitkey=assignedEntryRole, variationPoint.shortLabel vh.latestBindingTime=preCompileTime
ident	BswServiceDependencyIdent	0..1	aggr	This adds the ability to become referrable to BswServiceDependency. Tags: atp.Status=shallBecomeMandatory xml.sequenceOffset=-100
serviceNeeds	ServiceNeeds	1	aggr	The associated ServiceNeeds.

Table F.13: BswServiceDependency

Class	CompuConstFormulaContent			
Package	M2::MSR::AsamHdo::ComputationMethod			
Note	This meta-class represents the fact that the constant value of the computation method is represented by a variation point. This difference is due to compatibility with ASAM HDO.			
Base	<i>ARObject</i> , <i>CompuConstContent</i>			
Attribute	Type	Mult.	Kind	Note
vf	Numerical	1	attr	Value calculated via a system constant. This element is included in every case where parameters should be generated from numerical values during compile time (not runtime!). Thus for example, the influence of the cylinder number on conversion formulae can be introduced in a repeatable manner. Stereotypes: atpVariation Tags: vh.latestBindingTime=codeGenerationTime xml.sequenceOffset=30

Table F.14: CompuConstFormulaContent

Class	DataMapping (abstract)			
Package	M2::AUTOSARTemplates::SystemTemplate::DataMapping			
Note	Mapping of port elements (data elements and parameters) to frames and signals.			
Base	<i>ARObject</i>			
Subclasses	ClientServerToSignalMapping, SenderReceiverCompositeElementToSignalMapping, SenderReceiverToSignalGroupMapping, SenderReceiverToSignalMapping , TriggerToSignalMapping			
Attribute	Type	Mult.	Kind	Note
communication Direction	Communication DirectionType	0..1	attr	This attribute controls the direction into which the mapped SystemSignal is communicated with respect to the kind of PortPrototype used as the context element of the Data Mapping.
introduction	DocumentationBlock	0..1	aggr	This represents introductory documentation about the data mapping.

Table F.15: DataMapping

Class	Describable (abstract)			
Package	M2::AUTOSARTemplates::GenericStructure::GeneralTemplateClasses::Identifiable			
Note	This meta-class represents the ability to add a descriptive documentation to non identifiable elements.			
Base	<i>ARObject</i>			
Subclasses	CyclicTiming, EventControlledTiming, HwElementConnector, HwPinConnector, HwPinGroupConnector, I PduTiming, Ipv4DhcpServerConfiguration, Ipv6DhcpServerConfiguration, PncMapping, Socket Connection, TransformationComSpecProps , TransformationDescription , TransformationISignalProps			
Attribute	Type	Mult.	Kind	Note
adminData	AdminData	0..1	aggr	This represents the administrative data for the describable object. Tags: xml.sequenceOffset=-20





Class	Describable (abstract)			
category	CategoryString	0..1	attr	The category is a keyword that specializes the semantics of the Describable. It affects the expected existence of attributes and the applicability of constraints. Tags: xml.sequenceOffset=-50
desc	MultiLanguageOverviewParagraph	0..1	aggr	This represents a general but brief (one paragraph) description what the object in question is about. It is only one paragraph! Desc is intended to be collected into overview tables. This property helps a human reader to identify the object in question. More elaborate documentation, (in particular how the object is built or used) should go to "introduction". Tags: xml.sequenceOffset=-60
introduction	DocumentationBlock	0..1	aggr	This represents more information about how the object in question is built or is used. Therefore it is a DocumentationBlock. Tags: xml.sequenceOffset=-30

Table F.16: Describable

Class	<<atpMixed>> DocumentationBlock			
Package	M2::MSR::Documentation::BlockElements			
Note	This class represents a documentation block. It is made of basic text structure elements which can be displayed in a table cell.			
Base	<i>ARObject</i>			
Attribute	Type	Mult.	Kind	Note
defList	DefList	0..1	aggr	This represents a definition list in the documentation block. Stereotypes: atpVariation Tags: vh.latestBindingTime=postBuild xml.sequenceOffset=40
figure	MIFigure	0..1	aggr	This represents a figure in the documentation block. Stereotypes: atpVariation Tags: vh.latestBindingTime=postBuild xml.sequenceOffset=70
formula	MIFormula	0..1	aggr	This is a formula in the definition block. Stereotypes: atpVariation Tags: vh.latestBindingTime=postBuild xml.sequenceOffset=60
labeledList	LabeledList	0..1	aggr	This represents a labeled list. Stereotypes: atpVariation Tags: vh.latestBindingTime=postBuild xml.sequenceOffset=50





Class	<<atpMixed>> DocumentationBlock			
list	List	0..1	aggr	This represents numbered or unnumbered list. Stereotypes: atpVariation Tags: vh.latestBindingTime=postBuild xml.sequenceOffset=30
msrQueryP2	MsrQueryP2	0..1	aggr	This represents automatically contributed contents provided by an msrquery in the context of Documentation Block.
note	Note	0..1	aggr	This represents a note in the text flow. Stereotypes: atpVariation Tags: vh.latestBindingTime=postBuild xml.sequenceOffset=80
p	MultiLanguage Paragraph	0..1	aggr	This is one particular paragraph. Stereotypes: atpVariation Tags: vh.latestBindingTime=postBuild xml.sequenceOffset=10
structuredReq	StructuredReq	0..1	aggr	This aggregation supports structured requirements embedded in a documentation block. Stereotypes: atpVariation Tags: vh.latestBindingTime=postBuild xml.sequenceOffset=100
trace	TraceableText	0..1	aggr	This represents traceable text in the documentation block. This allows to specify requirements/constraints in any documentation block. The kind of the trace is specified in the category. Stereotypes: atpVariation Tags: vh.latestBindingTime=postBuild xml.sequenceOffset=90
verbatim	MultiLanguageVerbatim	0..1	aggr	This represents one particular verbatim text. Stereotypes: atpVariation Tags: vh.latestBindingTime=postBuild xml.sequenceOffset=20

Table F.17: DocumentationBlock

Class	EcuInstance			
Package	M2::AUTOSARTemplates::SystemTemplate::Fibex::FibexCore::CoreTopology			
Note	ECUInstances are used to define the ECUs used in the topology. The type of the ECU is defined by a reference to an ECU specified with the ECU resource description. Tags: atp.recommendedPackage=EcuInstances			
Base	ARObject, CollectableElement, FibexElement, Identifiable , MultilanguageReferrable , PackageableElement , Referrable			
Attribute	Type	Mult.	Kind	Note





Class	EcuInstance			
associatedComIPduGroup	ISignalIPduGroup	*	ref	<p>With this reference it is possible to identify which ISignalIPduGroups are applicable for which Communication Connector/ ECU.</p> <p>Only top level ISignalIPduGroups shall be referenced by an EcuInstance. If an ISignalIPduGroup contains other ISignalIPduGroups than these contained ISignalIPdu Groups shall not be referenced by the EcuInstance. Contained ISignalIPduGroups are associated to an Ecu Instance via the top level ISignalIPduGroup.</p>
associatedConsumedProvidedServiceInstanceGroup	ConsumedProvidedServiceInstanceGroup	*	ref	<p>With this reference it is possible to identify which ConsumedProvidedServiceInstanceGroups are applicable for which ECUInstance.</p> <p>Stereotypes: atpVariation Tags:vh.latestBindingTime=postBuild</p>
associatedPdurIPduGroup	PdurIPduGroup	*	ref	<p>With this reference it is possible to identify which PdurIPdu Groups are applicable for which Communication Connector/ ECU.</p>
clientIdRange	ClientIdRange	0..1	aggr	<p>Restriction of the Client Identifier for this Ecu to an allowed range of numerical values. The Client Identifier of the transaction handle is generated by the client RTE for inter-Ecu Client/Server communication.</p>
comConfigurationGwTimeBase	TimeValue	0..1	attr	<p>The period between successive calls to Com_Main FunctionRouteSignals of the AUTOSAR COM module in seconds.</p>
comConfigurationRxTimeBase	TimeValue	0..1	attr	<p>The period between successive calls to Com_Main FunctionRx of the AUTOSAR COM module in seconds.</p>
comConfigurationTxTimeBase	TimeValue	0..1	attr	<p>The period between successive calls to Com_Main FunctionTx of the AUTOSAR COM module in seconds.</p>
comEnableMDTForCyclicTransmission	Boolean	0..1	attr	<p>Enables for the Com module of this EcuInstance the minimum delay time monitoring for cyclic and repeated transmissions (TransmissionModeTiming has cyclic Timing assigned or eventControlledTiming with numberOfRepetitions > 0).</p>
commController	CommunicationController	1..*	aggr	<p>CommunicationControllers of the ECU.</p> <p>Stereotypes: atpVariation Tags:vh.latestBindingTime=postBuild</p>
connector	CommunicationConnector	*	aggr	<p>All channels controlled by a single controller.</p> <p>Stereotypes: atpVariation Tags:vh.latestBindingTime=postBuild</p>
dltConfig	DltConfig	0..1	aggr	<p>Describes the Dlt configuration on this EcuInstance.</p>
dolpConfig	DolpConfig	0..1	aggr	<p>Dolp configuration on this EcuInstance.</p> <p>Tags:atp.Status=draft</p>
ecuInstanceProps	EcuInstanceProps	0..1	aggr	<p>Additional properties of the EcuInstance that may vary in different Variants of the Ecu.</p> <p>Stereotypes: atpVariation Tags:vh.latestBindingTime=postBuild</p>
ethSwitchPortGroupDerivation	Boolean	0..1	attr	<p>Defines whether the derivation of SwitchPortGroups based on VLAN and/or CouplingPort.pncMapping shall be performed for this EcuInstance. If not defined the derivation shall not be done.</p>
partition	EcuPartition	*	aggr	<p>Optional definition of Partitions within an Ecu.</p>





Class	EcuInstance			
pncPrepareSleepTimer	TimeValue	0..1	attr	Time in seconds the PNC state machine shall wait in PNC_PREPARE_SLEEP.
pncSynchronousWakeup	Boolean	0..1	attr	If this parameter is available and set to true then all available PNCs will be woken up as soon as a channel wakeup occurs. This is ensured by adding all PNCs to all channel wakeup sources during upstream mapping.
pnResetTime	TimeValue	0..1	attr	Specifies the runtime of the reset timer in seconds. This reset time is valid for the reset of PN requests in the EIRA and in the ERA.
sleepModeSupported	Boolean	1	attr	Specifies whether the ECU instance may be put to a "low power mode" <ul style="list-style-type: none"> • true: sleep mode is supported • false: sleep mode is not supported Note: This flag may only be set to "true" if the feature is supported by both hardware and basic software.
v2xSupported	V2xSupportEnum	0..1	attr	This attribute is used to control the existence of the V2X stack on the given EcuInstance.
wakeUpOverBusSupported	Boolean	1	attr	Driver support for wakeup over Bus.

Table F.18: EcuInstance

Class	EcucValueCollection			
Package	M2::AUTOSARTemplates::ECUCDescriptionTemplate			
Note	This represents the anchor point of the ECU configuration description. Tags: atp.recommendedPackage=EcucValueCollections			
Base	ARElement , ARObject , CollectableElement , Identifiable , MultilanguageReferrable , PackageableElement , Referrable			
Attribute	Type	Mult.	Kind	Note
ecucValue	EcucModuleConfigurationValues	1..*	ref	References to the configuration of individual software modules that are present on this ECU. atpVariation: [RS_ECUC_00079] Stereotypes: atpVariation Tags: vh.latestBindingTime=preCompileTime
ecuExtract	System	1	ref	Represents the extract of the System Configuration that is relevant for the ECU configured with that ECU Configuration Description.

Table F.19: EcucValueCollection

Class	EndToEndProtectionISignalIPdu
Package	M2::AUTOSARTemplates::SystemTemplate::EndToEndProtection
Note	It is possible to protect the inter-ECU data exchange of safety-related ISignalGroups at the level of COM IPdus using protection mechanisms provided by E2E Library. For each ISignalGroup to be protected, a separate EndToEndProtectionISignalIPdu element shall be created within the EndToEndProtectionSet. The EndToEndProtectionISignalIPdu element refers to the ISignalGroup that is to be protected and to the ISignalIPdu that transmits the protected ISignalGroup. The information how the referenced ISignalGroup shall be protected (through which E2E Profile and with which E2E settings) is defined in the EndToEndDescription element.





Class	EndToEndProtectionISignalPdu			
Base	ARObject			
Attribute	Type	Mult.	Kind	Note
dataOffset	Integer	1	attr	This attribute defines the beginning offset (in bits) of the Array representation of the Signal Group (including CRC, counter and application signal group) in the IPdu. This attribute is mandatory and the dataOffset shall always be defined.
iSignalGroup	ISignalGroup	1	ref	Reference to the ISignalGroup that is to be protected.
iSignalPdu	ISignalPdu	1	ref	Reference to the ISignalPdu that transmits the protected ISignalGroup.

Table F.20: EndToEndProtectionISignalPdu

Class	FlatInstanceDescriptor			
Package	M2::AUTOSARTemplates::CommonStructure::FlatMap			
Note	<p>Represents exactly one node (e.g. a component instance or data element) of the instance tree of a software system. The purpose of this element is to map the various nested representations of this instance to a flat representation and assign a unique name (shortName) to it.</p> <p>Use cases:</p> <ul style="list-style-type: none"> Specify unique names of measurable data to be used by MCD tools Specify unique names of calibration data to be used by MCD tool Specify a unique name for an instance of a component prototype in the ECU extract of the system description <p>Note that in addition it is possible to assign alias names via AliasNameAssignment.</p>			
Base	ARObject, Identifiable , MultilanguageReferrable , Referrable			
Attribute	Type	Mult.	Kind	Note
ecuExtractReference	AtpFeature	0..1	iref	<p>Refers to the instance in the ECU extract. This is valid only, if the FlatMap is used in the context of an ECU extract.</p> <p>The reference shall be such that it uniquely defines the object instance. For example, if a data prototype is declared as a role within an SwcInternalBehavior, it is not enough to state the SwcInternalBehavior as context and the aggregated data prototype as target. In addition, the reference shall also include the complete path identifying instance of the component prototype and the Atomic SoftwareComponentType, which is referred by the particular SwcInternalBehavior.</p> <p>Tags:xml.sequenceOffset=40</p>
role	Identifier	0..1	attr	<p>The role denotes the particular role of the downstream memory location described by this FlatInstanceDescriptor.</p> <p>It applies to use case where one upstream object results in multiple downstream objects, e.g. ModeDeclaration GroupPrototypes which are measurable. In this case the RTE will provide locations for current mode, previous mode and next mode.</p>
rtePluginProps	RtePluginProps	0..1	aggr	<p>The properties of a communication graph with respect to the utilization of RTE Implementation Plug-in.</p> <p>Stereotypes: atpSplitable Tags:atp.Splitkey=rtePluginProps</p>





Class	FlatInstanceDescriptor			
swDataDef Props	SwDataDefProps	0..1	aggr	The properties of this FlatInstanceDescriptor.
upstream Reference	AtpFeature	0..1	iref	<p>Refers to the instance in the context of an "upstream" descriptions, wich could be the system or system extract description, the basic software module description or (if a flat map is used in preliminary context) a description of an atomic component or composition. This reference is optional in case the flat map is used in ECU context.</p> <p>The reference shall be such that it uniquely defines the object instance in the given context. For example, if a data prototype is declared as a role within an SwcInternal Behavior, it is not enough to state the SwcInternal Behavior as context and the aggregated data prototype as target. In addition, the reference shall also include the complete path identifying the instance of the component prototype that contains the particular instance of Swc InternalBehavior.</p> <p>Tags:xml.sequenceOffset=20</p>

Table F.21: FlatInstanceDescriptor

Class	HwDescriptionEntity (abstract)			
Package	M2::AUTOSARTemplates::EcuResourceTemplate			
Note	This meta-class represents the ability to describe a hardware entity.			
Base	<i>ARObject</i> , <i>Referrable</i>			
Subclasses	HwElement , HwPin , HwPinGroup , HwType			
Attribute	Type	Mult.	Kind	Note
hwAttribute Value	HwAttributeValue	*	aggr	<p>This aggregation represents a particular hardware attribute value.</p> <p>Stereotypes: atpVariation</p> <p>Tags: vh.latestBindingTime=systemDesignTime xml.sequenceOffset=50</p>
hwCategory	HwCategory	*	ref	<p>One of the associations representing one particular category of the hardware entity.</p> <p>Tags:xml.sequenceOffset=30</p>
hwType	HwType	0..1	ref	<p>This association is used to assign an optional HwType which contains the common attribute values for all occurrences of this HwDescriptionEntity. Note that Hw Types can not be redefined and therefore shall not have a hwType reference.</p>

Table F.22: HwDescriptionEntity

Class	HwElement
Package	M2::AUTOSARTemplates::EcuResourceTemplate
Note	<p>This represents the ability to describe Hardware Elements on an instance level. The particular types of hardware are distinguished by the category. This category determines the applicable attributes. The possible categories and attributes are defined in HwCategory.</p> <p>Tags:atp.recommendedPackage=HwElements</p>





Class		HwElement		
Base	ARElement , ARObject , CollectableElement , HwDescriptionEntity , Identifiable , MultilanguageReferrable , PackageableElement , Referrable			
Attribute	Type	Mult.	Kind	Note
hwElement Connection	HwElementConnector	*	aggr	This represents one particular connection between two hardware elements. Stereotypes: atpVariation Tags: vh.latestBindingTime=systemDesignTime xml.sequenceOffset=110
hwPinGroup	HwPinGroup	*	aggr	This aggregation is used to describe the connection facilities of a hardware element. Note that hardware element has no pins but only pingroups. Stereotypes: atpVariation Tags: vh.latestBindingTime=systemDesignTime xml.sequenceOffset=90
nestedElement	HwElement	*	ref	This association is used to establish hierarchies of hw elements. Note that one particular HwElement can be target of this association only once. I.e. multiple instantiation of the same HwElement is not supported (at any hierarchy level). Stereotypes: atpVariation Tags: vh.latestBindingTime=systemDesignTime xml.sequenceOffset=70

Table F.23: HwElement

Class		HwType		
Package	M2::AUTOSARTemplates::EcuResourceTemplate::HwElementCategory			
Note	This represents the ability to describe Hardware types on an abstract level. The particular types of hardware are distinguished by the category. This category determines the applicable attributes. The possible categories and attributes are defined in HwCategory. Tags: atp.recommendedPackage=HwTypes			
Base	ARElement , ARObject , CollectableElement , HwDescriptionEntity , Identifiable , MultilanguageReferrable , PackageableElement , Referrable			
Attribute	Type	Mult.	Kind	Note
–	–	–	–	–

Table F.24: HwType

Class		ISignal		
Package	M2::AUTOSARTemplates::SystemTemplate::Fibex::FibexCore::CoreCommunication			
Note	Signal of the Interaction Layer. The RTE supports a "signal fan-out" where the same System Signal is sent in different SignalIPdus to multiple receivers. To support the RTE "signal fan-out" each SignalIPdu contains ISignals. If the same System Signal is to be mapped into several SignalIPdus there is one ISignal needed for each ISignalToIPduMapping.			





Class		ISignal		
		<p style="text-align: center;">△</p> <p>ISignals describe the Interface between the Precompile configured RTE and the potentially Postbuild configured Com Stack (see ECUC Parameter Mapping).</p> <p>In case of the SystemSignalGroup an ISignal shall be created for each SystemSignal contained in the SystemSignalGroup.</p> <p>Tags:atp.recommendedPackage=ISignals</p>		
Base		<p><i>ARObject, CollectableElement, FibexElement, Identifiable, MultilanguageReferrable, Packageable Element, Referrable</i></p>		
Attribute	Type	Mult.	Kind	Note
data Transformation	DataTransformation	0..1	ref	<p>Optional reference to a DataTransformation which represents the transformer chain that is used to transform the data that shall be placed inside this ISignal.</p> <p>Stereotypes: atpSplitable; atpVariation</p> <p>Tags: atp.Splitkey=dataTransformation, variationPoint.shortLabel vh.latestBindingTime=codeGenerationTime</p>
dataTypePolicy	DataTypePolicyEnum	1	attr	<p>With the aggregation of SwDataDefProps an ISignal specifies how it is represented on the network. This representation follows a particular policy. Note that this causes some redundancy which is intended and can be used to support flexible development methodology as well as subsequent integrity checks.</p> <p>If the policy "networkRepresentationFromComSpec" is chosen the network representation from the ComSpec that is aggregated by the PortPrototype shall be used. If the "override" policy is chosen the requirements specified in the PortInterface and in the ComSpec are not fulfilled by the networkRepresentationProps. In case the System Description doesn't use a complete Software Component Description (VFB View) the "legacy" policy can be chosen.</p>
initValue	ValueSpecification	0..1	aggr	<p>Optional definition of a ISignal's initValue in case the System Description doesn't use a complete Software Component Description (VFB View). This supports the inclusion of legacy system signals.</p> <p>This value can be used to configure the Signal's "Init Value".</p> <p>If a full DataMapping exist for the SystemSignal this information may be available from a configured Sender ComSpec and ReceiverComSpec. In this case the initvalues in SenderComSpec and/or ReceiverComSpec override this optional value specification. Further restrictions apply from the RTE specification.</p>
iSignalProps	ISignalProps	0..1	aggr	<p>Additional optional ISignal properties that may be stored in different files.</p> <p>Stereotypes: atpSplitable</p> <p>Tags:atp.Splitkey=iSignalProps</p>
iSignalType	ISignalTypeEnum	0..1	attr	<p>This attribute defines whether this iSignal is an array that results in a UINT8_N / UINT8_DYN ComSignalType in the COM configuration or a primitive type.</p>





Class	ISignal			
length	Integer	1	attr	<p>Size of the signal in bits. The size needs to be derived from the mapped VariableDataPrototype according to the mapping of primitive DataTypes to BaseTypes as used in the RTE. Indicates maximum size for dynamic length signals.</p> <p>The ISignal length of zero bits is allowed.</p>
network Representation Props	SwDataDefProps	0..1	aggr	<p>Specification of the actual network representation. The usage of SwDataDefProps for this purpose is restricted to the attributes compuMethod and baseType. The optional baseType attributes "memAllignment" and "byteOrder" shall not be used.</p> <p>The attribute "dataTypePolicy" in the SystemTemplate element defines whether this network representation shall be ignored and the information shall be taken over from the network representation of the ComSpec.</p> <p>If "override" is chosen by the system integrator the network representation can violate against the requirements defined in the PortInterface and in the network representation of the ComSpec.</p> <p>In case that the System Description doesn't use a complete Software Component Description (VFB View) this element is used to configure "ComSignalDataInvalid Value" and the Data Semantics.</p>
systemSignal	SystemSignal	1	ref	Reference to the System Signal that is supposed to be transmitted in the ISignal.
timeout Substitution Value	ValueSpecification	0..1	aggr	Defines and enables the ComTimeoutSubstitution for this ISignal.
transformation ISignalProps	TransformationISignal Props	*	aggr	A transformer chain consists of an ordered list of transformers. The ISignal specific configuration properties for each transformer are defined in the TransformationISignalProps class. The transformer configuration properties that are common for all ISignals are described in the TransformationTechnology class.

Table F.25: ISignal

Class	ISignalGroup			
Package	M2::AUTOSARTemplates::SystemTemplate::Fibex::FibexCore::CoreCommunication			
Note	<p>SignalGroup of the Interaction Layer. The RTE supports a "signal fan-out" where the same System Signal Group is sent in different SignalIPdus to multiple receivers.</p> <p>An ISignalGroup refers to a set of ISignals that shall always be kept together. A ISignalGroup represents a COM Signal Group.</p> <p>Therefore it is recommended to put the ISignalGroup in the same Package as ISignals (see atp.recommendedPackage)</p> <p>Tags:atp.recommendedPackage=ISignalGroup</p>			
Base	ARObject, CollectableElement, FibexElement, Identifiable, MultilanguageReferrable, Packageable Element, Referrable			
Attribute	Type	Mult.	Kind	Note





Class	ISignalGroup			
comBasedSignalGroupTransformation	DataTransformation	0..1	ref	Optional reference to a DataTransformation which represents the transformer chain that is used to transform the data that shall be placed inside this ISignalGroup based on the COMBasedTransformer approach. Stereotypes: atpSplittable; atpVariation Tags: atp.Splitkey=comBasedSignalGroupTransformation, variationPoint.shortLabel vh.latestBindingTime=codeGenerationTime
iSignal	ISignal	*	ref	Reference to a set of ISignals that shall always be kept together.
systemSignalGroup	SystemSignalGroup	1	ref	Reference to the SystemSignalGroup that is defined on VFB level and that is supposed to be transmitted in the ISignalGroup.
transformationISignalProps	TransformationISignalProps	*	aggr	A transformer chain consists of an ordered list of transformers. The ISignalGroup specific configuration properties for each transformer are defined in the TransformationISignalProps class. The transformer configuration properties that are common for all ISignalGroups are described in the TransformationTechnology class.

Table F.26: ISignalGroup

Class	ISignalIPdu			
Package	M2::AUTOSARTemplates::SystemTemplate::Fibex::FibexCore::CoreCommunication			
Note	Represents the IPdus handled by Com. The ISignalIPdu assembled and disassembled in AUTOSAR COM consists of one or more signals. In case no multiplexing is performed this IPdu is routed to/from the Interface Layer. A maximum of one dynamic length signal per IPdu is allowed. Tags: atp.recommendedPackage=Pdus			
Base	ARObject, CollectableElement, FibexElement, IPdu, Identifiable, MultilanguageReferrable, PackageableElement, Pdu, Referrable			
Attribute	Type	Mult.	Kind	Note
iPduTimingSpecification	IPduTiming	0..1	aggr	Timing specification for Com IPdus (Transmission Modes). This information is mandatory for the sender in a System Extract. This information may be omitted on receivers in a System Extract. atpVariation: The timing of a Pdu can vary. Stereotypes: atpVariation Tags: vh.latestBindingTime=postBuild
iSignalToPduMapping	ISignalToIPduMapping	*	aggr	Definition of SignalToIPduMappings included in the Signal IPdu. atpVariation: The content of a PDU can be variable. Stereotypes: atpVariation Tags: vh.latestBindingTime=postBuild
pduCounter	SignalIPduCounter	0..1	aggr	An included Pdu counter is used to ensure that a sequence of Pdus is maintained. Stereotypes: atpVariation Tags: vh.latestBindingTime=preCompileTime





Class	ISignalPdu			
pduReplication	SignalPduReplication	0..1	aggr	Pdu Replication is a form of redundancy where the data content of one ISignalPdu (source) is transmitted inside a set of replica ISignalPdus. These ISignalPdus (copies) have different Pdu IDs, identical PduCounters, identical data content and are transmitted with the same frequency. Stereotypes: atpVariation Tags: vh.latestBindingTime=preCompileTime
unusedBitPattern	Integer	1	attr	AUTOSAR COM and AUTOSAR IPDUM are filling not used areas of an IPDU with this bit-pattern. This attribute is mandatory to avoid undefined behavior. This byte-pattern will be repeated throughout the IPdu.

Table F.27: ISignalPdu

Class	Identifiable (abstract)
Package	M2::AUTOSARTemplates::GenericStructure::GeneralTemplateClasses::Identifiable
Note	Instances of this class can be referred to by their identifier (within the namespace borders). In addition to this, Identifiables are objects which contribute significantly to the overall structure of an AUTOSAR description. In particular, Identifiables might contain Identifiables.
Base	<i>ARObject</i> , <i>MultilanguageReferrable</i> , <i>Referrable</i>
Subclasses	<p> ARPackage, AbstractEvent, AbstractImplementationDataTypeElement, AbstractServiceInstance, ApplicationEndpoint, ApplicationError, ApplicationPartitionToEcuPartitionMapping, AsynchronousServerCallResultPoint, AtpBlueprint, AtpBlueprintable, AtpClassifier, AtpFeature, AutosarOperationArgumentInstance, AutosarVariableInstance, BswInternalTriggeringPoint, BswModuleDependency, BuildActionEntity, BuildActionEnvironment, CanTpAddress, CanTpChannel, CanTpNode, Chapter, ClassContentConditional, ClientIdDefinition, ClientServerOperation, Code, CollectableElement, ComManagementMapping, CommConnectorPort, CommunicationConnector, CommunicationController, Compiler, ConsistencyNeeds, ConsumedEventGroup, CouplingPort, CouplingPortStructuralElement, CryptoServiceMapping, DataPrototypeGroup, DataTransformation, DependencyOnArtifact, DiagEventDebounceAlgorithm, DiagnosticConnectedIndicator, DiagnosticDataElement, DiagnosticFunctionInhibitSource, DiagnosticMasterToSlaveEventMapping, DiagnosticRoutineSubfunction, DitArgument, DitLogChannel, DitMessage, DolpInterface, DolpLogicAddress, ECUMapping, EOCExecutableEntityRefAbstract, EcuPartition, EcucContainerValue, EcucDefinitionElement, EcucDestinationUriDef, EcucEnumerationLiteralDef, EcucQuery, EcucValidationCondition, EndToEndProtection, ExclusiveArea, ExecutableEntity, ExecutionTime, FMAttributeDef, FMFeatureMapAssertion, FMFeatureMapCondition, FMFeatureMapElement, FMFeatureRelation, FMFeatureRestriction, FMFeatureSelection, FlatInstanceDescriptor, FlexrayArTpNode, FlexrayTpConnectionControl, FlexrayTpNode, FlexrayTpPduPool, FrameTriggering, GeneralParameter, GlobalTimeGateway, GlobalTimeMaster, GlobalTimeSlave, HeapUsage, HwAttributeDef, HwAttributeLiteralDef, HwPin, HwPinGroup, IPSecRule, IPv6ExtHeaderFilterList, ISignalToIPduMapping, ISignalTriggering, IdentCaption, InternalTriggeringPoint, J1939SharedAddressCluster, J1939TpNode, Keyword, LifeCycleState, LinScheduleTable, LinTpNode, Linker, MacMulticastGroup, McDataInstance, MemorySection, ModeDeclaration, ModeDeclarationMapping, ModeSwitchPoint, NetworkEndpoint, NmCluster, NmEcu, NmNode, NvBlockDescriptor, PackageableElement, ParameterAccess, PduToFrameMapping, PduTriggering, PerInstanceMemory, PhysicalChannel, PortGroup, PortInterfaceMapping, PossibleErrorReaction, ResourceConsumption, RootSwCompositionPrototype, RptComponent, RptContainer, RptExecutableEntity, RptExecutableEntityEvent, RptExecutionContext, RptProfile, RptServicePoint, RunnableEntityGroup, SdgAttribute, SdgClass, SecureCommunicationAuthenticationProps, SecureCommunicationFreshnessProps, ServerCallPoint, ServiceNeeds, SignalServiceTranslationElementProps, SignalServiceTranslationEventProps, SignalServiceTranslationProps, SocketAddress, SomeipTpChannel, SpecElementReference, StackUsage, StaticSocketConnection, StructuredReq, SwGenericAxisParamType, SwServiceArg, SwcServiceDependency, SwcToApplicationPartitionMapping, SwcToEcuMapping, SwcToImplMapping, SystemMapping, TcpOptionFilterList, TimingCondition, TimingConstraint, TimingDescription, TimingExtensionResource, TimingModelInstance, TlsCryptoCipherSuite, Topic1, TpAddress, TraceableTable, TraceableText, TracedFailure, TransformationProps, TransformationTechnology, Trigger, VariableAccess, VariationPointProxy, ViewMap, VlanConfig, WaitPoint </p>





Class	Identifiable (abstract)			
Attribute	Type	Mult.	Kind	Note
adminData	AdminData	0..1	aggr	This represents the administrative data for the identifiable object. Tags: xml.sequenceOffset=-40
annotation	Annotation	*	aggr	Possibility to provide additional notes while defining a model element (e.g. the ECU Configuration Parameter Values). These are not intended as documentation but are mere design notes. Tags: xml.sequenceOffset=-25
category	CategoryString	0..1	attr	The category is a keyword that specializes the semantics of the Identifiable. It affects the expected existence of attributes and the applicability of constraints. Tags: xml.sequenceOffset=-50
desc	MultiLanguageOverview Paragraph	0..1	aggr	This represents a general but brief (one paragraph) description what the object in question is about. It is only one paragraph! Desc is intended to be collected into overview tables. This property helps a human reader to identify the object in question. More elaborate documentation, (in particular how the object is built or used) should go to "introduction". Tags: xml.sequenceOffset=-60
introduction	DocumentationBlock	0..1	aggr	This represents more information about how the object in question is built or is used. Therefore it is a DocumentationBlock. Tags: xml.sequenceOffset=-30
uuid	String	0..1	attr	The purpose of this attribute is to provide a globally unique identifier for an instance of a meta-class. The values of this attribute should be globally unique strings prefixed by the type of identifier. For example, to include a DCE UUID as defined by The Open Group, the UUID would be preceded by "DCE:". The values of this attribute may be used to support merging of different AUTOSAR models. The form of the UUID (Universally Unique Identifier) is taken from a standard defined by the Open Group (was Open Software Foundation). This standard is widely used, including by Microsoft for COM (GUIDs) and by many companies for DCE, which is based on CORBA. The method for generating these 128-bit IDs is published in the standard and the effectiveness and uniqueness of the IDs is not in practice disputed. If the id namespace is omitted, DCE is assumed. An example is "DCE:2fac1234-31f8-11b4-a222-08002b34c003". The uuid attribute has no semantic meaning for an AUTOSAR model and there is no requirement for AUTOSAR tools to manage the timestamp. Tags: xml.attribute=true

Table F.28: Identifiable

Class	InstantiationTimingEventProps			
Package	M2::AUTOSARTemplates::SWComponentTemplate::Composition			
Note	This meta class represents the ability to refine a timing event for particular instances of a software component. This supports then an instance specific timing.			
Base	ARObject, InstantiationRTEEventProps			
Attribute	Type	Mult.	Kind	Note
period	TimeValue	1	attr	This attribute represents the value of the refined activation period.

Table F.29: InstantiationTimingEventProps

Class	McDataInstance			
Package	M2::AUTOSARTemplates::CommonStructure::MeasurementCalibrationSupport			
Note	<p>Describes the specific properties of one data instance in order to support measurement and/or calibration of this data instance.</p> <p>The most important attributes are:</p> <ul style="list-style-type: none"> • Its shortName is copied from the ECU Flat map (if applicable) and will be used as identifier and for display by the MC system. • The category is copied from the corresponding data type (ApplicationDataType if defined, otherwise ImplementationDataType) as far as applicable. • The symbol is the one used in the programming language. It will be used to find out the actual memory address by the final generation tool with the help of linker generated information. <p>It is assumed that in the M1 model this part and all the aggregated and referred elements (with the exception of the Flat Map and the references from ImplementationElementInParameterInstanceRef and McAccessDetails) are completely generated from "upstream" information. This means, that even if an element like e.g. a CompuMethod is only used via reference here, it will be copied into the M1 artifact which holds the complete McSupportData for a given Implementation.</p>			
Base	ARObject, Identifiable , MultilanguageReferrable , Referrable			
Attribute	Type	Mult.	Kind	Note
arraySize	PositiveInteger	0..1	attr	The existence of this attribute turns the data instance into an array of data. The attribute determines the size of the array in terms of number of elements.
displayIdentifier	McIdIdentifier	0..1	attr	An optional attribute to be used to set the ASAM ASAP2 DISPLAY_IDENTIFIER attribute.
flatMapEntry	FlatInstanceDescriptor	0..1	ref	<p>Reference to the corresponding entry in the ECU Flat Map. This allows to trace back to the original specification of the generated data instance. This link shall be added by the RTE generator mainly for documentation purposes.</p> <p>The reference is optional because</p> <ul style="list-style-type: none"> • The McDataInstance may represent an array or struct in which only the subElements correspond to FlatMap entries. • The McDataInstance may represent a task local buffer for rapid prototyping access which is different from the "main instance" used for measurement access.
instanceInMemory	ImplementationElementInParameterInstanceRef	0..1	aggr	Reference to the corresponding data instance in the description of calibration data structures published by the RTE generator. This is used to support emulation methods inside the ECU, it is not required for A2L generation.





Class	McDataInstance			
mcDataAccessDetails	McDataAccessDetails	0..1	aggr	Refers to "upstream" information on how the RTE uses this data instance. Use Case: Rapid Prototyping
mcDataAssignment	RoleBasedMcDataAssignment	*	aggr	An assignment between McDataInstances. This supports the indication of related McDataElement implementing the of "RP global buffer", "RP global measurement buffer", "RP enabler flag".
resultingProperties	SwDataDefProps	0..1	aggr	These are the generated properties resulting from decisions taken by the RTE generator for the actually implemented data instance. Only those properties are relevant here, which are needed for the measurement and calibration system.
resultingRptSwPrototypingAccess	RptSwPrototypingAccess	0..1	aggr	Describes the implemented accessibility of data and modes by the rapid prototyping tooling.
role	Identifier	0..1	attr	An optional attribute to be used for additional information on the role of this data instance, for example in the context of rapid prototyping.
rptImplPolicy	RptImplPolicy	0..1	aggr	Describes the implemented code preparation for rapid prototyping at data accesses for a hook based bypassing.
subElement (ordered)	McDataInstance	*	aggr	This relation indicates, that the target element is part of a "struct" which is given by the source element. This information will be used by the final generator to set up the correct addressing scheme. Stereotypes: atpVariation Tags: vh.latestBindingTime=preCompileTime
symbol	SymbolString	0..1	attr	This String is used to determine the memory address during final generation of the MC configuration data (e.g. "A2L" file) . It shall be the name of the element in the programming language such that it can be identified in linker generated information. In case the McDataInstance is part of composite data in the programming language, the symbol String may include parts denoting the element context, unless the context is given by the symbol attribute of an enclosing McDataInstance. This means in particular for the C language that the "." character shall be used as a separator between the name of a "struct" variable the name of one of its elements. The symbol can differ from the shortName in case of generated C data declarations. It is an optional attribute since it may be missing in case the instance represents an element (e.g. a single array element) which has no name in the linker map. Stereotypes: atpSplittable Tags: atp.Splitkey=symbol

Table F.30: McDataInstance

Class	McSupportData
Package	M2::AUTOSARTemplates::CommonStructure::MeasurementCalibrationSupport
Note	Root element for all measurement and calibration support data related to one Implementation artifact on an ECU. There shall be one such element related to the RTE implementation (if it owns MC data) and a separate one for each module or component, which owns private MC data.





Class	McSupportData			
Base	<i>ARObject</i>			
Attribute	Type	Mult.	Kind	Note
emulation Support	McSwEmulationMethod Support	*	aggr	Describes the calibration method used by the RTE. This information is not needed for A2L generation, but to setup software emulation in the ECU. Stereotypes: atpVariation Tags: vh.latestBindingTime=preCompileTime
mcParameter Instance	McDataInstance	*	aggr	A data instance to be used for calibration. Stereotypes: atpSplitable; atpVariation Tags: atp.Splitkey=shortName, variationPoint.shortLabel vh.latestBindingTime=postBuild
mcVariable Instance	McDataInstance	*	aggr	A data instance to be used for measurement. Stereotypes: atpSplitable; atpVariation Tags: atp.Splitkey=shortName, variationPoint.shortLabel vh.latestBindingTime=postBuild
measurable System ConstantValues	SwSystemconstant ValueSet	*	ref	Sets of system constant values to be transferred to the MCD system, because the system constants have been specified with "swCalibrationAccess" = readonly.
rptSupportData	RptSupportData	0..1	aggr	The rapid prototyping support data belonging to this implementation. The aggregation is <<atpSplitable>> because in case of an already existing BSW Implementation model, this description will be added later in the process, namely at code generation time. Stereotypes: atpSplitable Tags: atp.Splitkey=rptSupportData

Table F.31: McSupportData

Class	MultilanguageReferrable (abstract)			
Package	M2::AUTOSARTemplates::GenericStructure::GeneralTemplateClasses::Identifiable			
Note	Instances of this class can be referred to by their identifier (while adhering to namespace borders). They also may have a longName. But they are not considered to contribute substantially to the overall structure of an AUTOSAR description. In particular it does not contain other Referrables.			
Base	<i>ARObject</i> , Referrable			
Subclasses	Caption, DefItem, DocumentationContext, Identifiable , SdgCaption, TraceReferrable , Traceable			
Attribute	Type	Mult.	Kind	Note
longName	MultilanguageLong Name	0..1	aggr	This specifies the long name of the object. Long name is targeted to human readers and acts like a headline.

Table F.32: MultilanguageReferrable

Class	ParameterInAtomicSWCTypeInstanceRef			
Package	M2::AUTOSARTemplates::SWComponentTemplate::SwcInternalBehavior::DataElements::InstanceRefs Usage			
Note	This class implements an instance reference which can be applied for variables as well as for parameters.			





Class		ParameterInAtomicSWCTypeInstanceRef		
Base		<i>ARObject, AtpInstanceRef</i>		
Attribute	Type	Mult.	Kind	Note
base	AtomicSwComponent Type	1	ref	Stereotypes: atpDerived Tags: xml.sequenceOffset=10
contextData Prototype (ordered)	ApplicationComposite ElementDataPrototype	*	ref	This ist the context in a compositeDataType. Tags: xml.sequenceOffset=40
portPrototype	PortPrototype	0..1	ref	This is the port providing the variable or the entry point to the variable structure. Tags: xml.sequenceOffset=20
rootParameter DataPrototype	DataPrototype	0..1	ref	This represents the entry point for references into a CompositeDataType. Tags: xml.sequenceOffset=30
targetData Prototype	DataPrototype	1	ref	This is the target of the instance ref Tags: xml.sequenceOffset=50

Table F.33: ParameterInAtomicSWCTypeInstanceRef

Class		PostBuildVariantCriterionValueSet		
Package		M2::AUTOSARTemplates::GenericStructure::VariantHandling		
Note		This meta-class represents the ability to denote one set of postBuildVariantCriterionValues. Tags: atp.recommendedPackage=PostBuildVariantCriterionValueSets		
Base		<i>ARElement, ARObject, CollectableElement, Identifiable, MultilanguageReferrable, Packageable Element, Referrable</i>		
Attribute	Type	Mult.	Kind	Note
postBuildVariant CriterionValue	PostBuildVariant CriterionValue	*	aggr	This is is one particular postbuild variant criterion/value pair being part of the PostBuildVariantSet.

Table F.34: PostBuildVariantCriterionValueSet

Primitive		Ref		
Package		M2::AUTOSARTemplates::GenericStructure::GeneralTemplateClasses::PrimitiveTypes		
Note		<p>This primitive denotes a name based reference. For detailed syntax see the xsd.pattern.</p> <ul style="list-style-type: none"> • first slash (relative or absolute reference) [optional] • Identifier [required] • a sequence of slashes and Identifiers [optional] <p>This primitive is used by the meta-model tools to create the references.</p> <p>Tags: xml.xsd.customType=REF xml.xsd.pattern=/?[a-zA-Z][a-zA-Z0-9_]{0,127}(/[a-zA-Z][a-zA-Z0-9_]{0,127})* xml.xsd.type=string</p>		
Attribute	Type	Mult.	Kind	Note
base	Identifier	0..1	attr	This attribute reflects the base to be used for this reference. Tags: xml.attribute=true





Primitive	Ref			
blueprintValue	String	0..1	attr	This represents a description that documents how the value shall be defined when deriving objects from the blueprint. Tags: atp.Status=draft xml.attribute=true
index	PositiveInteger	0..1	attr	This attribute supports the use case to point on specific elements in an array. This is in particular required if arrays are used to implement particular data objects. Tags: xml.attribute=true

Table F.35: Ref

Class	Referrable (abstract)			
Package	M2::AUTOSARTemplates::GenericStructure::GeneralTemplateClasses::Identifiable			
Note	Instances of this class can be referred to by their identifier (while adhering to namespace borders).			
Base	ARObject			
Subclasses	AtpDefinition, BswDistinguishedPartition, BswModuleCallPoint, BswModuleClientServerEntry, BswVariableAccess, CouplingPortTrafficClassAssignment, DiagnosticDebounceAlgorithmProps, DiagnosticEnvModeElement, EthernetPriorityRegeneration, EventHandler, ExclusiveAreaNestingOrder, HwDescriptionEntity, ImplementationProps, LinSlaveConfigIdent, ModeTransition, MultilanguageReferrable, PduActivationRoutingGroup, PncMappingIdent, SingleLanguageReferrable, SoConIPdulIdentifier, SocketConnectionBundle, TimeSyncServerConfiguration, TpConnectionIdent			
Attribute	Type	Mult.	Kind	Note
shortName	Identifier	1	attr	This specifies an identifying shortName for the object. It needs to be unique within its context and is intended for humans but even more for technical reference. Tags: xml.enforceMinMultiplicity=true xml.sequenceOffset=-100
shortNameFragment	ShortNameFragment	*	aggr	This specifies how the Referrable.shortName is composed of several shortNameFragments. Tags: xml.sequenceOffset=-90

Table F.36: Referrable

Class	RootSwCompositionPrototype
Package	M2::AUTOSARTemplates::SystemTemplate
Note	<p>The RootSwCompositionPrototype represents the top-level-composition of software components within a given System. According to the use case of the System, this may for example be the a more or less complete VFB description, the software of a System Extract or the software of a flat ECU Extract with only atomic SWCs.</p> <p>Therefore the RootSwComposition will only occasionally contain all atomic software components that are used in a complete VFB System. The OEM is primarily interested in the required functionality and the interfaces defining the integration of the Software Component into the System. The internal structure of such a component contains often substantial intellectual property of a supplier. Therefore a top-level software composition will often contain empty compositions which represent subsystems.</p> <p>The contained SwComponentPrototypes are fully specified by their SwComponentTypes (including Port Prototypes, PortInterfaces, VariableDataPrototypes, SwcInternalBehavior etc.), and their ports are interconnected using SwConnectorPrototypes.</p>





Class	RootSwCompositionPrototype			
Base	<i>ARObject, AtpFeature, AtpPrototype, Identifiable, MultilanguageReferrable, Referrable</i>			
Attribute	Type	Mult.	Kind	Note
calibrationParameterValueSet	CalibrationParameterValueSet	*	ref	Used CalibrationParameterValueSet for instance specific initialization of calibration parameters. Stereotypes: atpSplittable Tags: atp.Splitkey=calibrationParameterValueSet
flatMap	FlatMap	0..1	ref	The FlatMap used in the scope of this RootSwCompositionPrototype. Stereotypes: atpSplittable Tags: atp.Splitkey=flatMap
softwareComposition	CompositionSwComponentType	1	tref	We assume that there is exactly one top-level composition that includes all Component instances of the system Stereotypes: isOfType

Table F.37: RootSwCompositionPrototype

Class	Sdg			
Package	M2::MSR::AsamHdo::SpecialData			
Note	Sdg (SpecialDataGroup) is a generic model which can be used to keep arbitrary information which is not explicitly modeled in the meta-model. Sdg can have various contents as defined by sdgContentsType. Special Data should only be used moderately since all elements should be defined in the meta-model. Thereby SDG should be considered as a temporary solution when no explicit model is available. If an sdgCaption is available, it is possible to establish a reference to the sdg structure.			
Base	<i>ARObject</i>			
Attribute	Type	Mult.	Kind	Note
gid	NameToken	1	attr	This attributes specifies an identifier. Gid comes from the SGML/XML-Term "Generic Identifier" which is the element name in XML. The role of this attribute is the same as the name of an XML - element. Tags: xml.attribute=true
sdgCaption	SdgCaption	0..1	aggr	This aggregation allows to assign the properties of Identifiable to the sdg. By this, a shortName etc. can be assigned to the Sdg. Tags: xml.sequenceOffset=20
sdgCaptionRef	SdgCaption	0..1	ref	This association allows to reuse an already existing caption. Tags: xml.name=SDG-CAPTION-REF xml.sequenceOffset=25
sdgContentsType	SdgContents	0..1	aggr	This is the content of the Sdg. Tags: xml.roleElement=false xml.roleWrapperElement=false xml.sequenceOffset=30 xml.typeElement=false xml.typeWrapperElement=false

Table F.38: Sdg

Class	SenderReceiverToSignalMapping			
Package	M2::AUTOSARTemplates::SystemTemplate::DataMapping			
Note	Mapping of a sender receiver communication data element to a signal.			
Base	<i>ARObject</i> , <i>DataMapping</i>			
Attribute	Type	Mult.	Kind	Note
dataElement	VariableDataPrototype	1	iref	Reference to the data element.
systemSignal	SystemSignal	1	ref	Reference to the system signal used to carry the data element.

Table F.39: SenderReceiverToSignalMapping

Primitive	String
Package	M2::AUTOSARTemplates::GenericStructure::GeneralTemplateClasses::PrimitiveTypes
Note	<p>This represents a String in which white-space shall be normalized before processing. For example: in order to compare two Strings:</p> <ul style="list-style-type: none"> • leading and trailing white-space needs to be removed • consecutive white-space (blank, cr, lf, tab) needs to be replaced by one blank. <p>Tags: xml.xsd.customType=STRING xml.xsd.type=string</p>

Table F.40: String

Class	SwServiceArg			
Package	M2::MSR::DataDictionary::ServiceProcessTask			
Note	<p>Specifies the properties of a data object exchanged during the call of an SwService, e.g. an argument or a return value.</p> <p>The SwServiceArg can also be used in the argument list of a C-macro. For this purpose the category shall be set to "MACRO". A reference to implementationDataType can optional be added if the actual argument has an implementationDataType.</p>			
Base	<i>ARObject</i> , <i>Identifiable</i> , <i>MultilanguageReferrable</i> , <i>Referrable</i>			
Attribute	Type	Mult.	Kind	Note
direction	ArgumentDirectionEnum	0..1	attr	<p>Specifies the direction of the data transfer. The direction shall indicate the direction of the actual information that is being consumed by the caller and/or the callee, not the direction of formal arguments in C.</p> <p>The attribute is optional for backwards compatibility reasons. For example, if a pointer is used to pass a memory address for the expected result, the direction shall be "out". If a pointer is used to pass a memory address with content to be read by the callee, its direction shall be "in".</p> <p>Tags:xml.sequenceOffset=10</p>
swArraysize	ValueList	0..1	aggr	<p>This turns the argument of the service to an array.</p> <p>Tags:xml.sequenceOffset=20</p>
swDataDef Props	SwDataDefProps	0..1	aggr	<p>Data properties of this SwServiceArg.</p> <p>Tags:xml.sequenceOffset=30</p>

Table F.41: SwServiceArg

Class	<<atpMixedString>> SwSystemconstDependentFormula (abstract)			
Package	M2::AUTOSARTemplates::GenericStructure::VariantHandling			
Note	This class represents an expression depending on system constants.			
Base	<i>ARObject, FormulaExpression</i>			
Subclasses	<i>AttributeValueVariationPoint</i> , <i>BlueprintFormula</i> , <i>ConditionByFormula</i> , <i>FMFormulaByFeaturesAndSwSystemconsts</i>			
Attribute	Type	Mult.	Kind	Note
sysc	SwSystemconst	1	ref	This refers to a system constant. The internal (coded) value of the system constant shall be used. Tags: xml.sequenceOffset=50
syscString	SwSystemconst	1	ref	syscString indicates that the referenced system constant shall be evaluated as a string according to [TPS_SWCT_01431].

Table F.42: SwSystemconstDependentFormula

Class	SwSystemconstantValueSet			
Package	M2::AUTOSARTemplates::GenericStructure::VariantHandling			
Note	This meta-class represents the ability to specify a set of system constant values. Tags: atp.recommendedPackage=SwSystemconstantValueSets			
Base	<i>ARElement, ARObject, CollectableElement, Identifiable, MultilanguageReferrable, PackageableElement, Referrable</i>			
Attribute	Type	Mult.	Kind	Note
sw Systemconstant Value	SwSystemconstValue	*	aggr	This is one particular value of a system constant.

Table F.43: SwSystemconstantValueSet

Class	SwcBswMapping			
Package	M2::AUTOSARTemplates::CommonStructure::SwcBswMapping			
Note	Maps an SwcInternalBehavior to an BswInternalBehavior. This is required to coordinate the API generation and the scheduling for AUTOSAR Service Components, ECU Abstraction Components and Complex Driver Components by the RTE and the BSW scheduling mechanisms. Tags: atp.recommendedPackage=SwcBswMappings			
Base	<i>ARElement, ARObject, AtpClassifier, AtpFeature, AtpStructureElement, CollectableElement, Identifiable, MultilanguageReferrable, PackageableElement, Referrable</i>			
Attribute	Type	Mult.	Kind	Note
bswBehavior	BswInternalBehavior	1	ref	The mapped BswInternalBehavior
runnable Mapping	SwcBswRunnable Mapping	*	aggr	A mapping between a pair of SWC and BSW runnables. Stereotypes: atpVariation Tags: vh.latestBindingTime=preCompileTime
swcBehavior	SwcInternalBehavior	1	ref	The mapped SwcInternalBehavior.
synchronized ModeGroup	SwcBswSynchronized ModeGroupPrototype	*	aggr	A pair of SWC and BSW mode group prototypes to be synchronized by the scheduler. Stereotypes: atpVariation Tags: vh.latestBindingTime=preCompileTime





Class	SwcBswMapping			
synchronized Trigger	SwcBswSynchronized Trigger	*	aggr	A pair of SWC and BSW Triggers to be synchronized by the scheduler. Stereotypes: atpVariation Tags: vh.latestBindingTime=preCompileTime

Table F.44: SwcBswMapping

Class	System			
Package	M2::AUTOSARTemplates::SystemTemplate			
Note	<p>The top level element of the System Description. The System description defines five major elements: Topology, Software, Communication, Mapping and Mapping Constraints.</p> <p>The System element directly aggregates the elements describing the Software, Mapping and Mapping Constraints; it contains a reference to an ASAM FIBEX description specifying Communication and Topology.</p> <p>Tags:atp.recommendedPackage=Systems</p>			
Base	ARElement , ARObject , AtpClassifier , AtpFeature , AtpStructureElement , CollectableElement , Identifiable , MultilanguageReferrable , PackageableElement , Referrable			
Attribute	Type	Mult.	Kind	Note
clientId DefinitionSet	ClientIdDefinitionSet	*	ref	Set of Client Identifiers that are used for inter-ECU client-server communication in the System.
containerIPdu HeaderByte Order	ByteOrderEnum	0..1	attr	Defines the byteOrder of the header in ContainerIPdus.
ecuExtract Version	RevisionLabelString	0..1	attr	Version number of the Ecu Extract.
fibexElement	FibexElement	*	ref	Reference to ASAM FIBEX elements specifying Communication and Topology. All Fibex Elements used within a System Description shall be referenced from the System Element. atpVariation: In order to describe a product-line, all Fibex Elements can be optional. Stereotypes: atpVariation Tags: vh.latestBindingTime=postBuild
j1939Shared AddressCluster	J1939SharedAddress Cluster	*	aggr	Collection of J1939Clusters that share a common address space for the routing of messages. Stereotypes: atpSplittable; atpVariation Tags: atp.Splitkey=shortName, variationPoint.shortLabel vh.latestBindingTime=postBuild
mapping	SystemMapping	*	aggr	Aggregation of all mapping aspects (mapping of SW components to ECUs, mapping of data elements to signals, and mapping constraints). In order to support OEM / Tier 1 interaction and shared development for one common System this aggregation is atpSplittable and atpVariation. The content of System Mapping can be provided by several parties using different names for the SystemMapping. This element is not required when the System description is used for a network-only use-case.





Class	System			
				△ Stereotypes: atpSplitable; atpVariation Tags: atp.Splitkey=shortName, variationPoint.shortLabel vh.latestBindingTime=postBuild
pncVectorLength	PositiveInteger	0..1	attr	Length of the partial networking request release information vector (in bytes).
pncVectorOffset	PositiveInteger	0..1	attr	Absolute offset (with respect to the NM-PDU) of the partial networking request release information vector that is defined in bytes as an index starting with 0.
rootSoftwareComposition	RootSwCompositionPrototype	0..1	aggr	Aggregation of the root software composition, containing all software components in the System in a hierarchical structure. This element is not required when the System description is used for a network-only use-case. atpVariation: The RootSwCompositionPrototype can vary. Stereotypes: atpSplitable; atpVariation Tags: atp.Splitkey=shortName, variationPoint.shortLabel vh.latestBindingTime=systemDesignTime
systemDocumentation	Chapter	*	aggr	Possibility to provide additional documentation while defining the System. The System documentation can be composed of several chapters. Stereotypes: atpSplitable; atpVariation Tags: atp.Splitkey=shortName, variationPoint.shortLabel vh.latestBindingTime=systemDesignTime xml.sequenceOffset=-10
systemVersion	RevisionLabelString	1	attr	Version number of the System Description.

Table F.45: System

Class	SystemSignal			
Package	M2::AUTOSARTemplates::SystemTemplate::Fibex::FibexCore::CoreCommunication			
Note	The system signal represents the communication system's view of data exchanged between SW components which reside on different ECUs. The system signals allow to represent this communication in a flattened structure, with exactly one system signal defined for each data element prototype sent and received by connected SW component instances. Tags: atp.recommendedPackage=SystemSignals			
Base	ARElement , ARObject , CollectableElement , Identifiable , MultilanguageReferrable , PackageableElement , Referrable			
Attribute	Type	Mult.	Kind	Note
dynamicLength	Boolean	1	attr	The length of dynamic length signals is variable in run-time. Only a maximum length of such a signal is specified in the configuration (attribute length in ISignal element).
physicalProps	SwDataDefProps	0..1	aggr	Specification of the physical representation.

Table F.46: SystemSignal

Class	TransientFault			
Package	M2::AUTOSARTemplates::CommonStructure::ServiceNeeds			
Note	The reported failure is classified as runtime error.			
Base	ARObject, Identifiable, MultilanguageReferrable, Referrable, TracedFailure			
Attribute	Type	Mult.	Kind	Note
possibleErrorReaction	PossibleErrorReaction	*	aggr	Describes a possible error reactions for the transient fault handler.

Table F.47: TransientFault

Class	VariableInAtomicSWCTypeInstanceRef			
Package	M2::AUTOSARTemplates::SWComponentTemplate::SwcInternalBehavior::DataElements::InstanceRefs Usage			
Note				
Base	ARObject, AtpInstanceRef			
Attribute	Type	Mult.	Kind	Note
base	AtomicSwComponentType	1	ref	Stereotypes: atpDerived Tags: xml.sequenceOffset=10
contextDataPrototype (ordered)	ApplicationCompositeElementDataPrototype	*	ref	This ist the context in a compositeDataType. Tags: xml.sequenceOffset=40
portPrototype	PortPrototype	0..1	ref	This is the port providing the paramter or the entry point to the parameter structure. Tags: xml.sequenceOffset=20
rootVariableDataPrototype	VariableDataPrototype	0..1	ref	Tags: xml.sequenceOffset=30
targetDataPrototype	DataPrototype	1	ref	This is the target of the instance ref. Note that it shall be one of ApplicationCompositeElementDataPrototype of VariableDataPrototype. Tags: xml.sequenceOffset=50

Table F.48: VariableInAtomicSWCTypeInstanceRef

Class	VariationPoint			
Package	M2::AUTOSARTemplates::GenericStructure::VariantHandling			
Note	This meta-class represents the ability to express a "structural variation point". The container of the variation point is part of the selected variant if swSyscond evaluates to true and each postBuildVariant Criterion is fulfilled.			
Base	ARObject			
Attribute	Type	Mult.	Kind	Note
blueprintCondition	DocumentationBlock	0..1	aggr	This represents a description that documents how the variation point shall be resolved when deriving objects from the blueprint. Note that variationPoints are not allowed within a blueprintCondition. Tags: xml.sequenceOffset=28
desc	MultiLanguageOverviewParagraph	0..1	aggr	This allows to describe shortly the purpose of the variation point. Tags: xml.sequenceOffset=20





Class	VariationPoint			
formalBlueprintGenerator	BlueprintGenerator	0..1	aggr	<p>This represents a description that documents how the variation point shall be resolved when deriving objects from the blueprint by using ARML.</p> <p>Note that variationPoints are not allowed within a formal BlueprintGenerator.</p> <p>Tags: atp.Status=draft xml.sequenceOffset=30</p>
postBuildVariantCondition	PostBuildVariantCondition	*	aggr	<p>This is the set of post build variant conditions which all shall be fulfilled in order to (postbuild) bind the variation point.</p> <p>Tags:xml.sequenceOffset=40</p>
sdg	Sdg	0..1	aggr	<p>An optional special data group is attached to every variation point. These data can be used by external software systems to attach application specific data. For example, a variant management system might add an identifier, an URL or a specific classifier.</p> <p>Tags:xml.sequenceOffset=50</p>
shortLabel	Identifier	0..1	attr	<p>This provides a name to the particular variation point to support the RTE generator. It is necessary for supporting splittable aggregations and if binding time is later than codeGenerationTime, as well as some RTE conditions. It needs to be unique with in the enclosing Identifiables with the same ShortName.</p> <p>Tags:xml.sequenceOffset=10</p>
swSyscond	ConditionByFormula	0..1	aggr	<p>This condition acts as Binding Function for the Variation Point. Note that the multiplicity is 0..1 in order to support pure postBuild variants.</p> <p>Tags:xml.sequenceOffset=30</p>

Table F.49: VariationPoint

G Upstream Mapping

G.1 Introduction

This chapter describes the mapping of the ECU Configuration parameters (M1 model) onto the meta-classes and attributes of the AUTOSAR upstream templates (System Template, SW Component Template and ECU Resource Template).

The relationships between upstream templates and ECU Configuration are described in order to answer typical questions like:

- How shall a supplier use the information in a System Description in order to fulfill the needs defined by the systems engineer?
- How is a tool vendor supposed to generate an ECU Configuration Description out of ECU Extract of System Description?

Please note that the tables contain the following columns:

bsw module: Name of BSW module

bsw context: Reference to parameter container

bsw type: Type of parameter

bsw param: Name of the BSW parameter

bsw desc: Description from the configuration document

m2 template: System Template, SW Component Template, ECU Resource Template

m2 param: Name of the upstream template parameter

m2 description: Description from the upstream template definition

mapping rule: Textual description on how to transform between M2 and BSW domains

mapping type:

- local: no mapping needed since parameter local to BSW
- partial: some data can be automatically mapped but not all
- full: all data can be automatically mapped

G.2 NvM

BSW Module	BSW Context	
NvM	NvM/NvMBlockDescriptor	
BSW Parameter	BSW Type	
NvMBlockJobPriority	EcucIntegerParamDef	

BSW Description	
Defines the job priority for a NVRAM block (0 = Immediate priority).	
Template Description	
NvBlockNeeds.writingPriority: Requires the priority of writing this block in case of concurrent requests to write other blocks.	
NvBlockNeeds.storeEmergency: Defines whether or not the associated RAM Block shall be implicitly stored in case of ECU failure (e.g. loss of power) by the basic software. If the attribute storeEmergency is set to true the associated RAM Block shall be configured to have immediate priority.	
M2 Parameter	
CommonStructure::ServiceNeeds::NvBlockNeeds.writingPriority, CommonStructure::ServiceNeeds::NvBlockNeeds.storeEmergency	
Mapping Rule	Mapping Type
It is the integrators job to secure the value-monotonic assignment of writing Priority to NvMBlockJobPriority. This means that the lowest assigned value of writingPriority=MEDIUM shall be greater than highest assigned value of writingPriority=HIGH etc.If NvBlockNeeds.storeEmergency is set to True then NvMBlockJobPriority shall be 0 (Immediate priority). If NvBlockNeeds.storeEmergency is set to False then the value of NvMBlockJobPriority depends on the value of NvBlockNeeds.writingPriority.	full
Mapping Status	ECUC Parameter ID
valid	[ECUC_NvM_00477]

BSW Module	BSW Context
NvM	NvM/NvMBlockDescriptor
BSW Parameter	BSW Type
NvMBlockManagementType	EcucEnumerationParamDef
BSW Description	
Defines the block management type for the NVRAM block.[NVM137]	
Template Description	
Reliability against data loss on the non-volatile medium.	
M2 Parameter	
CommonStructure::ServiceNeeds::NvBlockNeeds.reliability	
Mapping Rule	Mapping Type
if (reliability == errorDetection noProtection) && nDataSets==0 then NvmBlockManagementType = NVM_BLOCK_NATIVE. if reliability == errorCorrection then NvmBlockManagementType = NVM_BLOCK_REDUNDANT. [constr_1095] applies.	full
Mapping Status	ECUC Parameter ID
valid	[ECUC_NvM_00062]

BSW Module	BSW Context
NvM	NvM/NvMBlockDescriptor
BSW Parameter	BSW Type
NvMBlockUseAutoValidation	EcucBooleanParamDef
BSW Description	
Defines whether the RAM Block shall be auto validated during shutdown phase. true: if auto validation mechanism is used, false: otherwise	

Template Description	
If set to true the RAM Block shall be auto validated during shutdown phase.	
M2 Parameter	
CommonStructure::ServiceNeeds::NvBlockNeeds.useAutoValidationAtShutDown	
Mapping Rule	Mapping Type
1:1 mapping	full
Mapping Status	ECUC Parameter ID
valid	[ECUC_NvM_00557]

BSW Module	BSW Context
NvM	NvM/NvMBlockDescriptor
BSW Parameter	BSW Type
NvMBlockUseCRCCompMechanism	EcucBooleanParamDef
BSW Description	
Defines whether the CRC of the RAM Block shall be compared during a write job with the CRC which was calculated during the last successful read or write job. true: if compare mechanism is used, false: otherwise	
Template Description	
If set to true the CRC of the RAM Block shall be compared during a write job with the CRC which was calculated during the last successful read or write job in order to skip unnecessary NVRAM writings.	
M2 Parameter	
CommonStructure::ServiceNeeds::NvBlockNeeds.useCRCCompMechanism	
Mapping Rule	Mapping Type
1:1 mapping	full
Mapping Status	ECUC Parameter ID
valid	[ECUC_NvM_00556]

BSW Module	BSW Context
NvM	NvM/NvMBlockDescriptor
BSW Parameter	BSW Type
NvMBlockUseCrc	EcucBooleanParamDef
BSW Description	
Defines CRC usage for the NVRAM block, i.e. memory space for CRC is reserved in RAM and NV memory. true: CRC will be used for this NVRAM block. false: CRC will not be used for this NVRAM block.	
Template Description	
Reliability against data loss on the non-volatile medium.	
M2 Parameter	
CommonStructure::ServiceNeeds::NvBlockNeeds.reliability	
Mapping Rule	Mapping Type
reliability == errorCorrection errorDetection means that NvmBlockUseCrc shall be set to true, else NvmBlockUseCrc = false	full
Mapping Status	ECUC Parameter ID
valid	[ECUC_NvM_00036]

BSW Module	BSW Context
NvM	NvM/NvMBlockDescriptor

BSW Parameter		BSW Type
NvMBlockUseSetRamBlockStatus		EcucBooleanParamDef
BSW Description		
Defines if NvMSetRamBlockStatusApi shall be used for this block or not. Note: If NvMSetRamBlockStatusApi is disabled this configuration parameter shall be ignored. true: calling of NvMSetRamBlockStatus for this RAM block shall set the status of the RAM block. false: calling of NvMSetRamBlockStatus for this RAM block shall be ignored.		
Template Description		
This attribute defines how the management of the RAM Block status is controlled.		
M2 Parameter		
CommonStructure::ServiceNeeds::NvBlockNeeds.ramBlockStatusControl		
Mapping Rule		Mapping Type
If the value of NvBlockNeeds.ramBlockStatusControl is set to RamBlockStatusControlEnum.api the parameter shall be set to true. If the value of NvBlockNeeds.ramBlockStatusControl is set to RamBlockStatusControlEnum.nvRamManager it shall be set to false.		full
Mapping Status		ECUC Parameter ID
valid		[ECUC_NvM_00552]

BSW Module	BSW Context	
NvM	NvM/NvMBlockDescriptor	
BSW Parameter		BSW Type
NvMBlockWriteProt		EcucBooleanParamDef
BSW Description		
Defines an initial write protection of the NV block true: Initial block write protection is enabled. false: Initial block write protection is disabled.		
Template Description		
True: data of this NVRAM Block are write protected for normal operation (but protection can be disabled) false: no restriction		
M2 Parameter		
CommonStructure::ServiceNeeds::NvBlockNeeds.readonly		
Mapping Rule		Mapping Type
1:1 mapping		full
Mapping Status		ECUC Parameter ID
valid		[ECUC_NvM_00033]

BSW Module	BSW Context	
NvM	NvM/NvMBlockDescriptor	
BSW Parameter		BSW Type
NvMCalcRamBlockCrc		EcucBooleanParamDef
BSW Description		

Defines CRC (re)calculation for the permanent RAM block or NVRAM blocks which are configured to use explicit synchronization mechanism.	
true: CRC will be (re)calculated for this permanent RAM block. false: CRC will not be (re)calculated for this permanent RAM block.	
Template Description	
Defines if CRC (re)calculation for the permanent RAM Block is required.	
M2 Parameter	
CommonStructure::ServiceNeeds::NvBlockNeeds.calcRamBlockCrc	
Mapping Rule	Mapping Type
1:1 mapping	full
Mapping Status	ECUC Parameter ID
valid	[ECUC_NvM_00119]

BSW Module	BSW Context
NvM	NvM/NvMBlockDescriptor
BSW Parameter	BSW Type
NvMNvBlockNum	EcucIntegerParamDef
BSW Description	
Defines the number of multiple NV blocks in a contiguous area according to the given block management type.	
1-255 For NVRAM blocks to be configured of block management type NVM_BLOCK_DATASET. The actual range is limited according to SWS_NvM_00444.	
1 For NVRAM blocks to be configured of block management type NVM_BLOCK_NATIVE	
2 For NVRAM blocks to be configured of block management type NVM_BLOCK_REDUNDANT	
Template Description	
NvBlockNeeds.nDataSets: Number of data sets to be provided by the NVRAM manager for this block. This is the total number of ROM Blocks and RAM Blocks.	
NvBlockNeeds.reliability: Reliability against data loss on the non-volatile medium.	
M2 Parameter	
CommonStructure::ServiceNeeds::NvBlockNeeds.nDataSets,CommonStructure::ServiceNeeds::NvBlockNeeds.reliability	
Mapping Rule	Mapping Type
if (nDataSets == 0 && reliability ==noProtection errorDetection) then NvMNvBlockNum = 1. if (nDataSets >0 && reliability ==noProtection errorDetection) then NvMNvBlockNum = nDataSets.	full
Mapping Status	ECUC Parameter ID
valid	[ECUC_NvM_00480]

BSW Module	BSW Context
NvM	NvM/NvMBlockDescriptor
BSW Parameter	BSW Type
NvMResistantToChangedSw	EcucBooleanParamDef
BSW Description	

<p>Defines whether a NVRAM block shall be treated resistant to configuration changes or not. If there is no default data available at configuration time then the application shall be responsible for providing the default initialization data. In this case the application has to use NvM_GetErrorStatus() to be able to distinguish between first initialization and corrupted data.</p> <p>true: NVRAM block is resistant to changed software. false: NVRAM block is not resistant to changed software.</p>	
Template Description	
<p>Defines whether an NVRAM Block shall be treated resistant to configuration changes (true) or not (false). For details how to handle initialization in the latter case, please refer to the NVRAM specification.</p>	
M2 Parameter	
CommonStructure::ServiceNeeds::NvBlockNeeds.resistantToChangedSw	
Mapping Rule	Mapping Type
1:1 Mapping	full
Mapping Status	ECUC Parameter ID
valid	[ECUC_NvM_00483]

BSW Module	BSW Context
NvM	NvM/NvMBlockDescriptor
BSW Parameter	BSW Type
NvMRomBlockNum	EcucIntegerParamDef
BSW Description	
<p>Defines the number of multiple ROM blocks in a contiguous area according to the given block management type.</p> <p>0-254 For NVRAM blocks to be configured of block management type NVM_BLOCK_DATASET. The actual range is limited according to SWS_NvM_00444.</p> <p>0-1 For NVRAM blocks to be configured of block management type NVM_BLOCK_NATIVE</p> <p>0-1 For NVRAM blocks to be configured of block management type NVM_BLOCK_REDUNDANT</p>	
Template Description	
<p>Number of ROM Blocks to be provided by the NVRAM manager for this block. Please note that these multiple ROM Blocks are given in a contiguous area.</p>	
M2 Parameter	
CommonStructure::ServiceNeeds::NvBlockNeeds.nRomBlocks	
Mapping Rule	Mapping Type
1:1 mapping	full
Mapping Status	ECUC Parameter ID
valid	[ECUC_NvM_00485]

BSW Module	BSW Context
NvM	NvM/NvMBlockDescriptor
BSW Parameter	BSW Type
NvMSelectBlockForFirstInitAll	EcucBooleanParamDef
BSW Description	

<p>Defines whether a block will be processed or not by NvM_FirstInitAll. A block can be configured to be processed even if it doesn't have permanent RAM and/or explicit synchronization.</p> <p>TRUE: block will be processed by NvM_FirstInitAll</p> <p>FALSE: block will not be processed by NvM_FirstInitAll</p>	
Template Description	
If this attribute is set to true the NvM shall process this block in the NvM_FirstInitAll() function.	
M2 Parameter	
CommonStructure::ServiceNeeds::NvBlockNeeds.selectBlockForFirstInitAll	
Mapping Rule	Mapping Type
1:1 mapping	full
Mapping Status	ECUC Parameter ID
valid	[ECUC_NvM_00558]

BSW Module	BSW Context
NvM	NvM/NvMBlockDescriptor
BSW Parameter	BSW Type
NvMSelectBlockForReadAll	EcucBooleanParamDef
BSW Description	
<p>Defines whether a NVRAM block shall be processed during NvM_ReadAll or not. This configuration parameter has only influence on those NVRAM blocks which are configured to have a permanent RAM block or which are configured to use explicit synchronization mechanism.</p> <p>true: NVRAM block shall be processed by NvM_ReadAll</p> <p>false: NVRAM block shall not be processed by NvM_ReadAll</p>	
Template Description	
Defines whether the associated RAM Block shall be implicitly restored during startup by the basic software.	
M2 Parameter	
CommonStructure::ServiceNeeds::NvBlockNeeds.restoreAtStart	
Mapping Rule	Mapping Type
1:1 Mapping	full
Mapping Status	ECUC Parameter ID
valid	[ECUC_NvM_00117]

BSW Module	BSW Context
NvM	NvM/NvMBlockDescriptor
BSW Parameter	BSW Type
NvMSelectBlockForWriteAll	EcucBooleanParamDef
BSW Description	
<p>Defines whether a NVRAM block shall be processed during NvM_WriteAll or not. This configuration parameter has only influence on those NVRAM blocks which are configured to have a permanent RAM block or which are configured to use explicit synchronization mechanism.</p> <p>true: NVRAM block shall be processed by NvM_WriteAll</p> <p>false: NVRAM block shall not be processed by NvM_WriteAll</p>	
Template Description	
Defines whether or not the associated RAM Block shall be implicitly stored during shutdown by the basic software.	
M2 Parameter	
CommonStructure::ServiceNeeds::NvBlockNeeds.storeAtShutdown	

Mapping Rule		Mapping Type
1:1 Mapping		full
Mapping Status	ECUC Parameter ID	
valid	[ECUC_NvM_00549]	

BSW Module	BSW Context	
NvM	NvM/NvMBlockDescriptor	
BSW Parameter		BSW Type
NvMStaticBlockIDCheck		EcucBooleanParamDef
BSW Description		
<p>Defines if the Static Block ID check is enabled.</p> <p>false: Static Block ID check is disabled. true: Static Block ID check is enabled.</p>		
Template Description		
Defines if the Static Block Id check shall be enabled.		
M2 Parameter		
CommonStructure::ServiceNeeds::NvBlockNeeds.checkStaticBlockId		
Mapping Rule		Mapping Type
1:1 mapping		full
Mapping Status	ECUC Parameter ID	
valid	[ECUC_NvM_00532]	

BSW Module	BSW Context	
NvM	NvM/NvMBlockDescriptor	
BSW Parameter		BSW Type
NvMWriteBlockOnce		EcucBooleanParamDef
BSW Description		
<p>Defines write protection after first write. The NVRAM manager sets the write protection bit either after the NV block was written the first time or if the block was already written and it is detected as valid and consistent during a read for it. [NVM276].</p> <p>true: Defines write protection after first write is enabled. false: Defines write protection after first write is disabled.</p>		
Template Description		
<p>Defines write protection after first write:</p> <p>true: This block is prevented from being changed/erased or being replaced with the default ROM data after first initialization by the software-component. false: No such restriction.</p>		
M2 Parameter		
CommonStructure::ServiceNeeds::NvBlockNeeds.writeOnlyOnce		
Mapping Rule		Mapping Type
1:1 mapping		full
Mapping Status	ECUC Parameter ID	
valid	[ECUC_NvM_00072]	

BSW Module	BSW Context	
NvM	NvM/NvMBlockDescriptor	

BSW Parameter		BSW Type	
NvMWriteVerification		EcucBooleanParamDef	
BSW Description			
Defines if Write Verification is enabled.			
false: Write verification is disabled. true: Write Verification is enabled.			
Template Description			
Defines if Write Verification shall be enabled for this NVRAM Block.			
M2 Parameter			
CommonStructure::ServiceNeeds::NvBlockNeeds.writeVerification			
Mapping Rule		Mapping Type	
1:1 mapping		full	
Mapping Status		ECUC Parameter ID	
valid		[ECUC_NvM_00534]	

G.3 Com

BSW Module	BSW Context		
Com	Com/ComConfig/ComGwMapping/ComGwDestination/ComGwDestination Description		
BSW Parameter		BSW Type	
ComFilter		EcucParamConfContainerDef	
BSW Description			
This container contains the configuration parameters of the AUTOSAR COM module's Filters.			
Note: On sender side the container is used to specify the transmission mode conditions.			
Template Description			
Base class for data filters. The type of the filter is specified in attribute dataFilterType. Some of the filter types require additional arguments which are specified as attributes of this class.			
M2 Parameter			
CommonStructure::Filter::DataFilter			
Mapping Rule		Mapping Type	
Create container on the receiver side if the NonqueuedReceiverComSpec contains a DataFilter. Create Container on the sender side if the TransmissionMode Condition element contains a reference to this signal.		full	
Mapping Status		ECUC Parameter ID	
valid		[ECUC_Com_00339]	

BSW Module	BSW Context		
Com	Com/ComConfig/ComGwMapping/ComGwDestination/ComGwDestination Description/ComFilter		
BSW Parameter		BSW Type	
ComFilterAlgorithm		EcucEnumerationParamDef	
BSW Description			
The range of values is specified in the [17] specification, chapter 2.2.2, Reception Filtering.			
Template Description			
This attribute specifies the type of the filter.			
M2 Parameter			
CommonStructure::Filter::DataFilter.dataFilterType			
Mapping Rule		Mapping Type	

Mapping between DataFilterTypeEnum and ComFilterAlgorithm Enum is necessary.	full
Mapping Status	ECUC Parameter ID
valid	[ECUC_Com_00146]

BSW Module	BSW Context	
Com	Com/ComConfig/ComGwMapping/ComGwDestination/ComGwDestinationDescription/ComFilter	
BSW Parameter	BSW Type	
ComFilterMask	EcucIntegerParamDef	
BSW Description		
The name of this attribute corresponds to the parameter name in the [17] specification of Reception Filtering.		
Template Description		
Mask for old and new value.		
M2 Parameter		
CommonStructure::Filter::DataFilter.mask		
Mapping Rule		Mapping Type
1:1 mapping		full
Mapping Status	ECUC Parameter ID	
valid	[ECUC_Com_00235]	

BSW Module	BSW Context	
Com	Com/ComConfig/ComGwMapping/ComGwDestination/ComGwDestinationDescription/ComFilter	
BSW Parameter	BSW Type	
ComFilterMax	EcucIntegerParamDef	
BSW Description		
The name of this attribute corresponds to the parameter name in the [17] specification of Reception Filtering.		
Template Description		
Value to specify the upper boundary		
M2 Parameter		
CommonStructure::Filter::DataFilter.max		
Mapping Rule		Mapping Type
1:1 mapping		full
Mapping Status	ECUC Parameter ID	
valid	[ECUC_Com_00317]	

BSW Module	BSW Context	
Com	Com/ComConfig/ComGwMapping/ComGwDestination/ComGwDestinationDescription/ComFilter	
BSW Parameter	BSW Type	
ComFilterMin	EcucIntegerParamDef	
BSW Description		
The name of this attribute corresponds to the parameter name in the [17] specification of Reception Filtering.		
Template Description		
Value to specify the lower boundary		
M2 Parameter		

CommonStructure::Filter::DataFilter.min	
Mapping Rule	Mapping Type
1:1 mapping	full
Mapping Status	ECUC Parameter ID
valid	[ECUC_Com_00318]

BSW Module	BSW Context
Com	Com/ComConfig/ComGwMapping/ComGwDestination/ComGwDestination Description/ComFilter
BSW Parameter	BSW Type
ComFilterOffset	EcucIntegerParamDef
BSW Description	
The name of this attribute corresponds to the parameter name in the [17] specification of Reception Filtering.	
Range = 0..(ComFilterPeriod-1)	
Template Description	
Specifies the initial number of messages to occur before the first message is passed	
M2 Parameter	
CommonStructure::Filter::DataFilter.offset	
Mapping Rule	Mapping Type
1:1 mapping	full
Mapping Status	ECUC Parameter ID
valid	[ECUC_Com_00313]

BSW Module	BSW Context
Com	Com/ComConfig/ComGwMapping/ComGwDestination/ComGwDestination Description/ComFilter
BSW Parameter	BSW Type
ComFilterPeriod	EcucIntegerParamDef
BSW Description	
This parameter defines the period of the ComFilterAlgorithm ONE_EVERY_N.	
Template Description	
Specifies number of messages to occur before the message is passed again	
M2 Parameter	
CommonStructure::Filter::DataFilter.period	
Mapping Rule	Mapping Type
1:1 mapping	full
Mapping Status	ECUC Parameter ID
valid	[ECUC_Com_00312]

BSW Module	BSW Context
Com	Com/ComConfig/ComGwMapping/ComGwDestination/ComGwDestination Description/ComFilter
BSW Parameter	BSW Type
ComFilterX	EcucIntegerParamDef
BSW Description	
The name of this attribute corresponds to the parameter name in the [17] specification of Reception Filtering.	
Template Description	

Value to compare with	
M2 Parameter	
CommonStructure::Filter::DataFilter.x	
Mapping Rule	Mapping Type
1:1 mapping	full
Mapping Status	ECUC Parameter ID
valid	[ECUC_Com_00147]

BSW Module	BSW Context
Com	Com/ComConfig/ComGwMapping/ComGwDestination/ComGwDestination Description
BSW Parameter	BSW Type
ComSignalInitValue	EcucStringParamDef
BSW Description	
Initial value for this signal. In case of UINT8_N the default value is a string of length ComSignalLength with all bytes set to 0x00. In case of UINT8_DYN the initial size shall be 0.	
In case the ComSignalType is UINT8, UINT16, UINT32, UINT64, SINT8, SINT16, SINT32, SINT64 the string shall be interpreted as defined in the chapter Integer Type in the AUTOSAR EcuC specification.	
In case the ComSignalType is FLOAT32, FLOAT64 the string shall be interpreted as defined in the chapter Float Type in the AUTOSAR EcuC specification.	
In case the ComSignalType is BOOLEAN the string shall be interpreted as defined in the chapter Boolean Type in the AUTOSAR EcuC specification.	
In case the ComSignal is a UINT8_N, UINT8_DYN the string shall be interpreted as a decimal representation of the characters separated by blanks, e.g. "97 98 100" means a string "abd", where the char "a" is in byte 0(lowest address), "b" is in byte 1, and "d" is in byte 2 and (highest address). For the ComSignalType UINT8_DYN the dynamic length shall be set to the number of configured characters. An empty string "" shall be interpreted as 0-sized dynamic signal.	
Template Description	
Initial value to be sent if sender component is not yet fully initialized, but receiver needs data already.	
M2 Parameter	
SystemTemplate::Fibex::FibexCore::CoreCommunication::ISignal.initValue,SWComponentTemplate::Communication::NonqueuedSenderComSpec.initValue	
Mapping Rule	Mapping Type
It is possible to aggregate an initValue at the level of a ComSpec in the SW C Template. in case the System Description doesn't use a complete Software Component Description (VFB View) the initValue is defined in the System Template.	full
Mapping Status	ECUC Parameter ID
valid	[ECUC_Com_00170]

BSW Module	BSW Context
Com	Com/ComConfig/ComSignal
BSW Parameter	BSW Type
ComDataInvalidAction	EcucEnumerationParamDef
BSW Description	
This parameter defines the action performed upon reception of an invalid signal. Relating to signal groups the action in case if one of the included signals is an invalid signal. If Replace is used the ComSignalInitValue will be used for the replacement.	
Template Description	

InvalidationPolicy: Specifies whether the component can actively invalidate a particular dataElement.	
If no invalidationPolicy points to a dataElement this is considered to yield the identical result as if the handleInvalid attribute was set to dontInvalidate.	
ISignalPort.handleInvalid: This attribute defines how invalidation is applied to the ISignals received in the context of this ISignalPort.	
M2 Parameter SWComponentTemplate::PortInterface::InvalidationPolicy, SystemTemplate::Fibex::FibexCore::CoreCommunication::ISignalPort.handleInvalid	
Mapping Rule	Mapping Type
If strategy HandleInvalidEnum.keep is defined then set ComDataInvalidAction to NOTIFY. If strategy HandleInvalidEnum.replace is defined then set ComDataInvalidAction to REPLACE. In all other cases the ComDataInvalidAction shall not be configured.	full
Mapping Status	ECUC Parameter ID
valid	[ECUC_Com_00314]

BSW Module	BSW Context
Com	Com/ComConfig/ComSignal
BSW Parameter	BSW Type
ComFilter	EcucParamConfContainerDef
BSW Description	
This container contains the configuration parameters of the AUTOSAR COM module's Filters.	
Note: On sender side the container is used to specify the transmission mode conditions.	
Template Description	
Base class for data filters. The type of the filter is specified in attribute dataFilterType. Some of the filter types require additional arguments which are specified as attributes of this class.	
M2 Parameter CommonStructure::Filter::DataFilter	
Mapping Rule	Mapping Type
Create container on the receiver side if the NonqueuedReceiverComSpec contains a DataFilter. Create Container on the sender side if the TransmissionMode Condition element contains a reference to this signal.	full
Mapping Status	ECUC Parameter ID
valid	[ECUC_Com_00339]

BSW Module	BSW Context
Com	Com/ComConfig/ComSignal/ComFilter
BSW Parameter	BSW Type
ComFilterAlgorithm	EcucEnumerationParamDef
BSW Description	
The range of values is specified in the [17] specification, chapter 2.2.2, Reception Filtering.	
Template Description	
This attribute specifies the type of the filter.	
M2 Parameter CommonStructure::Filter::DataFilter.dataFilterType	
Mapping Rule	Mapping Type

Mapping between DataFilterTypeEnum and ComFilterAlgorithm Enum is necessary.		full
Mapping Status	ECUC Parameter ID	
valid	[ECUC_Com_00146]	

BSW Module	BSW Context	
Com	Com/ComConfig/ComSignal/ComFilter	
BSW Parameter	BSW Type	
ComFilterMask	EcucIntegerParamDef	
BSW Description		
The name of this attribute corresponds to the parameter name in the [17] specification of Reception Filtering.		
Template Description		
Mask for old and new value.		
M2 Parameter		
CommonStructure::Filter::DataFilter.mask		
Mapping Rule		Mapping Type
1:1 mapping		full
Mapping Status	ECUC Parameter ID	
valid	[ECUC_Com_00235]	

BSW Module	BSW Context	
Com	Com/ComConfig/ComSignal/ComFilter	
BSW Parameter	BSW Type	
ComFilterMax	EcucIntegerParamDef	
BSW Description		
The name of this attribute corresponds to the parameter name in the [17] specification of Reception Filtering.		
Template Description		
Value to specify the upper boundary		
M2 Parameter		
CommonStructure::Filter::DataFilter.max		
Mapping Rule		Mapping Type
1:1 mapping		full
Mapping Status	ECUC Parameter ID	
valid	[ECUC_Com_00317]	

BSW Module	BSW Context	
Com	Com/ComConfig/ComSignal/ComFilter	
BSW Parameter	BSW Type	
ComFilterMin	EcucIntegerParamDef	
BSW Description		
The name of this attribute corresponds to the parameter name in the [17] specification of Reception Filtering.		
Template Description		
Value to specify the lower boundary		
M2 Parameter		
CommonStructure::Filter::DataFilter.min		
Mapping Rule		Mapping Type
1:1 mapping		full

Mapping Status	ECUC Parameter ID
valid	[ECUC_Com_00318]

BSW Module	BSW Context	
Com	Com/ComConfig/ComSignal/ComFilter	
BSW Parameter	BSW Type	
ComFilterOffset	EcucIntegerParamDef	
BSW Description		
The name of this attribute corresponds to the parameter name in the [17] specification of Reception Filtering.		
Range = 0..(ComFilterPeriod-1)		
Template Description		
Specifies the initial number of messages to occur before the first message is passed		
M2 Parameter		
CommonStructure::Filter::DataFilter.offset		
Mapping Rule	Mapping Type	
1:1 mapping	full	
Mapping Status	ECUC Parameter ID	
valid	[ECUC_Com_00313]	

BSW Module	BSW Context	
Com	Com/ComConfig/ComSignal/ComFilter	
BSW Parameter	BSW Type	
ComFilterPeriod	EcucIntegerParamDef	
BSW Description		
This parameter defines the period of the ComFilterAlgorithm ONE_EVERY_N.		
Template Description		
Specifies number of messages to occur before the message is passed again		
M2 Parameter		
CommonStructure::Filter::DataFilter.period		
Mapping Rule	Mapping Type	
1:1 mapping	full	
Mapping Status	ECUC Parameter ID	
valid	[ECUC_Com_00312]	

BSW Module	BSW Context	
Com	Com/ComConfig/ComSignal/ComFilter	
BSW Parameter	BSW Type	
ComFilterX	EcucIntegerParamDef	
BSW Description		
The name of this attribute corresponds to the parameter name in the [17] specification of Reception Filtering.		
Template Description		
Value to compare with		
M2 Parameter		
CommonStructure::Filter::DataFilter.x		
Mapping Rule	Mapping Type	
1:1 mapping	full	
Mapping Status	ECUC Parameter ID	

valid	[ECUC_Com_00147]
-------	------------------

BSW Module	BSW Context	
Com	Com/ComConfig/ComSignal	
BSW Parameter	BSW Type	
ComSignalDataInvalidValue	EcucStringParamDef	
BSW Description		
<p>Defines the data invalid value of the signal.</p> <p>In case the ComSignalType is UINT8, UINT16, UINT32, UINT64, SINT8, SINT16, SINT32, SINT64 the string shall be interpreted as defined in the chapter Integer Type in the AUTOSAR EcuC specification.</p> <p>In case the ComSignalType is FLOAT32, FLOAT64 the string shall be interpreted as defined in the chapter Float Type in the AUTOSAR EcuC specification.</p> <p>In case the ComSignalType is BOOLEAN the string shall be interpreted as defined in the chapter Boolean Type in the AUTOSAR EcuC specification.</p> <p>In case the ComSignal is a UINT8_N, UINT8_DYN the string shall be interpreted as a decimal representation of the characters separated by blanks, e.g. "97 98 100" means a string "abd", where the char "a" is in byte 0(lowest address), "b" is in byte 1, and "d" is in byte 2 and (highest address). For the ComSignalType UINT8_DYN the dynamic length shall be set to the number of configured characters. An empty string "" shall be interpreted as 0-sized dynamic signal.</p>		
Template Description		
<p>InvalidationPolicy: Specifies whether the component can actively invalidate a particular dataElement.</p> <p>If no invalidationPolicy points to a dataElement this is considered to yield the identical result as if the handleInvalid attribute was set to dontInvalidate.</p> <p>SwDataDefProps.invalidValue: Optional value to express invalidity of the actual data element.</p>		
M2 Parameter		
SWComponentTemplate::PortInterface::InvalidationPolicy, DataDictionary::DataDefProperties::SwDataDefProps.invalidValue		
Mapping Rule		Mapping Type
ComSignalDataInvalidValue is only derived 1:1 from the SwDataDef Props.invalidValue if the InvalidationPolicy equals keep or replace. In all other cases of InvalidationPolicy the ComSignalDataInvalidValue shall not be configured.		full
Mapping Status		ECUC Parameter ID
valid		[ECUC_Com_00391]

BSW Module	BSW Context	
Com	Com/ComConfig/ComSignal	
BSW Parameter	BSW Type	
ComSignalInitValue	EcucStringParamDef	
BSW Description		

<p>Initial value for this signal. In case of UINT8_N the default value is a string of length ComSignalLength with all bytes set to 0x00. In case of UINT8_DYN the initial size shall be 0.</p> <p>In case the ComSignalType is UINT8, UINT16, UINT32, UINT64, SINT8, SINT16, SINT32, SINT64 the string shall be interpreted as defined in the chapter Integer Type in the AUTOSAR EcuC specification.</p> <p>In case the ComSignalType is FLOAT32, FLOAT64 the string shall be interpreted as defined in the chapter Float Type in the AUTOSAR EcuC specification.</p> <p>In case the ComSignalType is BOOLEAN the string shall be interpreted as defined in the chapter Boolean Type in the AUTOSAR EcuC specification.</p> <p>In case the ComSignal is a UINT8_N, UINT8_DYN the string shall be interpreted as a decimal representation of the characters separated by blanks, e.g. "97 98 100" means a string "abd", where the char "a" is in byte 0(lowest address), "b" is in byte 1, and "d" is in byte 2 and (highest address). For the ComSignalType UINT8_DYN the dynamic length shall be set to the number of configured characters. An empty string "" shall be interpreted as 0-sized dynamic signal.</p>	
Template Description	
Initial value to be sent if sender component is not yet fully initialized, but receiver needs data already.	
M2 Parameter	
SystemTemplate::Fibex::FibexCore::CoreCommunication::ISignal.initValue,SWComponentTemplate::Communication::NonqueuedSenderComSpec.initValue	
Mapping Rule	Mapping Type
It is possible to aggregate an initValue at the level of a ComSpec in the SW C Template. in case the System Description doesn't use a complete Software Component Description (VFB View) the initValue is defined in the System Template.	full
Mapping Status	ECUC Parameter ID
valid	[ECUC_Com_00170]

BSW Module	BSW Context
Com	Com/ComConfig/ComSignal
BSW Parameter	BSW Type
ComTimeout	EcucFloatParamDef
BSW Description	
Defines the length of the deadline monitoring timeout period in seconds. The period for the first timeout period can be configured separately by ECUC_Com_00183.	
Template Description	

<p>ISignalPort.timeout: - ISignalPort with communicationDirection = in:</p> <p>Optional timeout value in seconds for the reception of the ISignal in case the System Description doesn't use a complete Software Component Description (VFB View). This supports the inclusion of legacy system signals. If a full DataMapping exist for the SystemSignal this information may be available from a configured ReceiverComSpec, in this case the timeout value in ReceiverComSpec overrides this optional timeout specification.</p> <p>- ISignalPort with communicationDirection = out:</p> <p>Optional timeout value in seconds for transmission deadline monitoring in case the System Description doesn't use a complete Software Component Description (VFB View). This supports the inclusion of legacy system signals. If a full DataMapping exist for the SystemSignal this information may be available from a configured SenderComSpec, in this case the timeout value in SenderComSpec overrides this optional timeout specification.</p> <p>TransmissionAcknowledgementRequest.timeout: Number of seconds before an error is reported or in case of allowed redundancy, the value is sent again.</p> <p>NonqueuedReceiverComSpec.aliveTimeout: Specify the amount of time (in seconds) after which the software component (via the RTE) needs to be notified if the corresponding data item have not been received according to the specified timing description.</p> <p>If the aliveTimeout attribute is 0 no timeout monitoring shall be performed.</p>		
<p>M2 Parameter</p> <p>SystemTemplate::Fibex::FibexCore::CoreCommunication::ISignalPort.timeout, SW SWComponentTemplate::Communication::TransmissionAcknowledgementRequest.timeout, SW ComponentTemplate::Communication::NonqueuedReceiverComSpec.aliveTimeout</p>		
<p>Mapping Rule</p> <p>TX Signals: If a full DataMapping exist for the SystemSignal this information may be available from a configured SenderComSpec.transmissionAcknowledge.timeout that specifies the amount of time (in seconds) after which the software component (via the RTE) needs to be notified if the corresponding data item have not been transmitted according to the specified timing description. In this case the timeout value in SenderComSpec overrides the optional timeout specification in the System Template defined on the ISignalPort.</p> <p>RX Signals: If a full DataMapping exist for the SystemSignal this information may be available from a configured NonqueuedReceiverComSpec.aliveTimeout. In this case the timeout value in ReceiverComSpec overrides the optional timeout specification in the System Template defined on the ISignalPort. Please note that the SWS_RTE defines an algorithm to finally set the applicable timeout value.</p>		<p>Mapping Type</p> <p>full</p>
<p>Mapping Status</p> <p>valid</p>		<p>ECUC Parameter ID</p> <p>[ECUC_Com_00263]</p>

BSW Module	BSW Context
-------------------	--------------------

Com	Com/ComConfig/ComSignal	
BSW Parameter		BSW Type
ComTimeoutSubstitutionValue		EcucStringParamDef
BSW Description		
<p>The signal substitution value will be used in case of a timeout and ComRxDataTimeoutAction is set to SUBSTITUTE.</p> <p>In case of UINT8_N the default value is a string of length ComSignalLength with all bytes set to 0x00.</p> <p>In case ofUINT8_DYN the initial size shall be 0.</p> <p>In case the ComSignalType is UINT8, UINT16, UINT32, UINT64, SINT8, SINT16, SINT32, SINT64 the string shall be interpreted as defined in the chapter Integer Type in the AUTOSAR EcuC specification.</p> <p>In case the ComSignalType is FLOAT32, FLOAT64 the string shall be interpreted as defined in the chapter Float Type in the AUTOSAR EcuC specification.</p> <p>In case the ComSignalType is BOOLEAN the string shall be interpreted as defined in the chapter Boolean Type in the AUTOSAR EcuC specification.</p> <p>In case the ComSignal is a UINT8_N, UINT8_DYN the string shall be interpreted as a decimal representation of the characters separated by blanks, e.g. "97 98 100" means a string "abd", where the char "a" is in byte 0(lowest address), "b" is in byte 1, and "d" is in byte 2 and (highest address). For the ComSignalType UINT8_DYN the dynamic length shall be set to the number of configured characters. An empty string "" shall be interpreted as 0-sized dynamic signal.</p>		
Template Description		
Defines and enables the ComTimeoutSubstitution for this ISignal.		
M2 Parameter		
SystemTemplate::Fibex::FibexCore::CoreCommunication::ISignal.timeoutSubstitutionValue		
Mapping Rule		Mapping Type
<p>The mapping of ComTimeoutSubstitutionValue depends on the setting in the ISignal.dataTypePolicy:</p> <ul style="list-style-type: none"> - ISignal.dataTypePolicy = override or legacy: SystemTemplate::Fibex::FibexCore::CoreCommunication::ISignal.timeoutSubstitutionValue - ISignal.dataTypePolicy = networkRepresentationFromComSpec: SWComponentTemplate::Communication::NonequeuedReceiverComSpec.timeoutSubstitutionValue - ISignal.dataTypePolicy = transformingISignal this is not supported. 		full
Mapping Status		ECUC Parameter ID
valid		[ECUC_Com_10006]

BSW Module	BSW Context
Com	Com/ComConfig/ComSignalGroup
BSW Parameter	
ComDataInvalidAction	
BSW Type	
EcucEnumerationParamDef	
BSW Description	
<p>This parameter defines the action performed upon reception of an invalid signal.</p> <p>Relating to signal groups the action in case if one of the included signals is an invalid signal.</p> <p>If Replace is used the ComSignalInitValue will be used for the replacement.</p>	

Template Description	
InvalidationPolicy: Specifies whether the component can actively invalidate a particular dataElement. If no invalidationPolicy points to a dataElement this is considered to yield the identical result as if the handleInvalid attribute was set to dontInvalidate.	
ISignalPort.handleInvalid: This attribute defines how invalidation is applied to the ISignals received in the context of this ISignalPort.	
M2 Parameter SWComponentTemplate::PortInterface::InvalidationPolicy, SystemTemplate::Fibex::FibexCore::Core Communication::ISignalPort.handleInvalid	
Mapping Rule	Mapping Type
If strategy HandleInvalidEnum.keep is defined then set ComDataInvalidAction to NOTIFY. If strategy HandleInvalidEnum.replace is defined then set ComData InvalidAction to REPLACE. In all other cases the ComDataInvalidAction shall not be configured.	full
Mapping Status	ECUC Parameter ID
valid	[ECUC_Com_00314]

BSW Module	BSW Context
Com	Com/ComConfig/ComSignalGroup/ComGroupSignal
BSW Parameter	BSW Type
ComFilter	EcucParamConfContainerDef
BSW Description	
This container contains the configuration parameters of the AUTOSAR COM module's Filters. Note: On sender side the container is used to specify the transmission mode conditions.	
Template Description	
Base class for data filters. The type of the filter is specified in attribute dataFilterType. Some of the filter types require additional arguments which are specified as attributes of this class.	
M2 Parameter	
CommonStructure::Filter::DataFilter	
Mapping Rule	Mapping Type
Create container on the receiver side if the NonqueuedReceiverComSpec contains a DataFilter. Create Container on the sender side if the TransmissionMode Condition element contains a reference to this signal.	full
Mapping Status	ECUC Parameter ID
valid	[ECUC_Com_00339]

BSW Module	BSW Context
Com	Com/ComConfig/ComSignalGroup/ComGroupSignal/ComFilter
BSW Parameter	BSW Type
ComFilterAlgorithm	EcucEnumerationParamDef
BSW Description	
The range of values is specified in the [17] specification, chapter 2.2.2, Reception Filtering.	
Template Description	
This attribute specifies the type of the filter.	
M2 Parameter	
CommonStructure::Filter::DataFilter.dataFilterType	
Mapping Rule	Mapping Type

Mapping between DataFilterTypeEnum and ComFilterAlgorithm Enum is necessary.		full
Mapping Status	ECUC Parameter ID	
valid	[ECUC_Com_00146]	

BSW Module	BSW Context	
Com	Com/ComConfig/ComSignalGroup/ComGroupSignal/ComFilter	
BSW Parameter	BSW Type	
ComFilterMask	EcucIntegerParamDef	
BSW Description		
The name of this attribute corresponds to the parameter name in the [17] specification of Reception Filtering.		
Template Description		
Mask for old and new value.		
M2 Parameter		
CommonStructure::Filter::DataFilter.mask		
Mapping Rule		Mapping Type
1:1 mapping		full
Mapping Status	ECUC Parameter ID	
valid	[ECUC_Com_00235]	

BSW Module	BSW Context	
Com	Com/ComConfig/ComSignalGroup/ComGroupSignal/ComFilter	
BSW Parameter	BSW Type	
ComFilterMax	EcucIntegerParamDef	
BSW Description		
The name of this attribute corresponds to the parameter name in the [17] specification of Reception Filtering.		
Template Description		
Value to specify the upper boundary		
M2 Parameter		
CommonStructure::Filter::DataFilter.max		
Mapping Rule		Mapping Type
1:1 mapping		full
Mapping Status	ECUC Parameter ID	
valid	[ECUC_Com_00317]	

BSW Module	BSW Context	
Com	Com/ComConfig/ComSignalGroup/ComGroupSignal/ComFilter	
BSW Parameter	BSW Type	
ComFilterMin	EcucIntegerParamDef	
BSW Description		
The name of this attribute corresponds to the parameter name in the [17] specification of Reception Filtering.		
Template Description		
Value to specify the lower boundary		
M2 Parameter		
CommonStructure::Filter::DataFilter.min		
Mapping Rule		Mapping Type
1:1 mapping		full

Mapping Status	ECUC Parameter ID
valid	[ECUC_Com_00318]

BSW Module	BSW Context	
Com	Com/ComConfig/ComSignalGroup/ComGroupSignal/ComFilter	
BSW Parameter	BSW Type	
ComFilterOffset	EcucIntegerParamDef	
BSW Description		
The name of this attribute corresponds to the parameter name in the [17] specification of Reception Filtering.		
Range = 0..(ComFilterPeriod-1)		
Template Description		
Specifies the initial number of messages to occur before the first message is passed		
M2 Parameter		
CommonStructure::Filter::DataFilter.offset		
Mapping Rule	Mapping Type	
1:1 mapping	full	
Mapping Status	ECUC Parameter ID	
valid	[ECUC_Com_00313]	

BSW Module	BSW Context	
Com	Com/ComConfig/ComSignalGroup/ComGroupSignal/ComFilter	
BSW Parameter	BSW Type	
ComFilterPeriod	EcucIntegerParamDef	
BSW Description		
This parameter defines the period of the ComFilterAlgorithm ONE_EVERY_N.		
Template Description		
Specifies number of messages to occur before the message is passed again		
M2 Parameter		
CommonStructure::Filter::DataFilter.period		
Mapping Rule	Mapping Type	
1:1 mapping	full	
Mapping Status	ECUC Parameter ID	
valid	[ECUC_Com_00312]	

BSW Module	BSW Context	
Com	Com/ComConfig/ComSignalGroup/ComGroupSignal/ComFilter	
BSW Parameter	BSW Type	
ComFilterX	EcucIntegerParamDef	
BSW Description		
The name of this attribute corresponds to the parameter name in the [17] specification of Reception Filtering.		
Template Description		
Value to compare with		
M2 Parameter		
CommonStructure::Filter::DataFilter.x		
Mapping Rule	Mapping Type	
1:1 mapping	full	
Mapping Status	ECUC Parameter ID	

valid	[ECUC_Com_00147]
-------	------------------

BSW Module	BSW Context	
Com	Com/ComConfig/ComSignalGroup/ComGroupSignal	
BSW Parameter	BSW Type	
ComSignalDataInvalidValue	EcucStringParamDef	
BSW Description		
<p>Defines the data invalid value of the signal.</p> <p>In case the ComSignalType is UINT8, UINT16, UINT32, UINT64, SINT8, SINT16, SINT32, SINT64 the string shall be interpreted as defined in the chapter Integer Type in the AUTOSAR EcuC specification.</p> <p>In case the ComSignalType is FLOAT32, FLOAT64 the string shall be interpreted as defined in the chapter Float Type in the AUTOSAR EcuC specification.</p> <p>In case the ComSignalType is BOOLEAN the string shall be interpreted as defined in the chapter Boolean Type in the AUTOSAR EcuC specification.</p> <p>In case the ComSignal is a UINT8_N, UINT8_DYN the string shall be interpreted as a decimal representation of the characters separated by blanks, e.g. "97 98 100" means a string "abd", where the char "a" is in byte 0(lowest address), "b" is in byte 1, and "d" is in byte 2 and (highest address). For the ComSignalType UINTE8_DYN the dynamic length shall be set to the number of configured characters. An empty string "" shall be interpreted as 0-sized dynamic signal.</p>		
Template Description		
<p>InvalidationPolicy: Specifies whether the component can actively invalidate a particular dataElement.</p> <p>If no invalidationPolicy points to a dataElement this is considered to yield the identical result as if the handleInvalid attribute was set to dontInvalidate.</p> <p>SwDataDefProps.invalidValue: Optional value to express invalidity of the actual data element.</p>		
M2 Parameter		
SWComponentTemplate::PortInterface::InvalidationPolicy, DataDictionary::DataDefProperties::SwDataDefProps.invalidValue		
Mapping Rule		Mapping Type
ComSignalDataInvalidValue is only derived 1:1 from the SwDataDef Props.invalidValue if the InvalidationPolicy equals keep or replace. In all other cases of InvalidationPolicy the ComSignalDataInvalidValue shall not be configured.		full
Mapping Status		ECUC Parameter ID
valid		[ECUC_Com_00391]

BSW Module	BSW Context	
Com	Com/ComConfig/ComSignalGroup/ComGroupSignal	
BSW Parameter	BSW Type	
ComSignalInitValue	EcucStringParamDef	
BSW Description		

<p>Initial value for this signal. In case of UINT8_N the default value is a string of length ComSignalLength with all bytes set to 0x00. In case of UINT8_DYN the initial size shall be 0.</p> <p>In case the ComSignalType is UINT8, UINT16, UINT32, UINT64, SINT8, SINT16, SINT32, SINT64 the string shall be interpreted as defined in the chapter Integer Type in the AUTOSAR EcuC specification.</p> <p>In case the ComSignalType is FLOAT32, FLOAT64 the string shall be interpreted as defined in the chapter Float Type in the AUTOSAR EcuC specification.</p> <p>In case the ComSignalType is BOOLEAN the string shall be interpreted as defined in the chapter Boolean Type in the AUTOSAR EcuC specification.</p> <p>In case the ComSignal is a UINT8_N, UINT8_DYN the string shall be interpreted as a decimal representation of the characters separated by blanks, e.g. "97 98 100" means a string "abd", where the char "a" is in byte 0(lowest address), "b" is in byte 1, and "d" is in byte 2 and (highest address). For the ComSignalType UINT8_DYN the dynamic length shall be set to the number of configured characters. An empty string "" shall be interpreted as 0-sized dynamic signal.</p>	
Template Description	
Initial value to be sent if sender component is not yet fully initialized, but receiver needs data already.	
M2 Parameter	
SystemTemplate::Fibex::FibexCore::CoreCommunication::ISignal.initValue,SWComponentTemplate::Communication::NonqueuedSenderComSpec.initValue	
Mapping Rule	Mapping Type
It is possible to aggregate an initValue at the level of a ComSpec in the SW C Template. in case the System Description doesn't use a complete Software Component Description (VFB View) the initValue is defined in the System Template.	full
Mapping Status	ECUC Parameter ID
valid	[ECUC_Com_00170]

BSW Module	BSW Context
Com	Com/ComConfig/ComSignalGroup/ComGroupSignal
BSW Parameter	BSW Type
ComTimeoutSubstitutionValue	EcucStringParamDef
BSW Description	
<p>The signal substitution value will be used in case of a timeout and ComRxDataTimeoutAction is set to SUBSTITUTE.</p> <p>In case of UINT8_N the default value is a string of length ComSignalLength with all bytes set to 0x00.</p> <p>In case of UINT8_DYN the initial size shall be 0.</p> <p>In case the ComSignalType is UINT8, UINT16, UINT32, UINT64, SINT8, SINT16, SINT32, SINT64 the string shall be interpreted as defined in the chapter Integer Type in the AUTOSAR EcuC specification.</p> <p>In case the ComSignalType is FLOAT32, FLOAT64 the string shall be interpreted as defined in the chapter Float Type in the AUTOSAR EcuC specification.</p> <p>In case the ComSignalType is BOOLEAN the string shall be interpreted as defined in the chapter Boolean Type in the AUTOSAR EcuC specification.</p> <p>In case the ComSignal is a UINT8_N, UINT8_DYN the string shall be interpreted as a decimal representation of the characters separated by blanks, e.g. "97 98 100" means a string "abd", where the char "a" is in byte 0(lowest address), "b" is in byte 1, and "d" is in byte 2 and (highest address). For the ComSignalType UINT8_DYN the dynamic length shall be set to the number of configured characters. An empty string "" shall be interpreted as 0-sized dynamic signal.</p>	

Template Description	
Defines and enables the ComTimeoutSubstitution for this ISignal.	
M2 Parameter	
SystemTemplate::Fibex::FibexCore::CoreCommunication::ISignal.timeoutSubstitutionValue	
Mapping Rule	Mapping Type
<p>The mapping of ComTimeoutSubstitutionValue depends on the setting in the ISignal.dataTypePolicy:</p> <ul style="list-style-type: none"> - ISignal.dataTypePolicy = override or legacy: SystemTemplate::Fibex::FibexCore::CoreCommunication::ISignal.timeoutSubstitutionValue - ISignal.dataTypePolicy = networkRepresentationFromComSpec: SWComponentTemplate::Communication::NonequeuedReceiverComSpec.timeoutSubstitutionValue - ISignal.dataTypePolicy = transformingISignal this is not supported. 	full
Mapping Status	ECUC Parameter ID
valid	[ECUC_Com_10006]

BSW Module	BSW Context
Com	Com/ComConfig/ComSignalGroup
BSW Parameter	BSW Type
ComTimeout	EcucFloatParamDef
BSW Description	
Defines the length of the deadline monitoring timeout period in seconds. The period for the first timeout period can be configured separately by ECUC_Com_00183.	
Template Description	

<p>ISignalPort.timeout: - ISignalPort with communicationDirection = in:</p> <p>Optional timeout value in seconds for the reception of the ISignal in case the System Description doesn't use a complete Software Component Description (VFB View). This supports the inclusion of legacy system signals. If a full DataMapping exist for the SystemSignal this information may be available from a configured ReceiverComSpec, in this case the timeout value in ReceiverComSpec overrides this optional timeout specification.</p> <p>- ISignalPort with communicationDirection = out:</p> <p>Optional timeout value in seconds for transmission deadline monitoring in case the System Description doesn't use a complete Software Component Description (VFB View). This supports the inclusion of legacy system signals. If a full DataMapping exist for the SystemSignal this information may be available from a configured SenderComSpec, in this case the timeout value in SenderComSpec overrides this optional timeout specification.</p> <p>TransmissionAcknowledgementRequest.timeout: Number of seconds before an error is reported or in case of allowed redundancy, the value is sent again.</p> <p>NonqueuedReceiverComSpec.aliveTimeout: Specify the amount of time (in seconds) after which the software component (via the RTE) needs to be notified if the corresponding data item have not been received according to the specified timing description.</p> <p>If the aliveTimeout attribute is 0 no timeout monitoring shall be performed.</p>		
<p>M2 Parameter</p> <p>SystemTemplate::Fibex::FibexCore::CoreCommunication::ISignalPort.timeout, SW SWComponentTemplate::Communication::TransmissionAcknowledgementRequest.timeout, SW ComponentTemplate::Communication::NonqueuedReceiverComSpec.aliveTimeout</p>		
<p>Mapping Rule</p> <p>TX Signals: If a full DataMapping exist for the SystemSignal this information may be available from a configured SenderComSpec.transmissionAcknowledge.timeout that specifies the amount of time (in seconds) after which the software component (via the RTE) needs to be notified if the corresponding data item have not been transmitted according to the specified timing description. In this case the timeout value in SenderComSpec overrides the optional timeout specification in the System Template defined on the ISignalPort.</p> <p>RX Signals: If a full DataMapping exist for the SystemSignal this information may be available from a configured NonqueuedReceiverComSpec.aliveTimeout. In this case the timeout value in ReceiverComSpec overrides the optional timeout specification in the System Template defined on the ISignalPort. Please note that the SWS_RTE defines an algorithm to finally set the applicable timeout value.</p>		<p>Mapping Type</p> <p>full</p>
<p>Mapping Status</p> <p>valid</p>		<p>ECUC Parameter ID</p> <p>[ECUC_Com_00263]</p>

G.4 WdgM

BSW Module	BSW Context	
WdgM	WdgM/WdgMConfigSet/WdgMMode/WdgMLocalStatusParams	
BSW Parameter		BSW Type
WdgMFailedAliveSupervisionRefCycleTol		EcucIntegerParamDef
BSW Description		
This parameter shall contain the acceptable amount of reference cycles with incorrect/failed alive supervisions for this Supervised Entity.		
Template Description		
Number of consecutive failed alive cycles for this SupervisedEntity which shall be tolerated until the supervision status of the SupervisedEntity is set to WDGM_ALIVE_EXPIRED (see SWS WdgM for more details).		
Note that this value has to be recalculated with respect to the WdgM's own cycle time for ECU configuration.		
M2 Parameter		
CommonStructure::ServiceNeeds::SupervisedEntityNeeds.toleratedFailedCycles		
Mapping Rule		Mapping Type
1:1		full
Mapping Status		ECUC Parameter ID
valid		[ECUC_WdgM_00327]

G.5 Dcm

BSW Module	BSW Context	
Dcm	Dcm/DcmConfigSet/DcmDsd	
BSW Parameter		BSW Type
DcmDsdServiceRequestManufacturerNotification		EcucParamConfContainerDef
BSW Description		
The name of this container is used to define the name of the R-Port through which the DCM accesses the interface ServiceRequestNotification. The R-Port is named ServiceRequestManufacturerNotification_{Name} where {Name} is the name of the container DcmDsdServiceRequestManufacturerNotification.		
The lowerMultiplicity is 0: If container DcmDsdServiceRequestManufacturerNotification does not exist the Indication API is not available.		
Template Description		
This represents the ability to define whether the usage of PortInterface ServiceRequestNotification has the characteristics of being initiated by a manufacturer or by a supplier.		
M2 Parameter		
CommonStructure::ServiceNeeds::DiagnosticCommunicationManagerNeeds.serviceRequestCallbackType		
Mapping Rule		Mapping Type
If DiagnosticCommunicationManagerNeeds.serviceRequestCallbackType is set to DiagnosticServiceRequestCallbackTypeEnum.requestCallbackType Manufacturer then DcmDsdServiceRequestManufacturerNotification shall exist and the value of DcmDsdServiceRequestManufacturerNotification.shortName shall be taken from the SwcServiceDependency.shortName that aggregates the DiagnosticCommunicationManagerNeeds.		full
Mapping Status		ECUC Parameter ID
valid		[ECUC_Dcm_00681]

BSW Module	BSW Context	
Dcm	Dcm/DcmConfigSet/DcmDsd	
BSW Parameter	BSW Type	
DcmDsdServiceRequestSupplierNotification	EcucParamConfContainerDef	
BSW Description		
<p>The name of this container is used to define the name of the R-Port through which the DCM accesses the interface ServiceRequestNotification.</p> <p>The R-Port is named ServiceRequestSupplierNotification_<SWC> where <SWC> is the name of the container DcmDsdServiceRequestSupplierNotification.</p> <p>The lowerMultiplicity is 0: If the container DcmDsdRequestSupplierNotification does not exist the Indication API is not available.</p>		
Template Description		
This represents the ability to define whether the usage of PortInterface ServiceRequestNotification has the characteristics of being initiated by a manufacturer or by a supplier.		
M2 Parameter		
CommonStructure::ServiceNeeds::DiagnosticCommunicationManagerNeeds.serviceRequestCallbackType		
Mapping Rule		Mapping Type
If DiagnosticCommunicationManagerNeeds.serviceRequestCallbackType is set to DiagnosticServiceRequestCallbackTypeEnum.requestCallbackTypeSupplier then DcmDsdServiceRequestSupplierNotification shall exist and the value of DcmDsdServiceRequestSupplierNotification.shortName shall be taken from the SwcServiceDependency.shortName that aggregates the DiagnosticCommunicationManagerNeeds.		full
Mapping Status		ECUC Parameter ID
valid		[ECUC_Dcm_00816]

BSW Module	BSW Context	
Dcm	Dcm/DcmConfigSet/DcmDsp/DcmDspData	
BSW Parameter	BSW Type	
DcmDspDataResetToDefaultFnc	EcucFunctionNameDef	
BSW Description		
<p>Function name to request to application to reset an IOControl to default value. (ResetToDefault-function).</p> <p>This parameter is related to the interface Xxx_ResetToDefault.</p>		
Template Description		
<p>DiagnosticServiceSwMapping.mappedBswServiceDependency: This is supposed to represent a reference to a BswServiceDependency. the latter is not derived from Referrable and therefore this detour needs to be implemented to still let BswServiceDependency become the target of a reference.</p> <p>DiagnosticIoControlNeeds.resetToDefaultSupported: This represents a flag for the existence of the ResetToDefault operation in the service interface.</p>		
M2 Parameter		
DiagnosticExtract::ServiceMapping::DiagnosticServiceSwMapping.mappedBswServiceDependency, CommonStructure::ServiceNeeds::DiagnosticIoControlNeeds.resetToDefaultSupported		
Mapping Rule		Mapping Type
It could be possible to get the FNC name via BswServiceDependency		full
Mapping Status		ECUC Parameter ID
valid		[ECUC_Dcm_00673]

BSW Module	BSW Context	
Dcm	Dcm/DcmConfigSet/DcmDsp/DcmDspData	
BSW Parameter	BSW Type	
DcmDspDataShortTermAdjustmentFnc	EcucFunctionNameDef	
BSW Description		
Function name to request to application to adjust the IO signal. (ShortTermAdjustment-function).		
This parameter is related to the interface Xxx_ShortTermAdjustment.		
Template Description		
DiagnosticServiceSwMapping.mappedBswServiceDependency: This is supposed to represent a reference to a BswServiceDependency. the latter is not derived from Referrable and therefore this detour needs to be implemented to still let BswServiceDependency become the target of a reference.		
DiagnosticIoControlNeeds.shortTermAdjustmentSupported: This attribute determines, if the referenced port supports temporarily setting of I/O value to a specific value provided by the diagnostic tester.		
M2 Parameter		
DiagnosticExtract::ServiceMapping::DiagnosticServiceSwMapping.mappedBswServiceDependency, CommonStructure::ServiceNeeds::DiagnosticIoControlNeeds.shortTermAdjustmentSupported		
Mapping Rule		Mapping Type
It could be possible to get the FNC name via BswServiceDependency		full
Mapping Status		ECUC Parameter ID
valid		[ECUC_Dcm_00675]

BSW Module	BSW Context	
Dcm	Dcm/DcmConfigSet/DcmDsp/DcmDspData/DcmDspDataType	
BSW Parameter	BSW Type	
BOOLEAN	EcucEnumerationLiteralDef	
BSW Description		
Type of the data is boolean.		
Template Description		
BaseTypeDirectDefinition.baseTypeEncoding: This specifies, how an object of the current BaseType is encoded, e.g. in an ECU within a message sequence.		
BaseTypeDirectDefinition.baseTypeSize: Describes the length of the data type specified in the container in bits.		
DiagnosticValueNeeds.fixedLength: This attribute controls whether the data length of the data is fixed.		
M2 Parameter		
AsamHdo::BaseTypes::BaseTypeDirectDefinition.baseTypeEncoding, AsamHdo::BaseTypes::BaseTypeDirectDefinition.baseTypeSize, CommonStructure::ServiceNeeds::DiagnosticValueNeeds.fixedLength		
Mapping Rule		Mapping Type
baseTypeEncoding = BOOLEAN baseTypeSize = 1 maxNumberOfElements shall not exist arraySizeSemantics shall not exist		full
Derivation from DiagnosticValueNeeds.fixedLength=1 possible.		

Mapping Status	ECUC Parameter ID
valid	

BSW Module	BSW Context	
Dcm	Dcm/DcmConfigSet/DcmDsp/DcmDspData/DcmDspDataType	
BSW Parameter	BSW Type	
FLOAT	EcucEnumerationLiteralDef	
BSW Description		
Type of the data is float.		
Template Description		
BaseTypeDirectDefinition.baseTypeEncoding: This specifies, how an object of the current BaseType is encoded, e.g. in an ECU within a message sequence.		
BaseTypeDirectDefinition.baseTypeSize: Describes the length of the data type specified in the container in bits.		
DiagnosticValueNeeds.fixedLength: This attribute controls whether the data length of the data is fixed.		
M2 Parameter		
AsamHdo::BaseTypes::BaseTypeDirectDefinition.baseTypeEncoding, AsamHdo::BaseTypes::BaseTypeDirectDefinition.baseTypeSize, CommonStructure::ServiceNeeds::DiagnosticValueNeeds.fixedLength		
Mapping Rule		Mapping Type
baseTypeEncoding = NONE, WINDOWS-1252, UTF-8, BCD-P, BCD-UP baseTypeSize = 8 maxNumberOfElements shall not exist arraySizeSemantics shall not exist Derivation from DiagnosticValueNeeds.fixedLength=1 possible.		full
Mapping Status	ECUC Parameter ID	
valid		

BSW Module	BSW Context	
Dcm	Dcm/DcmConfigSet/DcmDsp/DcmDspData/DcmDspDataType	
BSW Parameter	BSW Type	
FLOAT_N	EcucEnumerationLiteralDef	
BSW Description		
Type of the data is float array.		
Template Description		
BaseTypeDirectDefinition.baseTypeEncoding: This specifies, how an object of the current BaseType is encoded, e.g. in an ECU within a message sequence.		
BaseTypeDirectDefinition.baseTypeSize: Describes the length of the data type specified in the container in bits.		
DiagnosticValueNeeds.fixedLength: This attribute controls whether the data length of the data is fixed.		
M2 Parameter		

AsamHdo::BaseTypes::BaseTypeDirectDefinition.baseTypeEncoding, AsamHdo::BaseTypes::BaseTypeDirectDefinition.baseTypeSize, CommonStructure::ServiceNeeds::DiagnosticValueNeeds.fixedLength	
Mapping Rule	Mapping Type
baseTypeEncoding = NONE, WINDOWS-1252, UTF-8, BCD-P, BCD-UP baseTypeSize = 8 maxNumberOfElements shall not exist arraySizeSemantics shall not exist Derivation from DiagnosticValueNeeds.fixedLength=1 possible.	full
Mapping Status	ECUC Parameter ID
valid	

BSW Module	BSW Context
Dcm	Dcm/DcmConfigSet/DcmDsp/DcmDspData/DcmDspDataType
BSW Parameter	BSW Type
SINT16	EcucEnumerationLiteralDef
BSW Description	
Type of the data is sint16.	
Template Description	
BaseTypeDirectDefinition.baseTypeSize: Describes the length of the data type specified in the container in bits.	
BaseTypeDirectDefinition.baseTypeEncoding: This specifies, how an object of the current BaseType is encoded, e.g. in an ECU within a message sequence.	
DiagnosticValueNeeds.fixedLength: This attribute controls whether the data length of the data is fixed.	
M2 Parameter	
AsamHdo::BaseTypes::BaseTypeDirectDefinition.baseTypeSize, AsamHdo::BaseTypes::BaseTypeDirectDefinition.baseTypeEncoding, CommonStructure::ServiceNeeds::DiagnosticValueNeeds.fixedLength	
Mapping Rule	Mapping Type
baseTypeEncoding = 2C baseTypeSize = 16 maxNumberOfElements shall not exist arraySizeSemantics shall not exist Derivation from DiagnosticValueNeeds.fixedLength=1 possible.	full
Mapping Status	ECUC Parameter ID
valid	

BSW Module	BSW Context
Dcm	Dcm/DcmConfigSet/DcmDsp/DcmDspData/DcmDspDataType
BSW Parameter	BSW Type
SINT16_N	EcucEnumerationLiteralDef
BSW Description	
Type of the data is sint16 array.	
Template Description	

BaseTypeDirectDefinition.baseTypeSize: Describes the length of the data type specified in the container in bits.	
BaseTypeDirectDefinition.baseTypeEncoding: This specifies, how an object of the current BaseType is encoded, e.g. in an ECU within a message sequence.	
DiagnosticDataElement.arraySizeSemantics: This attribute controls the meaning of the value of the array size.	
DiagnosticDataElement.maxNumberOfElements: The existence of this attribute turns the data instance into an array of data. The attribute determines the size of the array in terms of how many elements the array can take.	
DiagnosticValueNeeds.fixedLength: This attribute controls whether the data length of the data is fixed.	
M2 Parameter	
AsamHdo::BaseTypes::BaseTypeDirectDefinition.baseTypeSize, AsamHdo::BaseTypes::BaseTypeDirectDefinition.baseTypeEncoding DiagnosticExtract::CommonDiagnostics::DiagnosticDataElement.arraySizeSemantics DiagnosticExtract::CommonDiagnostics::DiagnosticDataElement.maxNumberOfElements, CommonStructure::ServiceNeeds::DiagnosticValueNeeds.fixedLength	
Mapping Rule	Mapping Type
baseTypeEncoding = 2C baseTypeSize = 16 maxNumberOfElements exists and value is greater than 0 (cf. TPS_DEXT_01001) arraySizeSemantics either does not exist or exists and is set to ArraySizeSemanticsEnum.fixedSize (cf. TPS_DEXT_01001) Derivation from DiagnosticValueNeeds.fixedLength=1 possible.	full
Mapping Status	ECUC Parameter ID
valid	

BSW Module	BSW Context
Dcm	Dcm/DcmConfigSet/DcmDsp/DcmDspData/DcmDspDataType
BSW Parameter	BSW Type
SINT32	EcucEnumerationLiteralDef
BSW Description	
Type of the data is sint32.	
Template Description	
BaseTypeDirectDefinition.baseTypeSize: Describes the length of the data type specified in the container in bits.	
BaseTypeDirectDefinition.baseTypeEncoding: This specifies, how an object of the current BaseType is encoded, e.g. in an ECU within a message sequence.	
DiagnosticValueNeeds.fixedLength: This attribute controls whether the data length of the data is fixed.	
M2 Parameter	
AsamHdo::BaseTypes::BaseTypeDirectDefinition.baseTypeSize, AsamHdo::BaseTypes::BaseTypeDirectDefinition.baseTypeEncoding, CommonStructure::ServiceNeeds::DiagnosticValueNeeds.fixedLength	

Mapping Rule		Mapping Type
baseTypeEncoding = 2C baseTypeSize = 32 maxNumberOfElements shall not exist arraySizeSemantics shall not exist Derivation from DiagnosticValueNeeds.fixedLength=1 possible.		full
Mapping Status	ECUC Parameter ID	
valid		

BSW Module	BSW Context	
Dcm	Dcm/DcmConfigSet/DcmDsp/DcmDspData/DcmDspDataType	
BSW Parameter	BSW Type	
SINT32_N	EcucEnumerationLiteralDef	
BSW Description	Type of the data is sint32 array.	
Template Description	<p>BaseTypeDirectDefinition.baseTypeSize: Describes the length of the data type specified in the container in bits.</p> <p>BaseTypeDirectDefinition.baseTypeEncoding: This specifies, how an object of the current BaseType is encoded, e.g. in an ECU within a message sequence.</p> <p>DiagnosticDataElement.arraySizeSemantics: This attribute controls the meaning of the value of the array size.</p> <p>DiagnosticDataElement.maxNumberOfElements: The existence of this attribute turns the data instance into an array of data. The attribute determines the size of the array in terms of how many elements the array can take.</p> <p>DiagnosticValueNeeds.fixedLength: This attribute controls whether the data length of the data is fixed.</p>	
M2 Parameter	AsamHdo::BaseTypes::BaseTypeDirectDefinition.baseTypeSize, AsamHdo::BaseTypes::BaseTypeDirectDefinition.baseTypeEncoding DiagnosticExtract::CommonDiagnostics::DiagnosticDataElement.arraySizeSemantics DiagnosticExtract::CommonDiagnostics::DiagnosticDataElement.maxNumberOfElements, CommonStructure::ServiceNeeds::DiagnosticValueNeeds.fixedLength	
Mapping Rule	Mapping Type	
baseTypeEncoding = 2C baseTypeSize = 32 maxNumberOfElements exists and value is greater than 0 (cf. TPS_DEXT_01001) arraySizeSemantics either does not exist or exists and is set to ArraySizeSemanticsEnum.fixedSize (cf. TPS_DEXT_01001) Derivation from DiagnosticValueNeeds.fixedLength=1 possible.		full
Mapping Status	ECUC Parameter ID	
valid		

BSW Module	BSW Context

Dcm	Dcm/DcmConfigSet/DcmDsp/DcmDspData/DcmDspDataType	
BSW Parameter		BSW Type
SINT8		EcucEnumerationLiteralDef
BSW Description		
Type of the data is sint8.		
Template Description		
BaseTypeDirectDefinition.baseTypeSize: Describes the length of the data type specified in the container in bits.		
BaseTypeDirectDefinition.baseTypeEncoding: This specifies, how an object of the current BaseType is encoded, e.g. in an ECU within a message sequence.		
DiagnosticValueNeeds.fixedLength: This attribute controls whether the data length of the data is fixed.		
M2 Parameter		
AsamHdo::BaseTypes::BaseTypeDirectDefinition.baseTypeSize, AsamHdo::BaseTypes::BaseTypeDirectDefinition.baseTypeEncoding, CommonStructure::ServiceNeeds::DiagnosticValueNeeds.fixedLength		
Mapping Rule		Mapping Type
baseTypeEncoding = 2C baseTypeSize = 8 maxNumberOfElements shall not exist arraySizeSemantics shall not exist Derivation from DiagnosticValueNeeds.fixedLength=1 possible.		full
Mapping Status		ECUC Parameter ID
valid		

BSW Module	BSW Context	
Dcm	Dcm/DcmConfigSet/DcmDsp/DcmDspData/DcmDspDataType	
BSW Parameter		BSW Type
SINT8_N		EcucEnumerationLiteralDef
BSW Description		
Type of the data is sint8 array.		
Template Description		
BaseTypeDirectDefinition.baseTypeSize: Describes the length of the data type specified in the container in bits.		
BaseTypeDirectDefinition.baseTypeEncoding: This specifies, how an object of the current BaseType is encoded, e.g. in an ECU within a message sequence.		
DiagnosticDataElement.arraySizeSemantics: This attribute controls the meaning of the value of the array size.		
DiagnosticDataElement.maxNumberOfElements: The existence of this attribute turns the data instance into an array of data. The attribute determines the size of the array in terms of how many elements the array can take.		
DiagnosticValueNeeds.fixedLength: This attribute controls whether the data length of the data is fixed.		
M2 Parameter		

AsamHdo::BaseTypes::BaseTypeDirectDefinition.baseTypeSize, AsamHdo::BaseTypes::BaseTypeDirectDefinition.baseTypeEncoding DiagnosticExtract::CommonDiagnostics::DiagnosticDataElement.arraySizeSemantics DiagnosticExtract::CommonDiagnostics::DiagnosticDataElement.maxNumberOfElements, CommonStructure::ServiceNeeds::DiagnosticValueNeeds.fixedLength	
Mapping Rule	Mapping Type
baseTypeEncoding = 2C baseTypeSize = 8 maxNumberOfElements exists and value is greater than 0 (cf. TPS_DEXT_01001) arraySizeSemantics either does not exist or exists and is set to ArraySizeSemanticsEnum.fixedSize (cf. TPS_DEXT_01001) Derivation from DiagnosticValueNeeds.fixedLength=1 possible.	full
Mapping Status	ECUC Parameter ID
valid	

BSW Module	BSW Context
Dcm	Dcm/DcmConfigSet/DcmDsp/DcmDspData/DcmDspDataType
BSW Parameter	BSW Type
UINT16	EcucEnumerationLiteralDef
BSW Description	
Type of the data is uint16.	
Template Description	
BaseTypeDirectDefinition.baseTypeEncoding: This specifies, how an object of the current BaseType is encoded, e.g. in an ECU within a message sequence.	
BaseTypeDirectDefinition.baseTypeSize: Describes the length of the data type specified in the container in bits.	
DiagnosticValueNeeds.fixedLength: This attribute controls whether the data length of the data is fixed.	
M2 Parameter	
AsamHdo::BaseTypes::BaseTypeDirectDefinition.baseTypeEncoding, AsamHdo::BaseTypes::BaseTypeDirectDefinition.baseTypeSize, CommonStructure::ServiceNeeds::DiagnosticValueNeeds.fixedLength	
Mapping Rule	Mapping Type
baseTypeEncoding = NONE, UTF-16 baseTypeSize = 16 maxNumberOfElements shall not exist arraySizeSemantics shall not exist Derivation from DiagnosticValueNeeds.fixedLength=1 possible.	full
Mapping Status	ECUC Parameter ID
valid	

BSW Module	BSW Context
Dcm	Dcm/DcmConfigSet/DcmDsp/DcmDspData/DcmDspDataType
BSW Parameter	BSW Type
UINT16_N	EcucEnumerationLiteralDef
BSW Description	

Type of the data is uint16 array.	
Template Description	
<p>BaseTypeDirectDefinition.baseTypeEncoding: This specifies, how an object of the current BaseType is encoded, e.g. in an ECU within a message sequence.</p> <p>BaseTypeDirectDefinition.baseTypeSize: Describes the length of the data type specified in the container in bits.</p> <p>DiagnosticDataElement.arraySizeSemantics: This attribute controls the meaning of the value of the array size.</p> <p>DiagnosticDataElement.maxNumberOfElements: The existence of this attribute turns the data instance into an array of data. The attribute determines the size of the array in terms of how many elements the array can take.</p> <p>DiagnosticValueNeeds.fixedLength: This attribute controls whether the data length of the data is fixed.</p>	
M2 Parameter	
AsamHdo::BaseTypes::BaseTypeDirectDefinition.baseTypeEncoding, AsamHdo::BaseTypes::BaseTypeDirectDefinition.baseTypeSize DiagnosticExtract::CommonDiagnostics::DiagnosticDataElement.arraySizeSemantics DiagnosticExtract::CommonDiagnostics::DiagnosticDataElement.maxNumberOfElements, CommonStructure::ServiceNeeds::DiagnosticValueNeeds.fixedLength	
Mapping Rule	Mapping Type
baseTypeEncoding = NONE, UTF-16 baseTypeSize = 16 maxNumberOfElements exists and value is greater than 0 (cf. TPS_DEXT_01001) arraySizeSemantics either does not exist or exists and is set to ArraySizeSemanticsEnum.fixedSize (cf. TPS_DEXT_01001) Derivation from DiagnosticValueNeeds.fixedLength=1 possible.	full
Mapping Status	ECUC Parameter ID
valid	

BSW Module	BSW Context
Dcm	Dcm/DcmConfigSet/DcmDsp/DcmDspData/DcmDspDataType
BSW Parameter	BSW Type
UINT32	EcucEnumerationLiteralDef
BSW Description	
Type of the data is uint32.	
Template Description	
<p>BaseTypeDirectDefinition.baseTypeEncoding: This specifies, how an object of the current BaseType is encoded, e.g. in an ECU within a message sequence.</p> <p>BaseTypeDirectDefinition.baseTypeSize: Describes the length of the data type specified in the container in bits.</p> <p>DiagnosticValueNeeds.fixedLength: This attribute controls whether the data length of the data is fixed.</p>	
M2 Parameter	

AsamHdo::BaseTypes::BaseTypeDirectDefinition.baseTypeEncoding, AsamHdo::BaseTypes::BaseTypeDirectDefinition.baseTypeSize, CommonStructure::ServiceNeeds::DiagnosticValueNeeds.fixedLength	
Mapping Rule	Mapping Type
baseTypeEncoding = NONE, UTF-32 baseTypeSize = 32 maxNumberOfElements shall not exist arraySizeSemantics shall not exist Derivation from DiagnosticValueNeeds.fixedLength=1 possible.	full
Mapping Status	ECUC Parameter ID
valid	

BSW Module	BSW Context
Dcm	Dcm/DcmConfigSet/DcmDsp/DcmDspData/DcmDspDataType
BSW Parameter	BSW Type
UINT32_N	EcucEnumerationLiteralDef
BSW Description	
Type of the data is uint32 array.	
Template Description	
<p>BaseTypeDirectDefinition.baseTypeEncoding: This specifies, how an object of the current BaseType is encoded, e.g. in an ECU within a message sequence.</p> <p>BaseTypeDirectDefinition.baseTypeSize: Describes the length of the data type specified in the container in bits.</p> <p>DiagnosticDataElement.arraySizeSemantics: This attribute controls the meaning of the value of the array size.</p> <p>DiagnosticDataElement.maxNumberOfElements: The existence of this attribute turns the data instance into an array of data. The attribute determines the size of the array in terms of how many elements the array can take.</p> <p>DiagnosticValueNeeds.fixedLength: This attribute controls whether the data length of the data is fixed.</p>	
M2 Parameter	
AsamHdo::BaseTypes::BaseTypeDirectDefinition.baseTypeEncoding, AsamHdo::BaseTypes::BaseTypeDirectDefinition.baseTypeSize DiagnosticExtract::CommonDiagnostics::DiagnosticDataElement.arraySizeSemantics DiagnosticExtract::CommonDiagnostics::DiagnosticDataElement.maxNumberOfElements, CommonStructure::ServiceNeeds::DiagnosticValueNeeds.fixedLength	
Mapping Rule	Mapping Type
baseTypeEncoding = NONE, UTF-32 baseTypeSize = 32 maxNumberOfElements exists and value is greater than 0 (cf. TPS_DEXT_01001) arraySizeSemantics either does not exist or exists and is set to ArraySizeSemanticsEnum.fixedSize (cf. TPS_DEXT_01001) Derivation from DiagnosticValueNeeds.fixedLength=1 possible.	full
Mapping Status	ECUC Parameter ID
valid	

BSW Module	BSW Context	
Dcm	Dcm/DcmConfigSet/DcmDsp/DcmDspData/DcmDspDataType	
BSW Parameter	BSW Type	
UINT8	EcucEnumerationLiteralDef	
BSW Description	Type of the data is uint8.	
Template Description	<p>BaseTypeDirectDefinition.baseTypeEncoding: This specifies, how an object of the current BaseType is encoded, e.g. in an ECU within a message sequence.</p> <p>BaseTypeDirectDefinition.baseTypeSize: Describes the length of the data type specified in the container in bits.</p> <p>DiagnosticValueNeeds.fixedLength: This attribute controls whether the data length of the data is fixed.</p>	
M2 Parameter	AsamHdo::BaseTypes::BaseTypeDirectDefinition.baseTypeEncoding, AsamHdo::BaseTypes::BaseTypeDirectDefinition.baseTypeSize, CommonStructure::ServiceNeeds::DiagnosticValueNeeds.fixedLength	
Mapping Rule	Mapping Type	
baseTypeEncoding = NONE, WINDOWS-1252, UTF-8, BCD-P, BCD-UP baseTypeSize = 8 maxNumberOfElements shall not exist arraySizeSemantics shall not exist	full	
Derivation from DiagnosticValueNeeds.fixedLength=1 possible.		
Mapping Status	ECUC Parameter ID	
valid		

BSW Module	BSW Context	
Dcm	Dcm/DcmConfigSet/DcmDsp/DcmDspData/DcmDspDataType	
BSW Parameter	BSW Type	
UINT8_DYN	EcucEnumerationLiteralDef	
BSW Description	Type of the data is uint8 array with dynamic length.	
Template Description	<p>BaseTypeDirectDefinition.baseTypeEncoding: This specifies, how an object of the current BaseType is encoded, e.g. in an ECU within a message sequence.</p> <p>BaseTypeDirectDefinition.baseTypeSize: Describes the length of the data type specified in the container in bits.</p> <p>DiagnosticDataElement.arraySizeSemantics: This attribute controls the meaning of the value of the array size.</p> <p>DiagnosticDataElement.maxNumberOfElements: The existence of this attribute turns the data instance into an array of data. The attribute determines the size of the array in terms of how many elements the array can take.</p> <p>DiagnosticValueNeeds.fixedLength: This attribute controls whether the data length of the data is fixed.</p>	

M2 Parameter	
AsamHdo::BaseTypes::BaseTypeDirectDefinition.baseTypeEncoding, AsamHdo::BaseTypes::BaseTypeDirectDefinition.baseTypeSize DiagnosticExtract::CommonDiagnostics::DiagnosticDataElement.arraySizeSemantics DiagnosticExtract::CommonDiagnostics::DiagnosticDataElement.maxNumberOfElements, CommonStructure::ServiceNeeds::DiagnosticValueNeeds.fixedLength	
Mapping Rule	Mapping Type
baseTypeEncoding = NONE, WINDOWS-1252, UTF-8, BCD-P, BCD-UP baseTypeSize = 8 maxNumberOfElements exists and value is greater than 0 (cf. TPS_DEXT_01002) arraySizeSemantics exists and is set to ArraySizeSemanticsEnum.variableSize (cf. TPS_DEXT_01002) Derivation from DiagnosticValueNeeds.fixedLength=0 possible.	full
Mapping Status	ECUC Parameter ID
valid	

BSW Module	BSW Context
Dcm	Dcm/DcmConfigSet/DcmDsp/DcmDspData/DcmDspDataType
BSW Parameter	BSW Type
UINT8_N	EcucEnumerationLiteralDef
BSW Description	
Type of the data is uint8 array.	
Template Description	
<p>BaseTypeDirectDefinition.baseTypeEncoding: This specifies, how an object of the current BaseType is encoded, e.g. in an ECU within a message sequence.</p> <p>BaseTypeDirectDefinition.baseTypeSize: Describes the length of the data type specified in the container in bits.</p> <p>DiagnosticDataElement.arraySizeSemantics: This attribute controls the meaning of the value of the array size.</p> <p>DiagnosticDataElement.maxNumberOfElements: The existence of this attribute turns the data instance into an array of data. The attribute determines the size of the array in terms of how many elements the array can take.</p> <p>DiagnosticValueNeeds.fixedLength: This attribute controls whether the data length of the data is fixed.</p>	
M2 Parameter	
AsamHdo::BaseTypes::BaseTypeDirectDefinition.baseTypeEncoding, AsamHdo::BaseTypes::BaseTypeDirectDefinition.baseTypeSize DiagnosticExtract::CommonDiagnostics::DiagnosticDataElement.arraySizeSemantics DiagnosticExtract::CommonDiagnostics::DiagnosticDataElement.maxNumberOfElements, CommonStructure::ServiceNeeds::DiagnosticValueNeeds.fixedLength	
Mapping Rule	Mapping Type

baseTypeEncoding = NONE, WINDOWS-1252, UTF-8, BCD-P, BCD-UP baseTypeSize = 8 maxNumberOfElements exists and value is greater than 0 (cf. TPS_DEXT_01001) arraySizeSemantics either does not exist or exists and is set to ArraySizeSemanticsEnum.fixedSize (cf. TPS_DEXT_01001)		full
Derivation from DiagnosticValueNeeds.fixedLength=1 possible.		
Mapping Status	ECUC Parameter ID	
valid		

BSW Module	BSW Context	
Dcm	Dcm/DcmConfigSet/DcmDsp/DcmDspData	
BSW Parameter	BSW Type	
DcmDspDataUsePort	EcucEnumerationParamDef	
BSW Description		
Defines which interface shall be used to access the data.		
Template Description		
This attribute controls whether interaction requires the software-component to react synchronously on a request or whether it processes the request in background but still the DCM has to issue the call again to eventually obtain the result of the request.		
M2 Parameter		
CommonStructure::ServiceNeeds::DiagnosticValueNeeds.processingStyle		
Mapping Rule		Mapping Type
1:1 mapping		full
Mapping Status	ECUC Parameter ID	
valid	[ECUC_Dcm_00713]	

BSW Module	BSW Context	
Dcm	Dcm/DcmConfigSet/DcmDsp/DcmDspData/DcmDspDataUsePort	
BSW Parameter	BSW Type	
USE_DATA_ASYNC_CLIENT_SERVER	EcucEnumerationLiteralDef	
BSW Description		
The DCM will access the Data using an R-Port requiring a asynchronous ClientServerInterface DataServices_{Data}. The R-Port is named DataServices_{Data} where {Data} is the name of the container DcmDspData.		
Template Description		
The software-component processes the request in background but still the Dcm has to issue the call again to eventually obtain the result of the request.		
M2 Parameter		
CommonStructure::ServiceNeeds::DiagnosticProcessingStyleEnum.processingStyleAsynchronous		
Mapping Rule		Mapping Type
DiagnosticServiceSwMapping is having a SwcServiceDependency and ServiceNeeds::DiagnosticProcessingStyleEnum is equal to processingStyleAsynchronous		full
Mapping Status	ECUC Parameter ID	
valid		

BSW Module	BSW Context	
Dcm	Dcm/DcmConfigSet/DcmDsp/DcmDspData/DcmDspDataUsePort	
BSW Parameter	BSW Type	

USE_DATA_ASYNC_CLIENT_SERVER_ERROR	EcucEnumerationLiteralDef
BSW Description	
The Dcm will access the Data using an R-Port requiring a asynchronous ClientServerInterface DataServices_{Data}. The parameter ErrorCode can be returned to allow the application to trigger a negative response during the operation. The R-Port is named DataServices_{Data} where {Data} is the name of the container DcmDspData.	
Template Description	
The software-component processes the request in background but still the Dcm has to issue the call again to eventually obtain the result of the request or handle error code.	
M2 Parameter	
CommonStructure::ServiceNeeds::DiagnosticProcessingStyleEnum.processingStyleAsynchronousWithError	
Mapping Rule	Mapping Type
DiagnosticServiceSwMapping is having a SwcServiceDependency and ServiceNeeds::DiagnosticProcessingStyleEnum is equal to processingStyleAsynchronousWithError	full
Mapping Status	ECUC Parameter ID
valid	

BSW Module	BSW Context
Dcm	Dcm/DcmConfigSet/DcmDsp/DcmDspData/DcmDspDataUsePort
BSW Parameter	BSW Type
USE_DATA_SYNC_CLIENT_SERVER	EcucEnumerationLiteralDef
BSW Description	
The DCM will access the Data using an R-Port requiring a synchronous ClientServerInterface DataServices_{Data}. The R-Port is named DataServices_{Data} where {Data} is the name of the container DcmDspData.	
Template Description	
The software-component is supposed to react synchronously on the request.	
M2 Parameter	
CommonStructure::ServiceNeeds::DiagnosticProcessingStyleEnum.processingStyleSynchronous	
Mapping Rule	Mapping Type
DiagnosticServiceSwMapping is having a SwcServiceDependency and ServiceNeeds::DiagnosticProcessingStyleEnum is equal to processingStyleSynchronous	full
Mapping Status	ECUC Parameter ID
valid	

BSW Module	BSW Context
Dcm	Dcm/DcmConfigSet/DcmDsp/DcmDspData/DcmDspDiagnosisScaling/DcmDspAlternativeDataInterface
BSW Parameter	BSW Type
DcmDataElement	EcucForeignReferenceDef
BSW Description	
Alternative Diagnosis Representation for the data defined by the means of a VariableDataPrototype in a DataInterface.	
The CompuMethod of the data type of the referenced VariableDataPrototype will be applied to the data type of the VariableDataPrototype in the interface used by the Dcm.	
Template Description	

<p>A VariableDataPrototype is used to contain values in an ECU application. This means that most likely a VariableDataPrototype allocates "static" memory on the ECU. In some cases optimization strategies might lead to a situation where the memory allocation can be avoided.</p> <p>In particular, the value of a VariableDataPrototype is likely to change as the ECU on which it is used executes.</p>	
M2 Parameter	
SWComponentTemplate::Datatype::DataPrototypes::VariableDataPrototype	
Mapping Rule	Mapping Type
1:1 mapping	full
Mapping Status	ECUC Parameter ID
valid	[ECUC_Dcm_00995]

BSW Module	BSW Context
Dcm	Dcm/DcmConfigSet/DcmDsp/DcmDspData/DcmDspDiagnosisScaling/DcmDspAlternativeDataInterface
BSW Parameter	BSW Type
DcmPortInterfaceMapping	EcucForeignReferenceDef
BSW Description	
Optional reference to PortInterfaceMapping which defines the mapping rules.	
<p>The PortInterfaceMapping is used to get the DataPrototypeMapping that describes a conversion between the data prototype referenced by DcmDataElement and the data prototype referenced from DcmDspExternalSRDataElementClass.</p>	
Template Description	
Specifies one PortInterfaceMapping to support the connection of Ports typed by two different PortInterfaces with PortInterface elements having unequal names and/or unequal semantic (resolution or range).	
M2 Parameter	
SWComponentTemplate::PortInterface::PortInterfaceMapping	
Mapping Rule	Mapping Type
1:1 mapping	full
Mapping Status	ECUC Parameter ID
valid	[ECUC_Dcm_00996]

BSW Module	BSW Context
Dcm	Dcm/DcmConfigSet/DcmDsp/DcmDspData/DcmDspDiagnosisScaling/DcmDspAlternativeDataType
BSW Parameter	BSW Type
DcmApplicationDataType	EcucForeignReferenceDef
BSW Description	
Alternative Diagnosis Representation for the data defined by the means of a ApplicationDataType of category VALUE, BOOLEAN or ARRAY.	
<p>The CompuMethod that applies to the referenced ApplicationDataType in case of category VALUE or BOOLEAN will be applied to the data type of the VariableDataPrototype in the interface used by the Dcm.</p>	
Template Description	
A primitive data type defines a set of allowed values.	
M2 Parameter	
SWComponentTemplate::Datatype::Datatypes::ApplicationPrimitiveDataType	
Mapping Rule	Mapping Type

1:1 mapping	full
Mapping Status	ECUC Parameter ID
valid	[ECUC_Dcm_00998]

BSW Module	BSW Context	
Dcm	Dcm/DcmConfigSet/DcmDsp/DcmDspDid	
BSW Parameter	BSW Type	
DcmDspDidIdentifier	EcucIntegerParamDef	
BSW Description		
2 byte Identifier of the DID		
Within each DcmConfigSet all DcmDspDidIdentifier values shall be unique.		
Template Description		
DiagnosticAbstractDataIdentifier.id: This is the numerical identifier used to identify the DiagnosticAbstractDataIdentifier in the scope of diagnostic workflow		
DiagnosticValueNeeds.didNumber: This represents a Data identifier for the diagnostic value. This allows to predefine the DID number if the responsible function developer has received a particular requirement from the OEM or from a standardization body.		
M2 Parameter		
DiagnosticExtract::CommonDiagnostics::DiagnosticAbstractDataIdentifier.id, CommonStructure::ServiceNeeds::DiagnosticValueNeeds.didNumber		
Mapping Rule	Mapping Type	
1:1 mapping	full	
Mapping Status	ECUC Parameter ID	
valid	[ECUC_Dcm_00602]	

BSW Module	BSW Context	
Dcm	Dcm/DcmConfigSet/DcmDsp/DcmDspDidInfo/DcmDspDidControl	
BSW Parameter	BSW Type	
DcmDspDidFreezeCurrentState	EcucBooleanParamDef	
BSW Description		
This indicates the presence of "FreezeCurrentState".		
Template Description		
DiagnosticIOControl.freezeCurrentState: Setting this attribute to true represents the ability of the Dcm to execute a freezeCurrentState.		
DiagnosticIOControlNeeds.freezeCurrentStateSupported: This attribute determines, if the referenced port supports temporary freezing of I/O value.		
M2 Parameter		
DiagnosticExtract::Dcm::DiagnosticService::IOControl::DiagnosticIOControl.freezeCurrentState, CommonStructure::ServiceNeeds::DiagnosticIOControlNeeds.freezeCurrentStateSupported		
Mapping Rule	Mapping Type	
1:1 mapping	full	
Mapping Status	ECUC Parameter ID	
valid	[ECUC_Dcm_00624]	

BSW Module	BSW Context	
Dcm	Dcm/DcmConfigSet/DcmDsp/DcmDspDidInfo/DcmDspDidControl	

BSW Parameter		BSW Type
DcmDspDidResetToDefault		EcucBooleanParamDef
BSW Description		
This indicates the presence of "ResetToDefault".		
Template Description		
DiagnosticIOControl.resetToDefault: Setting this attribute to true represents the ability of the Dcm to execute a resetToDefault.		
DiagnosticIoControlNeeds.resetToDefaultSupported: This represents a flag for the existence of the ResetToDefault operation in the service interface.		
M2 Parameter		
DiagnosticExtract::Dcm::DiagnosticService::IOControl::DiagnosticIOControl.resetToDefault, CommonStructure::ServiceNeeds::DiagnosticIoControlNeeds.resetToDefaultSupported		
Mapping Rule		Mapping Type
1:1 mapping		full
Mapping Status		ECUC Parameter ID
valid		[ECUC_Dcm_00623]

BSW Module	BSW Context	
Dcm	Dcm/DcmConfigSet/DcmDsp/DcmDspDidInfo/DcmDspDidControl	
BSW Parameter		BSW Type
DcmDspDidShortTermAdjustment		EcucBooleanParamDef
BSW Description		
This indicates the presence of "ShortTermAdjustment".		
Template Description		
DiagnosticIOControl.shortTermAdjustment: Setting this attribute to true represents the ability of the Dcm to execute a shortTermAdjustment.		
DiagnosticIoControlNeeds.shortTermAdjustmentSupported: This attribute determines, if the referenced port supports temporarily setting of I/O value to a specific value provided by the diagnostic tester.		
M2 Parameter		
DiagnosticExtract::Dcm::DiagnosticService::IOControl::DiagnosticIOControl.shortTermAdjustment, CommonStructure::ServiceNeeds::DiagnosticIoControlNeeds.shortTermAdjustmentSupported		
Mapping Rule		Mapping Type
1:1 mapping		full
Mapping Status		ECUC Parameter ID
valid		[ECUC_Dcm_00625]

BSW Module	BSW Context	
Dcm	Dcm/DcmConfigSet/DcmDsp/DcmDspMemoryTransfer	
BSW Parameter		BSW Type
DcmDspMemoryTransferUsePort		EcucBooleanParamDef
BSW Description		
If this parameter is set to true, the Dcm uses a port requiring a PortInterface UploadDownload. If the parameter is false, the DCM uses the according C-API callouts.		
Template Description		
This meta-class represents the ability to specify needs regarding upload and download by means of diagnostic services.		
M2 Parameter		
CommonStructure::ServiceNeeds::DiagnosticUploadDownloadNeeds		
Mapping Rule		Mapping Type

1:1 mapping	full
Mapping Status	ECUC Parameter ID
valid	[ECUC_Dcm_01133]

BSW Module	BSW Context
Dcm	Dcm/DcmConfigSet/DcmDsp/DcmDspPid/DcmDspPidData
BSW Parameter	BSW Type
DcmDspPidDataByteSize	EcucIntegerParamDef
BSW Description	
Defines the array length in bytes or the the maximum array length for variable datalengths.	
Template Description	
BaseTypeDirectDefinition.baseTypeSize: Describes the length of the data type specified in the container in bits.	
DiagnosticDataElement.maxNumberOfElements: The existence of this attribute turns the data instance into an array of data. The attribute determines the size of the array in terms of how many elements the array can take.	
M2 Parameter	
AsamHdo::BaseTypes::BaseTypeDirectDefinition.baseTypeSize, DiagnosticExtract::CommonDiagnostics::DiagnosticDataElement.maxNumberOfElements	
Mapping Rule	Mapping Type
S/R via array: $DcmDspPidDataByteSize = \maxNumberOfElements * (baseTypeSize / 8)$ C/S of FNC callback: $DcmDspPidDataByteSize = \maxNumberOfElements$ Note: 8 is the baseTypeSize of UINT8	full
Mapping Status	ECUC Parameter ID
valid	[ECUC_Dcm_01108]

BSW Module	BSW Context
Dcm	Dcm/DcmConfigSet/DcmDsp/DcmDspPid/DcmDspPidData/DcmDspPidService01/DcmDspDiagnosisScaling/DcmDspAlternativeDataInterface
BSW Parameter	BSW Type
DcmDataElement	EcucForeignReferenceDef
BSW Description	
Alternative Diagnosis Representation for the data defined by the means of a VariableDataPrototype in a DataInterface.	
The CompuMethod of the data type of the referenced VariableDataPrototype will be applied to the data type of the VariableDataPrototype in the interface used by the Dcm.	
Template Description	
A VariableDataPrototype is used to contain values in an ECU application. This means that most likely a VariableDataPrototype allocates "static" memory on the ECU. In some cases optimization strategies might lead to a situation where the memory allocation can be avoided.	
In particular, the value of a VariableDataPrototype is likely to change as the ECU on which it is used executes.	
M2 Parameter	
SWComponentTemplate::Datatype::DataPrototypes::VariableDataPrototype	
Mapping Rule	Mapping Type
1:1 mapping	full

Mapping Status	ECUC Parameter ID
valid	[ECUC_Dcm_00995]

BSW Module	BSW Context	
Dcm	Dcm/DcmConfigSet/DcmDsp/DcmDspPid/DcmDspPidData/DcmDspPidService01/DcmDspDiagnosisScaling/DcmDspAlternativeDataInterface	
BSW Parameter	BSW Type	
DcmPortInterfaceMapping	EcucForeignReferenceDef	
BSW Description		
Optional reference to PortInterfaceMapping which defines the mapping rules.		
The PortInterfaceMapping is used to get the DataPrototypeMapping that describes a conversion between the data prototype referenced by DcmDataElement and the data prototype referenced from DcmDspExternalSRDataElementClass.		
Template Description		
Specifies one PortInterfaceMapping to support the connection of Ports typed by two different PortInterfaces with PortInterface elements having unequal names and/or unequal semantic (resolution or range).		
M2 Parameter		
SWComponentTemplate::PortInterface::PortInterfaceMapping		
Mapping Rule	Mapping Type	
1:1 mapping	full	
Mapping Status	ECUC Parameter ID	
valid	[ECUC_Dcm_00996]	

BSW Module	BSW Context	
Dcm	Dcm/DcmConfigSet/DcmDsp/DcmDspPid/DcmDspPidData/DcmDspPidService01/DcmDspDiagnosisScaling/DcmDspAlternativeDataType	
BSW Parameter	BSW Type	
DcmApplicationDataType	EcucForeignReferenceDef	
BSW Description		
Alternative Diagnosis Representation for the data defined by the means of a ApplicationDataType of category VALUE, BOOLEAN or ARRAY.		
The CompuMethod that applies to the referenced ApplicationDataType in case of category VALUE or BOOLEAN will be applied to the data type of the VariableDataPrototype in the interface used by the Dcm.		
Template Description		
A primitive data type defines a set of allowed values.		
M2 Parameter		
SWComponentTemplate::Datatype::Datatypes::ApplicationPrimitiveDataType		
Mapping Rule	Mapping Type	
1:1 mapping	full	
Mapping Status	ECUC Parameter ID	
valid	[ECUC_Dcm_00998]	

BSW Module	BSW Context	
Dcm	Dcm/DcmConfigSet/DcmDsp/DcmDspPid	
BSW Parameter	BSW Type	
DcmDspPidIdentifier	EcucIntegerParamDef	
BSW Description		

1 byte Identifier of the PID	
Within each DcmConfigSet all DcmDspPidIdentifier values shall be unique.	
Template Description	
ObdPidServiceNeeds.parameterId: Standardized parameter identifier (PID) according to the OBD standard specified in attribute "standard".	
DiagnosticParameterIdentifier.id: This is the numerical identifier used to identify the DiagnosticParameterIdentifier in the scope of diagnostic workflow (see SAE J1979-DA).	
M2 Parameter	
CommonStructure::ServiceNeeds::ObdPidServiceNeeds.parameterId, DiagnosticExtract::CommonDiagnostics::DiagnosticParameterIdentifier.id	
Mapping Rule	Mapping Type
1:1 mapping	full
Mapping Status	ECUC Parameter ID
valid	[ECUC_Dcm_00627]

BSW Module	BSW Context
Dcm	Dcm/DcmConfigSet/DcmDsp/DcmDspRequestControl
BSW Parameter	BSW Type
DcmDspRequestControlTestId	EcucIntegerParamDef
BSW Description	
Test Id for Service \$08	
Template Description	
ObdControlServiceNeeds.testId: Test Identifier (TID) according to ISO 15031-5.	
DiagnosticTestRoutineIdentifier.id: This represents the numerical id of the DiagnosticTestIdentifier (see SAE J1979-DA).	
M2 Parameter	
CommonStructure::ServiceNeeds::ObdControlServiceNeeds.testId, DiagnosticExtract::Dcm::ObdService::Mode_0x08_RequestControlOfOnBoardDevice::DiagnosticTestRoutineIdentifier.id	
Mapping Rule	Mapping Type
The value shall be taken from DiagnosticRequestControlOfOnBoardDevice.testId.id if available.	full
Mapping Status	ECUC Parameter ID
valid	[ECUC_Dcm_00656]

BSW Module	BSW Context
Dcm	Dcm/DcmConfigSet/DcmDsp/DcmDspRoutine
BSW Parameter	BSW Type
DcmDspRequestRoutineResults	EcucParamConfContainerDef
BSW Description	
Provides the configuration of RequestResult subservice for RoutineControl service. Existence indicates that the RequestRoutineResults in the RoutineControl is supported.	
Template Description	

DiagnosticRoutine.requestResult: This represents the ability to request the result of a running routine.	
DiagnosticRoutineNeeds.diagRoutineType: This denotes the type of diagnostic routine which is implemented by the referenced server port.	
M2 Parameter	
DiagnosticExtract::CommonDiagnostics::DiagnosticRoutine.requestResult, CommonStructure::ServiceNeeds::DiagnosticRoutineNeeds.diagRoutineType	
Mapping Rule	Mapping Type
1:1 mapping for DiagnosticRoutine.requestResult OR DiagnosticRoutineNeeds.diagRoutineType == asynchronous	full
Mapping Status	ECUC Parameter ID
valid	[ECUC_Dcm_01023]

BSW Module	BSW Context
Dcm	Dcm/DcmConfigSet/DcmDsp/DcmDspRoutine/DcmDspRequestRoutineRe- sults/DcmDspRequestRoutineResultsIn/DcmDspRequestRoutineResultsIn Signal/DcmDspArgumentScaling/DcmDspAlternativeArgumentData
BSW Parameter	BSW Type
DcmDataElement	EcucForeignReferenceDef
BSW Description	
Alternative Diagnosis Representation for the data defined by the means of a ArgumentDataProto- type. The CompuMethod of the data type of the referenced ArgumentDataPrototype will be applied to the data type of the ArgumentDataPrototype in the interface used by the Dcm.	
Template Description	
An argument of an operation, much like a data element, but also carries direction information and is owned by a particular ClientServerOperation.	
M2 Parameter	
SWComponentTemplate::PortInterface::ArgumentDataPrototype	
Mapping Rule	Mapping Type
1:1 mapping	full
Mapping Status	ECUC Parameter ID
valid	[ECUC_Dcm_01056]

BSW Module	BSW Context
Dcm	Dcm/DcmConfigSet/DcmDsp/DcmDspRoutine/DcmDspRequestRoutineRe- sults/DcmDspRequestRoutineResultsIn/DcmDspRequestRoutineResultsIn Signal/DcmDspArgumentScaling/DcmDspAlternativeDataType
BSW Parameter	BSW Type
DcmApplicationDataType	EcucForeignReferenceDef
BSW Description	
Alternative Diagnosis Representation for the data defined by the means of a ApplicationDataType of category VALUE, BOOLEAN or ARRAY. The CompuMethod that applies to the referenced ApplicationDataType in case of category VALUE or BOOLEAN will be applied to the data type of the VariableDataPrototype in the interface used by the Dcm.	

Template Description	
A primitive data type defines a set of allowed values.	
M2 Parameter	
SWComponentTemplate::Datatype::Datatypes::ApplicationPrimitiveDataType	
Mapping Rule	Mapping Type
1:1 mapping	full
Mapping Status	ECUC Parameter ID
valid	[ECUC_Dcm_00998]

BSW Module	BSW Context
Dcm	Dcm/DcmConfigSet/DcmDsp/DcmDspRoutine/DcmDspRequestRoutineResults/DcmDspRequestRoutineResultsIn/DcmDspRequestRoutineResultsInSignal/DcmDspRoutineSignalType
BSW Parameter	BSW Type
FLOAT	EcucEnumerationLiteralDef
BSW Description	
Type of the data is float.	
Template Description	
BaseTypeDirectDefinition.baseTypeEncoding: This specifies, how an object of the current BaseType is encoded, e.g. in an ECU within a message sequence.	
BaseTypeDirectDefinition.baseTypeSize: Describes the length of the data type specified in the container in bits.	
DiagnosticValueNeeds.fixedLength: This attribute controls whether the data length of the data is fixed.	
M2 Parameter	
AsamHdo::BaseTypes::BaseTypeDirectDefinition.baseTypeEncoding, AsamHdo::BaseTypes::BaseTypeDirectDefinition.baseTypeSize, CommonStructure::ServiceNeeds::DiagnosticValueNeeds.fixedLength	
Mapping Rule	Mapping Type
baseTypeEncoding = NONE, WINDOWS-1252, UTF-8, BCD-P, BCD-UP baseTypeSize = 8 maxNumberOfElements shall not exist arraySizeSemantics shall not exist Derivation from DiagnosticValueNeeds.fixedLength=1 possible.	full
Mapping Status	ECUC Parameter ID
valid	

BSW Module	BSW Context
Dcm	Dcm/DcmConfigSet/DcmDsp/DcmDspRoutine/DcmDspRequestRoutineResults/DcmDspRequestRoutineResultsIn/DcmDspRequestRoutineResultsInSignal/DcmDspRoutineSignalType
BSW Parameter	BSW Type
FLOAT_N	EcucEnumerationLiteralDef
BSW Description	
Type of the data is float array.	
Template Description	

BaseTypeDirectDefinition.baseTypeEncoding: This specifies, how an object of the current BaseType is encoded, e.g. in an ECU within a message sequence.	
BaseTypeDirectDefinition.baseTypeSize: Describes the length of the data type specified in the container in bits.	
DiagnosticValueNeeds.fixedLength: This attribute controls whether the data length of the data is fixed.	
M2 Parameter	
AsamHdo::BaseTypes::BaseTypeDirectDefinition.baseTypeEncoding, AsamHdo::BaseTypes::BaseTypeDirectDefinition.baseTypeSize, CommonStructure::ServiceNeeds::DiagnosticValueNeeds.fixedLength	
Mapping Rule	Mapping Type
baseTypeEncoding = NONE, WINDOWS-1252, UTF-8, BCD-P, BCD-UP baseTypeSize = 8 maxNumberOfElements shall not exist arraySizeSemantics shall not exist Derivation from DiagnosticValueNeeds.fixedLength=1 possible.	full
Mapping Status	ECUC Parameter ID
valid	

BSW Module	BSW Context
Dcm	Dcm/DcmConfigSet/DcmDsp/DcmDspRoutine/DcmDspRequestRoutineResults/DcmDspRequestRoutineResultsOut/DcmDspRequestRoutineResultsOutSignal/DcmDspArgumentScaling/DcmDspAlternativeArgumentData
BSW Parameter	BSW Type
DcmDataElement	EcucForeignReferenceDef
BSW Description	
Alternative Diagnosis Representation for the data defined by the means of a ArgumentDataPrototype.	
The CompuMethod of the data type of the referenced ArgumentDataPrototype will be applied to the data type of the ArgumentDataPrototype in the interface used by the Dcm.	
Template Description	
An argument of an operation, much like a data element, but also carries direction information and is owned by a particular ClientServerOperation.	
M2 Parameter	
SWComponentTemplate::PortInterface::ArgumentDataPrototype	
Mapping Rule	Mapping Type
1:1 mapping	full
Mapping Status	ECUC Parameter ID
valid	[ECUC_Dcm_01056]

BSW Module	BSW Context
Dcm	Dcm/DcmConfigSet/DcmDsp/DcmDspRoutine/DcmDspRequestRoutineResults/DcmDspRequestRoutineResultsOut/DcmDspRequestRoutineResultsOutSignal/DcmDspArgumentScaling/DcmDspAlternativeDataType
BSW Parameter	BSW Type
DcmApplicationDataType	EcucForeignReferenceDef
BSW Description	

Alternative Diagnosis Representation for the data defined by the means of a ApplicationDataType of category VALUE, BOOLEAN or ARRAY.	
The CompuMethod that applies to the referenced ApplicationDataType in case of category VALUE or BOOLEAN will be applied to the data type of the VariableDataPrototype in the interface used by the Dcm.	
Template Description	
A primitive data type defines a set of allowed values.	
M2 Parameter	
SWComponentTemplate::Datatype::Datatypes::ApplicationPrimitiveDataType	
Mapping Rule	Mapping Type
1:1 mapping	full
Mapping Status	ECUC Parameter ID
valid	[ECUC_Dcm_00998]

BSW Module	BSW Context
Dcm	Dcm/DcmConfigSet/DcmDsp/DcmDspRoutine/DcmDspRequestRoutineResults/DcmDspRequestRoutineResultsOut/DcmDspRequestRoutineResultsOutSignal/DcmDspRoutineSignalType
BSW Parameter	BSW Type
FLOAT	EcucEnumerationLiteralDef
BSW Description	
Type of the data is float.	
Template Description	
BaseTypeDirectDefinition.baseTypeEncoding: This specifies, how an object of the current BaseType is encoded, e.g. in an ECU within a message sequence.	
BaseTypeDirectDefinition.baseTypeSize: Describes the length of the data type specified in the container in bits.	
DiagnosticValueNeeds.fixedLength: This attribute controls whether the data length of the data is fixed.	
M2 Parameter	
AsamHdo::BaseTypes::BaseTypeDirectDefinition.baseTypeEncoding, AsamHdo::BaseTypes::BaseTypeDirectDefinition.baseTypeSize, CommonStructure::ServiceNeeds::DiagnosticValueNeeds.fixedLength	
Mapping Rule	Mapping Type
baseTypeEncoding = NONE, WINDOWS-1252, UTF-8, BCD-P, BCD-UP baseTypeSize = 8 maxNumberOfElements shall not exist arraySizeSemantics shall not exist Derivation from DiagnosticValueNeeds.fixedLength=1 possible.	full
Mapping Status	ECUC Parameter ID
valid	

BSW Module	BSW Context
Dcm	Dcm/DcmConfigSet/DcmDsp/DcmDspRoutine/DcmDspRequestRoutineResults/DcmDspRequestRoutineResultsOut/DcmDspRequestRoutineResultsOutSignal/DcmDspRoutineSignalType
BSW Parameter	BSW Type

FLOAT_N	EcucEnumerationLiteralDef
BSW Description	
Type of the data is float array.	
Template Description	
BaseTypeDirectDefinition.baseTypeEncoding: This specifies, how an object of the current BaseType is encoded, e.g. in an ECU within a message sequence.	
BaseTypeDirectDefinition.baseTypeSize: Describes the length of the data type specified in the container in bits.	
DiagnosticValueNeeds.fixedLength: This attribute controls whether the data length of the data is fixed.	
M2 Parameter	
AsamHdo::BaseTypes::BaseTypeDirectDefinition.baseTypeEncoding, AsamHdo::BaseTypes::BaseTypeDirectDefinition.baseTypeSize, CommonStructure::ServiceNeeds::DiagnosticValueNeeds.fixedLength	
Mapping Rule	Mapping Type
baseTypeEncoding = NONE, WINDOWS-1252, UTF-8, BCD-P, BCD-UP baseTypeSize = 8 maxNumberOfElements shall not exist arraySizeSemantics shall not exist Derivation from DiagnosticValueNeeds.fixedLength=1 possible.	full
Mapping Status	ECUC Parameter ID
valid	

BSW Module	BSW Context
Dcm	Dcm/DcmConfigSet/DcmDsp/DcmDspRoutine
BSW Parameter	BSW Type
DcmDspRoutineIdentifier	EcucIntegerParamDef
BSW Description	
2 bytes Identifier of the RID Within each DcmConfigSet all DcmDspRoutineIdentifier values shall be unique.	
Template Description	
DiagnosticRoutine.id: This is the numerical identifier used to identify the DiagnosticRoutine in the scope of diagnostic workflow	
DiagnosticRoutineNeeds.ridNumber: This represents a routine identifier for the diagnostic routine. This allows to predefine the RID number if the a function developer has received a particular requirement from the OEM or from a standardization body.	
M2 Parameter	
DiagnosticExtract::CommonDiagnostics::DiagnosticRoutine.id, CommonStructure::ServiceNeeds::DiagnosticRoutineNeeds.ridNumber	
Mapping Rule	Mapping Type
1:1 mapping	full
Mapping Status	ECUC Parameter ID
valid	[ECUC_Dcm_00641]

BSW Module	BSW Context	
Dcm	Dcm/DcmConfigSet/DcmDsp/DcmDspRoutine	
BSW Parameter		BSW Type
DcmDspStartRoutine		EcucParamConfContainerDef
BSW Description		
Provides the configuration of Start subservice for RoutineControl service.		
Template Description		
DiagnosticRoutine.start: This represents the ability to start a routine		
DiagnosticRoutineNeeds: Specifies the general needs on the configuration of the Diagnostic Communication Manager (Dcm) which are not related to a particular item (e.g. a PID). The main use case is the mapping of service ports to the Dcm which are not related to a particular item.		
M2 Parameter		
DiagnosticExtract::CommonDiagnostics::DiagnosticRoutine.start, CommonStructure::ServiceNeeds::DiagnosticRoutineNeeds		
Mapping Rule		Mapping Type
A routine always comes with a start routine, independently of whether the execution is done synchronously or asynchronously.		full
Mapping Status		ECUC Parameter ID
valid		[ECUC_Dcm_01021]

BSW Module	BSW Context	
Dcm	Dcm/DcmConfigSet/DcmDsp/DcmDspRoutine/DcmDspStartRoutine/DcmDspStartRoutineIn/DcmDspStartRoutineInSignal/DcmDspArgumentScaling/DcmDspAlternativeArgumentData	
BSW Parameter		BSW Type
DcmDataElement		EcucForeignReferenceDef
BSW Description		
Alternative Diagnosis Representation for the data defined by the means of a ArgumentDataPrototype.		
The CompuMethod of the data type of the referenced ArgumentDataPrototype will be applied to the data type of the ArgumentDataPrototype in the interface used by the Dcm.		
Template Description		
An argument of an operation, much like a data element, but also carries direction information and is owned by a particular ClientServerOperation.		
M2 Parameter		
SWComponentTemplate::PortInterface::ArgumentDataPrototype		
Mapping Rule		Mapping Type
1:1 mapping		full
Mapping Status		ECUC Parameter ID
valid		[ECUC_Dcm_01056]

BSW Module	BSW Context	
Dcm	Dcm/DcmConfigSet/DcmDsp/DcmDspRoutine/DcmDspStartRoutine/DcmDspStartRoutineIn/DcmDspStartRoutineInSignal/DcmDspArgumentScaling/DcmDspAlternativeDataType	
BSW Parameter		BSW Type
DcmApplicationDataType		EcucForeignReferenceDef
BSW Description		

Alternative Diagnosis Representation for the data defined by the means of a ApplicationDataType of category VALUE, BOOLEAN or ARRAY.	
The CompuMethod that applies to the referenced ApplicationDataType in case of category VALUE or BOOLEAN will be applied to the data type of the VariableDataPrototype in the interface used by the Dcm.	
Template Description	
A primitive data type defines a set of allowed values.	
M2 Parameter	
SWComponentTemplate::Datatype::Datatypes::ApplicationPrimitiveDataType	
Mapping Rule	Mapping Type
1:1 mapping	full
Mapping Status	ECUC Parameter ID
valid	[ECUC_Dcm_00998]

BSW Module	BSW Context
Dcm	Dcm/DcmConfigSet/DcmDsp/DcmDspRoutine/DcmDspStartRoutine/DcmDspStartRoutineIn/DcmDspStartRoutineInSignal/DcmDspRoutineSignalType
BSW Parameter	BSW Type
FLOAT	EcucEnumerationLiteralDef
BSW Description	
Type of the data is float.	
Template Description	
BaseTypeDirectDefinition.baseTypeEncoding: This specifies, how an object of the current BaseType is encoded, e.g. in an ECU within a message sequence.	
BaseTypeDirectDefinition.baseTypeSize: Describes the length of the data type specified in the container in bits.	
DiagnosticValueNeeds.fixedLength: This attribute controls whether the data length of the data is fixed.	
M2 Parameter	
AsamHdo::BaseTypes::BaseTypeDirectDefinition.baseTypeEncoding, AsamHdo::BaseTypes::BaseTypeDirectDefinition.baseTypeSize, CommonStructure::ServiceNeeds::DiagnosticValueNeeds.fixedLength	
Mapping Rule	Mapping Type
baseTypeEncoding = NONE, WINDOWS-1252, UTF-8, BCD-P, BCD-UP baseTypeSize = 8 maxNumberOfElements shall not exist arraySizeSemantics shall not exist Derivation from DiagnosticValueNeeds.fixedLength=1 possible.	full
Mapping Status	ECUC Parameter ID
valid	

BSW Module	BSW Context
Dcm	Dcm/DcmConfigSet/DcmDsp/DcmDspRoutine/DcmDspStartRoutine/DcmDspStartRoutineIn/DcmDspStartRoutineInSignal/DcmDspRoutineSignalType
BSW Parameter	BSW Type
FLOAT_N	EcucEnumerationLiteralDef
BSW Description	

Type of the data is float array.	
Template Description	
BaseTypeDirectDefinition.baseTypeEncoding: This specifies, how an object of the current BaseType is encoded, e.g. in an ECU within a message sequence.	
BaseTypeDirectDefinition.baseTypeSize: Describes the length of the data type specified in the container in bits.	
DiagnosticValueNeeds.fixedLength: This attribute controls whether the data length of the data is fixed.	
M2 Parameter	
AsamHdo::BaseTypes::BaseTypeDirectDefinition.baseTypeEncoding, AsamHdo::BaseTypes::BaseTypeDirectDefinition.baseTypeSize, CommonStructure::ServiceNeeds::DiagnosticValueNeeds.fixedLength	
Mapping Rule	Mapping Type
baseTypeEncoding = NONE, WINDOWS-1252, UTF-8, BCD-P, BCD-UP baseTypeSize = 8 numberOfElements shall not exist arraySizeSemantics shall not exist Derivation from DiagnosticValueNeeds.fixedLength=1 possible.	full
Mapping Status	ECUC Parameter ID
valid	

BSW Module	BSW Context
Dcm	Dcm/DcmConfigSet/DcmDsp/DcmDspRoutine/DcmDspStartRoutine/DcmDspStartRoutineOut/DcmDspStartRoutineOutSignal/DcmDspArgumentScaling/DcmDspAlternativeArgumentData
BSW Parameter	BSW Type
DcmDataElement	EcucForeignReferenceDef
BSW Description	
Alternative Diagnosis Representation for the data defined by the means of a ArgumentDataPrototype.	
The CompuMethod of the data type of the referenced ArgumentDataPrototype will be applied to the data type of the ArgumentDataPrototype in the interface used by the Dcm.	
Template Description	
An argument of an operation, much like a data element, but also carries direction information and is owned by a particular ClientServerOperation.	
M2 Parameter	
SWComponentTemplate::PortInterface::ArgumentDataPrototype	
Mapping Rule	Mapping Type
1:1 mapping	full
Mapping Status	ECUC Parameter ID
valid	[ECUC_Dcm_01056]

BSW Module	BSW Context
Dcm	Dcm/DcmConfigSet/DcmDsp/DcmDspRoutine/DcmDspStartRoutine/DcmDspStartRoutineOut/DcmDspStartRoutineOutSignal/DcmDspArgumentScaling/DcmDspAlternativeData Type
BSW Parameter	BSW Type

DcmApplicationDataType	EcucForeignReferenceDef
BSW Description	
Alternative Diagnosis Representation for the data defined by the means of a ApplicationDataType of category VALUE, BOOLEAN or ARRAY.	
The CompuMethod that applies to the referenced ApplicationDataType in case of category VALUE or BOOLEAN will be applied to the data type of the VariableDataPrototype in the interface used by the Dcm.	
Template Description	
A primitive data type defines a set of allowed values.	
M2 Parameter	
SWComponentTemplate::Datatype::Datatypes::ApplicationPrimitiveDataType	
Mapping Rule	Mapping Type
1:1 mapping	full
Mapping Status	ECUC Parameter ID
valid	[ECUC_Dcm_00998]

BSW Module	BSW Context
Dcm	Dcm/DcmConfigSet/DcmDsp/DcmDspRoutine/DcmDspStartRoutine/DcmDspStartRoutineOut/DcmDspStartRoutineOutSignal/DcmDspRoutineSignalType
BSW Parameter	BSW Type
FLOAT	EcucEnumerationLiteralDef
BSW Description	
Type of the data is float.	
Template Description	
BaseTypeDirectDefinition.baseTypeEncoding: This specifies, how an object of the current BaseType is encoded, e.g. in an ECU within a message sequence.	
BaseTypeDirectDefinition.baseTypeSize: Describes the length of the data type specified in the container in bits.	
DiagnosticValueNeeds.fixedLength: This attribute controls whether the data length of the data is fixed.	
M2 Parameter	
AsamHdo::BaseTypes::BaseTypeDirectDefinition.baseTypeEncoding, AsamHdo::BaseTypes::BaseTypeDirectDefinition.baseTypeSize, CommonStructure::ServiceNeeds::DiagnosticValueNeeds.fixedLength	
Mapping Rule	Mapping Type
baseTypeEncoding = NONE, WINDOWS-1252, UTF-8, BCD-P, BCD-UP baseTypeSize = 8 maxNumberOfElements shall not exist arraySizeSemantics shall not exist Derivation from DiagnosticValueNeeds.fixedLength=1 possible.	full
Mapping Status	ECUC Parameter ID
valid	

BSW Module	BSW Context
Dcm	Dcm/DcmConfigSet/DcmDsp/DcmDspRoutine/DcmDspStartRoutine/DcmDspStartRoutineOut/DcmDspStartRoutineOutSignal/DcmDspRoutineSignalType
BSW Parameter	BSW Type

FLOAT_N	EcucEnumerationLiteralDef
BSW Description	
Type of the data is float array.	
Template Description	
BaseTypeDirectDefinition.baseTypeEncoding: This specifies, how an object of the current BaseType is encoded, e.g. in an ECU within a message sequence.	
BaseTypeDirectDefinition.baseTypeSize: Describes the length of the data type specified in the container in bits.	
DiagnosticValueNeeds.fixedLength: This attribute controls whether the data length of the data is fixed.	
M2 Parameter	
AsamHdo::BaseTypes::BaseTypeDirectDefinition.baseTypeEncoding, AsamHdo::BaseTypes::BaseTypeDirectDefinition.baseTypeSize, CommonStructure::ServiceNeeds::DiagnosticValueNeeds.fixedLength	
Mapping Rule	Mapping Type
baseTypeEncoding = NONE, WINDOWS-1252, UTF-8, BCD-P, BCD-UP baseTypeSize = 8 maxNumberOfElements shall not exist arraySizeSemantics shall not exist Derivation from DiagnosticValueNeeds.fixedLength=1 possible.	full
Mapping Status	ECUC Parameter ID
valid	

BSW Module	BSW Context
Dcm	Dcm/DcmConfigSet/DcmDsp/DcmDspRoutine
BSW Parameter	BSW Type
DcmDspStopRoutine	EcucParamConfContainerDef
BSW Description	
Provides the configuration of Stop subservice for RoutineControl service. Existence indicates that the StopRoutine in the RoutineControl is supported.	
Template Description	
DiagnosticRoutine.stop: This represents the ability to stop a running routine.	
DiagnosticRoutineNeeds.diagRoutineType: This denotes the type of diagnostic routine which is implemented by the referenced server port.	
M2 Parameter	
DiagnosticExtract::CommonDiagnostics::DiagnosticRoutine.stop, CommonStructure::ServiceNeeds::DiagnosticRoutineNeeds.diagRoutineType	
Mapping Rule	Mapping Type
1:1 mapping for DiagnosticRoutine.stop OR DiagnosticRoutineNeeds.diagRoutineType == asynchronous	full
Mapping Status	ECUC Parameter ID
valid	[ECUC_Dcm_01022]

BSW Module	BSW Context	
Dcm	Dcm/DcmConfigSet/DcmDsp/DcmDspRoutine/DcmDspStopRoutine/DcmDspStopRoutineIn/DcmDspStopRoutineInSignal/DcmDspArgumentScaling/DcmDspAlternativeArgumentData	
BSW Parameter		BSW Type
DcmDataElement		EcucForeignReferenceDef
BSW Description		
Alternative Diagnosis Representation for the data defined by the means of a ArgumentDataPrototype.		
The CompuMethod of the data type of the referenced ArgumentDataPrototype will be applied to the data type of the ArgumentDataPrototype in the interface used by the Dcm.		
Template Description		
An argument of an operation, much like a data element, but also carries direction information and is owned by a particular ClientServerOperation.		
M2 Parameter		
SWComponentTemplate::PortInterface::ArgumentDataPrototype		
Mapping Rule		Mapping Type
1:1 mapping		full
Mapping Status		ECUC Parameter ID
valid		[ECUC_Dcm_01056]

BSW Module	BSW Context	
Dcm	Dcm/DcmConfigSet/DcmDsp/DcmDspRoutine/DcmDspStopRoutine/DcmDspStopRoutineIn/DcmDspStopRoutineInSignal/DcmDspArgumentScaling/DcmDspAlternativeDataType	
BSW Parameter		BSW Type
DcmApplicationDataType		EcucForeignReferenceDef
BSW Description		
Alternative Diagnosis Representation for the data defined by the means of a ApplicationDataType of category VALUE, BOOLEAN or ARRAY.		
The CompuMethod that applies to the referenced ApplicationDataType in case of category VALUE or BOOLEAN will be applied to the data type of the VariableDataPrototype in the interface used by the Dcm.		
Template Description		
A primitive data type defines a set of allowed values.		
M2 Parameter		
SWComponentTemplate::Datatype::Datatypes::ApplicationPrimitiveDataType		
Mapping Rule		Mapping Type
1:1 mapping		full
Mapping Status		ECUC Parameter ID
valid		[ECUC_Dcm_00998]

BSW Module	BSW Context	
Dcm	Dcm/DcmConfigSet/DcmDsp/DcmDspRoutine/DcmDspStopRoutine/DcmDspStopRoutineIn/DcmDspStopRoutineInSignal/DcmDspRoutineSignalType	
BSW Parameter		BSW Type
FLOAT		EcucEnumerationLiteralDef
BSW Description		
Type of the data is float.		
Template Description		

BaseTypeDirectDefinition.baseTypeEncoding: This specifies, how an object of the current BaseType is encoded, e.g. in an ECU within a message sequence.	
BaseTypeDirectDefinition.baseTypeSize: Describes the length of the data type specified in the container in bits.	
DiagnosticValueNeeds.fixedLength: This attribute controls whether the data length of the data is fixed.	
M2 Parameter	
AsamHdo::BaseTypes::BaseTypeDirectDefinition.baseTypeEncoding, AsamHdo::BaseTypes::BaseTypeDirectDefinition.baseTypeSize, CommonStructure::ServiceNeeds::DiagnosticValueNeeds.fixedLength	
Mapping Rule	Mapping Type
baseTypeEncoding = NONE, WINDOWS-1252, UTF-8, BCD-P, BCD-UP baseTypeSize = 8 maxNumberOfElements shall not exist arraySizeSemantics shall not exist Derivation from DiagnosticValueNeeds.fixedLength=1 possible.	full
Mapping Status	ECUC Parameter ID
valid	

BSW Module	BSW Context
Dcm	Dcm/DcmConfigSet/DcmDsp/DcmDspRoutine/DcmDspStopRoutine/DcmDspStopRoutineIn/DcmDspStopRoutineInSignal/DcmDspRoutineSignalType
BSW Parameter	BSW Type
FLOAT_N	EcucEnumerationLiteralDef
BSW Description	
Type of the data is float array.	
Template Description	
BaseTypeDirectDefinition.baseTypeEncoding: This specifies, how an object of the current BaseType is encoded, e.g. in an ECU within a message sequence.	
BaseTypeDirectDefinition.baseTypeSize: Describes the length of the data type specified in the container in bits.	
DiagnosticValueNeeds.fixedLength: This attribute controls whether the data length of the data is fixed.	
M2 Parameter	
AsamHdo::BaseTypes::BaseTypeDirectDefinition.baseTypeEncoding, AsamHdo::BaseTypes::BaseTypeDirectDefinition.baseTypeSize, CommonStructure::ServiceNeeds::DiagnosticValueNeeds.fixedLength	
Mapping Rule	Mapping Type
baseTypeEncoding = NONE, WINDOWS-1252, UTF-8, BCD-P, BCD-UP baseTypeSize = 8 maxNumberOfElements shall not exist arraySizeSemantics shall not exist Derivation from DiagnosticValueNeeds.fixedLength=1 possible.	full
Mapping Status	ECUC Parameter ID
valid	

BSW Module	BSW Context	
Dcm	Dcm/DcmConfigSet/DcmDsp/DcmDspRoutine/DcmDspStopRoutine/DcmDspStopRoutineOut/DcmDspStopRoutineOutSignal/DcmDspArgumentScaling/DcmDspAlternativeArgumentData	
BSW Parameter		BSW Type
DcmDataElement		EcucForeignReferenceDef
BSW Description		
Alternative Diagnosis Representation for the data defined by the means of a ArgumentDataPrototype.		
The CompuMethod of the data type of the referenced ArgumentDataPrototype will be applied to the data type of the ArgumentDataPrototype in the interface used by the Dcm.		
Template Description		
An argument of an operation, much like a data element, but also carries direction information and is owned by a particular ClientServerOperation.		
M2 Parameter		
SWComponentTemplate::PortInterface::ArgumentDataPrototype		
Mapping Rule		Mapping Type
1:1 mapping		full
Mapping Status		ECUC Parameter ID
valid		[ECUC_Dcm_01056]

BSW Module	BSW Context	
Dcm	Dcm/DcmConfigSet/DcmDsp/DcmDspRoutine/DcmDspStopRoutine/DcmDspStopRoutineOut/DcmDspStopRoutineOutSignal/DcmDspArgumentScaling/DcmDspAlternativeData Type	
BSW Parameter		BSW Type
DcmApplicationDataType		EcucForeignReferenceDef
BSW Description		
Alternative Diagnosis Representation for the data defined by the means of a ApplicationDataType of category VALUE, BOOLEAN or ARRAY.		
The CompuMethod that applies to the referenced ApplicationDataType in case of category VALUE or BOOLEAN will be applied to the data type of the VariableDataPrototype in the interface used by the Dcm.		
Template Description		
A primitive data type defines a set of allowed values.		
M2 Parameter		
SWComponentTemplate::Datatype::Datatypes::ApplicationPrimitiveDataType		
Mapping Rule		Mapping Type
1:1 mapping		full
Mapping Status		ECUC Parameter ID
valid		[ECUC_Dcm_00998]

BSW Module	BSW Context	
Dcm	Dcm/DcmConfigSet/DcmDsp/DcmDspRoutine/DcmDspStopRoutine/DcmDspStopRoutineOut/DcmDspStopRoutineOutSignal/DcmDspRoutineSignalType	
BSW Parameter		BSW Type
FLOAT		EcucEnumerationLiteralDef
BSW Description		
Type of the data is float.		
Template Description		

BaseTypeDirectDefinition.baseTypeEncoding: This specifies, how an object of the current BaseType is encoded, e.g. in an ECU within a message sequence.	
BaseTypeDirectDefinition.baseTypeSize: Describes the length of the data type specified in the container in bits.	
DiagnosticValueNeeds.fixedLength: This attribute controls whether the data length of the data is fixed.	
M2 Parameter	
AsamHdo::BaseTypes::BaseTypeDirectDefinition.baseTypeEncoding, AsamHdo::BaseTypes::BaseTypeDirectDefinition.baseTypeSize, CommonStructure::ServiceNeeds::DiagnosticValueNeeds.fixedLength	
Mapping Rule	Mapping Type
baseTypeEncoding = NONE, WINDOWS-1252, UTF-8, BCD-P, BCD-UP baseTypeSize = 8 maxNumberOfElements shall not exist arraySizeSemantics shall not exist Derivation from DiagnosticValueNeeds.fixedLength=1 possible.	full
Mapping Status	ECUC Parameter ID
valid	

BSW Module	BSW Context
Dcm	Dcm/DcmConfigSet/DcmDsp/DcmDspRoutine/DcmDspStopRoutine/DcmDspStopRoutineOut/DcmDspStopRoutineOutSignal/DcmDspRoutineSignalType
BSW Parameter	BSW Type
FLOAT_N	EcucEnumerationLiteralDef
BSW Description	
Type of the data is float array.	
Template Description	
BaseTypeDirectDefinition.baseTypeEncoding: This specifies, how an object of the current BaseType is encoded, e.g. in an ECU within a message sequence.	
BaseTypeDirectDefinition.baseTypeSize: Describes the length of the data type specified in the container in bits.	
DiagnosticValueNeeds.fixedLength: This attribute controls whether the data length of the data is fixed.	
M2 Parameter	
AsamHdo::BaseTypes::BaseTypeDirectDefinition.baseTypeEncoding, AsamHdo::BaseTypes::BaseTypeDirectDefinition.baseTypeSize, CommonStructure::ServiceNeeds::DiagnosticValueNeeds.fixedLength	
Mapping Rule	Mapping Type
baseTypeEncoding = NONE, WINDOWS-1252, UTF-8, BCD-P, BCD-UP baseTypeSize = 8 maxNumberOfElements shall not exist arraySizeSemantics shall not exist Derivation from DiagnosticValueNeeds.fixedLength=1 possible.	full
Mapping Status	ECUC Parameter ID
valid	

BSW Module	BSW Context	
Dcm	Dcm/DcmConfigSet/DcmDsp/DcmDspSecurity	
BSW Parameter	BSW Type	
DcmDspSecurityRow	EcucParamConfContainerDef	
BSW Description		
Definition of a single Row of configuration for security level configuration (per security level) The name of this container is used to define the name of the R-Port through which the DCM accesses the interface SecurityAccess_{SecurityLevel}. The R-Port is named SecurityAccess_{SecurityLevel} where {SecurityLevel} is the name of the container DcmDspSecurityRow. If there is no reference, no check of security level shall be done.		
Template Description		
This meta-class represents the needs of a software-component to verify the access to security level via diagnostic services.		
M2 Parameter		
CommonStructure::ServiceNeeds::DiagnosticsCommunicationSecurityNeeds		
Mapping Rule		Mapping Type
1:1 mapping		full
Mapping Status		ECUC Parameter ID
valid		[ECUC_Dcm_00759]

BSW Module	BSW Context	
Dcm	Dcm/DcmConfigSet/DcmDsp/DcmDspVehInfo	
BSW Parameter	BSW Type	
DcmDspVehInfoInfoType	EcucIntegerParamDef	
BSW Description		
value of InfoType.		
Within each DcmConfigSet all DcmDspVehInfoInfoType values shall be unique.		
Template Description		
ObdInfoServiceNeeds.infoType: The InfoType according to ISO 15031-5		
DiagnosticInfoType.id: This attribute represents the value of InfoType (see SAE J1979-DA).		
M2 Parameter		
CommonStructure::ServiceNeeds::ObdInfoServiceNeeds.infoType, DiagnosticExtract::CommonDiagnostics::DiagnosticInfoType.id		
Mapping Rule		Mapping Type
If DiagnosticRequestVehicleInfo, us DiagnosticRequestVehicleInfo.infoType.id.		full
Mapping Status		ECUC Parameter ID
valid		[ECUC_Dcm_00631]

G.6 Dem

BSW Module	BSW Context	
Dem	Dem/DemConfigSet	
BSW Parameter	BSW Type	
DemDebounceCounterBasedClass	EcucParamConfContainerDef	
BSW Description		
This container contains the configuration of Debounce Counter Based Class		
Template Description		

This meta-class represents the ability to indicate that the counter-based debounce algorithm shall be used by the DEM for this diagnostic monitor.	
This is related to set the ECUC choice container DemDebounceAlgorithmClass to DemDebounceCounterBased.	
M2 Parameter	
CommonStructure::ServiceNeeds::DiagEventDebounceCounterBased	
Mapping Rule	Mapping Type
1:1 mapping	full
Mapping Status	ECUC Parameter ID
valid	[ECUC_Dem_00881]

BSW Module	BSW Context
Dem	Dem/DemConfigSet/DemDebounceCounterBasedClass
BSW Parameter	BSW Type
DemDebounceCounterJumpDown	EcucBooleanParamDef
BSW Description	
Switch for the activation of Jump-Down.	
true: Jump-Down activated false: Jump-Down deactivated	
Template Description	
This value activates or deactivates the counter jump-down behavior.	
M2 Parameter	
CommonStructure::ServiceNeeds::DiagEventDebounceCounterBased.counterJumpDown	
Mapping Rule	Mapping Type
Shall be taken from DiagnosticExtract::DiagnosticCommonProps.debounceAlgorithmProps.debounceAlgorithm.counterJumpDown.	full
Applicable if DiagnosticExtract::DiagnosticCommonProps.debounceAlgorithmProps.debounceAlgorithm is modeled by means of a DiagEventDebounceCounterBased.	
Mapping Status	ECUC Parameter ID
valid	[ECUC_Dem_00685]

BSW Module	BSW Context
Dem	Dem/DemConfigSet/DemDebounceCounterBasedClass
BSW Parameter	BSW Type
DemDebounceCounterPassedThreshold	EcucIntegerParamDef
BSW Description	
Defines the value of the internal debounce counter, which indicates the passed status.	
Template Description	
This value defines the event-specific limit that indicates the "passed" counter status.	
M2 Parameter	
CommonStructure::ServiceNeeds::DiagEventDebounceCounterBased.counterPassedThreshold	
Mapping Rule	Mapping Type
Shall be taken from DiagnosticExtract::DiagnosticCommonProps.debounceAlgorithmProps.debounceAlgorithm.counterPassedThreshold.	full
Applicable if DiagnosticExtract::DiagnosticCommonProps.debounceAlgorithmProps.debounceAlgorithm is modeled by means of a DiagEventDebounceCounterBased.	

Mapping Status	ECUC Parameter ID
valid	[ECUC_Dem_00636]

BSW Module	BSW Context	
Dem	Dem/DemConfigSet/DemEventParameter	
BSW Parameter	BSW Type	
DemDebounceAlgorithmClass	EcucChoiceContainerDef	
BSW Description		
Debounce algorithm class: counter based, time based, or monitor internal.		
Template Description		
This class represents the ability to specify the pre-debounce algorithm which is selected and/or required by the particular monitor.		
This class inherits from Identifiable in order to allow further documentation of the expected or implemented debouncing and to use the category for the identification of the expected / implemented debouncing.		
M2 Parameter		
CommonStructure::ServiceNeeds::DiagEventDebounceAlgorithm		
Mapping Rule		Mapping Type
1:1 mapping		full
Mapping Status	ECUC Parameter ID	
valid	[ECUC_Dem_00604]	

BSW Module	BSW Context	
Dem	Dem/DemConfigSet/DemEventParameter/DemDebounceAlgorithmClass	
BSW Parameter	BSW Type	
DemDebounceCounterBased	EcucParamConfContainerDef	
BSW Description		
This container contains the configuration (parameters) for counter based debouncing.		
Template Description		
This meta-class represents the ability to indicate that the counter-based debounce algorithm shall be used by the DEM for this diagnostic monitor.		
This is related to set the ECUC choice container DemDebounceAlgorithmClass to DemDebounceCounterBased.		
M2 Parameter		
CommonStructure::ServiceNeeds::DiagEventDebounceCounterBased		
Mapping Rule		Mapping Type
There are two ways to derive the existence of DemDebounceCounterBased: <ol style="list-style-type: none"> DiagEventNeeds,diagEventDebounceAlgoritm exists and is modeled as a DiagEventDebounceCounterBased. DiagnosticContributionSet.commonProperties.debounceAlgorithm Props.debounceAlgorithm exists and is modeled as a DiagEventDebounceCounterBased If both alternatives exist at the same time then the definition of DiagnosticContributionSet.commonProperties.debounceAlgorithmProps.debounceAlgorithm shall be handled with priority.		full
Mapping Status	ECUC Parameter ID	
valid	[ECUC_Dem_00711]	

BSW Module	BSW Context	
Dem	Dem/DemConfigSet/DemEventParameter/DemDebounceAlgorithmClass	
BSW Parameter		BSW Type
DemDebounceMonitorInternal		EcucParamConfContainerDef
BSW Description		
This container contains the configuration (parameters) for monitor internal debouncing.		
Template Description		
This meta-class represents the ability to indicate that the pre-debounce algorithm shall be used by the Dem for this diagnostic monitor.		
This is related to setting the EcuC choice container DemDebounceAlgorithmClass to DemDebounceMonitorInternal.		
If the FaultDetectionAlogrithm is already known to be implemented by a specific BswModuleEntry the reference bswModuleEntry points to the function specification.		
If the FaultDetectionCounter value is accessible at a PortPrototype this PortPrototype shall be referenced by an assignedPort.		
M2 Parameter		
CommonStructure::ServiceNeeds::DiagEventDebounceMonitorInternal		
Mapping Rule		Mapping Type
1:1 mapping		full
Mapping Status		ECUC Parameter ID
valid		[ECUC_Dem_00712]

BSW Module	BSW Context	
Dem	Dem/DemConfigSet/DemEventParameter/DemDebounceAlgorithmClass	
BSW Parameter		BSW Type
DemDebounceTimeBase		EcucParamConfContainerDef
BSW Description		
This container contains the configuration (parameters) for time based debouncing.		
Template Description		
This meta-class represents the ability to indicate that the time-based pre-debounce algorithm shall be used by the Dem for this diagnostic monitor.		
This is related to set the EcuC choice container DemDebounceAlgorithmClass to DemDebounceTimeBase.		
M2 Parameter		
CommonStructure::ServiceNeeds::DiagEventDebounceTimeBased		
Mapping Rule		Mapping Type
1:1 mapping		full
Mapping Status		ECUC Parameter ID
valid		[ECUC_Dem_00713]

BSW Module	BSW Context	
Dem	Dem/DemGeneral/DemDataElementClass/DemExternalCSDDataElementClass/DemDataElementDataType	
BSW Parameter		BSW Type
FLOAT		EcucEnumerationLiteralDef
BSW Description		
Type of the data is float.		
Template Description		

BaseTypeDirectDefinition.baseTypeEncoding: This specifies, how an object of the current BaseType is encoded, e.g. in an ECU within a message sequence.	
BaseTypeDirectDefinition.baseTypeSize: Describes the length of the data type specified in the container in bits.	
DiagnosticValueNeeds.fixedLength: This attribute controls whether the data length of the data is fixed.	
M2 Parameter	
AsamHdo::BaseTypes::BaseTypeDirectDefinition.baseTypeEncoding, AsamHdo::BaseTypes::BaseTypeDirectDefinition.baseTypeSize, CommonStructure::ServiceNeeds::DiagnosticValueNeeds.fixedLength	
Mapping Rule	Mapping Type
baseTypeEncoding = NONE, WINDOWS-1252, UTF-8, BCD-P, BCD-UP baseTypeSize = 8 maxNumberOfElements shall not exist arraySizeSemantics shall not exist Derivation from DiagnosticValueNeeds.fixedLength=1 possible.	full
Mapping Status	ECUC Parameter ID
valid	

BSW Module	BSW Context
Dem	Dem/DemGeneral/DemDataElementClass/DemExternalCSDDataElementClass/ DemDataElementDataType
BSW Parameter	BSW Type
FLOAT_N	EcucEnumerationLiteralDef
BSW Description	
Type of the data is float array.	
Template Description	
BaseTypeDirectDefinition.baseTypeEncoding: This specifies, how an object of the current BaseType is encoded, e.g. in an ECU within a message sequence.	
BaseTypeDirectDefinition.baseTypeSize: Describes the length of the data type specified in the container in bits.	
DiagnosticValueNeeds.fixedLength: This attribute controls whether the data length of the data is fixed.	
M2 Parameter	
AsamHdo::BaseTypes::BaseTypeDirectDefinition.baseTypeEncoding, AsamHdo::BaseTypes::BaseTypeDirectDefinition.baseTypeSize, CommonStructure::ServiceNeeds::DiagnosticValueNeeds.fixedLength	
Mapping Rule	Mapping Type
baseTypeEncoding = NONE, WINDOWS-1252, UTF-8, BCD-P, BCD-UP baseTypeSize = 8 maxNumberOfElements shall not exist arraySizeSemantics shall not exist Derivation from DiagnosticValueNeeds.fixedLength=1 possible.	full
Mapping Status	ECUC Parameter ID
valid	

BSW Module	BSW Context	
Dem	Dem/DemGeneral/DemDataElementClass/DemExternalSRDataElementClass/DemDataElementDataType	
BSW Parameter	BSW Type	
FLOAT	EcucEnumerationLiteralDef	
BSW Description	Type of the data is float.	
Template Description	<p>BaseTypeDirectDefinition.baseTypeEncoding: This specifies, how an object of the current BaseType is encoded, e.g. in an ECU within a message sequence.</p> <p>BaseTypeDirectDefinition.baseTypeSize: Describes the length of the data type specified in the container in bits.</p> <p>DiagnosticValueNeeds.fixedLength: This attribute controls whether the data length of the data is fixed.</p>	
M2 Parameter	AsamHdo::BaseTypes::BaseTypeDirectDefinition.baseTypeEncoding, AsamHdo::BaseTypes::BaseTypeDirectDefinition.baseTypeSize, CommonStructure::ServiceNeeds::DiagnosticValueNeeds.fixedLength	
Mapping Rule	Mapping Type	
baseTypeEncoding = NONE, WINDOWS-1252, UTF-8, BCD-P, BCD-UP baseTypeSize = 8 maxNumberOfElements shall not exist arraySizeSemantics shall not exist Derivation from DiagnosticValueNeeds.fixedLength=1 possible.	full	
Mapping Status	ECUC Parameter ID	
valid		

BSW Module	BSW Context	
Dem	Dem/DemGeneral/DemDataElementClass/DemExternalSRDataElementClass/DemDataElementDataType	
BSW Parameter	BSW Type	
FLOAT_N	EcucEnumerationLiteralDef	
BSW Description	Type of the data is float array.	
Template Description	<p>BaseTypeDirectDefinition.baseTypeEncoding: This specifies, how an object of the current BaseType is encoded, e.g. in an ECU within a message sequence.</p> <p>BaseTypeDirectDefinition.baseTypeSize: Describes the length of the data type specified in the container in bits.</p> <p>DiagnosticValueNeeds.fixedLength: This attribute controls whether the data length of the data is fixed.</p>	
M2 Parameter	AsamHdo::BaseTypes::BaseTypeDirectDefinition.baseTypeEncoding, AsamHdo::BaseTypes::BaseTypeDirectDefinition.baseTypeSize, CommonStructure::ServiceNeeds::DiagnosticValueNeeds.fixedLength	
Mapping Rule	Mapping Type	

baseTypeEncoding = NONE, WINDOWS-1252, UTF-8, BCD-P, BCD-UP baseTypeSize = 8 maxNumberOfElements shall not exist arraySizeSemantics shall not exist Derivation from DiagnosticValueNeeds.fixedLength=1 possible.	full
Mapping Status	ECUC Parameter ID
valid	

BSW Module	BSW Context	
Dem	Dem/DemGeneral/DemDataElementClass/DemExternalSRDataElementClass/DemDiagnosisScaling/DemAlternativeDataInterface	
BSW Parameter		BSW Type
DemDataElement		EcucForeignReferenceDef
BSW Description		
Alternative Diagnosis Representation for the data defined by the means of a VariableDataPrototype in a DataInterface.		
The CompuMethod of the data type of the referenced VariableDataPrototype will be applied to the data type of the VariableDataPrototype in the interface used by the Dem.		
Template Description		
A VariableDataPrototype is used to contain values in an ECU application. This means that most likely a VariableDataPrototype allocates "static" memory on the ECU. In some cases optimization strategies might lead to a situation where the memory allocation can be avoided.		
In particular, the value of a VariableDataPrototype is likely to change as the ECU on which it is used executes.		
M2 Parameter		
SWComponentTemplate::Datatype::DataPrototypes::VariableDataPrototype		
Mapping Rule		Mapping Type
1:1 mapping		full
Mapping Status		ECUC Parameter ID
valid		[ECUC_Dem_00845]

BSW Module	BSW Context	
Dem	Dem/DemGeneral/DemDataElementClass/DemExternalSRDataElementClass/DemDiagnosisScaling/DemAlternativeDataInterface	
BSW Parameter		BSW Type
DemPortInterfaceMapping		EcucForeignReferenceDef
BSW Description		
Optional reference to PortInterfaceMapping which defines the mapping rules.		
The PortInterfaceMapping is used to get the DataPrototypeMapping that describes a conversion between the data prototype referenced by DemDataElement and the data prototype referenced from DcmDspExternalSRDataElementClass.		
Template Description		
Specifies one PortInterfaceMapping to support the connection of Ports typed by two different PortInterfaces with PortInterface elements having unequal names and/or unequal semantic (resolution or range).		
M2 Parameter		
SWComponentTemplate::PortInterface::PortInterfaceMapping		
Mapping Rule		Mapping Type

1:1 mapping	full
Mapping Status	ECUC Parameter ID
valid	[ECUC_Dem_00846]

BSW Module	BSW Context	
Dem	Dem/DemGeneral/DemDataElementClass/DemExternalSRDataElementClass/DemDiagnosisScaling/DemAlternativeDataType	
BSW Parameter	BSW Type	
DemApplicationDataType	EcucForeignReferenceDef	
BSW Description		
Alternative Diagnosis Representation for the data defined by the means of a ApplicationDataType of category VALUE, BOOLEAN or ARRAY.		
The CompuMethod that applies to the referenced ApplicationDataType in case of category VALUE or BOOLEAN will be applied to the data type of the VariableDataPrototype in the interface used by the Dem.		
Template Description		
A primitive data type defines a set of allowed values.		
M2 Parameter		
SWComponentTemplate::Datatype::Datatypes::ApplicationPrimitiveDataType		
Mapping Rule	Mapping Type	
1:1 mapping	full	
Mapping Status	ECUC Parameter ID	
valid	[ECUC_Dem_00848]	

G.7 BswM

BSW Module	BSW Context	
BswM	BswM/BswMConfig/BswMArbitration/BswMModeCondition/BswMConditionValue/BswMBswMode/BswMCompuScaleModeValue	
BSW Parameter	BSW Type	
BswMCompuMethodRef	EcucForeignReferenceDef	
BSW Description		
This is a foreign reference to the CompuMethod used for mode requests.		
Template Description		
This meta-class represents the ability to express the relationship between a physical value and the mathematical representation.		
Note that this is still independent of the technical implementation in data types. It only specifies the formula how the internal value corresponds to its physical pendant.		
M2 Parameter		
AsamHdo::ComputationMethod::CompuMethod		
Mapping Rule	Mapping Type	
1:1 mapping	full	
Mapping Status	ECUC Parameter ID	
valid	[ECUC_BswM_01040]	

BSW Module	BSW Context	
BswM	BswM/BswMConfig/BswMArbitration/BswMModeCondition/BswMConditionValue/BswMModeDeclaration	

BSW Parameter		BSW Type
BswMModeValueRef		EcucForeignReferenceDef
BSW Description		
This is a foreign reference to the Mode Declaration used for the mode requests corresponding to this condition.		
Template Description		
Declaration of one Mode. The name and semantics of a specific mode is not defined in the meta-model.		
M2 Parameter		
CommonStructure::ModeDeclaration::ModeDeclaration		
Mapping Rule		Mapping Type
1:1 mapping		full
Mapping Status		ECUC Parameter ID
valid		[ECUC_BswM_00864]

BSW Module	BSW Context	
BswM	BswM/BswMConfig/BswMArbitration/BswMModeRequestPort/BswMModeInit Value/BswMCompuScaleModeValue	
BSW Parameter		BSW Type
BswMCompuMethodRef		EcucForeignReferenceDef
BSW Description		
This is a foreign reference to the CompuMethod used for mode requests.		
Template Description		
This meta-class represents the ability to express the relationship between a physical value and the mathematical representation.		
Note that this is still independent of the technical implementation in data types. It only specifies the formula how the internal value corresponds to its physical pendant.		
M2 Parameter		
AsamHdo::ComputationMethod::CompuMethod		
Mapping Rule		Mapping Type
1:1 mapping		full
Mapping Status		ECUC Parameter ID
valid		[ECUC_BswM_01040]

BSW Module	BSW Context	
BswM	BswM/BswMConfig/BswMArbitration/BswMModeRequestPort/BswMMode RequestSource/BswMBswModeNotification	
BSW Parameter		BSW Type
BswMBswModeDeclarationGroupPrototypeRef		EcucForeignReferenceDef
BSW Description		
This is a foreign reference to the Mode Declaration Group Prototype.		
Template Description		
The ModeDeclarationGroupPrototype specifies a set of Modes (ModeDeclarationGroup) which is provided or required in the given context.		
M2 Parameter		
CommonStructure::ModeDeclaration::ModeDeclarationGroupPrototype		
Mapping Rule		Mapping Type
1:1 mapping		full
Mapping Status		ECUC Parameter ID
valid		[ECUC_BswM_00927]

BSW Module	BSW Context	
BswM	BswM/BswMConfig/BswMArbitration/BswMModeRequestPort/BswMModeRequestSource/BswMSwcModeNotification	
BSW Parameter		BSW Type
BswMSwcModeNotificationModeDeclarationGroupPrototypeRef		EcucForeignReferenceDef
BSW Description		
This is a foreign reference to the ModeDeclarationGroupPrototype.		
Template Description		
The ModeDeclarationGroupPrototype specifies a set of Modes (ModeDeclarationGroup) which is provided or required in the given context.		
M2 Parameter		
CommonStructure::ModeDeclaration::ModeDeclarationGroupPrototype		
Mapping Rule		Mapping Type
1:1 mapping		full
Mapping Status		ECUC Parameter ID
valid		[ECUC_BswM_00893]

BSW Module	BSW Context	
BswM	BswM/BswMConfig/BswMArbitration/BswMModeRequestPort/BswMModeRequestSource/BswMSwcModeRequest	
BSW Parameter		BSW Type
BswMSwcModeRequestVariableDataPrototypeRef		EcucForeignReferenceDef
BSW Description		
This is a reference to the VariableDataPrototype.		
Template Description		
<p>A VariableDataPrototype is used to contain values in an ECU application. This means that most likely a VariableDataPrototype allocates "static" memory on the ECU. In some cases optimization strategies might lead to a situation where the memory allocation can be avoided.</p> <p>In particular, the value of a VariableDataPrototype is likely to change as the ECU on which it is used executes.</p>		
M2 Parameter		
SWComponentTemplate::Datatype::DataPrototypes::VariableDataPrototype		
Mapping Rule		Mapping Type
1:1 mapping		full
Mapping Status		ECUC Parameter ID
valid		[ECUC_BswM_01046]

BSW Module	BSW Context	
BswM	BswM/BswMConfig/BswMDataTypeMappingSets	
BSW Parameter		BSW Type
BswMDataTypeMappingSetRef		EcucForeignReferenceDef
BSW Description		
Reference to DataTypeMappingSet.		
Template Description		
This class represents a list of mappings between ApplicationDataTypes and ImplementationDataTypes. In addition, it can contain mappings between ImplementationDataTypes and ModeDeclarationGroups.		
M2 Parameter		
SWComponentTemplate::Datatype::Datatypes::DataTypeMappingSet		
Mapping Rule		Mapping Type

1:1 mapping	full
Mapping Status	ECUC Parameter ID
valid	[ECUC_BswM_00937]

BSW Module	BSW Context	
BswM	BswM/BswMConfig/BswMModeControl/BswMAAction/BswMAvailableActions/BswMRteModeRequest	
BSW Parameter		BSW Type
BswMRequestedModeRef		EcucForeignReferenceDef
BSW Description		
This is a foreign reference to the Mode Declaration used for the mode request		
Template Description		
Declaration of one Mode. The name and semantics of a specific mode is not defined in the meta-model.		
M2 Parameter		
CommonStructure::ModeDeclaration::ModeDeclaration		
Mapping Rule		Mapping Type
1:1 mapping		full
Mapping Status	ECUC Parameter ID	
valid	[ECUC_BswM_01024]	

BSW Module	BSW Context	
BswM	BswM/BswMConfig/BswMModeControl/BswMAAction/BswMAvailableActions/BswMRteSwitch	
BSW Parameter		BSW Type
BswMSwitchedMode		EcucForeignReferenceDef
BSW Description		
This parameter contains the integer value that corresponds to a certain mode in a Mode Declaration Group.		
Template Description		
Declaration of one Mode. The name and semantics of a specific mode is not defined in the meta-model.		
M2 Parameter		
CommonStructure::ModeDeclaration::ModeDeclaration		
Mapping Rule		Mapping Type
1:1 mapping		full
Mapping Status	ECUC Parameter ID	
valid	[ECUC_BswM_00896]	

BSW Module	BSW Context	
BswM	BswM/BswMConfig/BswMModeControl/BswMAAction/BswMAvailableActions/BswMSchMSwitch	
BSW Parameter		BSW Type
BswMSchMModeDeclarationGroupRef		EcucForeignReferenceDef
BSW Description		
This is the reference to a ModeDeclarationGroup to define a ModeDeclarationGroupPrototype in the role BswModuleDescription.providedModeGroup.		
Template Description		
A collection of Mode Declarations. Also, the initial mode is explicitly identified.		
M2 Parameter		

CommonStructure::ModeDeclaration::ModeDeclarationGroup	
Mapping Rule	Mapping Type
1:1 mapping	full
Mapping Status	ECUC Parameter ID
valid	[ECUC_BswM_01031]

BSW Module	BSW Context
BswM	BswM/BswMConfig/BswMModeControl/BswMAction/BswMAvailableActions/BswMSchMSwitch
BSW Parameter	BSW Type
BswMSchMSwitchedMode	EcucForeignReferenceDef
BSW Description	
This parameter contains the integer value that corresponds to a certain mode in a Mode Declaration Group.	
Template Description	
Declaration of one Mode. The name and semantics of a specific mode is not defined in the meta-model.	
M2 Parameter	
CommonStructure::ModeDeclaration::ModeDeclaration	
Mapping Rule	Mapping Type
1:1 mapping	full
Mapping Status	ECUC Parameter ID
valid	[ECUC_BswM_00901]

BSW Module	BSW Context
BswM	BswM/BswMConfig/BswMModeControl/BswMRteModeRequestPort
BSW Parameter	BSW Type
BswMRteModeRequestPortInterfaceRef	EcucInstanceReferenceDef
BSW Description	
This is an instance reference to the variable data prototype used for the mode request.	
Template Description	
A VariableDataPrototype is used to contain values in an ECU application. This means that most likely a VariableDataPrototype allocates "static" memory on the ECU. In some cases optimization strategies might lead to a situation where the memory allocation can be avoided.	
In particular, the value of a VariableDataPrototype is likely to change as the ECU on which it is used executes.	
M2 Parameter	
SWComponentTemplate::Datatype::DataPrototypes::VariableDataPrototype	
Mapping Rule	Mapping Type
1:1 mapping	full
Mapping Status	ECUC Parameter ID
valid	[ECUC_BswM_01025]

BSW Module	BSW Context
BswM	BswM/BswMConfig/BswMModeControl/BswMRteModeRequestPort
BSW Parameter	BSW Type
BswMRteModeRequestVariableDataPrototypeSRRef	EcucForeignReferenceDef
BSW Description	
This is a foreign reference to a VariableDataPrototype used for the mode request.	

Template Description	
A VariableDataPrototype is used to contain values in an ECU application. This means that most likely a VariableDataPrototype allocates "static" memory on the ECU. In some cases optimization strategies might lead to a situation where the memory allocation can be avoided.	
In particular, the value of a VariableDataPrototype is likely to change as the ECU on which it is used executes.	
M2 Parameter	
SWComponentTemplate::Datatype::DataPrototypes::VariableDataPrototype	
Mapping Rule	Mapping Type
1:1 mapping	full
Mapping Status	ECUC Parameter ID
valid	[ECUC_BswM_01057]

BSW Module	BSW Context
BswM	BswM/BswMConfig/BswMModeControl/BswMSwitchPort
BSW Parameter	BSW Type
BswMModeSwitchInterfaceRef	EcucForeignReferenceDef
BSW Description	
Reference to the ModeSwitchInterface of this BswMModeSwitchPort.	
Template Description	
A mode switch interface declares a ModeDeclarationGroupPrototype to be sent and received.	
M2 Parameter	
SWComponentTemplate::PortInterface::ModeSwitchInterface	
Mapping Rule	Mapping Type
1:1 mapping	full
Mapping Status	ECUC Parameter ID
valid	[ECUC_BswM_00951]

G.8 MemMap

BSW Module	BSW Context
MemMap	MemMap/MemMapAllocation/MemMapGenericMapping
BSW Parameter	BSW Type
MemMapSwAddressMethodRef	EcucForeignReferenceDef
BSW Description	
Reference to the SwAddrMethod which applies to the MemMapGenericMapping.	
Template Description	
Used to assign a common addressing method, e.g. common memory section, to data or code objects. These objects could actually live in different modules or components.	
M2 Parameter	
DataDictionary::AuxillaryObjects::SwAddrMethod	
Mapping Rule	Mapping Type
1:1 mapping	full
Mapping Status	ECUC Parameter ID
valid	[ECUC_MemMap_00013]

BSW Module	BSW Context
MemMap	MemMap/MemMapAllocation/MemMapSectionSpecificMapping
BSW Parameter	BSW Type

MemMapMemorySectionRef	EcucForeignReferenceDef
BSW Description	
Reference to the MemorySection which applies to the MemMapSectionSpecificMapping.	
Template Description	
<p>Provides a description of an abstract memory section used in the Implementation for code or data. It shall be declared by the Implementation Description of the module or component, which actually allocates the memory in its code. This means in case of data prototypes which are allocated by the RTE, that the generated Implementation Description of the RTE shall contain the corresponding MemorySections.</p> <p>The attribute "symbol" (if symbol is missing: "shortName") defines the module or component specific section name used in the code. For details see the document "Specification of Memory Mapping".</p> <p>Typically the section name is build according the pattern:</p> <pre><SwAddrMethod shortName>[_<further specialization nominator>][_<alignment>]</pre> <p>where</p> <ul style="list-style-type: none"> * "[<SwAddrMethod shortName>]" is the shortName of the referenced SwAddrMethod * "[_<further specialization nominator>]" is an optional infix to indicate the specialization in the case that several MemorySections for different purpose of the same Implementation Description referring to the same or equally named SwAddrMethods. * "[_<alignment>]" is the alignment attributes value and is only applicable in the case that the memoryAllocationKeywordPolicy value of the referenced SwAddrMethod is set to addrMethodShortNameAndAlignment <p>MemorySection used to Implement the code of RunnableEntitys and BswSchedulableEntitys shall have a symbol (if missing: shortName) identical to the referred SwAddrMethod to conform to the generated RTE header files.</p> <p>In addition to the section name described above, a prefix is used in the corresponding macro code in order to define a name space. This prefix is by default given by the shortName of the BswModuleDescription resp. the SwComponentType. It can be superseded by the prefix attribute.</p>	
M2 Parameter	
CommonStructure::ResourceConsumption::MemorySectionUsage::MemorySection	
Mapping Rule	Mapping Type
1:1 mapping	full
Mapping Status	ECUC Parameter ID
valid	[ECUC_MemMap_00016]

G.9 RTE

BSW Module	BSW Context
Rte	Rte/RteImplicitCommunication
BSW Parameter	BSW Type
RteVariableReadAccessRef	EcucForeignReferenceDef
BSW Description	
Reference to the VariableAccess in the dataReadAccess role.	
Template Description	
<p>The presence of a VariableAccess implies that a RunnableEntity needs access to a VariableDataPrototype.</p> <p>The kind of access is specified by the role in which the class is used.</p>	
M2 Parameter	

SWComponentTemplate::SwcInternalBehavior::DataElements::VariableAccess	
Mapping Rule	Mapping Type
1:1 mapping	full
Mapping Status	ECUC Parameter ID
valid	[ECUC_Rte_09035]

BSW Module	BSW Context
Rte	Rte/RteImplicitCommunication
BSW Parameter	BSW Type
RteVariableWriteAccessRef	EcucForeignReferenceDef
BSW Description	
Reference to the VariableAccess in the dataWriteAccess role.	
Template Description	
The presence of a VariableAccess implies that a RunnableEntity needs access to a VariableDataPrototype.	
The kind of access is specified by the role in which the class is used.	
M2 Parameter	
SWComponentTemplate::SwcInternalBehavior::DataElements::VariableAccess	
Mapping Rule	Mapping Type
1:1 mapping	full
Mapping Status	ECUC Parameter ID
valid	[ECUC_Rte_09036]

BSW Module	BSW Context
Rte	Rte/RteOsInteraction/RteModeToScheduleTableMapping/RteModeSchtblMap Bsw
BSW Parameter	BSW Type
RteModeSchtblMapBswProvidedModeGroupRef	EcucForeignReferenceDef
BSW Description	
Reference to an instance of a ModeDeclarationGroupPrototype of a Bsw-Module.	
Template Description	
The ModeDeclarationGroupPrototype specifies a set of Modes (ModeDeclarationGroup) which is provided or required in the given context.	
M2 Parameter	
CommonStructure::ModeDeclaration::ModeDeclarationGroupPrototype	
Mapping Rule	Mapping Type
1:1 mapping	full
Mapping Status	ECUC Parameter ID
valid	[ECUC_Rte_09053]

BSW Module	BSW Context
Rte	Rte/RteOsInteraction/RteModeToScheduleTableMapping
BSW Parameter	BSW Type
RteModeSchtblMapModeDeclarationRef	EcucForeignReferenceDef
BSW Description	
Reference to the ModeDeclarations.	
Template Description	
Declaration of one Mode. The name and semantics of a specific mode is not defined in the meta-model.	

M2 Parameter	
CommonStructure::ModeDeclaration::ModeDeclaration	
Mapping Rule	Mapping Type
1:1 mapping	full
Mapping Status	ECUC Parameter ID
valid	[ECUC_Rte_09054]

BSW Module	BSW Context
Rte	Rte/RteOsInteraction/RteModeToScheduleTableMapping/RteModeSchtblMapSwc
BSW Parameter	BSW Type
RteModeSchtblMapSwcPortRef	EcucForeignReferenceDef
BSW Description	
Reference to the PPortPrototype of a SwComponentPrototype.	
Template Description	
Component port providing a certain port interface.	
M2 Parameter	
SWComponentTemplate::Components::PPortPrototype	
Mapping Rule	Mapping Type
1:1 mapping	full
Mapping Status	ECUC Parameter ID
valid	[ECUC_Rte_09057]

BSW Module	BSW Context
Rte	Rte/RteSwComponentInstance/RteEventTolsrMapping
BSW Parameter	BSW Type
RtelsrEventRef	EcucForeignReferenceDef
BSW Description	
Reference to the description of the ExternalTriggerOccurredEvent or TimingEvent which is pointing to the RunnableEntity being mapped. This allows a fine grained mapping of RunnableEntites based on the activating RTEEvent.	
Template Description	
Abstract base class for all RTE-related events	
M2 Parameter	
SWComponentTemplate::SwcInternalBehavior::RTEEvents::RTEEvent	
Mapping Rule	Mapping Type
1:1 mapping	full
Mapping Status	ECUC Parameter ID
valid	[ECUC_Rte_09153]

BSW Module	BSW Context
Rte	Rte/RteSwComponentInstance/RteEventToTaskMapping
BSW Parameter	BSW Type
RteActivationOffset	EcucFloatParamDef
BSW Description	
Activation offset in seconds.	
Template Description	
The value makes an assumption about the time offset of the first activation of the RunnableEntity triggered by the mapped TimingEvent relative to the periodic activation of the time base of this TimingEvent. Unit: second.	

M2 Parameter	
SWComponentTemplate::SwcInternalBehavior::RTEEvents::TimingEvent.offset	
Mapping Rule	Mapping Type
1:1 mapping	full
Mapping Status	ECUC Parameter ID
valid	[ECUC_Rte_09018]

BSW Module	BSW Context
Rte	Rte/RteSwComponentInstance/RteEventToTaskMapping
BSW Parameter	BSW Type
RteEventRef	EcucForeignReferenceDef
BSW Description	
Reference to the description of the RTEEvent which is pointing to the RunnableEntity being mapped. This allows a fine grained mapping of RunnableEntites based on the activating RTEEvent.	
Template Description	
Abstract base class for all RTE-related events	
M2 Parameter	
SWComponentTemplate::SwcInternalBehavior::RTEEvents::RTEEvent	
Mapping Rule	Mapping Type
1:1 mapping	full
Mapping Status	ECUC Parameter ID
valid	[ECUC_Rte_09019]

BSW Module	BSW Context
Rte	Rte/RteSwComponentInstance/RteExclusiveAreaImplementation
BSW Parameter	BSW Type
RteExclusiveAreaRef	EcucForeignReferenceDef
BSW Description	
Reference to the ExclusiveArea.	
Template Description	
Prevents an executable entity running in the area from being preempted.	
M2 Parameter	
CommonStructure::InternalBehavior::ExclusiveArea	
Mapping Rule	Mapping Type
1:1 mapping	full
Mapping Status	ECUC Parameter ID
valid	[ECUC_Rte_09032]

BSW Module	BSW Context
Rte	Rte/RteSwComponentInstance/RteInternalTriggerConfig
BSW Parameter	BSW Type
RteSwcTriggerSourceRef	EcucForeignReferenceDef
BSW Description	
Reference to an InternalTriggeringPoint of the related component instance.	
The referenced InternalTriggeringPoint has to belong to the same software component instance as the RteSwComponentInstance owning this parameter configures.	
Template Description	
If a RunnableEntity owns an InternalTriggeringPoint it is entitled to trigger the execution of RunnableEntities of the corresponding software-component.	

M2 Parameter	
SWComponentTemplate::SwcInternalBehavior::Trigger::InternalTriggeringPoint	
Mapping Rule	Mapping Type
1:1 mapping	full
Mapping Status	ECUC Parameter ID
valid	[ECUC_Rte_09097]

BSW Module	BSW Context
Rte	Rte/RteSwComponentInstance/RteNvRamAllocation
BSW Parameter	BSW Type
RteSwNvBlockDescriptorRef	EcucForeignReferenceDef
BSW Description	
Reference to the NvBlockDescriptor in case the RTE needs to call the NvM directly (e.g. for the supportDirtyFlag feature, storeCyclic feature, server invocation for NV data management or mode switch based invocation NvM services).	
Template Description	
Specifies the properties of exactly on NVRAM Block.	
M2 Parameter	
SWComponentTemplate::NvBlockComponent::NvBlockDescriptor	
Mapping Rule	Mapping Type
1:1 mapping	full
Mapping Status	ECUC Parameter ID
valid	[ECUC_Rte_09132]

BSW Module	BSW Context
Rte	Rte/RteSwComponentInstance/RteNvRamAllocation
BSW Parameter	BSW Type
RteSwNvRamMappingRef	EcucForeignReferenceDef
BSW Description	
Reference to the SwServiceDependency which is used to specify the NvBlockNeeds.	
Template Description	
Specialization of ServiceDependency in the context of an SwcInternalBehavior. It allows to associate ports, port groups and (in special cases) data defined for an atomic software component to a given ServiceNeeds element.	
M2 Parameter	
SWComponentTemplate::SwcInternalBehavior::ServiceMapping::SwcServiceDependency	
Mapping Rule	Mapping Type
1:1 mapping	full
Mapping Status	ECUC Parameter ID
valid	[ECUC_Rte_09044]

BSW Module	BSW Context
Rte	Rte/RteSwComponentInstance
BSW Parameter	BSW Type
RteSoftwareComponentInstanceRef	EcucForeignReferenceDef
BSW Description	
Reference to a SwComponentPrototype.	
Template Description	
Role of a software component within a composition.	
M2 Parameter	

SWComponentTemplate::Composition::SwComponentPrototype	
Mapping Rule	Mapping Type
1:1 mapping	full
Mapping Status	ECUC Parameter ID
valid	[ECUC_Rte_09004]

BSW Module	BSW Context
Rte	Rte/RteSwComponentType/RteComponentTypeCalibration
BSW Parameter	BSW Type
RteCalibrationSwAddrMethodRef	EcucForeignReferenceDef
BSW Description	
Reference to the SwAddrMethod for which software calibration support shall be enabled.	
Template Description	
Used to assign a common addressing method, e.g. common memory section, to data or code objects. These objects could actually live in different modules or components.	
M2 Parameter	
DataDictionary::AuxillaryObjects::SwAddrMethod	
Mapping Rule	Mapping Type
1:1 mapping	full
Mapping Status	ECUC Parameter ID
valid	[ECUC_Rte_09038]

BSW Module	BSW Context
Rte	Rte/RteSwComponentType
BSW Parameter	BSW Type
RteComponentTypeRef	EcucForeignReferenceDef
BSW Description	
Reference to either AtomicSwComponentType or ParameterSwComponentType.	
Template Description	
Base class for AUTOSAR software components.	
M2 Parameter	
SWComponentTemplate::Components::SwComponentType	
Mapping Rule	Mapping Type
1:1 mapping	full
Mapping Status	ECUC Parameter ID
valid	[ECUC_Rte_09003]

BSW Module	BSW Context
Rte	Rte/RteSwComponentType
BSW Parameter	BSW Type
RteImplementationRef	EcucForeignReferenceDef
BSW Description	
The Implementation which shall be assigned to the SwComponentType.	
Template Description	
This meta-class represents a specialization of the general Implementation meta-class with respect to the usage in application software.	
M2 Parameter	
SWComponentTemplate::SwImplementation::SwImplementation	
Mapping Rule	Mapping Type
1:1 mapping	full

Mapping Status	ECUC Parameter ID
valid	[ECUC_Rte_09028]

G.10 ECUC

BSW Module	BSW Context	
EcuC	EcuC/EcucConfigSet/EcucPduCollection/MetaDataType	
BSW Parameter		BSW Type
MetaDataType		EcucParamConfContainerDef
BSW Description		
The content of meta data in a Pdu consists of an ordered list of meta data items. This container represents a meta data item that is contained in meta data of a Pdu.		
Template Description		
This meta-class represents a single meta-data item.		
M2 Parameter		
SWComponentTemplate::PortInterface::MetaDataType		
Mapping Rule		Mapping Type
1:1 mapping		full
Mapping Status		ECUC Parameter ID
valid		[ECUC_EcuC_00074]

BSW Module	BSW Context	
EcuC	EcuC/EcucConfigSet/EcucPduCollection/MetaDataType/MetaDataType	
BSW Parameter		BSW Type
MetaDataTypeLength		EcucIntegerParamDef
BSW Description		
This parameter defines the length of a meta data item in bytes.		
Template Description		
This attribute determines the length of the MetaDataType at run-time.		
M2 Parameter		
SWComponentTemplate::PortInterface::MetaDataType.length		
Mapping Rule		Mapping Type
1:1 mapping		full
Mapping Status		ECUC Parameter ID
valid		[ECUC_EcuC_00075]

BSW Module	BSW Context	
EcuC	EcuC/EcucConfigSet/EcucPduCollection/MetaDataType/MetaDataType/MetaDataType	
BSW Parameter		BSW Type
ADDRESS_EXTENSION_8		EcucEnumerationLiteralDef
BSW Description		
Address extension field (N_AE) of the mixed addressing modes with 11bit and 29bit CAN ID of ISO 15765-2. Size: 8 bits.		
Template Description		
This aggregation contributes the specification of the concrete meta-data item type.		
M2 Parameter		
SWComponentTemplate::PortInterface::MetaDataType.metaDataType		
Mapping Rule		Mapping Type

SWComponentTemplate::PortInterface::MetaDatum.metaDatumType == A DDRESS_EXTENSION_16		full
Mapping Status	ECUC Parameter ID	
valid		

BSW Module	BSW Context	
EcuC	EcuC/EcucConfigSet/EcucPduCollection/MetaDataType/MetaDatum/MetaDatumType	
BSW Parameter	BSW Type	
CAN_ID_32	EcucEnumerationLiteralDef	
BSW Description		
CAN ID according to ISO 11898-2, either 29 bits or 11 bits. Encoding according to Can_IdType. Size: 32 bits.		
Template Description		
This aggregation contributes the specification of the concrete meta-data item type.		
M2 Parameter		
SWComponentTemplate::PortInterface::MetaDatum.metaDatumType		
Mapping Rule		Mapping Type
SWComponentTemplate::PortInterface::MetaDatum.metaDatumType == C AN_ID_32		full
Mapping Status	ECUC Parameter ID	
valid		

BSW Module	BSW Context	
EcuC	EcuC/EcucConfigSet/EcucPduCollection/MetaDataType/MetaDatum/MetaDatumType	
BSW Parameter	BSW Type	
ETHERNET_MAC_64	EcucEnumerationLiteralDef	
BSW Description		
Ethernet MAC address. Size: 64 bits.		
Template Description		
This aggregation contributes the specification of the concrete meta-data item type.		
M2 Parameter		
SWComponentTemplate::PortInterface::MetaDatum.metaDatumType		
Mapping Rule		Mapping Type
SWComponentTemplate::PortInterface::MetaDatum.metaDatumType == E ETHERNET_MAC_64		full
Mapping Status	ECUC Parameter ID	
valid		

BSW Module	BSW Context	
EcuC	EcuC/EcucConfigSet/EcucPduCollection/MetaDataType/MetaDatum/MetaDatumType	
BSW Parameter	BSW Type	
LIN_NAD_8	EcucEnumerationLiteralDef	
BSW Description		
LIN node address as used in the LIN transport protocol. Size: 8 bits.		
Template Description		
This aggregation contributes the specification of the concrete meta-data item type.		
M2 Parameter		

SWComponentTemplate::PortInterface::MetaDatum.metaDatumType	
Mapping Rule	Mapping Type
SWComponentTemplate::PortInterface::MetaDatum.metaDatumType == L IN_NAD_8	full
Mapping Status	ECUC Parameter ID
valid	

BSW Module	BSW Context
EcuC	EcuC/EcucConfigSet/EcucPduCollection/MetaDataType/MetaDatum/MetaDatumType
BSW Parameter	BSW Type
PRIORITY_8	EcucEnumerationLiteralDef
BSW Description	
Priority field of SAE J1939 IDs, or Ethernet QoS parameter. Size: 8 bits.	
Template Description	
This aggregation contributes the specification of the concrete meta-data item type.	
M2 Parameter	
SWComponentTemplate::PortInterface::MetaDatum.metaDatumType	
Mapping Rule	Mapping Type
SWComponentTemplate::PortInterface::MetaDatum.metaDatumType == P RRIORITY_8	full
Mapping Status	ECUC Parameter ID
valid	

BSW Module	BSW Context
EcuC	EcuC/EcucConfigSet/EcucPduCollection/MetaDataType/MetaDatum/MetaDatumType
BSW Parameter	BSW Type
SOCKET_CONNECTION_ID_16	EcucEnumerationLiteralDef
BSW Description	
SoAd socket connection ID. Size: 16 bits.	
Template Description	
This aggregation contributes the specification of the concrete meta-data item type.	
M2 Parameter	
SWComponentTemplate::PortInterface::MetaDatum.metaDatumType	
Mapping Rule	Mapping Type
SWComponentTemplate::PortInterface::MetaDatum.metaDatumType == S OCKET_CONNECTION_ID_16	full
Mapping Status	ECUC Parameter ID
valid	

BSW Module	BSW Context
EcuC	EcuC/EcucConfigSet/EcucPduCollection/MetaDataType/MetaDatum/MetaDatumType
BSW Parameter	BSW Type
SOURCE_ADDRESS_16	EcucEnumerationLiteralDef
BSW Description	
Source address of CanTp, FrTp, or DoIP transport protocol messages, or of SAE J1939 messages. Size: 16 bits.	
Template Description	

This aggregation contributes the specification of the concrete meta-data item type.	
M2 Parameter	
SWComponentTemplate::PortInterface::MetaDataType.metaDataType	
Mapping Rule	Mapping Type
SWComponentTemplate::PortInterface::MetaDataType == SOURCE_ADDRESS_16	full
Mapping Status	ECUC Parameter ID
valid	

BSW Module	BSW Context
EcuC	EcuC/EcucConfigSet/EcucPduCollection/MetaDataType/MetaDataItem/MetaDataType
BSW Parameter	BSW Type
TARGET_ADDRESS_16	EcucEnumerationLiteralDef
BSW Description	
Target address of CanTp, FrTp, or DoIP transport protocol messages, or destination address of SAE J1939 messages. Size: 16 bits.	
Template Description	
This aggregation contributes the specification of the concrete meta-data item type.	
M2 Parameter	
SWComponentTemplate::PortInterface::MetaDataType.metaDataType	
Mapping Rule	Mapping Type
SWComponentTemplate::PortInterface::MetaDataType == TARGET_ADDRESS_16	full
Mapping Status	ECUC Parameter ID
valid	

BSW Module	BSW Context
EcuC	EcuC/EcucConfigSet/EcucPduCollection/Pdu
BSW Parameter	BSW Type
MetaDataTypeRef	EcucReferenceDef
BSW Description	
Reference to meta data that is transported in the Pdu through the AUTOSAR layers.	
Template Description	

VariableDataPrototype:

A VariableDataPrototype is used to contain values in an ECU application. This means that most likely a VariableDataPrototype allocates "static" memory on the ECU. In some cases optimization strategies might lead to a situation where the memory allocation can be avoided.

In particular, the value of a VariableDataPrototype is likely to change as the ECU on which it is used executes.

SenderReceiverToSignalMapping:

Mapping of a sender receiver communication data element to a signal.

SystemSignal:

The system signal represents the communication system's view of data exchanged between SW components which reside on different ECUs. The system signals allow to represent this communication in a flattened structure, with exactly one system signal defined for each data element prototype sent and received by connected SW component instances.

ISignal:

Signal of the Interaction Layer. The RTE supports a "signal fan-out" where the same System Signal is sent in different SignalIPdus to multiple receivers.

To support the RTE "signal fan-out" each SignalIPdu contains ISignals. If the same System Signal is to be mapped into several SignalIPdus there is one ISignal needed for each ISignalToIPduMapping.

ISignals describe the Interface between the Precompile configured RTE and the potentially Postbuild configured Com Stack (see ECUC Parameter Mapping).

In case of the SystemSignalGroup an ISignal shall be created for each SystemSignal contained in the SystemSignalGroup.

ISignalIPdu:

Represents the IPdus handled by Com. The ISignalIPdu assembled and disassembled in AUTOSAR COM consists of one or more signals.

In case no multiplexing is performed this IPdu is routed to/from the Interface Layer.

A maximum of one dynamic length signal per IPdu is allowed.

M2 Parameter

SWComponentTemplate::Datatype::DataPrototypes::VariableDataPrototype
SystemTemplate::DataMapping::SenderReceiverToSignalMapping
SystemTemplate::Fibex::FibexCore::CoreCommunication::SystemSignal
SystemTemplate::Fibex::FibexCore::CoreCommunication::ISignal
SystemTemplate::Fibex::FibexCore::CoreCommunication::ISignalIPdu

Mapping Rule

A MetaDataTypeRef shall be derived for a given Pdu if a MetaDataItemSet exists that refers to a VariablePrototype that is also referenced from a SenderReceiverToSignalMapping that in turn references a SystemSignal that is referenced by a ISignal that is mapped to an ISignalIPdu that is derived to the mentioned Pdu in EcuC.

Mapping Type

full

Mapping Status

valid

ECUC Parameter ID

[ECUC_EcuC_00077]

BSW Module	BSW Context
EcuC	EcuC/ECucPartitionCollection/ECucPartition

BSW Parameter		BSW Type	
EcucPartitionSoftwareComponentInstanceRef		EcucInstanceReferenceDef	
BSW Description			
References the SW Component instances from the Ecu Extract that shall be executed in this partition.			
Template Description			
Role of a software component within a composition.			
M2 Parameter			
SWComponentTemplate::Composition::SwComponentPrototype			
Mapping Rule		Mapping Type	
1:1 mapping		full	
Mapping Status		ECUC Parameter ID	
valid		[ECUC_EcuC_00036]	

BSW Module		BSW Context	
EcuC		EcuC/EcucUnitGroupAssignment	
BSW Parameter		BSW Type	
EcucUnitGroupRef		EcucForeignReferenceDef	
BSW Description			
Optional reference to the UnitGroup to support the generation of ASAM MCD file. These UnitGroups are selecting a set of units for a specific country.			
Template Description			
<p>This meta-class represents the ability to specify a logical grouping of units. The category denotes the unit system that the referenced units are associated to.</p> <p>In this way, e.g. country-specific unit systems (CATEGORY="COUNTRY") can be defined as well as specific unit systems for certain application domains.</p> <p>In the same way a group of equivalent units, can be defined which are used in different countries, by setting CATEGORY="EQUIV_UNITS". KmPerHour and MilesPerHour could such be combined to one group named "vehicle_speed". The unit MeterPerSec would not belong to this group because it is normally not used for vehicle speed. But all of the mentioned units could be combined to one group named "speed".</p> <p>Note that the UnitGroup does not ensure the physical compliance of the units. This is maintained by the physical dimension.</p>			
M2 Parameter			
AsamHdo::Units::UnitGroup			
Mapping Rule		Mapping Type	
1:1 mapping		full	
Mapping Status		ECUC Parameter ID	
valid		[ECUC_EcuC_00062]	

G.11 OS

BSW Module		BSW Context	
Os		Os/Osloc/OslocCommunication/OslocDataProperties	
BSW Parameter		BSW Type	
OslocDataTypeRef		EcucForeignReferenceDef	
BSW Description			

<p>This is the type of the data to be transferred on the IOC communication channel. This attribute is necessary to generate the parameter type of the loc functions. Additionally this information should be used to compute the data size for necessary data copy operations within the loc module.</p> <p>If more than one attribute is defined, the IOC generator should generate an locXxxGroup function (Xxx= CHOICE [Send, Receive, Write, Read]).</p> <p>N:1 or N:M communication (Multiplicity of OslocSenderProperties > 1) is only allowed for multiplicity of OslocDataTypeRef = 1</p>	
Template Description	
Describes a reusable data type on the implementation level. This will typically correspond to a typedef in C-code.	
M2 Parameter	
CommonStructure::ImplementationDataTypes::ImplementationDataType	
Mapping Rule	Mapping Type
1:1 mapping	full
Mapping Status	ECUC Parameter ID
valid	[ECUC_Os_01005]

BSW Module	BSW Context
Os	Os/Osloc/OslocCommunication/OslocDataProperties
BSW Parameter	BSW Type
OsMemoryMappingCodeLocationRef	EcucForeignReferenceDef
BSW Description	
Reference to the memory mapping containing details about the section where the IOC buffer is placed.	
Template Description	
Describes a reusable data type on the implementation level. This will typically correspond to a typedef in C-code.	
M2 Parameter	
CommonStructure::ImplementationDataTypes::ImplementationDataType	
Mapping Rule	Mapping Type
1:1 mapping	full
Mapping Status	ECUC Parameter ID
valid	[ECUC_Os_00405]

H Splitable Elements in the Scope of this Document

This chapter contains a table of all model elements stereotyped «atpSplitable» in the scope of this document.

Each entry in the table consists of the identification of the specific model element itself and the applicable value of the tagged value `atp.Splitkey`.

For more information about the concept of splitable model elements and how these shall be treated please refer to [11].

Name of splitable element	Splitkey
AdminData.sdq	sdq
ARPackage.arPackage	shortName, variationPoint.shortLabel
ARPackage.element	shortName, variationPoint.shortLabel
ARPackage.referenceBase	shortLabel
AtomicSwComponentType.internalBehavior	internalBehavior, variationPoint.shortLabel
AtomicSwComponentType.symbolProps	shortName
CompositionSwComponentType.component	shortName, variationPoint.shortLabel
CompositionSwComponentType.connector	shortName, variationPoint.shortLabel
CompositionSwComponentType.constantValueMapping	constantValueMapping
CompositionSwComponentType.dataTypeMapping	dataTypeMapping
CompositionSwComponentType.instantiationRTEEvent-Props	shortLabel, variationPoint.shortLabel
ConsistencyNeeds.dpgDoesNotRequireCoherency	shortName, variationPoint.shortLabel
ConsistencyNeeds.dpgRequiresCoherency	shortName, variationPoint.shortLabel
ConsistencyNeeds.regDoesNotRequireStability	shortName, variationPoint.shortLabel
ConsistencyNeeds.regRequiresStability	shortName, variationPoint.shortLabel
EndToEndProtection.endToEndProfile	endToEndProfile
EndToEndProtection.endToEndProtectionISignalIPdu	variationPoint.shortLabel
EndToEndProtection.endToEndProtectionVariablePrototype	shortLabel, variationPoint.shortLabel
EndToEndProtectionSet.endToEndProtection	shortName, variationPoint.shortLabel
Implementation.mcSupport	mcSupport
Implementation.resourceConsumption	shortName
ImplementationDataType.symbolProps	shortName
InternalBehavior.constantMemory	shortName, variationPoint.shortLabel
InternalBehavior.constantValueMapping	constantValueMapping
InternalBehavior.dataTypeMapping	dataTypeMapping
InternalBehavior.exclusiveArea	shortName, variationPoint.shortLabel
InternalBehavior.exclusiveAreaNestingOrder	shortName, variationPoint.shortLabel
InternalBehavior.staticMemory	shortName, variationPoint.shortLabel
McGroup.mcFunction	mcFunction
McGroup.refCalprmSet	variationPoint.shortLabel
McGroup.refMeasurementSet	variationPoint.shortLabel
McGroup.subGroup	subGroup
McGroupDataRefSet.flatMapEntry	flatMapEntry
McGroupDataRefSet.mcDataInstance	mcDataInstance
NvBlockDescriptor.constantValueMapping	constantValueMapping
NvBlockDescriptor.dataTypeMapping	dataTypeMapping
NvBlockDescriptor.modeSwitchEventTriggeredActivity	modeSwitchEventTriggeredActivity, variationPoint.shortLabel
NvBlockSwComponentType.bulkNvDataDescriptor	shortName, variationPoint.shortLabel

NvBlockSwComponentType.nvBlockDescriptor	shortName, variationPoint.shortLabel
ParameterSwComponentType.constantMapping	constantMapping
ParameterSwComponentType.dataTypeMapping	dataTypeMapping
RapidPrototypingScenario.rptContainer	shortName, variationPoint.shortLabel
RapidPrototypingScenario.rptProfile	shortName
RapidPrototypingScenario.rptSystem	rptSystem
RptContainer.byPassPoint	byPassPoint, contextElement, target, variationPoint.shortLabel
RptContainer.rptContainer	shortName, variationPoint.shortLabel
RptContainer.rptHook	rptHook, variationPoint.shortLabel
RTEEvent.disabledMode	contextPort, contextModeDeclarationGroupPrototype, targetModeDeclaration
RunnableEntity.asynchronousServerCallResultPoint	shortName, variationPoint.shortLabel
RunnableEntity.dataReadAccess	shortName, variationPoint.shortLabel
RunnableEntity.dataReceivePointByArgument	shortName, variationPoint.shortLabel
RunnableEntity.dataReceivePointByValue	shortName, variationPoint.shortLabel
RunnableEntity.dataSendPoint	shortName, variationPoint.shortLabel
RunnableEntity.dataWriteAccess	shortName, variationPoint.shortLabel
RunnableEntity.externalTriggeringPoint	ident.shortName, variationPoint.shortLabel
RunnableEntity.internalTriggeringPoint	shortName, variationPoint.shortLabel
RunnableEntity.modeAccessPoint	ident.shortName, variationPoint.shortLabel
RunnableEntity.modeSwitchPoint	shortName, variationPoint.shortLabel
RunnableEntity.parameterAccess	shortName, variationPoint.shortLabel
RunnableEntity.readLocalVariable	shortName, variationPoint.shortLabel
RunnableEntity.serverCallPoint	shortName, variationPoint.shortLabel
RunnableEntity.writtenLocalVariable	shortName, variationPoint.shortLabel
SwcInternalBehavior.arTypedPerInstanceMemory	shortName, variationPoint.shortLabel
SwcInternalBehavior.event	shortName, variationPoint.shortLabel
SwcInternalBehavior.exclusiveAreaPolicy	exclusiveAreaPolicy, variationPoint.shortLabel
SwcInternalBehavior.explicitInterRunnableVariable	shortName, variationPoint.shortLabel
SwcInternalBehavior.implicitInterRunnableVariable	shortName, variationPoint.shortLabel
SwcInternalBehavior.includedDataTypeSet	includedDataTypeSet
SwcInternalBehavior.includedModeDeclarationGroupSet	includedModeDeclarationGroupSet
SwcInternalBehavior.instantiationDataDefProps	instantiationDataDefProps, variationPoint.shortLabel
SwcInternalBehavior.perInstanceMemory	shortName, variationPoint.shortLabel
SwcInternalBehavior.perInstanceParameter	shortName, variationPoint.shortLabel
SwcInternalBehavior.portAPIOption	portAPIOption, variationPoint.shortLabel
SwcInternalBehavior.runnable	shortName, variationPoint.shortLabel
SwcInternalBehavior.serviceDependency	shortName, variationPoint.shortLabel
SwcInternalBehavior.sharedParameter	shortName, variationPoint.shortLabel
SwcInternalBehavior.variationPointProxy	shortName
SwComponentType.consistencyNeeds	shortName, variationPoint.shortLabel
SwComponentType.port	shortName, variationPoint.shortLabel
SwComponentType.swComponentDocumentation	swComponentDocumentation, variationPoint.shortLabel
SwcServiceDependency.assignedPort	assignedPort, variationPoint.shortLabel

Table H.1: Usage of splittable elements

I Variation Points in the Scope of this Document

This chapter contains a table of all model elements stereotyped `<<atpVariation>>` in the scope of this document.

Each entry in the table consists of the identification of the model element itself and the applicable value of the tagged value `vh.latestBindingTime`.

For more information about the concept of variation points and how model elements that contain variation points shall be treated please refer to [11].

Variation Point	Latest Binding Time
<code>AccessCount.value</code>	<code>preCompileTime</code>
<code>AccessCountSet.accessCount</code>	<code>preCompileTime</code>
<code>ApplicationArrayElement.maxNumberOfElements</code>	<code>preCompileTime</code>
<code>ApplicationRecordDataType.element</code>	<code>preCompileTime</code>
<code>ARPackage.arPackage</code>	<code>blueprintDerivationTime</code>
<code>ARPackage.element</code>	<code>systemDesignTime</code>
<code>ArrayValueSpecification.element</code>	<code>preCompileTime</code>
<code>AtomicSwComponentType.internalBehavior</code>	<code>preCompileTime</code>
<code>BulkNvDataDescriptor.nvBlockDataMapping</code>	<code>preCompileTime</code>
<code>CalibrationParameterValueSet.calibrationParameterValue</code>	<code>preCompileTime</code>
<code>ClientServerInterface.operation</code>	<code>blueprintDerivationTime</code>
<code>ClientServerOperation.argument</code>	<code>blueprintDerivationTime</code>
<code>CompositionSwComponentType.component</code>	<code>postBuild</code>
<code>CompositionSwComponentType.connector</code>	<code>postBuild</code>
<code>CompositionSwComponentType.instantiationRTEEventProps</code>	<code>codeGenerationTime</code>
<code>CompuConstFormulaContent.vf</code>	<code>codeGenerationTime</code>
<code>CompuNominatorDenominator.v</code>	<code>preCompileTime</code>
<code>CompuScale.lowerLimit</code>	<code>preCompileTime</code>
<code>CompuScale.upperLimit</code>	<code>preCompileTime</code>
<code>CompuScales.compuScale</code>	<code>blueprintDerivationTime</code>
<code>ConsistencyNeeds.dpgDoesNotRequireCoherency</code>	<code>preCompileTime</code>
<code>ConsistencyNeeds.dpgRequiresCoherency</code>	<code>preCompileTime</code>
<code>ConsistencyNeeds.regDoesNotRequireStability</code>	<code>preCompileTime</code>
<code>ConsistencyNeeds.regRequiresStability</code>	<code>preCompileTime</code>
<code>DataPrototypeGroup.dataPrototypeGroup</code>	<code>preCompileTime</code>
<code>DataPrototypeGroup.implicitDataAccess</code>	<code>preCompileTime</code>
<code>DiagEventDebounceCounterBased.counterDecrementStepSize</code>	<code>preCompileTime</code>
<code>DiagEventDebounceCounterBased.counterFailedThreshold</code>	<code>preCompileTime</code>
<code>DiagEventDebounceCounterBased.counterIncrementStepSize</code>	<code>preCompileTime</code>
<code>DiagEventDebounceCounterBased.counterJumpDown</code>	<code>preCompileTime</code>
<code>DiagEventDebounceCounterBased.counterJumpDownValue</code>	<code>preCompileTime</code>
<code>DiagEventDebounceCounterBased.counterJumpUp</code>	<code>preCompileTime</code>
<code>DiagEventDebounceCounterBased.counterJumpUpValue</code>	<code>preCompileTime</code>
<code>DiagEventDebounceCounterBased.counterPassedThreshold</code>	<code>preCompileTime</code>
<code>DiagEventDebounceTimeBased.timeBasedFdcThresholdStorageValue</code>	<code>postBuild</code>
<code>DiagEventDebounceTimeBased.timeFailedThreshold</code>	<code>postBuild</code>
<code>DiagEventDebounceTimeBased.timePassedThreshold</code>	<code>postBuild</code>
<code>EndToEndProtection.endToEndProtectionISignalIPdu</code>	<code>preCompileTime</code>
<code>EndToEndProtection.endToEndProtectionVariablePrototype</code>	<code>preCompileTime</code>
<code>EndToEndProtectionSet.endToEndProtection</code>	<code>preCompileTime</code>
<code>ErrorTracerNeeds.tracedFailure</code>	<code>preCompileTime</code>

Implementation.buildActionManifest	codeGenerationTime
Implementation.generatedArtifact	preCompileTime
Implementation.requiredArtifact	preCompileTime
Implementation.requiredGeneratorTool	preCompileTime
ImplementationDataType.subElement	preCompileTime
ImplementationDataTypeElement.arraySize	preCompileTime
ImplementationDataTypeElement.subElement	preCompileTime
InternalBehavior.constantMemory	preCompileTime
InternalBehavior.exclusiveArea	preCompileTime
InternalBehavior.exclusiveAreaNestingOrder	preCompileTime
InternalBehavior.staticMemory	preCompileTime
InternalConstrs.lowerLimit	preCompileTime
InternalConstrs.upperLimit	preCompileTime
McGroupDataRefSet	preCompileTime
ModeDeclarationGroup.modeDeclaration	blueprintDerivationTime
NumericalOrText.vf	preCompileTime
NumericalValueSpecification.value	preCompileTime
NvBlockDescriptor.clientServerPort	preCompileTime
NvBlockDescriptor.instantiationDataDefProps	preCompileTime
NvBlockDescriptor.modeSwitchEventTriggeredActivity	preCompileTime
NvBlockDescriptor.nvBlockDataMapping	preCompileTime
NvBlockSwComponentType.bulkNvDataDescriptor	preCompileTime
NvBlockSwComponentType.nvBlockDescriptor	preCompileTime
ParameterSwComponentType.instantiationDataDefProps	preCompileTime
PerInstanceMemorySize.size	preCompileTime
PhysConstrs.lowerLimit	preCompileTime
PhysConstrs.upperLimit	preCompileTime
PortGroup.outerPort	preCompileTime
PortInterfaceMappingSet.portInterfaceMapping	blueprintDerivationTime
RapidPrototypingScenario.rptContainer	preCompileTime
ReceiverComSpec.maxDeltaCounterInit	preCompileTime
ReceiverComSpec.usesEndToEndProtection	preCompileTime
RecordValueSpecification.field	preCompileTime
RptContainer.byPassPoint	preCompileTime
RptContainer.rptContainer	preCompileTime
RptContainer.rptHook	preCompileTime
RuleArguments.vf	preCompileTime
RuleArguments.vtf	preCompileTime
RuleBasedValueSpecification.arguments	preCompileTime
RunnableEntity.asynchronousServerCallResultPoint	preCompileTime
RunnableEntity.dataReadAccess	preCompileTime
RunnableEntity.dataReceivePointByArgument	preCompileTime
RunnableEntity.dataReceivePointByValue	preCompileTime
RunnableEntity.dataSendPoint	preCompileTime
RunnableEntity.dataWriteAccess	preCompileTime
RunnableEntity.externalTriggeringPoint	preCompileTime
RunnableEntity.internalTriggeringPoint	preCompileTime
RunnableEntity.modeAccessPoint	preCompileTime
RunnableEntity.modeSwitchPoint	preCompileTime
RunnableEntity.parameterAccess	preCompileTime
RunnableEntity.readLocalVariable	preCompileTime
RunnableEntity.serverCallPoint	preCompileTime
RunnableEntity.writtenLocalVariable	preCompileTime

RunnableEntityGroup.runnableEntity	preCompileTime
RunnableEntityGroup.runnableEntityGroup	preCompileTime
ScaleConstr.lowerLimit	preCompileTime
ScaleConstr.upperLimit	preCompileTime
Sdf.value	preCompileTime
SdgContents.sdg	postBuild
SdgContents.sdx	postBuild
SenderComSpec.usesEndToEndProtection	preCompileTime
ServiceDependency.assignedDataType	preCompileTime
SubElementMapping.firstElement	preCompileTime
SubElementMapping.secondElement	preCompileTime
SupervisedEntityNeeds.checkpoints	preCompileTime
SwAxisIndividual.swMaxAxisPoints	preCompileTime
SwAxisIndividual.swMinAxisPoints	preCompileTime
SwCbswMapping.runnableMapping	preCompileTime
SwCbswMapping.synchronizedModeGroup	preCompileTime
SwCbswMapping.synchronizedTrigger	preCompileTime
SwImplementation.perInstanceMemorySize	preCompileTime
SwInternalBehavior.arTypedPerInstanceMemory	preCompileTime
SwInternalBehavior.event	preCompileTime
SwInternalBehavior.exclusiveAreaPolicy	preCompileTime
SwInternalBehavior.explicitInterRunnableVariable	preCompileTime
SwInternalBehavior.implicitInterRunnableVariable	preCompileTime
SwInternalBehavior.instantiationDataDefProps	preCompileTime
SwInternalBehavior.perInstanceMemory	preCompileTime
SwInternalBehavior.perInstanceParameter	preCompileTime
SwInternalBehavior.portAPIOption	preCompileTime
SwInternalBehavior.runnable	preCompileTime
SwInternalBehavior.serviceDependency	preCompileTime
SwInternalBehavior.sharedParameter	preCompileTime
SwComponentDocumentation.chapter	postBuild
SwComponentType.consistencyNeeds	preCompileTime
SwComponentType.port	preCompileTime
SwComponentType.portGroup	preCompileTime
SwComponentType.swComponentDocumentation	preCompileTime
SwServiceDependency.assignedData	preCompileTime
SwServiceDependency.assignedPort	preCompileTime
SwDataDefProps	codeGenerationTime
SwDataDefProps.swValueBlockSize	preCompileTime
SwDataDefProps.swValueBlockSizeMult	preCompileTime
SwGenericAxisParam.vf	preCompileTime
SwTextProps.swMaxTextSize	preCompileTime
SwValues.vf	preCompileTime
SwValues.vtf	preCompileTime
TextTableMapping.bitfieldTextTableMaskFirst	preCompileTime
TextTableMapping.bitfieldTextTableMaskSecond	preCompileTime
TextTableValuePair.firstValue	preCompileTime
TextTableValuePair.secondValue	preCompileTime
ValueList.vf	preCompileTime

Table I.1: Usage of variation points