

<b>Document Title</b>	Specification of Ethernet State Manager
<b>Document Owner</b>	AUTOSAR
<b>Document Responsibility</b>	AUTOSAR
<b>Document Identification No</b>	415
<b>Document Status</b>	Final
<b>Part of AUTOSAR Standard</b>	Classic Platform
<b>Part of Standard Release</b>	4.4.0

<b>Document Change History</b>			
<b>Date</b>	<b>Release</b>	<b>Changed by</b>	<b>Change Description</b>
2018-10-31	4.4.0	AUTOSAR Release Management	<ul style="list-style-type: none"> <li>• Error classification has been fixed</li> <li>• Editorial changes</li> </ul>
2017-12-08	4.3.1	AUTOSAR Release Management	<ul style="list-style-type: none"> <li>• Default error is removed</li> <li>• Editorial changes</li> </ul>
2016-11-30	4.3.0	AUTOSAR Release Management	<ul style="list-style-type: none"> <li>• Remove Set and Get Transceiver mode functionality</li> <li>• Correct EthSM_TcplpModeIndication callback return value</li> <li>• Harmonize main function period with the other modules</li> <li>• Remove Get current internal mode</li> </ul>
2015-07-31	4.2.2	AUTOSAR Release Management	<ul style="list-style-type: none"> <li>• Harmonize Sequence diagrams, Network State Machine and Functional Description</li> <li>• Debugging support marked as obsolete</li> <li>• Report to DET if Tcplp state is not accepted</li> <li>• Adaptations related to renaming of DET,</li> <li>• Error Handling: tables for Runtime Errors and Transient Faults added</li> </ul>

<b>Document Change History</b>			
<b>Date</b>	<b>Release</b>	<b>Changed by</b>	<b>Change Description</b>
2014-10-31	4.2.1	AUTOSAR Release Management	<ul style="list-style-type: none"> <li>• Change from Synchronous to Asynchronous API</li> <li>• Additional callback functions added</li> <li>• Existing behavior of functions changes</li> <li>• Editorial changes</li> </ul>
2014-03-31	4.1.3	AUTOSAR Release Management	<ul style="list-style-type: none"> <li>• Corrective action after timeout</li> <li>• Non mutually exclusive transitions from ETHSM_STATE_ONLINE</li> <li>• Editorial changes</li> </ul>
2013-10-31	4.1.2	AUTOSAR Release Management	<ul style="list-style-type: none"> <li>• Optimization of full com request</li> <li>• Standardization of internal state names</li> <li>• Asynchronous behavior of several interfaces</li> <li>• Several clarifications and corrections</li> <li>• Editorial changes</li> <li>• Removed chapter(s) on change documentation</li> </ul>
2013-03-15	4.1.1	AUTOSAR Administration	<ul style="list-style-type: none"> <li>• New State Machine (new sub states and new state conditions, new APIs)</li> <li>• Update chapter 10</li> <li>• Added Production Error if Transceiver Link is down</li> <li>• General Update (corrections and formulations)</li> </ul>
2011-12-22	4.0.3	AUTOSAR Administration	<ul style="list-style-type: none"> <li>• Update Chapter 10 (Parameter adjustment)</li> </ul>

<b>Document Change History</b>			
<b>Date</b>	<b>Release</b>	<b>Changed by</b>	<b>Change Description</b>
2010-09-30	3.1.5	AUTOSAR Administration	<ul style="list-style-type: none"> <li>• Functional changes:</li> <li>• Correction of the naming convention of SW modul version information</li> <li>• Correction of chapter 10 - configuration parameter "EthSMNetworkIndex"</li> <li>• Remove InstanceID from GetVersionId structure</li> <li>• Additional callback function: Call of SoAd_BusSM_ModelIndication realized after the successful initialization of the EthTrcv and the EthController.</li> <li>• Non functional changes:</li> <li>• Adding a self loop with "No initialization" in the state diagramm</li> </ul>
2010-02-02	3.1.4	AUTOSAR Administration	<ul style="list-style-type: none"> <li>• Initial Release</li> </ul>

## Disclaimer

This work (specification and/or software implementation) and the material contained in it, as released by AUTOSAR, is for the purpose of information only. AUTOSAR and the companies that have contributed to it shall not be liable for any use of the work.

The material contained in this work is protected by copyright and other types of intellectual property rights. The commercial exploitation of the material contained in this work requires a license to such intellectual property rights.

This work may be utilized or reproduced without any modification, in any form or by any means, for informational purposes only. For any other purpose, no part of the work may be utilized or reproduced, in any form or by any means, without permission in writing from the publisher.

The work has been developed for automotive applications only. It has neither been developed, nor tested for non-automotive applications.

The word AUTOSAR and the AUTOSAR logo are registered trademarks.

## Table of Contents

1	Introduction and functional overview .....	7
2	Acronyms and abbreviations .....	8
3	Related documentation.....	9
3.1	Input documents.....	9
3.2	Related specification .....	10
4	Constraints and assumptions .....	11
4.1	Limitations .....	11
4.2	Applicability to car domains .....	11
5	Dependencies to other modules.....	12
5.1	File structure.....	12
5.1.1	Code file structure.....	12
5.1.2	Version Check.....	13
6	Requirements traceability .....	14
7	Functional specification .....	18
7.1	Translation of network communication mode requests.....	18
7.2	Output of current network communication modes .....	18
7.3	Control of peripherals .....	18
7.3.1	Ethernet Interface Controllers .....	18
7.4	Multiple networks.....	19
7.5	Background and Rationale .....	19
7.6	Network mode state machine .....	20
7.6.1	Initial transition.....	22
7.6.2	Transition between substate WAIT_TRCVLINK and OFFLINE.....	22
7.6.3	Transition between substate WAIT_TRCVLINK and WAIT_ONLINE ...	23
7.6.4	Transition from substate WAIT_ONLINE to OFFLINE .....	24
7.6.5	Transition between substate WAIT_ONLINE and ONLINE.....	24
7.6.6	Transition from substate ONLINE to WAIT_OFFLINE .....	25
7.6.7	Transition from substate WAIT_OFFLINE to OFFLINE .....	26
7.6.8	Transition between substate ONLINE and ONHOLD.....	28
7.6.9	Transition from substate ONHOLD to WAIT_TRCVLINK.....	30
7.6.10	Transition from substate ONHOLD to OFFLINE.....	32
7.6.11	Information about state transitions.....	34
7.7	Error notification .....	35
7.8	Error classification .....	35
7.8.1	Development Errors .....	35
7.8.2	Runtime Errors.....	36
7.8.3	Transient Faults .....	36
7.8.4	Production Errors.....	36
7.8.5	Extended Production Errors.....	36
7.9	Commercial Off The Shelf stack usage .....	37
8	API specification.....	38

8.1	Imported types.....	38
8.2	Type definitions .....	38
8.2.1	EthSM_NetworkModeStateType.....	38
8.3	Function definitions.....	39
8.3.1	EthSM_Init .....	39
8.3.2	EthSM_GetVersionInfo .....	39
8.3.3	EthSM_RequestComMode .....	39
8.3.4	EthSM_GetCurrentComMode .....	41
8.4	Call-back notifications.....	42
8.4.1	EthSM_CtrlModeIndication .....	42
8.4.2	EthSM_TrsvLinkStateChg.....	42
8.4.3	EthSM_TcplpModeIndication .....	43
8.5	Scheduled functions .....	44
8.5.1	EthSM_MainFunction.....	44
8.6	Expected Interfaces.....	45
8.6.1	Mandatory Interfaces .....	45
8.6.2	Optional Interfaces.....	45
9	Sequence diagrams .....	46
10	Configuration specification.....	49
10.1	How to read this chapter .....	49
10.2	Containers and configuration parameters .....	49
10.2.1	Configuration Tool .....	49
10.2.2	EthSM.....	49
10.2.3	EthSMGeneral .....	50
10.2.4	EthSMNetwork.....	51
10.2.5	EthSMDemEventParameterRefs .....	52
10.3	Published Information.....	53
11	Not applicable requirements .....	54

# 1 Introduction and functional overview

This specification specifies the functionality, API and the configuration of the AUTOSAR Basic Software module Ethernet State Manager.

In the AUTOSAR Layered Software Architecture, the Ethernet State Manager belongs to the ECU Abstraction Layer, or more precisely, to the Communication Hardware Abstraction.

The main task of the Ethernet State Manager can be summarized as follows:

[SWS\_EthSM\_00001]

[ The Ethernet State Manager shall provide an abstract interface to the AUTOSAR Communication Manager to startup or shutdown the communication on an Ethernet cluster. ] ( )

[SWS\_EthSM\_00002]

[ The Ethernet State Manager does not directly access the Ethernet hardware (Ethernet Communication Controller and Ethernet Transceiver), but by means of the Ethernet Interface. The Ethernet Interface redirects the request to the appropriate driver module.] ( )

This is an example of an Autosar architecture including an Ethernet network.

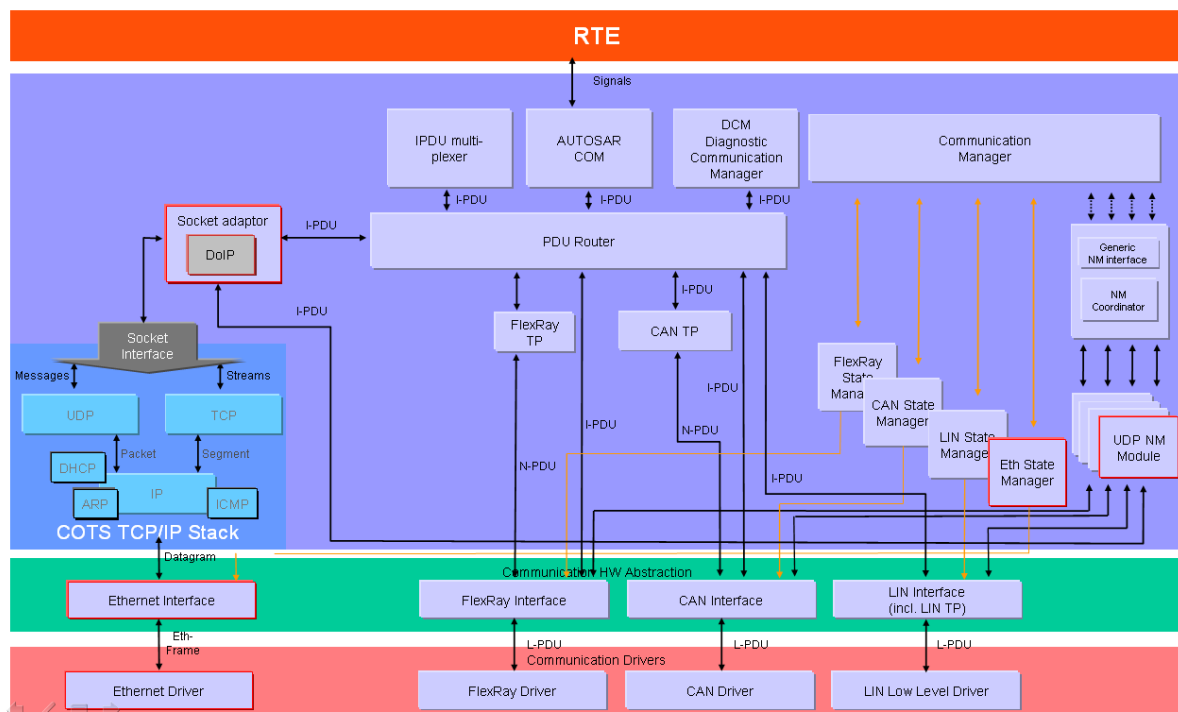

Figure 1-1: Example of an Autosar architecture including an Ethernet network

## 2 Acronyms and abbreviations

<b>Abbreviation / Acronym:</b>	<b>Description:</b>
API	Application Program Interface
BSW	Basic Software
BswM	Basic Software Mode Manager
ComM	Communication Manager
DEM	Diagnostic Event Manager
DET	Default Error Tracer
EcuM	ECU State Manager
Eth	Ethernet Controller
EthTrcv	Ethernet Transceiver
EthSM	Ethernet State Manager
EthIf	Ethernet Interface
SchM	BSW Scheduler
SoAd	Socket Adapter



## 3 Related documentation

### 3.1 Input documents

- [1] List of Basic Software Modules  
AUTOSAR\_TR\_BSWModuleList.pdf
  
- [2] Layered Software Architecture  
AUTOSAR\_EXP\_LayeredSoftwareArchitecture.pdf
  
- [3] AUTOSAR General Requirements on Basic Software Modules  
AUTOSAR\_SRS\_BSWGeneral.pdf
  
- [4] Specification of AUTOSAR COM  
AUTOSAR\_SWS\_COM.pdf
  
- [5] Specification of ECU Configuration  
AUTOSAR\_TPS\_ECUConfiguration.pdf
  
- [6] Specification of Communication Stack Types  
AUTOSAR\_SWS\_CommunicationStackTypes.pdf
  
- [7] Specification of Communication Manager  
AUTOSAR\_SWS\_ComManager.pdf
  
- [8] Requirements on Mode Management  
AUTOSAR\_SRS\_ModeManagement.pdf
  
- [9] Basic Software Module Description Template  
AUTOSAR\_TPS\_BSWModuleDescriptionTemplate.pdf
  
- [10] Specification of the Ethernet Interface  
AUTOSAR\_SWS\_EthernetInterface.pdf
  
- [11] Requirements on Ethernet in AUTOSAR  
AUTOSAR\_SRS\_Ethernet.pdf
  
- [12] Specification of Standard Types  
AUTOSAR\_SWS\_StandardTypes
  
- [13] Specification of Diagnostic Event Manager  
AUTOSAR\_SWS\_DiagnosticEventManager.pdf
  
- [14] Specification of Default Error Tracer  
AUTOSAR\_SWS\_DefaultErrorTracer.pdf
  
- [15] Specification of Basic Software Mode Manager  
AUTOSAR\_SWS\_BSWModeManager.pdf

[16] Specification of Basic Software Mode Manager  
AUTOSAR\_SWS\_SocketAdapter.pdf

[17] General Specification of Basic Software Modules  
AUTOSAR\_SWS\_BSWGeneral.pdf

[18] Specification of TcpIp module  
AUTOSAR\_SWS\_TcpIp.pdf

### **3.2 Related specification**

AUTOSAR provides a General Specification on Basic Software modules [17] (SWS BSW General), which is also valid for Ethernet State Manager.

Thus, the specification SWS BSW General shall be considered as additional and required specification for Ethernet State Manager.

## 4 Constraints and assumptions

### 4.1 Limitations

The EthSM can be used for Ethernet communication only. Its dedication is to operate with the EthIf to control one or multiple underlying Ethernet Controllers and Ethernet Transceiver Drivers. Other protocols than Ethernet (i.e. CAN, LIN or FlexRay) are not supported.

The following items are not supported by the current version of this specification.

- Wake on LAN

The actual EthSM requires an IP-based communication stack. To get FULL\_COMMUNICATION it is necessary to get an active IP communication. In further specifications, an alternative “low level” state machine will be introduced. This state machine only works on driver/transceiver level (without IP communication). This is necessary to realize other communication protocols (e.g. IEEE 1722).

### 4.2 Applicability to car domains

The Ethernet State Manager can be used for all domain applications always when the Ethernet protocol is used. The Ethernet BSW Stack can be used wherever high data rates are required.

## 5 Dependencies to other modules

### **AUTOSAR BSW Scheduler**

The BSW Scheduler calls the main functions of the EthSM, which are necessary for the cyclic processes of the EthSM.

### **AUTOSAR Communication Manager**

The ComM requests network communication modes and is notified by the EthSM when a communication mode is reached.

### **AUTOSAR Ethernet Interface**

The EthSM uses the API of the EthIf to initialize the Ethernet Communication Hardware and to control the operating modes of the Ethernet Controllers and Ethernet Transceivers assigned to the Ethernet Networks.

The Ethernet Interface uses the API of the EthSM to provide the transceiver link state.

### **AUTOSAR Default Error Tracer**

In order to be able to report development errors, the Ethernet State Manager has to have access to the error hook of the Default Error Tracer.

### **AUTOSAR Diagnostic Event Manager**

In order to be able to report production errors the Ethernet State Manager has to have access to the Diagnostic Event Manager.

### **ECU State Manager**

The EcuM initializes the EthSM.

### **AUTOSAR Bsw Manager**

The BswM is notified by the EthSM when an internal state is reached.

### **AUTOSAR Tcplp**

Tcplp is called to request the TCPIP state (e.g. Online, Offline, On Hold, ...).

TcplP uses the API of the EthSM to provide the TCPIP state.

## 5.1 File structure

### 5.1.1 Code file structure

For details refer to the chapter 5.1.6 “Code File Structure” in SWS\_BSWGeneral.

Remark:

Actually the module EthSM doesn't provide link time configuration and post-build time configuration.

The EthSM needs to report development errors if development errors are enabled by configuration. Therefore, it includes the header file Det.h.] ()

[SWS\_EthSM\_00010] [

The EthSM implementation (EthSM.c) references the API of the EthIf. Therefore, it includes the header file EthIf.h.] ()

[SWS\_EthSM\_00013] [

The EthSM module shall include the ComM\_Bus\_SM.h header file. ]()

### **5.1.2 Version Check**

For details refer to the chapter 5.1.8 “Version Check” in *SWS\_BSWGeneral*.

## 6 Requirements traceability

Requirement	Description	Satisfied by
SRS_BSW_00003	All software modules shall provide version and identification information	SWS_EthSM_00046, SWS_EthSM_00060
SRS_BSW_00005	Modules of the $\mu$ C Abstraction Layer (MCAL) may not have hard coded horizontal interfaces	SWS_EthSM_00999
SRS_BSW_00010	The memory consumption of all Basic SW Modules shall be documented for a defined configuration for all supported platforms.	SWS_EthSM_00999
SRS_BSW_00101	The Basic Software Module shall be able to initialize variables and hardware in a separate initialization function	SWS_EthSM_00043
SRS_BSW_00159	All modules of the AUTOSAR Basic Software shall support a tool based configuration	SWS_EthSM_00081
SRS_BSW_00160	Configuration files of AUTOSAR Basic SW module shall be readable for human beings	SWS_EthSM_00999
SRS_BSW_00161	The AUTOSAR Basic Software shall provide a microcontroller abstraction layer which provides a standardized interface to higher software layers	SWS_EthSM_00999
SRS_BSW_00162	The AUTOSAR Basic Software shall provide a hardware abstraction layer	SWS_EthSM_00999
SRS_BSW_00164	The Implementation of interrupt service routines shall be done by the Operating System, complex drivers or modules	SWS_EthSM_00999
SRS_BSW_00168	SW components shall be tested by a function defined in a common API in the Basis-SW	SWS_EthSM_00999
SRS_BSW_00170	The AUTOSAR SW Components shall provide information about their dependency from faults, signal qualities, driver demands	SWS_EthSM_00999
SRS_BSW_00306	AUTOSAR Basic Software Modules shall be compiler and platform independent	SWS_EthSM_00999
SRS_BSW_00308	AUTOSAR Basic Software Modules shall not define global data in their header files, but in the C file	SWS_EthSM_00999
SRS_BSW_00309	All AUTOSAR Basic Software Modules shall indicate all global data with read-only purposes by explicitly assigning the const keyword	SWS_EthSM_00999
SRS_BSW_00314	All internal driver modules shall separate the interrupt frame definition from the service routine	SWS_EthSM_00999
SRS_BSW_00318	Each AUTOSAR Basic Software Module file shall provide version numbers in the header	SWS_EthSM_00060

	file	
SRS_BSW_00321	The version numbers of AUTOSAR Basic Software Modules shall be enumerated according specific rules	SWS_EthSM_00999
SRS_BSW_00325	The runtime of interrupt service routines and functions that are running in interrupt context shall be kept short	SWS_EthSM_00999
SRS_BSW_00328	All AUTOSAR Basic Software Modules shall avoid the duplication of code	SWS_EthSM_00999
SRS_BSW_00331	All Basic Software Modules shall strictly separate error and status information	SWS_EthSM_00999
SRS_BSW_00333	For each callback function it shall be specified if it is called from interrupt context or not	SWS_EthSM_00999
SRS_BSW_00334	All Basic Software Modules shall provide an XML file that contains the meta data	SWS_EthSM_00999
SRS_BSW_00336	Basic SW module shall be able to shutdown	SWS_EthSM_00999
SRS_BSW_00341	Module documentation shall contains all needed informations	SWS_EthSM_00999
SRS_BSW_00343	The unit of time for specification and configuration of Basic SW modules shall be preferably in physical time unit	SWS_EthSM_00999
SRS_BSW_00344	BSW Modules shall support link-time configuration	SWS_EthSM_00999
SRS_BSW_00347	A Naming separation of different instances of BSW drivers shall be in place	SWS_EthSM_00999
SRS_BSW_00353	All integer type definitions of target and compiler specific scope shall be placed and organized in a single type header	SWS_EthSM_00999
SRS_BSW_00358	The return type of init() functions implemented by AUTOSAR Basic Software Modules shall be void	SWS_EthSM_00043
SRS_BSW_00359	All AUTOSAR Basic Software Modules callback functions shall avoid return types other than void if possible	SWS_EthSM_00999
SRS_BSW_00360	AUTOSAR Basic Software Modules callback functions are allowed to have parameters	SWS_EthSM_00999
SRS_BSW_00361	All mappings of not standardized keywords of compiler specific scope shall be placed and organized in a compiler specific type and keyword header	SWS_EthSM_00999
SRS_BSW_00369	All AUTOSAR Basic Software Modules shall not return specific development error codes via the API	SWS_EthSM_00999
SRS_BSW_00371	The passing of function pointers as API parameter is forbidden for all AUTOSAR Basic Software Modules	SWS_EthSM_00999
SRS_BSW_00373	The main processing function of each AUTOSAR Basic Software Module shall be	SWS_EthSM_00999

	named according the defined convention	
SRS_BSW_00374	All Basic Software Modules shall provide a readable module vendor identification	SWS_EthSM_00060
SRS_BSW_00375	Basic Software Modules shall report wake-up reasons	SWS_EthSM_00999
SRS_BSW_00377	A Basic Software Module can return a module specific types	SWS_EthSM_00999
SRS_BSW_00395	The Basic Software Module specifications shall list all configuration parameter dependencies	SWS_EthSM_00999
SRS_BSW_00398	The link-time configuration is achieved on object code basis in the stage after compiling and before linking	SWS_EthSM_00999
SRS_BSW_00399	Parameter-sets shall be located in a separate segment and shall be loaded after the code	SWS_EthSM_00999
SRS_BSW_00400	Parameter shall be selected from multiple sets of parameters after code has been loaded and started	SWS_EthSM_00999
SRS_BSW_00404	BSW Modules shall support post-build configuration	SWS_EthSM_00999
SRS_BSW_00405	BSW Modules shall support multiple configuration sets	SWS_EthSM_00043
SRS_BSW_00406	A static status variable denoting if a BSW module is initialized shall be initialized with value 0 before any APIs of the BSW module is called	SWS_EthSM_00054, SWS_EthSM_00060, SWS_EthSM_00115, SWS_EthSM_00120
SRS_BSW_00407	Each BSW module shall provide a function to read out the version information of a dedicated module implementation	SWS_EthSM_00046
SRS_BSW_00413	An index-based accessing of the instances of BSW modules shall be done	SWS_EthSM_00999
SRS_BSW_00414	Init functions shall have a pointer to a configuration structure as single parameter	SWS_EthSM_00043
SRS_BSW_00416	The sequence of modules to be initialized shall be configurable	SWS_EthSM_00999
SRS_BSW_00417	Software which is not part of the SW-C shall report error events only after the DEM is fully operational.	SWS_EthSM_00999
SRS_BSW_00423	BSW modules with AUTOSAR interfaces shall be describable with the means of the SW-C Template	SWS_EthSM_00999
SRS_BSW_00424	BSW module main processing functions shall not be allowed to enter a wait state	SWS_EthSM_00081
SRS_BSW_00425	The BSW module description template shall provide means to model the defined trigger conditions of schedulable objects	SWS_EthSM_00081
SRS_BSW_00426	BSW Modules shall ensure data consistency of data which is shared between BSW	SWS_EthSM_00999



	modules	
SRS_BSW_00427	ISR functions shall be defined and documented in the BSW module description template	SWS_EthSM_00999
SRS_BSW_00428	A BSW module shall state if its main processing function(s) has to be executed in a specific order or sequence	SWS_EthSM_00999
SRS_BSW_00429	Access to OS is restricted	SWS_EthSM_00999
SRS_BSW_00432	Modules should have separate main processing functions for read/receive and write/transmit data path	SWS_EthSM_00999
SRS_BSW_00433	Main processing functions are only allowed to be called from task bodies provided by the BSW Scheduler	SWS_EthSM_00999
SRS_BSW_00437	Memory mapping shall provide the possibility to define RAM segments which are not to be initialized during startup	SWS_EthSM_00999
SRS_BSW_00438	Configuration data shall be defined in a structure	SWS_EthSM_00999

## 7 Functional specification

An ECU can have different communication networks. Each network has to be identified with a unique network handle. The ComM requests communication modes from the networks. It knows by its configuration, which handle is assigned to what kind of network. In case of Ethernet, it uses the Ethernet state manager, which is responsible for the control flow abstraction of Ethernet networks. The following sections describe this in detail.

### 7.1 Translation of network communication mode requests

[SWS\_EthSM\_00014] [

The EthSM shall provide to the ComM an API, which can be used by the ComM to request communication modes of Ethernet networks.] ()

[SWS\_EthSM\_00015][

Depending on the parameters handed over by this API, the EthSM shall execute a state transition of the related network mode state machine (refer to section 7.6). ] ()

[SWS\_EthSM\_00016][

This transition shall translate the request into a respective API call to control the assigned Ethernet peripherals.] ()

### 7.2 Output of current network communication modes

The current communication mode of a network can be different from the requested mode. The EthSM has to provide the information on the current communication mode to the ComM by the two following kind of interfaces:

[SWS\_EthSM\_00017][

The EthSM shall provide an API, which can be polled by the ComM to get the current communication mode of an Ethernet network. ] ()

[SWS\_EthSM\_00018][

The EthSM shall use a call-back notification of ComM to notify ComM of a change in communication modes.] ()

### 7.3 Control of peripherals

#### 7.3.1 Ethernet Interface Controllers

One or more Ethernet Interface Controllers belong to a certain Ethernet network (handle).

[SWS\_EthSM\_00022]

Depending on the network mode state machine, the EthSM shall control the Ethernet Interface Controller modes of each Ethernet network. ] ( )

[SWS\_EthSM\_00023]

The EthSM shall use the API of the EthIf to control the operating modes of the assigned Ethernet Interface Controllers.] ( )

## 7.4 Multiple networks

The Ethernet State Manager shall be able to handle separate networks. This concerns separate physical networks (see also chapter 7.3) and also separate VLAN's on the same physical network.

In both cases, the separation is done by separate handles per physical or virtual network. VLANs appear on higher layers (ComM) as separate networks. E.g.: If there is one physical Ethernet Interface Controller and two VLANs assigned to it, two ComM channels exists.

## 7.5 Background and Rationale

### Explanation:

The application is responsible to recognize if the Ethernet network is needed or not.

One possible use case could be the usage of the Ethernet network in a tester connection (see description below).

### Use Case: Use Ethernet in a tester connection

For example, the detection could takes place over a separate hardware pin of the ECU. In this case, the activation of the hardware pin and therefore the activation of the Ethernet network can only realized through the offboard-diagnostic tester. Reasons for the deactivation of the Ethernet network could be:

- The tester deactivate via the separate hardware pin the network
- The application deactivate the network
- The application recognize a timeout
- The link status of the network failed

[SWS\_EthSM\_00038] [

The ComM calls the EthSM to request a certain communication mode. The Ethernet network only needs the communication modes FULL\_COMMUNICATION and NO\_COMMUNICATION. ] ( )

[SWS\_EthSM\_00085] [

If FULL\_COMMUNICATION is requested the Ethernet Interface Controller is set to the state ACTIVE. To reach FULL\_COMMUNICATION it is also necessary to get an ACTIVE link state (Ethernet cable is connected) and an ONLINE TcpIP state (IP communication is available). The link state will be detected by the Ethernet

Transceiver module and will be communicated by the Ethernet Interface. The TcpIp state will be detected and communicated by the TcpIp module.] ()

[SWS\_EthSM\_00086]

If the ComM request NO\_COMMUNICATION the Ethernet Interface Controller is set to the state DOWN.] ()

Remark:

For the de-initialization no separate interface is necessary, the de-initialization is automatically realized in the EthIf.

It is also necessary to set the TcpIp state to OFFLINE.

[SWS\_EthSM\_00087]

The Ethernet network has to be wake up by the application and it's either on (FULL\_COMMUNICATION) or off (NO\_COMMUNICATION). So there is no need for other states e.g. like SILENT\_COMMUNICATION.] ()

## 7.6 Network mode state machine

[SWS\_EthSM\_00024]

The EthSM shall implement for each configured network handle one network mode state machine. The internal states are described in the Fig. 7-1 [\[SWS EthSM 00041\]](#).] ()

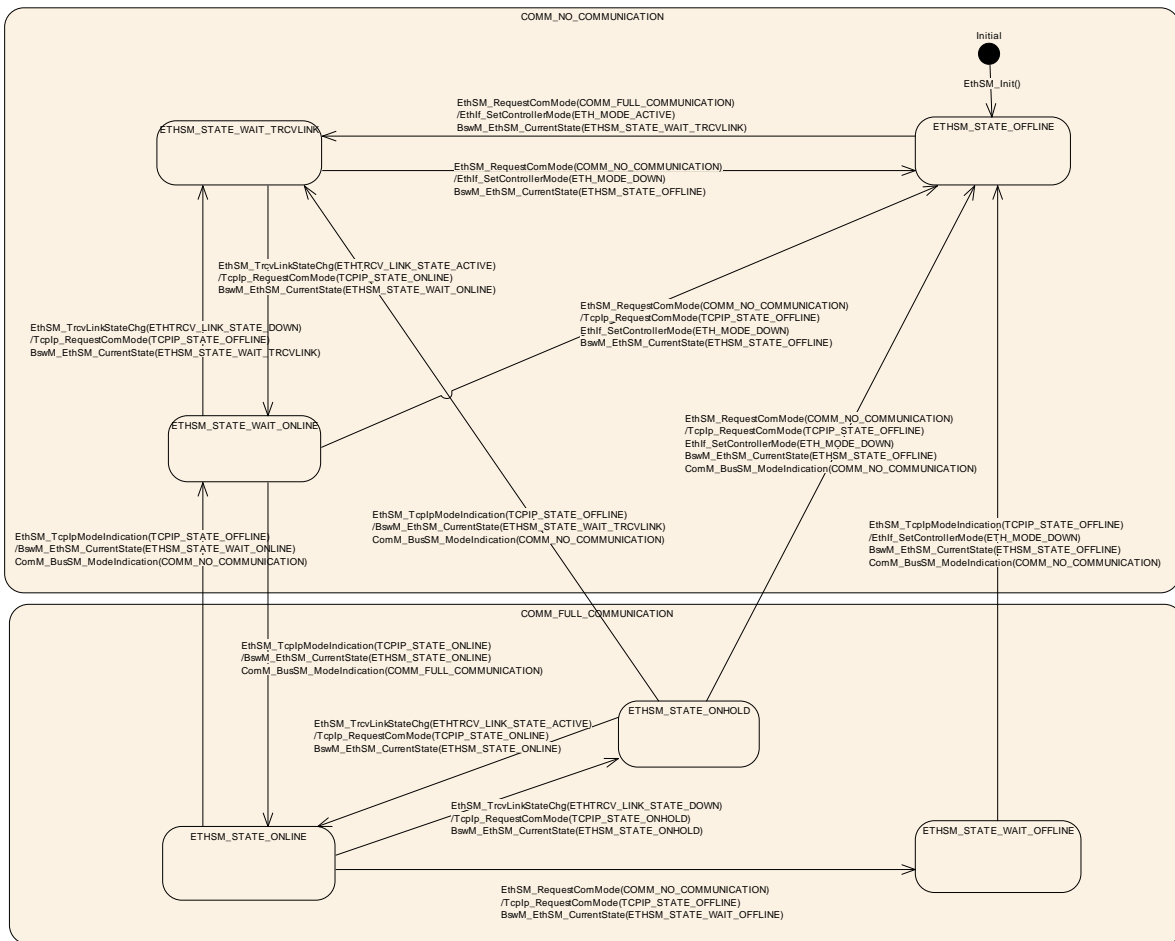

Figure 7-1: Network mode state machine of the EthSM

The Ethernet State Manager network mode state machine includes six sub states:

NO_COMMUNICATION	ETHSM_STATE_OFFLINE
	ETHSM_STATE_WAIT_TRCVLINK
	ETHSM_STATE_WAIT_ONLINE
FULL_COMMUNICATION	ETHSM_STATE_ONLINE
	ETHSM_STATE_ONHOLD
	ETHSM_STATE_WAIT_OFFLINE

The table below shows the detailed conditions of the sub states:

State	Controller Mode	Transceiver Mode	Transceiver Link	TcpIP Address	ComM Mode
ETHSM_STATE_OFFLINE	DOWN	DOWN	DOWN	OFFLINE	No Communication
ETHSM_STATE_WAIT_TRCVLINK	ACTIVE	ACTIVE	DOWN	OFFLINE	No Communication
ETHSM_STATE_WAIT_ONLINE	ACTIVE	ACTIVE	ACTIVE	OFFLINE	No Communication
ETHSM_STATE_ONLINE	ACTIVE	ACTIVE	ACTIVE	ONLINE	Full Communication
ETHSM_STATE_ONHOLD	ACTIVE	ACTIVE	DOWN	ONLINE	Full Communication
ETHSM_STATE_WAIT_OFFLINE	ACTIVE	ACTIVE	ACTIVE	ONLINE	Full Communication

To reach COMM\_FULL\_COMMUNICATION following conditions are necessary:

- Ethernet Interface Controller and transceiver are active
- The transceiver link state is active
- An active IP communication is available

The first step is set the controller to ACTIVE. After this is done, the Ethernet State Manager is in the sub state ETHSM\_STATE\_WAIT\_TRCVLINK.

In this sub state the state manager has to wait for the monitored link state information of the transceiver. After the link state is set to ACTIVE, the Ethernet State Manager is in the sub state ETHSM\_STATE\_WAIT\_ONLINE.

In this sub state the state manager has to wait for the monitored TcpIp state information of the TcpIp module. After the TcpIP state is set to ACTIVE (= IP communication is available), the Ethernet State Manager is in the sub state ETHSM\_STATE\_ONLINE.

→ Now FULL\_COMMUNICATION is reached.

### 7.6.1 Initial transition

[SWS\_EthSM\_00025] [

After the initialization of the EthSM the state machine shall have a transition to ETHSM\_STATE\_OFFLINE.

The initialization of the EthSM causes no further transactions in other modules. So no separate sequence diagram is needed.] ()

### 7.6.2 Transition between substate WAIT\_TRCVLINK and OFFLINE

[SWS\_EthSM\_00026] [

In the state ETHSM\_STATE\_OFFLINE the state machine shall have a transition to ETHSM\_STATE\_WAIT\_TRCVLINK, if the ComM requests COMM\_FULL\_COMMUNICATION for the corresponding network handle. In this

transition the EthSM shall interact like specified in the sequence diagram Figure 9-1.  
] ()

[SWS\_EthSM\_00088] [  
The transition from ETHSM\_STATE\_OFFLINE to  
ETHSM\_STATE\_WAIT\_TRCVLINK set the controller mode to ETH\_MODE\_ACTIVE.  
] ()

[SWS\_EthSM\_00097][  
After the successful transition from ETHSM\_STATE\_OFFLINE to  
ETHSM\_STATE\_WAIT\_TRCVLINK the Ethernet State Manager shall call the  
callback function BswM\_EthSM\_CurrentState of the BswM and transmit the internal  
state ETHSM\_STATE\_WAIT\_TRCVLINK.] ()

[SWS\_EthSM\_00127] [  
In the state ETHSM\_STATE\_WAIT\_TRCVLINK the state machine shall have a  
transition to ETHSM\_STATE\_OFFLINE, if the ComM requests  
COMM\_NO\_COMMUNICATION for the corresponding network handle.] ()

[SWS\_EthSM\_00128] [  
The transition from ETHSM\_STATE\_WAIT\_TRCVLINK to  
ETHSM\_STATE\_OFFLINE sets the controller mode to ETH\_MODE\_DOWN. ] ()

[SWS\_EthSM\_00130][  
After the successful transition from ETHSM\_STATE\_WAIT\_TRCVLINK to  
ETHSM\_STATE\_OFFLINE the Ethernet State Manager shall call the callback  
function BswM\_EthSM\_CurrentState of the BswM and transmit the internal state  
ETHSM\_STATE\_OFFLINE.] ()

### 7.6.3 Transition between substate WAIT\_TRCVLINK and WAIT\_ONLINE

[SWS\_EthSM\_00132] [  
In the state ETHSM\_STATE\_WAIT\_TRCVLINK the state machine shall have a  
transition to ETHSM\_STATE\_WAIT\_ONLINE, if the Ethernet Interface reports  
ETHTRCV\_LINK\_STATE\_ACTIVE for the corresponding network handle. In this  
transition the EthSM shall interact like specified in the sequence diagram Figure 9-1.  
] ()

[SWS\_EthSM\_00133] [  
The transition from ETHSM\_STATE\_WAIT\_TRCVLINK to  
ETHSM\_STATE\_WAIT\_ONLINE shall request the Tcplp state  
TCPIP\_STATE\_ONLINE from the Tcplp module.] ()

[SWS\_EthSM\_00134][  
After the successful transition from ETHSM\_STATE\_WAIT\_TRCVLINK to  
ETHSM\_STATE\_WAIT\_ONLINE the Ethernet State Manager shall call the callback

function BswM\_EthSM\_CurrentState of the BswM and transmit the internal state ETHSM\_STATE\_WAIT\_ONLINE.] ()

[SWS\_EthSM\_00136] [

In the state ETHSM\_STATE\_WAIT\_ONLINE the state machine shall have a transition to ETHSM\_STATE\_WAIT\_TRCVLINK, if the Ethernet interface reports ETHTRCV\_LINK\_STATE\_DOWN for the corresponding network handle.] ()

[SWS\_EthSM\_00137] [

The transition from ETHSM\_STATE\_WAIT\_ONLINE to ETHSM\_STATE\_WAIT\_TRCVLINK shall request the Tcplp state TCPIP\_STATE\_OFFLINE from the Tcplp module.] ()

[SWS\_EthSM\_00138]

After the successful transition from ETHSM\_STATE\_WAIT\_ONLINE to ETHSM\_STATE\_WAIT\_TRCVLINK the Ethernet State Manager shall call the callback function BswM\_EthSM\_CurrentState of the BswM and transmit the internal state ETHSM\_STATE\_WAIT\_TRCVLINK.] ()

#### **7.6.4 Transition from substate WAIT\_ONLINE to OFFLINE**

[SWS\_EthSM\_00140] [

In the state ETHSM\_STATE\_WAIT\_ONLINE the state machine shall have a transition to ETHSM\_STATE\_OFFLINE, if the ComM requests COMM\_NO\_COMMUNICATION for the corresponding network handle.] ()

[SWS\_EthSM\_00141] [

The transition from ETHSM\_STATE\_WAIT\_ONLINE to ETHSM\_STATE\_OFFLINE sets the controller mode to ETH\_MODE\_DOWN. ] ()

[SWS\_EthSM\_00143] [

The transition from ETHSM\_STATE\_WAIT\_ONLINE to ETHSM\_STATE\_OFFLINE shall request the Tcplp state TCPIP\_STATE\_OFFLINE from the Tcplp module.]()

[SWS\_EthSM\_00144]

After the successful transition from ETHSM\_STATE\_WAIT\_ONLINE to ETHSM\_STATE\_OFFLINE the Ethernet State Manager shall call the callback function BswM\_EthSM\_CurrentState of the BswM and transmit the internal state ETHSM\_STATE\_OFFLINE.] ()

#### **7.6.5 Transition between substate WAIT\_ONLINE and ONLINE**

[SWS\_EthSM\_00146] [

In the state ETHSM\_STATE\_WAIT\_ONLINE the state machine shall have a transition to ETHSM\_STATE\_ONLINE, if the Tcplp modul reports



TCPIP\_STATE\_ONLINE for the corresponding network handle. In this transition the EthSM shall interact like specified in the sequence diagram Figure 9-1.] ()

[SWS\_EthSM\_00148]

After the successful transition from ETHSM\_STATE\_WAIT\_ONLINE to ETHSM\_STATE\_ONLINE the Ethernet State Manager shall call the callback function BswM\_EthSM\_CurrentState of the BswM and transmit the internal state ETHSM\_STATE\_ONLINE.] ()

[SWS\_EthSM\_00150]

After the successful transition from ETHSM\_STATE\_WAIT\_ONLINE to ETHSM\_STATE\_ONLINE the Ethernet State Manager shall call the callback function ComM\_BusSM\_ModelIndication of the ComM and transmit the communication mode (COMM\_FULL\_COMMUNICATION).]()

[SWS\_EthSM\_00151] [

In the state ETHSM\_STATE\_ONLINE the state machine shall have a transition to ETHSM\_STATE\_WAIT\_ONLINE, if the Tcplp modul reports TCPIP\_STATE\_OFFLINE for the corresponding network handle.] ()

[SWS\_EthSM\_00152] [

After the successful transition from ETHSM\_STATE\_ONLINE to ETHSM\_STATE\_WAIT\_ONLINE the Ethernet State Manager shall call the callback function BswM\_EthSM\_CurrentState of the BswM and transmit the internal state ETHSM\_STATE\_WAIT\_ONLINE.] ()

[SWS\_EthSM\_00154] [

After the successful transition from ETHSM\_STATE\_ONLINE to ETHSM\_STATE\_WAIT\_ONLINE the Ethernet State Manager shall call the callback function ComM\_BusSM\_ModelIndication of the ComM and transmit the communication mode (COMM\_NO\_COMMUNICATION). ]()

### **7.6.6 Transition from substate ONLINE to WAIT\_OFFLINE**

[SWS\_EthSM\_00155] [

In the state ETHSM\_STATE\_ONLINE the state machine shall have a transition to ETHSM\_STATE\_WAIT\_OFFLINE, if the ComM requests COMM\_NO\_COMMUNICATION for the corresponding network handle. In this transition the EthSM shall interact like specified in the sequence diagram

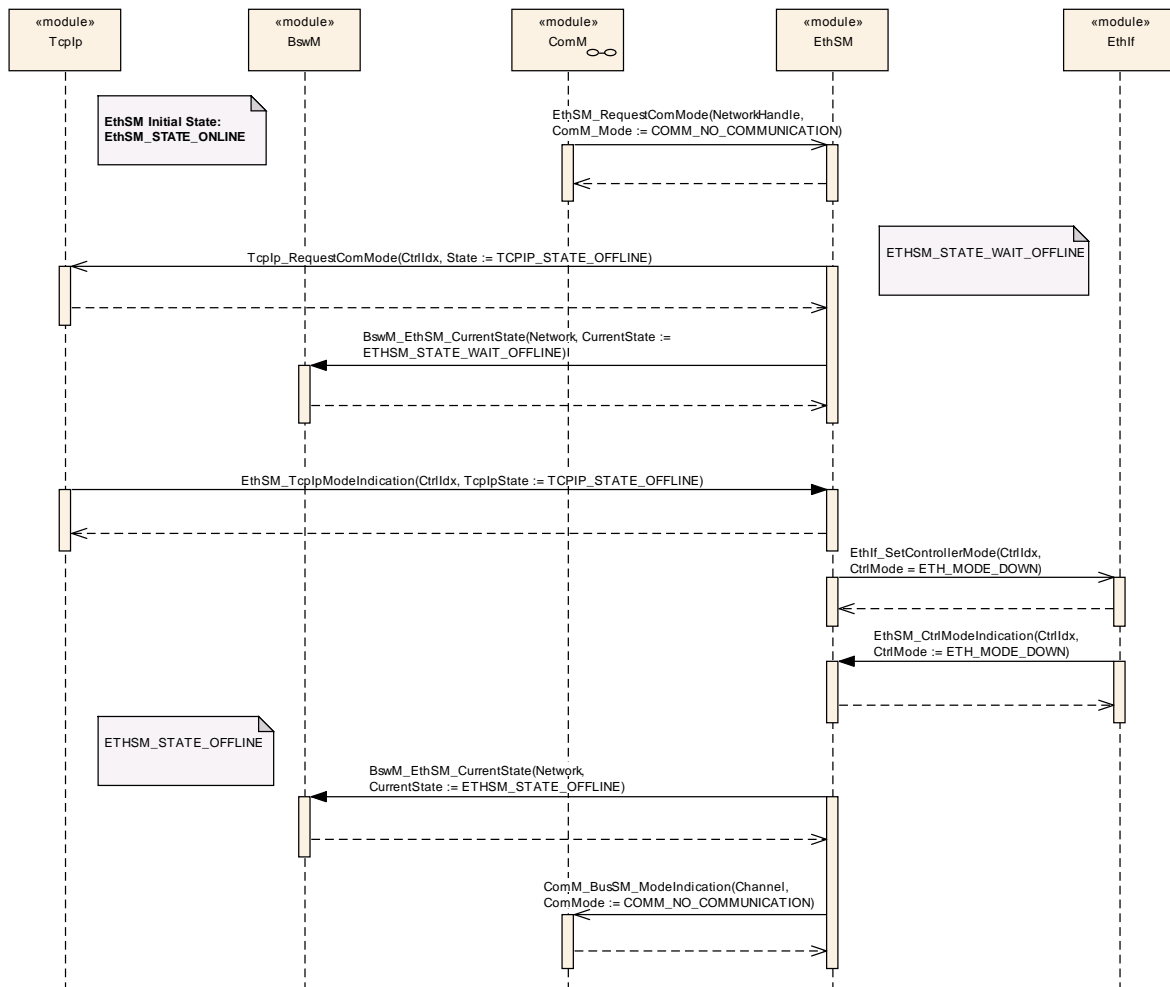

Figure 9-2.] ()

[SWS\_EthSM\_00157] [

After entering the state ETHSM\_STATE\_WAIT\_OFFLINE, the API Tcplp\_RequestComMode shall be called with TCPIP\_STATE\_OFFLINE. ]()

[SWS\_EthSM\_00158]

After the successful transition from ETHSM\_STATE\_ONLINE to ETHSM\_STATE\_WAIT\_OFFLINE the Ethernet State Manager shall call the callback function BswM\_EthSM\_CurrentState of the BswM and transmit the internal state ETHSM\_STATE\_WAIT\_OFFLINE.] ()

### 7.6.7 Transition from substate WAIT\_OFFLINE to OFFLINE

[SWS\_EthSM\_00160] [

In the state ETHSM\_STATE\_WAIT\_OFFLINE the state machine shall have a transition to ETHSM\_STATE\_OFFLINE, if the Tcplp modul reports TCPIP\_STATE\_OFFLINE for the corresponding network handle. In this transition the EthSM shall interact like specified in the sequence diagram

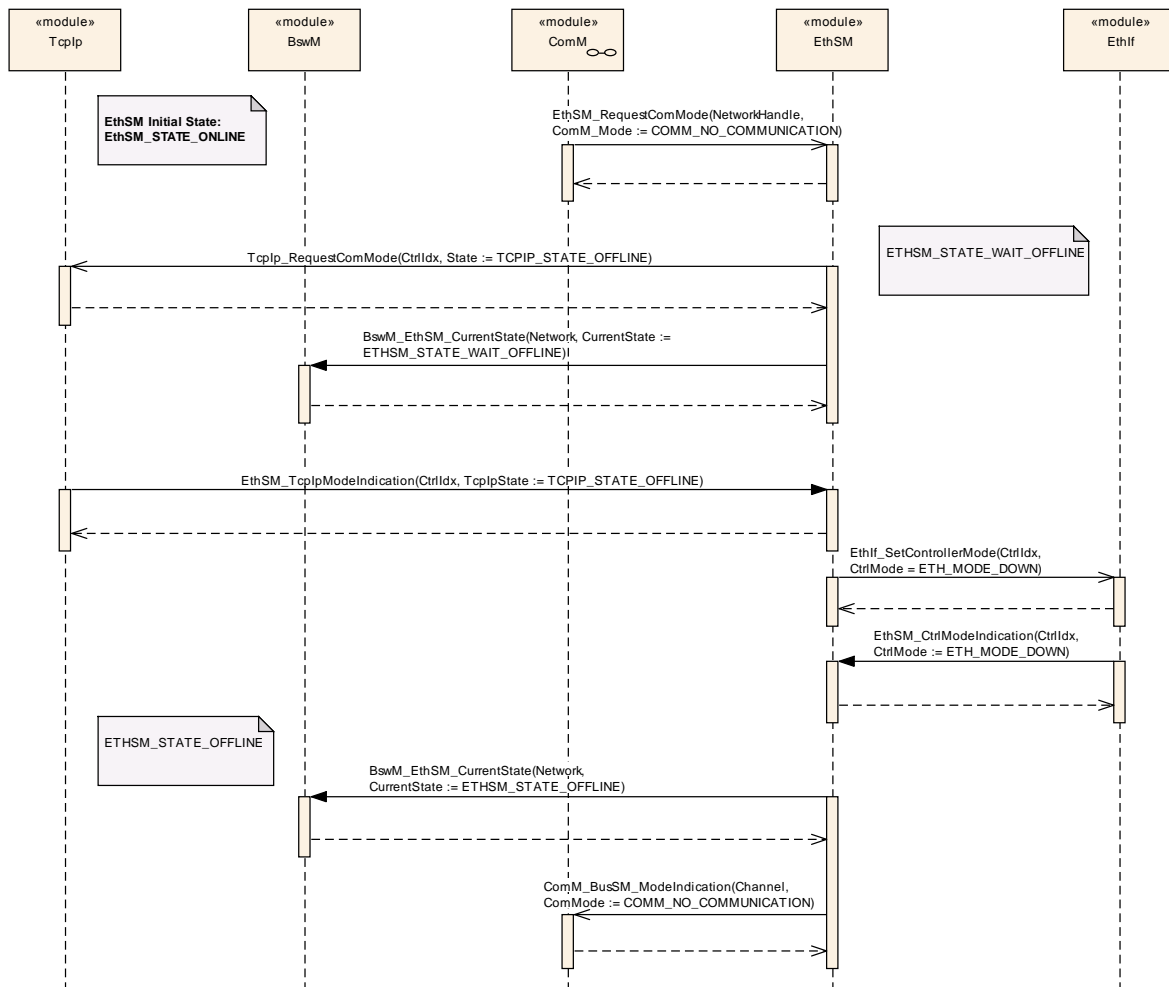

Figure 9-2.] ()

[SWS\_EthSM\_00161] [

The transition from ETHSM\_STATE\_WAIT\_OFFLINE to ETHSM\_STATE\_OFFLINE sets the controller mode to ETH\_MODE\_DOWN. ] ()

[SWS\_EthSM\_00163] [

After the successful transition from ETHSM\_STATE\_WAIT\_OFFLINE to ETHSM\_STATE\_OFFLINE the Ethernet State Manager shall call the callback function BswM\_EthSM\_CurrentState of the BswM and transmit the internal state ETHSM\_STATE\_OFFLINE.] ()

[SWS\_EthSM\_00165] [

After the successful transition from ETHSM\_STATE\_WAIT\_OFFLINE to ETHSM\_STATE\_OFFLINE the Ethernet State Manager shall call the callback function ComM\_BusSM\_ModeIndication of the ComM and transmit the communication mode (COMM\_NO\_COMMUNICATION). ]()

### 7.6.8 Transition between substate **ONLINE** and **ONHOLD**

[SWS\_EthSM\_00166] [

In the state ETHSM\_STATE\_ONLINE the state machine shall have a transition to ETHSM\_STATE\_ONHOLD, if the Ethernet Interface reports ETHTRCV\_LINK\_STATE\_DOWN for the corresponding network handle. In this transition the EthSM shall interact like specified in the sequence diagram

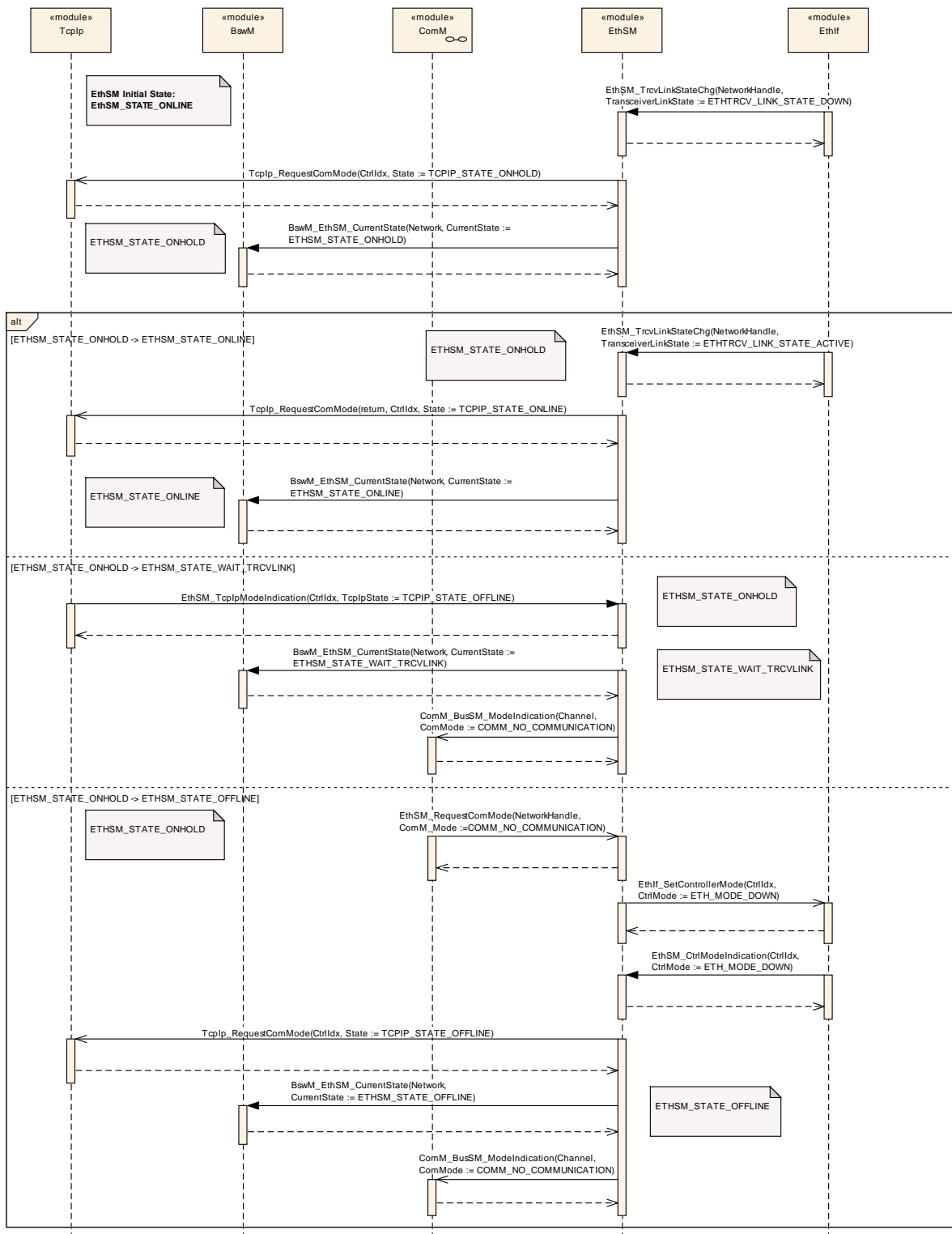

Figure 9-3.] ( )

[SWS\_EthSM\_00167] [

The transition from ETHSM\_STATE\_ONLINE to ETHSM\_STATE\_ONHOLD shall request the Tcplp state TCPIP\_STATE\_ONHOLD from the Tcplp module.] ( )

[SWS\_EthSM\_00168]

After the successful transition from ETHSM\_STATE\_ONLINE to ETHSM\_STATE\_ONHOLD the Ethernet State Manager shall call the callback function BswM\_EthSM\_CurrentState of the BswM and transmit the internal state ETHSM\_STATE\_ONHOLD.] ()

[SWS\_EthSM\_00170] [

In the state ETHSM\_STATE\_ONHOLD the state machine shall have a transition to ETHSM\_STATE\_ONLINE, if the Ethernet interface reports ETHTRCV\_LINK\_STATE\_ACTIVE for the corresponding network handle.] ()

[SWS\_EthSM\_00171] [

The transition from ETHSM\_STATE\_ONHOLD to ETHSM\_STATE\_ONLINE shall request the Tcplp state TCPIP\_STATE\_ONLINE from the Tcplp module.] ()

[SWS\_EthSM\_00172]

After the successful transition from ETHSM\_STATE\_ONHOLD to ETHSM\_STATE\_ONLINE the Ethernet State Manager shall call the callback function BswM\_EthSM\_CurrentState of the BswM and transmit the internal state ETHSM\_STATE\_ONLINE.] ()

[SWS\_EthSM\_00188]

If the optional configuration parameter ETHSM\_E\_LINK\_DOWN exists, ETHSM\_E\_LINK\_DOWN with EventStatus DEM\_EVENT\_STATUS\_FAILED shall be reported to the DEM module when switching from ETHSM\_STATE\_ONLINE to ETHSM\_STATE\_ONHOLD.] ()

[SWS\_EthSM\_00196]

If the optional configuration parameter ETHSM\_E\_LINK\_DOWN exists, ETHSM\_E\_LINK\_DOWN with EventStatus DEM\_EVENT\_STATUS\_PASSED shall be reported to the DEM module when switching from ETHSM\_STATE\_ONHOLD to ETHSM\_STATE\_ONLINE.] ()

### 7.6.9 Transition from substate ONHOLD to WAIT\_TRCVLINK

[SWS\_EthSM\_00174] [

In the state ETHSM\_STATE\_ONHOLD the state machine shall have a transition to ETHSM\_STATE\_WAIT\_TRCVLINK, if the Tcplp modul reports TCPIP\_STATE\_OFFLINE for the corresponding network handle. In this transition the EthSM shall interact like specified in the sequence diagram

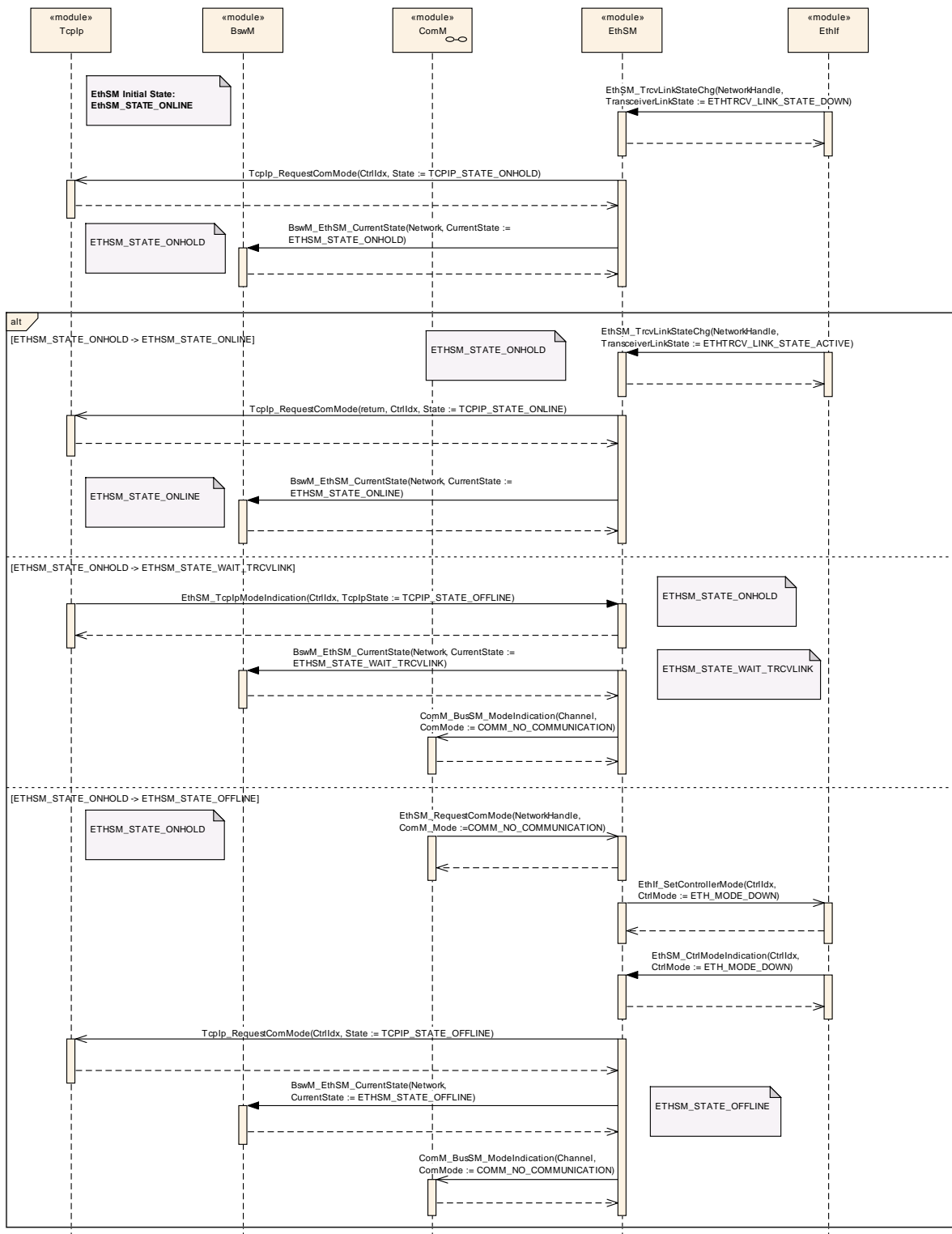

Figure 9-3.] ()

[SWS\_EthSM\_00175] [

After the successful transition from ETHSM\_STATE\_ONHOLD to ETHSM\_STATE\_WAIT\_TRCVLINK the Ethernet State Manager shall call the

callback function BswM\_EthSM\_CurrentState of the BswM and transmit the internal state ETHSM\_STATE\_WAIT\_TRCVLINK.] ()

[SWS\_EthSM\_00177] [

After the successful transition from ETHSM\_STATE\_ONHOLD to ETHSM\_STATE\_WAIT\_TRCVLINK the Ethernet State Manager shall call the callback function ComM\_BusSM\_ModeIndication of the ComM and transmit the communication mode (COMM\_NO\_COMMUNICATION). ] ()

#### **7.6.10 Transition from substate ONHOLD to OFFLINE**

[SWS\_EthSM\_00178] [

In the state ETHSM\_STATE\_ONHOLD the state machine shall have a transition to ETHSM\_STATE\_OFFLINE, if the ComM requests COMM\_NO\_COMMUNICATION for the corresponding network handle. In this transition the EthSM shall interact like specified in the sequence diagram



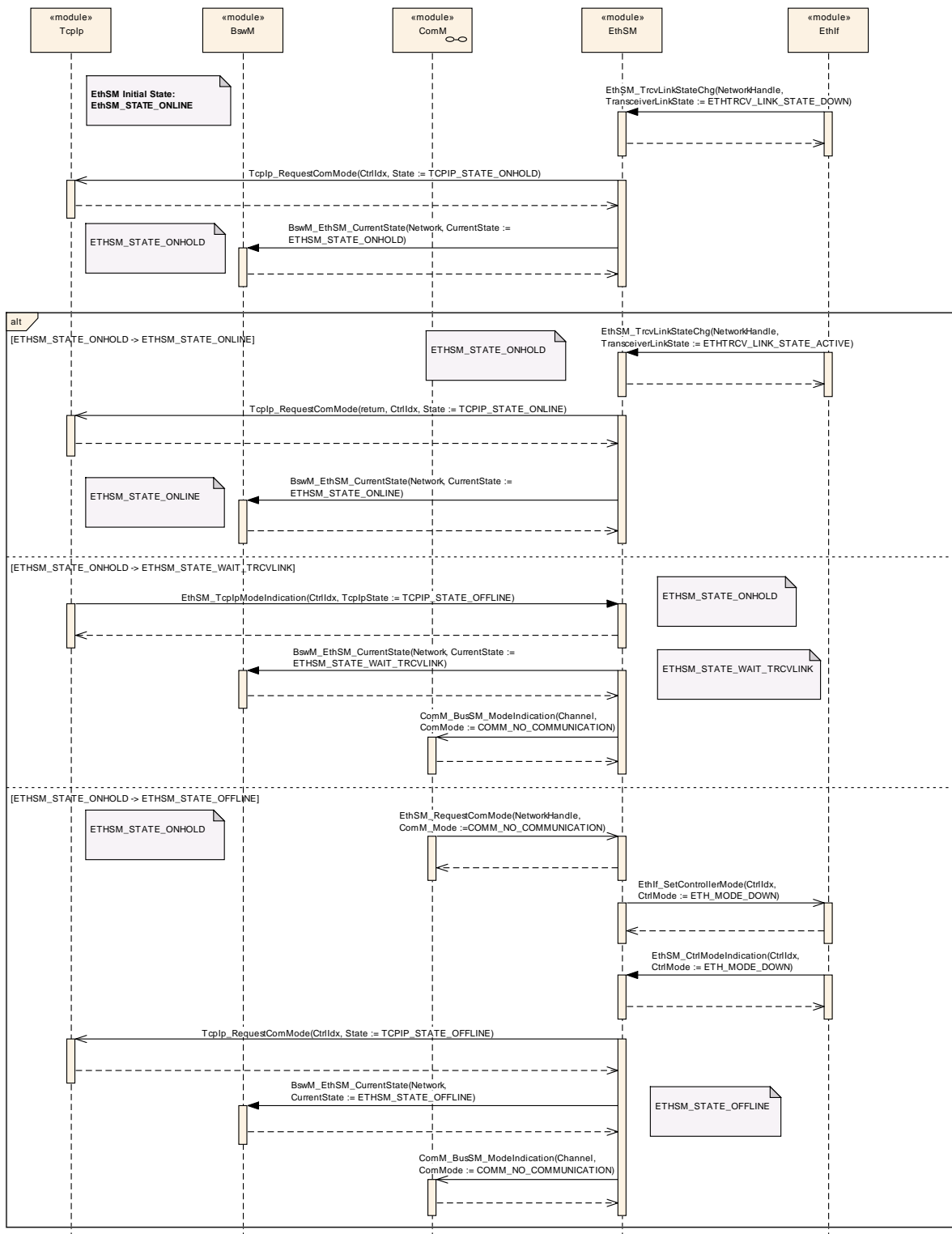

Figure 9-3.] ( )

[SWS\_EthSM\_00179] [

The transition from ETHSM\_STATE\_ONHOLD to ETHSM\_STATE\_OFFLINE sets the controller mode to ETH\_MODE\_DOWN.] ( )

[SWS\_EthSM\_00181]

The transition from ETHSM\_STATE\_ONHOLD to ETHSM\_STATE\_OFFLINE shall request the Tcplp state TCPIP\_STATE\_OFFLINE from the Tcplp module.] ()

[SWS\_EthSM\_00182]

After the successful transition from ETHSM\_STATE\_ONHOLD to ETHSM\_STATE\_OFFLINE the Ethernet State Manager shall call the callback function BswM\_EthSM\_CurrentState of the BswM and transmit the internal state ETHSM\_STATE\_OFFLINE.] ()

[SWS\_EthSM\_00184]

After the successful transition from ETHSM\_STATE\_ONHOLD to ETHSM\_STATE\_OFFLINE the Ethernet State Manager shall call the callback function ComM\_BusSM\_ModelIndication of the ComM and transmit the communication mode (COMM\_NO\_COMMUNICATION).] ()

### 7.6.11 Information about state transitions

[SWS\_EthSM\_00083] [

After the state machine has finished a state transition, the Ethernet State Manager has to inform the ComM and the BswM about the actual state of the Ethernet State Manager (see Figure 9-1 and

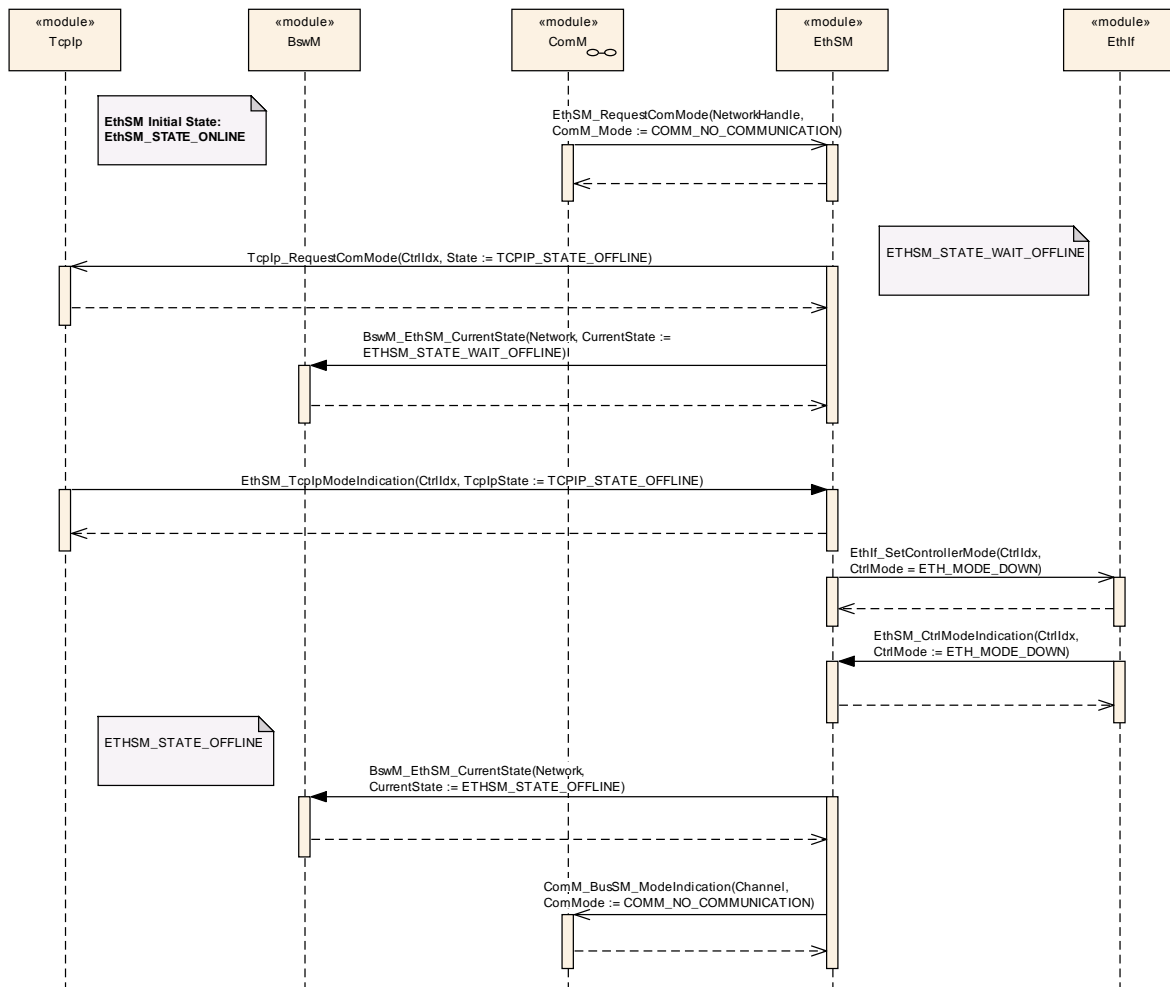

Figure 9-2).  
The ComM needs the information about the communication states, e.g. COMM\_FULL\_COMMUNICATION or COMM\_NO\_COMMUNICATION.  
The BswM needs the information about the EthSM internal states, see [\[SWS\\_EthSM\\_00041\].](#) ()

## 7.7 Error notification

For details refer to the chapters 7.2.1 “Error classification” & 7.2.2 “Development Errors” in *SWS\_BSWGeneral*.

## 7.8 Error classification

### 7.8.1 Development Errors

[SWS\_EthSM\_00200]

<i>Type or error</i>	<i>Related error code</i>	<i>Value [hex]</i>
Invalid communication mode requested	ETHSM_E_INVALID_NETWORK_MODE	0x01
EthSM module was not initialized	ETHSM_E_UNINIT	0x02
Invalid pointer in parameter list	ETHSM_E_PARAM_POINTER	0x03
Invalid parameter in parameter list	ETHSM_E_INVALID_NETWORK_HANDLE	0x04
Invalid Tcplp state	ETHSM_E_INVALID_TCP_IP_MODE	0x05
Invalid parameter in parameter list	ETHSM_E_PARAM_CONTROLLER	0x07

] ()

### 7.8.2 Runtime Errors

There are no Runtime Errors

### 7.8.3 Transcient Faults

There are no transient faults.

### 7.8.4 Production Errors

[SWS\_EthSM\_00202]

<b>Error Name:</b>	ETHSM_E_LINK_DOWN	
<b>Short Description:</b>	Link down detection	
<b>Long Description:</b>	It shall be reported when the transceiver switches to “down” while communication has already been established and is requested because of communication request	
<b>Recommended DTC:</b>	N/A	
<b>Detection Criteria:</b>	FAIL	During transition from ETHSM_STATE_ONLINE to ETHSM_STATE_ONHOLD, which is triggered by EthSM_TrvcLinkStateChg(ETHTRCV_LINK_STATE_DOWN)
	PASS	During transition from ETHSM_STATE_ONHOLD to ETHSM_STATE_ONLINE, which is triggered by EthSM_TrvcLinkStateChg(ETHTRCV_LINK_STATE_ACTIVATE)
<b>Secondary Parameters:</b>	None	
<b>Time Required:</b>	PRE_FAIL: Immediately PASS: Configuration dependent	
<b>Monitor Frequency</b>	Continuous	
<b>MIL illumination:</b>	N/A	

] ()

### 7.8.5 Extended Production Errors

There are no extended production errors.

### 7.9 Commercial Off The Shelf stack usage

A commercial off the shelf stack (COTS) shall be useable. The commercial stack is useable without adaptation (Variant 1 in Figure 7-2). However, the Ethernet State Manager is not able to control the Ethernet Interface Controller and Ethernet transceiver in this case. The commercial stack may be adapted for usage with the Ethernet Interface. In this case, the Ethernet State Manager is able to control both Ethernet Interface Controller and Ethernet transceiver (Variant 2 in Figure 7-2).

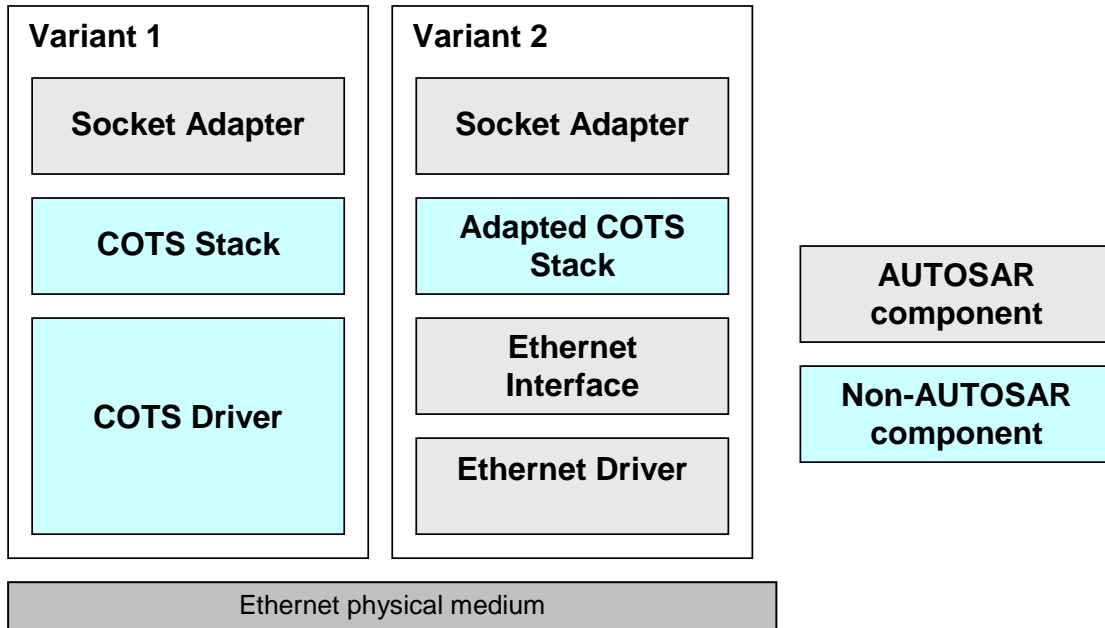

**Figure 7-2: BSW stack architecture variants**

[SWS\_EthSM\_00078]

It is possible to set the Ethernet State Manager in a dummy mode (see chapter 10 configuration specification). In this mode, the Ethernet State Manager doesn't support the API to the Ethernet interface. The API to the ComM is available but the functionality is deactivated. The function calls from the ComM will be answered with the return value E\_OK.] ()

## 8 API specification

### 8.1 Imported types

[SWS\_EthSM\_91001] |

Module	Header File	Imported Type
ComM	Rte_ComM_Type.h	ComM_ModeType
ComStack_Types	ComStackTypes.h	NetworkHandleType
Dem	Rte_Dem_Type.h	Dem_EventIdType
	Rte_Dem_Type.h	Dem_EventStatusType
Eth_GeneralTypes	Eth_GeneralTypes.h	EthTrcv_LinkStateType
	Eth_GeneralTypes.h	Eth_ModeType
Std_Types	StandardTypes.h	Std_ReturnType
	StandardTypes.h	Std_VersionInfoType
Tcplp	Tcplp.h	Tcplp_StateType

| ()

### 8.2 Type definitions

#### 8.2.1 EthSM\_NetworkModeStateType

[SWS\_EthSM\_00041] |

<b>Name:</b>	EthSM_NetworkModeStateType	
<b>Type:</b>	Enumeration	
<b>Range:</b>	ETHSM_STATE_OFFLINE	--EthSM is initialized in this state.
	ETHSM_STATE_WAIT_TRCVLINK	--ComM requests COMM_FULL_- COMMUNICATION in this state. Controller will be set to ACTIVE. EthSM waits for transceiver link state (ACTIVE).
	ETHSM_STATE_WAIT_ONLINE	--Transceiver link state is ACTIVE EthSM waits for IP communication (TcplP state = ONLINE)
	ETHSM_STATE_ONLINE	--IP communication is available ComM state COMM_FULL_COMMUNICATION is reached
	ETHSM_STATE_ONHOLD	--EthSM lost active transceiver link state, TcplP state is still ONLINE)
	ETHSM_STATE_WAIT_OFFLINE	--ComM requests COMM_NO_- COMMUNICATION in this state.
<b>Description:</b>	This type shall define the states of the network mode state machine.	
<b>Available via:</b>	EthSM.h	

| ()

## 8.3 Function definitions

This is a list of functions provided for upper layer modules.

### Note:

Depending on the Ethernet hardware, it may become necessary that implementations deviate from API specifications in respect to the asynchronous/synchronous behaviour.

### 8.3.1 EthSM\_Init

[SWS\_EthSM\_00043] [

<b>Service name:</b>	EthSM_Init
<b>Syntax:</b>	void EthSM_Init( void )
<b>Service ID[hex]:</b>	0x07
<b>Sync/Async:</b>	Synchronous
<b>Reentrancy:</b>	Non Reentrant
<b>Parameters (in):</b>	None
<b>Parameters (inout):</b>	None
<b>Parameters (out):</b>	None
<b>Return value:</b>	None
<b>Description:</b>	This function initialize the EthSM.
<b>Available via:</b>	EthSM.h

] (SRS\_BSW\_00405, SRS\_BSW\_00101, SRS\_BSW\_00358, SRS\_BSW\_00414)

### 8.3.2 EthSM\_GetVersionInfo

[SWS\_EthSM\_00046] [

<b>Service name:</b>	EthSM_GetVersionInfo
<b>Syntax:</b>	void EthSM_GetVersionInfo( Std_VersionInfoType* versioninfo )
<b>Service ID[hex]:</b>	0x02
<b>Sync/Async:</b>	Synchronous
<b>Reentrancy:</b>	Reentrant
<b>Parameters (in):</b>	None
<b>Parameters (inout):</b>	None
<b>Parameters (out):</b>	versioninfo   Pointer where to put out the version information.
<b>Return value:</b>	None
<b>Description:</b>	This service puts out the version information of this module.
<b>Available via:</b>	EthSM.h

] (SRS\_BSW\_00407, SRS\_BSW\_00003)

### 8.3.3 EthSM\_RequestComMode

[SWS\_EthSM\_00050] [

<b>Service name:</b>	EthSM_RequestComMode	
<b>Syntax:</b>	Std_ReturnType EthSM_RequestComMode( NetworkHandleType NetworkHandle, ComM_ModeType ComM_Mode )	
<b>Service ID[hex]:</b>	0x05	
<b>Sync/Async:</b>	Asynchronous	
<b>Reentrancy:</b>	Non Reentrant	
<b>Parameters (in):</b>	NetworkHandle	Handle of destinated communication network for request
	ComM_Mode	Requested communication mode
<b>Parameters (inout):</b>	None	
<b>Parameters (out):</b>	None	
<b>Return value:</b>	Std_ReturnType	E_OK: Service accepted E_NOT_OK: Service denied
<b>Description:</b>	Handles the communication mode and sets the Ethernet network active or passive.	
<b>Available via:</b>	EthSM.h	

] ()

Remark: The function reentrancy is limited to different network handles. Reentrancy for the same network is not to be regarded here.

[SWS\_EthSM\_00051] [

The function `EthSM_RequestComMode` checks the network handle of the request. It only accepts the request, if the network handle of the request is a handle contained in the EthSM configuration (configuration parameter `EthSMNetworkHandle`). In this case the return value is set to `E_OK`.

If it is not contained in the configuration, the function denies the request. In this case the return value is set to `E_NOT_OK`.] ()

[SWS\_EthSM\_00052] [

The function `EthSM_RequestComMode` shall report `ETHSM_E_INVALID_NETWORK_HANDLE` to the DET, if it does not accept the network handle of the request.] ()

[SWS\_EthSM\_00095] [

The function `EthSM_RequestComMode` shall report `ETHSM_E_INVALID_NETWORK_MODE` to the DET, if it does not accept the `ComM_Mode` of the request.] ()

[SWS\_EthSM\_00053] [

If the function `EthSM_RequestComMode` accepts the function call, it shall store the communication mode for the network handle and the corresponding network mode switch of the state machine shall be initiated in the next main function cycle latest.] ()

[SWS\_EthSM\_00054] [

The function `EthSM_RequestComMode` shall report `ETHSM_E_UNINIT` to the DET, if the EthSM is not initialized yet.] (SRS\_BSW\_00406)

[SWS\_EthSM\_00199][



The function `EthSM_RequestComMode` shall accept `SilentCom` request from `ComM` and will return `E_OK`. No error shall be reported to `ComM` in this case, though `SilentCom` is not available according to [SWS\\_EthSM\\_00087](#)] ()

### 8.3.4 EthSM\_GetCurrentComMode

#### [SWS\_EthSM\_00055] [

<b>Service name:</b>	EthSM_GetCurrentComMode	
<b>Syntax:</b>	Std_ReturnType EthSM_GetCurrentComMode ( NetworkHandleType NetworkHandle, ComM_ModeType* ComM_ModePtr )	
<b>Service ID[hex]:</b>	0x04	
<b>Sync/Async:</b>	Synchronous	
<b>Reentrancy:</b>	Non Reentrant	
<b>Parameters (in):</b>	NetworkHandle	Network handle whose current communication mode shall be put out
<b>Parameters (inout):</b>	None	
<b>Parameters (out):</b>	ComM_ModePtr	Pointer where to put out the current communication mode
<b>Return value:</b>	Std_ReturnType	E_OK: Service accepted E_NOT_OK: Service denied
<b>Description:</b>	This service shall put out the current communication mode of a Ethernet network.	
<b>Available via:</b>	EthSM.h	

] ()

#### [SWS\_EthSM\_00057] [

The function `EthSM_GetCurrentComMode` checks the network handle of the service request. It only accepts the service, if the network handle of the request is a handle contained in the `EthSM` configuration (configuration parameter `EthSMNetworkHandle`). In this case the return value is set to `E_OK`.

If it is not contained in the configuration, the function denies the request. In this case the return value is set to `E_NOT_OK`.] ()

#### [SWS\_EthSM\_00058] [

The function `EthSM_GetCurrentComMode` shall report `ETHSM_E_INVALID_NETWORK_HANDLE` to the `DET`, if it does not accept the network handle of the request.] ()

#### [SWS\_EthSM\_00059] [

The function `EthSM_GetCurrentComMode` puts out the current communication mode for the network handle to the designated pointer of type `ComM_ModeType`, if it accepts the request.] ()

Remark: Because the Ethernet hardware needs a certain time to proceed with the request and there is currently no notification mechanism specified, the real hardware mode and the mode notified by the `EthSM` might be different until the hardware is ready.

#### [SWS\_EthSM\_00060] [

The function `EthSM_GetCurrentComMode` shall report `ETHSM_E_UNINIT` to the `DET`, if the `EthSM` is not initialized yet.] ([SRS\\_BSW\\_00406](#), [SRS\\_BSW\\_00374](#), [SRS\\_BSW\\_00003](#), [SRS\\_BSW\\_00318](#))

## 8.4 Call-back notifications

### 8.4.1 EthSM\_CtrlModeIndication

[SWS\_EthSM\_00190] [

<b>Service name:</b>	EthSM_CtrlModeIndication	
<b>Syntax:</b>	<pre>void EthSM_CtrlModeIndication(     uint8 CtrlIdx,     Eth_ModeType CtrlMode )</pre>	
<b>Service ID[hex]:</b>	0x09	
<b>Sync/Async:</b>	Synchronous	
<b>Reentrancy:</b>	Reentrant (only for different Ethernet controllers)	
<b>Parameters (in):</b>	CtrlIdx	Ethernet Interface Controller whose mode has changed
	CtrlMode	Notified Ethernet Interface Controller mode
<b>Parameters (inout):</b>	None	
<b>Parameters (out):</b>	None	
<b>Return value:</b>	None	
<b>Description:</b>	Called when mode has been read out. Either triggered by previous EthIf_GetControllerMode or by EthIf_SetControllerMode call. Can directly be called within the trigger functions.	
<b>Available via:</b>	EthSM.h	

] ()

[SWS\_EthSM\_00191]

If the function EthSM\_CtrlModeIndication gets a CtrlIdx, which is not configured in the configuration of the EthSM module, it shall call the function Det\_ReportError with ErrorId parameter ETHSM\_E\_PARAM\_CONTROLLER.] ()

[SWS\_EthSM\_00192]

If the EthSM module is not initialized, when the function EthSM\_CtrlModeIndication is called, then the function EthSM\_CtrlModeIndication shall call the function Det\_ReportError with ErrorId parameter ETHSM\_E\_UNINIT.] ()

### 8.4.2 EthSM\_TrcvLinkStateChg

[SWS\_EthSM\_00109] [

<b>Service name:</b>	EthSM_TrcvLinkStateChg	
<b>Syntax:</b>	<pre>void EthSM_TrcvLinkStateChg(     uint8 CtrlIdx,     EthTrcv_LinkStateType TransceiverLinkState )</pre>	
<b>Service ID[hex]:</b>	0x06	
<b>Sync/Async:</b>	Synchronous	
<b>Reentrancy:</b>	Non Reentrant	
<b>Parameters (in):</b>	CtrlIdx	Index of the Ethernet controller within the context of the

	Ethernet Interface
	TransceiverLinkState Actual transceiver link state of the specific network handle
<b>Parameters (inout):</b>	None
<b>Parameters (out):</b>	None
<b>Return value:</b>	None
<b>Description:</b>	This service is called by the Ethernet Interface to report a transceiver link state change.
<b>Available via:</b>	EthSM.h

] ()

[SWS\_EthSM\_00112] [

The function EthSM\_TrcvLinkStateChg shall report ETHSM\_E\_PARAM\_CONTROLLER to the DET, if it does not accept the CtrlIdx of the function call.] ()

[SWS\_EthSM\_00114] [

If the function EthSM\_TrcvLinkStateChg does not report a DET error, it shall store the transceiver link state for the affected network handle and the corresponding network mode switch of the state machine shall be initiated in the next main function cycle latest.

] ()

[SWS\_EthSM\_00115] [

The function EthSM\_TrcvLinkStateChg shall report ETHSM\_E\_UNINIT to the DET, if the EthSM is not initialized yet.] (SRS\_BSW\_00406)

### 8.4.3 EthSM\_TcplpModeIndication

[SWS\_EthSM\_00110] [

<b>Service name:</b>	EthSM_TcplpModeIndication	
<b>Syntax:</b>	void EthSM_TcplpModeIndication( uint8 CtrlIdx, TcpIp_StateType TcpIpState )	
<b>Service ID[hex]:</b>	0x08	
<b>Sync/Async:</b>	Synchronous	
<b>Reentrancy:</b>	Non Reentrant	
<b>Parameters (in):</b>	CtrlIdx	Ethlf controller index to identify the communication network where the Tcplp state is changed
	TcplpState	Actual Tcplp state of the specific network handle
<b>Parameters (inout):</b>	None	
<b>Parameters (out):</b>	None	
<b>Return value:</b>	None	
<b>Description:</b>	This service is called by the Tcplp to report the actual Tcplp state (e.g. online, offline).	
<b>Available via:</b>	EthSM_TcpIp.h	

] ()

[SWS\_EthSM\_00116] [

If the function `EthSM_TcpIpModeIndication` gets a `CtrlIdx`, which is not configured in the configuration of the `EthSM` module, it shall call the function `Det_ReportError` with `ErrorId` parameter `ETHSM_E_PARAM_CONTROLLER`.] ()

[SWS\_EthSM\_00118] [

If development error detection is enabled, the parameter `TcpIpState` shall be checked for being in the allowed range.

In case it is outside of the allowed range, the function `EthSM_TcpIpModeIndication` shall ignore the state indication and report development error `ETHSM_E_INVALID_TCP_IP_MODE` to the `DET`.] ()

[SWS\_EthSM\_00119] [

If the function `EthSM_TcpIpModeIndication` accepts the function call, it shall store the `TcpIp` state for the affected network handle and the corresponding network mode switch of the state machine shall be initiated in the next main function cycle latest.] ()

[SWS\_EthSM\_00120] [

The function `EthSM_TcpIpModeIndication` shall report `ETHSM_E_UNINIT` to the `DET`, if the `EthSM` is not initialized yet.] (`SRS_BSW_00406`)

## 8.5 Scheduled functions

These functions are directly called by Basic Software Scheduler. The following functions shall have no return value and no parameter. All functions shall be non reentrant.

### 8.5.1 EthSM\_MainFunction

[SWS\_EthSM\_00035] [

<b>Service name:</b>	<code>EthSM_MainFunction</code>
<b>Syntax:</b>	<code>void EthSM_MainFunction(     void )</code>
<b>Service ID[hex]:</b>	<code>0x01</code>
<b>Sync/Async:</b>	Synchronous
<b>Reentrancy:</b>	Non Reentrant
<b>Parameters (in):</b>	None
<b>Parameters (inout):</b>	None
<b>Parameters (out):</b>	None
<b>Return value:</b>	None
<b>Description:</b>	Cyclic Main Function which is called from the Scheduler.
<b>Available via:</b>	<code>EthSM_SchM.h</code>

] ()

[SWS\_EthSM\_00093] [

The function `EthSM_MainFunction` shall be called cyclically with a fixed cycle time. The cycle time could be defined via the configuration parameter `ETHSM_MAIN_FUNCTION_PERIOD`.] ()

[SWS\_EthSM\_00197] [

The main function of the EthSM module shall operate the effects of the EthSM state machine, which the EthSM module shall implement for each configured network. ]()

[SWS\_EthSM\_00198] [

The EthSM shall monitor the requested and current state of the Ethernet Interface Controller. If the EthSM detects a mismatch, it shall bring the hardware back to the corresponding state. (i.e. FullCOM requires the state ETH\_MODE\_ACTIVE; NoCom requires ETH\_MODE\_DOWN) ]()

## 8.6 Expected Interfaces

In this chapter all interfaces required from other modules are listed.

### 8.6.1 Mandatory Interfaces

This chapter defines all interfaces which are required to fulfill the core functionality of the module.

[SWS\_EthSM\_91002] [

<i>API function</i>	<i>Header File</i>	<i>Description</i>
BswM_EthSM_CurrentState	BswM_EthSM.h	Function called by EthSM to indicate its current state.
ComM_BusSM_ModelIndication	ComM.h	Indication of the actual bus mode by the corresponding Bus State Manager. ComM shall propagate the indicated state to the users with means of the RTE and BswM.
Dem_SetEventStatus	Dem.h	Called by SW-Cs or BSW modules to report monitor status information to the Dem. BSW modules calling Dem_SetEventStatus can safely ignore the return value.
Ethlf_SetControllerMode	Ethlf.h	Enables / disables the indexed controller
Tcplp_RequestComMode	Tcplp.h	By this API service the TCP/IP stack is requested to change the Tcplp state of the communication network identified by Ethlf controller index.

] ()

### 8.6.2 Optional Interfaces

This chapter defines all interfaces which are required to fulfill an optional functionality of the module.

[SWS\_EthSM\_91003] [

<i>API function</i>	<i>Header File</i>	<i>Description</i>
Det_ReportError	Det.h	Service to report development errors.
Ethlf_GetControllerMode	Ethlf.h	Obtains the state of the indexed controller

] ()

## 9 Sequence diagrams

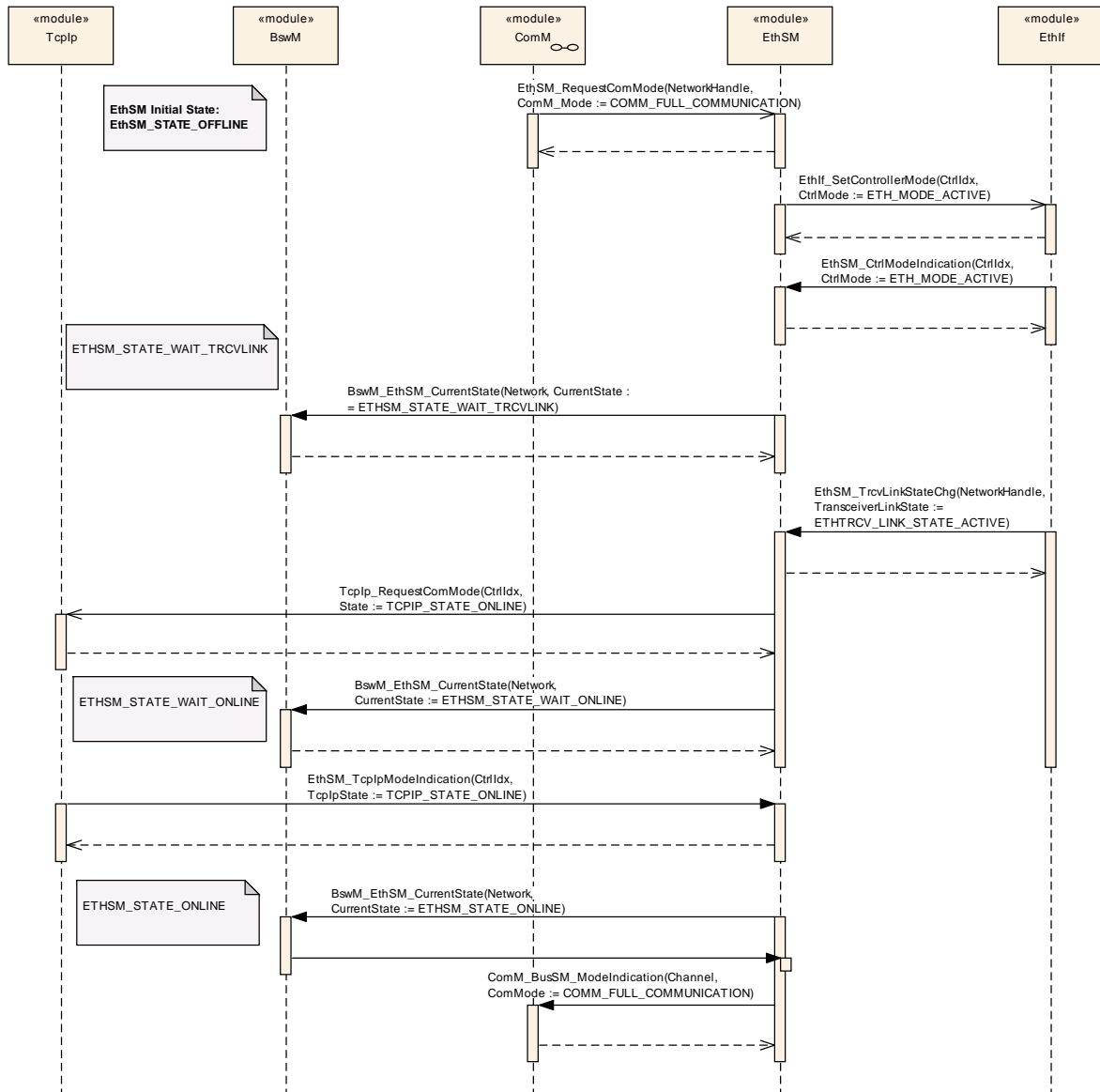
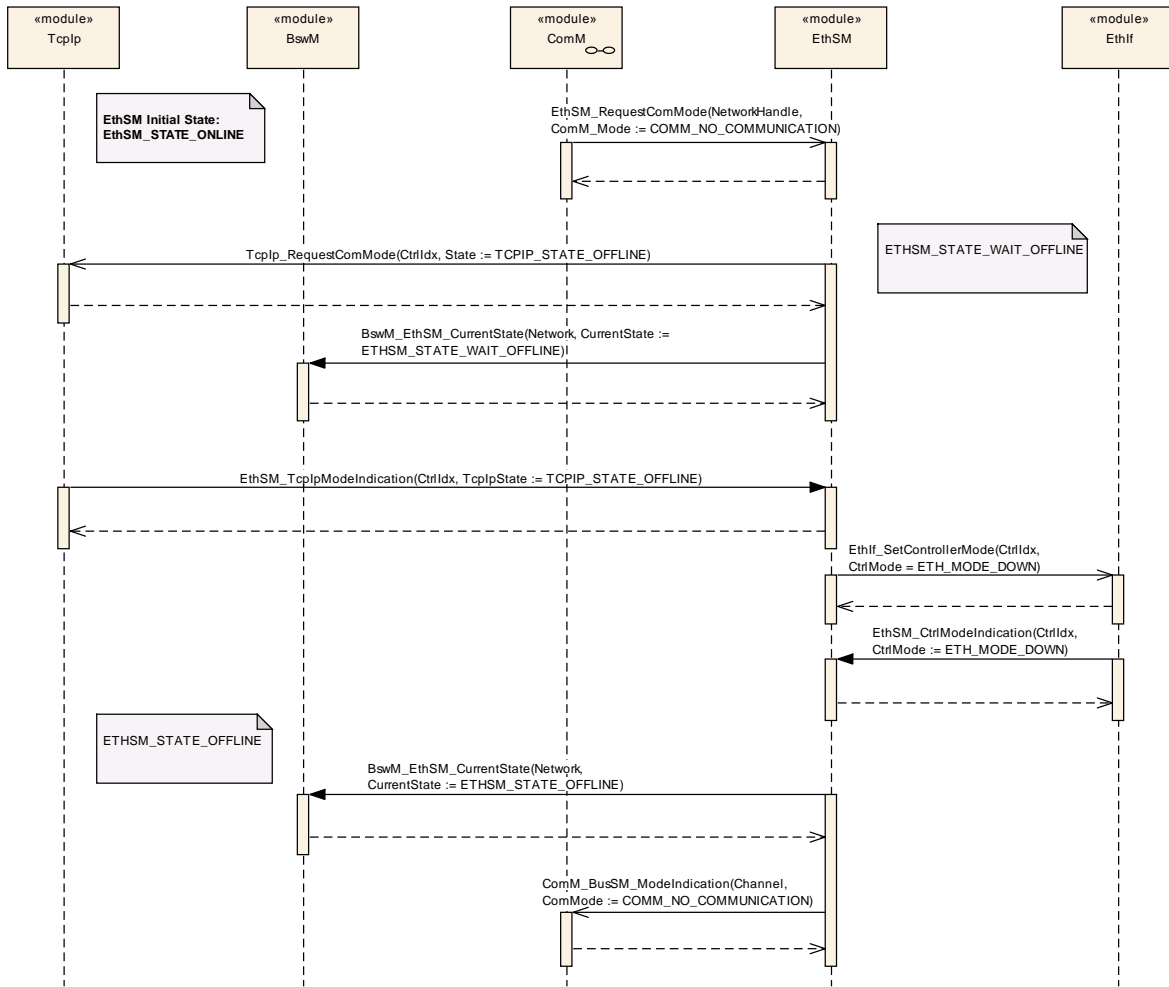
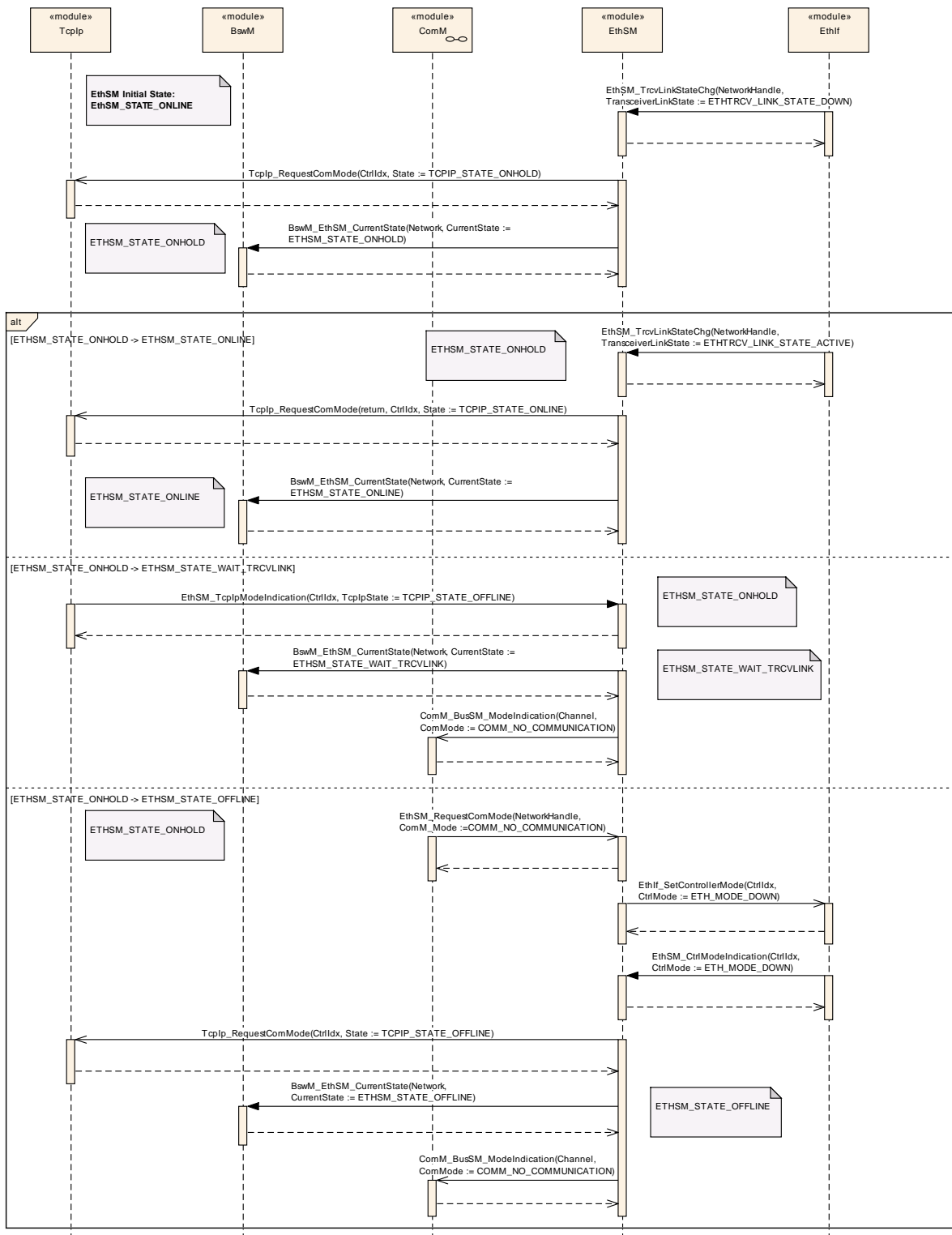

Figure 9-1: Network mode state machine – transition from no to full communication



**Figure 9-2: Network mode state machine – transition from full to no communication**



**Figure 9-3: Network mode state machine – sub state ONHOLD**



## 10 Configuration specification

In general, this chapter defines configuration parameters and their clustering into containers. In order to support the specification Chapter 10.1 describes fundamentals. It also specifies a template (table) you shall use for the parameter specification. We intend to leave Chapter 10.1 in the specification to guarantee comprehension.

Chapter 10.2 specifies the structure (containers) and the parameters of the module EthSM.

Chapter 10.3 specifies published information of the module EthSM.

### 10.1 How to read this chapter

For details refer to the chapter 10.1 “Introduction to configuration specification” in *SWS\_BSWGeneral*.

### 10.2 Containers and configuration parameters

The following chapters summarize all configuration parameters. The detailed meanings of the parameters describe Chapters 7 and Chapter 8.

#### 10.2.1 Configuration Tool

[SWS\_EthSM\_00081]

A configuration tool will create a configuration structure that is understood by the EthSM.] (SRS\_BSW\_00159, SRS\_BSW\_00424, SRS\_BSW\_00425)

#### 10.2.2 EthSM

<b>SWS Item</b>	<b>ECUC_EthSM_00108 :</b>
<b>Module Name</b>	<i>EthSM</i>
<b>Module Description</b>	Configuration of the Ethernet State Manager
<b>Post-Build Variant Support</b>	false
<b>Supported Config Variants</b>	VARIANT-PRE-COMPILE

<b>Included Containers</b>		
<b>Container Name</b>	<b>Multiplicity</b>	<b>Scope / Dependency</b>
EthSMGeneral	1	This container contains the global parameter of the Ethernet State Manager.
EthSMNetwork	1..*	This container contains the Ethernet network-specific parameters of each Ethernet network. It also contains the reference to combination of controller and transceiver assigned to an Ethernet network.

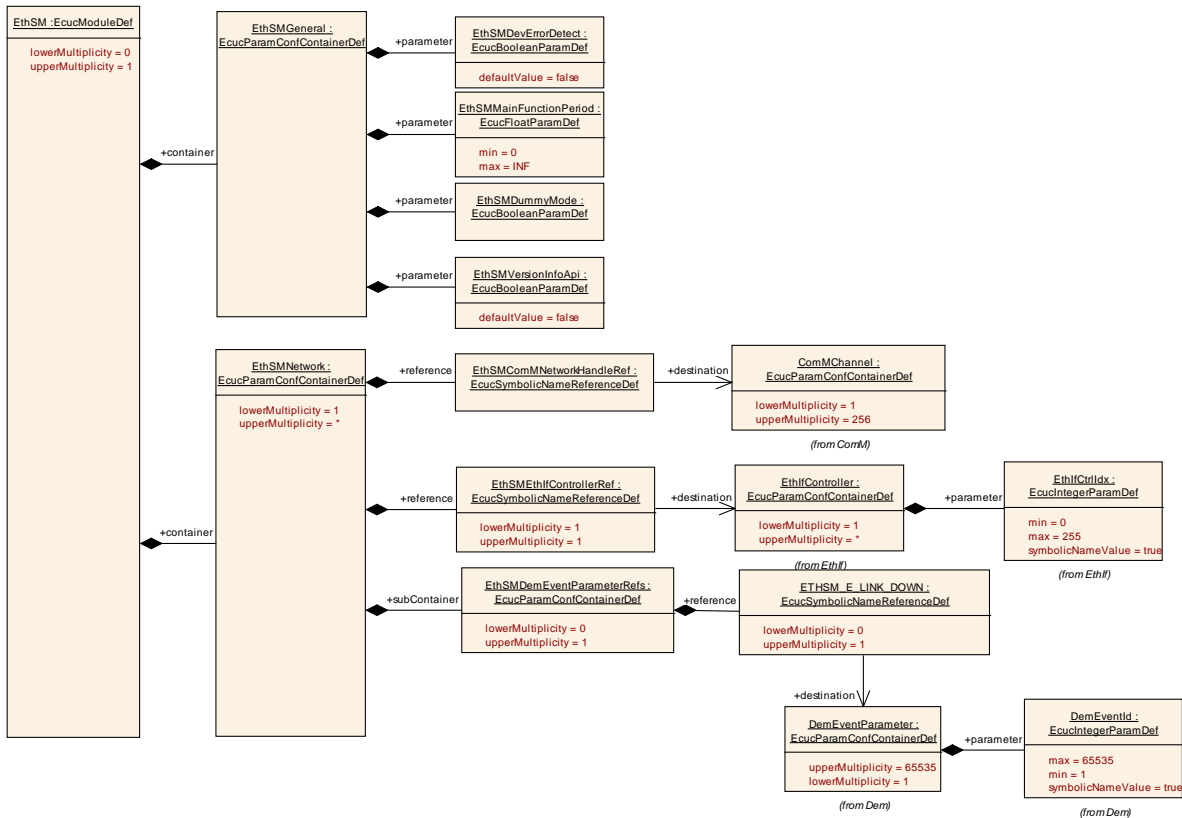

### 10.2.3 EthSMGeneral

<b>SWS Item</b>	<b>ECUC_EthSM_00063 :</b>		
<b>Container Name</b>	EthSMGeneral		
<b>Description</b>	This container contains the global parameter of the Ethernet State Manager.		
<b>Configuration Parameters</b>			

<b>SWS Item</b>	<b>ECUC_EthSM_00065 :</b>		
<b>Name</b>	EthSMDevErrorDetect		
<b>Parent Container</b>	EthSMGeneral		
<b>Description</b>	Switches the development error detection and notification on or off. <ul style="list-style-type: none"> <li>• true: detection and notification is enabled.</li> <li>• false: detection and notification is disabled.</li> </ul>		
<b>Multiplicity</b>	1		
<b>Type</b>	EcucBooleanParamDef		
<b>Default value</b>	false		
<b>Post-Build Variant Value</b>	false		
<b>Value Configuration Class</b>	<b>Pre-compile time</b>	X	All Variants
	<b>Link time</b>	--	
	<b>Post-build time</b>	--	
<b>Scope / Dependency</b>	scope: local		

<b>SWS Item</b>	<b>ECUC_EthSM_00079 :</b>		
<b>Name</b>	EthSMDummyMode		

<b>Parent Container</b>	EthSMGeneral		
<b>Description</b>	Disables the API to the EthIf. The API to the ComM is available but the functionality is deactivated. The function calls from the ComM will be answered with the return value E_OK.		
<b>Multiplicity</b>	1		
<b>Type</b>	EcucBooleanParamDef		
<b>Default value</b>	--		
<b>Post-Build Variant Value</b>	false		
<b>Value Configuration Class</b>	<b>Pre-compile time</b>	X	All Variants
	<b>Link time</b>	--	
	<b>Post-build time</b>	--	
<b>Scope / Dependency</b>	scope: local		

<b>SWS Item</b>	<b>ECUC_EthSM_00066 :</b>		
<b>Name</b>	EthSMMainFunctionPeriod		
<b>Parent Container</b>	EthSMGeneral		
<b>Description</b>	Specifies the period in seconds that the MainFunction has to be triggered with.		
<b>Multiplicity</b>	1		
<b>Type</b>	EcucFloatParamDef		
<b>Range</b>	]0 .. INF[		
<b>Default value</b>	--		
<b>Post-Build Variant Value</b>	false		
<b>Value Configuration Class</b>	<b>Pre-compile time</b>	X	All Variants
	<b>Link time</b>	--	
	<b>Post-build time</b>	--	
<b>Scope / Dependency</b>	scope: local		

<b>SWS Item</b>	<b>ECUC_EthSM_00092 :</b>		
<b>Name</b>	EthSMVersionInfoApi		
<b>Parent Container</b>	EthSMGeneral		
<b>Description</b>	Enables and disables the version info API.		
<b>Multiplicity</b>	1		
<b>Type</b>	EcucBooleanParamDef		
<b>Default value</b>	false		
<b>Post-Build Variant Value</b>	false		
<b>Value Configuration Class</b>	<b>Pre-compile time</b>	X	All Variants
	<b>Link time</b>	--	
	<b>Post-build time</b>	--	
<b>Scope / Dependency</b>	scope: local		

**No Included Containers**

### 10.2.4 EthSMNetwork

<b>SWS Item</b>	<b>ECUC_EthSM_00067 :</b>		
<b>Container Name</b>	EthSMNetwork		
<b>Description</b>	This container contains the Ethernet network-specific parameters of each Ethernet network. It also contains the reference to combination of controller and transceiver assigned to an Ethernet network.		
<b>Configuration Parameters</b>			

<b>SWS Item</b>	<b>ECUC_EthSM_00068 :</b>		
-----------------	---------------------------	--	--

<b>Name</b>	EthSMComMNetworkHandleRef		
<b>Parent Container</b>	EthSMNetwork		
<b>Description</b>	Unique handle to identify one certain Ethernet network. Reference to one of the network handles configured for the ComM.		
<b>Multiplicity</b>	1		
<b>Type</b>	Symbolic name reference to [ ComMChannel ]		
<b>Post-Build Variant Value</b>	false		
<b>Value Configuration Class</b>	<b>Pre-compile time</b>	X	All Variants
	<b>Link time</b>	--	
	<b>Post-build time</b>	--	
<b>Scope / Dependency</b>	scope: local		

<b>SWS Item</b>	<b>ECUC_EthSM_00105 :</b>		
<b>Name</b>	EthSMEthIfControllerRef		
<b>Parent Container</b>	EthSMNetwork		
<b>Description</b>	Reference to EthIfCtrl container where a ETH controller and transceiver (optional) combination is configured.		
<b>Multiplicity</b>	1		
<b>Type</b>	Symbolic name reference to [ EthIfController ]		
<b>Post-Build Variant Value</b>	false		
<b>Value Configuration Class</b>	<b>Pre-compile time</b>	X	All Variants
	<b>Link time</b>	--	
	<b>Post-build time</b>	--	
<b>Scope / Dependency</b>	scope: local		

<b>Included Containers</b>		
<b>Container Name</b>	<b>Multiplicity</b>	<b>Scope / Dependency</b>
EthSMDemEventParameterRefs	0..1	Container for the references to DemEventParameter elements which shall be invoked using the API Dem_SetEventStatus in case the corresponding error occurs. The EventId is taken from the referenced DemEventParameter's DemEventId symbolic value. The standardized errors are provided in this container and can be extended by vendor-specific error references.

### 10.2.5 EthSMDemEventParameterRefs

<b>SWS Item</b>	<b>ECUC_EthSM_00106 :</b>
<b>Container Name</b>	EthSMDemEventParameterRefs
<b>Description</b>	Container for the references to DemEventParameter elements which shall be invoked using the API Dem_SetEventStatus in case the corresponding error occurs. The EventId is taken from the referenced DemEventParameter's DemEventId symbolic value. The standardized errors are provided in this container and can be extended by vendor-specific error references.
<b>Configuration Parameters</b>	

<b>SWS Item</b>	<b>ECUC_EthSM_00107 :</b>
<b>Name</b>	ETHSM_E_LINK_DOWN
<b>Parent Container</b>	EthSMDemEventParameterRefs
<b>Description</b>	Reference to configured DEM event to report bus off errors for this Eth network.
<b>Multiplicity</b>	0..1
<b>Type</b>	Symbolic name reference to [ DemEventParameter ]

<b>Post-Build Multiplicity</b>	<b>Variant</b>	false		
<b>Post-Build Variant Value</b>		false		
<b>Multiplicity Configuration Class</b>	<b>Pre-compile time</b>	X	All Variants	
	<b>Link time</b>	--		
	<b>Post-build time</b>	--		
<b>Value Configuration Class</b>	<b>Pre-compile time</b>	X	All Variants	
	<b>Link time</b>	--		
	<b>Post-build time</b>	--		
<b>Scope / Dependency</b>		scope: local		
<b>No Included Containers</b>				

### 10.3 Published Information

For details refer to the chapter 10.3 “Published Information” in *SWS\_BSWGeneral*.

## 11 Not applicable requirements

**[SWS\_EthSM\_00999]** | These requirements are not applicable to this specification.  
| (SRS\_BSW\_00344, SRS\_BSW\_00404, SRS\_BSW\_00170, SRS\_BSW\_00395,  
SRS\_BSW\_00398, SRS\_BSW\_00399, SRS\_BSW\_00400, SRS\_BSW\_00438,  
SRS\_BSW\_00375, SRS\_BSW\_00416, SRS\_BSW\_00437, SRS\_BSW\_00168,  
SRS\_BSW\_00423, SRS\_BSW\_00426, SRS\_BSW\_00427, SRS\_BSW\_00428,  
SRS\_BSW\_00429, SRS\_BSW\_00432, SRS\_BSW\_00433, SRS\_BSW\_00336,  
SRS\_BSW\_00369, SRS\_BSW\_00417, SRS\_BSW\_00161, SRS\_BSW\_00162,  
SRS\_BSW\_00005, SRS\_BSW\_00164, SRS\_BSW\_00325, SRS\_BSW\_00343,  
SRS\_BSW\_00160, SRS\_BSW\_00413, SRS\_BSW\_00347, SRS\_BSW\_00373,  
SRS\_BSW\_00314, SRS\_BSW\_00353, SRS\_BSW\_00361, SRS\_BSW\_00328,  
SRS\_BSW\_00377, SRS\_BSW\_00306, SRS\_BSW\_00308, SRS\_BSW\_00309,  
SRS\_BSW\_00371, SRS\_BSW\_00359, SRS\_BSW\_00360, SRS\_BSW\_00331,  
SRS\_BSW\_00010, SRS\_BSW\_00333, SRS\_BSW\_00321, SRS\_BSW\_00341,  
SRS\_BSW\_00334)