

Document Title	Log and Trace Protocol Specification
Document Owner	AUTOSAR
Document Responsibility	AUTOSAR
Document Identification No	787

Document Status	Final
Part of AUTOSAR Standard	Foundation
Part of Standard Release	1.4.0

Document Change History			
Date	Release	Changed by	Description
2018-03-29	1.4.0	AUTOSAR Release Management	<ul style="list-style-type: none"> No content changes
2017-12-08	1.3.0	AUTOSAR Release Management	<ul style="list-style-type: none"> No content changes
2017-10-27	1.2.0	AUTOSAR Release Management	<ul style="list-style-type: none"> Enhanced formal quality of requirements and requirements tracing
2017-03-31	1.1.0	AUTOSAR Release Management	<ul style="list-style-type: none"> Added requirement for the header format (Big-endian)
2016-11-30	1.0.0	AUTOSAR Release Management	<ul style="list-style-type: none"> Initial Release

Disclaimer

This work (specification and/or software implementation) and the material contained in it, as released by AUTOSAR, is for the purpose of information only. AUTOSAR and the companies that have contributed to it shall not be liable for any use of the work.

The material contained in this work is protected by copyright and other types of intellectual property rights. The commercial exploitation of the material contained in this work requires a license to such intellectual property rights.

This work may be utilized or reproduced without any modification, in any form or by any means, for informational purposes only. For any other purpose, no part of the work may be utilized or reproduced, in any form or by any means, without permission in writing from the publisher.

The work has been developed for automotive applications only. It has neither been developed, nor tested for non-automotive applications.

The word AUTOSAR and the AUTOSAR logo are registered trademarks.

Table of Contents

1	Introduction and overview	5
1.1	Purpose.....	5
1.2	Applicability of the protocol.....	6
1.2.1	Safety and security considerations	6
1.2.2	Constraints and assumptions	6
1.2.3	Limitations.....	6
1.3	Dependencies to other protocol layers.....	6
1.4	Dependencies to the Application Layer.....	7
2	Use Cases.....	8
2.1.1	Use Case general logging with Dlt	8
2.1.2	Use Case tracing of VFB.....	9
2.1.3	Use Case runtime configuration of Dlt	10
2.1.4	Use Case non-verbose mode	11
3	Requirements traceability	12
4	Acronyms and abbreviations.....	14
4.1	Term and definition	15
5	Protocol specification	16
5.1	Message format	16
5.1.1	Header format.....	16
5.1.2	Body/Payload format.....	23
5.1.3	Data Types	32
5.2	Message types.....	44
5.2.1	Data Messages.....	44
5.2.2	Control Messages.....	44
5.3	Services / Commands.....	44
5.3.1	Set Log Level.....	45
5.3.2	Set Trace Status.....	46
5.3.3	Get Log Info	47
5.3.4	Get Default Log Level.....	49
5.3.5	Store Configuration.....	49
5.3.6	Reset to Factory Default.....	50
5.3.7	SetMessageFiltering.....	50
5.3.8	Set Default LogLevel	50
5.3.9	Set Default Trace Status	51
5.3.10	Get ECU Software Version.....	52
5.3.11	Get Default Trace Status.....	53
5.3.12	Get LogChannel Names.....	53
5.3.13	Get Trace Status	54
5.3.14	Set LogChannel Assignment.....	54
5.3.15	Set LogChannel Threshold.....	55
5.3.16	Get LogChannel Threshold	55
5.3.17	BufferOverflowNotification.....	56
5.3.18	Call SWC Injection.....	57

5.3.19	DLT Commands (deprecated).....	58
5.4	External Client / Tool	59
5.4.1	Extensions for storing in a database/file	59
5.5	Sequences (lower layer)	60
5.5.1	States.....	60
5.5.2	Control flow / Transitions.....	61
5.6	Error Handling.....	64
5.6.1	Error messages	64
5.6.2	Error resolution.....	65
6	Protocol usage and guidelines.....	66
7	Configuration specification.....	67
7.1	Dlt Header	67
7.1.1	Header Type	67
7.2	Dlt Extended Header	67
7.2.1	Message Info	67
7.3	Published Information.....	68

1 Introduction and overview

This protocol specification specifies the format, message sequences and semantics of the AUTOSAR Protocol Dlt.

The protocol allows sending Diagnostic, Log and Trace information onto the communications bus.

Therefore, the Dlt module collects debug information from applications or other software modules, adds metadata to the debug information, and sends it to the communications bus.

In addition, the Dlt Protocol allows filtering debug information depending on the severity level, e.g.: “fatal error” or “information”. This filter can be modified during runtime via Dlt Control Messages sent by an external Logging Tool.

It is also possible to directly inform applications about the new filter level to only generate debug information especially for this selected severity level, assign messages to another communications bus at runtime, or to store the modified Dlt configuration nonvolatile (if supported by hardware).

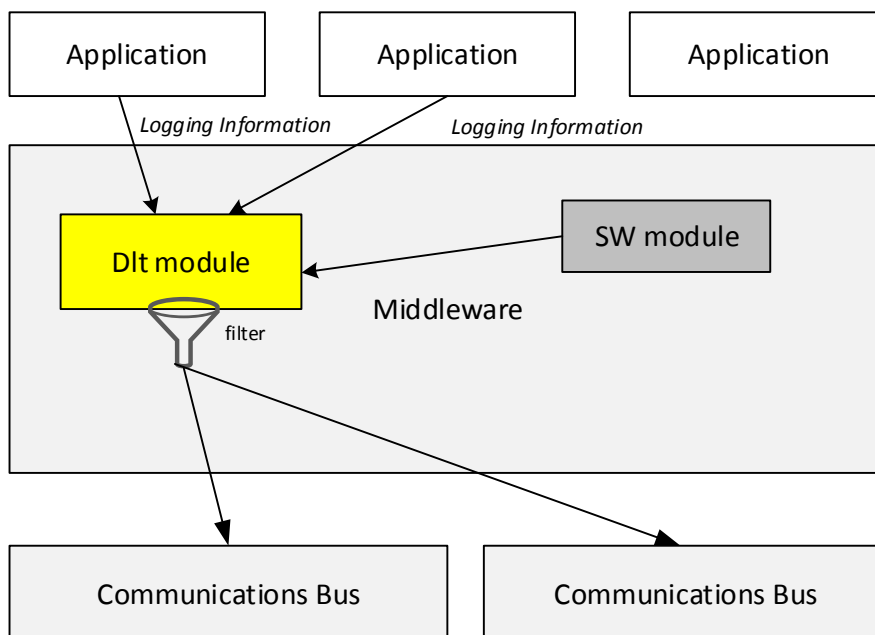

Figure 2 – Location of the Dlt Protocol

1.1 Purpose

The Dlt protocol can be used at the ECU' development phase to log and store debug information externally on a logging device.

1.2 Applicability of the protocol

It is intended to use the Dlt Protocol at the development phase of an ECU. It is assumed to use an external logging- and tracing tool to store the debug information generated by the ECU.

This logging- and tracing tool is also needed to modify the filter setting at runtime if wanted, or to store the current Dlt configuration of the ECU persistently.

1.2.1 Safety and security considerations

It is highly recommended to deactivate the Dlt functionality after the development phase is over. In particular, the Injection-Feature should be deactivated in any case!

The activation and deactivation of the Dlt functionality should be done using a security mechanism.

1.2.2 Constraints and assumptions

The Dlt Protocol is designed to work “connectionless”. This means that no external communication or other stimulation is needed to use the Dlt protocol.

Although there is no need to connect an external Logging tool, it makes sense having one, which stores and interprets the received debug messages. This device can also be used to generate Dlt Control Messages to influence the ECU, like modifying the filter setting (i.e. change the severity level of the debug information).

1.2.3 Limitations

The available (free) bandwidth of the communications bus should be taken into consideration to not influence the regular communication too much.

1.3 Dependencies to other protocol layers

[1] IEC 7498-1 The Basic Model, IEC Norm, 1994

[2] ASAM MCD-2 NET (FIBEX)

1.4 Dependencies to the Application Layer

To transmit Dlt messages, the applications need to know whether to send the Dlt messages using the verbose- or non-verbose mode.

In addition, the applications may offer the possibility to get informed about a filter setting change. For this purpose, the applications should register themselves at the Dlt module.

2 Use Cases

This chapter describes the use cases which can be realized by an environment of an ECU which implements the Dlt Protocol.

Although the Dlt protocol is bus agnostic, it is recommended to use communications busses with higher bandwidth like Ethernet. Nonetheless it is not limited to it.

2.1.1 Use Case general logging with Dlt

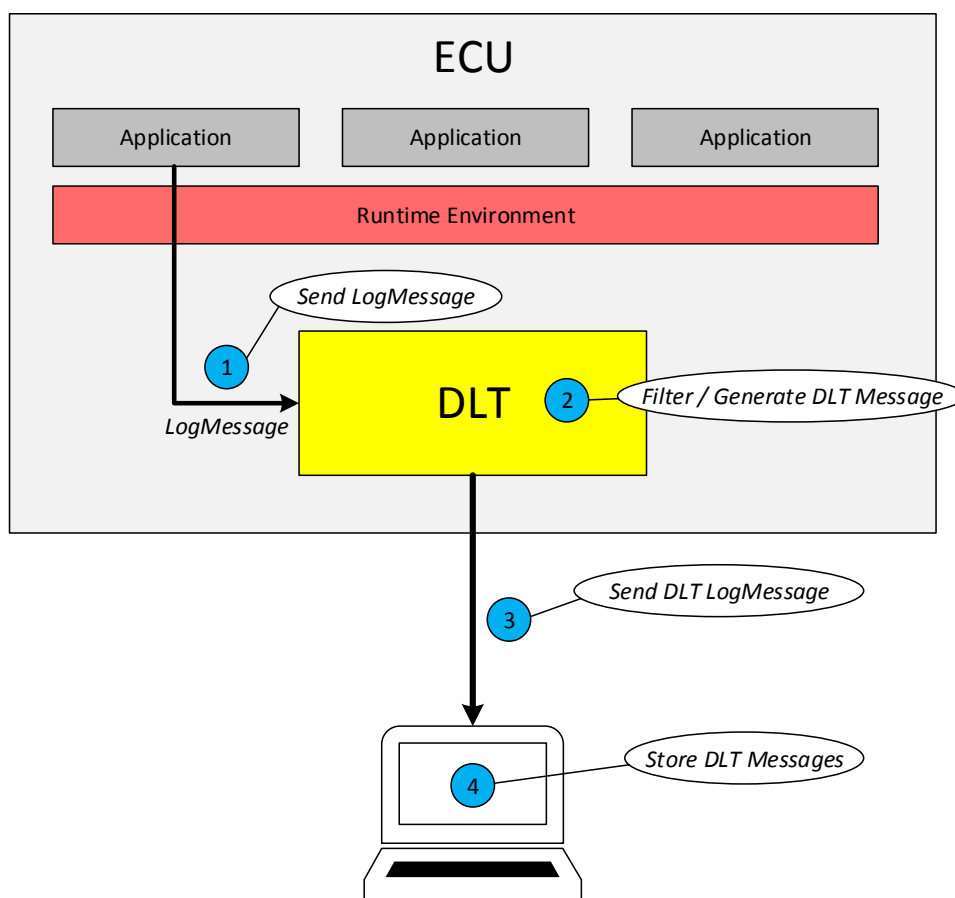

Figure 3: General logging with Dlt

- (1) An application / SW-C is generating a Log Message.
- (2) The Log Message is sent to a Dlt module, which implements the Dlt Protocol
- (3) The Dlt module sends the log message to the communications bus
- (4) An external Dlt client records the log message

2.1.2 Use Case tracing of VFB

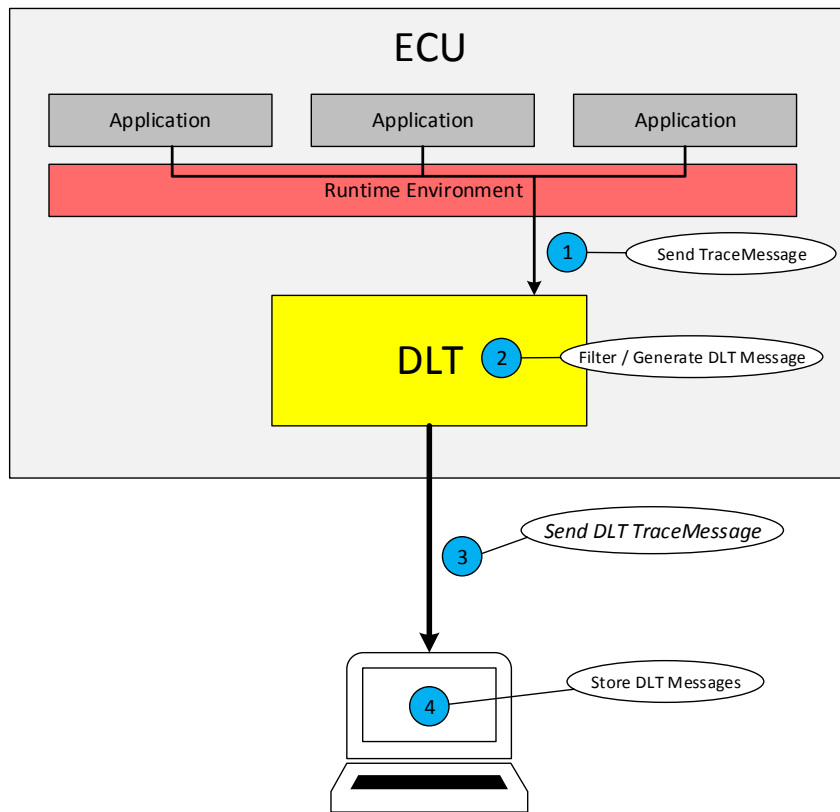

Figure 4: Tracing of VFB

- (1) RTE calls the macro provided by Dlt, which calls the Dlt API generating the trace message.
- (2) The Dlt module which implements the Dlt Protocol sends the trace message to the implemented Dlt communication module interface.
- (3) The Dlt communication module forwards the trace message to the network.
- (4) An external client receives and stores the trace messages.

2.1.3 Use Case runtime configuration of Dlt

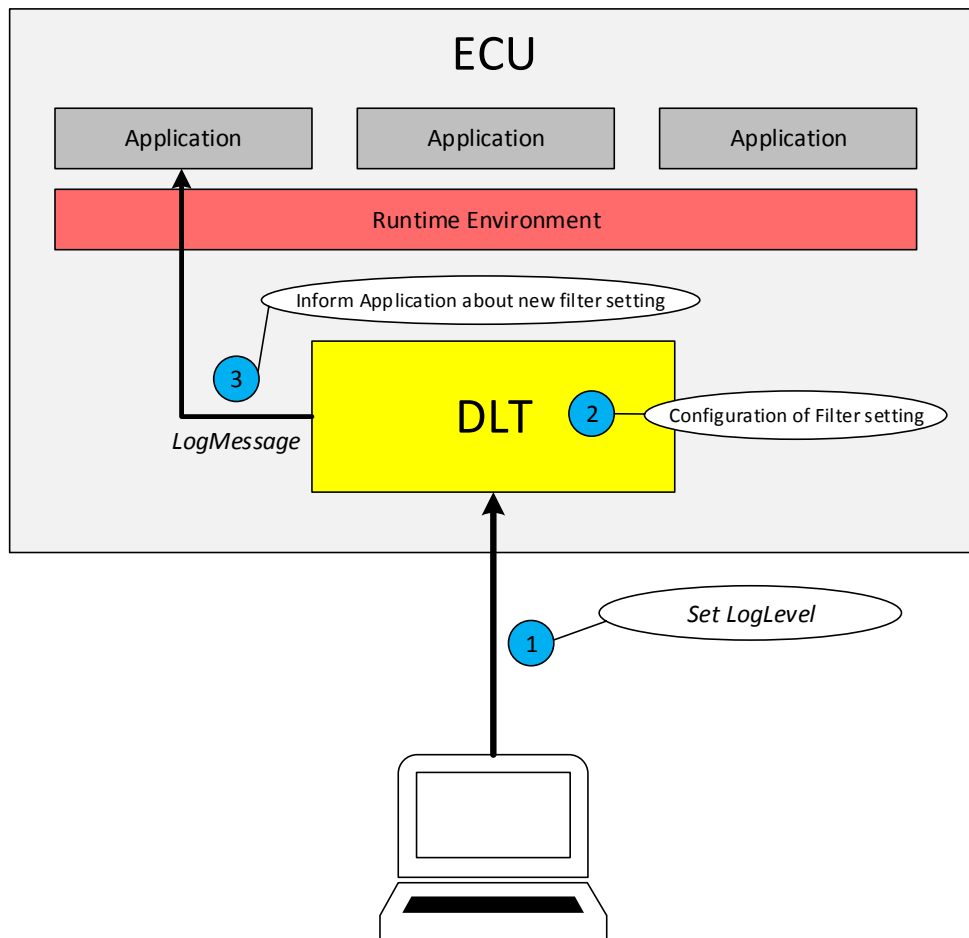

Figure 5: Runtime configuration of Dlt

- (1) An external Dlt client sets the log and trace level and sends the change to the Dlt module, which implements the Dlt Protocol.
- (2) The Dlt module adapts its configuration of filter settings accordingly.
- (3) The Dlt module informs the application about the new log level.

2.1.4 Use Case non-verbose mode

To reduce the amount of traffic on the bus, it can be avoided to send meta data about variables on the communications bus.

Instead, an external FIBEX file holds the information how the payload shall be interpreted. The external Dlt client merges and stores these meta data with the received parameter values.

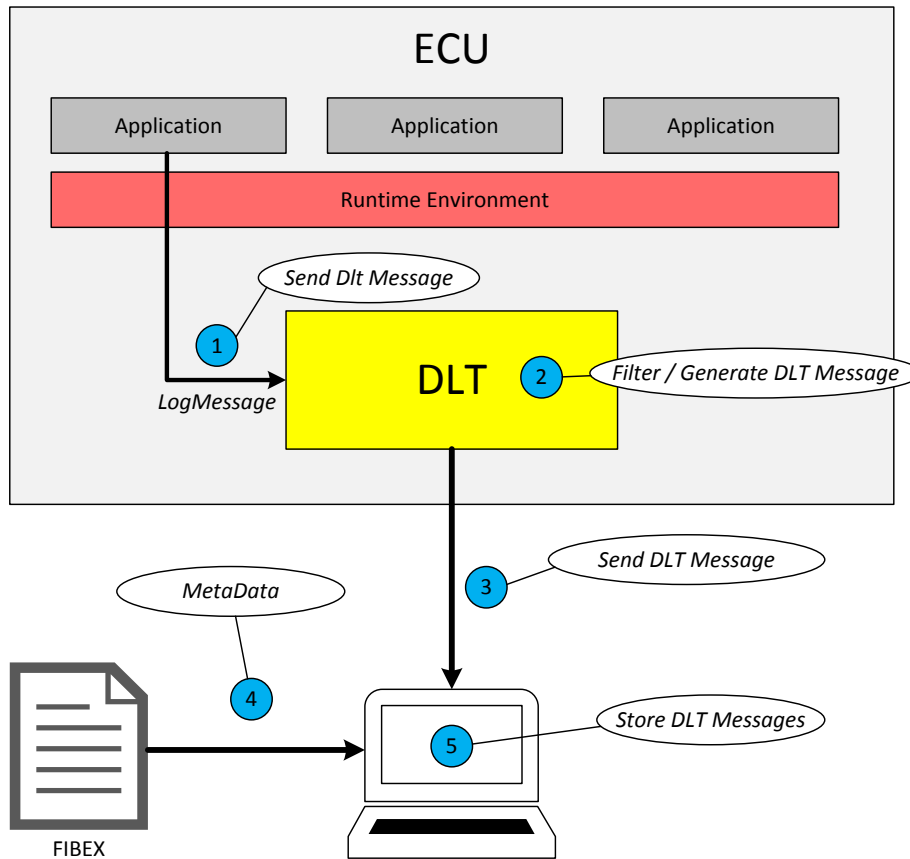

- (1) The Dlt module is called to transmit a Dlt message in non-verbose mode.
- (2) The Dlt module filters and generate the Dlt message
- (3) The Dlt module sends the Dlt message to the communications bus.
- (4) An external Dlt client fetches meta information from an external FIBEX file.
- (5) The merged information is stored by an external Dlt client.

3 Requirements traceability

Requirement	Description	Satisfied by
RS_LT_00002	All log and trace messages sent by an ECU shall have a standardized transmission format and a standardized storage format.	PRS_Dlt_00094, PRS_Dlt_00120, PRS_Dlt_00126, PRS_Dlt_00135, PRS_Dlt_00292, PRS_Dlt_00320, PRS_Dlt_00324, PRS_Dlt_00325, PRS_Dlt_00326, PRS_Dlt_00404, PRS_Dlt_00405, PRS_Dlt_00427, PRS_Dlt_00458, PRS_Dlt_00600, PRS_Dlt_00601, PRS_Dlt_00602, PRS_Dlt_00603, PRS_Dlt_00604, PRS_Dlt_00605, PRS_Dlt_00606, PRS_Dlt_00607, PRS_Dlt_00608, PRS_Dlt_00609, PRS_Dlt_00610, PRS_Dlt_00611, PRS_Dlt_00612, PRS_Dlt_00614, PRS_Dlt_00617, PRS_Dlt_00618, PRS_Dlt_00619, PRS_Dlt_00620, PRS_Dlt_00621, PRS_Dlt_00622, PRS_Dlt_00623, PRS_Dlt_00641
RS_LT_00013	The transmitted data shall be packetized.	PRS_Dlt_00091, PRS_Dlt_00314, PRS_Dlt_00315, PRS_Dlt_00409
RS_LT_00014	The transport format shall be binary.	PRS_Dlt_00378
RS_LT_00016	The format shall deal with Big and Little Endianess.	PRS_Dlt_00091, PRS_Dlt_00604, PRS_Dlt_00605
RS_LT_00017	Each log and trace message shall contain a timestamp, which will be added to the message during reception of the message in the LT module	PRS_Dlt_00112, PRS_Dlt_00309, PRS_Dlt_00323, PRS_Dlt_00628
RS_LT_00018	A global message counter shall be implemented, to detect messages loss.	PRS_Dlt_00105, PRS_Dlt_00106, PRS_Dlt_00319, PRS_Dlt_00613
RS_LT_00020	The log and trace message shall contain a parameter, which represents the source of the log and trace message	PRS_Dlt_00322, PRS_Dlt_00616
RS_LT_00021	There shall be a logical grouping for log messages by using different identifiers.	PRS_Dlt_00127, PRS_Dlt_00128, PRS_Dlt_00312, PRS_Dlt_00313
RS_LT_00022	Each ECU shall have its unique ECU ID	PRS_Dlt_00308, PRS_Dlt_00321, PRS_Dlt_00606, PRS_Dlt_00607, PRS_Dlt_00615
RS_LT_00023	The payload shall transport the parameters of a log and trace message.	PRS_Dlt_00134, PRS_Dlt_00314, PRS_Dlt_00315, PRS_Dlt_00353, PRS_Dlt_00378, PRS_Dlt_00409, PRS_Dlt_00459, PRS_Dlt_00623
RS_LT_00024	It shall be possible to transmit the parameters in a raw format.	PRS_Dlt_00126, PRS_Dlt_00310, PRS_Dlt_00402, PRS_Dlt_00418
RS_LT_00025	It shall be possible to transmit ASCII text in log or trace messages.	PRS_Dlt_00155, PRS_Dlt_00156, PRS_Dlt_00157, PRS_Dlt_00182, PRS_Dlt_00183, PRS_Dlt_00366, PRS_Dlt_00367, PRS_Dlt_00373, PRS_Dlt_00392, PRS_Dlt_00400, PRS_Dlt_00410, PRS_Dlt_00411, PRS_Dlt_00420, PRS_Dlt_00627

RS_LT_00026	The data in non-verbose mode shall be described by an extra file	PRS_Dlt_00134, PRS_Dlt_00353, PRS_Dlt_00396, PRS_Dlt_00397, PRS_Dlt_00398, PRS_Dlt_00399, PRS_Dlt_00401, PRS_Dlt_00402, PRS_Dlt_00403, PRS_Dlt_00418, PRS_Dlt_00424, PRS_Dlt_00425
RS_LT_00027	Each message in non-verbose mode shall have a unique Message ID significant for identifying the source of the tracing.	PRS_Dlt_00352, PRS_Dlt_00397, PRS_Dlt_00398, PRS_Dlt_00624
RS_LT_00032	A protocol shall be implemented to be able to set and query the trace status and log levels of log and trace sources of each ECU.	PRS_Dlt_00194, PRS_Dlt_00195, PRS_Dlt_00196, PRS_Dlt_00197, PRS_Dlt_00198, PRS_Dlt_00199, PRS_Dlt_00200, PRS_Dlt_00380, PRS_Dlt_00381, PRS_Dlt_00383, PRS_Dlt_00393, PRS_Dlt_00494, PRS_Dlt_00502, PRS_Dlt_00635, PRS_Dlt_00637, PRS_Dlt_00638, PRS_Dlt_00639, PRS_Dlt_00640
RS_LT_00033	A list of all log and trace sources of an ECU shall be accessible from the external client.	PRS_Dlt_00197
RS_LT_00037	There shall be a buffer to store log and trace message locally.	PRS_Dlt_00769
RS_LT_00039	The LT shall provide the possibility to store configuration data in a persistent way.	PRS_Dlt_00199
RS_LT_00040	the LT component shall be able to filter log and trace messages	PRS_Dlt_00205
RS_LT_00044	Provide raw buffer content.	PRS_Dlt_00119, PRS_Dlt_00135, PRS_Dlt_00139, PRS_Dlt_00145, PRS_Dlt_00147, PRS_Dlt_00148, PRS_Dlt_00149, PRS_Dlt_00150, PRS_Dlt_00152, PRS_Dlt_00153, PRS_Dlt_00160, PRS_Dlt_00161, PRS_Dlt_00169, PRS_Dlt_00170, PRS_Dlt_00171, PRS_Dlt_00172, PRS_Dlt_00173, PRS_Dlt_00175, PRS_Dlt_00176, PRS_Dlt_00177, PRS_Dlt_00182, PRS_Dlt_00183, PRS_Dlt_00354, PRS_Dlt_00355, PRS_Dlt_00356, PRS_Dlt_00357, PRS_Dlt_00358, PRS_Dlt_00362, PRS_Dlt_00363, PRS_Dlt_00364, PRS_Dlt_00366, PRS_Dlt_00367, PRS_Dlt_00369, PRS_Dlt_00370, PRS_Dlt_00371, PRS_Dlt_00372, PRS_Dlt_00374, PRS_Dlt_00375, PRS_Dlt_00385, PRS_Dlt_00386, PRS_Dlt_00387, PRS_Dlt_00388, PRS_Dlt_00389, PRS_Dlt_00390, PRS_Dlt_00411, PRS_Dlt_00412, PRS_Dlt_00414, PRS_Dlt_00422, PRS_Dlt_00423, PRS_Dlt_00459, PRS_Dlt_00625, PRS_Dlt_00626, PRS_Dlt_00627

4 Acronyms and abbreviations

Abbreviation / Acronym	Description
APID	Application ID
CTID	Context ID
Dlt	Diagnostic Log and Trace
FIBEX	Field Bus Exchange Format
MCNT	Message Counter
MSBF	Most Significant Byte First
MSBI	Message Bus Info
MSCI	Message Control Info
MSLI	Message Log Info
MSTP	Message Type
MSTI	Message Trace Info
NOAR	Number of Arguments
STMS	Timestamp
UEH	Use Extended Header
VERB	Verbose
VERS	Version Number
WEID	With ECU ID
WSID	With Session ID
WTMS	With Timestamp

4.1 Term and definition

Term	Description:
Log and trace message	A log and trace message contains all data and options to describe a log and trace event in a software. The log and trace message consists of a header and payload.
Dlt User	A Dlt User represents the source of a generated Dlt message. Possible users are Applications, RTE or other software modules
Log Message	A Log Message contains debug information like state changes or value changes.
Trace Message	A Trace messages contains information, which has passed via the VFB.
ECU ID	The ECU ID is the name of an ECU, composed by four 8-bit ASCII characters (e.g. ABS0 or COMB).
FIBEX	The Field Bus Exchange Format is a versatile XML bases description format.
Session	A session is the logical entity of the source of log or trace messages. If a SW-C / application is instantiated several times, a session for each instance with a globally unique session ID is used.
Session ID	The Session ID is the identification number of a log or trace session
Application ID	Application ID is an abbreviation of a SW-C / application. It identifies the SW-C / application the log and trace message originates.
Context ID	<p>Context ID is a user defined ID to group Log and Trace Messages generated by a SW-C / application. The following rules apply:</p> <ul style="list-style-type: none"> • Each Application ID can own several Context IDs. • Context IDs are grouped by Application IDs. • Context IDs shall be unique within an Application ID. • The source of a log and trace message is identified using the tuple "Application ID" and "Context ID". <p>Four 8-bit ASCII characters compose the Context ID.</p>
Message ID	Message ID is the ID to characterize the information, which is transported by the message itself. A Message ID identifies a log or trace message uniquely. It can be used for identifying the source (in source code) of a message and it can be used for characterizing the payload of a message. A Message ID is statically fixed at development or configuration time.
Log level	A log level defines a classification for the severity grade of a Log Message.
Trace status	The trace status provides information if a trace message should be send.
Log Channel	A physical Communications Bus which is used to transmit Dlt messages.
External client	The external client is a tool to control, monitor and store the log/trace information provided by the ECUs using the Dlt module.

5 Protocol specification

5.1 Message format

For both, debug data and control information, the same Dlt message format is used. It consists of a Standard Header, an optional Extended Header, and a Payload segment.



Figure 6 - Dlt message format

5.1.1 Header format

[PRS_Dlt_00091] [The Standard Header and the Extended Header shall be in big endian format (MSB first).] (RS_LT_00016,RS_LT_00013)

5.1.1.1 Standard Header

	Header Type	Message Counter	Length	ECU ID (optional)	Session ID (optional)	Timestamp (optional)
Short Name	HTYP	MCNT	LEN	ECU	SEID	TMSP
Byte	0	1	2 3	4 5 6 7	8 9 10 11	12 13 14 15

Figure 7 - Dlt Standard Header

[PRS_Dlt_00458] [The Dlt Standard Header shall consist of the following fields in the following order:

- Byte 0: HTYP (Header Type)
- Byte 1: MCNT (Message Counter)
- Byte 2-3: LEN (Length)
- Byte 4-7: ECU (ECU ID)
- Byte 8-11: SEID (Session ID)
- Byte 12-15: TMSP (Timestamp)

] (RS_LT_00002)

5.1.1.1.1 Header Type

The Dlt Header Type (HTYP) contains general information about the Dlt message.

[PRS_Dlt_00094] [The Header Type (HTYP) shall contain the following information and be encoded the following way:

- Bit 0: UEH (Use Extended Header)
- Bit 1: MSBF (Most Significant Byte First)
- Bit 2: WEID (With ECU ID)
- Bit 3: WSID (With Session ID)
- Bit 4: WTMS (With Timestamp)
- Bit 5-7: VERS (Version Number)

] (RS_LT_00002)

Header Type (HTYP)								
Name	UEH	MSBF	WEID	WSID	WTMS	VERS		
Bit	0	1	2	3	4	5	6	7
Byte	0							

Figure 8 - Encoding of Header Type

[PRS_Dlt_00600] [The Header Type (HTYP) shall be the first byte of any Dlt message.] (RS_LT_00002)

[PRS_Dlt_00601] [The size of the Header Type (HTYP) shall be 1 byte.] (RS_LT_00002)

[PRS_Dlt_00602] [If the UEH bit is set to '0', the extended header is not used.] (RS_LT_00002)

[PRS_Dlt_00603] [If the UEH bit is set to '1', the extended header is used.] (RS_LT_00002)

Note:

If the verbose mode is needed, the UEH bit has to be set to 1.

[PRS_Dlt_00604] [If the MSBF bit is set to '0', the payload data is encoded in little endian format.] (RS_LT_00002, RS_LT_00016)

[PRS_Dlt_00605] [If the MSBF bit is set to '1', the payload data is encoded in big endian format.] (RS_LT_00002, RS_LT_00016)

[PRS_Dlt_00606] [If the WEID bit is set to '0', the ECU ID (WEID) field is not contained in the Standard Header.] (RS_LT_00002, RS_LT_00022)

[PRS_DIt_00607] [If the WEID bit is set to '1', the ECU ID (WEID) field is contained in the Standard Header.] (RS_LT_00002, RS_LT_00022)

[PRS_DIt_00608] [If the WSID bit is set to '0', the Session ID (WSID) field is not contained in the Standard Header.] (RS_LT_00002)

[PRS_DIt_00609] [If the WSID bit is set to '1', the Session ID (WSID) field is contained in the Standard Header.] (RS_LT_00002)

[PRS_DIt_00610] [If the WTMS bit is set to '0', the Timestamp (WTMS) field is not contained in the Standard Header.] (RS_LT_00002)

[PRS_DIt_00611] [If the WTMS bit is set to '1', the Timestamp (WTMS) field is contained in the Standard Header.] (RS_LT_00002)

[PRS_DIt_00612] [The VERS bits shall contain the Version number of the DIt Data protocol in the Standard Header.] (RS_LT_00002)

Note:

Please be aware that the byte position of the defined fields within the DIt Standard Header may shift due to the activation/deactivation of the optional fields (see above).

5.1.1.1.2 Message Counter

The Message Counter counts DIt messages received by the DIt module. With the Message Counter, lost messages can be recognized to a certain level.

[PRS_DIt_00319] [The Message Counter is an unsigned 8-bit (0-255) integer.] (RS_LT_00018)

[PRS_DIt_00613] [After initialization of the DIt module, the Message Counter (MCNT) shall be set to '0'.](RS_LT_00018)

[PRS_DIt_00105] [The DIt module shall increment the Message Counter by one at every Log and Trace message received via the DIt API.] (RS_LT_00018)

[PRS_DIt_00106] [If the Message Counter reaches 255, the counter shall wrap around and start with the value '0' at the next Log and Trace message to be transmitted.] (RS_LT_00018)

5.1.1.1.3 Length

[PRS_DIt_00320] [The Length field LEN of the DIt Standard Header shall be a 16-bit unsigned integer.] (RS_LT_00002)

[PRS_DIt_00614] [The Length Field LEN of the DIt Standard Header shall be set to the overall length of the DIt message, which is the sum of the length of the Standard

Header itself, the length of the optional Dlt Extended Header, and the length of the optional Payload.] (RS_LT_00002)

5.1.1.1.4 The optional ECU ID

The optional ECU ID is used to identify which ECU has sent a Dlt message. Therefore, it is highly recommended that the ECU ID is unique within the vehicle.

[PRS_Dlt_00321] [The ECU ID shall be a 32-bit field interpreted as four 8-bit ASCII characters.] (RS_LT_00022)

[PRS_Dlt_00308] [If the ECU ID is shorter than four 8-bit ASCII characters, the remaining characters shall be filled with 0x00.] (RS_LT_00022)

[PRS_Dlt_00615] [The ECU ID field shall only exist if the WEID bit of the Header Type is set to '1'.] (RS_LT_00022)

5.1.1.1.5 Session ID

The optional Session ID is used to identify the source of a log or trace message within an ECU.

[PRS_Dlt_00322] [The Session ID field shall be a 32-bit unsigned integer.] (RS_LT_00020)

[PRS_Dlt_00616] [The Session ID field shall only exist if the WSID bit of the Header Type is set to '1'.] (RS_LT_00020)

5.1.1.1.6 Timestamp

The optional Timestamp is used to add timing information a Dlt message has been generated.

[PRS_Dlt_00323] [The Timestamp field (TMSP) shall be a 32-bit unsigned integer.] (RS_LT_00017)

[PRS_Dlt_00112] [The Timestamp field (TMSP) shall hold the timestamp from the moment an application sends the message to the Dlt module.] (RS_LT_00017)

[PRS_Dlt_00309] [The time resolution is in 0.1 milliseconds.] (RS_LT_00017)

[PRS_Dlt_00628] [The timer shall start with '00000000' when the ECU which generates the LogMessage starts up.] (RS_LT_00017)

5.1.1.2 Extended Header

In case the UEH bit of the Standard Header is set to '1', additional information is transmitted which are defined in the Dlt Extended Header format.

The Dlt Extended Header is directly attached after the Dlt Standard Header fields.

	Message Info	Number of Arguments	Application ID				Context ID			
Name	MSIN	NOAR	APID				CTID			
Byte	0	1	2	3	4	5	6	7	8	9

Figure 9 - Extended Header

[PRS_Dlt_00617] | The Dlt Extended Header format shall consist of the following fields in the following order:

- Byte 0: MSIN (Message Info)
- Byte 1: NOAR (Number of Arguments)
- Byte 2-5: APID (Application ID)
- Byte 6-9: CTID (Context ID)

| (RS_LT_00002)

5.1.1.2.1 Message Info

[PRS_Dlt_00618] | The Message Info field (MSIN) shall contain the following information in the following order:

- Bit 0: VERB (Verbose)
- Bit 1-3: MSTP (Message Type)
- Bit 4-7: MTIN (Message Type Info)

| (RS_LT_00002)

	Message Info (MSIN)							
Name	VERB	MSTP			MTIN			
Bit offset	0	1	2	3	4	5	6	7
Byte	0							

Figure 10 - Encoding of the Message Info field

[PRS_Dlt_00119] | If the VERB bit is set to '1', the payload shall be transmitted in verbose mode. | (RS_LT_00044)

[PRS_Dlt_00310] [If the VERB bit is set to '0', the payload shall be transmitted in non-verbose mode.] (RS_LT_00024)

[PRS_Dlt_00324] [The Message Type (MSTP) shall be a 3-bit unsigned integer.] (RS_LT_00002)

[PRS_Dlt_00120] [The Message Type (MSTP) shall have one of the following values:

- 0x0: Dlt_TYPE_LOG (Dlt Log Message)
- 0x1: Dlt_TYPE_APP_TRACE (Dlt Trace Message)
- 0x2: Dlt_TYPE_NW_TRACE (Dlt Network Message)
- 0x3: Dlt_TYPE_CONTROL (Dlt Control Message)
- 0x4 – 0x15: *Reserved*

] (RS_LT_00002)

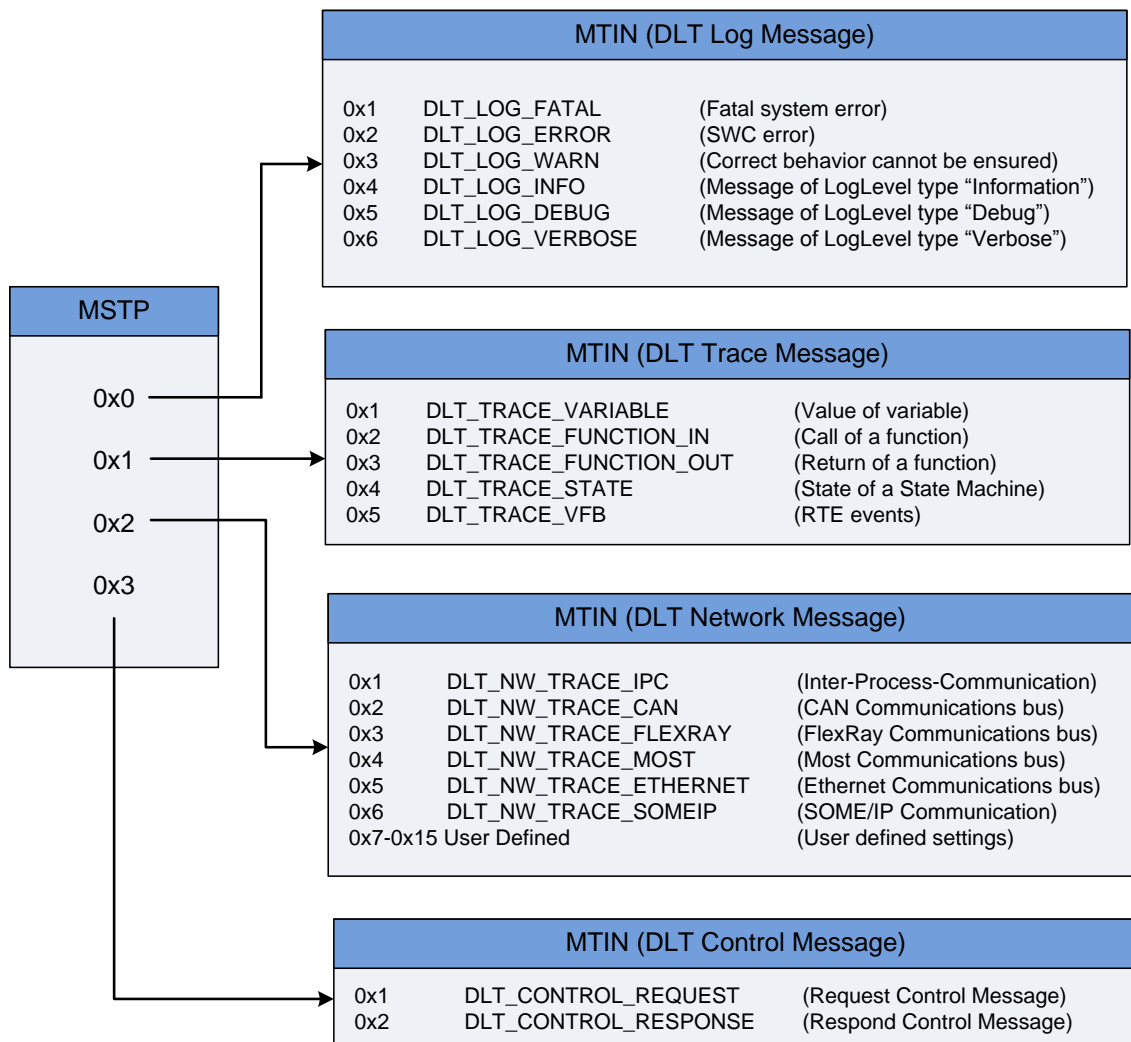

Figure 11 - Dependency between the MSTP field and the MTIN field

[PRS_Dlt_00325] [The Message Type Info field (MTIN) shall be a 4-bit unsigned integer.] (RS_LT_00002)

[PRS_DIt_00619] [If the MSTP field is set to 0x0 (i.e. DIt Log Message), the Message Type Info field (MTIN) shall have one of the following values with the following meaning:

- 0x1: DIt_LOG_FATAL (Fatal system error)
- 0x2: DIt_LOG_DLT_ERROR (Application error)
- 0x3: DIt_LOG_WARN (Correct behavior cannot be ensured)
- 0x4: DIt_LOGINFO (Message of LogLevel type “Information”)
- 0x5: DIt_LOG_DEBUG (Message of LogLevel type “Debug”)
- 0x6: DIt_LOG_VERBOSE (Message of LogLevel type “Verbose”)
- 0x7 – 0x15: *Reserved*] (RS_LT_00002)

[PRS_DIt_00620] [If the MSTP field is set to 0x1 (i.e. DIt Trace Message), the Message Type Info field (MTIN) shall have one of the following values with the following meaning:

- 0x1: DIt_TRACE_VARIABLE (Value of variable)
- 0x2: DIt_TRACE_FUNCTION_IN (Call of a function)
- 0x3: DIt_TRACE_FUNCTION_OUT (Return of a function)
- 0x4: DIt_TRACE_STATE (State of a State Machine)
- 0x5: DIt_TRACE_VFB (RTE events)
- 0x6 – 0x15: *Reserved*] (RS_LT_00002)

[PRS_DIt_00621] [If the MSTP field is set to 0x2 (i.e. DIt Network Message), the Message Type Info field (MTIN) shall have one of the following values with the following meaning:

- 0x1: DIt_NW_TRACE_IPC (Inter-Process-Communication)
- 0x2: DIt_NW_TRACE_CAN (CAN Communications bus)
- 0x3: DIt_NW_TRACE_FLEXRAY (FlexRay Communications bus)
- 0x4: DIt_NW_TRACE_MOST (Most Communications bus)
- 0x5: DIt_NW_TRACE_ETHERNET (Ethernet Communications bus)
- 0x6: DIt_NW_TRACE_SOMEIP (Inter-SOME/IP Communication)
- 0x7-0x15: *User Defined* (User defined settings)]
(RS_LT_00002)

[PRS_DIt_00622] [The If the MSTP field is set to 0x3 (i.e. DIt Control Message), the Message Type Info field (MTIN) shall have one of the following values with the following meaning:

- 0x1: DIt_CONTROL_REQUEST (Request Control Message)
- 0x2: DIt_CONTROL_RESPONSE (Respond Control Message)
- 0x3-0x15: *Reserved*] (RS_LT_00002)

5.1.1.2.2 Number of Arguments

Number of Arguments represents the number of consecutive parameters in the payload segment of one Dlt message.

[PRS_Dlt_00326] | The Number of Arguments field (NOAR) shall be an 8-bit unsigned integer. | (RS_LT_00002)

[PRS_Dlt_00126] | If the VERB bit is set to '1' (i.e. Verbose Mode is used), the Number of Arguments field (NOAR) shall contain the number of provided arguments within the payload. | (RS_LT_00002, RS_LT_00024)

[PRS_Dlt_00623] | If the VERB bit is set to '0' (i.e. Verbose Mode is not used), the Number of Arguments field (NOAR) shall be set to 0x00. | (RS_LT_00002, RS_LT_00023)

5.1.1.2.3 Application ID

The Application ID is an abbreviation of the application, which generates the Dlt message.

[PRS_Dlt_00127] | The Application ID field (APID) shall be a 32-bit field interpreted as four 8-bit ASCII characters. | (RS_LT_00021)

[PRS_Dlt_00312] | If the Application ID is shorter than four 8-bit ASCII characters, the remaining characters shall be filled with 0x00. | (RS_LT_00021)

5.1.1.2.4 Context ID

The Context ID is a user defined ID to (logically) group Dlt messages generated by an application.

[PRS_Dlt_00128] | The Context ID field (CTID) shall be a 32-bit field interpreted as four 8-bit ASCII characters. | (RS_LT_00021)

[PRS_Dlt_00313] | If the Context ID is shorter than four 8-bit ASCII characters, the remaining characters shall be filled with 0x00. | (RS_LT_00021)

5.1.2 Body/Payload format

The Dlt Payload follows the Dlt Header or the Dlt Extended Header if used. The Dlt Payload contains the parameters that are logged or traced, or it contains control information.

[PRS_Dlt_00314] | If the UEH (Use Extended Header) bit is set to '1', the payload shall adjoin the Dlt Extended Header. | (RS_LT_00013, RS_LT_00023)

[PRS_DIt_00315] [If the UEH (Use Extended Header) bit is set to '0', the payload shall adjoin the DIt Standard Header.] (RS_LT_00013, RS_LT_00023)

5.1.2.1 Non-Verbose Mode

To be able to transmit parameter values only - without the need of any meta information about them -, additional properties like parameter names or types -, the Non-Verbose Mode can be used.

To allow the correct disassembly of the contained parameter values within a received DIt message, a dedicated Message ID is added to the payload.

A separate, external file contains the description of the payload layout according to the corresponding Message ID.

Standard Header	Payload	
	Message ID	Non-Static Data

Figure 12 – Non-Verbose Mode message

[PRS_DIt_00624] [The Message ID shall be a 32-bit unsigned integer.] (RS_LT_00027)

[PRS_DIt_00352] [The Message ID shall be assigned unique for a single combination of static data.] (RS_LT_00027)

[PRS_DIt_00353] [With the combination of a Message ID and an external description, following information shall be recoverable: the Type Info:

- Type Length
- Data Type
- String Coding
- Variable Info
- Fixed Point

] (RS_LT_00023, RS_LT_00026)

Note: If verbose mode is used instead (see chapter 7.2.5), these parameters are contained directly within the DIt message payload.

[PRS_DIt_00134] [With the combination of a Message ID and an external description, following information shall be recoverable that is otherwise provided in the Extended Header:

- Message Type (MSTP)
- Message Info (MSIN)
- Number of arguments (NOAR)
- Application ID (APID)
- Context ID (CTID)

] (RS_LT_00023, RS_LT_00026)

5.1.2.1.1 Assembly of Non-Static Data

This example will demonstrate how the non-static data is assembled, transmitted and interpreted.

Following information will be transmitted to an external client by the sending of a log message:

- static text: "Temperature measurement"
- 8-bit unsigned integer: measurement_point = 1 (no unit)
- 32-bit float: reading = 22.1 Kelvin

There is a unique Message ID that characterize this log message call on this specific position in the source code. Following information is associated with this Message ID:

- position in source code: source file "temp_meas.c", line number 42
- static text: "Temperature measurement"
- expecting the value of a 8-bit unsigned integer with variable name = "measurement_point" and unit = ""
- expecting the value of a 32-bit float with variable name = "reading" and unit = "Kelvin"

All static data is already associated with the Message ID and only the non-static data will be transmitted:

Length in Bit	Value	Description
8	1	8-bit unsigned integer
32	22.1	32-bit float

Table 1 - Assembly of non-static data in Non-Verbose Mode

Based on the Message ID, the receiver can reassemble all static data of this DIt message (position in source code, static text, variable names and units). The non-static data will be transmitted consistently packed. The interpretation is possible by using the information associated with the Message ID. Also the ordering of the arguments is associated with the Message ID.

[PRS_DIt_00378] [The non-static data shall be transmitted consistently packed and byte aligned.] (RS_LT_00014, RS_LT_00023)

5.1.2.1.2 Description Format for transmitted Data

An external file holds the information how the payload shall be interpreted. For describing transmitted messages which are in non-verbose mode the ASAM Fibex (Field Bus Exchange Format) shall be used.

The software supplier of an application or of the middleware shall provide this description file. Because Dlt can have several sources of log or trace messages (several applications or diagnostic modules) the provided description files can be merged to one file for a given ECU.

Each Fibex description file for describing Non Verbose messages only corresponds to log or trace messages for one ECU. This is because Message IDs are only unique per ECU. Additionally the Software Version Number of the ECU has to be provide by the description file.

[PRS_Dlt_00402] [Each description file shall contain only one ECU XML-element.] (RS_LT_00024, RS_LT_00026)

[PRS_Dlt_00403] [The ECU XML-element shall be extended by a SW_VERSION XML-element.

In principle each log or trace message is comparable to a PDU known in some network protocols. Here the description of a log or trace message shall be equivalent to a CAN-Frame specified by Fibex. The information from the Extended Header is put in additionally XML-elements inside the FRAME-TYPE XML-element. The Non-Static Data is described by PDU and SIGNAL XML-elements.

As seen from the user, a log or trace message has several arguments. These arguments can be static text or non static variables. Only the non static variables data is transmitted. To reassemble the whole message with all arguments, a FRAME XML-element shall contain some empty PDU XML-elements which represents arguments with static text. This text shall be placed in the DESC XML-element of the PDU XML-element.] (RS_LT_00026)

[PRS_Dlt_00418] [The ASAM Fibex Standard (Field Bus Exchange Format) Version 3.0 shall be used for describing a Non Verbose message.] (RS_LT_00024, RS_LT_00026)

[PRS_Dlt_00396] [One log or trace message shall be represented by one FRAME XML-element in Fibex.] (RS_LT_00026)

[PRS_Dlt_00397] [The Message ID shall be the ID attribute of the <FRAME> XML-element.] (RS_LT_00026, RS_LT_00027)

[PRS_Dlt_00398] [The <FRAME-TYPE> XML-element shall be extended by the following XML-elements:

- Message Type (MSTP) – MESSAGE_TYPE
- Message Info (MSIN) – MESSAGE_INFO
- Application ID (APID) – APPLICATIONID
- Context ID (CTID) – CONTEXTID
- Source file – MESSAGE_SOURCE_FILE
- line number – MESSAGE_LINE_NUMBER] (RS_LT_00026, RS_LT_00027)

[PRS_Dlt_00399] [The user data of the log or trace message shall be represented by several PDU XML-elements. Each argument shall get one PDU XML-element.] (RS_LT_00026)

[PRS_Dlt_00400] [If the argument contains only static text, this text shall be placed in the DESC XML-element of the PDU. In this case the BYTE-LENGTH of the PDU XML-element shall be zero.] (RS_LT_00025)

[PRS_Dlt_00401] [If the argument contains “Non-Static Data” the data transported in the message is described within the PDU as SIGNAL XML-element.] (RS_LT_00026)

The following example shows the description of a sample Dlt message in FIBEX XML.

```
<fx:FRAME ID="ID 1">
  <ho:SHORT-NAME>Dlt Message with ID 1</ho:SHORT-NAME>
  <fx:BYTE-LENGTH>1</fx:BYTE-LENGTH>
  <fx:FRAME-TYPE>OTHER</fx:FRAME-TYPE>
  <fx:PDU-INSTANCES>
    <fx:PDU-INSTANCE ID="P 1 0">
      <fx:PDU-REF ID-REF="PDU 1 0"/>
      <fx:SEQUENCE-NUMBER>0</fx:SEQUENCE-NUMBER>
    </fx:PDU-INSTANCE>
    <fx:PDU-INSTANCE ID="P 1 1">
      <fx:PDU-REF ID-REF="PDU 1 1"/>
      <fx:SEQUENCE-NUMBER>1</fx:SEQUENCE-NUMBER>
    </fx:PDU-INSTANCE>
    <fx:PDU-INSTANCE ID="P 1 2">
      <fx:PDU-REF ID-REF="PDU 1 2"/>
      <fx:SEQUENCE-NUMBER>2</fx:SEQUENCE-NUMBER>
    </fx:PDU-INSTANCE>
  </fx:PDU-INSTANCES>
  <fx:MANUFACTURER-EXTENSION>
    <MESSAGE TYPE>DLT TYPE LOG</MESSAGE TYPE>
    <MESSAGE INFO>DLT LOG DEBUG</MESSAGE INFO>
    <APPLICATIONID>APPI</APPLICATIONID>
    <CONTEXTID>CONI</CONTEXTID>
    <MESSAGE SOURCE FILE>demo.c</MESSAGE SOURCE FILE>
    <MESSAGE LINE NUMBER>72</MESSAGE LINE NUMBER>
  </fx:MANUFACTURER-EXTENSION>
</fx:FRAME>
<!--===== 1. Parameter =====>
```

```

<fx:PDU ID="PDU 1 0">
  <ho:SHORT-NAME></ho:SHORT-NAME>
  <ho:DESC>Temperature measurement</ho:DESC>
  <fx:BYTE-LENGTH>0</fx:BYTE-LENGTH>
  <fx:PDU-TYPE>OTHER</fx:PDU-TYPE>
</fx:PDU>
<!--===== 2. Parameter =====>
<fx:PDU ID="PDU 1 1">
  <ho:SHORT-NAME>measurement point</ho:SHORT-NAME>
  <fx:BYTE-LENGTH>1</fx:BYTE-LENGTH>
  <fx:PDU-TYPE>OTHER</fx:PDU-TYPE>
  <fx:SIGNAL-INSTANCES>
    <fx:SIGNAL-INSTANCE ID="S 1 0">
      <fx:SEQUENCE-NUMBER>0</fx:SEQUENCE-NUMBER>
      <fx:SIGNAL-REF ID-REF="S UINT8"/>
    </fx:SIGNAL-INSTANCE>
  </fx:SIGNAL-INSTANCES>
</fx:PDU>
<!--===== 3. Parameter =====>
<fx:PDU ID="PDU 1 2">
  <ho:SHORT-NAME>reading</ho:SHORT-NAME>
  <fx:BYTE-LENGTH>1</fx:BYTE-LENGTH>
  <fx:PDU-TYPE>OTHER</fx:PDU-TYPE>
  <fx:SIGNAL-INSTANCES>
    <fx:SIGNAL-INSTANCE ID="S 1 0">
      <fx:SEQUENCE-NUMBER>0</fx:SEQUENCE-NUMBER>
      <fx:SIGNAL-REF ID-REF="FLOA32"/>
    </fx:SIGNAL-INSTANCE>
  </fx:SIGNAL-INSTANCES>
</fx:PDU>
    
```

5.1.2.2 Verbose Mode

Dlt messages which are sent in Verbose Mode contain a complete description of the parameters next to the parameter values itself.

This means that on the one hand no external file is needed for disassembly; On the other hand, a higher amount of data is sent on the bus.

The Verbose Mode can be used on ECUs where enough memory and high network bandwidth are available. Because of the self-description, the stored data on the external client is interpretable at any time and without any further external information.

5.1.2.2.1 Dlt Message Format in General

In Verbose Mode, any desired number of arguments can be transmitted. The information about the payload is provided within the message itself. The payload adjoins the Extended Header and consists of one or more arguments. The number of arguments in the payload is specified in the Extended Header within the Number of arguments field (NOAR).

Each argument consists of a “Type Info” field and the appended Data Payload. In “Type Info” field the necessary information is provided to interpret the following data structure.

[PRS_Dlt_00459] [The Dlt message in Verbose Mode shall consist of

- Standard Header
- Extended Header
- n Arguments, each consisting of a tuple of Type Info and Data Payload

] (RS_LT_00023, RS_LT_00044)

Standard Header	Extended Header	Payload			
		Argument 1		Argument n	
		Type Info	Data Payload	Type Info	Data Payload

Figure 13 – Verbose Mode message

[PRS_Dlt_00409] [The arguments and all inherited data shall be transmitted consistently packed.] (RS_LT_00023, RS_LT_00013)

5.1.2.2.2 Data Payload

The Data Payload contains the value of the variable (i.e. the debug information of an application or middleware), which is going to be transmitted on the communications bus. In addition to the variable value itself, it is needed to provide information like size and type of the variable. This information is contained in the Type Info field

5.1.2.2.3 Type Info

The Type Info Filed contains meta data about the Data Payload

[PRS_DIt_00135] [The Type Info is a 32 bit field and has to be part of the Payload segment if a DIt log or trace message shall be sent in Verbose Mode]
(RS_LT_00002, RS_LT_00044)

[PRS_DIt_00625] [The Type Info is a 32 bit field shall be encoded the following way:

- **Bit 0 - 3** **Type Length (TYLE)**
- Bit 4 Type Bool (BOOL)
- Bit 5 Type Signed (SINT)
- Bit 6 Type Unsigned (UINT)
- Bit 7 Type Float (FLOA)
- Bit 8 Type Array (ARAY)
- Bit 9 Type String (STRG)
- Bit 10 Type Raw (RAWD)
- Bit 11 Variable Info (VARI)
- Bit 12 Fixed Point (FIXP)
- Bit 13 Trace Info (TRAI)
- Bit 14 Type Struct (STRU)
- **Bit 15 – 17** **String Coding (SCOD)**
- *Bit 18 – 31* *reserved for future use*

] (RS_LT_00044)

Type Info (4 bytes)														
Name	Type Length (TYLE)	Type Bool (Bool)	Type Signed (SINT)	Type Unsigned (UINT)	Type Float (FLOA)	Type Array (ARAY)	Type String (STRG)	Type Raw (RAWD)	Variable Info (VARI)	Fixed Point (FIXP)	Trace Info (TRAI)	Type Struct (STRU)	String Coding (SCOD)	reserved
Bit	0-3	4	5	6	7	8	9	10	11	12	13	14	15-17	18-31

Figure 14– Encoding of the Type Info bit field

[PRS_Dit_00626] [The bits 0-3 (i.e. Type Length) of the Type Info field define the length of the adjoined Data Payload. The Type Length (TYLE) bit-field is encoded the following way:

- 0x00: not defined
- 0x01: 8 bit
- 0x02: 16 bit
- 0x03: 32 bit
- 0x04: 64 bit
- 0x05: 128 bit
- 0x06 – 0x07: reserved

](RS_LT_00044)

[PRS_Dit_00627] [The bits 15-17 (i.e. String Coding) of the Type Info field define the String type. It is encoded the following way:

- 0x00: ASCII
- 0x01: UTF-8
- 0x02-0x07: reserved

](RS_LT_00044, RS_LT_00025)

The table below shows a simplified assembly of Type Info

Offset to start pos in byte	Field Name	Bit position							
		0	1	2	3	4	5	6	7
0	Type Info	TYLE	TYLE	TYLE	TYLE	BOOL	SINT	UINT	FLOA
1	Type Info	ARAY	STRG	RAWD	VARI	FIXP	TRAI	STRU	SCOD
2	Type Info	SCOD	SCOD	-	-	-	-	-	-
3	Type Info	-	-	-	-	-	-	-	-

Table 5-1 Simplified Assembly of Type Info

The entries of Type Info are specified in the following section in detail.

Details regarding the Data Types of the Type Info field are described in the following chapter.

5.1.3 Data Types

5.1.3.1 Bits Type Length (TYLE)

Type Length specifies the length of the standard data type.

[PRS_DIt_00354] [Type Length is a bit field of 4 bit.

Type Info contains

- 1 (8 bit) for bool data (BOOL)
- 1 (8 bit) or 2 (16 bit) or 3 (32 bit) or 4 (64 bit) or 5 (128 bit) for signed (SINT) and unsigned integer data (UINT)
- 2 (16 bit) or 3 (32 bit) or 4 (64 bit) or 5 (128 bit) for float data (FLOA)] (RS_LT_00044)

5.1.3.2 Bit Variable Info (VARI)

If Variable Info (VARI) is set, the name and the unit of a variable can be added. Both always contain a length information field and a field with the text (of name or unit). The length field contains the number of characters of the associated name or unit filed. The unit information is to add only in some data types.

[PRS_DIt_00410] [The coding of all text in Variable Info (VARI) shall be in 8-bit ASCII format.] (RS_LT_00025)

[PRS_DIt_00411] [The strings in VARI shall be null terminated.] (RS_LT_00044, RS_LT_00025)

5.1.3.3 Bit Fixed Point (FIXP)

If fixed point values are used, the Fixed Point (FIXP) bit shall be set. Than the Data field represents the physical value of a fixed point variable.

For interpreting the fixed point variable the logical value of this variable has to be calculated.

The logical value is calculated by the physical value, the quantization and the offset of fixed point variable.

[PRS_DIt_00389] [The following equation defines the relation between the logical value (log_v) and the physical value (phy_v), offset and quantization:

$log_v = phy_v * quantization + offset$] (RS_LT_00044)

[PRS_DIt_00169] [The bit Fixed Point (FIXP) shall only be set in combination with Type Signed (SINT) or Type Unsigned (UINT).] (RS_LT_00044)

5.1.3.4 Bits String Coding (SCOD)

String Coding specifies only the coding of string data of Type String (STRG). All other strings like parameter name, unit and description are coded in 8-bit ASCII format.

[PRS_DIt_00182] [String Coding is a bit field of 3 bit.] (RS_LT_00044, RS_LT_00025)

[PRS_DIt_00366] [Following values shall be used for String Coding (SCOD):
0x00 = ASCII
0x01 = UTF-8
0x02 - 0x07 reserved for future use] (RS_LT_00044, RS_LT_00025)

[PRS_DIt_00183] [String Coding shall be set if Type String (STRG) is set.] (RS_LT_00044, RS_LT_00025)

[PRS_DIt_00367] [String Coding shall be set if Trace Info (TRAI) is set.] (RS_LT_00044, RS_LT_00025)

5.1.3.5 Type Bool (BOOL)

[PRS_DIt_00422] [If the BOOL bit is set, the Data Payload shall consist of at least one 8-bit unsigned integer parameter.] (RS_LT_00044)

[PRS_DIt_00423] [If the Data field equals 0x0, it shall be interpreted as FALSE. If the Data field equals 0x1 it shall be interpreted as TRUE.] (RS_LT_00044)

[PRS_DIt_00139] [Type Length (TYLE) shall be 1.] (RS_LT_00044)

[PRS_DIt_00355] [If Variable Info (VARI) is set, the Length of Name, the Name and the Unit fields shall be added.] (RS_LT_00044)

[PRS_Dit_00369] [The Data Payload of Type Bool (BOOL) shall be assembled as shown in following table.

Length in bit	Name	Description
If Variable Info (VARI) is set in Type Info		
16	Length of Name + termination char.	Unsigned 16-bit integer
x	Name	Null terminated string (name of variable)
8	Data	0x0 if value is FALSE or 0x1 if value is TRUE

Table 5-2 Data Payload of Type Bool (BOOL)

] (RS_LT_00044)

5.1.3.6 Type Signed (SINT) and Type Unsigned (UINT)

The SINT and UINT Data Payload are assembled in the same way. The only difference is in interpreting the Data field.

[PRS_Dit_00385] [If the SINT bit is set, the Data Payload consists of at least one signed integer Data field.] (RS_LT_00044)

[PRS_Dit_00386] [If the UINT bit is set, the Data Payload consists of at least one unsigned integer Data field.

Variable Info (VARI) and Fixed Point (FIXP) are optional.

Length in bit	Name	Description
If Variable Info (VARI) is set in Type Info		
16	Length of Name + termination char.	Unsigned 16-bit integer
16	Length of Unit + termination char.	Unsigned 16-bit integer
x	Name	Null terminated string (name of variable)
x	Unit	Null terminated string (unit of variable)
If Fixed Point (FIXP) is set in Type Info		
32	Quantization	32-bit float
32 / 64 / 128	Offset	Signed integer - with the length of at least 32 bit. The length shall be: 32 bit if Type Length (TYLE) equals 1,2 or 3 64 bit if Type Length (TYLE) equals 4 or 128 bit if Type Length (TYLE) equals 5

Length in bit	Name	Description
8/16/32 / 64 / 128	Data	Length depends on TYLE

Table 5-3 Data Payload of Type Signed (SINT) and Type Unsigned (UINT)

] (RS_LT_00044)

[PRS_DIt_00356] [Type Length (TYLE) shall be set to 1, 2, 3, 4 or 5.]
 (RS_LT_00044)

[PRS_DIt_00357] [If Variable Info (VARI) is set, the "Length of Name", "Length of Unit", the "Name" and the "Unit" fields shall be added.] (RS_LT_00044)

[PRS_DIt_00412] [If FIXP is set, the Quantization and Offset fields shall be added.]
 (RS_LT_00044)

[PRS_DIt_00388] [The Quantization field shall be a 32-bit float field.]
 (RS_LT_00044)

[PRS_DIt_00387] [The Offset field is a signed integer field with at least 32 bit. If the TYLE equals 4 the Offset field shall be a 64 signed integer field and if the TYLE equals 5 the Offset field shall be a 128 signed integer field.] (RS_LT_00044)

[PRS_DIt_00358] [The length of Data shall depend on Type Length (TYLE).]
 (RS_LT_00044)

[PRS_DIt_00370] [The Data Payload of Type Signed (SIGN) and of Type Unsigned (UINT) shall be assembled as shown in Table 5-3.] (RS_LT_00044)

5.1.3.7 Type Float (FLOA)

[PRS_DIt_00390] [If the bit Type Float (FLOA) is set, the Data Payload shall consist of at least one Data field, which shall be interpreted as a float variable.

Variable Info (VARI) is optional.

Length in bit	Name	Description
<i>If Variable Info (VARI) is set in Type Info</i>		
16	Length of name + termination char.	Unsigned 16-bit integer

Length in bit		Name	Description
	16	Length of unit + termination char.	Unsigned 16-bit integer
	x	Name	Null terminated string (name of variable)
	x	Unit	Null terminated string (unit of variable)
8/16/32 / 64 / 128		Data	Float data length depends on TYLE

Table 5-4 Data Payload of Type Float (FLOA)

] (RS_LT_00044)

[PRS_Dit_00145] [Type Length (TYLE) shall be set to 2, 3, 4 or 5 as specified in IEEE 754r:

Type Length (TYLE)	Type	Length	Mantissa	Exponent
2	b16 bit	16 bit	10 bit	5
3	b32 bit (single)	32 bit	23 bit	8
4	b64 bit (double)	64 bit	52 bit	11
5	b128	128 bit	112 bit	15

Table 5-5 Definition of Type Length according to IEEE 754r

] (RS_LT_00044)

[PRS_Dit_00362] [If Variable Info (VARI) is set, the “Length of Name”, “Length of Unit”, the “Name” and the “Unit” fields shall be added.] (RS_LT_00044)

[PRS_Dit_00363] [The length of Data shall depend on Type Length (TYLE).] (RS_LT_00044)

[PRS_Dit_00371] [The argument of Type Float (FLOA) shall be assembled as shown in Table 5-4.] (RS_LT_00044)

5.1.3.8 Type String (STRG)

[PRS_Dit_00420] [If the bit Type String (STRG) is set, the Data Payload shall consist of at least one Data field, which shall be interpreted as a string variable.] (RS_LT_00025)

[PRS_Dit_00155] [String Coding (SCOD) shall be specified.] (RS_LT_00025)

[PRS_DIt_00392] [The string in the Data field shall be interpreted with the type corresponding to the String Coding (SCOD) field in the Type Info field.] (RS_LT_00025)

[PRS_DIt_00156] [At the beginning of the Data Payload, a 16-bit unsigned integer specifies the length of the string (provide in the Data field) in byte including the termination character.] (RS_LT_00025)

[PRS_DIt_00157] [If Variable Info (VARI) is set, the “Length of Name” and the “Name” fields shall be added.] (RS_LT_00025)

[PRS_DIt_00373] [The Data Payload of Type String (STRG) shall be assembled as shown in following table.

Length in bit	Name	Description
16	Length of string + termination char.	Unsigned 16-bit integer
If Variable Info (VARI) is set in Type Info		
16	Length of name + termination char.	Unsigned 16-bit integer
x	Name	Null terminated string (name of variable)
x	Data string	Null terminated data string

Table 5-6 Data Payload of Type String (STRG)

] (RS_LT_00025)

5.1.3.9 Type Array (ARAY)

[PRS_DIt_00147] [If the bit Type Array is set, the Data Payload shall consist of an n-dimensional array of one or more data types of bool (BOOL), signed integer (SINT), unsigned integer (UINT) or float (FLOA) data types. The TYLE field and FIXP field shall be interpreted as in the standard data types.] (RS_LT_00044)

[PRS_DIt_00148] [At the beginning of the Data Payload a 16-bit unsigned integer shall specify the number of dimensions of the array.] (RS_LT_00044)

[PRS_DIt_00149] [If Variable Info (VARI) is set, the name of the array shall be described.] (RS_LT_00044)

[PRS_DIt_00150] [Within the loop over the number of dimensions, a 16-bit unsigned integer shall specify the number of entries in the current dimension.] (RS_LT_00044)

[PRS_DIt_00152] [If Variable Info (VARI) is set, the "Length of Name", "Length of Unit", the "Name" and the "Unit" fields shall be added.] (RS_LT_00044)

[PRS_DIt_00153] [If Fixed Point (FIXP) bit is set in the Type Info, the quantization and offset for the entry in the array shall be added.

It is only possible to use the same fixed point calculation for all entries in the array.] (RS_LT_00044)

[PRS_DIt_00372] [The Data Payload of Type Array (ARAY) shall be assembled as shown in following table.

Length in bit	Name	Description
16	Number of dimensions	Unsigned 16-bit integer
Loop over number of dimensions		
16	Number of entries in current dimension	Unsigned 16-bit integer
Loop End		
If Variable Info (VARI) is set in Type Info of current dimension		
16	Length of Name + termination char.	Unsigned 16-bit integer
16	Length of Unit + termination char.	Unsigned 16-bit integer
x	Name	Null terminated string (name of current dimension)
x	Unit	Null terminated string (unit of current dimension)
If Fixed Point (FIXP) is set in Type Info of current dimension		
32	Quantization	32-bit float
32 / 64 / 128	Offset	Signed integer of 32 bit if Type Length (TYLE) <= 3 or 64 bit if Type Length (TYLE) = 4 or 128 bit if Type Length (TYLE) = 5
x	Data of whole array The data shall be in the same structure/ordering as it is defined in the C90 standard.	

Table 5-7 Data Payload of Type Array (ARAY)

] (RS_LT_00044)

5.1.3.10 Type Struct (STRU)

If this bit is set, structured data are transmitted.

[PRS_DIt_00175] [At the beginning of the Data Payload a 16-bit unsigned integer shall specify the number of entries of the structure or the object.] (RS_LT_00044)

[PRS_DIt_00176] [If Variable Info (VARI) is set, the “Length of Name” and the “Name” fields shall be added.] (RS_LT_00044)

[PRS_DIt_00177] [The list of entries contains one or more standard arguments with Type Info and Data Payload. All standard argument types are allowed.] (RS_LT_00044)

[PRS_DIt_00414] [The Data Payload of Type Struct (STRU) shall be assembled as shown in following table.

Length (bit)	Name	Description
16	Number of entries in the struct / object	Unsigned 16-bit integer
<i>If Variable Info (VARI) is set in Type Info</i>		
16	Length of name + termination char.	Unsigned 16-bit integer
x	Name	Null terminated string (name of variable)
List of entries (each entry consists of a standard argument type described above)		
Entry 1		
4	Type Info	Essential information for interpreting the Data Payload
x	Data Payload	Data and optional additional parameters like variable info
Entry n		
4	Type Info	Essential information for interpreting the Data Payload
x	Data Payload	Data and optional additional parameters like variable info
End of list of entries		

Table 5-8 Data Payload of Type Struct (STRU)

] (RS_LT_00044)

5.1.3.11 Type Raw (RAWD)

If this bit is set, the Data Payload describes raw data. Variable Info (VARI) is optional.

[PRS_DIt_00364] [If Variable Info (VARI) is set, the coding of the name shall be in 8-bit ASCII format.] (RS_LT_00044)

[PRS_DIt_00160] [At the beginning of the Data Payload a 16-bit unsigned integer shall specify the length of the raw data in byte.] (RS_LT_00044)

[PRS_DIt_00161] [If Variable Info (VARI) is set, the “Length of Name” and the “Name” fields shall be added.

The interpretation of the Data field in the case of a Raw argument cannot be done. Some tools can show this data by a user defined data type.] (RS_LT_00044)

[PRS_DIt_00374] [The Data Payload of Type Raw (RAWD) shall be assembled as shown in following table.

Length in bit	Name	Description
16	Length of raw data in byte	Unsigned 16-bit integer
<i>If Variable Info (VARI) is set in Type Info</i>		
	16	Length of Name + termination char.
	x	Name
		Unsigned 16-bit integer
		Null terminated string (description of variable)
x	Data	Raw data

Table 5-9 Data Payload of Type Raw (RAWD)

] (RS_LT_00044)

5.1.3.12 Type Trace Info (TRAI)

Trace info is a separate argument in the Dlt message.

[PRS_Dlt_00170] [If the bit Trace Info (TRAI) is set, the trace information (like module name / function) shall be transmitted in the argument.] (RS_LT_00044)

[PRS_Dlt_00172] [At the beginning of the Data Payload, a 16-bit unsigned integer shall specify the length of the trace data string in byte including the termination character.] (RS_LT_00044)

[PRS_Dlt_00173] [Null terminated trace data string shall follow.] (RS_LT_00044)

[PRS_Dlt_00171] [String Coding (SCOD) shall specify the coding of the trace data string.] (RS_LT_00044)

[PRS_Dlt_00375] [The Data Payload of Trace Info (TRAI) shall be assembled as shown in following table.

Length in bit	Name	Description
16	Length of string + termination char. (in byte)	Unsigned 16-bit integer
x	Trace Data String	Null terminated string (like name of module / function in packet)

Table 5-10 Data Payload of Trace Info (TRAI)

] (RS_LT_00044)

5.1.3.13 Example of representation of natural data type argument

The following example shows the assembly of an 8-bit unsigned integer argument with Variable Info (VARI) bit set in verbose mode.

The Type Info is a 32-bit field that describes the Data. In this example, it defines the variable type (unsigned integer), its length (8 bit) and the presence of Variable Info (VARI) that describes the name and unit of the variable. Variable Info is following with two 16-bit unsigned integers describing the length of the Name and the Unit of the variable. Two null terminated strings follow that describe the Name and the Unit. Finally, the variable value follows. The length of the Data field is 8 bit.

Length in bit	Name	Value	Description
32	Type Info	0001 0010 0001 0000 0000 0000 0000 0000	Type Length (TYLE) = 0x1 (8 bit) Type Unsigned (UINT) = 0x1 Variable Info (VARI) = 0x1
Variable Info (VARI) is set in Type Info			
16	Length of name + termination char.	12	Unsigned 16-bit integer
16	Length of unit + termination char.	8	Unsigned 16-bit integer
96 (12*8)	Name	temperature	Null terminated string (name of variable)
64 (8*8)	Unit	celsius	Null terminated string (unit of variable)
8	Data	25	

Table 5-11 Example of the assembly of the payload in verbose mode

List of different Type Info fields bits combinations

The following table shows all combinations of valid settings in Type Info sorted according to the bit position in Type Info.

0-3 TYLE				4 BOOL	5 SINT	6 UINT	7 FLOA	8 ARAY	9 STRG	10 RAWD	11 VARI	12 FIXP	13 TRAI	14 STRU	15-17 SCOD			18-31 RESERVED	
x	x	x	x	x							o								
x	x	x	x		x						o	o							
x	x	x	x			x					o	o							
x	x	x	x				x				o								
									x		o				x	x	x		
										x	o								
													x		x	x	x		
								x			o								
											o			x					
											o								

Table 5-12 Assembly of valid settings in Type Info (o – optional, x – mandatory for this type, empty – not allowed for this type)

The following table shows the mandatory (marked with x) and optional (marked with o) setting according to used variable type:

Valid Settings Variable Type	Type Length (TYLE)	Variable Info (VARI)	Fixed Point (FIXP)	String Coding (SCOD)
Type Bool (BOOL)	x	o		
Type Signed Integer (SINT)	x	o	o	
Type Unsigned Integer (UINT)	x	o	o	
Type Float (FLOA)	x	o		
Type Array (ARAY)		o		
Type String (STRG)		o		x
Type Raw (RAWD)		o		
Trace Info (TRAI)				x
Type Struct (STRU)		o		

Table 5-13 Assembly of valid settings in Type Info (o – optional, x – mandatory for this type, empty – not allowed for this type)

Using the Verbose Mode helps to understand, analyze and debug the application.

5.1.3.14 Recommended arguments

To identify the source of a log or trace message some information to find the location in the source code shall be added to a Dlt message. Therefore the first two arguments in a Dlt message shall be:

- the name of the source file (string) and
- the line number (unsigned integer).

[PRS_Dlt_00424] [The first argument of a log or trace message shall be a string argument where the field “Name” (in Variable Info) contains the string “source_file” and the Data field contains the URL to the source file.] (RS_LT_00026)

[PRS_Dlt_00425] [The second argument of a log or trace message shall be a UINT argument (with 32 bit) where the field “Name” (in Variable Info) contains the string “line_number” and the Data field contains the line number in the source file where the log or trace message is sent.] (RS_LT_00026)

5.2 Message types

5.2.1 Data Messages

Dlt Data Messages are assembled as described in chapter 5.1 “Message format”.

5.2.2 Control Messages

Dlt Control Messages are mainly used to modify the behavior of the Dlt module at runtime. They allow things like changing the communications bus to send Dlt data messages, modifying the filter level, configuration can be triggered to be stored nonvolatile.

5.3 Services / Commands

The following chapters describe the defined Dlt Commands, including an unique ID (Service ID), the format, and the required parameters.

[PRS_Dlt_00635] [The following Dlt Commands using the following Services IDs shall be supported:

Service ID	Dlt Command Name	Description
0x01	SetLogLevel	Set the Log Level
0x02	SetTraceStatus	Enable/Disable Trace Messages
0x03	GetLogInfo	Returns the LogLevel for registered applications
0x04	GetDefaultLogLevel	Returns the LogLevel for wildcards
0x05	StoreConfiguration	Stores the current configuration non volatile
0x06	RestoreToFactoryDefault	Sets the configuration back to default
0x0A	SetMessageFiltering	Enable/Disable message filtering
0x11	SetDefaultLogLevel	Sets the LogLevel for wildcards
0x12	SetDefaultTraceStatus	Enable/Disable TraceMessages for wildcards
0x13	GetSoftwareVersion	Get the ECU software version
0x15	GetDefaultTraceStatus	Get the current TraceLevel for wildcards
0x17	GetLogChannelNames	Returns the LogChannel's name
0x1F	GetTraceStatus	Returns the current TraceStatus
0x20	SetLogChannelAssignment	Adds/ Removes the given LogChannel as output path
0x21	SetLogChannelThreshold	Sets the filter threshold for the given LogChannel
0x22	GetLogChannelThreshold	Returns the current LogLevel for a given LogChannel
0x23	BufferOverflowNotification	Report that a buffer overflow occurred

] (RS_LT_00032)

Note:

It is recommended that the defined Dlt Commands can be triggered by the reception of the corresponding Dlt Control Message, and/or via separate C APIs.

[PRS_Dlt_00187] [Control messages are normal Dlt messages with a Standard Header, an Extended Header, and payload. The payload contains of the Service ID and the contained parameters.

5.3.1 Set Log Level

[PRS_Dlt_00194] [

Service name:		SetLogLevel	
Service ID [hex]		0x01	
Sync/Async:		Synchronous	
Reentrancy:		Non Reentrant	
Request Parameter			
Number	Name	Type	Description
1	applicationId	4*uint8	Representation of the Application ID. If this field is filled with NULL all log level for all Context IDs on this ECU are set.
2	contextId	4*uint8	Representation of the Context ID <ul style="list-style-type: none"> If this field is filled with NULL all Context IDs belonging to the given Application ID are set. is only interpreted if Application ID is not NULL
3	newLogLevel	sint8	the new log level to set <ul style="list-style-type: none"> can be in the range of DLT_LOG_FATAL to DLT_LOG_VERBOSE for setting the pass through range if set to 0 all messages from this Context ID are blocked if set to -1 the default log level for this ECU will be used
4	reserved	4*uint8	Reserved – These 4 bytes shall be ignored (i.e.: “don’t care”) This field shall be filled with zeros.
Response Parameter			
Number	Name	Type	Description
1	status	uint8	0 == OK 1 == NOT_SUPPORTED 2 == ERROR
Description:		Set the pass through range for log messages for a given combination of Application ID/ Context ID.	

] (RS_LT_00032)

[PRS_Dlt_00195] [Action to process:

Update the LogLevel setting within the Dlt module and inform all registered Applications with the Application ID which has been provided by the Dlt_SetLogLevel service.] (RS_LT_00032)

5.3.2 Set Trace Status

[PRS_Dlt_00196] [

Service name:	SetTraceStatus		
Service ID [hex]	0x02		
:			
Sync/Async:	Synchronous		
Reentrancy:	Non Reentrant		
Request Parameter			
Number	Name	Type	Description
1	applicationId	4*uint8	Representation of the Application ID. <ul style="list-style-type: none"> If this field is filled with NULL all trace status for all Context IDs on this ECU are set.
2	contextId	4*uint8	Representation of the Context ID <ul style="list-style-type: none"> If this field is filled with NULL all Context IDs belonging to the given Application ID are set. is only interpreted if Application ID is not NULL
3	newTraceStatus	sint8	the new trace status to set <ul style="list-style-type: none"> can be 1 – for On and 0 – for Off if set to -1 the default trace status for this ECU will be used
4	reserved	4 bytes	Reserved - These 4 bytes shall be ignored (i.e.: “don’t care”). This field shall be filled with zeros.
Response Parameter			
Number	Name	Type	Description
1	status	uint8	0 == OK 1 == NOT_SUPPORTED 2 == ERROR
Description:	Called to enable or disable trace messages for a given tuple of Application ID / Context ID.		

] (RS_LT_00032)

5.3.3 Get Log Info

[PRS_DIt_00197] [

Service name:	GetLogInfo		
Service ID [hex]	0x03		
Sync/Async:	Synchronous		
Reentrancy:	Non Reentrant		
Request Parameter			
Number	Name	Type	Description
1	options	uint8	1 - reserved 2 - reserved 3 - reserved 4 - reserved 5 - reserved 6 - Information about registered Application IDs and Context IDs with log level and with trace status information 7 - Information about registered Application IDs and Context IDs with log level and with trace status information and all textual descriptions of each Application ID and Context ID
2	applicationId	4*uint8	Representation of the Application ID. <ul style="list-style-type: none"> If this field is filled with NULL all Application IDs with all Context IDs registered with this ECU are requested
3	contextId	4*uint8	Representation of the Context ID <ul style="list-style-type: none"> If this field is filled with NULL all Context IDs belonging to the given Application ID are requested is only interpreted if Application ID is not NULL
4	reserved	4*uint8	Reserved – These 4 bytes shall be ignored (i.e.: “don’t care”) This field shall be filled with zeros.
Response Parameter			
Number	Name	Type	Description
1	status	uint8	1 - NOT_SUPPORTED 2 - DLT_ERROR 3 - reserved 4 - reserved 5 - reserved 6 - Information about registered Application IDs and Context IDs with log level and with trace status information 7 - Information about registered Application IDs and Context IDs with log level and with trace status information and all textual descriptions of each Application ID and Context ID NOTE: In this case the control message shall be in Verbose Mode 8 – NO matching Context IDs 9 – RESPONSE DATA OVERFLOW – If the generated response is too large. If the response is not of the status 1, 2, 8 or 9 it should be the same that is used in the request entry of “options”.

2	<i>applicationIds</i>	LogInfoType	Null if status == 1 or 2 Response is build like this: 1. Number of Application IDs 2. Application ID + Number of Context IDs 1. Context ID + log level; 2. Context ID + log level; 3. ... 3. Application ID + Number of Context IDs 1. Context ID + log level; 2. 4. ...!
3	<i>reserved</i>	4*uint8	Reserved – These 4 bytes shall be ignored (i.e.: “don’t care”). This field shall be filled with zeros.
Description:		Called to request information about registered Application IDs, their Context IDs and the corresponding LogLevel. If the command GetLogInfo has been requested with a “reserved” options value, NOT_SUPPORTED shall be returned.	

] (RS_LT_00032, RS_LT_00033)

5.3.4 Get Default Log Level

[PRS_DIt_00198] [

Service name:		GetDefaultLogLevel	
Service ID [hex]		0x04	
:			
Sync/Async:		Synchronous	
Reentrancy:		Non Reentrant	
Request Parameter			
Number	Name	Type	Description
none			
Response Parameter			
Number	Name	Type	Description
1	status	uint8	0 == OK 1 == NOT_SUPPORTED 2 == ERROR
2	logLevel	uint8	Actual log level
Description:		Returns the actual default log level.	

] (RS_LT_00032)

5.3.5 Store Configuration

[PRS_DIt_00199] [

Service name:		StoreConfiguration	
Service ID [hex]		0x05	
:			
Sync/Async:		Synchronous	
Reentrancy:		Non Reentrant	
Request Parameter			
Number	Name	Type	Description
none			
Response Parameter			
Number	Name	Type	Description
1	status	uint8	0 == OK 1 == NOT_SUPPORTED 2 == ERROR
Description:		Called to store the actual DIt configuration nonvolatile. If not supported, NOT_SUPPORTED shall be the response.	

] (RS_LT_00032, RS_LT_00039)

5.3.6 Reset to Factory Default

[PRS_DIt_00200] [

Service name:	ResetToFactoryDefault		
Service ID [hex]	0x06		
:			
Sync/Async:	Synchronous		
Reentrancy:	Non Reentrant		
Request Parameter			
Number	Name	Type	Description
none			
Response Parameter			
Number	Name	Type	Description
1	status	uint8	0 == OK 1 == NOT_SUPPORTED 2 == ERROR
Description:	Called to set the DIt configuration back to factory defaults. If not supported, NOT_SUPPORTED shall be the response.		

] (RS_LT_00032)

5.3.7 SetMessageFiltering

[PRS_DIt_00205] [

Service name:	SetMessageFiltering		
Service ID [hex]	0x0A		
:			
Sync/Async:	Synchronous		
Reentrancy:	Non Reentrant		
Request Parameter			
Number	Name	Type	Description
1	newstatus	Uint8	0 – OFF 0 – ON
Response Parameter			
Number	Name	Type	Description
2	status	uint8	0 == OK 1 == NOT_SUPPORTED 2 == ERROR
Description:	Called to switch on/off the message filtering by the DIt module. If not supported, NOT_SUPPORTED shall be the response		

] (RS_LT_00040)

5.3.8 Set Default LogLevel

[PRS_DIt_00380] [

Service name:	SetDefaultLogLevel		
Service_ID [hex]	0x11		
Sync/Async:	Synchronous		
Reentrancy:	Non Reentrant		
Request Parameter			
Number	Name	Type	Description
1	<i>newLogLevel</i>	sint8	the new log level to set <ul style="list-style-type: none"> • can be in the range of DLT_LOG_FATAL to DLT_LOG_VERBOSE for setting the pass through range • if set to 0 all messages are blocked • if set to -1 all messages pass the filter
4	<i>Reserved</i>	4*uint8	Reserved – These 4 bytes shall be ignored (i.e.: “don’t care”). This field shall be filled with zeros.
Response Parameter			
Number	Name	Type	Description
1	<i>status</i>	uint8	0 == OK 1 == NOT_SUPPORTED 2 == ERROR
Description:	Called to modify the pass through range for log messages for all not explicit set Context IDs. If not supported, NOT_SUPPORTED shall be the response.		

] (RS_LT_00032)

[PRS_DIt_00381] [Action to process:
 Update the LogLevel filter for all wildcard entries according to the provided newLogLevel.] (RS_LT_00032)

5.3.9 Set Default Trace Status

[PRS_DIt_00383] [

Service name:	SetDefaultTraceStatus		
Service_ID [hex]	0x12		
Sync/Async:	Synchronous		
Reentrancy:	Non Reentrant		
Request Parameter			
Number	Name	Type	Description
1	<i>newTraceStatus</i>	sint8	the new trace status to set <ul style="list-style-type: none"> • can be 1 – for On and 0 – for Off
2	<i>reserved</i>	4 bytes	These 4 bytes shall be ignored (i.e.: “don’t care”) This field shall be filled with zeros.
Response Parameter			
Number	Name	Type	Description
1	<i>Status</i>	uint8	0 == OK 1 == NOT_SUPPORTED 2 == ERROR

Description:	Called to enable or disable trace messages for all not explicit set Context IDs. If not supported, NOT_SUPPORTED shall be the response.
---------------------	--

] (RS_LT_00032)

5.3.10 Get ECU Software Version

[PRS_Dit_00393] [

Service name:	GetSoftwareVersion		
Service_ID [hex]	0x13		
Sync/Async:	Synchronous		
Reentrancy:	Non Reentrant		
Request Parameter			
Number	Name	Type	Description
none			
Response Parameter			
Number	Name	Type	Description
1	Status	uint8	0 == OK 1 == NOT_SUPPORTED 2 == ERROR
2	Length	uint32	Length of the string swVersion
3	swVersion	char[]	String containing the ECU software version
Description:	Getting the ECU's software version		

] (RS_LT_00032)

5.3.11 Get Default Trace Status

[PRS_DIt_00494] [

Service name:	GetDefaultTraceStatus		
Service ID [hex]	0x15		
:			
Sync/Async:	Synchronous		
Reentrancy:	Non Reentrant		
Request Parameter			
Number	Name	Type	Description
<i>none</i>			
Response Parameter			
Number	Name	Type	Description
1	status	uint8	0 == OK 1 == NOT_SUPPORTED 2 == ERROR
2	traceStatus	uint8	Actual Trace Status 0 - off, 1 - on
Description:	Returns the actual default trace status. If not supported, NOT_SUPPORTED shall be the response.		

] (RS_LT_00032)

5.3.12 Get LogChannel Names

[PRS_DIt_00502] [

Service name:	GetLogChannelNames		
Service ID [hex]	0x17		
:			
Sync/Async:	Synchronous		
Reentrancy:	Non Reentrant		
Request Parameter			
Number	Name	Type	Description
<i>none</i>			
Response Parameter			
Number	Name	Type	Description
1	status	uint8	0 == OK 1 == NOT_SUPPORTED 2 == ERROR
2	countIf	uin8	Count of transmitted interface (i.e. LogChannel) names.
3	logChannelNames	4*uin8[]	List of Log Channel names. Array on each 4 byte
Description:	Called to get all available communication interfaces. If not supported, NOT_SUPPORTED shall be the response.		

] (RS_LT_00032)

5.3.13 Get Trace Status

[PRS_DIt_00638] [

Service name:	GetTraceStatus		
Service ID [hex]	0x1F		
:			
Sync/Async:	Synchronous		
Reentrancy:	Non Reentrant		
Request Parameter			
Number	Name	Type	Description
1	<i>applicationId</i>	4*uint8	Addressed Application ID
2	<i>contextId</i>	4*uint8	Addressed Context ID
Response Parameter			
Number	Name	Type	Description
1	<i>status</i>	uint8	0 == OK 1 == NOT_SUPPORTED 2 == ERROR
2	<i>traceStatus</i>	uint8	Actual Trace Status 0 - off, 1 - on
Description:	Returns the actual trace status for the addressed tuple of ApplicationID/ContextID. If not supported, NOT_SUPPORTED shall be the response.		

] (RS_LT_00032)

5.3.14 Set LogChannel Assignment

[PRS_DIt_00637] [

Service name:	SetLogChannelAssignment		
Service ID [hex]	0x20		
:			
Sync/Async:	Synchronous		
Reentrancy:	Non Reentrant		
Request Parameter			
Number	Name	Type	Description
1	<i>applicationId</i>	4*uint8	Addressed Application ID
2	<i>contextId</i>	4*uint8	Addressed Context ID
3	<i>logChannelName</i>	4*uint8	Name of the addressed LogChannel
4	<i>addRemoveOp</i>	uint8	0: Remove the addressed tuple of ApplicationID/Context ID from the addressed LogChannel 1: Add the addressed tuple of ApplicationID/ContextID to the addressed LogChannel
Response Parameter			
Number	Name	Type	Description
1	<i>status</i>	uint8	0 == OK 1 == NOT_SUPPORTED 2 == ERROR
Description:	Adds or removes the addressed tuple of ApplicationID/ContextID from the addressed LogChannel. If not supported, NOT_SUPPORTED shall be the response.		

] (RS_LT_00032)

5.3.15 Set LogChannel Threshold

[PRS_DIt_00639] [

Service name:	SetLogChannelThreshold		
Service ID [hex]	0x21		
:			
Sync/Async:	Synchronous		
Reentrancy:	Non Reentrant		
Request Parameter			
Number	Name	Type	Description
1	<i>logChannelName</i>	4*uint8	Name of the addressed LogChannel
2	<i>logLevelThreshold</i>	uint8	0 - DLT_LOG_OFF 1 - DLT_LOG_FATAL 2 - DLT_LOG_ERROR 3 - DLT_LOG_WARN 4 - DLT_LOG_INFO 5 - DLT_LOG_DEBUG 6 - DLT_LOG_VERBOSE
3	<i>traceStatus</i>	uint8	0: Trace Messages blocked 1: Trace Messages can pass
Response Parameter			
Number	Name	Type	Description
1	<i>Status</i>	uint8	0 == OK 1 == NOT_SUPPORTED 2 == ERROR
2	<i>traceStatus</i>	uint8	Actual Trace Status 0 - off, 1 - on
Description:	Sets the LogLevel and the TraceStatus for the addressed LogChannel. If not supported, NOT_SUPPORTED shall be the response.		

] (RS_LT_00032)

5.3.16 Get LogChannel Threshold

[PRS_DIt_00640] [

Service name:	GetLogChannelThreshold		
Service ID [hex]	0x22		
:			
Sync/Async:	Synchronous		
Reentrancy:	Non Reentrant		
Request Parameter			
Number	Name	Type	Description
1	<i>logChannelName</i>	4*uint8	Name of the addressed LogChannel
Response Parameter			
Number	Name	Type	Description

1	status	uint8	0 == OK 1 == NOT_SUPPORTED 2 == ERROR
2	logLevelThreshold	uint8	0 == DLT_LOG_OFF 1 == DLT_LOG_FATAL 2 == DLT_LOG_ERROR 3 == DLT_LOG_WARN 4 == DLT_LOG_INFO 5 == DLT_LOG_DEBUG 6 == DLT_LOG_VERBOSE
3	traceStatus	uint8	0 == Trace Messages are blocked 1 == Trace Messages can pass
Description:		Returns the LogLevel and the TraceStatus for the addressed LogChannel. If not supported, NOT_SUPPORTED shall be the response.	

] (RS_LT_00032)

5.3.17 BufferOverflowNotification

[PRS_Dlt_00769] [

Service name:		BufferOverflowNotification	
Service ID [hex]		0x23	
:			
Sync/Async:		Synchronous	
Reentrancy:		Non Reentrant	
Request Parameter			
Number	Name	Type	Description
Response Parameter			
Number	Name	Type	Description
1	status	uint8	0 == OK 1 == NOT_SUPPORTED 2 == ERROR
3	overflowCounter	uint32	Counter for the amount of lost Dlt messages since last sent MessageBufferOverflow message
Description:		The Dlt module sends this message when the dlt message buffer overflows. If not supported, NOT_SUPPORTED shall be the response.	

] (RS_LT_00037)

5.3.18 Call SWC Injection

[PRS_DIt_00217] [CallSWCInjection messages shall be forwarded to the according application. The Service ID 0xFFF to 0xFFFFFFFF are reserved for this purpose. The value is user defined and can be freely used by an application.] ()

[PRS_DIt_00218] [In the case of a CallSWCInjection message, the Application ID (APID), Context ID (CTID) and the Session ID (SEID) shall be filled in the header. The pair of APID and CTID together with the SEID identifies a unique client server interface of an application/runnable which is called in respect to reception of this message with the provided data.] ()

[PRS_DIt_00219] [If a unique identification is not possible (this pair does not exist, is not registered yet) the response shall be NOT_SUPPORTED.] ()

[PRS_DIt_00220] [

Service name:		CallSWCInjection	
Service ID [hex]		0xFFF ... 0xFFFFFFFF	
:			
Sync/Async:		Synchronous	
Reentrancy:		Non Reentrant	
Request Parameter			
Number	Name	Type	Description
1	<i>dataLength</i>	uint32	length of the provided data
2	<i>data[]</i>	uint8[]	data to provide to the application
Response Parameter			
Number	Name	Type	Description
1	<i>status</i>	uint8	0 == OK 1 == NOT_SUPPORTED 2 == ERROR 3 == PENDING
Description:		Used to call a function in an application. If the Injection feature is disabled and/or not implemented, NOT_SUPPORTED shall be the response.	

] ()

5.3.19 DLT Commands (deprecated)

[PRS_Dlt_00641] | The following Dlt Commands are deprecated and not supported any more:

- 0x07 SetComInterfaceStatus
- 0x08 SetComInterfaceMaxBandwidth
- 0x09 SetVerboseMode
- 0x0C GetLocalTime
- 0x0D SetUseECUID
- 0x0E SetUseSessionID
- 0x0F SetUseTimestamp
- 0x10 SetUseExtendedHeader
- 0x14 MessageBufferOverflow
- 0x16 GetComInterfaceStatus
- 0x18 GetComInterfaceMaxBandwidth
- 0x19 GetVerboseModeStatus
- 0x1A GetMessageFilteringStatus
- 0x1B GetUseECUID
- 0x1C GetUseSessionID
- 0x1D GetUseTimestamp
- 0x1E GetUseExtendedHeader

| (RS_LT_00002)

5.4 External Client / Tool

5.4.1 Extensions for storing in a database/file

The Dlt module can leave out some information in the header like timestamp and ECU ID. Therefore, it is important to store some additional information by the receiving external client.

For additionally storing the timestamp and the ECU ID a Storage Header shall be added in front of every received Dlt message.

Timestamp and ECU ID can be left of Dlt side, because of that the receiver shall add this information at receiving time. The Timestamp is also for a better calculating of sequences and timely dependencies by a diagnostic and visualization tool.

Additionally at the beginning of the Storage header a pattern shall be attached. This pattern is for some error recoveries if the byte-stream or file is broken.

[PRS_Dlt_00405] [An external client shall add the Storage Header to a received Dlt message before it stores the message.

Offset	Length (byte)	Name	Description
Dlt log or trace storage extension			
0	4	DLT-Pattern	“DLT”+0x01 in Hex 0 x 44 4C 54 01
4	8	Timestamp	
		seconds	Unsigned integer 32 bit seconds since 01.01.1970 (unix time)
		microseconds	Singed integer 32 bit microseconds of the second (between 0 – 1.000.000)
12	4	ECU ID	Four characters the ECU ID
Dlt log or trace message			
		Header	
		Extended Header	
		Payload	

Table 5-14 Storage Header to store in front of a Dlt message.

] (RS_LT_00002)

[PRS_Dlt_00427] [The first entry in the Storage Header shall be a pattern 0 x 44 4C 54 01 (“DLT”+0x1).] (RS_LT_00002)

[PRS_DIt_00404] [If an external client receives a message it shall store the time when it receives the message additionally to the message in the storage header.]
(RS_LT_00002)

[PRS_DIt_00292] [If an external client receives a message it shall store the ECU ID when it receives the message additionally to the message in the storage header.]
(RS_LT_00002)

5.5 Sequences (lower layer)

5.5.1 States

N /A – The DIt Protocol does not specify any states.

5.5.2 Control flow / Transitions

5.5.2.1 Transmission of Dlt Data Message

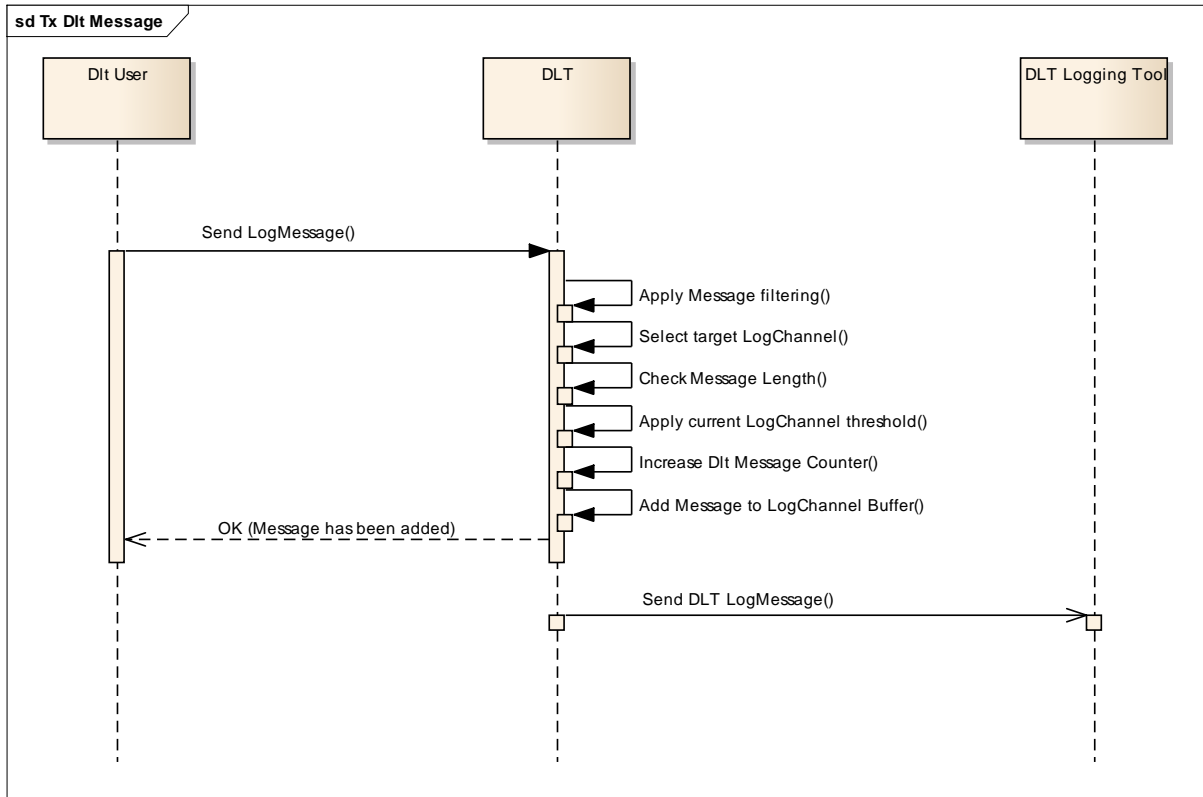

Sequence 1 – Transmission of Dlt Data Message

5.5.2.2 Set LogLevel Filter

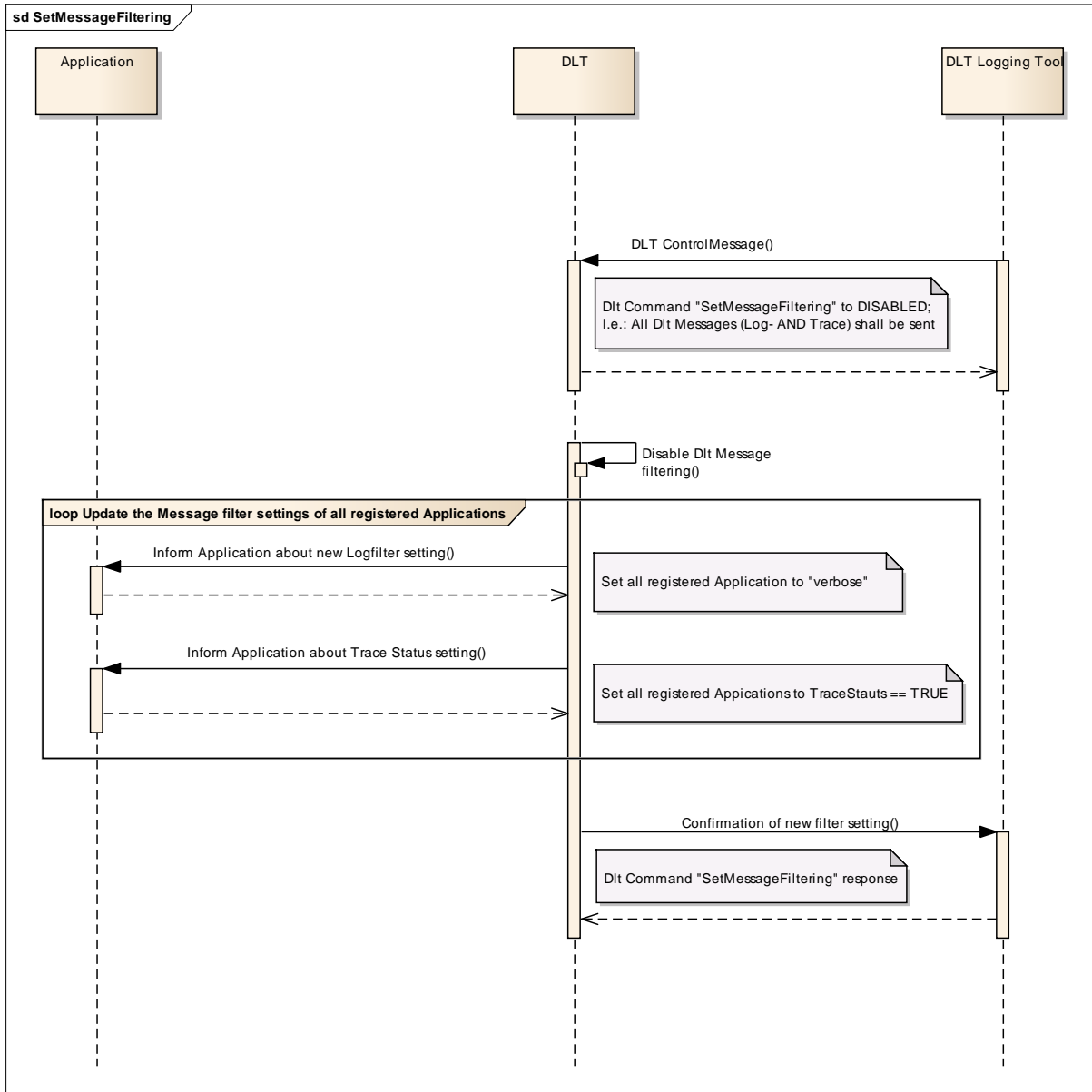

Sequence 2 - Set LogLevel Filter

5.5.2.3 Buffer Overflow

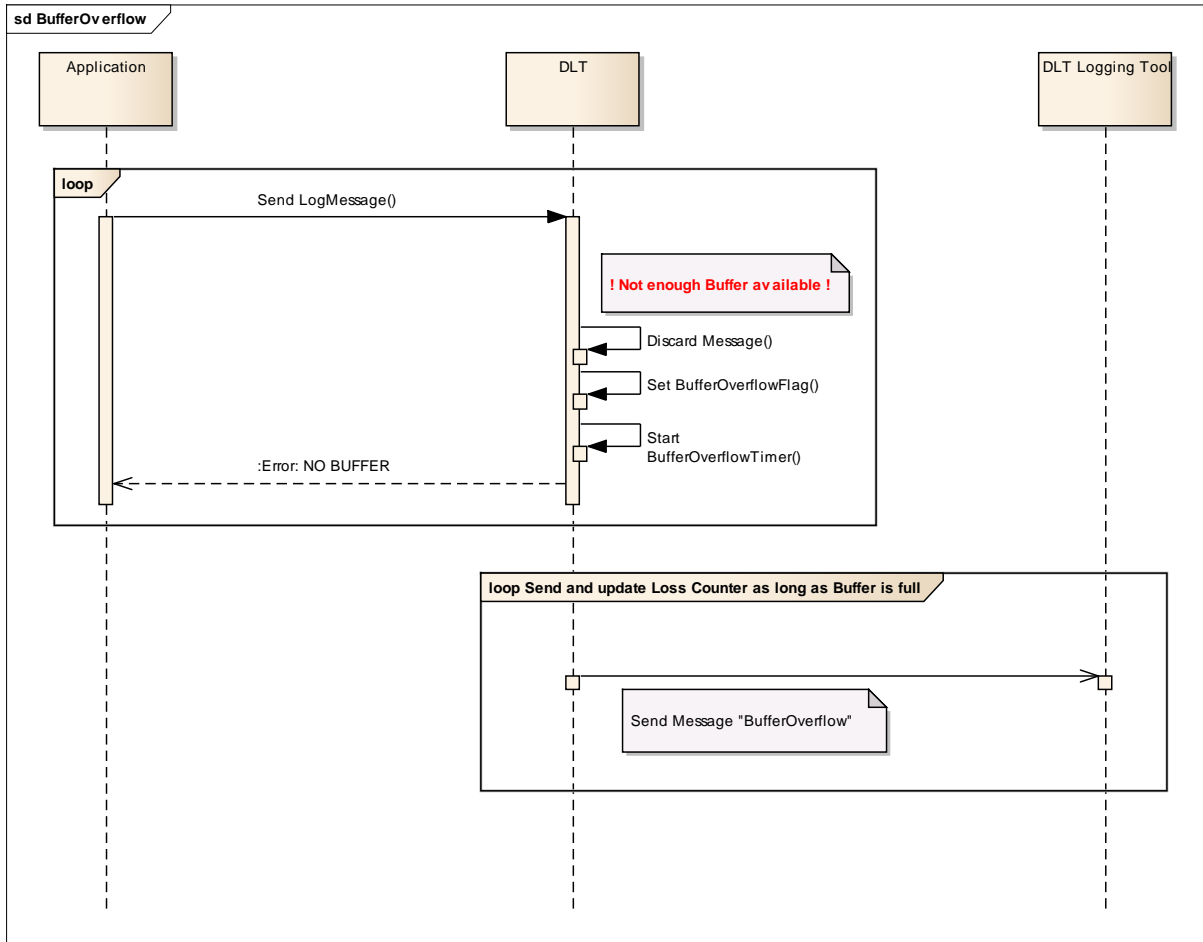

Sequence 3- Buffer Overflow

5.6 Error Handling

5.6.1 Error messages

5.6.1.1 Buffer Overflow

[PRS_DIt_00648] [If a DIt Message Buffer Overflow occurs, the Control Message with the Service ID 0x23 (BufferOverflowNotification) shall be sent.] ()

Note: The Service BufferOverflowNotification is defined in chapter 5..3.

[PRS_DIt_00649] [The status of the DIt Message Buffer shall be cyclically checked.

The minimum time interval of sending the DIt Overflow Message shall be configurable, i.e.: do not send more than one DIt Overflow Message within the configured time span.] ()

5.6.1.2 Answering a Command with “ERROR”

[PRS_DIt_00650] [The DIt module shall answer a DIt Command with “ERROR” if one of the following cases:

- At least one of the received parameter values cannot be matched to the current configuration
- Another DIt Command is currently in progress

] ()

[PRS_DIt_00642] [If the DIt module receives a DIt command using a Service ID which is neither specified in chapter “DIt Command” nor in chapter “DIt Commands (deprecated)”, the DIt module shall answer with “ERROR”.] ()

5.6.1.3 Answering a Command with “NOT SUPPORTED”

[PRS_DIt_00644] [The DIt module shall respond with “DLT_NOT_SUPPORTED” if it receives one of the following DIt Commands:

- 0x07 SetComInterfaceStatus
- 0x08 SetComInterfaceMaxBandwidth
- 0x09 SetVerboseMode
- 0x0A SetMessageFiltering
- 0x0C GetLocalTime
- 0x0D SetUseECUID
- 0x0E SetUseSessionID

- 0x0F SetUseTimestamp
- 0x10 SetUseExtendedHeader
- 0x14 MessageBufferOverflow
- 0x16 GetComInterfaceStatus
- 0x18 GetComInterfaceMaxBandwidth
- 0x19 GetVerboseModeStatus
- 0x1A GetMessageFilteringStatus
- 0x1B GetIseECUID
- 0x1C GetUseSessionID
- 0x1D GetUseTimestamp
- 0x1E GetUseExtendedHeader

] ()

5.6.2 Error resolution

5.6.2.1 Transmission Retry

[PRS_Dlt_00651] [In case an error occurred while trying to send a Dlt Message on the bus, the Dlt module shall re-try to send it. The maximum amount of transmission retries shall be configurable.] ()

Note:

This is not part of the Dlt Protocol itself, but recommended for the implementation of the Dlt Module.

6 Protocol usage and guidelines

Please refer to chapter 1 and 2

7 Configuration specification

This chapter lists all parameter the Dlt Protocol uses.

7.1 Dlt Header

Long Name	Short Name	Description
Header Type	HTTY	Metainformation about the Dlt Header
Message Counter	MCNT	Message counter of Dlt Tx messages
Length	LEN	Length of Dlt Message
ECU ID (optional)	ECU	Name of ECU
Session ID (optional)	SEID	Session ID
Timestamp (optional)	TMSP	Timestamp

7.1.1 Header Type

Long Name	Short Name	Description
Use Extended Header	UEH	Flag for usage of Dlt Extended Header
MSB First	MSBF	Flag for Little/Big endianness
With ECU ID	WEID	Flag for ECU ID field usage
With Session ID	WSID	Flag for Session ID field usage
With Timestamp	WTMS	Flag for Timestamp field usage
Version number	VERS	Contains the used Dlt Protocol Version

7.2 Dlt Extended Header

Long Name	Short Name	Description
Message Info	MSNI	Metainformation about the Extended Header
Number of Arguments	NOAR	Number of arguments contained in payload
Application ID	APID	Application ID
Context ID	CTID	Context ID

7.2.1 Message Info

Long Name	Short Name	Description
Verbose mode	VERB	Flag to indicate the usage of verbose mode
Message Type	MSTP	Identification of the type of Dlt message
Message Type Info	MTIN	Additional information of the message type

7.3 Published Information

Published information contains data defined by the implementer of the SW module that does not change when the protocol is adapted (i.e. configured) to the actual HW/SW environment. It thus contains version and manufacturer information.

Additional module-specific published parameters are listed below if applicable.